

3. Install leg link shaft.

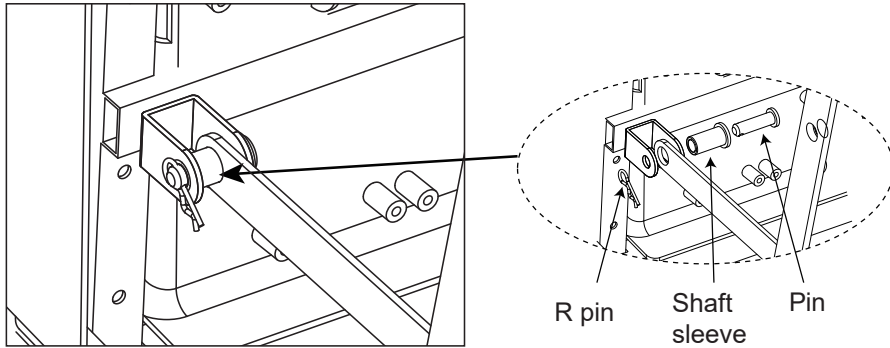

Scan QR code for
assembly instructions

4. Connect the docking wire to the air pipe.

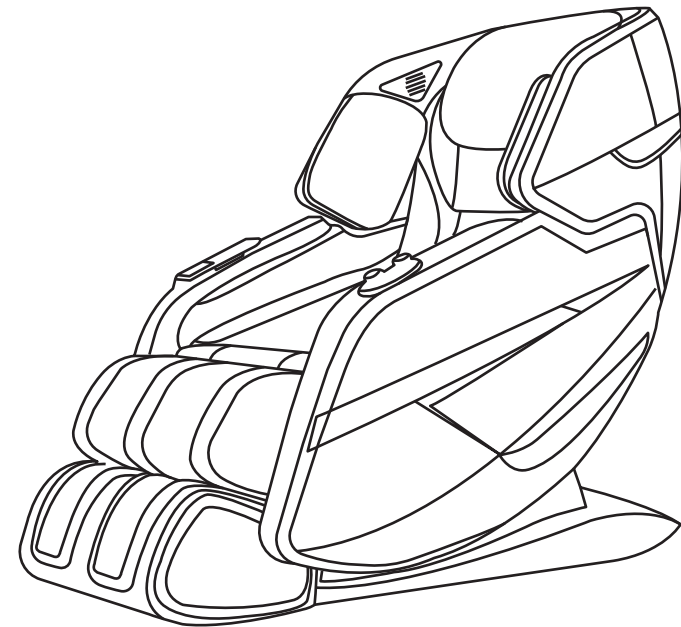
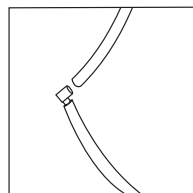
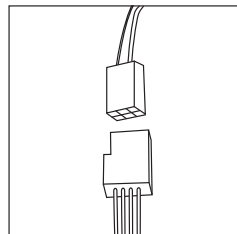
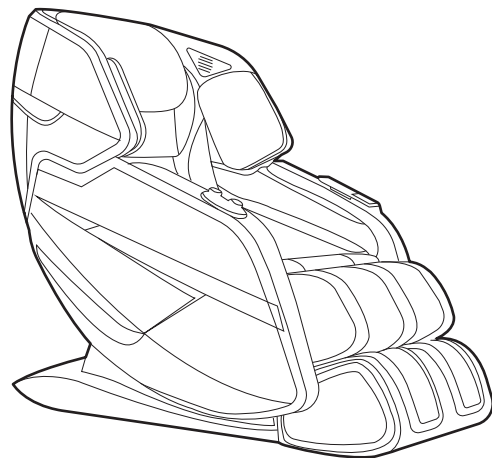

Massage Chair
JL10023WL-BN

SAFETY PRECAUTIONS

1. People with the following conditions should consult their physician before using the product:
 - * Who uses a medical electronic device, which is embedded in the body, such as a pacemaker.
 - * Who suffers from heart disease.
 - * Who suffers from backbone disease.
 - * Who is suffering from bone fragility, especially on the backbone.
 - * After surgery.
 - * Who is pregnant, after delivery or in a period of monthly illness.
 - * Who suffers from malignant tumors.
 - * Who is suffering from osteoporosis.
 - * Who is suffering from skin disease or affection.
 - * Who is undergoing medical treatment or feels some physical abnormality previously or is being treated now.
 - * Who has some abnormality or deformity of limbs or backbone.
 - * Who has backbone problems or injuries due to illness or accident.

Note: Never massage the swollen or inflamed parts of the body.
2. Do not let water enter the product or splash the surface of the product.
3. Water contact with electricity is dangerous. Do not leave the product in a humid environment (such as in bathroom or shower room or next to swimming pool).
4. Before connecting the product to the power supply, make sure the product voltage and supply voltage are the same.

5. If the plug, power cord or product itself is damaged, do not use the product.
6. In order to prevent the risk of electric shock, do not open the product outer casing.
7. Product is not intended for use by the disabled, sensory or mental impaired (including children), unless there is supervision or guidance by the people responsible for their safety when they use the product.
8. If the product or the power cord is damaged, in order to avoid danger, do not try to repair the product. This must be handled by specialist/technician.
9. Children should not use the product. They should be under supervision to ensure that they will not treat the product as a toy.
10. If unusual sound or noise is being heard from the product, turn off the product and immediately disconnect the power connection. Please contact the after-sales service center.
11. Do not use the product if the cover is damaged or if there is a mechanical or electronic failure. You should contact the after-sales service center.
12. Only place the product in accordance with the instructions in this user manual.
13. Do not use the product in humid conditions and high temperature environment or beside hot objects such as heaters, stoves.
14. Do not apply medical or cosmetic cream on the product or on your body before or when using the product.
15. When massaging around or near the neck, take care of the movement of rollers and refrain from using excessive intensity.
16. Do not destroy, bend, stretch, twist or tie the power cord. Damaged power cord can cause fire or electric shock.

17. Do not use the product on bare skin.
18. Recommended usage time for an individual is within 30 minutes a day.
19. The maximum capacity is 220lbs. If it is over 220lbs, permanent damage to the product would be resulted.
20. Always keep the product clean and never insert any object into the gaps on and around the product.
21. The product is designed for household use only.
22. Do not stand, sit or jump on the calf-rest when the product is in use to prevent any injury or damage.
23. Do not attempt to stand on the backrest and armrest to prevent any injury to person.

Warning:

- * Who should avoid using this product: those who are physically, sensory, or mentally impaired, or who are lack of experience and knowledge. Unless they are supervised or directed by the person responsible for their safety regarding the use of this product.
- * Children should be supervised to ensure that they cannot play with the massage chair.
- * If the power cord is damaged, it must be replaced with a dedicated cord.
- * The surface of the appliance is hot, and people who are not sensitive to heat must use with caution.

PREPARATION FOR USE

1. Open the packing case and take out the accessories

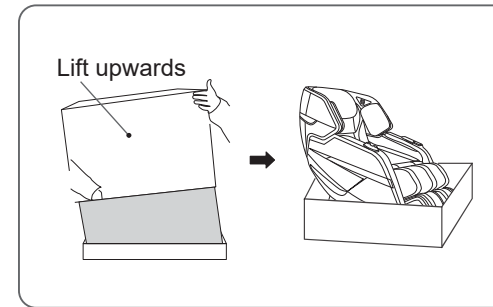

- 1) Remove the carton. Take out the chair.
- 2) Install the pillow and backrest cover.

2. Place the chair in an open area

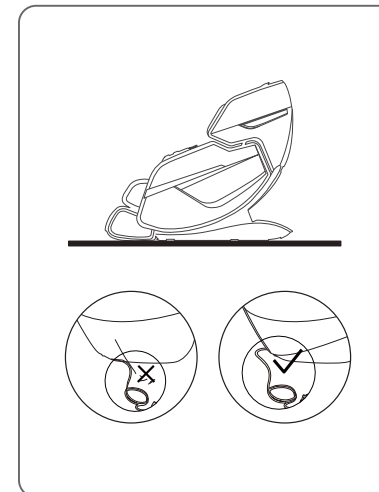

- * Allow sufficient space around the chair for reclining purposes.
- * To avoid damage to the floor and to reduce noise, please put a rug under the chair.
- * Make sure that there is no barrier at the front and the back of the chair.
- * Please do not put the chair on wet or uneven floor.
- * To avoid signal interference, please place the chair 3.3ft away from TV and radio.

Warning:

Do not put the power cord under the chair! Beware of damaging the power cord while moving the chair!

3. Move the chair

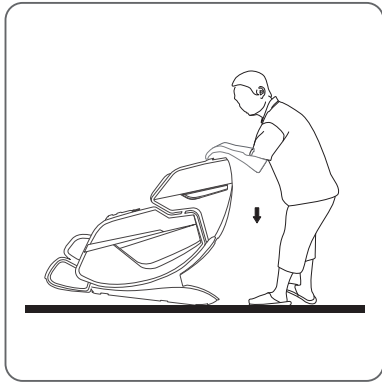

- 1) As illustrated, push the backrest downwards and tilt chair on to its wheels at a 45° angle.
- 2) Slowly push and move the chair to the desired location.
- 3) Lower the chair slowly and smoothly until it is fully flat on the ground.

Warning:

- * Do not move the chair when occupied or in use.
- * Moving the chair may cause damage to the floor.
Floor protection is recommended (e.g.rugs or carpet).
- * Do not drop or suddenly let go of the chair when moving as it may damage the chair.
- * To avoid injury to the massage chair or the transporter, it is recommended that two people carry the massage chair together with special care.

PRODUCT DESCRIPTION

Front View

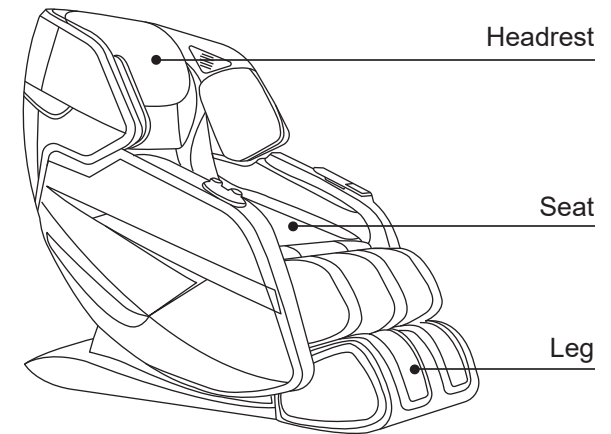

Moving Parts of Massage Chair

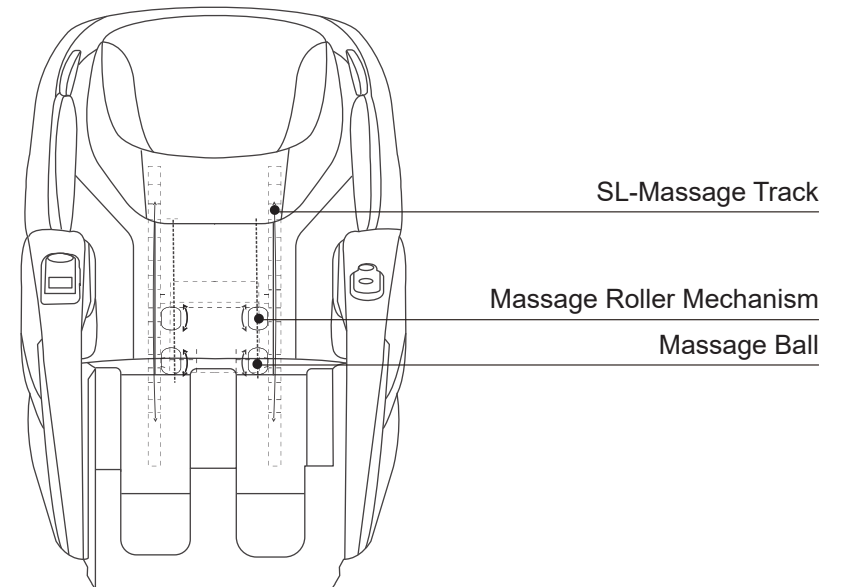

Rear View

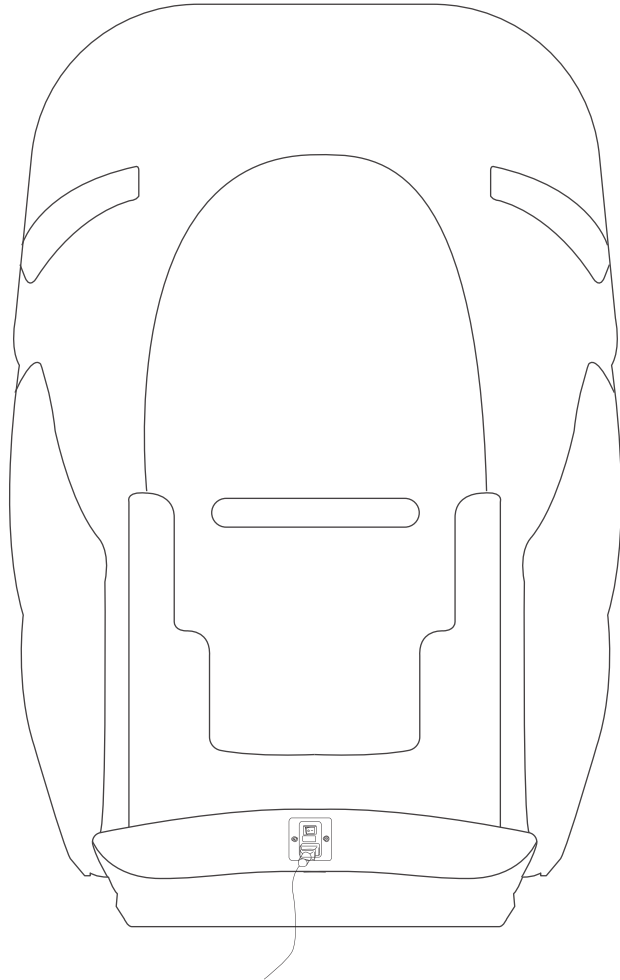

Main Power Socket

The Fuse

Power Switch

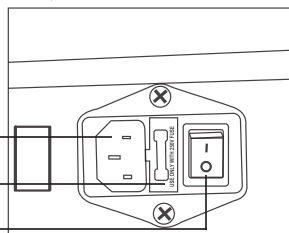

REMOTE CONTROLLER



On/Off

Auto Program
Neck & Shoulder

Manual Massage
3D On/Off

Airbag Massage Area
Width Adjustment

Intensity Adjustment
Spot Massage

Spot Massage Up

TV

Zero Gravity

Backrest Up

Pause

Waist & Hip

Foot Roller

Speed Adjustment

Heat On/Off
Spot Massage

Down

BOOK

Backrest Down

Function Description of Control Panel

On/Off



Press once to enter standby mode. Press the button again to stop current massage function and return to standby mode.

Pause



Press to pause all the functions that are currently running or continue to run the functions before the pause.

Auto Program



Press to start the automatic massage mode. The 8 automatic massage modes in sequence are: ① whole body massage mode; ② double 3D massage mode; ③ healthy massage mode; ④ cradle massage mode; ⑤ neck and shoulder massage mode; ⑥ waist and hip massage mode; ⑦ upper body massage mode; ⑧ lower body massage mode. Press the button ninth to stop the automatic massage mode.

Neck & Shoulder



Press this button to enter automatic massage mode ⑦, press this button again to stop.

Waist & Hip



Press this button to enter automatic massage mode ⑧, press this button again to stop.

Manual Massage



Press this button to enter the manual massage movement up mode, and switch four manual modes in turn: ① kneading 1; ② kneading 2; ③ kneading 3; ④ Shiatsu. Press the button fifth to stop the manual massage mode.



3D On/Off

Press this button to enter 3D massage mode, the “Strength” note on the controller screen lights up, and the massage movement bulges forward to enhance the massage body feeling; Press this button again to stop 3D massage chair mode, and the “Strength” note on the controller screen is off. “Strength” is not adjustable.



Foot Roller

Press this button to switch on or off the function of the foot roller. This function can be switched on or off in automatic mode or manual mode.



Airbag Massage Area

Press this button to manually enter the airbag massage mode in the corresponding area, in the order of: ① foot; ② foot & arm; ③ foot & shoulder; ④ shoulder & arm. Press the button fifth to stop the manual airbag massage adjustment.



Massage Width Adjustment

When the “Width” note on the screen lights up, the width of the massage movement can be adjusted.



Massage Speed Adjustment

Press this button to adjust the massage speed of the upper massage mechanism, corresponding to “Speed” note on the screen. Adjustable in low, medium and high speed.



Intensity Adjustment

Press to select from 3 levels of air pressure massage intensity, corresponding to “Intensity” note on the screen.



Spot Massage

Press this button to start/stop the spot massage mode; The position of upper massage mechanism can be controlled only in manual mode.



Heat On/Off

Press this button to start/stop the heating function on the back.



Spot Massage Up

Press this button, the upper massage mechanism will move up along the guide rail; The position of upper massage mechanism can be controlled only in manual mode.



Spot Massage Down

Press this button, the upper massage mechanism will move down along the guide rail; The position of upper massage mechanism can be controlled only in manual mode.



TV

Press this button to adjust the angle of the massage chair to the comfortable level, in order to watch TV.



BOOK

Press this button to adjust the angle of the massage chair to a comfortable reading angle.



Zero Gravity

Press this button to enter zero gravity mode, which simulates the zero-gravity state of space to distribute body weight evenly on the massage chair. Release physical and mental stress.



Backrest Up

Press and hold this button to move up the backrest.



Backrest Down

Press and hold this button to recline the backrest.

Knob Description

Knob 1



1. When the power is on, the red light of the knob flashes; Long press this button, the blue light will turn on, the massage chair will start up and enter the standby state.
2. When the power is on, turn the knob to adjust the Angle of the chair back.

Knob 2



1. When the power is on, press this button, the purple light will turn on, and you can switch four manual modes in turn: ① kneading; ② kneading 2; ③ kneading 3; ④ Shiatsu.
2. When the power is on, turn the knob to switch between the automatic program ①(A1) and the automatic program ②(A2). Turn to A1, red light is on, and turn to A2, blue light is on.

After use

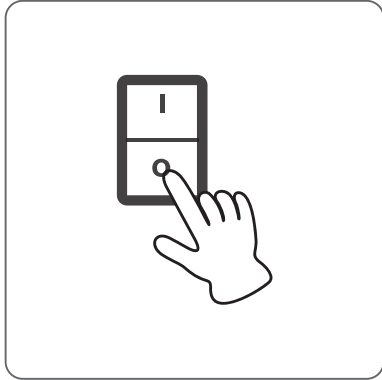

- 1) Press the On/Off button to disable all functions before putting the remote controller into the controller pocket.
- 2) Turn off the power switch (to "O") located at the back of the chair.
- 3) Remove plug from power socket.

* Please do not pull on the power cord to remove the plug.

Auto Program Description

Auto Program	Description
① whole body massage mode	With moderate massage intensity and airbag strength. Suitable for the whole body muscle relaxation after exercise.
② double 3D massage mode	Massage deeper into deep muscles and acupoints to better relieve muscle soreness and lower back discomfort and promote blood circulation.
③ healthy massage mode	With gentle massage intensity and airbag strength. Improve the whole body of middle-aged and elderly people's waist and back and muscle discomfort.
④ cradle massage mode	The massage chair cyclically swings by cyclically adjusting the Angle of the backrest, and gently massages to help relax and sleep.

⑤ neck and shoulder massage mode	Focus on the neck and shoulder massage with harder kneading intensity. Suitable for long-term desk worker to better relax muscle and relieve pain.
⑥ waist and hip massage mode	Focus on the waist and hip massage with moderate massage intensity. Conducive to reduce the waist and hip pain caused by sitting for a long time.
⑦ upper body massage mode	Upper body massage only. Focus on the massage on the neck & shoulder, waist & back. With moderate massage strength.
⑧ lower body massage mode	Lower body massage only. Focus on the hip & thighs. With moderate massage strength.

TROUBLESHOOTING

This page summarizes the most common problems you would encounter with the product.

If you are unable to solve the problem with information below, please contact the after-sales service center immediately.

The problem situation	Possible Cause	Suggestion
The product does not work	The product is not plugged in properly.	Ensure the voltage on the product corresponds to the local mains voltage and then plug in again. Then press on the power switch.
	The product has just finished its 15-min auto timer session and has automatically switched to standby mode.	If you want another session, press the On/Off button again.
	You may have used the product continuously for more than 45 minutes and the overheat protection has been activated.	Unplug the product and let it cool down for 60 minutes before you use it again.
	An excessive load has been applied on the product.	Reduce the excessive load and start again.
The product is abnormally warm	The product is likely to be overused.	Unplug the product and let it cool down before using it again.
Noise can be heard from the product	Noise is made by the mechanical parts of the product.	This is normal and does not mean that the product is faulty.

CARE & MAINTENANCE

Cleaning

- Do not use steel wool, abrasive cleaning agents or corrosive liquids (such as gasoline or acetone) to clean the product.
- Unplug the plug from the power socket.
- Wipe with a dry cloth to clean the chair, remote controller and power cord.
- Do not use a damp cloth or detergent.
 - Unplug the plug from the power socket.
 - Store the product in a cool dry place away from sunlight.
 - Do not put a heavy weight load on the product.

If the cover is damaged or there is any mechanical failure, please stop using the product. Contact the after-sales service immediately.

PRODUCT SPECIFICATIONS

Product Name	Massage Chair
Mode	JL10023WL-BN
Rated Voltage	120V
Power Input	60Hz
Power Consumption	150W
Packing Size	58" x 32" x 34"(L x W x H)
Net Weight	184 LBS
Gross Weight	227 LBS

Thank you very much!

Thank you for choosing products that meet your health needs. All products have been tested and confirmed to be safe and suitable for personal use.

Please read the manual carefully for correct usage and operation.

All rights reserved

Without permission, any form of reproduction, storage, transmission, translation, whether in part or in whole content will be considered copyright infringement.

Thank you for choosing this massage chair. Please read this instruction carefully before use, especially the safety precautions section, in order to use the massage chair correctly. Please store this manual properly after reading and refer to it whenever necessary.

Functions are subject to upgrade and change without prior notice. Please refer to the actual product.

Leg Mounting Instruction Card

1. Open the box, slowly take out the massage chair and legs, and check whether the installation accessories are complete.

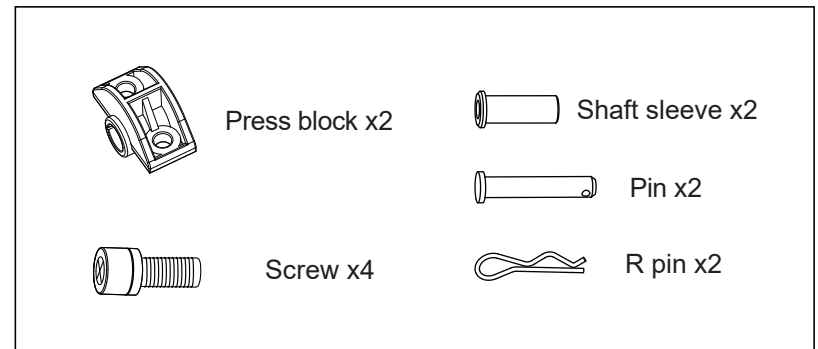

2. Place the shank shaft into the slot, then install the leg press block and tighten the cross screw with the appropriate tool.

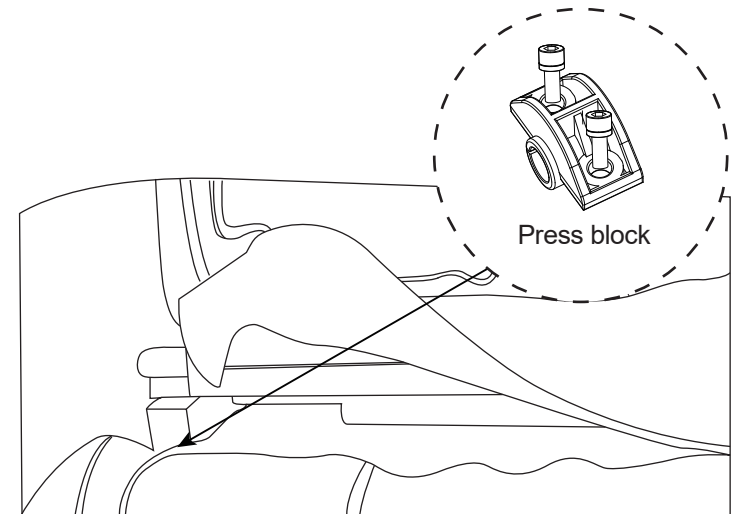



Costway Massage Chair Customer Warranty

Costway products include the following warranty:

This Costway massage chair has a three-year warranty for both parts and labor.

Costway customer service will not issue Return Material Authorizations (RMAs) for products due to buyer's remorse. RMAs will be issued only when product has quality problem. Costway products will be either repaired by the customer or by an in-home technician.

Service And Technical Support:

Customers can contact Costway's customer service department at 213-401-2666 at any time Monday through Friday or via email at topsupport@costway.com for warranty or service issues.

Customers are required to provide dated proof of purchase (sales receipt) when they contact Costway service department regarding a repair.



A Costway customer service representative will attend to most customer inquiries, however, in some cases, when necessary, a technical service specialist will provide advanced support.

Non-warranty repair is provided on a "per incident" basis. Costway customer service will verify that the unit has failed and provide instructions for repairing a unit. All applicable repairs, parts, shipping, handling, local tax, and a "per incident" fee will be charged for non-warranty repairs.

You can visit www.costway.com and www.costway.ca for the latest terms and pricing depending on the type of issue or incident.

Proof of purchase (sales receipt) is required for all warranty repairs or service.

Extended Warranties:

Costway offers extended warranty programs to enhance ownership of Costway products.

Extended warranty provides: A maximum 2-year limited repair or



replacement massage chair warranty with on-site service in certain areas.

Please visit www.costway.com and www.costway.ca for the latest terms for extended warranties.

Product Repairs

Many Costway product repairs may be performed by the customer in their own home with parts and instructions supplied by Costway, such as remote controller replacements that don't require a technician.

Customers may contact Costway's customer service department at topsupport@costway.com for warranty or service issues.

Floor Models and Demonstration Units have a prorated warranty period that begins the day the model is placed on the floor and connected to an electrical outlet by the retail partner. Proof of purchase (sales receipt) is required in order to obtain warranty service and parts. Non-warranty parts and service are available at a "per incident" rate.

Warranty Coverage Period: Warranty coverage begins on the date of customer purchase. Proof of purchase (sales receipt) is required for all



warranty repairs. The warranty period is measured by continuous calendar days based on a seven-day week.

Field Service: The Costway customer service department will diagnose the problem and schedule an authorized service provider to repair a chair in the customer's residence. If the area is not covered by Costway official or authorized service provider, after the Costway service team diagnose the problem and provide approval, customers may find their own qualified technician. Customers will be reimbursement once an invoice and proof of the technician's qualifications are submitted to the Costway customer service department. The value of reimbursement should not exceed the cost of a Costway official or authorized service provider.

Parts: All parts deemed necessary for repairs will be shipped to the customer at no charge.

CUSTOMER WARRANTY LIMITATIONS AND EXCLUSIONS

Warranties are not valid in certain areas. Invalid areas in Canada: NT, NU, YT.



Postcodes start with AOK, AOP, AOR, A2V, GOG, G4T, JOM, ROB, TOP, TOV, VOT, VOL, VOV, VOW, X0A, X0B, X0C, X0G, X0E, X1A, Y0A, Y0B, Y1A.

Invalid areas in US: Alaska, Hawaii, Puerto Rico, and Guam.

The warranty only applies to Costway products and does not include any accessories or enhancements.

Field service requires pre-approval and must be performed by qualified technicians. Costway official and authorized field service is only available in certain areas. Please visit www.costway.com and www.costway.ca for the latest information regarding authorized field service.

Softening of foams and filling composites in pillows, pads, and memory foam occurs naturally and does not constitute a defect under this warranty.

Fading, wear, and piling of fabrics occurs naturally and does not constitute a defect under this warranty.

Natural markings, grain, and dye variations in leather do not constitute a defect under this warranty.



Warranties do not cover any loss or damage resulting from improper installation, unauthorized repairs or modifications, improper use of electrical/power supply, loss of power, dropped products, a malfunction of or damage to an operating part from failure to provide manufacturer's recommended maintenance, transportation damage, theft, abuse, misuse, neglect, vandalism, or environmental conditions (fire, floods, rust, corrosion, sand, dirt, windstorms, hail, earthquakes, or exposure to other weather conditions), loss of use during the period the product is at a repair facility, or otherwise awaiting parts or repair.

Damage due to shipping and handling does not constitute a defect under this warranty.

Under no circumstance shall Costway or its representatives be liable for indirect, consequential, or incidental damages (including damages for lost profits, business interruption, bodily injury, medical harm, and the like), even if any party has been advised of the possibility of such damages.

Warranties are non-transferable and shall be in lieu of any other warranty, express or implied, including but not limited to any implied



warranty or merchant ability or fitness for particular use.

Costway's sole liability and the purchaser's exclusive right shall be for the repair, or at Costway's option, for the replacement of defective part.

Notwithstanding the above, if replacements parts for defective materials are not available, Costway reserves the right to make substitutions in lieu of repair or replacement.

All warranties begin on the date of purchase; no allowance or extension is offered for delivery and/or installation.

Warranties do not apply to rental, business, commercial, institutional, or other non-residential users.

Extended Warranty

LIMITED REPAIR OR REPLACEMENT MASSAGE CHAIR WARRANTY WITH
ON-SITE SERVICE

If you have a warranty or product question, please contact Costway's support team at 213-401-2666 at any time Monday through Friday, or via email at topsupport@costway.com.



In the event you detect and report a defect in the workmanship or material of the Equipment, during the Service Period, then the Administrator shall provide the services hereinafter described.

Your purchase of the Extended Warranty shall constitute your acceptance to the terms of this Limited Warranty including the indemnification provisions.

1) DEFINITIONS - For the purpose of this Limited Warranty, the following terms shall have the following meanings:

- (1) "Equipment" shall mean a Costway product or system;
- (2) "Customer" shall mean only the residential end-user of the Equipment who is the original purchaser of the equipment from the Distributor, from an authorized reseller.
- (3) Usages of "you" or "your" refer to the Customer;
- (4) "Commencement Date" shall mean the date on which the Equipment is first purchased by a Customer from the Distributor or from an authorized reseller;
- (5) "Service Period" shall mean the period commencing on the Commencement Date;



(6) "Administrator" shall mean Costway. Usage of "we," "us," or "our" shall mean the Administrator. You may contact the Administrator if you have questions regarding this coverage. We can be reached by phone at 213-401-2666.

2) COVERAGE - During the Service Period, we will repair or replace, at our sole discretion, any defective Equipment. We will return the Equipment to a properly functioning state. To obtain such service, you must be able to provide us with the original, dated proof of purchase (sales receipt) for the Equipment. This Limited Warranty extends only to Customers. Only our representatives may perform repairs on the Equipment under this Limited Warranty. Replaced parts shall be covered under this Limited Warranty for the remainder of the Service Period or for thirty (30) days, whichever is longer. We will provide on-site service as necessary on regular workdays. Submission of the Extended Warranty Card form is not a condition precedent to obtaining service under this Limited Warranty. If a particular replacement part is not available from the manufacturer, we will make reasonable efforts to locate a compatible replacement part. If we are unable to locate a compatible part, we may replace your Equipment with a similar product. Under no circumstances



shall the retail replacement value exceed the original net price paid for the Equipment. In the event you choose not to accept a replacement for your Equipment, we shall no longer be responsible for making repairs under this Limited Warranty.

3) EXCLUSIONS - This Limited Warranty does not include service needed on Equipment as a result of any of the following:

- (1) Installation, set-up, moving, or relocation from the originally installed location;
- (2) Cosmetic changes, tears, or failure of fabrics, woods, foam, pads, plastics, upholsteries, exterior coverings, and damages and changes resulting from normal wear and tear;
- (3) Negligence, misuse, abuse, improper maintenance, electrical disturbances and power surges, acts of nature, or work, attachments, additions, alterations, or modifications by persons other than authorized Administrator service providers;
- (4) Failure by the Customer to use a high-quality surge protector during the entire Service Period; (5) Improper operating environments;



- (6) Any problem not involving a defect;
- (7) Damage or malfunction whatsoever caused by an animal or pet;
- (8) Damage or malfunction whatsoever caused by liquids of any kind;
- (9) Rental, business, commercial, institutional, or other non-residential use;
- (10) Unnecessary service requirement. If no problem is found upon diagnosis by us or any other third party, you may be charged our standard rate for shipping costs and parts;
- (11) Dropped products or components (including remote controls);
- (12) Use of any item with the Equipment that is not designated for use with the Equipment; and
- (13) Field service requires pre-approval and must be performed by Costway's authorized field service personnel. Field service is only available in certain areas. Please visit www.costway.com and www.costway.ca for the latest information regarding field service.

4) YOUR RESPONSIBILITIES - You shall:

- (1) Operate the Equipment in an environment meeting the



requirements delineated in the Equipment's owner manual and other provided instructions;

(2) Protect the supply of electricity to the Equipment through the use a high-quality surge protection device;

(3) Permit no work on the Equipment except by our authorized service providers;

(4) Have an adult representative present whenever we provide support services;

(5) Perform telephone or email diagnostic procedures as requested by us;

(6) Safeguard and return (at our expense) all replacement parts shipped to you. Either the part to be replaced or the replacement part or item shipped to you must be returned to the Distributor upon request.

5) EXCULPATION AND INDEMNIFICATION - Our maximum liability under this Limited Warranty is limited to the cost of repairing or replacing defective Equipment. We shall not be liable to you for incidental and



consequential damages. Under no circumstances shall you or anyone else ever be deemed to be a third-party beneficiary of the agreement. We shall not be liable for, and you hereby indemnify and hold us and every authorized service provider innocent from, any and all loss, damage, claim, or cause of action, direct or indirect, incidental or consequential, occurring to you, or to the employees or agents of you, or to any other third party, or to the property of any of the foregoing, which may arise as a result of any defect covered by this Limited Warranty or as a result of any service performed under this Limited Warranty.

Exclusions:

- Any malfunction that is caused by circumstance beyond Costway's control.
- Damage or malfunction resulting from misuse or abuse including, but not limited to, damage from liquids of any kind, transit, shipping, relocation damage, incorrect voltage, operation contrary to what is detailed in the Owner's Manual, modification or repair by the user, use by anyone (whether the product is open or stowed) over weight capacity, or any use by more than one person at a time, outdoor usage, and any flood, fire, or other Acts of God.
- Normal wear and tear and all cosmetic damage to fabric or other exterior parts of the chair.



- Under no circumstances whatsoever shall Costway be liable for special, incidental, or consequential damages.
- Rental, business, commercial, institutional, or other non-residential use