

**EN**

With your inspiring rating, COSTWAY will be more consistent to offer you EASY SHOPPING EXPERIENCE, GOOD PRODUCTS and EFFICIENT SERVICE!

**DE**

Mit Ihrer inspirierenden Bewertung wird COSTWAY konsistenter sein, um Ihnen EIN SCHÖNES EINKAUFSERLEBNIS, GUTE PRODUKTE und EFFIZIENTEN SERVICE zu bieten!

**FR**

Avec votre évaluation inspirante, COSTWAY continuera à fournir une EXPÉRIENCE D'ACHAT PRATIQUE, des PRODUITS DE QUALITÉ et un SERVICE EFFICACE !

**ES**

Con su calificación inspiradora, COSTWAY será más consistente para ofrecerle EXPERIENCIA DE COMPRA FÁCIL, BUENOS PRODUCTOS y SERVICIO EFICIENTE.

**IT**

Con la tua valutazione incoraggiante, COSTWAY sarà più coerente per offrirti ESPERIENZA DI ACQUISTO FACILE, BUONI PRODOTTI e SERVIZIO EFFICIENTE!

**PL**

Dzięki twojej opinii COSTWAY będzie mógł oferować jeszcze WYGODNIEJSZE ZAKUPY, LEPSZE PRODUKTY i SPRAWNIEJSZĄ OBSŁUGĘ KLIENTA.

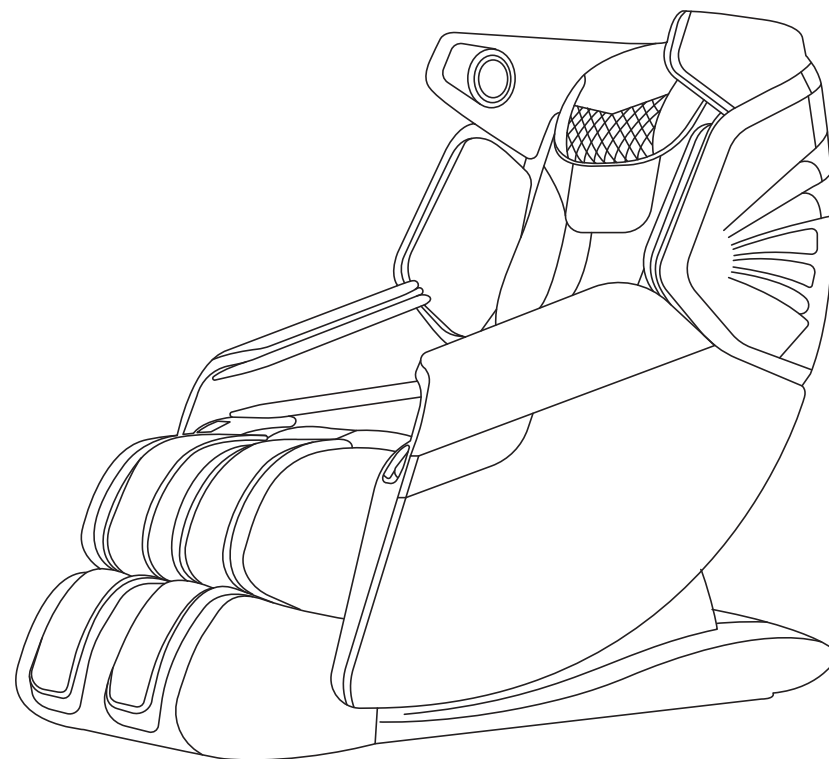
**USER'S MANUAL****Massage Chair  
JL10021WL-BN**

**US** office: Fontana

**UK** office: Ipswich

**AU** office: Truganina

**DE** office: Hamburg

**FR** office: Saint Vigor d'Ymonville

**PL** office: Gdańsk

This massager has been rigorously tested and confirmed to be safe and reliable. To ensure that you can use this massager correctly, please read this product manual carefully. Please keep it nearby so that you can read it at any time.

## **SAFETY PRECAUTIONS**

1. People with the following conditions should consult their physician before using the product:

- Who uses a medical electronic device, which is embedded in the body, such as a pacemaker.
- Who suffers from heart disease.
- Who suffers from backbone disease.
- Who is suffering from bone fragility, especially on the backbone.
- After surgery.
- Who is pregnant, after delivery or in a period of monthly illness.
- Who suffers from malignant tumors.
- Who is suffering from osteoporosis.
- who is suffering from skin disease or affection.
- Who is undergoing medical treatment or feels some physical abnormality previously or is being treated now.
- Who has some abnormality or deformity of limbs or backbone.

3. Wipe with a dry cloth to clean the chair, remote controller and power cord.

4. Do not use a damp cloth or detergent.

1. Unplug the plug from the power socket.

2. Store the product in a cool dry place away from sunlight.

3. Do not put a heavy weight load on the product.

If the cover is damaged or there is any mechanical failure, please stop using the product. Contact us immediately.

## PRODUCT SPECIFICATIONS

Project Name	Specification Description
Name of Product	Massage Chair
Type of Product	JL10021WL-BN
Power Input	120V, 60Hz
Power Consumption	100w
Box Dimension	1188(L)x828(W)x1175(H)mm
Net / Gross Weight	156LBS/201LBS

• Who has backbone problems or injuries due to illness or accident.  
Note: Never massage the swollen or inflamed parts of the body.

2. Do not let water enter the product or splash the surface of the product.

3. Water contact with electricity is dangerous. Do not leave the product in a humid environment (such as in bathroom or shower room or next to swimming pool).

4. Before connecting the product to the power supply, make sure the product voltage and supply voltage are the same.

5. If the plug, power cord or product itself is damaged, do not use the product.

6. In order to prevent the risk of electric shock, do not open the product outer casing.

7. Product is not intended for use by the disabled, sensory or mental impaired (including children), unless there is supervision or guidance by the people responsible for their safety when they use the product.

8. If the product or the power cord is damaged, in order to avoid danger, do not try to repair the product. This must be handled by specialist/technician.

9. Children should not use the product. They should be under supervision to ensure that they will not treat the product as a toy.

10. If unusual sound or noise is being heard from the product, turn off the product and immediately disconnect the power connection. Please contact us.

11. Do not use the product if cover is damaged or if there is a mechanical or electronic failure. You should contact us.

12. Only place the product in accordance with the instructions in this user manual.

13. Do not use the product in humid conditions and high temperature environment or beside hot objects such as heaters, stoves.

14. Do not apply medical or cosmetic cream on the product or on your body before or when using the product.

15. When massaging around or near the neck, take care of the movement of rollers and refrain from using excessive intensity.

16. Do not destroy, bend, stretch, twist or tie the power cord. Damaged power cord can cause fire or electric shock.

17. Do not use the product on bare skin.

18. Recommended usage time for an individual is within 30 minutes a day.

19. The maximum capacity is 220lbs. If it is over 220lbs, permanent damage to the product would be resulted.

20. Always keep the product clean and never insert any object into the gaps on and around the product.

21. The product is designed for household use only.

22. Do not stand, sit or jump on the calf-rest when the product is in use to prevent any injury or damage. 23. Do not attempt to stand on the backrest and armrest to prevent any injury to person.

### Warning:

- Who should avoid using this product: those who are physically, sensory, or mentally impaired, or who lack experience and knowledge. Unless they are supervised or directed by the person responsible for their safety regarding the use of this product.
- Children should be supervised to ensure that they cannot play with the massage chair.

Problem	Possible Cause	Suggestion
The product does not work	The product has just finished its 15-min auto timer session and has automatically switched to standby mode.	If you want another session, press the On/Off button again.
	You may have used the product continuously for more than 45 minutes and the overheat protection has been activated.	Unplug the product and let it cool down for 60 minutes before you use it again.
	An excessive load has been applied on the product.	Reduce the excess and start again.
The product is abnormally warm	The product is likely to be overused.	Unplug the product and let it cool down before using it again.
Noise can be heard from the product	Noise is made by the mechanical parts of the product.	This is normal and does not mean that the product is faulty.

## CARE & MAINTENANCE

### Cleaning

1. Do not use steel wool, abrasive cleaning agents or corrosive liquids (such as gasoline or acetone) to clean the product.
2. Unplug the plug from the power socket.

## 2. After use

1) Press the On/Off button to disable all functions before putting the remote controller into the controller pocket.

2) Turn off the power switch ( to "O" ) located at the back of the chair.

3) Remove plug from power socket.

- Please do not pull on the power cord to remove the plug.

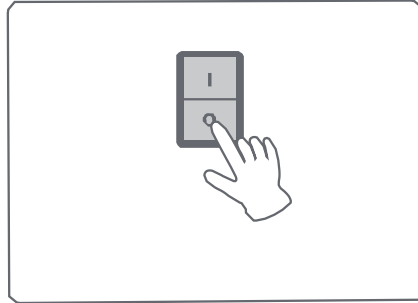

- If the power cord is damaged, it must be replaced with a dedicated cord or a special component purchased from its manufacturer or service department.
- The surface of the appliance is hot, and people who are not sensitive to heat must use caution.

## TROUBLE - SHOOTING

This page summarises the most common problems you would encounter with the product.

If you are unable to solve the problem with information below, please contact us immediately.





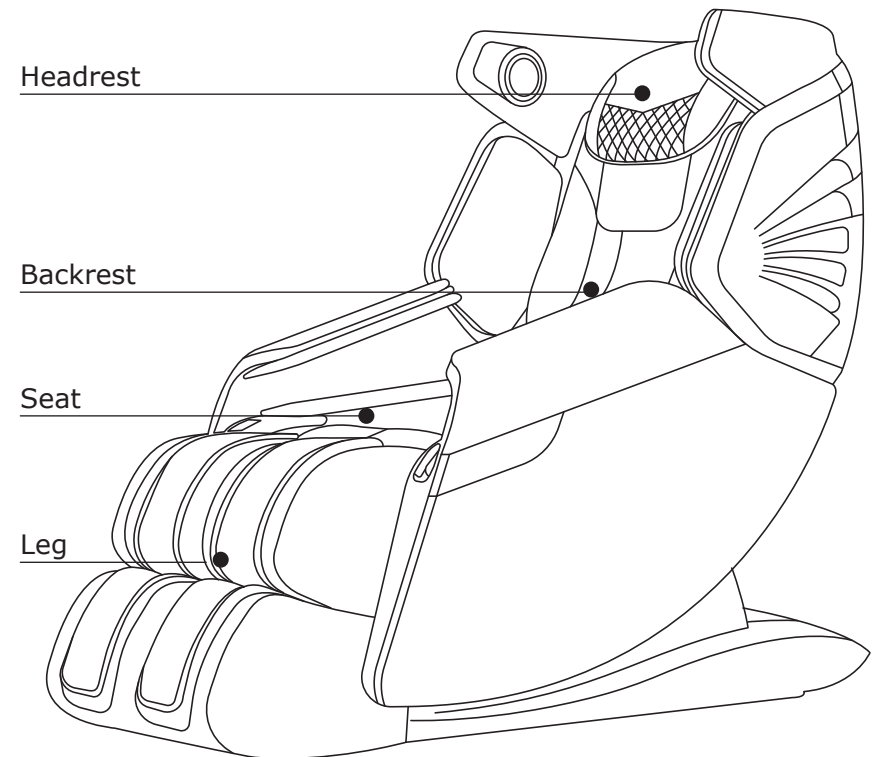

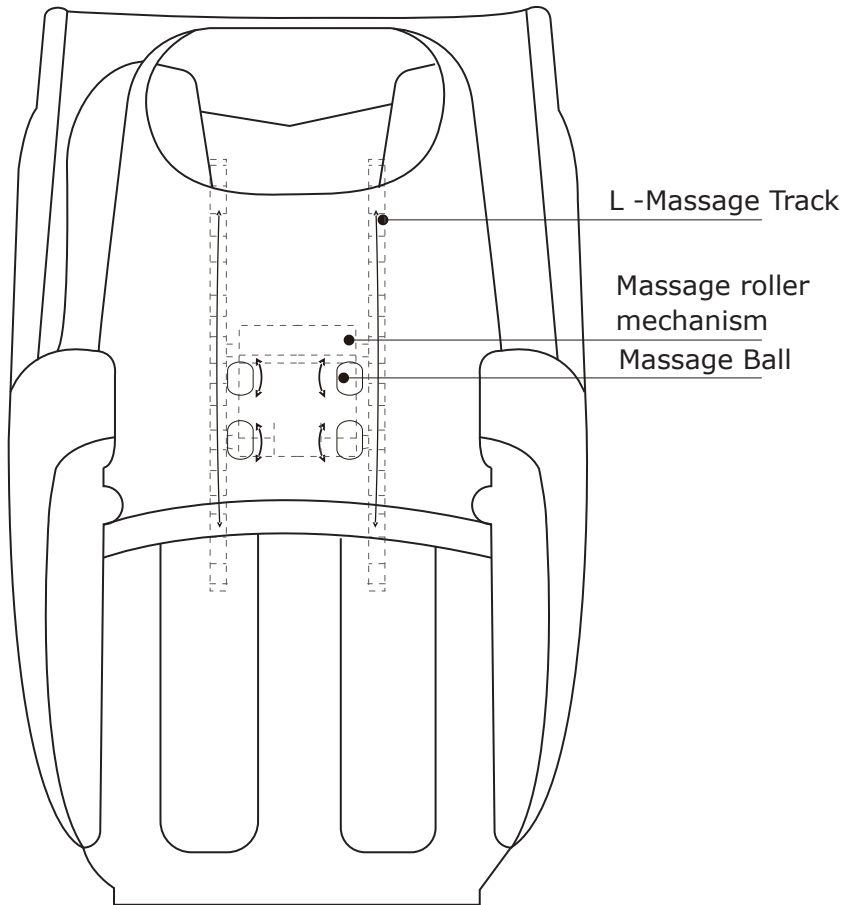

Problem	Possible Cause	Suggestion
The product does not work	The product is not plugged in properly.	Ensure the voltage on the product corresponds to the local mains voltage and then plug in again. Then press on the power switch.

## PRODUCT DESCRIPTION



## Massage chair movement



-  **Auto Programme**  
Press this button to choose from 4 Auto Programmes: Energy, Recovery, Relax and Sleep.
-  **3D Open**  
Enable/disable the 3D massage function.
-  **Heating/Foot roller**  
Short press: Turn on/off the Foot roller function.  
Long press: Turn on/off the Heating function.
-  **Manual Programme**  
Press this button to select from 3 manual programmes: Kneading, Tapping and Shiatsu. By pressing this button again, the programme will be disabled.
-  **Air Pressure**  
Air Pressure: weak, medium and strong three adjustable massage modes.
-  **Spot Massage**  
Spot massage can be selected when needed. This function is applicable to manual programme.
-  **(Mechanism) Up / Down**  
Press and hold this button to adjust the up / down of the massage mechanism during spot massage.
-  **(Backrest) Raise / Recline**  
Press this button to raise or recline the backrest. Press again to stop.

# REMOTE CONTROLLER

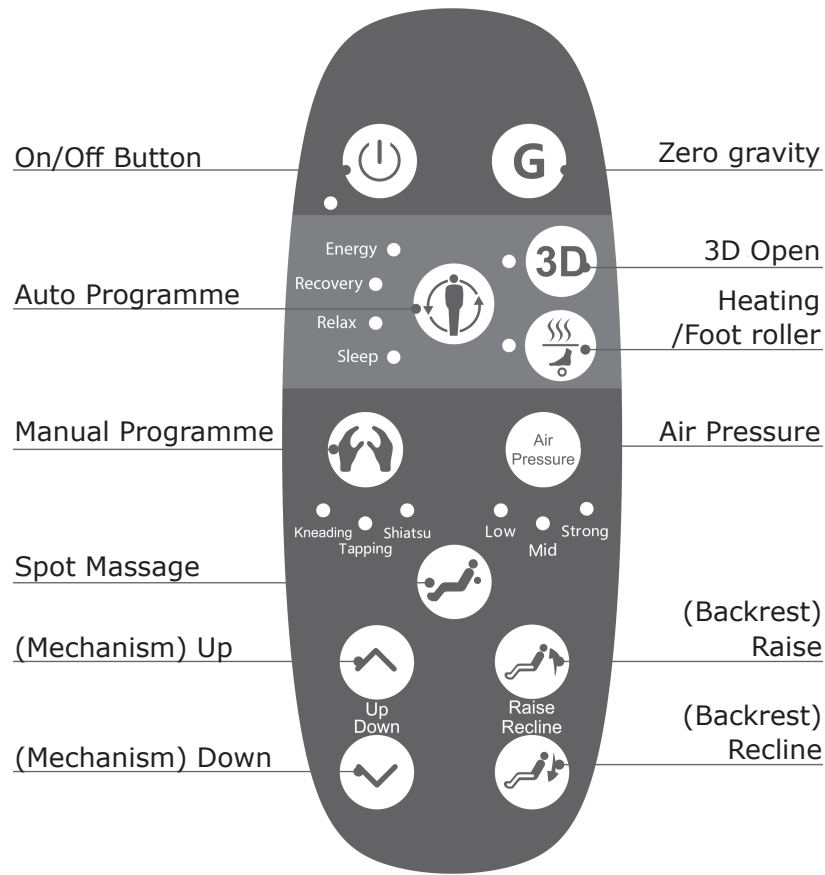

## Rear View

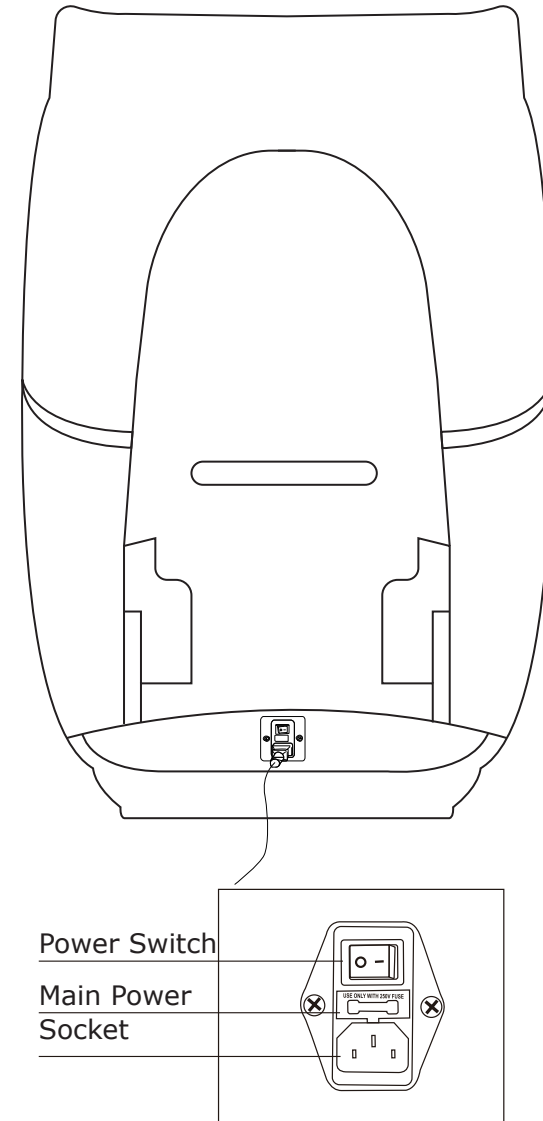

### On/Off Button

 Press once to enter standby mode. Press the button again to stop current massage function and return to standby mode.

### Zero gravity mode

 Press this key, similar to space zero gravity state, let the body in a natural and comfortable state, release physical and mental pressure.

# PREPARATION FOR USE

1) Remove the carton. Take out the chair.

2) Install the pillow and backrest cover.

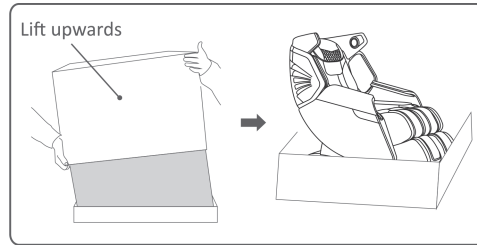

## 2. Place the chair in an open area

- Allow sufficient space around the chair for reclining purposes.
- To avoid damage to the floor and to reduce noise, please put a rug under the chair.
- Make sure that there is no barrier at the front and the back of the chair.
- Please do not put the chair on wet or uneven floor.
- To avoid signal interference, please place the chair 3.3 feet away from TV and radio.

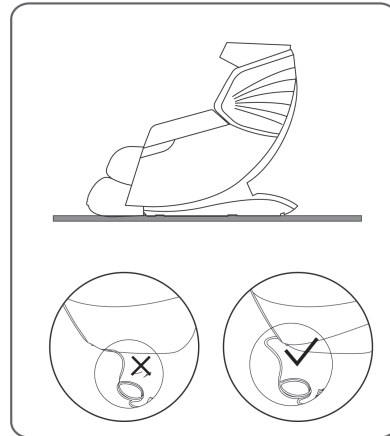

### **Warning:**

Do not put the power cord under the chair! Beware of damaging the power cord while moving the chair!

## 3. Move the chair

1) As illustrated, push the backrest downwards and tilt chair on to its wheels at a 45° angle.

2) Slowly push and move the chair to the desired location.

3) Lower the chair slowly and smoothly until it is fully flat on the ground.

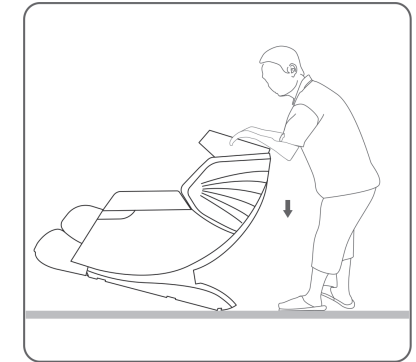

### **Warning:**

- Do not move the chair when occupied or in use.
- Moving the chair may cause damage to the floor. Floor protection is recommended (e.g. rugs or carpet).
- Do not drop or suddenly let go of the chair when moving as it may damage the chair.
- Two persons are recommended when moving the chair and extra care is required.





## **Costway Massage Chair Customer Warranty**

Costway products include the following warranty:

This Costway massage chair has a three-year warranty for both parts and labor.

Costway customer service will not issue Return Material Authorizations (RMAs) for products due to buyer's remorse. RMAs will be issued only when product has quality problem. Costway products will be either repaired by the customer or by an in-home technician.

### **Service And Technical Support:**

Customers can contact Costway's customer service department at 213-401-2666 at any time Monday through Friday or via email at [topsupport@costway.com](mailto:topsupport@costway.com) for warranty or service issues.

Customers are required to provide dated proof of purchase (sales receipt) when they contact Costway service department regarding a repair.



A Costway customer service representative will attend to most customer inquiries, however, in some cases, when necessary, a technical service specialist will provide advanced support.

Non-warranty repair is provided on a "per incident" basis. Costway customer service will verify that the unit has failed and provide instructions for repairing a unit. All applicable repairs, parts, shipping, handling, local tax, and a "per incident" fee will be charged for non-warranty repairs.

You can visit [www.costway.com](http://www.costway.com) and [www.costway.ca](http://www.costway.ca) for the latest terms and pricing depending on the type of issue or incident.

Proof of purchase (sales receipt) is required for all warranty repairs or service.

## **Extended Warranties:**

Costway offers extended warranty programs to enhance ownership of Costway products.

Extended warranty provides: A maximum 2-year limited repair or



replacement massage chair warranty with on-site service in certain areas.

Please visit [www.costway.com](http://www.costway.com) and [www.costway.ca](http://www.costway.ca) for the latest terms for extended warranties.

## **Product Repairs**

Many Costway product repairs may be performed by the customer in their own home with parts and instructions supplied by Costway, such as remote controller replacements that don't require a technician.

Customers may contact Costway's customer service department at [topsupport@costway.com](mailto:topsupport@costway.com) for warranty or service issues.

Floor Models and Demonstration Units have a prorated warranty period that begins the day the model is placed on the floor and connected to an electrical outlet by the retail partner. Proof of purchase (sales receipt) is required in order to obtain warranty service and parts. Non-warranty parts and service are available at a "per incident" rate.

Warranty Coverage Period: Warranty coverage begins on the date of customer purchase. Proof of purchase (sales receipt) is required for all



warranty repairs. The warranty period is measured by continuous calendar days based on a seven-day week.

**Field Service:** The Costway customer service department will diagnose the problem and schedule an authorized service provider to repair a chair in the customer's residence. If the area is not covered by Costway official or authorized service provider, after the Costway service team diagnose the problem and provide approval, customers may find their own qualified technician. Customers will be reimbursement once an invoice and proof of the technician's qualifications are submitted to the Costway customer service department. The value of reimbursement should not exceed the cost of a Costway official or authorized service provider.

**Parts:** All parts deemed necessary for repairs will be shipped to the customer at no charge.

## **CUSTOMER WARRANTY LIMITATIONS AND EXCLUSIONS**

Warranties are not valid in certain areas. Invalid areas in Canada: NT, NU, YT.



Postcodes start with AOK, AOP, AOR, A2V, GOG, G4T, JOM, ROB, TOP, TOV, VOT, VOL, VOV, VOW, X0A, X0B, X0C, X0G, X0E, X1A, Y0A, Y0B, Y1A.

Invalid areas in US: Alaska, Hawaii, Puerto Rico, and Guam.

The warranty only applies to Costway products and does not include any accessories or enhancements.

Field service requires pre-approval and must be performed by qualified technicians. Costway official and authorized field service is only available in certain areas. Please visit [www.costway.com](http://www.costway.com) and [www.costway.ca](http://www.costway.ca) for the latest information regarding authorized field service.

Softening of foams and filling composites in pillows, pads, and memory foam occurs naturally and does not constitute a defect under this warranty.

Fading, wear, and piling of fabrics occurs naturally and does not constitute a defect under this warranty.

Natural markings, grain, and dye variations in leather do not constitute a defect under this warranty.



Warranties do not cover any loss or damage resulting from improper installation, unauthorized repairs or modifications, improper use of electrical/power supply, loss of power, dropped products, a malfunction of or damage to an operating part from failure to provide manufacturer's recommended maintenance, transportation damage, theft, abuse, misuse, neglect, vandalism, or environmental conditions (fire, floods, rust, corrosion, sand, dirt, windstorms, hail, earthquakes, or exposure to other weather conditions), loss of use during the period the product is at a repair facility, or otherwise awaiting parts or repair.

Damage due to shipping and handling does not constitute a defect under this warranty.

Under no circumstance shall Costway or its representatives be liable for indirect, consequential, or incidental damages (including damages for lost profits, business interruption, bodily injury, medical harm, and the like), even if any party has been advised of the possibility of such damages.

Warranties are non-transferable and shall be in lieu of any other warranty, express or implied, including but not limited to any implied



warranty or merchant ability or fitness for particular use.

Costway's sole liability and the purchaser's exclusive right shall be for the repair, or at Costway's option, for the replacement of defective part.

Notwithstanding the above, if replacements parts for defective materials are not available, Costway reserves the right to make substitutions in lieu of repair or replacement.

All warranties begin on the date of purchase; no allowance or extension is offered for delivery and/or installation.

Warranties do not apply to rental, business, commercial, institutional, or other non-residential users.

## **Extended Warranty**

LIMITED REPAIR OR REPLACEMENT MASSAGE CHAIR WARRANTY WITH  
ON-SITE SERVICE

If you have a warranty or product question, please contact Costway's support team at 213-401-2666 at any time Monday through Friday, or via email at [topsupport@costway.com](mailto:topsupport@costway.com).



In the event you detect and report a defect in the workmanship or material of the Equipment, during the Service Period, then the Administrator shall provide the services hereinafter described.

Your purchase of the Extended Warranty shall constitute your acceptance to the terms of this Limited Warranty including the indemnification provisions.

1) DEFINITIONS - For the purpose of this Limited Warranty, the following terms shall have the following meanings:

- (1) "Equipment" shall mean a Costway product or system;
- (2) "Customer" shall mean only the residential end-user of the Equipment who is the original purchaser of the equipment from the Distributor, from an authorized reseller.
- (3) Usages of "you" or "your" refer to the Customer;
- (4) "Commencement Date" shall mean the date on which the Equipment is first purchased by a Customer from the Distributor or from an authorized reseller;
- (5) "Service Period" shall mean the period commencing on the Commencement Date;





(6) "Administrator" shall mean Costway. Usage of "we," "us," or "our" shall mean the Administrator. You may contact the Administrator if you have questions regarding this coverage. We can be reached by phone at 213-401-2666.

2) COVERAGE - During the Service Period, we will repair or replace, at our sole discretion, any defective Equipment. We will return the Equipment to a properly functioning state. To obtain such service, you must be able to provide us with the original, dated proof of purchase (sales receipt) for the Equipment. This Limited Warranty extends only to Customers. Only our representatives may perform repairs on the Equipment under this Limited Warranty. Replaced parts shall be covered under this Limited Warranty for the remainder of the Service Period or for thirty (30) days, whichever is longer. We will provide on-site service as necessary on regular workdays. Submission of the Extended Warranty Card form is not a condition precedent to obtaining service under this Limited Warranty. If a particular replacement part is not available from the manufacturer, we will make reasonable efforts to locate a compatible replacement part. If we are unable to locate a compatible part, we may replace your Equipment with a similar product. Under no circumstances



shall the retail replacement value exceed the original net price paid for the Equipment. In the event you choose not to accept a replacement for your Equipment, we shall no longer be responsible for making repairs under this Limited Warranty.

3) EXCLUSIONS - This Limited Warranty does not include service needed on Equipment as a result of any of the following:

- (1) Installation, set-up, moving, or relocation from the originally installed location;
- (2) Cosmetic changes, tears, or failure of fabrics, woods, foam, pads, plastics, upholsteries, exterior coverings, and damages and changes resulting from normal wear and tear;
- (3) Negligence, misuse, abuse, improper maintenance, electrical disturbances and power surges, acts of nature, or work, attachments, additions, alterations, or modifications by persons other than authorized Administrator service providers;
- (4) Failure by the Customer to use a high-quality surge protector during the entire Service Period; (5) Improper operating environments;



- (6) Any problem not involving a defect;
- (7) Damage or malfunction whatsoever caused by an animal or pet;
- (8) Damage or malfunction whatsoever caused by liquids of any kind;
- (9) Rental, business, commercial, institutional, or other non-residential use;
- (10) Unnecessary service requirement. If no problem is found upon diagnosis by us or any other third party, you may be charged our standard rate for shipping costs and parts;
- (11) Dropped products or components (including remote controls);
- (12) Use of any item with the Equipment that is not designated for use with the Equipment; and
- (13) Field service requires pre-approval and must be performed by Costway's authorized field service personnel. Field service is only available in certain areas. Please visit [www.costway.com](http://www.costway.com) and [www.costway.ca](http://www.costway.ca) for the latest information regarding field service.

4) YOUR RESPONSIBILITIES - You shall:

- (1) Operate the Equipment in an environment meeting the



requirements delineated in the Equipment's owner manual and other provided instructions;

(2) Protect the supply of electricity to the Equipment through the use a high-quality surge protection device;

(3) Permit no work on the Equipment except by our authorized service providers;

(4) Have an adult representative present whenever we provide support services;

(5) Perform telephone or email diagnostic procedures as requested by us;

(6) Safeguard and return (at our expense) all replacement parts shipped to you. Either the part to be replaced or the replacement part or item shipped to you must be returned to the Distributor upon request.

5) EXCULPATION AND INDEMNIFICATION - Our maximum liability under this Limited Warranty is limited to the cost of repairing or replacing defective Equipment. We shall not be liable to you for incidental and



consequential damages. Under no circumstances shall you or anyone else ever be deemed to be a third-party beneficiary of the agreement. We shall not be liable for, and you hereby indemnify and hold us and every authorized service provider innocent from, any and all loss, damage, claim, or cause of action, direct or indirect, incidental or consequential, occurring to you, or to the employees or agents of you, or to any other third party, or to the property of any of the foregoing, which may arise as a result of any defect covered by this Limited Warranty or as a result of any service performed under this Limited Warranty.

Exclusions:

- Any malfunction that is caused by circumstance beyond Costway's control.
- Damage or malfunction resulting from misuse or abuse including, but not limited to, damage from liquids of any kind, transit, shipping, relocation damage, incorrect voltage, operation contrary to what is detailed in the Owner's Manual, modification or repair by the user, use by anyone (whether the product is open or stowed) over weight capacity, or any use by more than one person at a time, outdoor usage, and any flood, fire, or other Acts of God.
- Normal wear and tear and all cosmetic damage to fabric or other exterior parts of the chair.



- Under no circumstances whatsoever shall Costway be liable for special, incidental, or consequential damages.
- Rental, business, commercial, institutional, or other non-residential use