

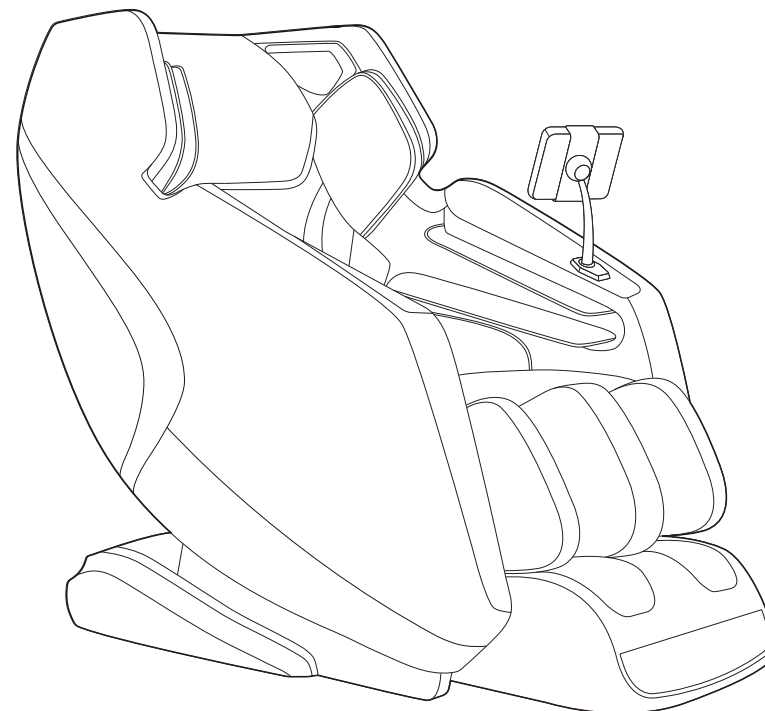

**Please give us a chance to make it right and do better !**

Contact our friendly customer service department for help first.  
Replacements for missing or damaged parts will be shipped ASAP !

**US** office: Fontana    **UK** office: Ipswich    **AU** office: Truganina  
**DE** office: Hamburg    **FR** office: Saint Vigor d'Ymonville    **PL** office: Gdańsk



## Contact Us!

**Do NOT return this item.**

Contact our friendly customer service department for help first.



US: cs.us@costway.com  
UK: cs.uk@costway.com  
AU: cs.au@costway.com

## USER'S MANUAL

### Massage Chair JL10013

THIS INSTRUCTION BOOKLET CONTAINS **IMPORTANT** SAFETY INFORMATION. PLEASE READ AND KEEP FOR FUTURE REFERENCE.



## Before You Start

- ⚠ Please read all instructions carefully.
- ⚠ Retain instructions for future reference.
- ⚠ Separate and count all parts and hardware.
- ⚠ Read through each step carefully and follow the proper order.
- ⚠ We recommend that, where possible, all items are assembled near to the area in which they will be placed in use, to avoid moving the product unnecessarily once assembled.
- ⚠ Always place the product on a flat, steady and stable surface.
- ⚠ Keep all small parts and packaging materials for this product away from babies and children as they potentially pose a serious choking hazard.

## Safety

### IMPORTANT SAFETY INSTRUCTIONS

This massage chair is intended for household only .When using an electrical appliance, basic precautions should always be followed, including the following:

Read all instructions before using this massage chair.

**DANGER**-To reduce the risk of electric shock:

- 1) Always unplug this appliance from the electrical outlet immediately after using and before cleaning.
- 2) Never use pins or other metallic fasteners with this appliance.
- 3) Carefully examine the covering before each use. Discard the appliance if the covering shows any sign of deterioration, such as checking, blistering, or cracking.
- 4) Keep Dry - Do not operate in a wet or moist condition.

**WARNING**-To reduce the risk of burns, fire, electric shock, or injury to persons:

- 1) An appliance should never be left unattended when plugged in. Unplug from outlet when not in use, and before putting on or taking off parts.
- 2) Do not operate under blanket or pillow. Excessive heating can occur and cause fire, electric shock, or injury to persons.
- 3) Close supervision is necessary when this appliance is used by, on, or near children, invalids, or disabled persons. Keep children away from extended foot support.
- 4) Use this appliance only for its intended use as described in this manual.

Do not use attachments not recommended by the manufacturer.

- 5) Never operate this appliance if it has a damaged cord or plug, if it is not working properly, if it has been dropped or damaged, or dropped into water.

Return the appliance to a service center for examination and repair.

- 6) Do not carry this appliance by supply cord or use cord as a handle.
- 7) Keep the cord away from heated surfaces.
- 8) Never operate the appliance with the air openings blocked. Keep the air openings free of lint, hair, and the like.
- 9) Never drop or insert any object into any opening.
- 10) Do not use outdoors.
- 11) Do not operate where aerosol (spray) products are being used or where oxygen is being administered.
- 12) To disconnect, turn all controls to the off position, then remove plug from outlet.
- 13) Temperatures sufficiently high to cause burns may occur regardless of the control setting. Do not use on an infant or invalid or on a sleeping or unconscious person. Do not use on insensitive skin or on a person with poor blood circulation. Check the skin in contact with the heated area of the appliance frequently to reduce the risk of blistering.
- 14) Do Not Crush - Avoid sharp folds.
- 15) Do not use massager in close proximity to loose clothing or jewelry.
- 16) Keep long hair away from massager while in use.
- 17) Connect this appliance to a properly grounded outlet only. See Grounding Instructions.
- 18) The apparatus shall not be exposed to dripping or splashing and that no objects filled with liquids, such as vases, shall be placed on the apparatus.
- 19) An apparatus with CL ASS I construction shall be connected to a MAINS socket outlet with a protective earthing connection
- 20) The appliance coupler is used as the disconnect device, the disconnect device shall remain readily operable.

- 21) This appliance is not intended for use by persons (including children) with reduced physical, sensory or mental capabilities, or lack of experience and knowledge, unless they have been given supervision Or instruction concerning use of the appliance by a person responsible for their safety.
- 22) If it is not in use for a long time or after use, please turn off the power and pull out the power plug.
- 23) Do not damage, break, over-bend, compress, tighten, wind, rotate or knot the power cord.

## SAVE THESE INSTRUCTIONS

**This massage chair is intended for household use only.**

### •Usage Environment

- Do not use the massage chair in an excessively humid or dusty environment as this may result in malfunction or electric shock.
- Do not use the massage chair in a room with a temperature of 104°F or higher.
- Do not expose the massage chair to heaters, stoves or direct sunlight. Place and use the massage chair on an even, non-slip floor.
- The massage chair is designed for home use and not for commercial purposes.

### **Caution**

- The massage chair is to be used indoors only.
- If you use the massage chair in a cold room, do not increase the room temperature abruptly. It is recommended that you increase the temperature gradually to a normal level.
- If the massage chair is stored in a cold place and is being brought into a warm environment, it is advisable to wait one hour before use. This is because its performance may not be at optimum level, as there may be water droplets on the mechanical parts due to condensation. Using the massage chair under such conditions may result in malfunction.

## IMPORTANT SAFETY INSTRUCTIONS

### • Safety Precautions

- To ensure safe and correct use of the massage chair, do not operate it without reading this operation manual carefully.
- Do not use the massage chair when the upholstery or seat is removed. This may cause injury or malfunction.
- Do not use the massage chair in combination with other therapeutic equipment or electric blanket, etc., as this may result in ineffectiveness or injury.
- Do not use the massage chair an hour before or after eating as this may have adverse effects on the user.
- Do not allow children or pets to play around the massage chair, e.g., behind the backrest, under the seat or leg rest of the massage chair. This may result in injury.
- Do not rest or place heavy objects on the armrests, leg rest or backrest as this may result in malfunction or injury.
- Do not use the massage chair when your body is wet.
- Do not operate the massage chair with wet hands.

It is not recommended to use the massage for more than 15 minutes.

- Do not perform continuous massage on the same spot of your body for more than 5 minutes at a time as this may result in excessive stimulation and may have adverse effects.
- Do not insert your hand or foot along the paths of the massage rollers during use as this may cause injury.
- Stop operation immediately if you experience any discomfort.
- This product is not intended for self-treatment of conditions that should be managed by a qualified health care provider.
- People on medication or with medical conditions, please consult your doctor before use.

### • People with Medical Conditions

**Consult your doctor before use if you:**

- are under medical rest as ordered by a doctor.
- have spinal disorders, an abnormal spinal condition or have suffered a spinal injury.
- have back problems.
- have diabetes, osteoporosis or sensory impairment.have joint dysfunction.
- have a pacemaker or other electronic medical devices.may be pregnant.
- have phlebitis or thrombosis.
- have an increased risk for blood clots.had recent surgery.
- have surgical pins, screws, or anything mechanical implanted in your body.

### • Instances When the massage chair Should Not Be Used

**In the following events, please switch off the main power switch immediately and disconnect the power cord from the electrical outlet:**

- If water is accidentally spilled onto the massage chair. This may result in electric shock or malfunction.
- If the fabric of the backrest is torn and the internal components are exposed.
- If pain or discomfort is felt during massage, stop operation immediately and consult your doctor.
- If you detect any malfunction or any other abnormal condition during operation.
- If there is a power failure. Injury may occur when power is restored unexpectedly.
- If there is lightning.

### • Assembly and Repair of the massage chair

- Do not disassemble the backrest cover of the massage chair. Touching the internal components may result in malfunction or electric shock.
- The massage chair must only be professionally serviced or repaired. Do not attempt to disassemble or repair the massage chair yourself.

### • Things to Note About the Power Plug and Cord

- Check that the Alternating Current (AC) voltage corresponds with the specifications indicated for the massage chair.
- Do not connect or disconnect the power plug from the electrical outlet with wet hands. This may result in malfunction or electric shock.
- When disconnecting the power plug, pull it by holding the plug, not the cord.
- Although operation will be stopped automatically by the Auto-Timer function, always remember to switch off the main power switch after use. Do not place the power cord under the massage chair or any other heavy objects.
- Do not wind the power cord around the massage chair as this may damage the cord and result in a fire or electric shock.
- Do not operate the massage chair with a damaged cord or extension cord.
- Do not use the massage chair if the electrical outlet is loose.
- If the power cord is damaged, it should be replaced by a qualified technician.

### • Grounding Instructions

This product must be grounded. If it is malfunction or breakdown, grounding provides a path of least resistance for electric current to reduce the risk of electric shock. This product is equipped with a cord having an equipment-grounding conductor and a grounding plug. The plug must be plugged into an appropriate outlet that is properly installed and grounded in accordance with all local codes and ordinances.

**DANGER**-Improper connection of the equipment-grounding conductor can result in a risk of electric shock. Check with a qualified electrician or serviceman if you are in doubt as to whether the product is properly grounded. Do not modify the plug provided with the product - if it will not fit the outlet, have a proper outlet installed by a qualified electrician.

This product is for use on a nominal 100-240V~ circuit and has a grounding plug that looks like the plug illustrated in sketch A as following illustration. Make sure that the product is connected to an outlet having the same configuration as the plug. No adapter should be used with this product.

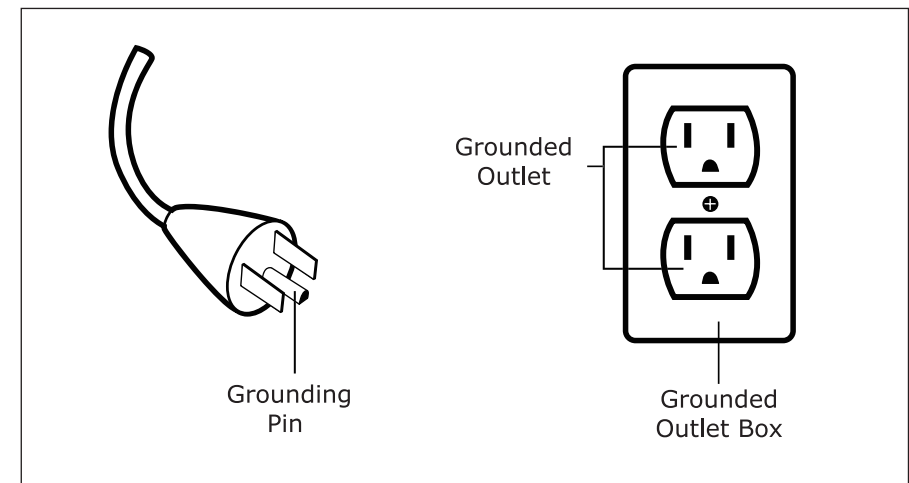

## Components

### Outer Structure

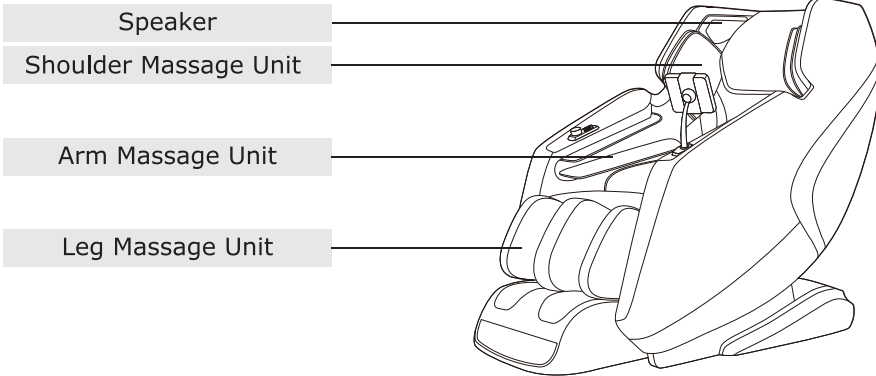

### Intelligent Body Scanning

- When turning the chair on, it will start auto body scan measuring for the key areas of the back including your height. Please relax and lay your head down on the pillow.
- If you are not satisfied with the shoulder&neck detection, please press UP and DOWN to adjust manually, and press OK to confirm.

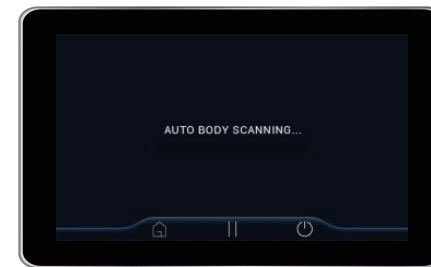

### Functions



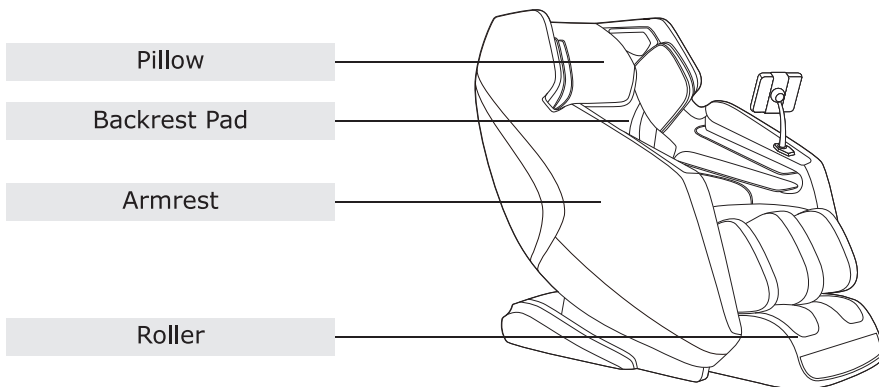
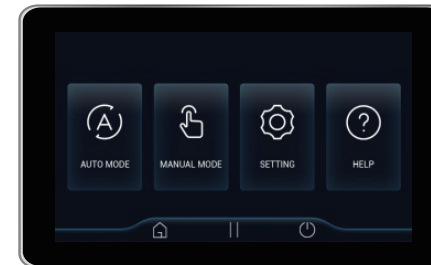



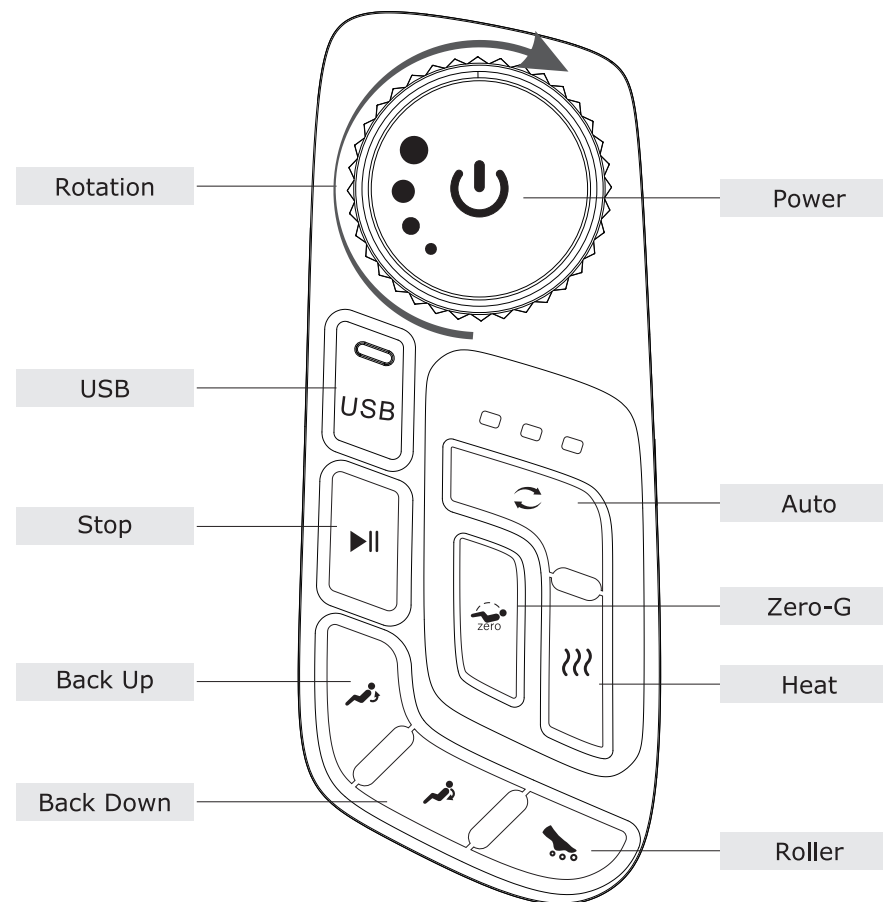

- You can choose the function according to your needs.
- You can check the Help (?) to know how to use.



| Function  | Description   |
|-----------|---|
| Auto Mode | Choose a professional auto massage program , which is subject to the actual product.  |
| Pro Mode  | According to your own needs, you can choose a suitable massage technique for targeted massage, which can be generated as a proprietary program. |
| Memo Mode | Choose a favorite program for massage.  |
| Setting   | Go to the settings page and set the time, language, brightness, and sound.  |

### Shortcut Key



| Function                  | Button  | Instruction  |
|---------------------------|---|--|
| Power                     |    | ON/OFF   |
| Rotation                  |    | Rotate clockwise to increase stage, and counterclockwise to decrease stages. The stage are divided into 1-5 stage.               |
| Stop                      |    | Press this button to switch between multiple automatic program functions. The specific display is subject to the actual product. |
| Auto                      |    | Press this button to switch between multiple automatic program functions. The specific display is subject to the actual product. |
| Heat                      |    | Press this button to turn ON/OFF the heating function.   |
| Zero-G                    |  | Press this button to turn off or switch the zero gravity of stage 1/2.   |
| Back Up<br>/<br>Back Down |  | Press the Back Up/Down button to adjust the backrest angle.  |
| Roller                    |  | Press the button to activate Roller, Press again to stop this function.  |

## Preparation Before Use

### Move the Chair

- Please turn off the main power and unplug the power from the electrical outlet.
- Tilt the chair backward as shown in the picture below and wheel it to the desired location.
- Please cover the floor with mat when move the massage chair in case that any damage of floor will be made.

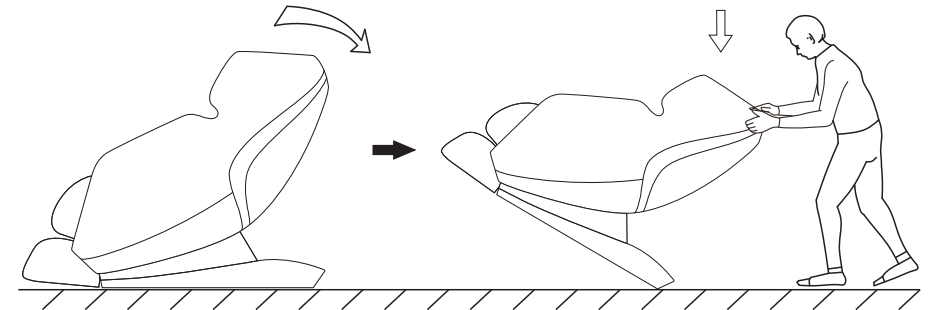

### Site of Placement

Please make sure that there is an allowance of more than 2 inch behind the massage chair, and more than 14 inch in front of the massage chair to allow the backrest to recline without obstruction during operation.

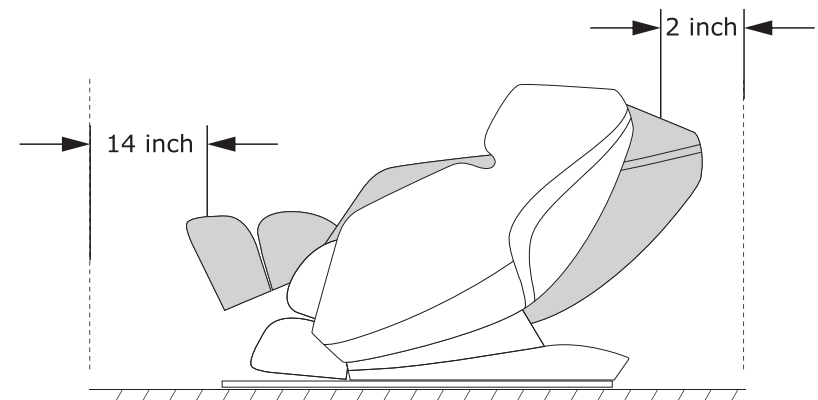



## Place the Leg rest

- To prevent any damage from a sudden drop of the leg rest, please support the leg rest with both hands and gently put it down to its initial position.

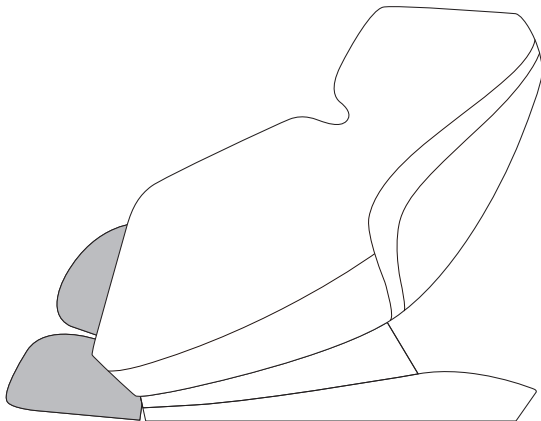
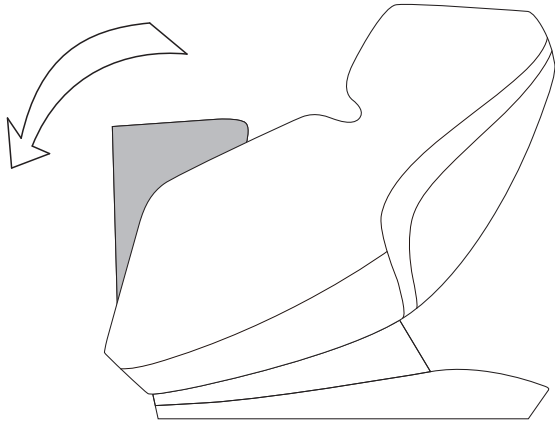

## Install Backrest Pad and Pillow Pad

- Attach the upper backrest pad to backrest with zipper.
- Attach the pillow pad to backrest with Velcro.



- Attach the left side of backrest pad to backrest with zipper, same as the other side.

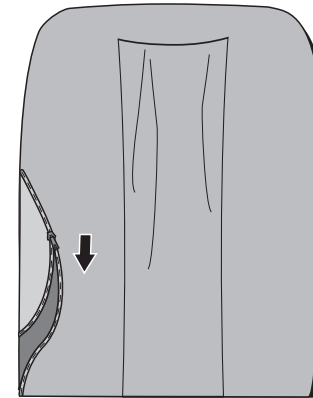

## Installation of manual bracket

- Aligned holes, lock screw.
- Press down to align the snap.

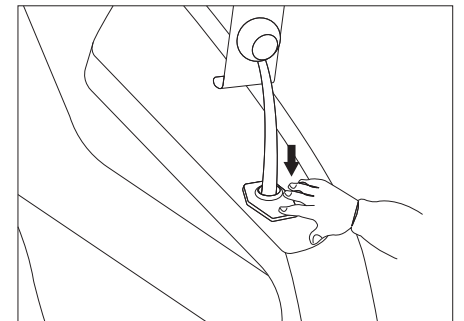
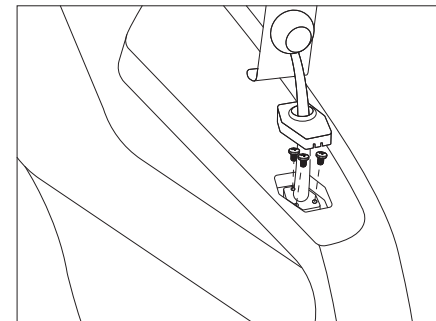

## Remote Controller Connection

- Connect the cable of remote controller with the cable under seat.

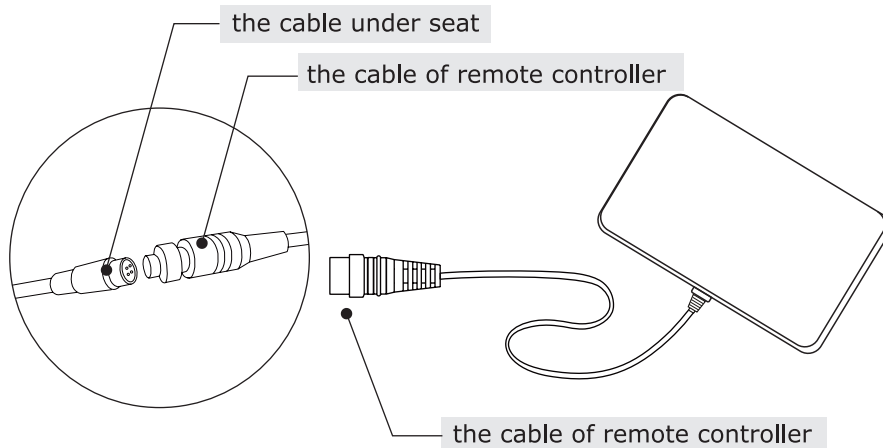

## Connect power

- Plug the power cord into power inlet, turn on the power switch.

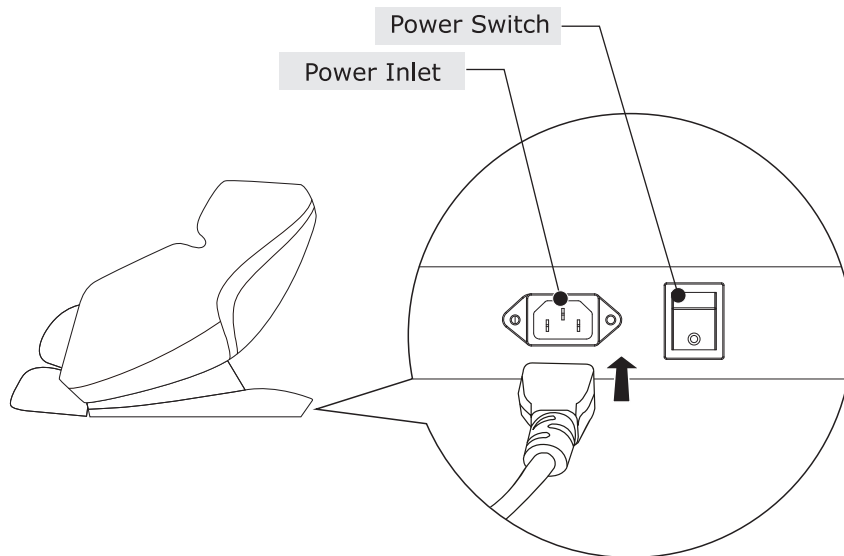

## Cleaning and Maintenance

### Maintenance methods

**Please follow the below steps to clean leather and plastic parts**

1. Please ensure the main switch is off and the power plug is unplugged from the electrical outlet.
2. Dip a soft, dry cloth in water or warm water containing 3% to 5% neutral detergent and wring it thoroughly.
3. Clean the leather and plastic parts.
4. Then wipe with dry soft cloth.
5. Let it dry naturally.

### Warning

- Do not use alcohol, thinner, gasoline and other chemicals for cleaning.
- Do not dry the surface with a blower.
- Do not iron the fabric.
- During maintenance, always unplug the power plug. Do not unplug it by wet hands.
- Please use a dust cover to avoid dust if you won't use the chair for a long time.
- As fabric's color may be dyed on the leather, be careful when using denim and colored cloth to wipe the product.
- Wipe the product with the melamine foam dipped in mild detergent, if the dirt is hard to remove.
- Do not let the leather touch plastic in case of the color fading.
- Water temperature should not exceed 104 °F.

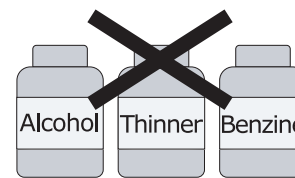

Please do not use



Water Temperature  
<104 °F.

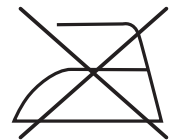

Do not iron

# Troubleshooting

If there is still an abnormality after the following checks, to prevent any accident, please stop using the massage chair immediately. Please unplug the power cord from the outlet and contact with customer service center.

| Problem                                    | Possible cause/action   |
|--|---|
| The massage rollers move up and then stop. | In order not to affect the body, the automatic timer function will move the massage roller to the upper end when the massage is over .  |
| Noise during the massage                   | <ul style="list-style-type: none"> <li>• The sound of clapping;</li> <li>• Friction sound of the massage wheel and fabric during kneading;</li> <li>• The sound of the massage wheel when lifting and kneading;</li> <li>• The sound during air pressure massage;;</li> <li>• The sound of the inflator pump;</li> <li>• The sound of airbag exhausting;</li> <li>• The sound of the backrest up and down.</li> </ul> |

Inevitable in structure, not abnormal

| Problem   | Possible cause/action   |
|---|---|
| The massage roller will stop during the massage.  | <ul style="list-style-type: none"> <li>•If the force applied to the massage rollers is too large, the massage rollers will stop running.</li> <li>•Lift your body slightly when using it, or raise the backrest slightly. (especially those who weigh more than 265lbs, please pay attention</li> </ul> |
| Press the power button, but the massage chair doesn't work properly or cannot connect to the power. | <ul style="list-style-type: none"> <li>• Please check the following:                             <ol style="list-style-type: none"> <li>1. Is the power plug fully inserted into the socket?</li> <li>2. Is the main power switch on the left rear of the unit turned on?</li> </ol> </li> </ul>        |
| The power cord and plug are abnormally hot.   | <ul style="list-style-type: none"> <li>• Please stop using immediately.</li> </ul>  |
|   | Please contact with customer service.   |
|   | Do not disassemble or repair it yourself or by non-professionals.   |

After checking, if there is still an abnormality, please stop using the massage chair immediately.

## Specifications

|                    |                                |
|--------------------|--------------------------------|
| Model              | JL10013                        |
| Rated Voltage      | 100- 240V~                     |
| Rated Frequency    | 50-60Hz                        |
| Rated Power        | 170W                           |
| Upright Dimension  | 60x 30 x 44.5 inch (L x W x H) |
| Extended Dimension | 64x 30x 37.5 inch (L x W x H)  |

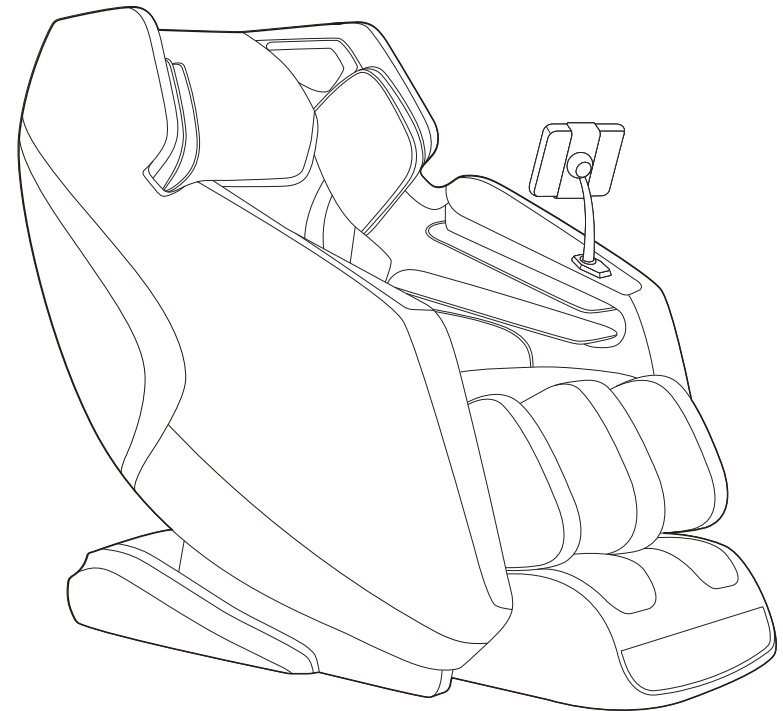
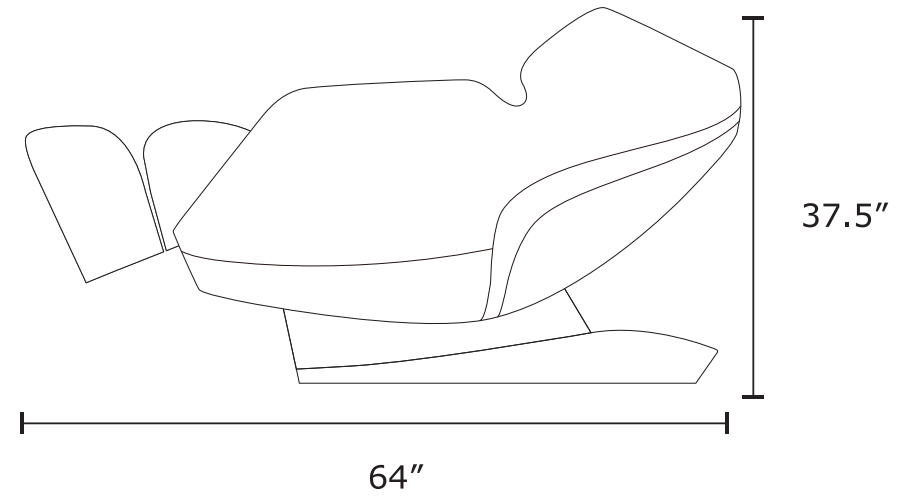
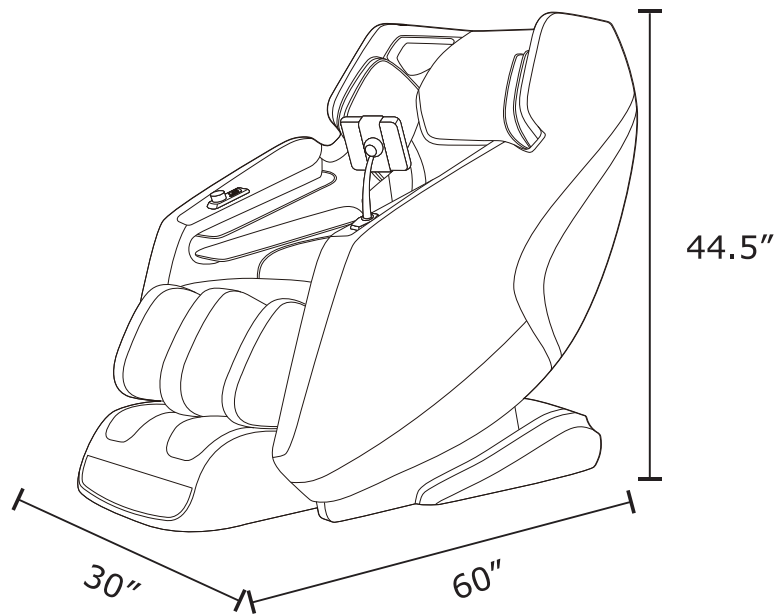



## **Costway Massage Chair Customer Warranty**

Costway products include the following warranty:

This Costway massage chair has a three-year warranty for both parts and labor.

Costway customer service will not issue Return Material Authorizations (RMAs) for products due to buyer's remorse. RMAs will be issued only when product has quality problem. Costway products will be either repaired by the customer or by an in-home technician.

### **Service And Technical Support:**

Customers can contact Costway's customer service department at 213-401-2666 at any time Monday through Friday or via email at [topsupport@costway.com](mailto:topsupport@costway.com) for warranty or service issues.

Customers are required to provide dated proof of purchase (sales receipt) when they contact Costway service department regarding a repair.



A Costway customer service representative will attend to most customer inquiries, however, in some cases, when necessary, a technical service specialist will provide advanced support.

Non-warranty repair is provided on a "per incident" basis. Costway customer service will verify that the unit has failed and provide instructions for repairing a unit. All applicable repairs, parts, shipping, handling, local tax, and a "per incident" fee will be charged for non-warranty repairs.

You can visit [www.costway.com](http://www.costway.com) and [www.costway.ca](http://www.costway.ca) for the latest terms and pricing depending on the type of issue or incident.

Proof of purchase (sales receipt) is required for all warranty repairs or service.

## **Extended Warranties:**

Costway offers extended warranty programs to enhance ownership of Costway products.

Extended warranty provides: A maximum 2-year limited repair or



replacement massage chair warranty with on-site service in certain areas.

Please visit [www.costway.com](http://www.costway.com) and [www.costway.ca](http://www.costway.ca) for the latest terms for extended warranties.

## **Product Repairs**

Many Costway product repairs may be performed by the customer in their own home with parts and instructions supplied by Costway, such as remote controller replacements that don't require a technician.

Customers may contact Costway's customer service department at [topsupport@costway.com](mailto:topsupport@costway.com) for warranty or service issues.

Floor Models and Demonstration Units have a prorated warranty period that begins the day the model is placed on the floor and connected to an electrical outlet by the retail partner. Proof of purchase (sales receipt) is required in order to obtain warranty service and parts. Non-warranty parts and service are available at a "per incident" rate.

Warranty Coverage Period: Warranty coverage begins on the date of customer purchase. Proof of purchase (sales receipt) is required for all



warranty repairs. The warranty period is measured by continuous calendar days based on a seven-day week.

**Field Service:** The Costway customer service department will diagnose the problem and schedule an authorized service provider to repair a chair in the customer's residence. If the area is not covered by Costway official or authorized service provider, after the Costway service team diagnose the problem and provide approval, customers may find their own qualified technician. Customers will be reimbursement once an invoice and proof of the technician's qualifications are submitted to the Costway customer service department. The value of reimbursement should not exceed the cost of a Costway official or authorized service provider.

**Parts:** All parts deemed necessary for repairs will be shipped to the customer at no charge.

## **CUSTOMER WARRANTY LIMITATIONS AND EXCLUSIONS**

Warranties are not valid in certain areas. Invalid areas in Canada: NT, NU, YT.





Postcodes start with AOK, AOP, AOR, A2V, GOG, G4T, JOM, ROB, TOP, TOV, VOT, VOL, VOV, VOW, X0A, X0B, X0C, X0G, X0E, X1A, Y0A, Y0B, Y1A.

Invalid areas in US: Alaska, Hawaii, Puerto Rico, and Guam.

The warranty only applies to Costway products and does not include any accessories or enhancements.

Field service requires pre-approval and must be performed by qualified technicians. Costway official and authorized field service is only available in certain areas. Please visit [www.costway.com](http://www.costway.com) and [www.costway.ca](http://www.costway.ca) for the latest information regarding authorized field service.

Softening of foams and filling composites in pillows, pads, and memory foam occurs naturally and does not constitute a defect under this warranty.

Fading, wear, and piling of fabrics occurs naturally and does not constitute a defect under this warranty.

Natural markings, grain, and dye variations in leather do not constitute a defect under this warranty.



Warranties do not cover any loss or damage resulting from improper installation, unauthorized repairs or modifications, improper use of electrical/power supply, loss of power, dropped products, a malfunction of or damage to an operating part from failure to provide manufacturer's recommended maintenance, transportation damage, theft, abuse, misuse, neglect, vandalism, or environmental conditions (fire, floods, rust, corrosion, sand, dirt, windstorms, hail, earthquakes, or exposure to other weather conditions), loss of use during the period the product is at a repair facility, or otherwise awaiting parts or repair.

Damage due to shipping and handling does not constitute a defect under this warranty.

Under no circumstance shall Costway or its representatives be liable for indirect, consequential, or incidental damages (including damages for lost profits, business interruption, bodily injury, medical harm, and the like), even if any party has been advised of the possibility of such damages.

Warranties are non-transferable and shall be in lieu of any other warranty, express or implied, including but not limited to any implied



warranty or merchant ability or fitness for particular use.

Costway's sole liability and the purchaser's exclusive right shall be for the repair, or at Costway's option, for the replacement of defective part.

Notwithstanding the above, if replacements parts for defective materials are not available, Costway reserves the right to make substitutions in lieu of repair or replacement.

All warranties begin on the date of purchase; no allowance or extension is offered for delivery and/or installation.

Warranties do not apply to rental, business, commercial, institutional, or other non-residential users.

## **Extended Warranty**

LIMITED REPAIR OR REPLACEMENT MASSAGE CHAIR WARRANTY WITH  
ON-SITE SERVICE

If you have a warranty or product question, please contact Costway's support team at 213-401-2666 at any time Monday through Friday, or via email at [topsupport@costway.com](mailto:topsupport@costway.com).



In the event you detect and report a defect in the workmanship or material of the Equipment, during the Service Period, then the Administrator shall provide the services hereinafter described.

Your purchase of the Extended Warranty shall constitute your acceptance to the terms of this Limited Warranty including the indemnification provisions.

1) DEFINITIONS - For the purpose of this Limited Warranty, the following terms shall have the following meanings:

- (1) "Equipment" shall mean a Costway product or system;
- (2) "Customer" shall mean only the residential end-user of the Equipment who is the original purchaser of the equipment from the Distributor, from an authorized reseller.
- (3) Usages of "you" or "your" refer to the Customer;
- (4) "Commencement Date" shall mean the date on which the Equipment is first purchased by a Customer from the Distributor or from an authorized reseller;
- (5) "Service Period" shall mean the period commencing on the Commencement Date;



(6) "Administrator" shall mean Costway. Usage of "we," "us," or "our" shall mean the Administrator. You may contact the Administrator if you have questions regarding this coverage. We can be reached by phone at 213-401-2666.

2) COVERAGE - During the Service Period, we will repair or replace, at our sole discretion, any defective Equipment. We will return the Equipment to a properly functioning state. To obtain such service, you must be able to provide us with the original, dated proof of purchase (sales receipt) for the Equipment. This Limited Warranty extends only to Customers. Only our representatives may perform repairs on the Equipment under this Limited Warranty. Replaced parts shall be covered under this Limited Warranty for the remainder of the Service Period or for thirty (30) days, whichever is longer. We will provide on-site service as necessary on regular workdays. Submission of the Extended Warranty Card form is not a condition precedent to obtaining service under this Limited Warranty. If a particular replacement part is not available from the manufacturer, we will make reasonable efforts to locate a compatible replacement part. If we are unable to locate a compatible part, we may replace your Equipment with a similar product. Under no circumstances



shall the retail replacement value exceed the original net price paid for the Equipment. In the event you choose not to accept a replacement for your Equipment, we shall no longer be responsible for making repairs under this Limited Warranty.

3) EXCLUSIONS - This Limited Warranty does not include service needed on Equipment as a result of any of the following:

- (1) Installation, set-up, moving, or relocation from the originally installed location;
- (2) Cosmetic changes, tears, or failure of fabrics, woods, foam, pads, plastics, upholsteries, exterior coverings, and damages and changes resulting from normal wear and tear;
- (3) Negligence, misuse, abuse, improper maintenance, electrical disturbances and power surges, acts of nature, or work, attachments, additions, alterations, or modifications by persons other than authorized Administrator service providers;
- (4) Failure by the Customer to use a high-quality surge protector during the entire Service Period; (5) Improper operating environments;



- (6) Any problem not involving a defect;
- (7) Damage or malfunction whatsoever caused by an animal or pet;
- (8) Damage or malfunction whatsoever caused by liquids of any kind;
- (9) Rental, business, commercial, institutional, or other non-residential use;
- (10) Unnecessary service requirement. If no problem is found upon diagnosis by us or any other third party, you may be charged our standard rate for shipping costs and parts;
- (11) Dropped products or components (including remote controls);
- (12) Use of any item with the Equipment that is not designated for use with the Equipment; and
- (13) Field service requires pre-approval and must be performed by Costway's authorized field service personnel. Field service is only available in certain areas. Please visit [www.costway.com](http://www.costway.com) and [www.costway.ca](http://www.costway.ca) for the latest information regarding field service.

4) YOUR RESPONSIBILITIES - You shall:

- (1) Operate the Equipment in an environment meeting the



requirements delineated in the Equipment's owner manual and other provided instructions;

(2) Protect the supply of electricity to the Equipment through the use a high-quality surge protection device;

(3) Permit no work on the Equipment except by our authorized service providers;

(4) Have an adult representative present whenever we provide support services;

(5) Perform telephone or email diagnostic procedures as requested by us;

(6) Safeguard and return (at our expense) all replacement parts shipped to you. Either the part to be replaced or the replacement part or item shipped to you must be returned to the Distributor upon request.

5) EXCULPATION AND INDEMNIFICATION - Our maximum liability under this Limited Warranty is limited to the cost of repairing or replacing defective Equipment. We shall not be liable to you for incidental and





consequential damages. Under no circumstances shall you or anyone else ever be deemed to be a third-party beneficiary of the agreement. We shall not be liable for, and you hereby indemnify and hold us and every authorized service provider innocent from, any and all loss, damage, claim, or cause of action, direct or indirect, incidental or consequential, occurring to you, or to the employees or agents of you, or to any other third party, or to the property of any of the foregoing, which may arise as a result of any defect covered by this Limited Warranty or as a result of any service performed under this Limited Warranty.

Exclusions:

- Any malfunction that is caused by circumstance beyond Costway's control.
- Damage or malfunction resulting from misuse or abuse including, but not limited to, damage from liquids of any kind, transit, shipping, relocation damage, incorrect voltage, operation contrary to what is detailed in the Owner's Manual, modification or repair by the user, use by anyone (whether the product is open or stowed) over weight capacity, or any use by more than one person at a time, outdoor usage, and any flood, fire, or other Acts of God.
- Normal wear and tear and all cosmetic damage to fabric or other exterior parts of the chair.



- Under no circumstances whatsoever shall Costway be liable for special, incidental, or consequential damages.
- Rental, business, commercial, institutional, or other non-residential use