

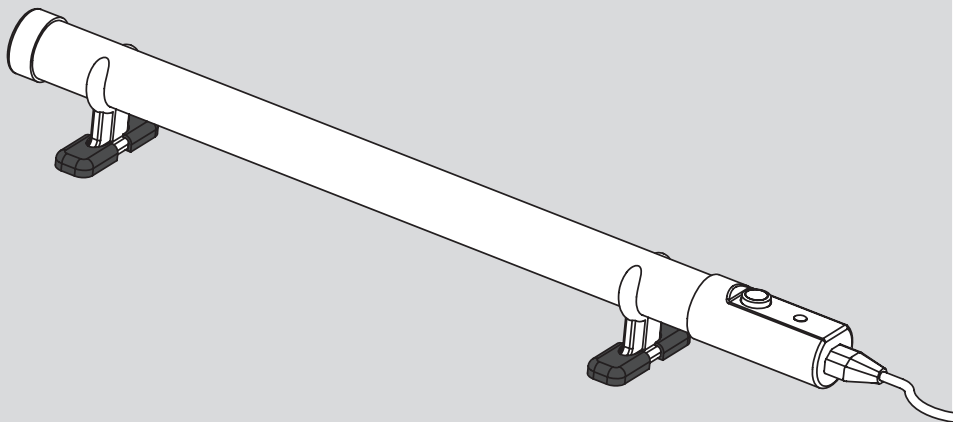

# SLIMLINE GREENHOUSE & SHED HEATER

WITH BUILT-IN THERMOSTAT



Assembly & Fitting Instructions

**hylite**

English

## Assembly & Fitting Instructions

### IMPORTANT SAFETY INSTRUCTIONS

PLEASE READ THESE INSTRUCTIONS CAREFULLY BEFORE ATTEMPTING TO INSTALL AND OPERATE THIS HEATER

### IMPORTANT SAFETY ADVICE

- ⚠️ WHILST MEETING THE REQUIREMENTS OF BS:EN90335-2-30, THE SURFACE OF THIS TUBULAR HEATER CAN STILL GET HOT. IT IS THEREFORE RECOMMENDED THAT THE AGED, INFIRM, CHILDREN AND ANIMALS ARE NOT LEFT UNSUPERVISED IN THE VICINITY OF THE HEATER UNLESS A SUITABLE GUARD IS FITTED.
- ⚠️ DUE TO THE HIGH SURFACE TEMPERATURES, IT IS ESSENTIAL THAT COMBUSTIBLE OR FLAMMABLE OBJECTS SUCH AS FABRICS OR CLOTHING DO NOT COME INTO CONTACT WITH THE HEATER.
- ⚠️ IF A TUBULAR HEATER IS TO BE INSTALLED IN A PLACE USED BY THE PUBLIC A WARNING NOTE SHOULD BE PLACED ADJACENT TO THE HEATER ADVISING THAT THE SURFACE IS HOT.
- ⚠️ ENSURE THE POWER CORD IS PUSHED FULLY INTO THE POWER SOCKET IN THE HEATER WHEN IN OPERATION. IF THE CORD IS DAMAGED DISCONTINUE USING THE PRODUCT AND CONTACT THE MANUFACTURER FOR FURTHER INSTRUCTIONS.
- ⚠️ ALWAYS SWITCH THE HEATER OFF AT THE MAINS WHEN NOT IN USE AND ENSURE THE POWER CORD IS NOT IN CONTACT WITH THE SURFACE OF THE HEATER.
- ⚠️ THE HEATER MUST ALWAYS BE POSITIONED HORIZONTALLY USING THE MOUNTING BRACKETS SUPPLIED AND ALLOWING FREE MOVEMENT OF AIR AROUND THE HEATER. DO NOT COVER THE HEATER AS THIS MAY CAUSE OVERHEATING.
- ⚠️ THE HEATER IS WATER RESISTANT (IP44 RATED) AND IS SUITABLE FOR USE IN LOFTS, GARAGES, UTILITY ROOMS, AIRING CUPBOARDS, SHEDS, DISPLAY WINDOWS ETC. HOWEVER IT IS NOT WATERPROOF AND SHOULD NOT BE USED IN ENVIRONMENTS WHERE CONTINUOUS OR EXCESSIVE WATER-SPRAYING MAY OCCUR.
- ⚠️ DO NOT USE THE HEATER IN BATHROOMS, SHOWERS OR SWIMMING POOLS.
- ⚠️ WHEN USING THE HEATER IN AN AREA WHERE IT MAY COME INTO CONTACT WITH WATER, AND TO ENSURE IT'S IP44 RATING IS MAINTAINED - ALWAYS ENSURE THAT THE POWER CABLE HAS THE BLACK FOAM GASKET IN PLACE ON THE CONNECTOR END BEFORE PLUGGING IT INTO THE SLIMLINE HEATER [FIG.1]

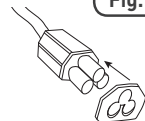

Fig.1

### 1. INSTALLING THE SLIMLINE ECOHEATER

**IMPORTANT:** The heater should only be operated in the horizontal plane, using the mounting brackets provided.

- Dimensions of the heaters are shown in [Fig.2].

Wattage	A
55	500mm
90	750mm
120	1000mm
190	1500mm

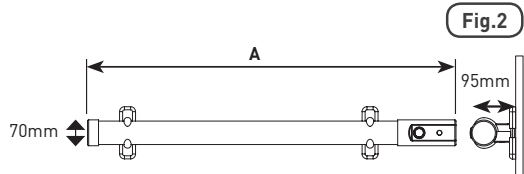

Fig.2

- Before installing the heater it is recommended that the power cable is attached by pushing it fully into the heaters power cable socket [Fig.3].

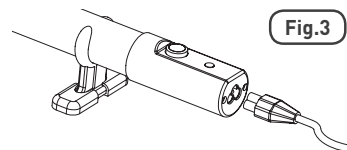

Fig.3

**IF FITTING TO A WALL**

- Follow minimum clearances below and above the heater as shown in [Fig.4].
- Once a suitable location has been found, screw the two bottom halves of the bracket to the wall (Fig.5).
- Place the Eco Heater on the brackets and then fasten top part of the brackets over tube to secure.

DO NOT SWITCH ON THE HEATER UNTIL IT IS SECURED.

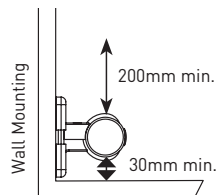

Fig.4

**FIXING TO A FLOOR OR OPERATING THE HEATER FREESTANDING**

- Follow the minimum clearances around the heater as shown in [Fig.6].
- If operating as a freestanding heater, fix brackets along the length of the heater to adequately support the unit and ensure it is stable.
- Attach rubber boots to the feet of the bracket [Fig.7] to increase stability.

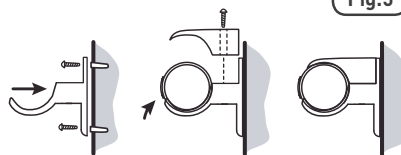

Fig.5

**INSTALLING MORE THAN ONE HEATER**

- Minimum clearances as shown in [Fig.8] must be observed when the heater is in use.

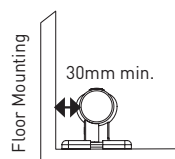

Fig.6

**2. OPERATION**

- Ensure the power cable is pushed fully into the heaters power socket before switching power on.
- Turn the thermostat knob in a clockwise direction until it reaches the maximum setting [Fig.9].
- When the room has reached the desired temperature, turn the thermostat knob in an anti-clockwise direction just until the appliance switches off (amber yellow light goes out) and not beyond.
- The temperature will then be regulated and kept at a constant level by the thermostat.
- The heater is fitted with a safety device which will switch off the heater in case of accidental overheating (please see safety notes).
- To reset, disconnect the heater from the power source for a few minutes to allow the unit to cool down.
- Make sure that any causes of overheating, such as obstructions, are removed and plug the appliance in again.
- DO NOT DIRECTLY EXPOSE TO WATER

PLEASE NOTE: When the heater is switched on for the first time, small wisps of smoke may drift from the heater. This is a perfectly normal part of the first time operating procedure and should cease after the heater has been operating for approximately 5 minutes

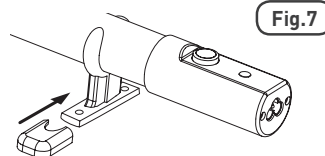

Fig.7

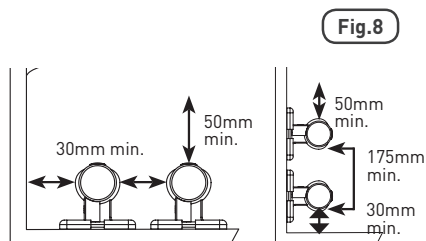

Fig.8

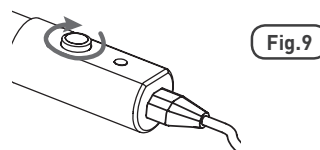

Fig.9

## English

Hylite tries to improve its products for the benefit of its customers. For this reason we reserve the right to make changes to any product at any time without notice.

Please note that this equipment and its components have no user serviceable parts. If you experience any difficulties installing this product please call our helpline or write to F4 Enterprises Limited.

**F4 Enterprises Limited**  
7 Abbey Square, Chester  
CH1 2HU, UK  
Tel: +44 (0)1352 736120  
[www.f4enterprises.co.uk](http://www.f4enterprises.co.uk)

---

## Français

Hylite s'évertue à améliorer constamment ses produits pour ses clients. Pour cette raison, nous nous réservons le droit de modifier nos produits à tout moment et sans préavis.

Veuillez noter qu'aucune des pièces de cet appareil ne peut être réparée par l'utilisateur. Si vous rencontrez des difficultés lors de l'installation de ce produit, appelez notre service d'assistance téléphonique ou écrivez à l'adresse suivante:

**F4 Enterprises Limited**  
7 Abbey Square, Chester  
CH1 2HU, UK  
Tel: +44 (0)1352 736120  
[www.f4enterprises.co.uk](http://www.f4enterprises.co.uk)

---

## Deutsch

Hylite versucht, seine Produkte zum Nutzen seiner Kunden zu verbessern. Aus diesem Grund behalten wir uns das Recht vor, jederzeit und ohne Ankündigung Änderungen an unseren Produkten vorzunehmen.

Bitte beachten Sie, dass dieses Gerät und seine Komponenten keine vom Benutzer zu wartenden Teile besitzen. Wenn Sie bei der Installation auf etwaige Probleme mit diesem Produkt stoßen, wenden Sie sich bitte an unsere telefonische Helpline oder schreiben Sie an:

**F4 Enterprises Limited**  
7 Abbey Square, Chester  
CH1 2HU, UK  
Tel: +44 (0)1352 736120  
[www.f4enterprises.co.uk](http://www.f4enterprises.co.uk)