

# MINI GREEN HOUSE

MGHFP

Issue 0118

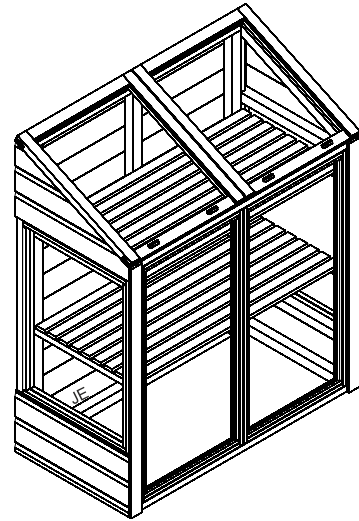
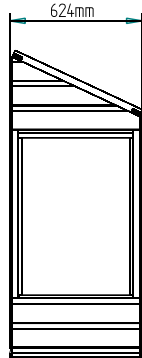
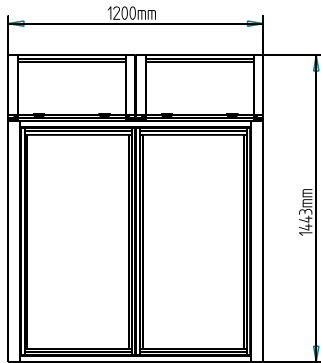

**Important : Assembly of this product requires two people.**



**IMPORTANT, RETAIN FOR FUTURE REFERENCE: READ CAREFULLY**

Thank you for choosing this garden building manufactured by the UK's largest manufacturer of timber garden products. In order to gain the most benefit from it, please note the following:

- If there are any technical queries with the product, please contact our customer help line on **0333 7777 089** between the hours of 8.30 am and 5.00 pm Monday to Friday.
- Timber is a natural material. It will shrink and swell as a result of varying moisture content.
- This product is pressure treated to ensure the longevity of all timber components and protect against rot. This may leave a colour difference on some parts that will even out as the moisture content stabilises.
- In line with your statutory rights, please check all parts prior to assembly, as assembly of damaged parts may be deemed to be acceptance and this may affect the remedies you are entitled to. If the product is not constructed in accordance with the instructions, or is altered in anyway (eg painted), the manufacturer cannot be held liable for any resulting damage.
- Please keep all plastic bags and small parts away from children in order to reduce the risk of suffocation.
- Make sure that you are building this product on a firm level base.
- This product is for DOMESTIC USE ONLY. Please keep these instructions for future reference.

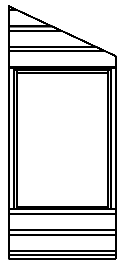

**MGCLSPTR**  
Left Hand Side  
QTY 1

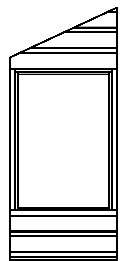

**MGRSPTR**  
Right Hand Side  
QTY 1

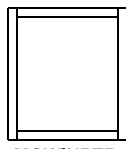

**MGWINPTR**  
Window  
QTY 2

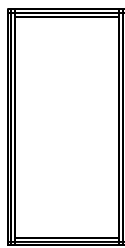

**MGHDRPTR**  
Door  
QTY 2

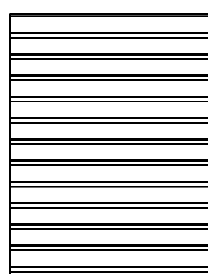

**MGHBPTR**  
Back Panel  
QTY 1

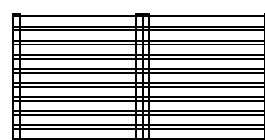

**MGHSLF**  
Shelf  
QTY 2



**Pw54260602**  
Window Glazing  
QTY 2

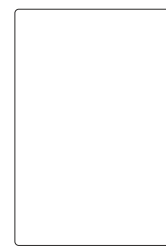

**Pw7795402**  
Side Panel Glazing  
QTY 2

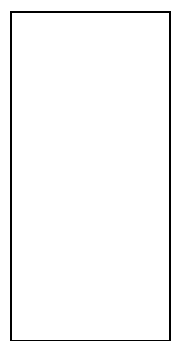

**Pw475100802**  
Door Glazing  
QTY 2

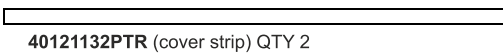

**40121132PTR** (cover strip) QTY 2

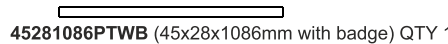

**45281086PTWB** (45x28x1086mm with badge) QTY 1

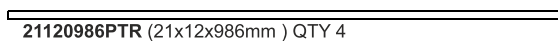

**21120986PTR** (21x12x986mm) QTY 4

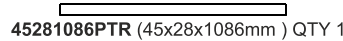

**45281086PTR** (45x28x1086mm) QTY 1

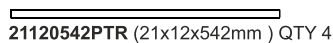

**21120542PTR** (21x12x542mm) QTY 4

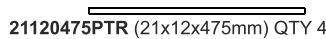

**21120475PTR** (21x12x475mm) QTY 4

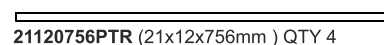

**21120756PTR** (21x12x756mm) QTY 4

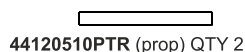

**44120510PTR** (prop) QTY 2

**MGHFP (FIXING PACK)**

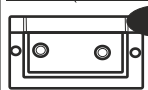

2" Flush hinge

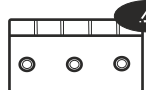

3" Butt hinge

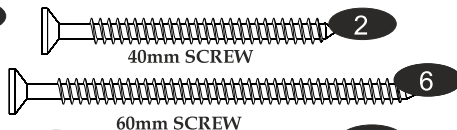

40mm SCREW

60mm SCREW

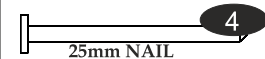

25mm NAIL



Corner Brace

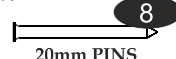

20mm PINS

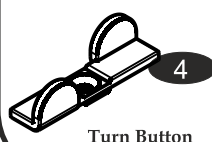

Turn Button

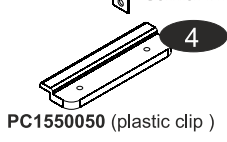

PC1550050 (plastic clip)

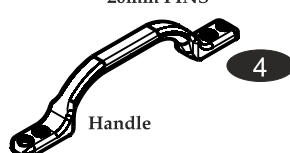

Handle

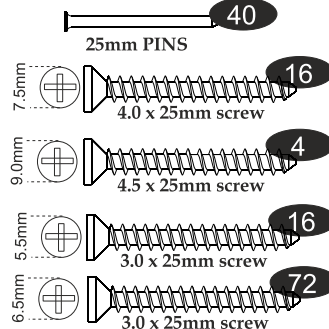

25mm PINS

4.0 x 25mm screw

4.5 x 25mm screw

3.0 x 25mm screw

3.0 x 25mm screw

**REQUIRED TOOLS : (NOT SUPPLIED)**



POZI DRIVE SCREWDRIVER



DRILL



HAMMER

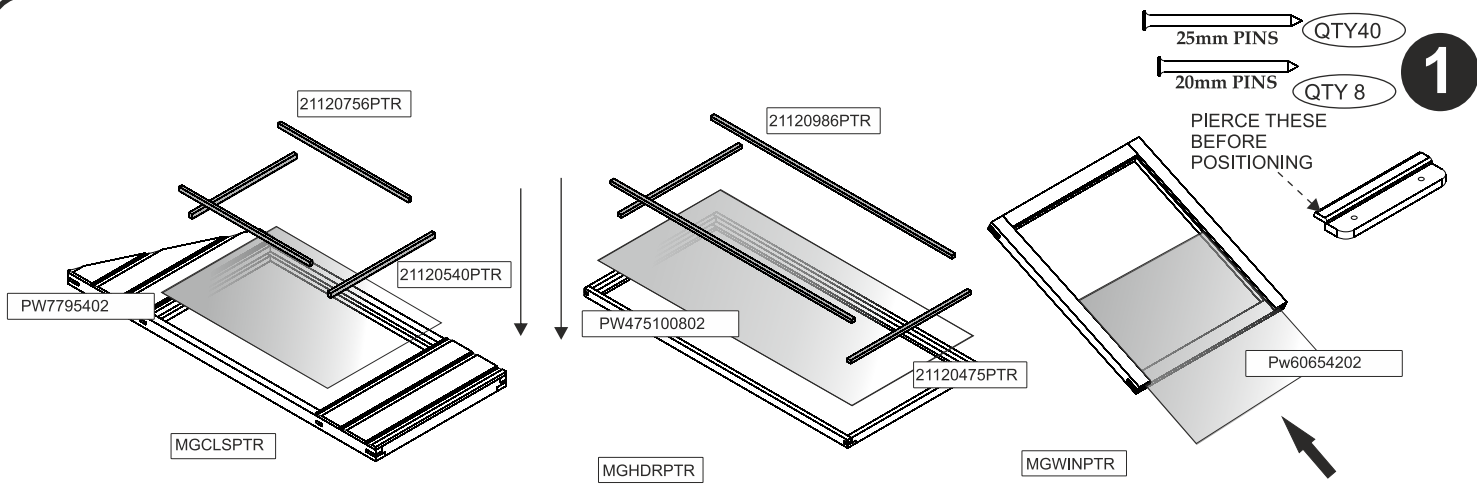

Place the side panels on the floor and slot the side panel glazing into the recess so it sits flush. Place the beading (21x12x540mm) tight against the top and bottom of the recess. Next position the (21x12x756mm) pieces on either side. Secure each beading in place using 3 panel pins for the sides and 2 for the top and bottom.

Place the door on the floor and slot the door glazing into the recess so it sits flush. Place the beading (21x12x475mm) tight against the top and bottom of the recess. Next position the (15x12x986mm) pieces on either side. Secure the 986mm beading in place using 3 panel pins in place using 3 panel pins and 2 panel pins for the 475mm beading.

Slide the window glazing into the recesses in the window so that it is tight against the top. Position two of the plastic clips at the bottom of the glazing to stop it from sliding out. Secure each clip in place using the 20mm panel pins for each.

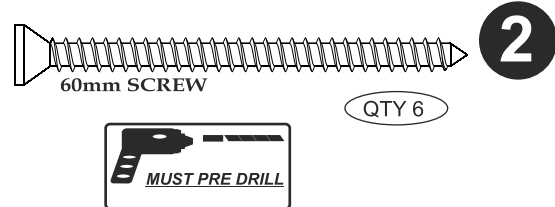
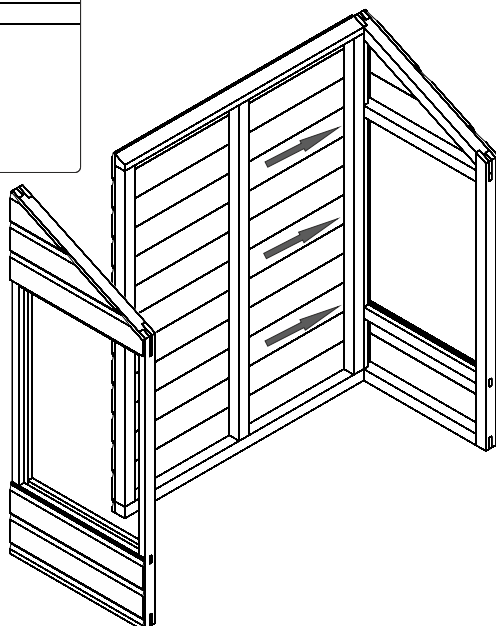
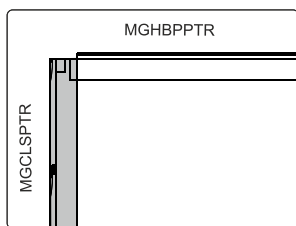

Fix the left and right hand side panels to the back panel as shown using 3x60mm screws for each, screwing through the back panel frame work into the side panel.

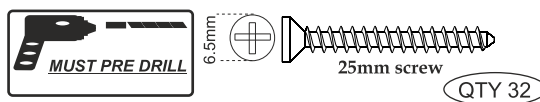
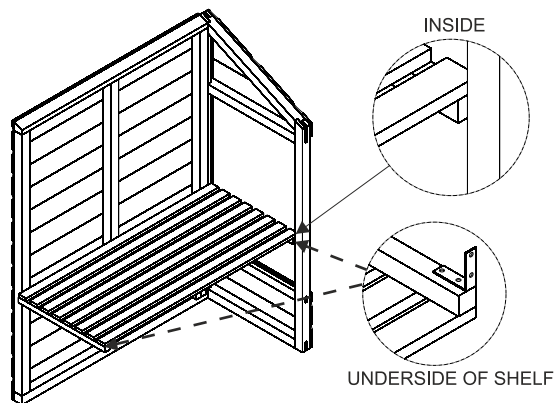

3

Place four of the corner braces on the underside of each shelf on both of the end battens as pictured. Secure each in place with 2 x 25mm screw.

Mark the desired height of the shelf on the inside of the framework. Secure the shelf in position by securing each brace to the frame using 2x25mm screw for each brace.

Repeat the step for the second shelf.

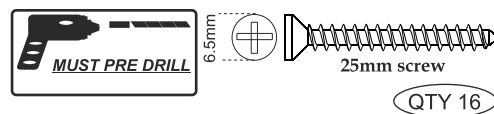
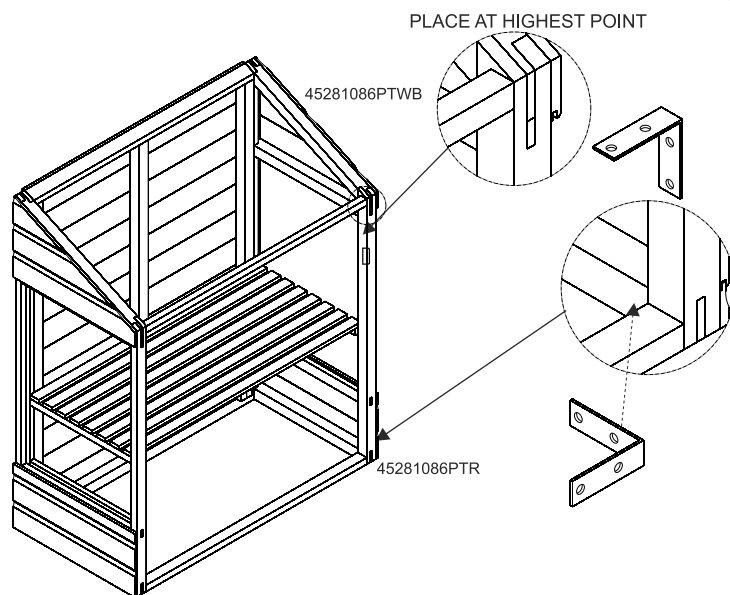

4

In the same manner as the previous step, fix the corner braces to the battens. Secure the 45x28x1086mm (with Badge) batten at the top and inside of each of the side panels as illustrated.

Repeat for the 45x28x1086mm batten at the bottom.

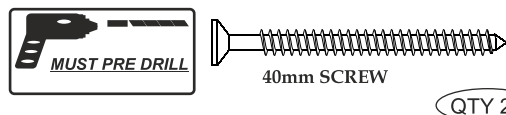
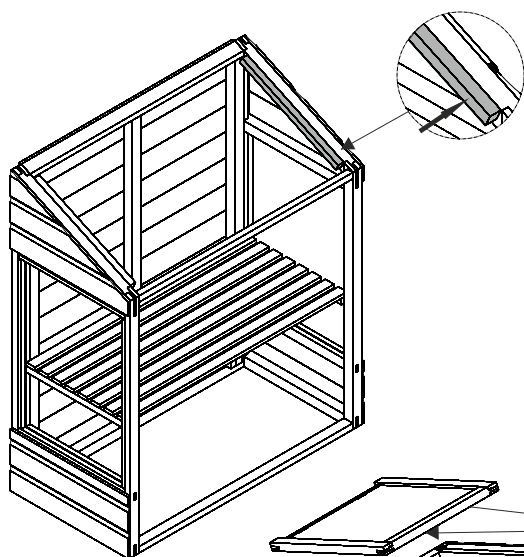

5

Place a prop on the inside of each side panel as shown. Secure at one end using a 40mm screw. Make sure the prop can pivot.

PRE-DRILL

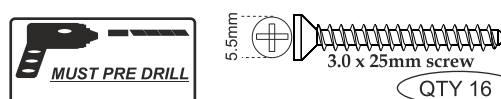
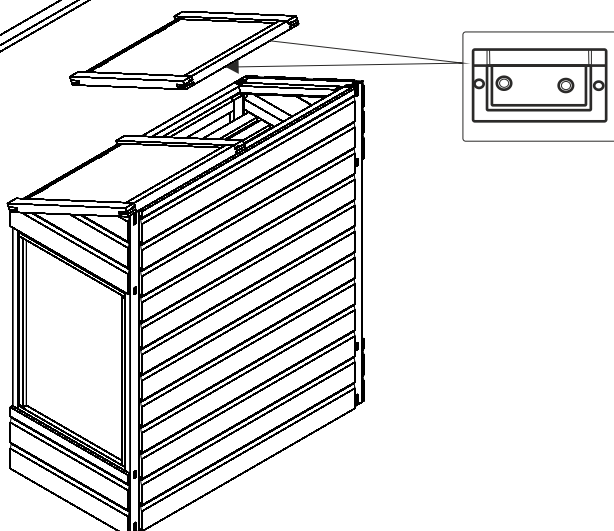

6

Fix two flush hinges to each of the windows, equally spaced, using 2x25mm screws for each hinge. Fix the inner part of the hinge to the window

Then secure the windows to the rest of the assembly as shown using a further 2x25mm screws per hinge

Fix two Butt hinges to each of the doors, equally spaced, using 3x25mm screws for each hinge. The barrel of the hinge must sit proud of the front of the door.

Then secure the doors to the rest of the assembly as shown using a further 3x25mm screws per hinge

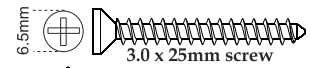

**7**

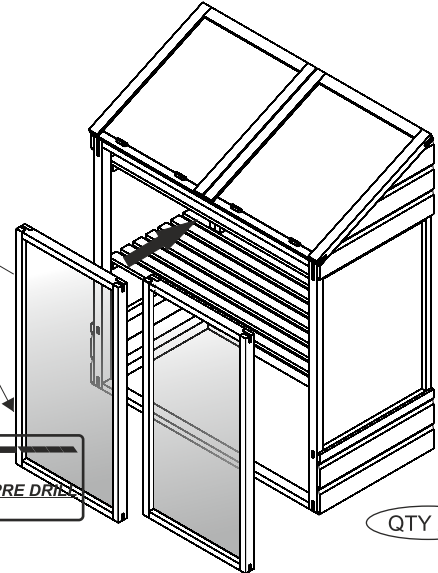
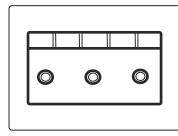

QTY 24

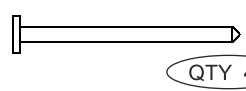
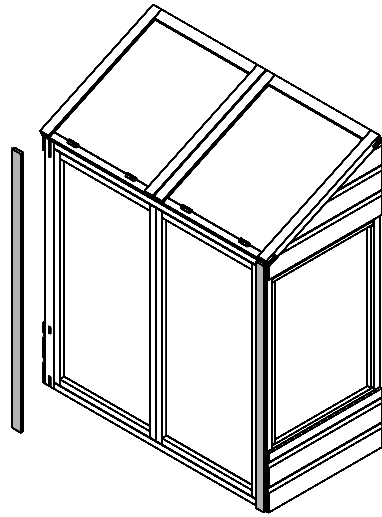

**8**

Fix the two cover strips to the front of the product so that it is flush with the sides. Secure in position by using 2x25mm nails for each board.

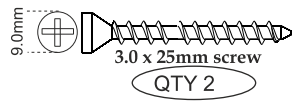

**9**

Fix a turn button on the inside and at the top and bottom of the one of the doors using a 25mm screw for each.

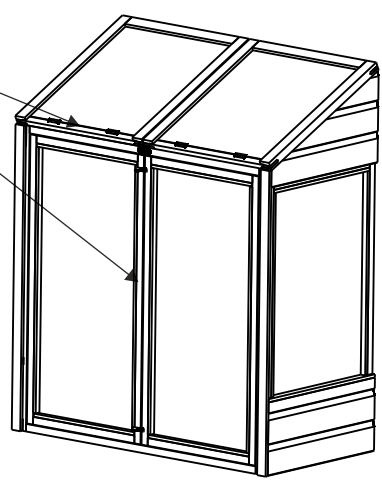
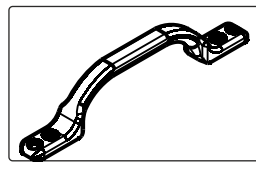
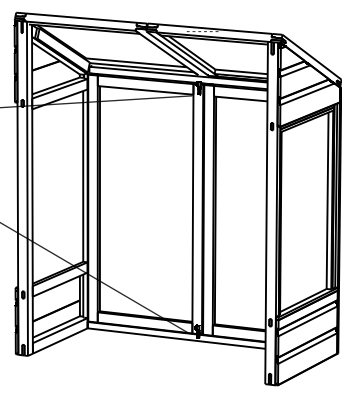
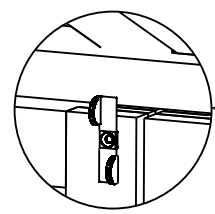

Place a handle on the front and centre of each window, and the centre of each door. Secure in position using the 4.0 x 25mm screws provided.

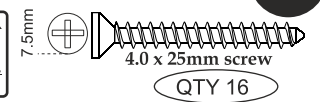

**10**

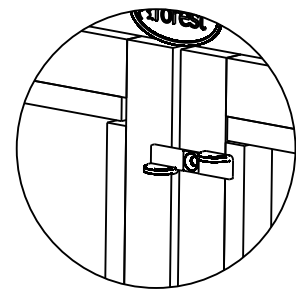
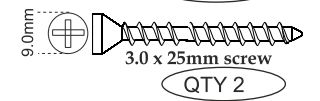

Fix the turn buttons to the top and bottom of the closed door using a 3.0 x 25mm screw for each. Make sure that they turn to keep the door shut.