

ROUND PICNIC TABLE BACKS

Issue 0117

IMPORTANT, RETAIN FOR FUTURE REFERENCE: READ CAREFULLY.

Check all parts are present prior to assembly.

- Always pre-drill timber to avoid splitting.
- The timber in this product is pressure treated to ensure longevity and protection against rot. This may leave a colour variations, but these will even out as the moisture content stabilises.
- Timber is a natural material and will shrink and swell as a result of varying moisture content.
- Place on solid level ground.
- Keep all plastic bags and parts away from children.

Technical Help line: 0333 321 3142 8:30am - 5.00pm Monday to Friday

In line with your statutory rights, please check all parts prior to assembly, as assembly of damaged parts may be deemed to be acceptance and this may affect the remedies you are entitled to. If the product is not constructed in accordance with the instructions, or is altered in anyway (e.g. painted), the manufacturer cannot be held liable for any resulting damage.

This article contains biocidal products to give protection against wood destroying insects & wood rotting fungi.

Contents may vary.

May contain : Basic copper carbonate (Copper (II) carbonate – Copper (II) hydroxide (1:1), Cupric oxide, Copper hydroxide carbonate, oxyethyl, ammoniumpropionate, Copper HDO, Propiconazole, Tebuconazole, Boric acid, Benzalkonium chloride.

Wear gloves when handling freshly treated wood. Avoid breathing dust when cutting treated or untreated wood.

Dispose of off-cuts responsibly – do not burn.

Required Tools (not supplied)

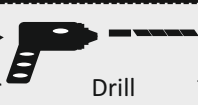
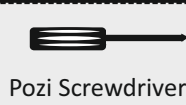
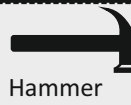





Hammer

Pozi Screwdriver

Drill

Tape Measure

Parts List

| | | |
|---|---|-----------------------|
| a |  | 40400220PPT qty 8 |
| b |  | 40301136PSPT qty 4 |
| c |  2 x rounded edges | 40401136PSTBPT qty 8 |
| d |  | 90400830PAI75PT qty 8 |

Fixing Pack (CPTSFBP)

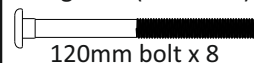

120mm bolt x 8

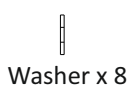

Washer x 8



Nut x 8

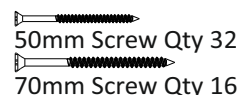

50mm Screw Qty 32



70mm Screw Qty 16



Assembly of this product requires a minimum of two adults!

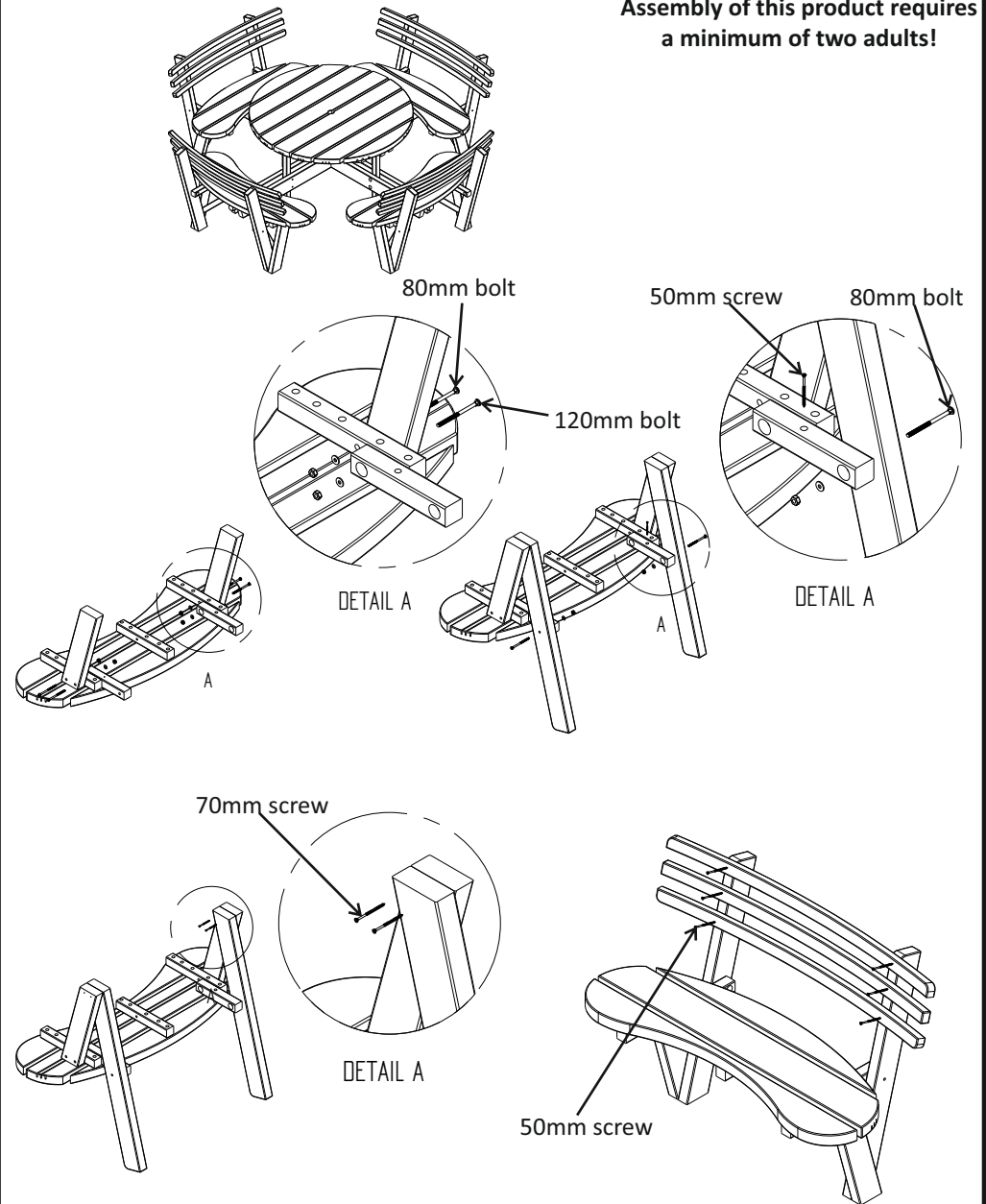

IMPORTANT NOTICE : PERIODICALLY CHECK ALL FIXINGS FOR

Forest Garden Ltd, Units 288 Hartlebury Trading Estate, Hartlebury, Worcestershire, Dy10 4JB