

**COMMERCIAL BENCHING TWO TIER 18' - 28' C6(03)**  
Assembly Instructions



**MODEL:** \_\_\_\_\_ **Long** \_\_\_\_\_ **Wide**

**COMPONENTS**

COMPONENTS		LENGTH OF BENCH						
HORIZONTAL FRAME	COMPONENT LENGTH	18'	20'	22'	24'	26'	28'	Special
A Width Piece	24" / 32" x 36" x 48"	4	4	4	4	4	4	
B Length Piece	24" Single Mitre	4	--	4	--	4	--	
B1 Length Piece	48" Single Mitre	4	8	4	8	4	8	
B2 Length Piece	48" No Mitre	12	12	16	16	20	20	
C Corner Leg	30"	4	4	4	4	4	4	
D Mid Leg	30"	8	8	10	10	12	12	
E Cross piece	22" / 30" / 34" / 46"	16	18	20	22	24	26	
F Cross piece Bracket	2"	16	20	20	24	24	28	
Bolts & Nuts	1/2"	320	352	384	416	448	480	
Panel	2' x 23" / 32" / 36" / 48"	18	20	22	24	26	28	
Panel Support (see 6)	24" (for 32", 36" & 48" wide only)	18	20	22	24	26	28	
Or Slats	24" / 32" / 36" / 48"	108	120	132	144	156	168	

**PLEASE NOTE:** Assemble the whole unit with the bolts and nuts fingertight only. When complete square up and tighten

**CROSS SECTIONS**

1. Please check the components.
2. Bolt the corner legs to width pieces 'A'.
3. The legs are spaced at 4ft intervals except for the end section on 18', 22' & 26' long benches (2' space). Bolt the mid legs to cross pieces 'E'.
4. Bolt on all the horizontal frame length pieces 'B'.
5. Attach the intermediate cross pieces to the horizontal frame using the 2" cross piece bracket
6. Panel supports are supplied for 32", 36" and 48" wide benches. These 24" long 1" x 1" angle pieces should be positioned lengthways down the bench centrally between the cross pieces E and at either end between width piece A and cross piece E.

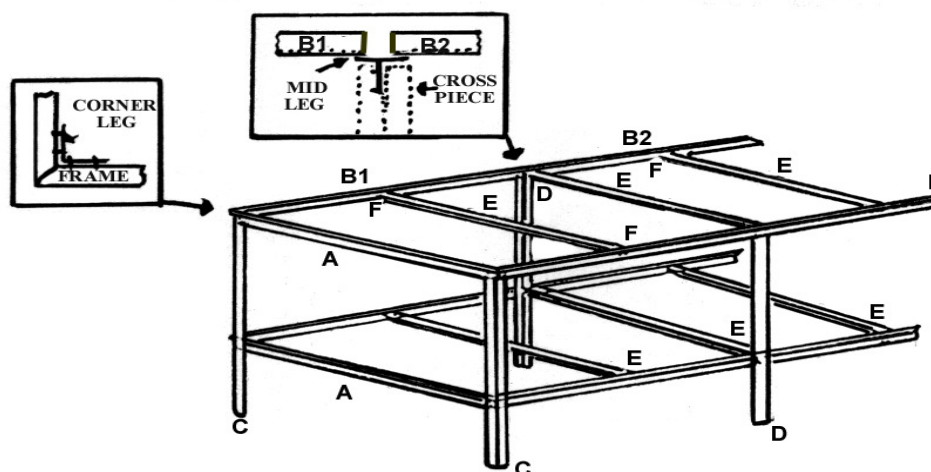
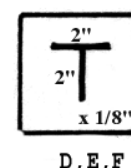
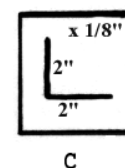
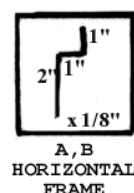

**Long Term Care of Aluminium Benches & Shelves.**

Prolonged contact with chemicals containing metal compounds can cause aluminium to corrode (an electrolytic reaction occurs). Typical of these are Cheshunt Compound and Bordeaux mixture both of which contain copper. All chemicals should list their contents and most are metal free.

When using these metallic chemicals it is best to line any aluminium surface with polythene, if not wash down well after the application. When growing on a capillary bed (sand, gravel or matting) which is not lined with polythene, apply chemicals to plants away from the bed and drain thoroughly before replacing.

**COMMERCIAL BENCH TWO TIER 18' - 28'**

*Layout Instructions*

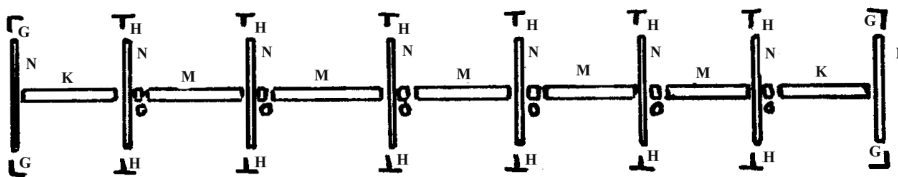
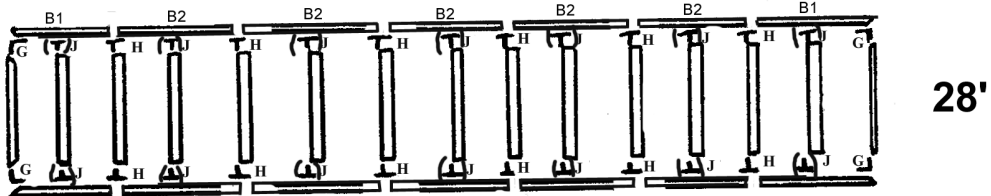
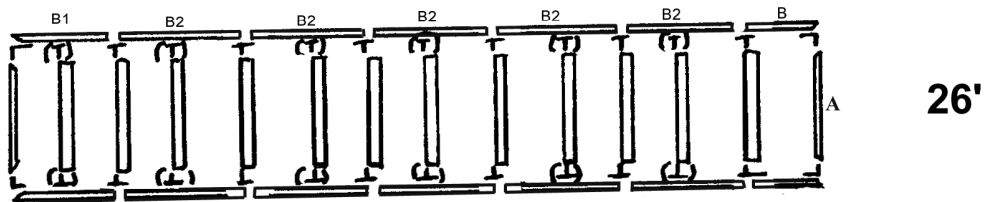
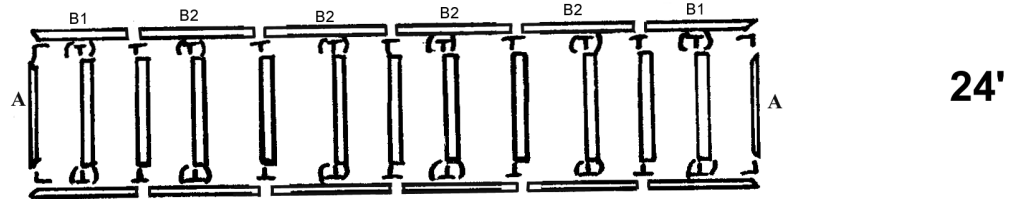
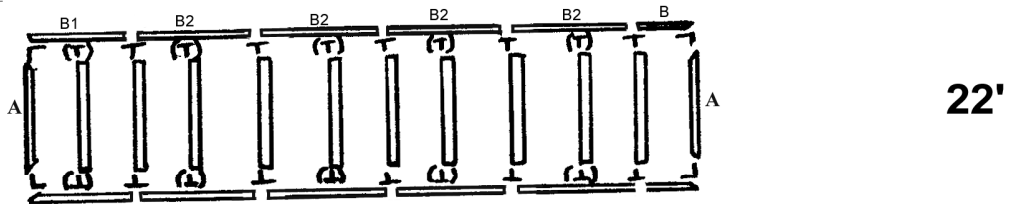
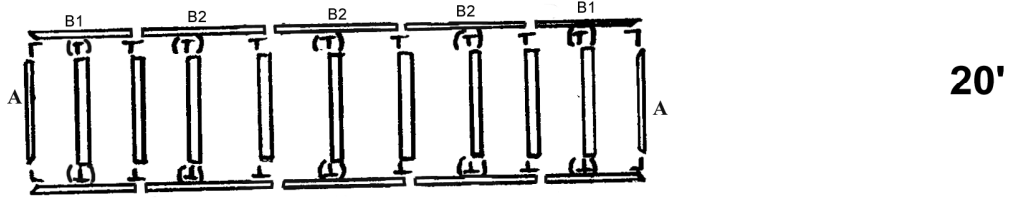
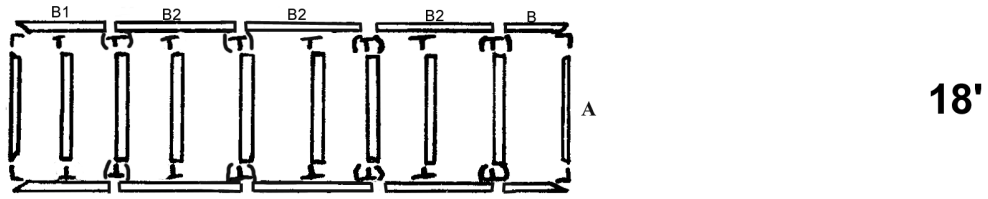

L = CORNER LEG 'G'      T = MID LEG 'H'      (T) = CROSS PIECE BRACKET

TWO WESTS & ELLIOTT LTD

4, Carrwood Road, Chesterfield, Derbyshire, S41 9RH. Tel: (01246) 451077