

SAMSUNG

The impressive new way to impress guests.

RU750 Series SMART Hospitality TVs

These 4K UHD Edge-Lit LED TVs offer outstanding detail and color along with the ability to allow guests to stream content from their personal devices. The RU750 also features Samsung LYNK Cloud for exceptional device management, content management and business intelligence.

samsung.com/hospitality

RU750 Series Hospitality TVs

43"	HG43RU750NFXZA	65"	HG65RU750NFXZA
50"	HG50RU750NFXZA	75"	HG75RU750NFXZA
55"	HG55RU750NFXZA		



Netflix subscription required.

RU750 Series Hospitality TVs

Key Features

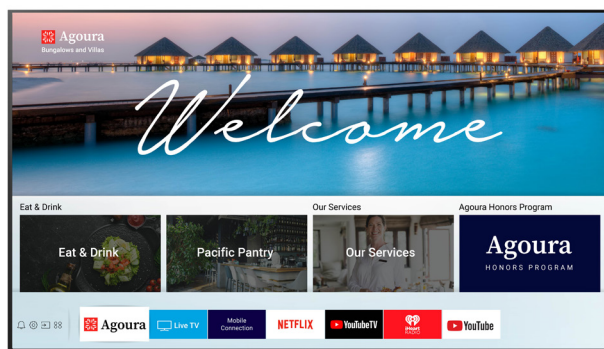

Netflix subscription required.

4K UHD

4K UHD with PurColor for breathtaking color

Deliver the unmatched, luxury experience your guests expect with 3840 x 2160 4K UHD resolution. Offering four times the pixels of Full HD, the RU750 series showcases content in stunning, lifelike detail. PurColor technology concentrates on red, green, and blue color adjustment points, but unlike traditional LED, PurColor also adjusts magenta, yellow and cyan. The result is fine-tuned color of incredible nuance and realism.



For streaming content

Allow your guests to enjoy their own content on the big screen. Guests can connect to their own Netflix account or other streaming services via a third party casting solution, and watch their favorite shows on the gorgeous 4K TV.



Easier, faster control with Home App and Eden UI

The Home app installed on the RU750 allows you to easily incorporate a welcome message, add logos/branding, and provide other useful information such as phone extensions to various guest services. Displayed on the Eden user interface, it's a sleek, fast, simple solution.



HDR10+ picture technology for incredible depth

4K UHD delivers more pixels, and HDR10+ gets the most out of every one. Color is richer. Light and dark scenes are more balanced. Contrast is expanded, for greater picture depth and nuance. Every guest experience with the RU750 series will be an incredible one.



Samsung LYNK Cloud

This web-based management tool offers easier device management, content management and business insight, for more effective promotions. (More detail on the following pages.)



Samsung LYNK DRM HD content decryption

Samsung's software-based DRM technology is integrated into the entire Samsung Hotel TV line. Samsung LYNK offers a robust solution to unlock premium HDTV content from content providers such as cable, satellite and VOD providers, with maximum efficiency and security.



Pro:Idiom HD content decryption

Pro:Idiom MPEG4 technology makes the RU750 series TVs compatible with most major VOD/PPV systems.



A host of features

The cleanly designed stand and cable management system render the RU750 gorgeous from every angle. Other features of the RU750 series include: Home App, RJ12 IR Pass-Through, Front Panel Lock-out, Menu Display Lock-out, Hotel Custom Logo/Welcome Message, Channel List Guide, Channel Re-mapping, USB Cloning and Anti-Theft Battery Cover Remote Control.



Samsung LYNK Cloud gives you seamless device management, content management and business intelligence.

From single boutique hotels to a portfolio of properties, Samsung LYNK Cloud offers a scalable, cloud-based solution for monitoring, managing and maintaining your entire fleet of guestroom TVs.

LYNK Cloud	Standard	Premium	Premium Plus
Device Management	X	X	X
OTT Apps	X	X	X
IPG	X	X	X
Content Management		X	X
Business Intelligence			X

The RU750 is natively compatible with LYNK Cloud, meaning it doesn't require a set-top box to power the system. It's simply plug and play.



Device management

Hotel managers can monitor all devices at all locations, and check errors in real time to quickly resolve any issues and ensure guests enjoy a seamless experience. Samsung LYNK Cloud also allows full access to controls, to allow hotel managers to remotely set volume, adjust configuration settings, and map access to specific channels and broadcasters.

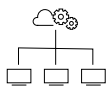

TV configuration

Easily track firmware versions of every connected device and remotely push TV configuration settings when needed.



Virtual control

With the virtual remote control, you can power on/off, reboot, mute, change channel or source or change the volume remotely either immediately or at a scheduled time.



Interactive Program Guide

Configure, maintain or change the interactive program guide in real-time from any location with the web-based portal.

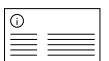

Device info

You can automatically capture info on each connected device, including TV model, serial number, firmware version, IP address, MAC address and location on property.



Device grouping

Easily push updated messaging to groups of devices. For example, a promotion geared to your most exclusive rooms. Or push messages to select properties.

OTT apps

With LYNK Cloud and Property Management System (PMS) integration, guests can access their own content accounts, including Netflix, YouTube, YouTube TV, iHeart Radio and more. In fact, the RU750 series hospitality TV is the only Samsung guestroom TV that's been certified for use by Netflix.

When guests check in, they simply launch the application through the RU750 series menu, log in, and begin streaming their favorite content. They stay logged in for the duration of their visit, and when guests check out, the RU750 automatically deletes their login information.



Apps mentioned here are just a sampling, and are not a complete list. Available apps subject to change.

Interactive Program Guide

LYNK Cloud enables hotels to offer a custom IPG. It's easy to introduce guests to your exclusive content while also offering them a simple way to navigate to your complete content offering. And you can update it any time through the LYNK Cloud portal.

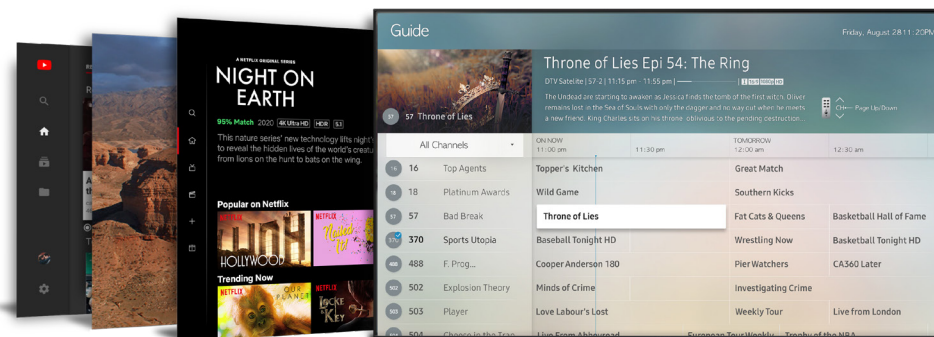

Content management

LYNK Cloud features a powerful yet easy-to-use content management platform. It supports web-based content creation, powerful multimedia hosting of large video and image files, and efficient content deployment across locations. Additionally, in-room TVs can be used to support staff through interactive menu ordering, booking onsite services such as spas and conference rooms, and more.

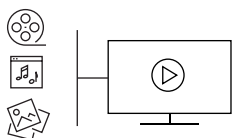

Powerful multimedia hosting

Upload videos, images and GIFs with minimal restrictions on file sizes.

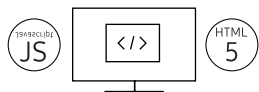

Web-standard content creation tools

Get simplified content framework and templates that support HTML5/Javascript.



Interactive service support

With an Open API platform, you have virtually endless options in incorporating interactive modules for ordering, booking and more.



Business intelligence

By analyzing guest behaviors such as what content they watch on TV, which applications they use and which hotel information they're interested in during their stay, Samsung LYNK Cloud can help managers uncover valuable business insights. Based on these insights, hotels can provide relevant, personalized content to guests, to increase engagement and ultimately revenue.

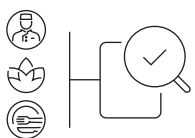

Service usage analysis

Samsung LYNK Cloud also enables users to analyze which services guests engage with most. It's possible to look at how many times a guest views promotional content, which hotel services they use – from in-room dining to the spa – and what purchasing decisions they ultimately make.

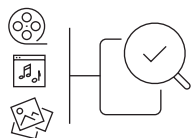

TV and OTT content usage analysis

Samsung LYNK Cloud allows hotel managers to analyze TV and OTT content usage of guests, including channel/OTT, duration and applications, in order to better cater to guest preferences and optimize entertainment content expenses.

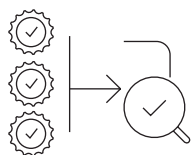

Promotion entry analysis

Samsung LYNK Cloud allows users to analyze the point at which each guest entered to access a specific promotion, whether a notification page, preview page or the hotel application page

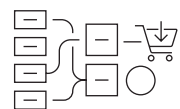

Promotion flow analysis

Samsung LYNK Cloud lets hotel managers analyze the user flow of any promotion. They can gather insights regarding the route through which a guest enters the final purchase page. If an abnormal number of guests exit through any single point, hotel managers can know to change the content or process.

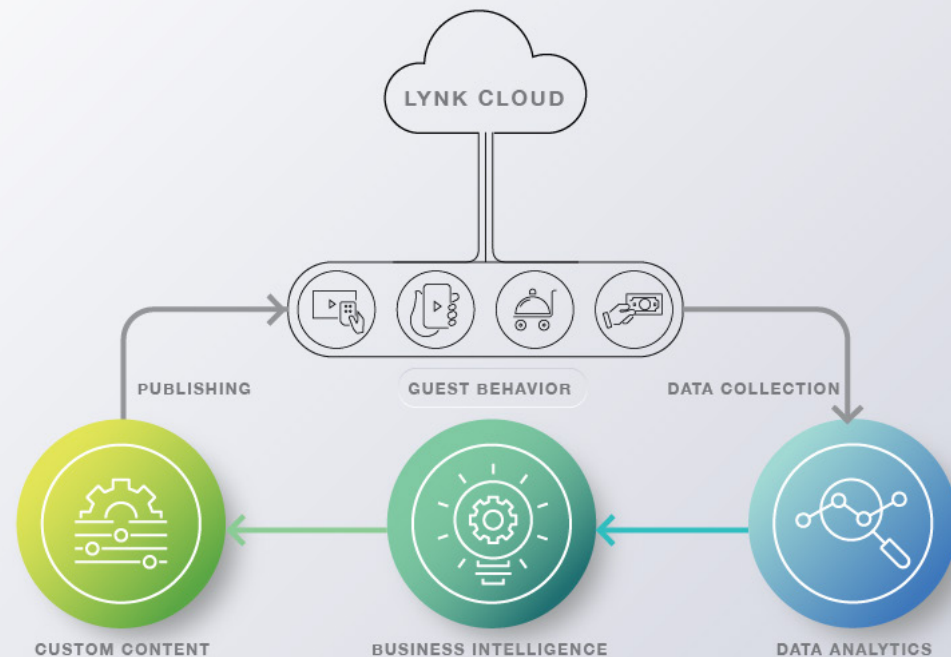

RU750 Series Hospitality TVs

DRM

Digital Rights Management (DRM)

Samsung LYNK DRM HD Content Decryption (RF)

Samsung's software-based DRM technology is integrated into the entire Samsung Hotel TV line. Samsung LYNK offers a robust solution to unlock premium HDTV content from content providers such as cable, satellite and VOD providers, with maximum efficiency and security.



Pro:Idiom DRM HD Content Decryption

The RU750 series is equipped with Pro:Idiom MPEG4 technology, making the TVs compatible with most major VOD/PPV systems. You can offer your guests premium HDTV content from cable, satellite or video-on-demand services with no optional cards or external box needed.

Pro:Idiom™

Glossary

Connections

Anynet + (HDMI – CEC)

This Samsung protocol allows the user to control other HDMI devices connected to the TV display, such as DVD players, PC computers and Soundbars.

ConnectShare (USB 2.0)

Connect a thumb drive or digital camera quickly and easily. User-friendly interface allows access to videos, a music playlist and pictures via the remote.

Management and Guest Convenience

Anti-Theft Battery Cover

Battery door is secured, ensuring batteries remain in the remote controller.

Auto Channel Search

Auto detect channel while in Hotel mode.

Clock On Timer and Alarm Key

Allows guests to program their TVs to turn on as a wake-up alarm.

Closed Captioning

A text display of all audio content, including spoken dialog and non-speech information such as the identity of the speakers and symbols for sound effects and music.

Hotel Channel List

Guest master channel listing of program content. This will display content in analog or HD.

Hotel Logo and Custom Message with Samsung Home App

Easily edit the Home App to display your hotel logo and custom message.

Hotel Mode Plug & Play

Interactive and Stand-Alone modes available.

Lockout Controls

The hotelier can enable front panel and menu display lock-outs.

Power On Status Setting

Settings include Power Always On, Last Option or Standby.

On Screen Display Language

Choose English/French/Spanish.

Security for HDMI and USB

You can enable or disable HDMI and USB access. If HDMI is disabled, HDMI source, HDMI-type external channels, and Anynet+ will not be accessible to guests. If USB is disabled, access to USB media is blocked.

Sleep Timer

Allows guests to set TV turn-off time in 30-minute intervals up to 180 minutes.

USB Cloning

A quick and easy way to copy the ideal settings off one television to others on the property. Saves time and helps provide a consistent viewing experience for all televisions.

Picture and Audio

4K Resolution

RU750 series TVs feature 3840 x 2160 4K resolution, to deliver incredible picture quality and a premium experience.

Premium Slim Edge-Lit LED Technology

Edge-lit LED technology provides the brilliance and energy savings advantages of LED technology, along with the uniform brightness typical of CCFL displays. And it does it all with an efficiency that makes it a more affordable technology. In fact, it's possible to upgrade your rooms to LED technology for a cost comparable to CCFL technology. When you add the energy savings of up to 50% that LED offers over CCFL, you end up with the perfect solution for both you and your guests.

Samsung Soundbar Compatible

Samsung Hospitality Displays enable Soundbar compatibility by supporting HDMI-CEC. When you connect the Soundbar to the Samsung Hospitality Display with an HDMI cable, the TV audio settings and menu lock feature are automatically applied, so you don't have to set up the Soundbar separately. You can also prevent guests from changing the settings. With a single remote, guests can control both the TV and Soundbar simultaneously.

Simple Stands

Simple stands are designed to look stylish from any angle. Integrated clean cable solution eliminates tangled, messy cable routing.

Warranty

Hospitality Warranty

2-year parts and 2-year labor warranty backed by the Samsung Hospitality Hotline at 1-866-894-0524. Optional professional installation, accessories and extended warranty are available.

RU750 Series Hospitality TVs

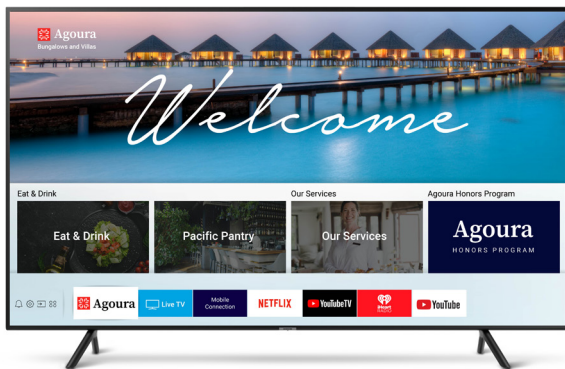

Netflix subscription required.

Dimensions

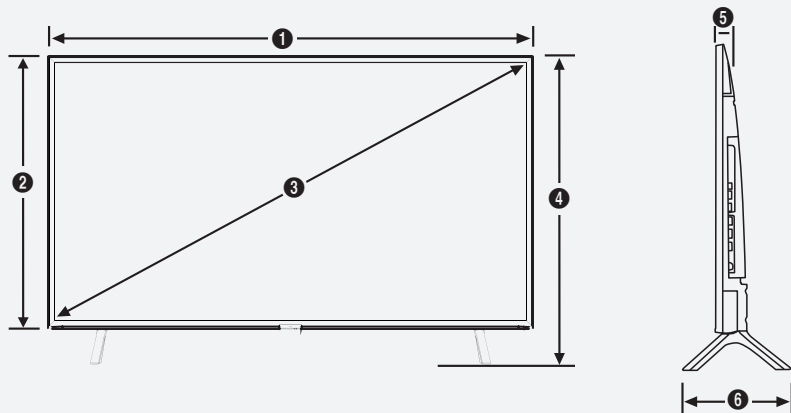

43" | HG43RU750NFXZA - 4K

1	2	3	4	5	6
38.2"	22.2"	42.5"	25.1"	2.3"	8.3"

50" | HG50RU750NFXZA - 4K

1	2	3	4	5	6
44.3"	25.6"	49.5"	28.7"	2.3"	10.3"

55" | HG55RU750NFXZA - 4K

1	2	3	4	5	6
48.8"	28.1"	54.6"	31.2"	2.3"	10.3"

65" | HG65RU750NFXZA - 4K

1	2	3	4	5	6
57.4"	33.0"	64.5"	36.1"	2.3"	12.3"

75" | HG75RU750NFXZA - 4K

1	2	3	4	5	6
66.3"	38.0"	74.5"	41.6"	2.4"	14.0"

RU750 Series Hospitality TVs

Connectivity

HG43RU750NFXZA
HG50RU750NFXZA
HG55RU750NFXZA
HG65RU750NFXZA

- | | | |
|--------------------------------|--------------|----------------|
| 1. Digital Audio Out (Optical) | 5. HDMI In 2 | 8. AV In |
| 2. USB (5V 0.5A) | 6. HDMI In 1 | 9. Data (RJ12) |
| 3. USB (HDD 5V 1A) | 7. Ant In | 10. LAN |
| 4. HDMI In 3 (ARC) | | |

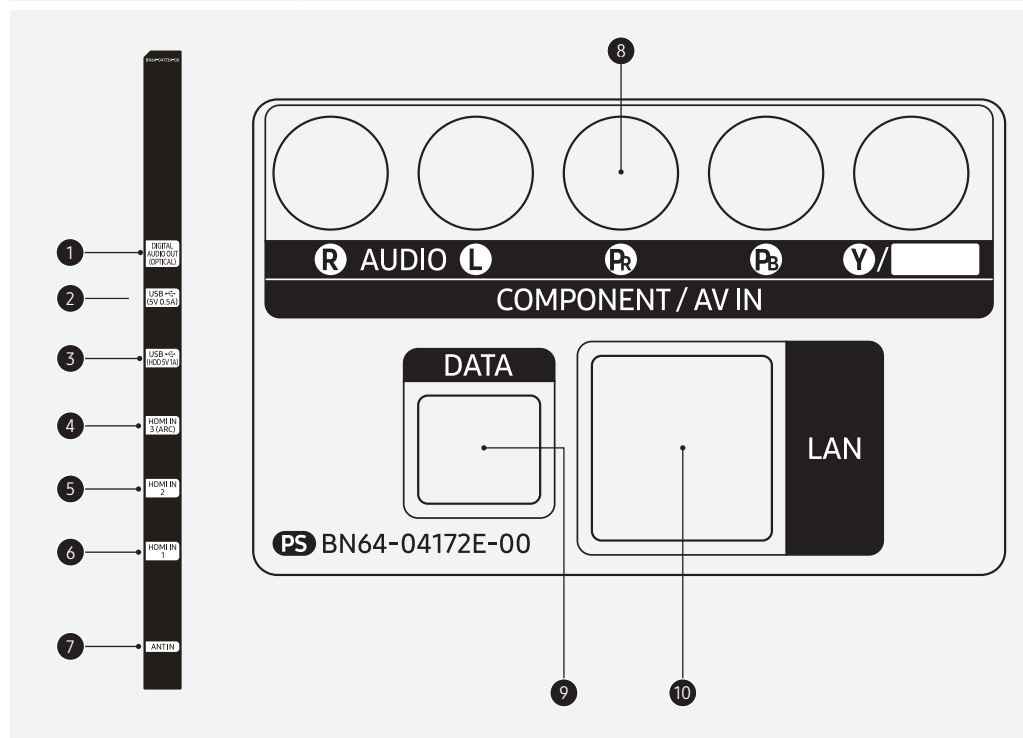

Two data cables are included.

Please refer to your user manual to determine which one is compatible with your specific set-top/set-back box solution.



RU750 Series Hospitality TVs

Specifications For complete product specifications, visit samsung.com/hospitality

		HG43RU750NFXZA	HG50RU750NFXZA	HG55RU750NFXZA	HG65RU750NFXZA	HG75RU750NFXZA
Display	Backlight	LED	LED	LED	LED	LED
	Resolution	3,840 x 2,160	3,840 x 2,160	3,840 x 2,160	3,840 x 2,160	3,840 x 2,160
	Screen Size Class (Diagonal)	43"	50"	55"	65"	75"
Audio	Dolby Digital Plus	Yes	Yes	Yes	Yes	Yes
	Sound Output (RMS)	20W	20W	20W	20W	20W
	Speaker Type	2CH	2CH	2CH	2CH	2CH
Video	Auto Motion Plus	Yes	Yes	Yes	Yes	Yes
	Color	PurColor	PurColor	PurColor	PurColor	PurColor
	Contrast	Mega Contrast	Mega Contrast	Mega Contrast	Mega Contrast	Mega Contrast
	Contrast Enhancer	Yes	Yes	Yes	Yes	Yes
	Film Mode	Yes	Yes	Yes	Yes	Yes
	HDR (High Dynamic Range)	HDR	HDR	HDR	HDR	HDR
	HDR10+	Yes	Yes	Yes	Yes	Yes
	HLG (Hybrid Log Gamma)	Yes	Yes	Yes	Yes	Yes
	Micro Dimming	UHD Dimming	UHD Dimming	UHD Dimming	UHD Dimming	UHD Dimming
	Motion Rate	Advanced 120	Advanced 120	Advanced 120	Advanced 120	Advanced 120
	Natural Mode Support	Yes	Yes	Yes	Yes	Yes
	Picture Engine	UHD Engine	UHD Engine	UHD Engine	UHD Engine	UHD Engine
PQI (Picture Quality Index)	1300	1300	1300	1300	1300	
Viewing Angle (H / V)	178° / 178°	178° / 178°	178° / 178°	178° / 178°	178° / 178°	
Input and Output	HDMI (Side / Rear)	3/0	3/0	3/0	3/0	3/0
	USB (Side / Rear)	2/0	2/0	2/0	2/0	2/0
	Component In (Y / Pb / Pr) (Side / Rear)	0/1	0/1	0/1	0/1	0/1
	Composite In (AV) (Side / Rear)	0/1 (Common Use for Component Y)	0/1 (Common Use for Component Y)	0/1 (Common Use for Component Y)	0/1 (Common Use for Component Y)	0/1 (Common Use for Component Y)
	Ethernet (LAN) (Side / Rear)	0/1	0/1	0/1	0/1	0/1
	Digital Audio Out (Optical) (Side / Rear)	1/0	1/0	1/0	1/0	1/0
	Ant In (Terrestrial / Cable Input) (Side / Rear)	1/1 (Common Use for Terrestrial) / 0	1/1 (Common Use for Terrestrial) / 0	1/1 (Common Use for Terrestrial) / 0	1/1 (Common Use for Terrestrial) / 0	1/1 (Common Use for Terrestrial) / 0
	Ex-Link (RS-232C)	Supports USB to Ex-Link Adapter	Supports USB to Ex-Link Adapter	Supports USB to Ex-Link Adapter	Supports USB to Ex-Link Adapter	Supports USB to Ex-Link Adapter
	HDMI A / Return Ch. Support	Yes	Yes	Yes	Yes	Yes
	Wi-Fi	Yes	Yes	Yes	Yes	Yes
	Anynet+ (HDMI-CEC)	Yes	Yes	Yes	Yes	Yes
	Data RJ12 (Side / Rear)	0/1	0/1	0/1	0/1	0/1
Features	Accessibility	Grayscale / Caption Setting / Voice Guide (US English) / Enlarge / High Contrast / Multi-Output Audio / Remote Button Repeat Setting	Grayscale / Caption Setting / Voice Guide (US English) / Enlarge / High Contrast / Multi-Output Audio / Remote Button Repeat Setting	Grayscale / Caption Setting / Voice Guide (US English) / Enlarge / High Contrast / Multi-Output Audio / Remote Button Repeat Setting	Grayscale / Caption Setting / Voice Guide (US English) / Enlarge / High Contrast / Multi-Output Audio / Remote Button Repeat Setting	Grayscale / Caption Setting / Voice Guide (US English) / Enlarge / High Contrast / Multi-Output Audio / Remote Button Repeat Setting
	Auto Channel Search	Yes	Yes	Yes	Yes	Yes
	Auto Power Off	Yes	Yes	Yes	Yes	Yes
	Caption (Subtitle)	Yes	Yes	Yes	Yes	Yes
	Connect Share™ (HDD)	Yes	Yes	Yes	Yes	Yes
	ConnectShare™ (USB 2.0)	Yes	Yes	Yes	Yes	Yes
	Digital Clean View	Yes	Yes	Yes	Yes	Yes
	EPG	Yes	Yes	Yes	Yes	Yes
	Game Mode	Yes (Auto Game Mode)	Yes (Auto Game Mode)	Yes (Auto Game Mode)	Yes (Auto Game Mode)	Yes (Auto Game Mode)
	IPv6 Support	Yes	Yes	Yes	Yes	Yes
	MBR Support	Yes	Yes	Yes	Yes	Yes
	OSD Language	English, Spanish, French	English, Spanish, French	English, Spanish, French	English, Spanish, French	English, Spanish, French
	Processor	Quad-Core	Quad-Core	Quad-Core	Quad-Core	Quad-Core
	USB HID Support	Yes	Yes	Yes	Yes	Yes
	V-Chip	Yes	Yes	Yes	Yes	Yes
Convergence	Mobile to TV - Mirroring, DLNA	Yes	Yes	Yes	Yes	

RU750 Series Hospitality TVs

Specifications For complete product specifications, visit samsung.com/hospitality

		HG43RU750NFXZA	HG50RU750NFXZA	HG55RU750NFXZA	HG65RU750NFXZA	HG75RU750NFXZA
Smart TV	Smart TV Type	Smart	Smart	Smart	Smart	Smart
	TV Plus App	Yes	Yes	Yes	Yes	Yes
	Web Browser App	Yes	Yes	Yes	Yes	Yes
System	Digital Broadcasting	ATSC / ClearQAM	ATSC / ClearQAM	ATSC / ClearQAM	ATSC / ClearQAM	ATSC / ClearQAM
	Analog Tuner	Yes	Yes	Yes	Yes	Yes
Hospitality Features	Energy Saving Mode (BLU Control)	Yes	Yes	Yes	Yes	Yes
	Hospitality Plug & Play (Easy Set-up)	Yes	Yes	Yes	Yes	Yes
	Hotel Channel List	Yes	Yes	Yes	Yes	Yes
	Channel Menu Display	Yes	Yes	Yes	Yes	Yes
	Mixed Channel List (ATSC, DVB-T / T2 / C / S2, Analog)	Yes	Yes	Yes	Yes	Yes
	My Channel	Yes	Yes	Yes	Yes	Yes
	Power On Mode	Yes	Yes	Yes	Yes	Yes
	RJ12/IR Pass Through	Yes	Yes	Yes	Yes	Yes
	Pro:Idiom	Yes	Yes	Yes	Yes	Yes
	Samsung LYNK DRM	Yes	Yes	Yes	Yes	Yes
	Security Mode	Yes	Yes	Yes	Yes	Yes
	USB Cloning	Yes	Yes	Yes	Yes	Yes
	Wake-up Timer (Alarm)	Yes	Yes	Yes	Yes	Yes
Design	Stand Type	Simple Luminus	Simple Luminus	Simple Luminus	Simple Luminus	Simple Luminus
	Front Color	Charcoal Black	Charcoal Black	Charcoal Black	Charcoal Black	Charcoal Black
	Bezel Type	Very Narrow Bezel	Very Narrow Bezel	Very Narrow Bezel	Very Narrow Bezel	Very Narrow Bezel
VESA	VESA Screw Size	M8	M8	M8	M8	M8
	VESA Screw Depth	43-45 mm	43-45 mm	43-45 mm	43-45 mm	43-45 mm
	VESA Mount	200 x 200 mm	200 x 200 mm	200 x 200 mm	400 x 400 mm	400 x 400 mm
Eco	Eco Sensor	Yes	Yes	Yes	Yes	Yes
Power	Power Consumption (Max)	105W	120W	135W	160W	205W
	Power Consumption (Standby)	0.4W	0.4W	0.4W	0.4W	0.4W
	Power Consumption (Typical)	50W	55W	65W	75W	90W
	Power Supply (V)	AC110-120V 50 / 60Hz	AC110-120V 50 / 60Hz	AC110-120V 50 / 60Hz	AC110-120V 50 / 60Hz	AC110-120V 50 / 60Hz
Dimensions (W x H x D)	Package Dimension (W x H x D)	1097.0 x 678.0 x 151.0 mm / 43.2" x 26.7" x 5.9"	1272.0 x 790.0 x 155.0 mm / 50.1" x 31.1" x 6.1"	1396.0 x 852.0 x 158.0 mm / 55.0" x 33.5" x 6.2"	1611.0 x 975.0 x 178.0 mm / 63.4" x 38.4" x 7.0"	1871.0 x 1131.0 x 234.0 mm / 73.7" x 44.5" x 9.2"
	Set Dimension with Stand (W x H x D)	970.2 x 636.3 x 210.3 mm / 38.2" x 25.1" x 8.3"	1124.8 x 728.8 x 261.3 mm / 44.3" x 28.7" x 10.3"	1238.6 x 792.8 x 261.3 mm / 48.8" x 31.2" x 10.3"	1457.5 x 917.3 x 312.8 mm / 57.4" x 36.1" x 12.3"	1684.6 x 1056.5 x 356.1 mm / 66.3" x 41.6" x 14.0"
	Set Dimension without Stand (W x H x D)	970.2 x 563.2 x 58.2 mm / 38.2" x 22.2" x 2.3"	1124.8 x 650.2 x 59.1 mm / 44.3" x 25.6" x 2.3"	1238.6 x 714.2 x 58.7 mm / 48.8" x 28.1" x 2.3"	1457.5 x 837.3 x 59.1 mm / 57.4" x 33.0" x 2.3"	1684.6 x 966.4 x 60.1 mm / 66.3" x 38.0" x 2.4"
Weight	Package Weight	12.8 kg / 28.2 lbs.	19.1 kg / 42.1 lbs.	22.6 kg / 49.8 lbs.	32.7 kg / 72.1 lbs.	49.3 kg / 108.7 lbs.
	Set Weight with Stand	9.8 kg / 21.6 lbs.	13.9 kg / 30.6 lbs.	17.7 kg / 39.0 lbs.	25.5 kg / 56.2 lbs.	37.5 kg / 82.7 lbs.
	Set Weight without Stand	9.6 kg / 21.2 lbs.	13.6 kg / 30.0 lbs.	17.3 kg / 38.1 lbs.	25.0 kg / 55.1 lbs.	37.0 kg / 81.6 lbs.
Accessory	Power Cable	Yes	Yes	Yes	Yes	Yes
	Batteries (for Remote Control)	Yes	Yes	Yes	Yes	Yes
	Data Cable	Yes	Yes	Yes	Yes	Yes
	Quick Install Guide	Yes	Yes	Yes	Yes	Yes
	Remote Controller Model	TM1240A	TM1240A	TM1240A	TM1240A	TM1240A
	Mini Wall Mount Supported	Yes	Yes	Yes	Yes	N/A
VESA Wall Mount Supported	Yes	Yes	Yes	Yes	Yes	

Learn More samsung.com/business insights.samsung.com samsung.com/hospitality

Product Support 1-866-SAM4BIZ **Follow Us** [youtube.com/samsungbizusa](https://www.youtube.com/samsungbizusa) [@SamsungBizUSA](https://www.instagram.com/SamsungBizUSA)

SAMSUNG