



SONICS

F-Series
Ultrasonic Generator Kits and Stack Components

40, 35, 30, 20 and 15 kHz Models Available

USER MANUAL

Sonics & Materials, Inc.
53 Church Hill Road ◊ Newtown, CT 06470 USA
203.270.4600 ◊ 203.270.4610 fax
info@sonics.com ◊ www.sonics.com

ULTRASONIC COMPONENTS

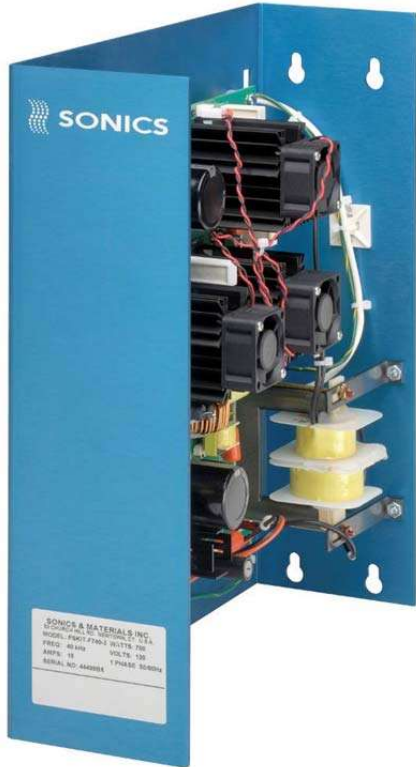

F-Series Generator Kit

- F800 - 40 kHz @ 800 Watts Power
- F1200 - 20 kHz @ 1200 Watts Power
- F1700 - 20 kHz @ 1700 Watts Power
- F2200 - 20 kHz @ 2200 Watts Power

WARNING

This Sonics & Materials manufactured ultrasonic generator kits and sequencing boards are designed for use as an internal electrical component. They should only be electrically powered after being properly mounted and earth grounded inside of an industry standard NEMA type electrical enclosure.



Optional Sequencing Boards

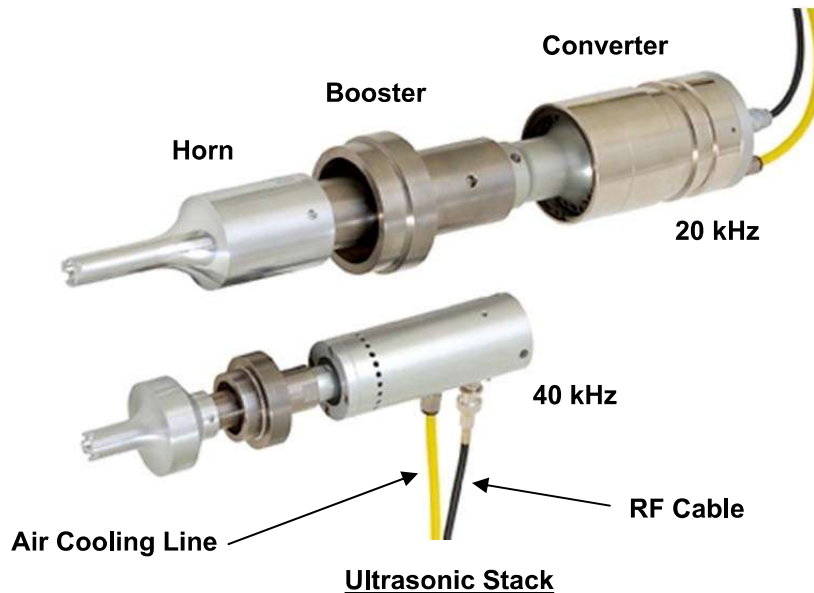

GLOSSARY OF TERMS

AIR COOLING: Air cooling of the converter and stack components may be required when running ultrasonic stacks in a continuous duty mode or with short duty cycle. The mechanical expansion and contraction of the internal converter PZT crystals, booster and horn can cause heat to build in the stack components which can result in a drop in frequency. This drop in frequency can then result in inconsistent welds and/or a generator overload condition.

AMPLITUDE: The extent of vibratory movement or, peak-to-peak vibration distance.

BOOSTER: Aluminum or titanium machined component between the ultrasonic converter and horn. Interchangeable and depending on gain ratio, is used to increase or decrease horn face amplitude.

CONVERTER: Also referred to as a transducer, ultrasonic component that contains piezoelectric (PZT) crystals and converts a high frequency electrical signal to mechanical vibration.

FREQUENCY: The number of occurrences within a given time period. (Usually 1 second.) At 20 kHz, the frequency of modulation is 20,000 times per second. At 40 kHz, the frequency of modulation is 40,000 times per second.

GAIN: Similar to amplification, expressed as the ratio of input to output.

GENERATOR KIT: Also referred to as a Power Supply, ultrasonic generator which converts low frequency (50/60 Hz) electrical input cycle to a higher output frequency such as 20 kHz or 40 kHz. Mounts internally to a properly rated NEMA type electrical enclosure.

HIGH VOLTAGE MULTIPLEXER: Also referred to as a Sequencer. Ultrasonic RF relay switching board which provides sequential switching of multiple converter stacks from a single ultrasonic generator or power supply.

HORN: An acoustical tool, typically machined from aluminum or titanium, which mechanically vibrates at a specific frequency. Stretches and shrinks in length creating amplitude at the face of the horn.

JOULES: Units of energy, also known as watt-seconds. One Joule is a measure of energy equal to 1 watt second.

KILOHERTZ (kHz): Common measurement for frequency of ultrasonic vibration. One kHz is 1000 cycles per second.

NODAL POINT: The point in an acoustical tool (such as a horn or booster) where little or no ultrasonic motion occurs.

RF CABLE: Cable that connects the ultrasonic converter to its RF output source. Single RF output source direct from an ultrasonic generator or multiple RF output sources from an ultrasonic sequencer.

SEQUENCER: Ultrasonic RF relay switching board which provides sequential switching of multiple converter stacks from a single ultrasonic generator or power supply.

SEQUENCING: PLC controlled method in which multiple ultrasonic stacks are fired in sequential order from a single ultrasonic generator or power supply.

STACK: Ultrasonic converter, booster and horn assembly. (Some applications do not require a booster in the stack.)

US: Abbreviation for ultrasonics.

WATT-SECONDS: Units of energy, also known as Joules.

IMPORTANT INFORMATION

COOLING: Three cooling fans are supplied and mounted to respective heat sinks on the kits main board. **NEMA enclosure must be fan powered and air vented for proper cooling of other heat sensitive components.**

LINE VOLTAGE: Incoming line voltage must be noise filtered and correctly earth grounded. Din rail mounted contact blocks are provided on the PLL board side of the kit for these connections.

220 VAC single phase is standard incoming source power unless optional 110 VAC was ordered prior to shipment on 800 or 1200 watt units.

ELECTRICAL NOISE: Due to potential for electrical noise interference, all RF cables and cable connections should be routed as far away from other electrical components as possible.

SINGLE RF CABLES (See Figure 1): RF cable out from the ultrasonic generator kit and direct to a single ultrasonic converter should not exceed 30' in length. **Contact Sonics if a longer RF cable length is required.**

MULTIPLE RF CABLES (See Figure 2): When sequencing multiple converters from a single generator kit, all RF cables out from the sequencer to individual ultrasonic converters should not exceed 30' in length. **Contact Sonics if a longer RF cable lengths are required.**

CONTACT BLOCKS: All user incoming line voltage, RF cable and PLC I/O interface connections are made to the din rail mounted contact blocks. There are no user connections to the generator kits main board or PLL board.

Figure 1

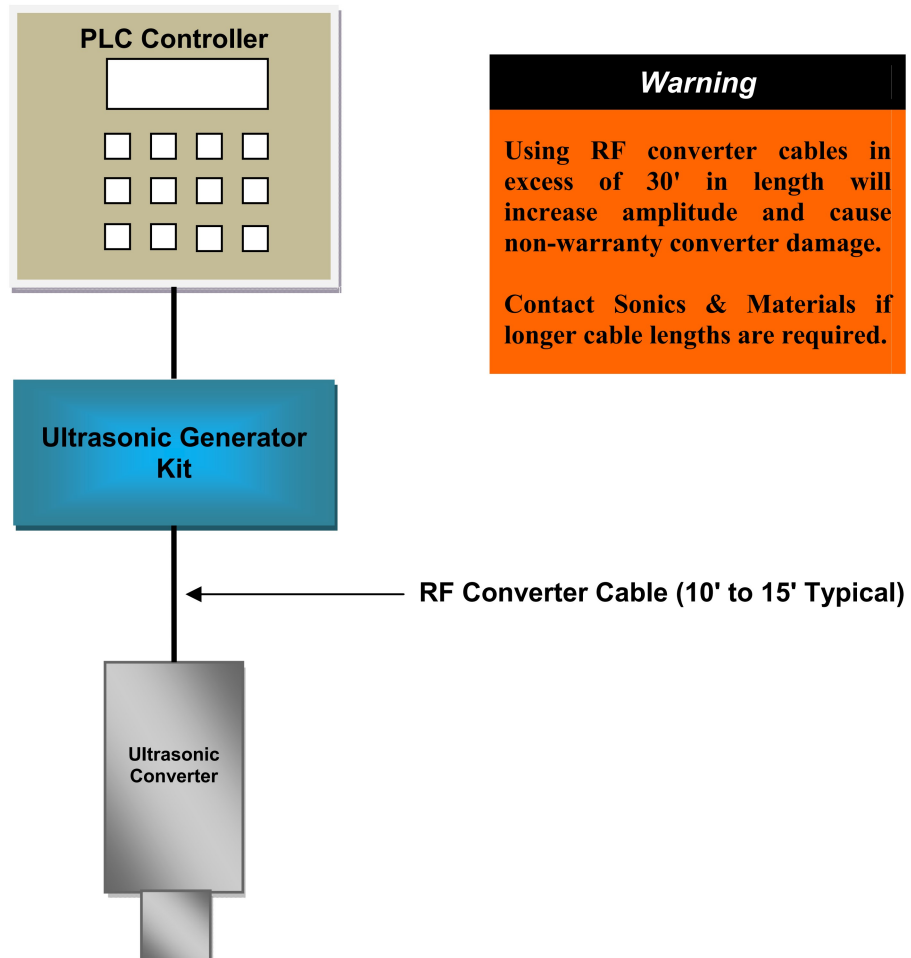

IMPORTANT INFORMATION

Figure 2

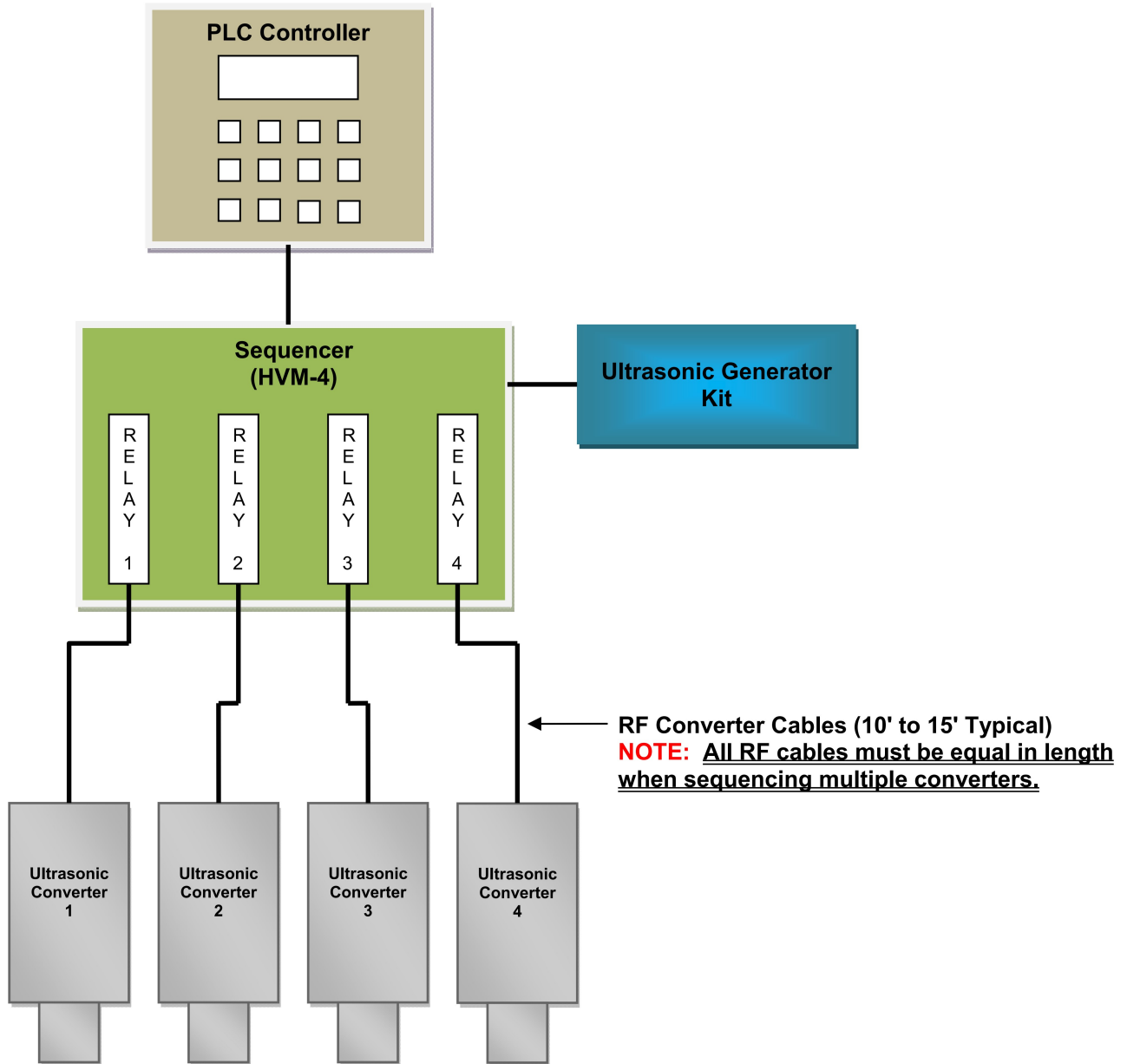

Important Note - RF CONVERTER CABLES

When sequencing multiple converters from a single generator kit.

All converter RF cables must be equal in length. Varying cable lengths will cause cable capacitance variations which will result in inconsistent stack-to-stack weld results.



DO NOT CUT OR SHORTEN RF CONVERTER CABLES

ALWAYS COIL AND ZIP-TIE EXCESS RF CABLE LENGTHS

PANEL FRONT AND MAIN BOARD

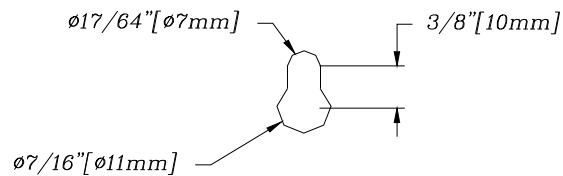
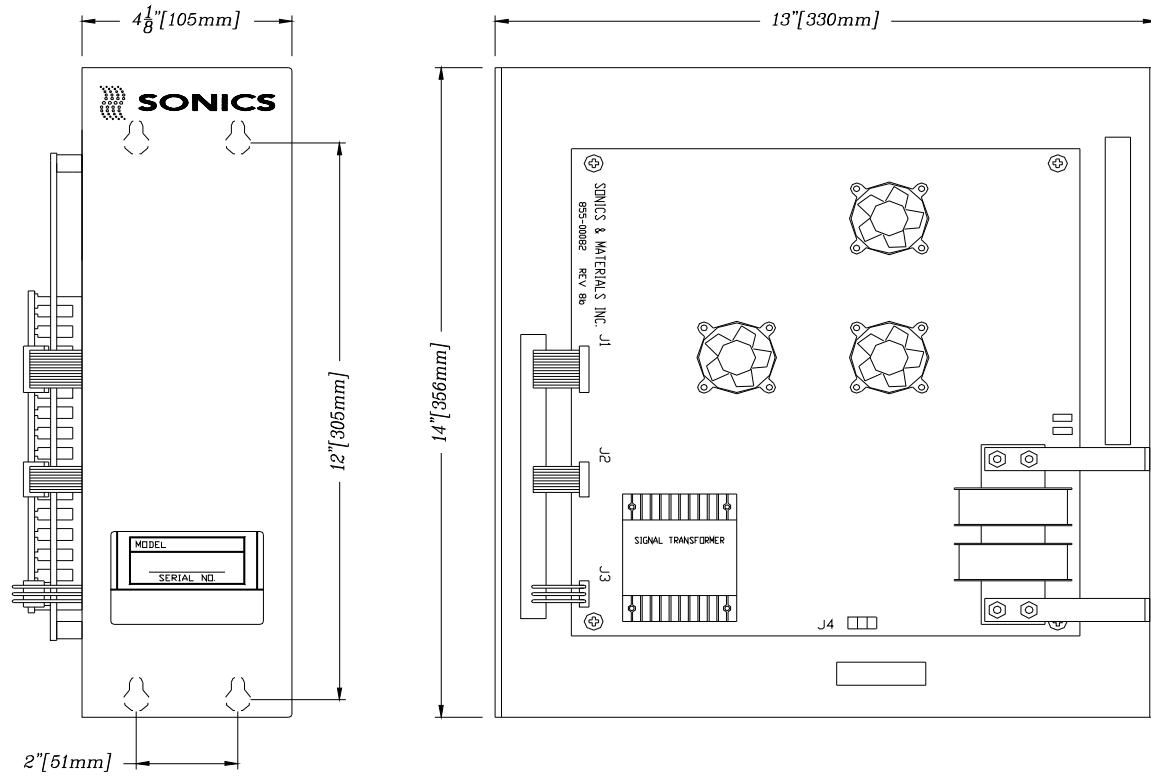

MAIN BOARD: Similar to a computers motherboard, the kits main board is the primary ultrasonic power source.

No line voltage power, RF signal or PLC interface connections are made by the user to the main board.

Per the 2" and 12" center-to-center distances as shown on the kits front view, secure the kit to the NEMA enclosures internal sub-plate using four (4) 1/4" screws.

CAUTION	
 <p>High voltage</p>	<p>Always disconnect main electrical power before servicing or making connections.</p>

PANEL FRONT AND PLL BOARD

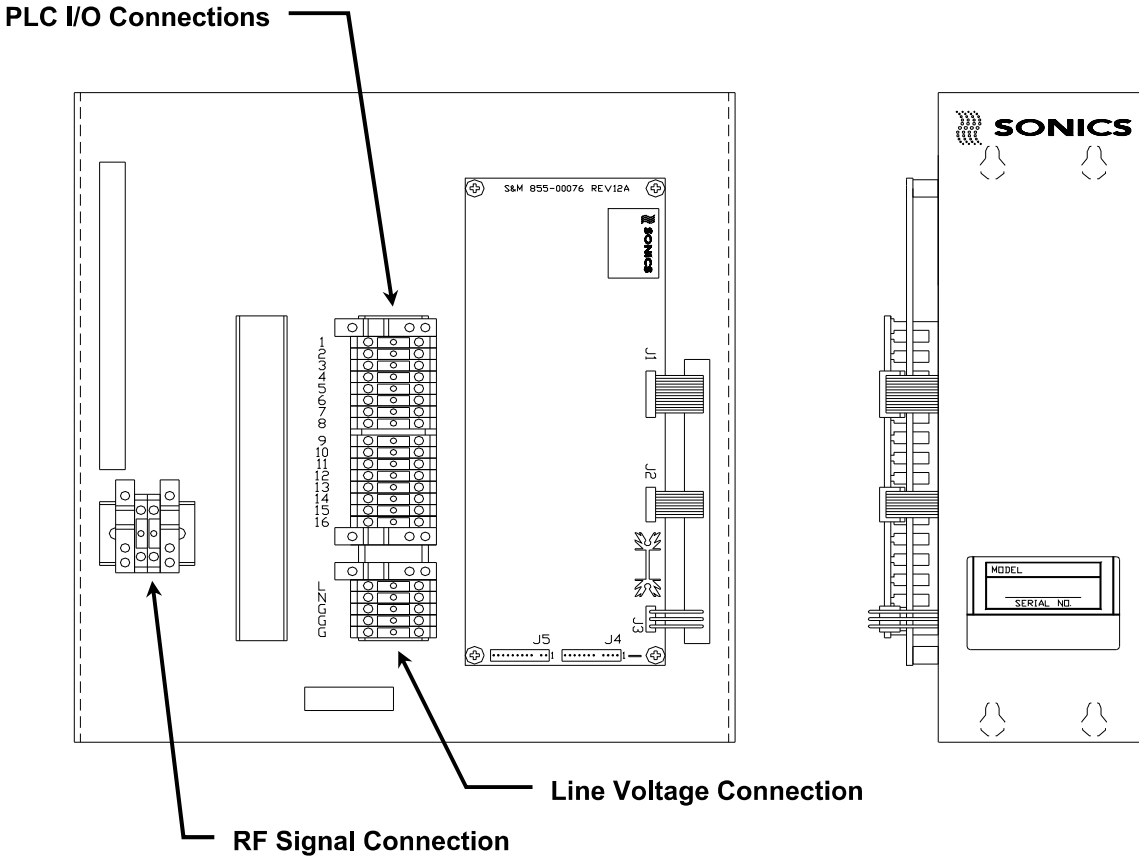

PLL BOARD (Phase-Lock-Loop): Working in tandem with the main board, the PLL board (also referred to as a control board) comprises of automatic frequency tuning, energy functions and variable amplitude settings.

PLC INTERFACING: Included with this manual is Sonics Drawing #E-3163 which details customer supplied PLC I/O (input and output) connections to the kits various contact blocks.

Contacts 1 through 8: *PLC outputs*
Contacts 9 through 16: *PLC input return*

Proper connections and PLC programming will allow the following user functions and capabilities.

- ✓ *Time base ultrasonic's on/off weld cycle.*
- ✓ *0 to 10 volt output signal that can correlate watts being applied during the weld cycle.*
- ✓ *Weld energy monitoring.*
- ✓ *Variable amplitude setting.*
- ✓ *System overload signal.*
- ✓ *External overload reset.*
- ✓ *System ready signal.*

CAUTION



Always disconnect main electrical power before servicing or making connections.

High voltage

20 kHz ULTRASONIC CONVERTERS

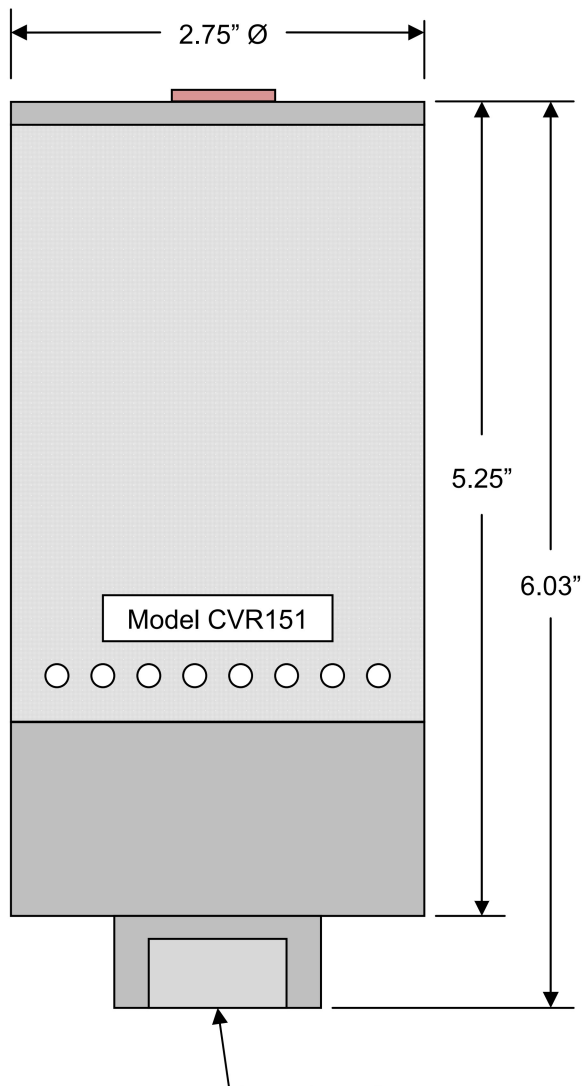
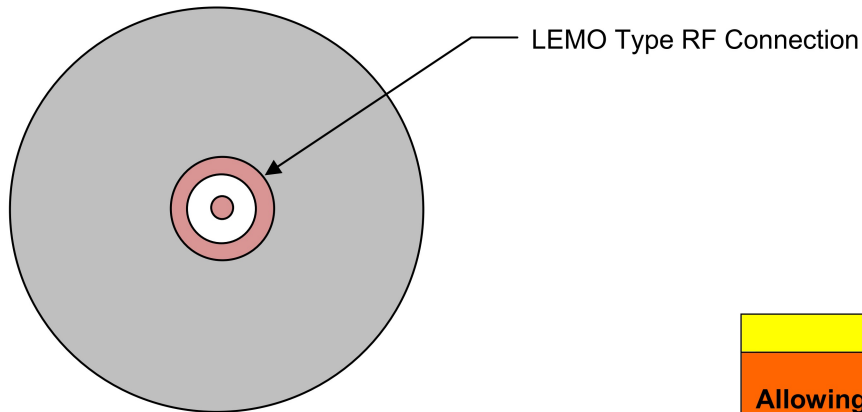

WARNING

Allowing contaminants such as oil or moisture to enter the converter through the air cooling port will cause non-warranty converter damage.

ALL AIR COOLING LINES MUST BE CLEAN AND DRY AT ALL TIMES

NOTE

Converter design and dimensional data is for reference only and subject to change without notice.

Drawings are not to scale.

Contact Sonics & Materials to verify current converter models, designs and dimensions.

20 kHz ULTRASONIC CONVERTERS

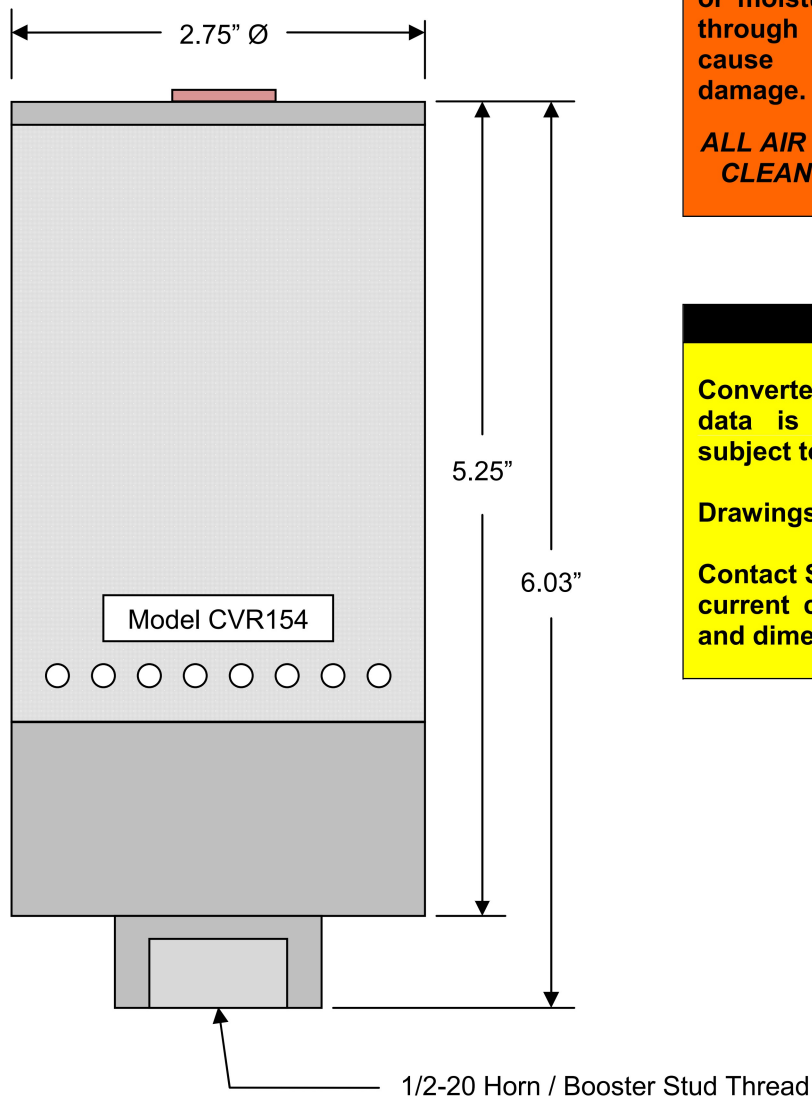
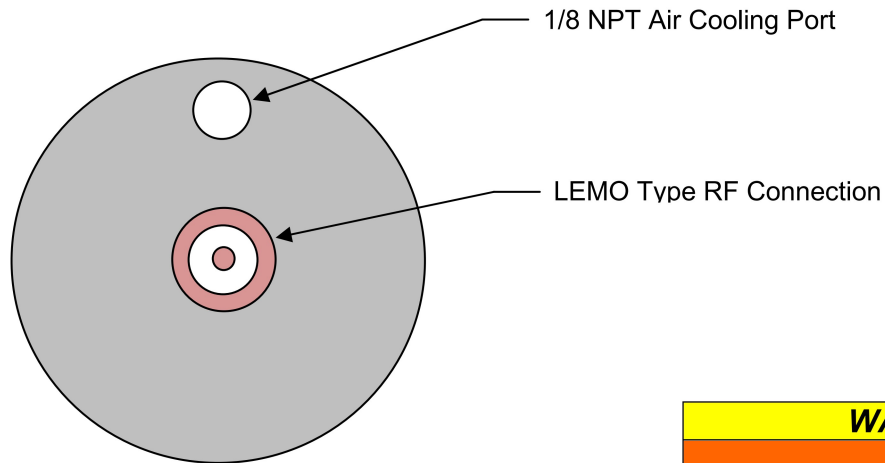

WARNING

Allowing contaminants such as oil or moisture to enter the converter through the air cooling port will cause non-warranty converter damage.

ALL AIR COOLING LINES MUST BE CLEAN AND DRY AT ALL TIMES

NOTE

Converter design and dimensional data is for reference only and subject to change without notice.

Drawings are not to scale.

Contact Sonics & Materials to verify current converter models, designs and dimensions.

40 kHz ULTRASONIC CONVERTERS

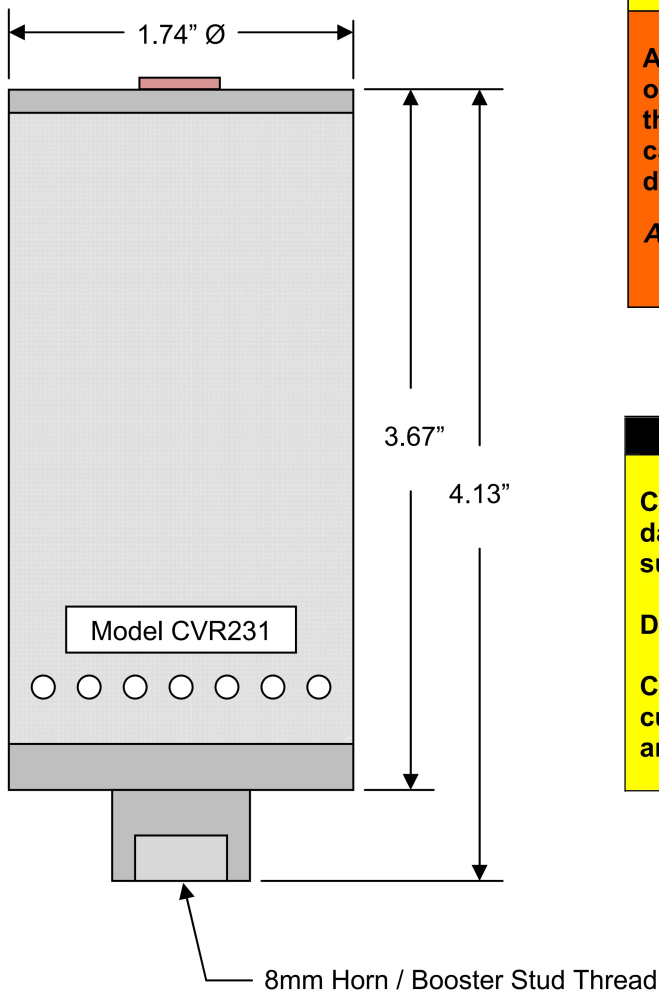
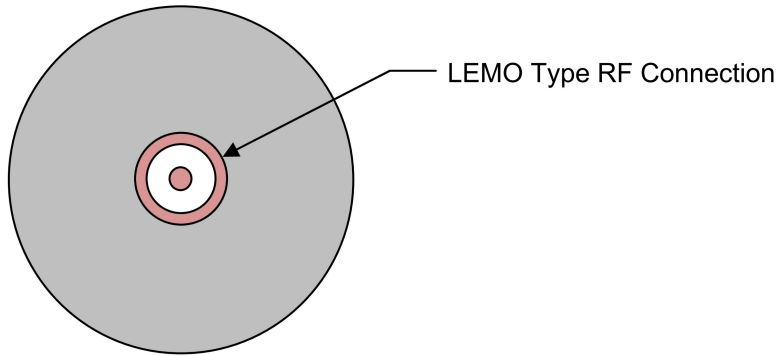

WARNING

Allowing contaminants such as oil or moisture to enter the converter through the air cooling port will cause non-warranty converter damage.

ALL AIR COOLING LINES MUST BE CLEAN AND DRY AT ALL TIMES

NOTE

Converter design and dimensional data is for reference only and subject to change without notice.

Drawings are not to scale.

Contact Sonics & Materials to verify current converter models, designs and dimensions.

40 kHz ULTRASONIC CONVERTERS

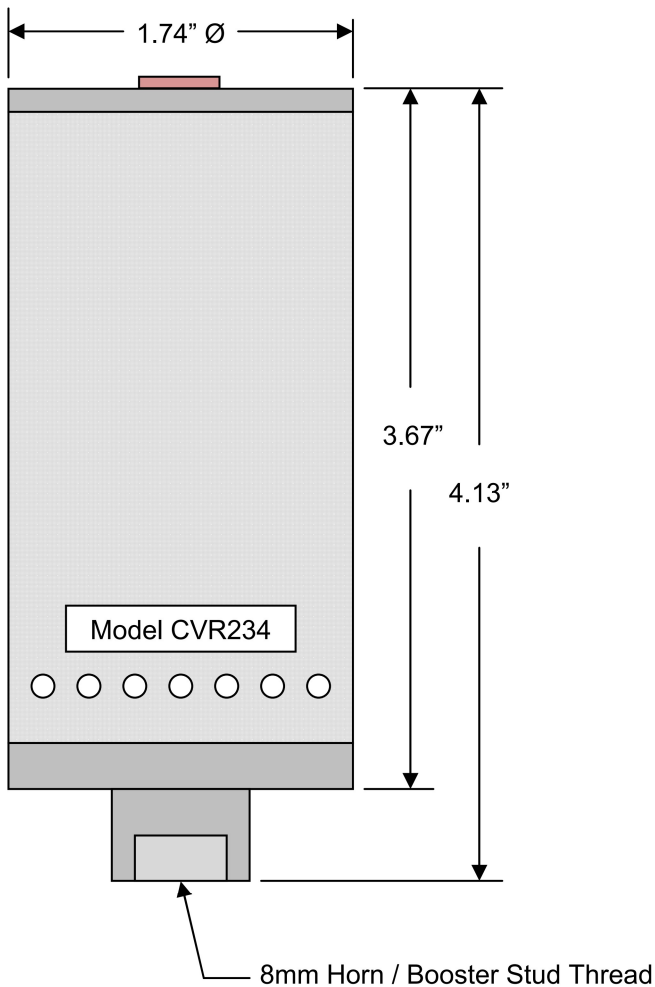
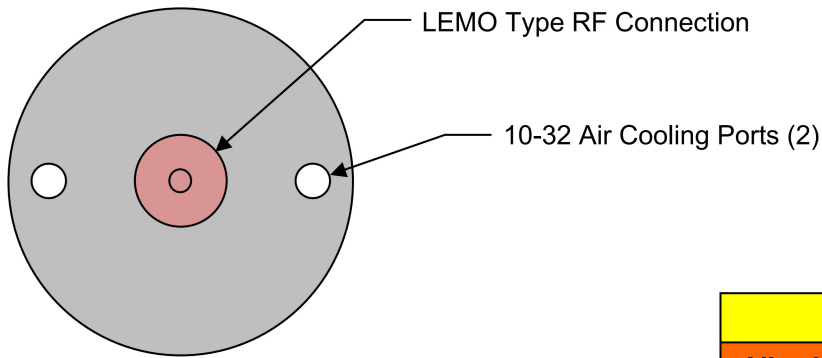

WARNING

Allowing contaminants such as oil or moisture to enter the converter through the air cooling port will cause non-warranty converter damage.

ALL AIR COOLING LINES MUST BE CLEAN AND DRY AT ALL TIMES

NOTE

Converter design and dimensional data is for reference only and subject to change without notice.

Drawings are not to scale.

Contact Sonics & Materials to verify current converter models, designs and dimensions.

40 kHz ULTRASONIC CONVERTERS

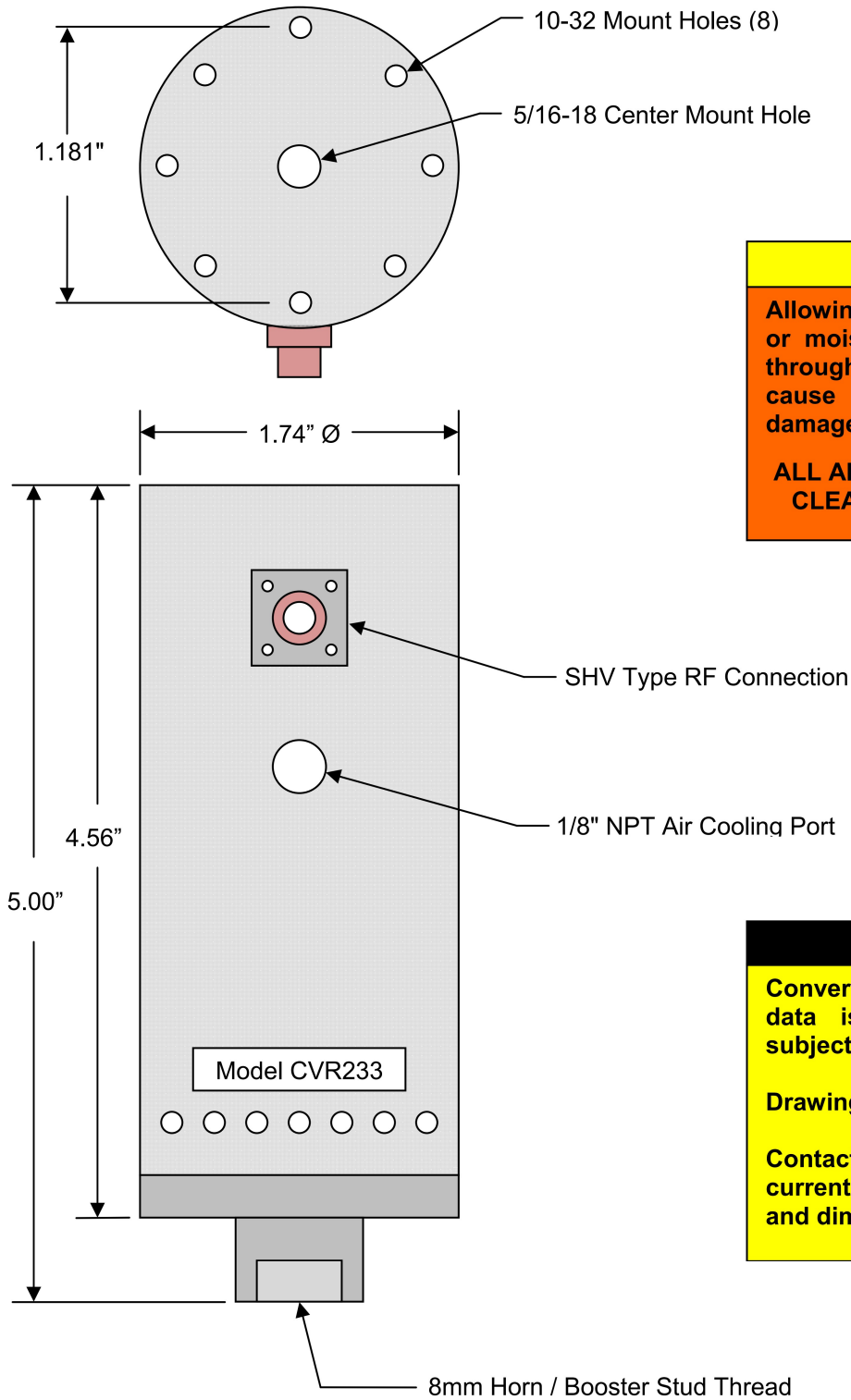

WARNING

Allowing contaminants such as oil or moisture to enter the converter through the air cooling port will cause non-warranty converter damage.

ALL AIR COOLING LINES MUST BE CLEAN AND DRY AT ALL TIMES

NOTE

Converter design and dimensional data is for reference only and subject to change without notice.

Drawings are not to scale.

Contact Sonics & Materials to verify current converter models, designs and dimensions.

40 kHz ULTRASONIC CONVERTERS

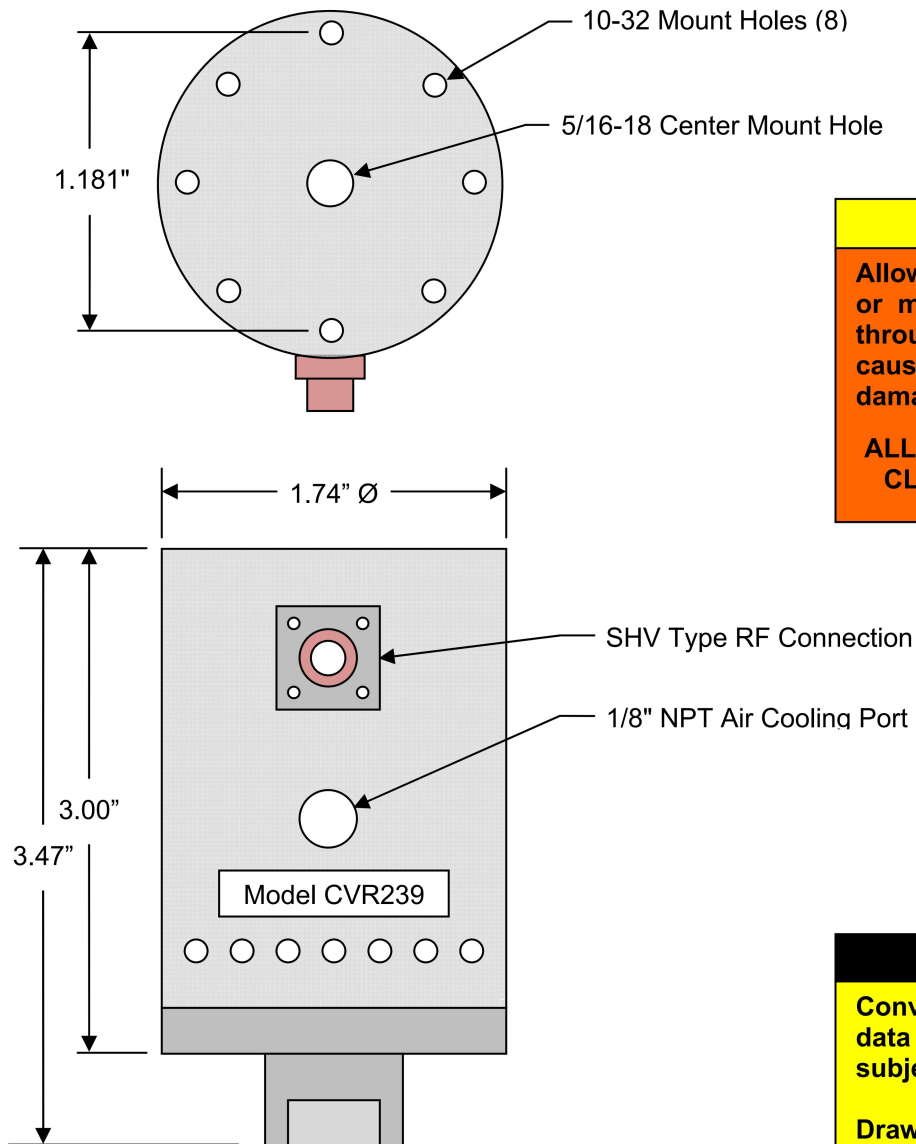

WARNING

Allowing contaminants such as oil or moisture to enter the converter through the air cooling port will cause non-warranty converter damage.

ALL AIR COOLING LINES MUST BE CLEAN AND DRY AT ALL TIMES

NOTE

Converter design and dimensional data is for reference only and subject to change without notice.

Drawings are not to scale.

Contact Sonics & Materials to verify current converter models, designs and dimensions.

CONVERTER RF CABLES

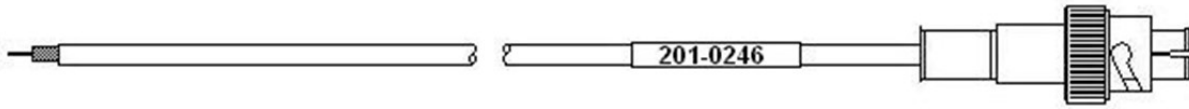

201-0246: 40 kHz @ 10' with SHV Type Connector



201-0292: 40 kHz @ 15' with LEMO Type Connector



201-0247: 20 kHz @ 10' with LEMO Type Connector

Important Notes - RF CONVERTER CABLES

1. When sequencing multiple converters from a single generator kit.

All converter RF cables must be equal in length. Varying cable lengths will cause cable capacitance variations resulting in inconsistent stack-to-stack weld results.



DO NOT CUT OR SHORTEN RF CONVERTER CABLES

ALWAYS COIL AND ZIP-TIE EXCESS RF CABLE LENGTHS

2. For customer supplied RF cables, use only RG58 coaxial cable rated for 1400 volts RMS or higher. (Alpha Wire #9058C recommended.)
3. Due to potential for electrical noise interference, all RF cables and cable connections should be routed as far away from other electrical components as possible.
4. When sequencing multiple converters from a single power supply kit, all RF cables out from the NEMA enclosure to individual ultrasonic converters should not exceed 15' in length. Contact Sonics if longer RF cable lengths are required.

BOOSTERS

Aluminum O-Ring Style Boosters			
DESCRIPTION	FREQ. (kHz)	HORN THREAD	COLOR CODE AND GAIN RATIO
BHN15GD BOOSTER	20	3/8-24	GOLD +1.50 GAIN
BHN15BR BOOSTER	20	3/8-24	BROWN +1.25 GAIN
BHN15GR BOOSTER	20	3/8-24	GREEN +1.00 GAIN
BHN15BU BOOSTER	20	3/8-24	BLUE -0.50 GAIN
BHN15PU BOOSTER	20	3/8-24	PURPLE -0.75 GAIN
BHN23BK BOOSTER	40	8 MM	BLACK +2.50 GAIN
BHN23SI BOOSTER	40	8 MM	SILVER +2.00 GAIN
BHN23GD BOOSTER	40	8 MM	GOLD +1.50 GAIN
BHN23BR BOOSTER	40	8 MM	BROWN +1.25 GAIN
BHN23GR BOOSTER	40	8 MM	GREEN +1.00 GAIN
BHN23PU BOOSTER	40	8 MM	PURPLE -0.75 GAIN

Titanium O-Ring Style Boosters			
DESCRIPTION	FREQ. (kHz)	HORN THREAD	COLOR CODE AND GAIN RATIO
BHN15TBK BOOSTER	20	3/8-24	BLACK +2.50 GAIN
BHN15TSI BOOSTER	20	3/8-24	SILVER +2.00 GAIN
BHN15TGD BOOSTER	20	3/8-24	GOLD +1.50 GAIN
BHN23TBK BOOSTER	40	8 MM	BLACK +2.50 GAIN
BHN23TSI BOOSTER	40	8 MM	SILVER +2.00 GAIN



BOOSTERS

Rigid Titanium Style Boosters			
DESCRIPTION	FREQ. (kHz)	HORN THREAD	COLOR CODE AND GAIN RATIO
BHN15BK BOOSTER	20	3/8-24	 BLACK +2.50 GAIN
BHN15SI BOOSTER	20	3/8-24	 SILVER +2.00 GAIN
BHN15GD BOOSTER	20	3/8-24	 GOLD +1.50 GAIN
BHN15BR BOOSTER	20	3/8-24	 BROWN +1.25 GAIN
BHN15GR BOOSTER	20	3/8-24	 GREEN +1.00 GAIN
BHN15BU BOOSTER	20	3/8-24	 BLUE -0.50 GAIN
BHN15PU BOOSTER	20	3/8-24	 PURPLE -0.75 GAIN
BHN23BK BOOSTER	40	8 MM	 BLACK +2.50 GAIN
BHN23SI BOOSTER	40	8 MM	 SILVER +2.00 GAIN
BHN23GD BOOSTER	40	8 MM	 GOLD +1.50 GAIN
BHN23BR BOOSTER	40	8 MM	 BROWN +1.25 GAIN
BHN23GR BOOSTER	40	8 MM	 GREEN +1.00 GAIN
BHN23PU BOOSTER	40	8 MM	 PURPLE -0.75 GAIN



BOOSTERS

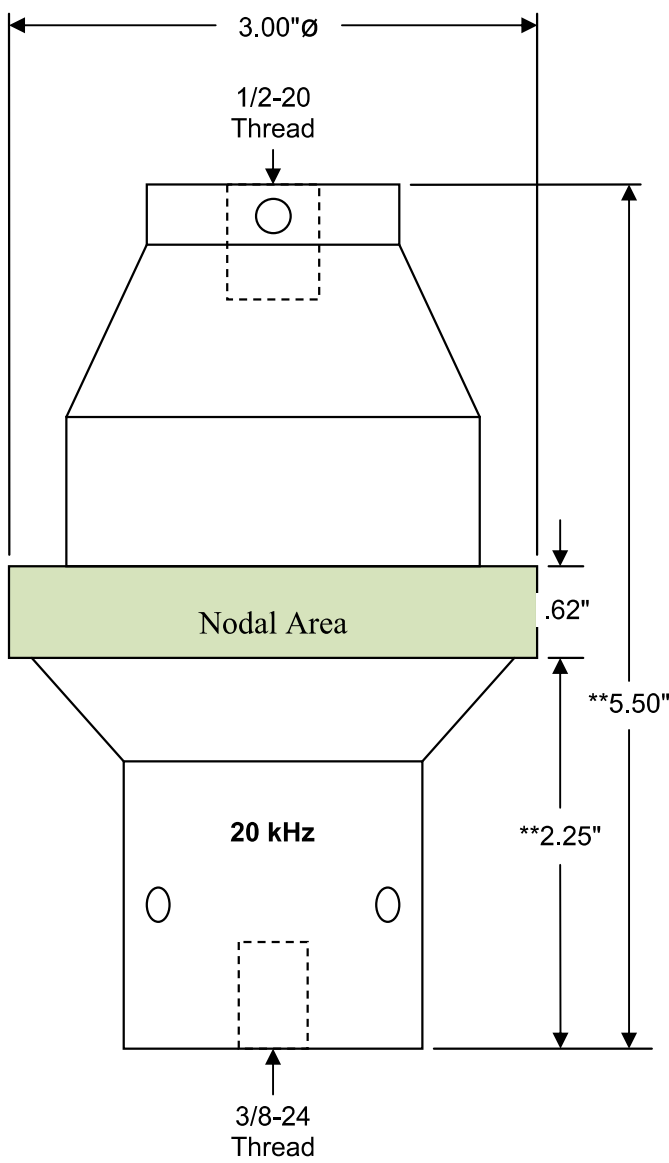
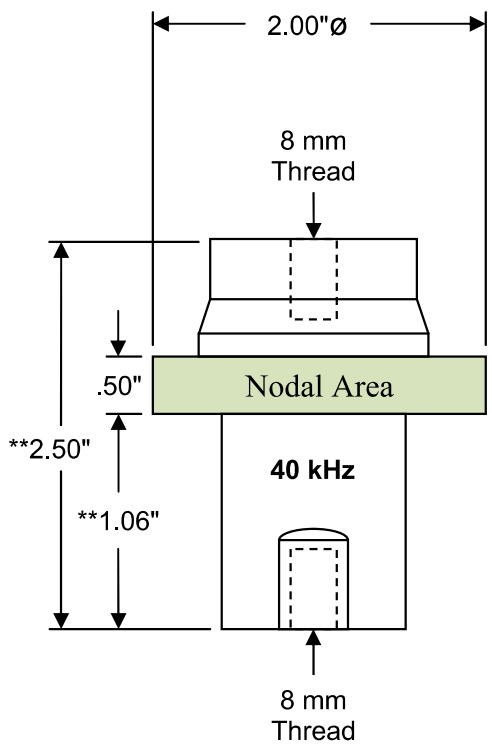

****** REFERENCE DIMENSIONS ONLY

Actual length varies depending on booster gain ratio and final acoustically tuned length.

Generator Kit I/O Connections

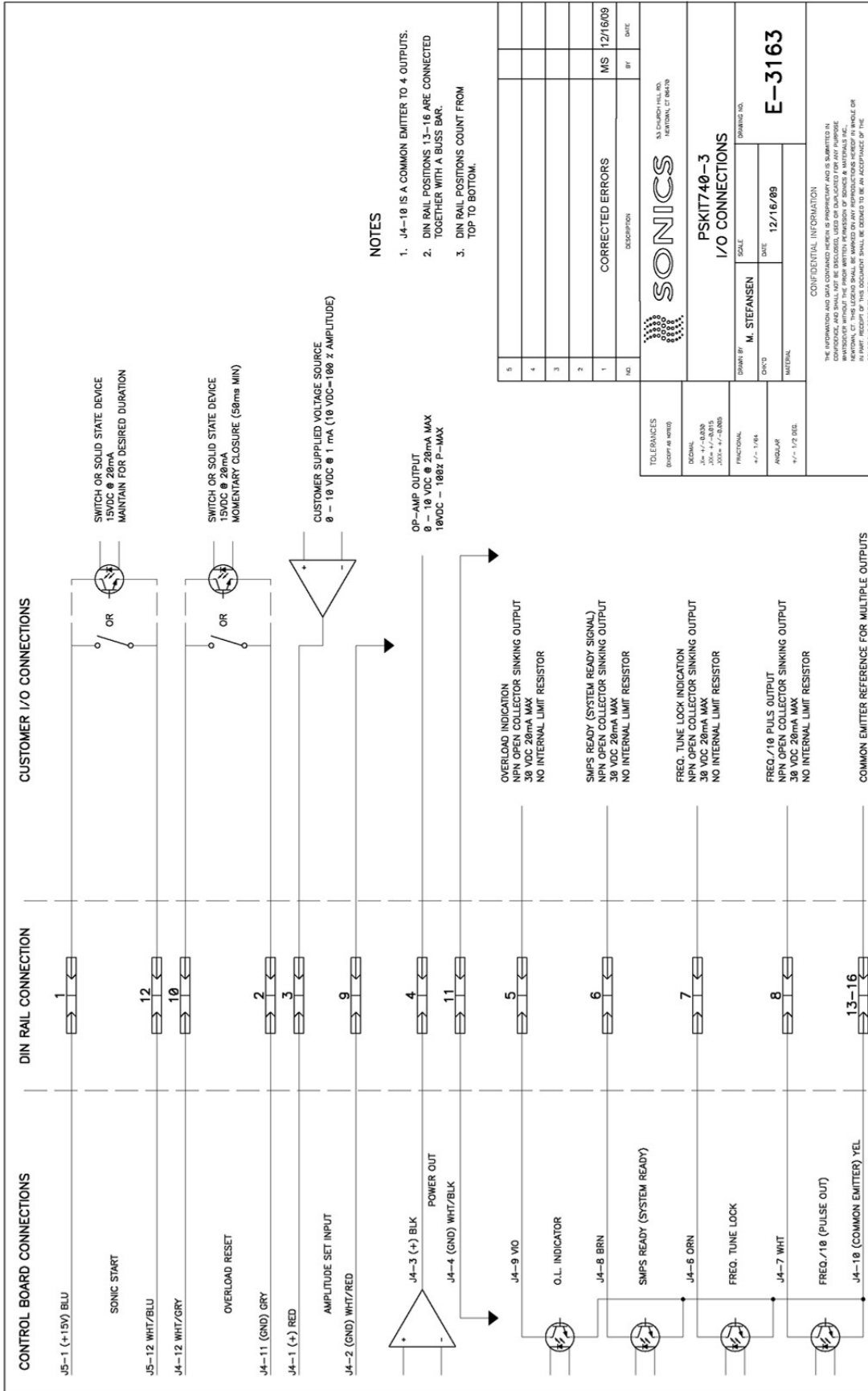

NOTES

- J4-18 IS A COMMON EMITTER TO 4 OUTPUTS.
- DIN RAIL POSITIONS 1,3-16 ARE CONNECTED TOGETHER WITH A BUSS BAR.
- DIN RAIL POSITIONS COUNT FROM TOP TO BOTTOM.

NO	DESCRIPTION	BY	DATE
1	CORRECTED ERRORS	MS	12/16/09
2			
3			
4			
5			

		53 CHURCH HILL RD. NATIONAL, CT 06470	
PSKIT740-3 I/O CONNECTIONS		DRAWING NO.	
DRAWN BY M. STEFANSEN	SCALE	DATE 12/16/09	MATERIAL
TOLERANCES DECIMAL AS SHOWN	ANGULAR 1/2° 1/2 DEG.	CONFIDENTIAL INFORMATION THE INFORMATION AND DATA CONTAINED HEREIN IS PROPRIETARY AND IS SUBMITTED IN CONFIDENCE TO SONICS & MATERIALS, INC. ANY REPRODUCTION OR TRANSMISSION OF THIS INFORMATION WITHOUT THE WRITTEN PERMISSION OF SONICS & MATERIALS, INC. IS STRICTLY PROHIBITED. THIS DOCUMENT SHALL BE RETURNED TO SONICS & MATERIALS, INC. UPON REQUEST. THIS DOCUMENT SHALL BE DEEMED TO BE IN ACCEPTANCE OF THE CONDITIONS SPECIFIED HEREIN.	
FUNCTIONAL ±0.1%		DATE 12/16/09	
DRAWING NO. PSKIT740-3		DATE 12/16/09	
DRAWN BY M. STEFANSEN		DATE 12/16/09	
SCALE		MATERIAL	
CORRECTED ERRORS		MS 12/16/09	
BY		DATE	