

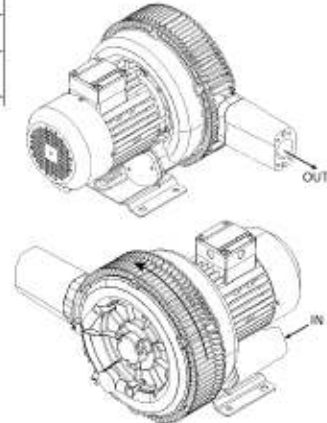

Phase	Model Number	Curve Number	Frequency (Hz)	KW	HP	Max Flow (SCFM)	Max Pressure (H ₂ O)	Max Vacuum (H ₂ O)	Sound Level (dB)	Inlet/Outlet Diameter (Inches)	Voltage	Current (A)	Weight (lbs)
3	AB-202	A111	60Hz	0.85	1.20	64	101	101	68	1.25"	220-275/380-480	3.9Δ/2.3Y	37
			50Hz	0.75	1.00	53	70	70	65		200-240/345-415	3.7Δ/2.1Y	

MODEL NO. : AB-202 DOUBLE STAGE

**Sound db measured at 3ft.

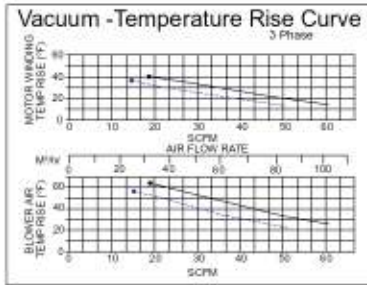
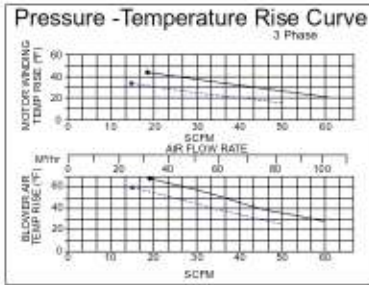
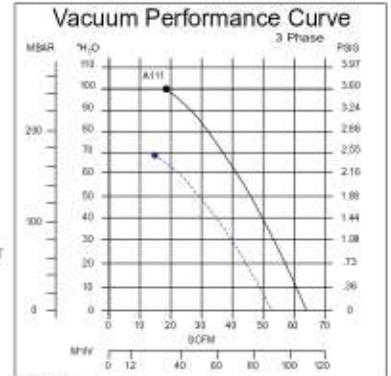
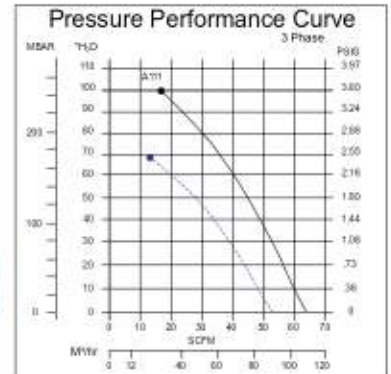
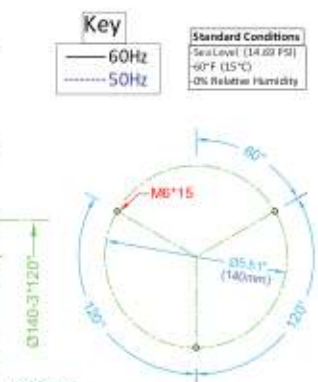
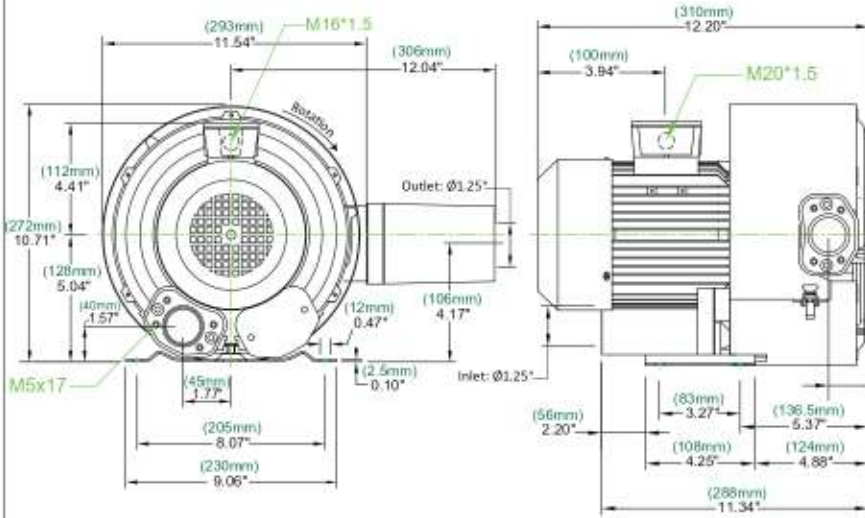

Disclaimer
Ownership of this document and all accompanying information and data including but not limited to all applicable copyrights, trade secrets, patents and other intellectual property, are transferred or disclosed to a third party without express written permission from Atlantic Blowers. Atlantic Blowers makes no representation or warranty, express or implied, with respect to the reuse of the data provided herein, regardless of its format or the means of its transmission. The user accepts the risks "as is", and assumes all risks associated with its use.