

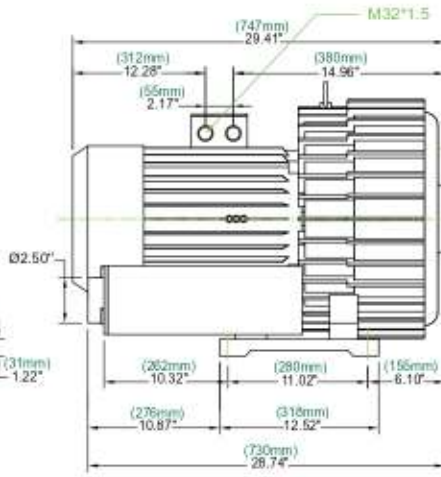

Phase	Model Number	Curve Number	Frequency (Hz)	KW	HP	Max Flow (SCFM)	Max Pressure (H ₂ O)	Max Vacuum (H ₂ O)	Sound Level (dB)	Inlet/Outlet Diameter (Inches)	Voltage	Current (A)	Weight (lbs)
3	AB-1602	A125	60Hz	37.00	50.00	776	236	236	81	2.50"	220-275/380-480	90.00/46.0Y	425
			50Hz	30.80	42.00	647	196	196	77		200-240/345-415	70.00/40.0Y	

MODEL NO. : AB-1602 DOUBLE STAGE

**Sound dB measured at 3ft.

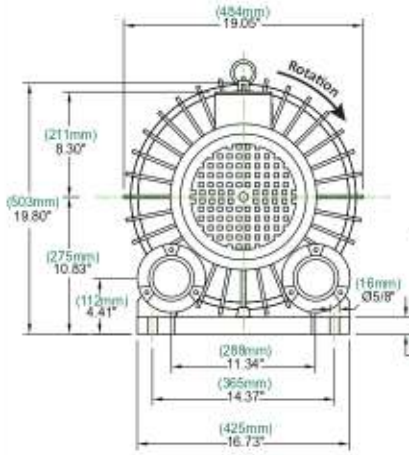

Key
 — 60Hz
 - - - 50Hz

Standard Conditions
 Sea Level (14.69PSI)
 60°F (15°C)
 0% Relative Humidity

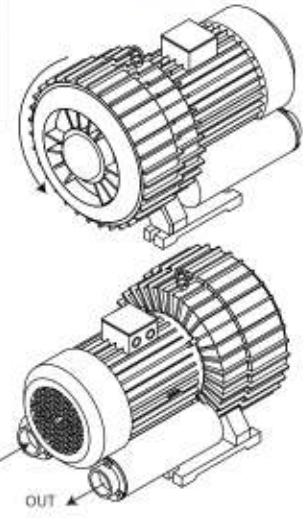
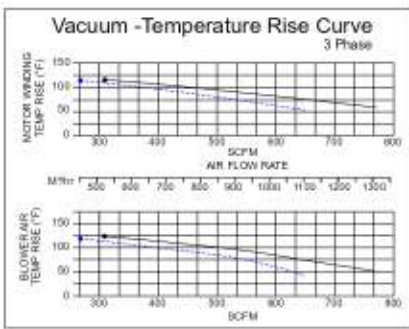
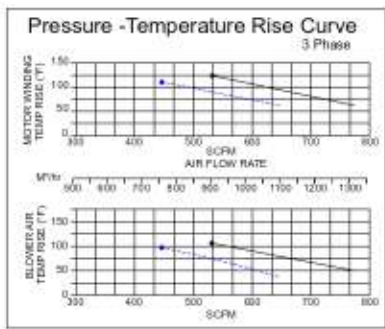
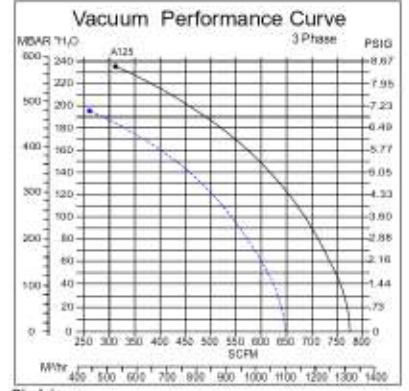
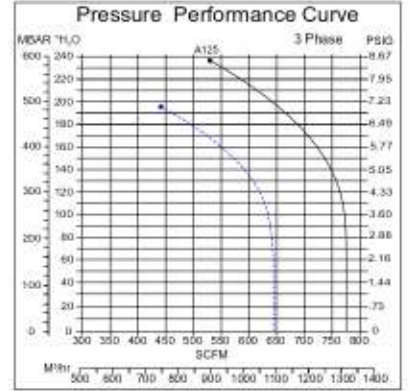

Disclaimer
 Ownership of this document and all accompanying information and data including but not limited to all applicable copyrights, trade secrets, patents and other intellectual property remain the property of Atlantic Blowers and are not to be copied, distributed or reproduced, nor transmitted or disclosed to a third party without express written permission from Atlantic Blowers. Atlantic Blowers makes no representation or warranties, express or implied, with respect to the reuse of the data provided herein regardless of its format or the means of its transmission. The user accepts the data "as is" and warrants all risks associated with its use.