

Gin 90 Series

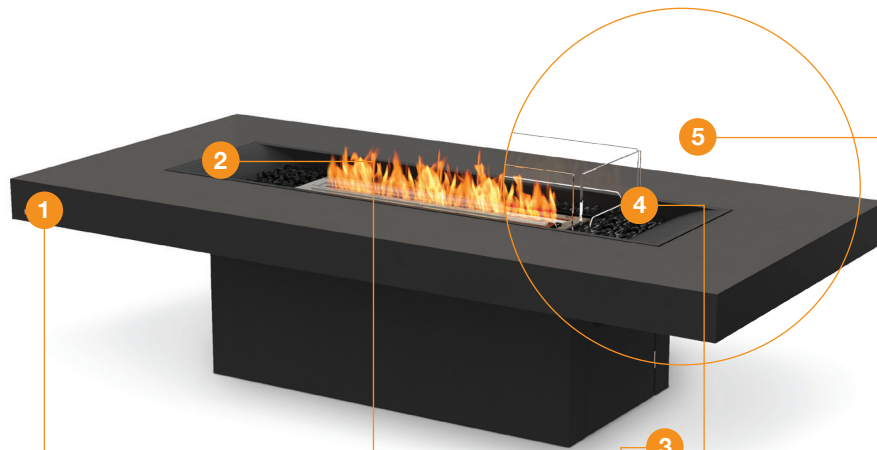

Gin 90 Series Design features



1. Fluid™ Concrete Finish

Incredibly strong yet relatively lightweight, EcoSmart's concrete products incorporate revolutionary Fluid Concrete Technology. Fluid features a stain and impact-resistant barrier that protects the concrete from environmental weathering – even under extreme conditions and long UV exposure.

Premium Teak Wood Finish

Classed as the most premium wood on the planet, teak is the strongest, most durable hardwood available. Teak contains a natural oil which repels water, keeping it from warping, cracking, or becoming brittle. Teak is the perfect material for outdoor furniture.

Surround Colours/Finishes

Our Fires are available in three Fluid Concrete colours or Natural Teak hardwood.



Natural (Gin 90 Bar)



Graphite (Gin 90 Dining)



Bone (Gin 90 Chat)



Teak (Gin 90 Low)

2. Decorative Media

Concrete models come with black glass charcoal.

3. Articulating Feet

Our Fire Pits and Tables feature 360° height-adjustable articulating feet, so you can achieve a perfectly level and stable model before operating the fireplace.

Environmentally-Friendly

Bioethanol fireplaces use an environmentally-friendly, renewable energy source that burns clean and delivers warming heat. You and your guests will enjoy the ambiance and tranquility of a real fire, without the hassles of burning real wood - no more embers, ash, and soot to clean up.

4. Burner Colours

Available with a Stainless Steel or Black Burner.

5. Optional Fire Screen

Pair with a toughened glass fire screen, which stabilises the flame in windy conditions.

Quick & Easy Installation

With no installation or building works required, simply unpack, put into position, and off you go.

Global Compliance

These models comply with existing standards in the USA, Europe, UK and Australia. UL Listed, EN 16647 BSI Certified ACCC Safety Mandate compliant. To comply with EN 16647 the Indoor Safety Tray must be installed before operating indoors.

Included Accessories



Jerry Can with Safety Spout & e-NRG bottle adaptor



Lighting Rod & Lighter



XL Baffles



Black Glass Charcoal

Optional Accessories



Glass Fire Screen

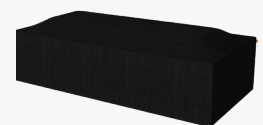

Outdoor Cover







Disclaimer: All product specifications and data are subject to change without notice and believed to be correct at the time of publication. MAD Design Group (MDG), its affiliates, agents, and employees, and all persons acting on its or their behalf (collectively, "MAD Design Group"), disclaim any and all liability for any errors, inaccuracies or incompleteness contained herein or in any other disclosure relating to any product. MDG disclaims any and all liability arising out of the use or application of any product described herein or of any information provided herein to the maximum extent permitted by law. The product specifications do not expand or otherwise modify MDG's terms and conditions of purchase, including but not limited to the warranty expressed therein, which apply to these products. No license, express or implied, by estoppel or otherwise, to any intellectual property rights is granted by this document or by any conduct of MDG. Customers using or selling MDG products not expressly indicated for use in such applications do so entirely at their own risk and agree to fully indemnify MDG for any damages arising or resulting from such use or sale. Please contact authorised personnel from MDG to obtain written terms and conditions regarding products designed for such applications. Images are indicative only.

Gin 90 Bar Specifications

Combining the functionality of a bar-height table with an integrated, elongated flame, Gin 90 Bar fire table is ideal for encouraging casual conversation.

Burner Ventilation and Efficiency*

Dimensions L x W x H mm/in	Compatible Burner	Fuel Capacity	Heats on Average (Indoors)	Thermal Output Net (MAX)	Approx. Burn Time	Minimum Room Size
2272 x 1098 x 1045 89.4 x 43.2 x 41.1	XL900	9 L [2.4 Gals]	Over 60 m ² [645 ft ²]	16 MJ/h 15,000 BTU/h 4.4 kW	8 - 13 hours	110 m ³ [3,884 ft ³]

Application	Indoor ¹ & Outdoor	
Surround Colours	 Natural ESFO.GIN.90.B.NA	 Graphite ESFO.GIN.90.B.GH
	 Bone ESFO.GIN.90.B.BO	 Teak ESFO.GIN.90.B.TN
Burner Colours	 Stainless Steel	 Black
Materials	Fluid Concrete or Teak Wood Surround, Grade 304 Stainless Steel Burner, with optional Black Ceramic Coating	
Approx. Weight	Concrete 221.2kg [486.7lbs] Teak 124.7kg [274.4lbs] Weight includes burner and black glass charcoal.	
Fuel Type	e-NRG Bioethanol / e-NRG.com	

Line drawings show concrete models with the optional Glass Fire Screen accessory.

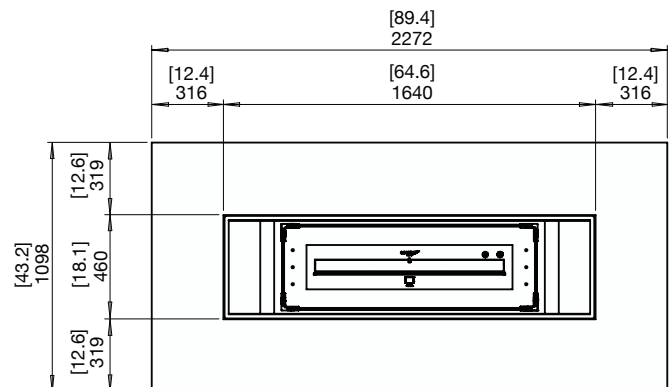
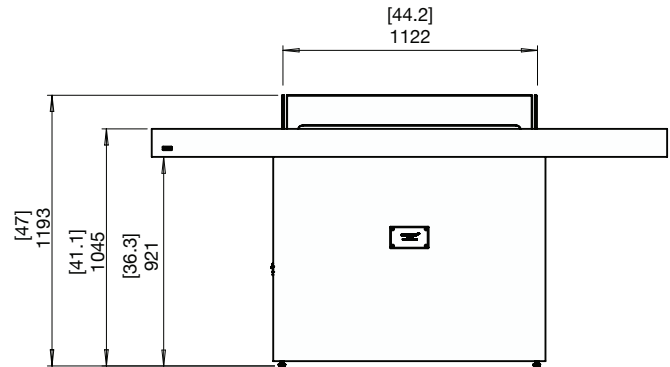

*These values are indicative only and may vary depending on the model purchased, installation, and the seasonal resource used to manufacture e-NRG.

This model comes with fixing brackets for permanently locating into a fixed position.

¹For Indoor Use, additional parts are required. Your chosen application is the ONLY application the model can be used in due to modified configuration of the model. Please advise your Sales Representative at time of purchase so that the product can be configured accordingly.

This model complies with existing standards in the USA, Europe, UK and Australia. UL Listed, EN 16647 BSI Certified ACCC Safety Mandate compliant. To comply with EN 16647 the Indoor Safety Tray must be installed before operating indoors.

FOR MORE INFORMATION PLEASE REFERENCE THE CLEARANCE & INSTALLATION MANUAL



















Disclaimer: All product specifications and data are subject to change without notice and believed to be correct at the time of publication. MAD Design Group (MDG), its affiliates, agents, and employees, and all persons acting on its or their behalf (collectively, "MAD Design Group"), disclaim any and all liability for any errors, inaccuracies or incompleteness contained herein or in any other disclosure relating to any product. MDG disclaims any and all liability arising out of the use or application of any product described herein or of any information provided herein to the maximum extent permitted by law. The product specifications do not expand or otherwise modify MDG's terms and conditions of purchase, including but not limited to the warranty expressed therein, which apply to these products. No license, express or implied, by estoppel or otherwise, to any intellectual property rights is granted by this document or by any conduct of MDG. Customers using or selling MDG products not expressly indicated for use in such applications do so entirely at their own risk and agree to fully indemnify MDG for any damages arising or resulting from such use or sale. Please contact authorised personnel from MDG to obtain written terms and conditions regarding products designed for such applications. Images are indicative only.

Gin 90 Dining Specifications

A clever, dual-purpose fire dining table with room for dining chairs, the Gin 90 Dining features the XL900 Burner as its centrepiece.

Burner Ventilation and Efficiency*

Dimensions L x W x H mm/in	Compatible Burner	Fuel Capacity	Heats on Average (Indoors)	Thermal Output Net (MAX)	Approx. Burn Time	Minimum Room Size
2272 x 1098 x 745 89.4 x 43.2 x 29.3	XL900	9 L [2.4 Gals]	Over 60 m ² [645 ft ²]	16 MJ/h 15,000 BTU/h 4.4 kW	8 - 13 hours	110 m ³ [3,884 ft ³]

Application	Indoor ¹ & Outdoor				
Surround Colours	<table border="0"> <tr> <td> Natural ESF.O.GIN.90.D.NA</td> <td> Graphite ESF.O.GIN.90.D.GH</td> </tr> <tr> <td> Bone ESF.O.GIN.90.D.BO</td> <td> Teak ESF.O.GIN.90.D.TN</td> </tr> </table>	 Natural ESF.O.GIN.90.D.NA	 Graphite ESF.O.GIN.90.D.GH	 Bone ESF.O.GIN.90.D.BO	 Teak ESF.O.GIN.90.D.TN
 Natural ESF.O.GIN.90.D.NA	 Graphite ESF.O.GIN.90.D.GH				
 Bone ESF.O.GIN.90.D.BO	 Teak ESF.O.GIN.90.D.TN				
Burner Colours	<table border="0"> <tr> <td> Stainless Steel</td> <td> Black</td> </tr> </table>	 Stainless Steel	 Black		
 Stainless Steel	 Black				
Materials	Fluid Concrete or Teak Wood Surround, Grade 304 Stainless Steel Burner, with optional Black Ceramic Coating				
Approx. Weight	Concrete 203.2kg [447.1lbs] Teak 119.7kg [263.4lbs] Weight includes burner and black glass charcoal.				
Fuel Type	e-NRG Bioethanol / e-NRG.com				

Line drawings show concrete models with the optional Glass Fire Screen accessory.

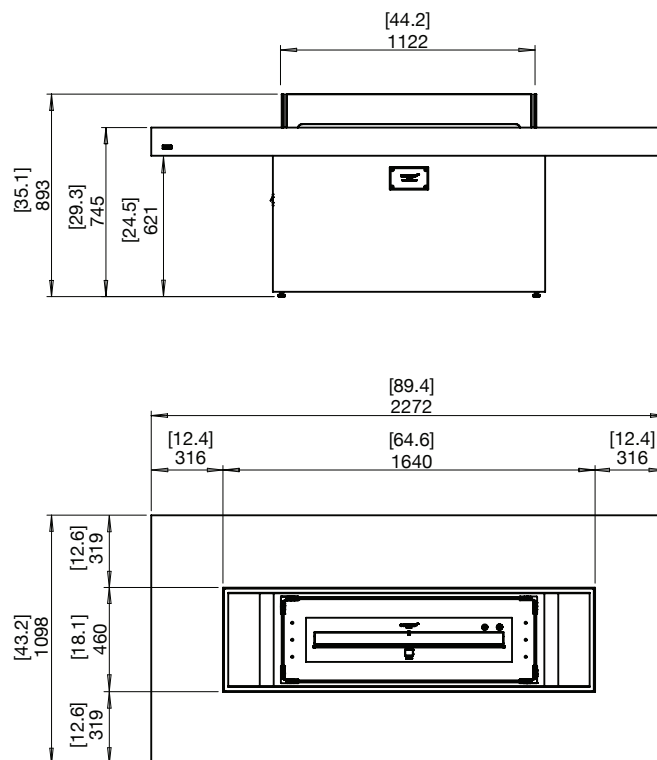

*These values are indicative only and may vary depending on the model purchased, installation, and the seasonal resource used to manufacture e-NRG.

This model comes with fixing brackets for permanently locating into a fixed position.

¹For Indoor Use, additional parts are required. Your chosen application is the ONLY application the model can be used in due to modified configuration of the model. Please advise your Sales Representative at time of purchase so that the product can be configured accordingly.

This model complies with existing standards in the USA, Europe, UK and Australia. UL Listed, EN 16647 BSI Certified ACCC Safety Mandate compliant. To comply with EN 16647 the Indoor Safety Tray must be installed before operating indoors.

FOR MORE INFORMATION PLEASE REFERENCE THE CLEARANCE & INSTALLATION MANUAL







Disclaimer: All product specifications and data are subject to change without notice and believed to be correct at the time of publication. MAD Design Group (MDG), its affiliates, agents, and employees, and all persons acting on its or their behalf (collectively, "MAD Design Group"), disclaim any and all liability for any errors, inaccuracies or incompleteness contained herein or in any other disclosure relating to any product. MDG disclaims any and all liability arising out of the use or application of any product described herein or of any information provided herein to the maximum extent permitted by law. The product specifications do not expand or otherwise modify MDG's terms and conditions of purchase, including but not limited to the warranty expressed therein, which apply to these products. No license, express or implied, by estoppel or otherwise, to any intellectual property rights is granted by this document or by any conduct of MDG. Customers using or selling MDG products not expressly indicated for use in such applications do so entirely at their own risk and agree to fully indemnify MDG for any damages arising or resulting from such use or sale. Please contact authorised personnel from MDG to obtain written terms and conditions regarding products designed for such applications. Images are indicative only.

Gin 90 Chat Specifications

The warmth and aesthetic appeal of an open flame combined with a cleverly engineered piece of fire furniture are the hallmarks of the Gin 90 Chat fire pit table.

Burner Ventilation and Efficiency*

Dimensions L x W x H mm/in	Compatible Burner	Fuel Capacity	Heats on Average (Indoors)	Thermal Output Net (MAX)	Approx. Burn Time	Minimum Room Size
2272 x 1098 x 595 89.4 x 43.2 x 23.4	XL900	9 L [2.4 Gals]	Over 60 m ² [645 ft ²]	16 MJ/h 15,000 BTU/h 4.4 kW	8 - 13 hours	110 m ³ [3,884 ft ³]

Application	Indoor ¹ & Outdoor
Surround Colours	<div style="display: flex; justify-content: space-around;"> <div style="text-align: center;">  Natural ESF.O.GIN.90.C.NA </div> <div style="text-align: center;">  Graphite ESF.O.GIN.90.C.GH </div> </div> <div style="display: flex; justify-content: space-around; margin-top: 10px;"> <div style="text-align: center;">  Bone ESF.O.GIN.90.C.BO </div> <div style="text-align: center;">  Teak ESF.O.GIN.90.C.TN </div> </div>
Burner Colours	<div style="display: flex; justify-content: space-around;"> <div style="text-align: center;">  Stainless Steel </div> <div style="text-align: center;">  Black </div> </div>
Materials	Fluid Concrete or Teak Wood Surround, Grade 304 Stainless Steel Burner, with optional Black Ceramic Coating
Approx. Weight	Concrete 188.8kg [415.4lbs] Teak 110.7kg [243.6lbs] Weight includes burner and black glass charcoal.
Fuel Type	e-NRG Bioethanol / e-NRG.com

Line drawings show concrete models with the optional Glass Fire Screen accessory.

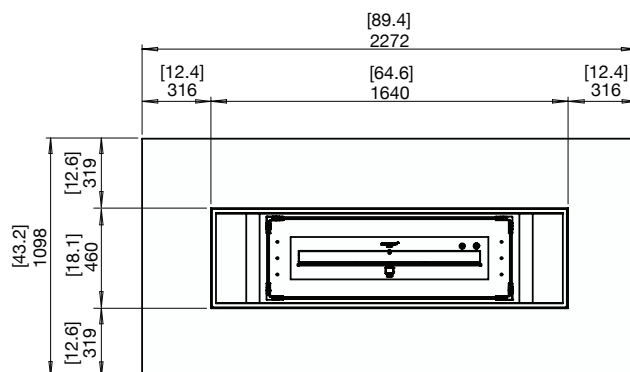
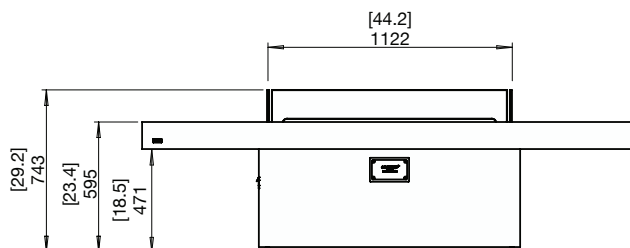

*These values are indicative only and may vary depending on the model purchased, installation, and the seasonal resource used to manufacture e-NRG.

This model comes with fixing brackets for permanently locating into a fixed position.

¹For Indoor Use, additional parts are required. Your chosen application is the ONLY application the model can be used in due to modified configuration of the model. Please advise your Sales Representative at time of purchase so that the product can be configured accordingly.

This model complies with existing standards in the USA, Europe, UK and Australia. UL Listed, EN 16647 BSI Certified ACCC Safety Mandate compliant. To comply with EN 16647 the Indoor Safety Tray must be installed before operating indoors.

FOR MORE INFORMATION PLEASE REFERENCE THE CLEARANCE & INSTALLATION MANUAL







Disclaimer: All product specifications and data are subject to change without notice and believed to be correct at the time of publication. MAD Design Group (MDG), its affiliates, agents, and employees, and all persons acting on its or their behalf (collectively, "MAD Design Group"), disclaim any and all liability for any errors, inaccuracies or incompleteness contained herein or in any other disclosure relating to any product. MDG disclaims any and all liability arising out of the use or application of any product described herein or of any information provided herein to the maximum extent permitted by law. The product specifications do not expand or otherwise modify MDG's terms and conditions of purchase, including but not limited to the warranty expressed therein, which apply to these products. No license, express or implied, by estoppel or otherwise, to any intellectual property rights is granted by this document or by any conduct of MDG. Customers using or selling MDG products not expressly indicated for use in such applications do so entirely at their own risk and agree to fully indemnify MDG for any damages arising or resulting from such use or sale. Please contact authorised personnel from MDG to obtain written terms and conditions regarding products designed for such applications. Images are indicative only.

Gin 90 Low Specifications

True to its name, the Gin 90 Low table is a low-set fire pit table that's been created to be a multi-functional piece of furniture for indoors or outside.

Burner Ventilation and Efficiency*

Dimensions L x W x H mm/in	Compatible Burner	Fuel Capacity	Heats on Average (Indoors)	Thermal Output Net (MAX)	Approx. Burn Time	Minimum Room Size
2272 x 1098 x 345 89.4 x 43.2 x 13.6	XL900	9 L [2.4 Gals]	Over 60 m ² [645 ft ²]	16 MJ/h 15,000 BTU/h 4.4 kW	8 - 13 hours	110 m ³ [3,884 ft ³]

Application	Indoor ¹ & Outdoor
Surround Colours	<div style="display: flex; justify-content: space-around;"> <div style="text-align: center;">  Natural ESF.O.GIN.90.L.NA </div> <div style="text-align: center;">  Graphite ESF.O.GIN.90.L.GH </div> </div> <div style="display: flex; justify-content: space-around; margin-top: 10px;"> <div style="text-align: center;">  Bone ESF.O.GIN.90.L.BO </div> <div style="text-align: center;">  Teak ESF.O.GIN.90.L.TN </div> </div>
Burner Colours	<div style="display: flex; justify-content: space-around;"> <div style="text-align: center;">  Stainless Steel </div> <div style="text-align: center;">  Black </div> </div>
Materials	Fluid Concrete or Teak Wood Surround, Grade 304 Stainless Steel Burner, with optional Black Ceramic Coating
Approx. Weight	Concrete 171.1kg [376.5lbs] Teak 91.7kg [201.8lbs] Weight includes burner and black glass charcoal.
Fuel Type	e-NRG Bioethanol / e-NRG.com

Line drawings show concrete models with the optional Glass Fire Screen accessory.

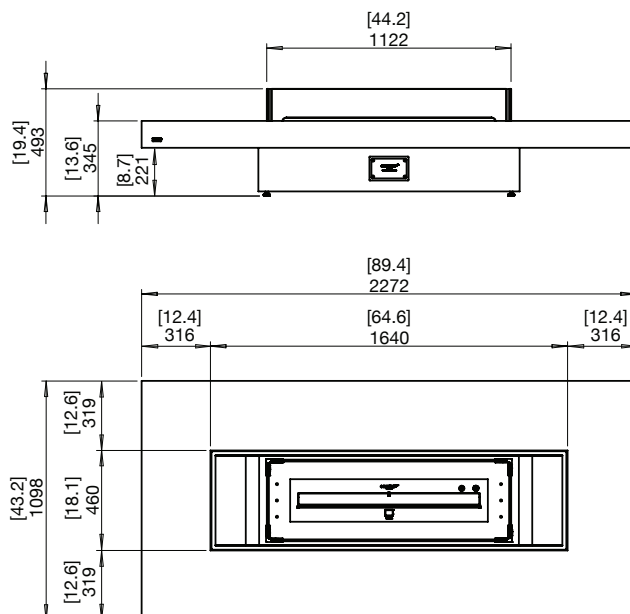

*These values are indicative only and may vary depending on the model purchased, installation, and the seasonal resource used to manufacture e-NRG.

This model comes with fixing brackets for permanently locating into a fixed position.

¹For Indoor Use, additional parts are required. Your chosen application is the ONLY application the model can be used in due to modified configuration of the model. Please advise your Sales Representative at time of purchase so that the product can be configured accordingly.

This model complies with existing standards in the USA, Europe, UK and Australia. UL Listed, EN 16647 BSI Certified ACCC Safety Mandate compliant. To comply with EN 16647 the Indoor Safety Tray must be installed before operating indoors.

FOR MORE INFORMATION PLEASE REFERENCE THE CLEARANCE & INSTALLATION MANUAL

Disclaimer: All product specifications and data are subject to change without notice and believed to be correct at the time of publication. MAD Design Group (MDG), its affiliates, agents, and employees, and all persons acting on its or their behalf (collectively, "MAD Design Group"), disclaim any and all liability for any errors, inaccuracies or incompleteness contained herein or in any other disclosure relating to any product. MDG disclaims any and all liability arising out of the use or application of any product described herein to the maximum extent permitted by law. The product specifications do not expand or otherwise modify MDG's terms and conditions of purchase, including but not limited to the warranty expressed therein, which apply to these products. No license, express or implied, by estoppel or otherwise, to any intellectual property rights is granted by this document or by any conduct of MDG. Customers using or selling MDG products not expressly indicated for use in such applications do so entirely at their own risk and agree to fully indemnify MDG for any damages arising or resulting from such use or sale. Please contact authorised personnel from MDG to obtain written terms and conditions regarding products designed for such applications. Images are indicative only.