

# Dell EMC PowerEdge R440

## Installation and Service Manual

## Notes, cautions, and warnings

 **NOTE:** A NOTE indicates important information that helps you make better use of your product.

 **CAUTION:** A CAUTION indicates either potential damage to hardware or loss of data and tells you how to avoid the problem.

 **WARNING:** A WARNING indicates a potential for property damage, personal injury, or death.

<b>Chapter 1: Dell EMC PowerEdge R440 system overview</b>	<b>7</b>
Front view of the system	7
Left control panel view	10
Right control panel view	12
Drive indicator codes	14
Back view of the system	15
NIC indicator codes	17
Power supply unit indicator codes	17
LCD panel	18
Viewing Home screen	19
Setup menu	19
View menu	19
Locating the Service Tag of your system	20
System Label Information	21
<b>Chapter 2: Initial system setup and configuration</b>	<b>22</b>
Setting up your system	22
iDRAC configuration	22
Options to set up iDRAC IP address	22
Log in to iDRAC	23
Options to install the operating system	23
Methods to download firmware and drivers	23
Downloading drivers and firmware	24
<b>Chapter 3: Installing and removing system components</b>	<b>25</b>
Safety instructions	25
Before working inside your system	26
After working inside your system	26
Recommended tools	26
Optional front bezel	26
Removing the front bezel	26
Installing the front bezel	27
System cover	28
Removing the system cover	28
Installing the system cover	29
Inside the system	30
Backplane cover	31
Removing the backplane cover	31
Installing the backplane cover	32
Air shroud	34
Removing the air shroud	34
Installing the air shroud	34
Cooling fans	35
Removing the cooling fan	35

Installing cooling fan.....	36
Intrusion switch.....	37
Removing the intrusion switch.....	37
Installing the intrusion switch.....	38
Drives.....	39
Removing a drive blank.....	39
Installing a drive blank.....	39
Removing a 2.5-inch drive from a 3.5-inch drive adapter.....	40
Installing a 2.5-inch drive into a 3.5-inch drive adapter.....	41
Removing a 3.5-inch drive adapter from a 3.5-inch drive carrier.....	41
Installing a 3.5-inch drive adapter into the 3.5-inch drive carrier.....	42
Removing a hard drive.....	43
Installing a hard drive.....	44
Removing the drive from the drive carrier.....	45
Installing a drive into the drive carrier.....	46
System memory.....	46
System memory guidelines.....	46
General memory module installation guidelines.....	48
Mode-specific guidelines.....	48
Removing a memory module.....	51
Installing a memory module.....	51
Processors and heat sinks.....	52
Removing a processor and heat sink module.....	52
Installing a processor and heat sink module.....	53
Removing the processor from the processor and heat sink module.....	54
Installing the processor into a processor and heat sink module.....	55
Internal PERC riser.....	57
Removing the internal PERC riser.....	57
Installing the internal PERC riser.....	58
Removing the PERC card from the internal PERC riser.....	60
Installing PERC card into the internal PERC riser.....	60
Expansion cards and expansion card risers.....	61
Expansion card installation guidelines.....	61
Expansion bus specifications.....	66
Installing an expansion card riser.....	66
Removing an expansion card riser.....	67
Removing the expansion card from the expansion card riser.....	69
Installing the expansion card into the expansion card riser.....	72
Internal PERC riser.....	74
M.2 SSD module.....	78
Installing the M.2 SSD module.....	78
Removing the M.2 SSD module.....	79
Optional MicroSD or vFlash card.....	80
Removing the MicroSD card.....	80
Installing the MicroSD card.....	81
Optional IDSDM or vFlash module.....	82
Removing the optional IDSDM or vFlash card.....	82
Installing optional IDSDM or vFlash card.....	83
LOM riser card.....	84
Removing the LOM riser card.....	84

Installing the LOM riser card.....	85
Hard drive backplane.....	86
Hard drive backplane details.....	86
Installing the hard drive backplane .....	87
Removing the hard drive backplane .....	88
Cable routing.....	89
System battery .....	93
Replacing the system battery.....	93
Optional internal USB memory key.....	94
Replacing the optional internal USB memory key.....	94
Optical drive (optional).....	95
Removing the optical drive.....	95
Installing the optical drive.....	95
Power supply units.....	96
Removing a power supply unit blank.....	96
Installing a power supply unit blank.....	97
Removing a power supply unit.....	97
Installing a power supply unit.....	98
Removing a non-redundant cabled AC power supply unit.....	99
Installing a non-redundant cabled AC power supply unit.....	100
Power interposer board.....	101
Removing power interposer board.....	101
Installing power interposer board.....	101
Control panel.....	102
Removing the left control panel.....	102
Installing the left control panel.....	103
Removing the right control panel.....	104
Installing the right control panel.....	105
System board.....	106
Removing the system board.....	106
Installing the system board.....	107
Trusted Platform Module.....	110
Upgrading the Trusted Platform Module.....	110
Initializing TPM for BitLocker users.....	111
Initializing the TPM 1.2 for TXT users.....	111
<b>Chapter 4: Jumpers and connectors .....</b>	<b>112</b>
System board jumpers and connectors.....	112
System board jumper settings.....	113
Disabling forgotten password.....	114
<b>Chapter 5: System diagnostics.....</b>	<b>115</b>
Dell Embedded System Diagnostics.....	115
Running the Embedded System Diagnostics from Boot Manager.....	115
Running the Embedded System Diagnostics from the Dell Lifecycle Controller.....	115
System diagnostic controls.....	115
<b>Chapter 6: Getting help.....</b>	<b>117</b>
Contacting Dell EMC.....	117

Documentation feedback.....	117
Accessing system information by using QRL.....	117
Quick Resource Locator for Dell EMC PowerEdge R440 system.....	118
Receiving automated support with SupportAssist .....	118
Recycling or End-of-Life service information.....	118

**Chapter 7: Documentation resources..... 119**

# Dell EMC PowerEdge R440 system overview

The Dell EMC PowerEdge R440 system is a 1U, dual socket rack system supports up to:

- Two Intel Xeon Scalable Processors
- 16 DIMM slots
- 4 x 3.5-inch drives, 8 x 2.5-inch drives, or 10 x 2.5-inch drives
- Four NVMe drives on 10 x 2.5-inch drive system
- Two redundant power supply units (PSU) or single cabled PSU (no longer offering)

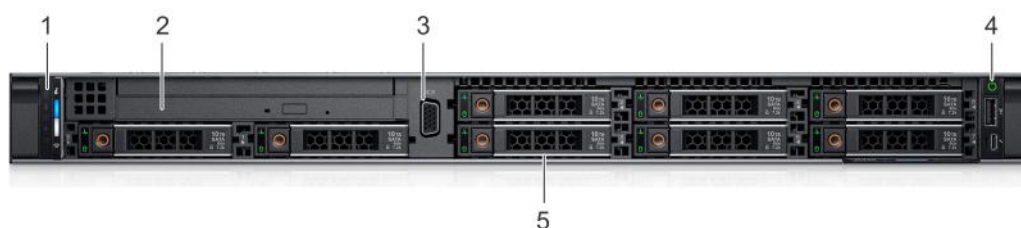
**i** **NOTE:** All instances of SAS, SATA hard drives and SSDs are referred to as drives in this document, unless specified otherwise.

## Topics:

- [Front view of the system](#)
- [Back view of the system](#)
- [LCD panel](#)
- [Locating the Service Tag of your system](#)
- [System Label Information](#)

## Front view of the system

The front view displays the features available on the front of the system.




**Figure 1. Front view of 8 x 2.5-inch drive system**

**Table 1. Features available on the front of the system**

Item	Ports, panels, and slots	Icon	Description
1	Left control panel	N/A	<p>Contains the system health and system ID, status LED, and the iDRAC Quick Sync 2 (wireless) indicator.</p> <p><b>i</b> <b>NOTE:</b> The iDRAC Quick Sync 2 indicator is available only on certain configurations.</p> <ul style="list-style-type: none"> <li>• Status LED: Enables you to identify any failed hardware components. There are up to five status LEDs and an overall system health LED (Chassis health and system ID) bar. For more information, see the <a href="#">Status LED indicators</a> section.</li> <li>• Quick Sync 2 (wireless): Indicates a Quick Sync enabled system. The Quick Sync feature is optional. This feature allows management of the system by using mobile devices. This feature aggregates hardware or firmware inventory and various system level diagnostic and error information that can be used in troubleshooting the system. For more information, see the <i>Integrated Dell</i></li> </ul>


**Table 1. Features available on the front of the system (continued)**

Item	Ports, panels, and slots	Icon	Description
			<i>Remote Access Controller User's Guide</i> at <a href="http://www.dell.com/poweredgemanuals">www.dell.com/poweredgemanuals</a> .
2	Optical drive (optional)	N/A	One optional slim SATA DVD-ROM drive or DVD+/-RW drive.
3	VGA port		Enables you to connect a display device to the system. For more information, see the <i>Dell EMC PowerEdge R440 Technical Specifications</i> on the product documentation page.
4	Right control panel	N/A	Contains the power button, USB port, iDRAC Direct micro port, and the iDRAC Direct status LED.
5	Drive slots	N/A	Enable you to install drives that are supported on your system. For more information,



**Figure 2. Front view of 4 x 3.5-inch drive system**

**Table 2. Features available on the front of the system**

Item	Ports, panels, and slots	Icon	Description
1	Left control panel	N/A	Contains the system health and system ID, status LED, and the iDRAC Quick Sync 2 (wireless) indicator.  <b>NOTE:</b> The iDRAC Quick Sync 2 indicator is available only on certain configurations. <ul style="list-style-type: none"> <li>• Status LED: Enables you to identify any failed hardware components. There are up to five status LEDs and an overall system health LED (Chassis health and system ID) bar. For more information, see the <a href="#">Status LED indicators</a> section.</li> <li>• Quick Sync 2 (wireless): Indicates a Quick Sync enabled system. The Quick Sync feature is optional. This feature allows management of the system by using mobile devices. This feature aggregates hardware or firmware inventory and various system level diagnostic and error information that can be used in troubleshooting the system. For more information, see the <i>Integrated Dell Remote Access Controller User's Guide</i> at <a href="http://www.dell.com/poweredgemanuals">www.dell.com/poweredgemanuals</a>.</li> </ul>
2	Drive slots	N/A	Enable you to install drives that are supported on your system. For more information, see the <i>Dell EMC PowerEdge R440 Technical Specifications</i> on the product documentation page.
3	Optical drive (optional)	N/A	One optional slim SATA DVD-ROM drive or DVD+/-RW drive.
4	VGA port		Enables you to connect a display device to the system. For more information, see the <i>Dell EMC PowerEdge R440 Technical Specifications</i> on the product documentation page.
5	Right control panel	N/A	Contains the power button, USB port, iDRAC Direct micro port, and the iDRAC Direct status LED.




**Table 2. Features available on the front of the system (continued)**

Item	Ports, panels, and slots	Icon	Description
6	Information Tag	N/A	The Information Tag is a slide-out label panel that contains system information such as Service Tag, NIC, MAC address, and so on. If you have opted for the secure default access to iDRAC, the Information tag also contains the iDRAC secure default password.



**Figure 3. Front view of 10 x 2.5-inch drive system**

**Table 3. Features available on the front of the system**

Item	Ports, panels, and slots	Icon	Description
1	Left control panel	N/A	<p>Contains the system health and system ID, status LED, and the iDRAC Quick Sync 2 (wireless) indicator.</p> <p><b>i NOTE:</b> The iDRAC Quick Sync 2 indicator is available only on certain configurations.</p> <ul style="list-style-type: none"> <li>• Status LED: Enables you to identify any failed hardware components. There are up to five status LEDs and an overall system health LED (Chassis health and system ID) bar. For more information, see the <a href="#">Status LED indicators</a> section.</li> <li>• Quick Sync 2 (wireless): Indicates a Quick Sync enabled system. The Quick Sync feature is optional. This feature allows management of the system by using mobile devices. This feature aggregates hardware or firmware inventory and various system level diagnostic and error information that can be used in troubleshooting the system. For more information, see the <i>Integrated Dell Remote Access Controller User's Guide</i> at <a href="http://www.dell.com/poweredgemanuals">www.dell.com/poweredgemanuals</a>.</li> </ul>
2	Drive slots	N/A	Enable you to install drives that are supported on your system. For more information, see the <i>Dell EMC PowerEdge R440 Technical Specifications</i> on the product documentation page.
3	VGA port		Enables you to connect a display device to the system.
4	Right control panel	N/A	Contains the power button, USB port, iDRAC Direct micro port, and the iDRAC Direct status LED. see the <i>Dell EMC PowerEdge R440 Technical Specifications</i> on the product documentation page.
5	Information Tag	N/A	The Information Tag is a slide-out label panel that contains system information such as Service Tag, NIC, MAC address, and so on. If you have opted for the secure default access to iDRAC, the Information tag also contains the iDRAC secure default password.

## Left control panel view

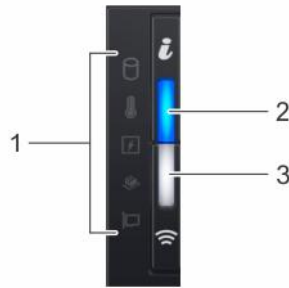


Figure 4. Left control panel with optional iDRAC Quick Sync 2.0 indicator

Table 4. Left control panel

Item	Indicator, button, or connector	Icon	Description
1	Status LED indicators	N/A	Indicate the status of the system. For more information, see the <a href="#">Status LED indicators</a> section.
2	System health and system ID indicator		Indicates the system health.
3	iDRAC Quick Sync 2 wireless indicator (optional) <b>NOTE:</b> iDRAC Quick Sync 2 wireless indicator is available only on certain configurations.		Indicates if the iDRAC Quick Sync 2 wireless option is activated. The Quick Sync 2 feature allows management of the system using mobile devices. This feature aggregates hardware/firmware inventory and various system level diagnostic/error information that can be used in troubleshooting the system. You can access system inventory, Dell Lifecycle Controller logs or system logs, system health status, and also configure iDRAC, BIOS, and networking parameters. You can also launch the virtual Keyboard, Video, and Mouse (KVM) viewer and virtual Kernel based Virtual Machine (KVM), on a supported mobile device. For more information, see the <i>Integrated Dell Remote Access Controller User's Guide</i> at <a href="http://www.dell.com/poweredgemanuals">www.dell.com/poweredgemanuals</a>




## Status LED indicators

**NOTE:** The indicators display solid amber if any error occurs.

Table 5. Status LED indicators and descriptions

Icon	Description	Condition	Corrective action
	Drive indicator	The indicator turns solid amber, if there is a drive error.	<ul style="list-style-type: none"> <li>Check the System event log to determine if the drive has an error.</li> <li>Run the appropriate Online Diagnostics test. Restart the system, and run embedded diagnostics (ePSA).</li> <li>If the drives are configured in a RAID array, restart the system, and enter the host adapter configuration utility program.</li> </ul>
	Temperature indicator	The indicator turns solid amber, if the system experiences a thermal error (for example, the ambient temperature is out of range or there is a fan failure).	<p>Ensure that none of the following conditions exist:</p> <ul style="list-style-type: none"> <li>A cooling fan has been removed or has failed.</li> <li>System cover, air shroud, or back filler bracket is removed.</li> <li>Ambient temperature is too high.</li> <li>External airflow is obstructed.</li> </ul> <p>If the problem persists, see <a href="#">Getting help</a>.</p>

**Table 5. Status LED indicators and descriptions (continued)**

Icon	Description	Condition	Corrective action
	Electrical indicator	The indicator turns solid amber, if the system experiences an electrical error (for example, voltage out of range, or a failed power supply unit (PSU) or voltage regulator).	Check the System event log or system messages for the specific issue. If it is due to a problem with the PSU, check the LED on the PSU. Reseat the PSU. If the problem persists, see <a href="#">Getting help</a> .
	Memory indicator	The indicator turns solid amber if a memory error occurs.	Check the System event log or system messages for the location of the failed memory. Reseat the memory module. If the problem persists, see <a href="#">Getting help</a> .
	PCIe indicator	The indicator turns solid amber, if a PCIe card experiences an error.	Restart the system. Update any required drivers for the PCIe card. Reinstall the card. If the problem persists, see <a href="#">Getting help</a> .

**NOTE:** For more information about the supported PCIe cards, see [Expansion card installation guidelines](#).

## System health and system ID indicator codes

The system health and system ID indicator is located on the left control panel of your system.



**Figure 5. System health and system ID indicators**

**Table 6. System health and system ID indicator codes**

System health and system ID indicator code	Condition
Solid blue	Indicates that the system is turned on, system is healthy, and system ID mode is not active. Press the system health and system ID button to switch to system ID mode.
Blinking blue	Indicates that the system ID mode is active. Press the system health and system ID button to switch to system health mode.
Solid amber	Indicates that the system is in fail-safe mode. If the problem persists, see the Getting help section.
Blinking amber	Indicates that the system is experiencing a fault. Check the System Event Log or the LCD panel, if available on the bezel, for specific error messages.  For more information about error messages, see the <i>Event and Error Message Reference Guide for 14th Generation Dell EMC PowerEdge Servers</i> at <a href="http://www.dell.com/qr1">www.dell.com/qr1</a> .

## iDRAC Quick Sync 2 indicator codes

iDRAC Quick Sync 2 module (optional) is located on the left control panel of your system.



**Figure 6. iDRAC Quick Sync 2 indicators**

**Table 7. iDRAC Quick Sync 2 indicators and descriptions**


iDRAC Quick Sync 2 indicator code	Condition	Corrective action
Off (default state)	Indicates that the iDRAC Quick Sync 2 feature is turned off. Press the iDRAC Quick Sync 2 button to turn on the iDRAC Quick Sync 2 feature.	If the LED fails to turn on, reseal the left control panel flex cable and check. If the problem persists, see the <a href="#">Getting help</a> section.
Solid white	Indicates that iDRAC Quick Sync 2 is ready to communicate. Press the iDRAC Quick Sync 2 button to turn off.	If the LED fails to turn off, restart the system. If the problem persists, see the <a href="#">Getting help</a> section.
Blinks white rapidly	Indicates data transfer activity.	If the indicator continues to blink indefinitely, see the <a href="#">Getting help</a> section.
Blinks white slowly	Indicates that firmware update is in progress.	If the indicator continues to blink indefinitely, see the <a href="#">Getting help</a> section.
Blinks white five times rapidly and then turns off	Indicates that the iDRAC Quick Sync 2 feature is disabled.	Check if iDRAC Quick Sync 2 feature is configured to be disabled by iDRAC. If the problem persists, see the <a href="#">Getting help</a> section. For more information, see <i>Integrated Dell Remote Access Controller User's Guide</i> at <a href="http://www.dell.com/poweredgemanuals">www.dell.com/poweredgemanuals</a> or <i>Dell OpenManage Server Administrator User's Guide</i> at <a href="http://www.dell.com/openmanagemanuals">www.dell.com/openmanagemanuals</a> > OpenManage Server Administrator
Solid amber	Indicates that the system is in fail-safe mode.	Restart the system. If the problem persists, see the <a href="#">Getting help</a> section.
Blinking amber	Indicates that the iDRAC Quick Sync 2 hardware is not responding properly.	Restart the system. If the problem persists, see the <a href="#">Getting help</a> section.

## Right control panel view






**Figure 7. Right control panel**

**Table 8. Right control panel**

Item	Indicator or button	Icon	Description
1	Power button		Indicates if the system is powered on or off. Press the power button to manually power on or off the system.

**Table 8. Right control panel (continued)**

Item	Indicator or button	Icon	Description
			 <b>NOTE:</b> Press the power button to gracefully shut down an ACPI-compliant operating system.
2	USB port		The USB ports are 4-pin, 2.0-compliant. This port enables you to connect USB devices to the system.
3	iDRAC Direct LED	N/A	The iDRAC Direct LED indicator lights up to indicate that the iDRAC Direct port is actively connected to a device. For more information, see the <a href="#">iDRAC Direct LED indicator codes</a> section.
4	iDRAC Direct port (Micro-AB USB)		The iDRAC Direct (Micro-AB USB) port enables you to access the iDRAC Direct (Micro-AB) features. For more information, see the <i>Integrated Dell Remote Access Controller User's Guide</i> at <a href="http://www.dell.com/poweredgemanuals">www.dell.com/poweredgemanuals</a>

## iDRAC Direct LED indicator codes

The iDRAC Direct LED indicator lights up to indicate that the port is connected and is being used as a part of the iDRAC subsystem.

You can configure iDRAC Direct by using a USB to micro USB (type AB) cable, which you can connect to your laptop or tablet. The following table describes iDRAC Direct activity when the iDRAC Direct port is active:

**Table 9. iDRAC Direct LED indicator codes**

iDRAC Direct LED indicator code	Condition
Solid green for two seconds	Indicates that the laptop or tablet is connected.
Flashing green (on for two seconds and off for two seconds)	Indicates that the laptop or tablet connected is recognized.
Turns off	Indicates that the laptop or tablet is unplugged.

## Drive indicator codes

Each drive carrier has an activity LED indicator and a status LED indicator. The indicators provide information about the current status of the drive. The activity LED indicator indicates whether the drive is currently in use or not. The status LED indicator indicates the power condition of the drive.



**Figure 8. Drive indicators**

1. Drive activity LED indicator
2. Drive status LED indicator
3. Drive capacity label

**NOTE:** If the drive is in the Advanced Host Controller Interface (AHCI) mode, the status LED indicator does not turn on.

**Table 10. Drive indicator codes**

Drive status indicator code	Condition
Flashes green twice per second	Identifying drive or preparing for removal.
Off	Drive ready for removal. <b>NOTE:</b> The drive status indicator remains off until all drives are initialized after the system is turned on. Drives are not ready for removal during this time.
Flashes green, amber, and then turns off	Predicted drive failure.
Flashes amber four times per second	Drive failed.
Flashes green slowly	Drive rebuilding.
Solid green	Drive online.
Flashes green for three seconds, amber for three seconds, and then turns off after six seconds	Rebuild stopped.

# Back view of the system

The back view displays the features available on the back of the system.

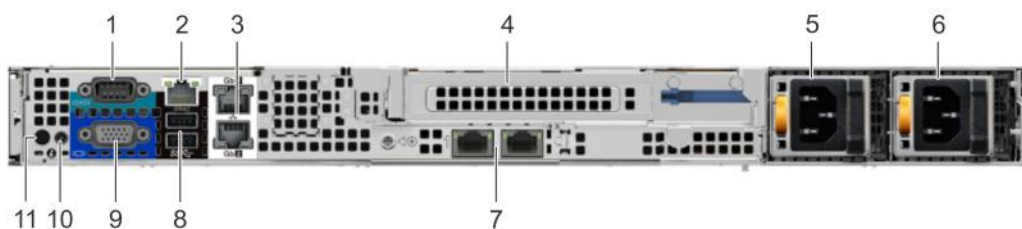


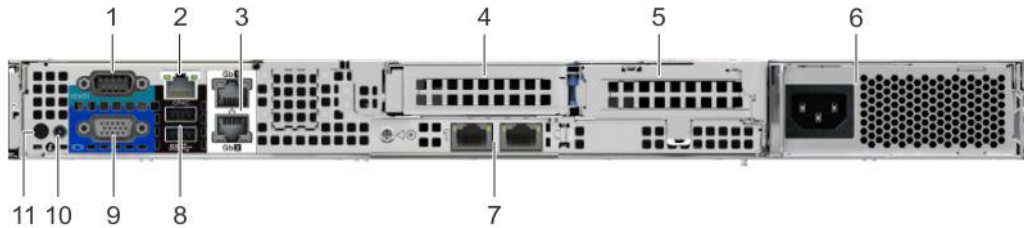
Figure 9. Back view of the system with full height riser

Table 11. Back view of the system with full height riser

Item	Ports, panels, or slots	Icon	Description
1	Serial port		Use the serial port to connect a serial device to the system. For more information, see the PowerEdge R440 Technical Specs at <a href="http://www.dell.com/poweredgemanuals">www.dell.com/poweredgemanuals</a> .
2	iDRAC9 dedicated network port	NA	Use the iDRAC9 dedicated network port to securely access the embedded iDRAC on a separate management network, see the <i>Integrated Dell Remote Access Controller User's Guide</i> at <a href="http://www.dell.com/poweredgemanuals">www.dell.com/poweredgemanuals</a>
3	Ethernet ports (2)		Use the Ethernet ports to connect Local Area Networks (LANs) to the system. For more information about the supported Ethernet ports, see the PowerEdge R440 Technical Specs at <a href="http://www.dell.com/poweredgemanuals">www.dell.com/poweredgemanuals</a>
4	Full height riser slot	N/A	Use the card slots to connect full-height PCIe expansion cards on full height riser.
5	Power supply unit (PSU)	N/A	For more information about the PSU configurations, see the PowerEdge R440 Technical Specs at <a href="http://www.dell.com/poweredgemanuals">www.dell.com/poweredgemanuals</a>
6	Power supply unit (PSU)	N/A	For more information about the PSU configurations, see the PowerEdge R440 Technical Specs at <a href="http://www.dell.com/poweredgemanuals">www.dell.com/poweredgemanuals</a>
7	LOM riser ports (2)		For more information about the PSU configurations, see the PowerEdge R440 Technical Specs at <a href="http://www.dell.com/poweredgemanuals">www.dell.com/poweredgemanuals</a>
8	USB 3.0 port (2)		Use the USB 3.0 port to connect USB devices to the system. These ports are 4-pin, USB 3.0-compliant.
9	VGA port		Use the VGA port to connect a display to the system. For more information about the supported VGA port, see the PowerEdge R440 Technical Specs at <a href="http://www.dell.com/poweredgemanuals">www.dell.com/poweredgemanuals</a> .
10	System status indicator cable port	N/A	Enables you to connect the status indicator cable and view system status when the CMA is installed.
11	System identification button		<p>Press the system ID button:</p> <ul style="list-style-type: none"> <li>To locate a particular system within a rack.</li> <li>To turn the system ID on or off.</li> </ul> <p>To reset iDRAC, press and hold the button for more than 15 seconds.</p> <p><b>NOTE:</b></p> <ul style="list-style-type: none"> <li>To reset iDRAC using system ID, ensure that the system ID button is enabled in the iDRAC setup.</li> </ul>

**Table 11. Back view of the system with full height riser (continued)**

Item	Ports, panels, or slots	Icon	Description
			<ul style="list-style-type: none"> <li>If the system stops responding during POST, press and hold the system ID button (for more than five seconds) to enter the BIOS progress mode.</li> </ul>



**Figure 10. Back view of the system with 2 risers**

**Table 12. Back view of the system with 2 risers**

Item	Ports, panels, or slots	Icon	Description
1	Serial port		Use the serial port to connect a serial device to the system. For more information, see the PowerEdge R440 Technical Specs at <a href="http://www.dell.com/poweredgemanuals">www.dell.com/poweredgemanuals</a> .
2	iDRAC9 dedicated network port	NA	Use the iDRAC9 dedicated network port to securely access the embedded iDRAC on a separate management network, see the <i>Integrated Dell Remote Access Controller User's Guide</i> at <a href="http://www.dell.com/poweredgemanuals">www.dell.com/poweredgemanuals</a>
3	Ethernet ports (2)		Use the Ethernet ports to connect Local Area Networks (LANs) to the system. For more information, see the PowerEdge R440 Technical Specs at <a href="http://www.dell.com/poweredgemanuals">www.dell.com/poweredgemanuals</a>
4	Low profile riser right slot	N/A	Use the card slot to connect half-height PCIe expansion card on low profile riser.
5	Low profile riser left slot	N/A	Use the card slot to connect half-height PCIe expansion card on low profile riser.
6	Cabled PSU	N/A	For more information, see the PowerEdge R440 Technical Specs at <a href="http://www.dell.com/poweredgemanuals">www.dell.com/poweredgemanuals</a>
7	LOM riser ports (2)		For more information, see the PowerEdge R440 Technical Specs at <a href="http://www.dell.com/poweredgemanuals">www.dell.com/poweredgemanuals</a>
8	USB 3.0 port (2)		Use the USB 3.0 port to connect USB devices to the system. These ports are 4-pin, USB 3.0-compliant.
9	VGA port		Use the VGA port to connect a display to the system. For more information, see the PowerEdge R440 Technical Specs at <a href="http://www.dell.com/poweredgemanuals">www.dell.com/poweredgemanuals</a>
10	System status indicator cable port	N/A	Enables you to connect the status indicator cable and view system status when the CMA is installed.
11	System identification button		<p>Press the system ID button:</p> <ul style="list-style-type: none"> <li>To locate a particular system within a rack.</li> <li>To turn the system ID on or off.</li> </ul> <p>To reset iDRAC, press and hold the button for more than 15 seconds.</p> <p><b>NOTE:</b></p> <ul style="list-style-type: none"> <li>To reset iDRAC using system ID, ensure that the system ID button is enabled in the iDRAC setup.</li> </ul>

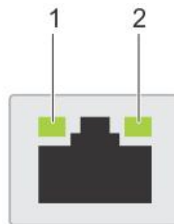


**Table 12. Back view of the system with 2 risers (continued)**

Item	Ports, panels, or slots	Icon	Description
			<ul style="list-style-type: none"> <li>If the system stops responding during POST, press and hold the system ID button (for more than five seconds) to enter the BIOS progress mode.</li> </ul>

## NIC indicator codes

Each NIC on the back of the system has indicators that provide information about the activity and link status. The activity LED indicator indicates if data is flowing through the NIC, and the link LED indicator indicates the speed of the connected network.



**Figure 11. NIC indicator codes**

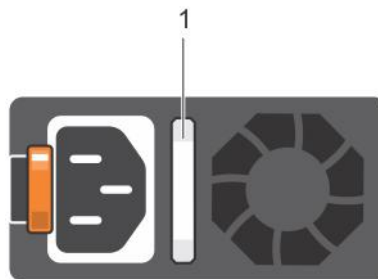
- link LED indicator
- activity LED indicator

**Table 13. NIC indicator codes**

Status	Condition
Link and activity indicators are off	The NIC is not connected to the network.
Link indicator is green and activity indicator is blinking green	The NIC is connected to a valid network at its maximum port speed and data is being sent or received.
Link indicator is amber and activity indicator is blinking green	The NIC is connected to a valid network at less than its maximum port speed and data is being sent or received.
Link indicator is green and activity indicator is off	The NIC is connected to a valid network at its maximum port speed and data is not being sent or received.
Link indicator is amber and activity indicator is off	The NIC is connected to a valid network at less than its maximum port speed and data is not being sent or received.
Link indicator is blinking green and activity is off	NIC identify is enabled through the NIC configuration utility.

## Power supply unit indicator codes

AC power supply units (PSUs) have an illuminated translucent handle that serves as an indicator. The indicator shows whether power is present or if a power fault has occurred.



**Figure 12. AC PSU status indicator**

- AC PSU status indicator/handle

**Table 14. AC PSU status indicator codes**

Power indicator codes	Condition
Green	A valid power source is connected to the PSU and the PSU is operational.
Blinking amber	Indicates a problem with the PSU.
Not illuminated	Power is not connected to the PSU.
Blinking green	When the firmware of the PSU is being updated, the PSU handle blinks green. <b>CAUTION:</b> Do not disconnect the power cord or unplug the PSU when updating firmware. If firmware update is interrupted, the PSUs do not function.
Blinking green and turns off	When hot-plugging a PSU, the PSU handle blinks green five times at a rate of 4 Hz and turns off. This indicates a PSU mismatch with respect to efficiency, feature set, health status, or supported voltage. <b>CAUTION:</b> If two PSUs are installed, both the PSUs must have the same type of label; for example, Extended Power Performance (EPP) label. Mixing PSUs from previous generations of PowerEdge servers is not supported, even if the PSUs have the same power rating. This results in a PSU mismatch condition or failure to turn the system on. <b>CAUTION:</b> When correcting a PSU mismatch, replace only the PSU with the blinking indicator. Swapping the PSU to make a matched pair can result in an error condition and unexpected system shutdown. To change from a high output configuration to a low output configuration or vice versa, you must turn off the system. <b>CAUTION:</b> AC PSUs support both 240 V and 120 V input voltages with the exception of Titanium PSUs, which support only 240 V. When two identical PSUs receive different input voltages, they can output different wattages, and trigger a mismatch. <b>CAUTION:</b> If two PSUs are used, they must be of the same type and have the same maximum output power.

## LCD panel

The LCD panel provides system information, status, and error messages to indicate if the system is functioning correctly or requires attention. The LCD panel can also be used to configure or view the system's iDRAC IP address. For information about the event and error messages generated by the system firmware and agents that monitor system components, go to [qrl.dell.com](http://qrl.dell.com) > **Look Up** > **Error Code**, type the error code, and then click **Look it up**.

The LCD panel is available only on the optional front bezel. The optional front bezel is hot pluggable.

The statuses and conditions of the LCD panel are outlined here:

- The LCD backlight is white during normal operating conditions.
- When the system needs attention, the LCD backlight turns amber, and displays an error code followed by descriptive text.  
**NOTE:** If the system is connected to a power source and an error is detected, the LCD turns amber regardless of whether the system is turned on or off.
- When the system turns off and there are no errors, LCD enters the standby mode after five minutes of inactivity. Press any button on the LCD to turn it on.
- If the LCD panel stops responding, remove the bezel and reinstall it. If the problem persists, see the PowerEdge T640 Technical Specs at [www.dell.com/poweredgemanuals](http://www.dell.com/poweredgemanuals)
- The LCD backlight remains off if LCD messaging is turned off using the iDRAC utility, the LCD panel, or other tools.



**Figure 13. LCD panel features**




**Table 15. LCD panel features**

Item	Button or display	Description
1	Left	Moves the cursor back in one-step increments.
2	Select	Selects the menu item highlighted by the cursor.
3	Right	Moves the cursor forward in one-step increments. During message scrolling: <ul style="list-style-type: none"> <li>• Press and hold the right button to increase scrolling speed.</li> <li>• Release the button to stop.</li> </ul> <p><b>NOTE:</b> The display stops scrolling when the button is released. After 45 seconds of inactivity, the display starts scrolling.</p>
4	LCD display	Displays system information, status, and error messages or iDRAC IP address.

## Viewing Home screen

The **Home** screen displays user-configurable information about the system. This screen is displayed during normal system operation when there are no status messages or errors. When the system turns off and there are no errors, LCD enters the standby mode after five minutes of inactivity. Press any button on the LCD to turn it on.

### Steps

1. To view the **Home** screen, press one of the three navigation buttons (Select, Left, or Right).
2. To navigate to the **Home** screen from another menu, complete the following steps:
  - a. Press and hold the navigation button until the up arrow  is displayed.
  - b. Navigate to the **Home** icon  using the up arrow .
  - c. Select the **Home** icon.
  - d. On the **Home** screen, press the **Select** button to enter the main menu.

## Setup menu

**NOTE:** When you select an option in the **Setup** menu, you must confirm the option before proceeding to the next action.

Option	Description
<b>iDRAC</b>	Select <b>DHCP</b> or <b>Static IP</b> to configure the network mode. If <b>Static IP</b> is selected, the available fields are <b>IP</b> , <b>Subnet (Sub)</b> , and <b>Gateway (Gtw)</b> . Select <b>Setup DNS</b> to enable DNS and to view domain addresses. Two separate DNS entries are available.
<b>Set error</b>	Select <b>SEL</b> to view LCD error messages in a format that matches the IPMI description in the SEL. This enables you to match an LCD message with an SEL entry.  Select <b>Simple</b> to view LCD error messages in a simplified user-friendly description. For information about the event and error messages generated by the system firmware and agents that monitor system components, go to <a href="http://qrl.dell.com">qrl.dell.com</a> > <b>Look Up</b> > <b>Error Code</b> , type the error code, and then click <b>Look it up</b> .
<b>Set home</b>	Select the default information to be displayed on the <b>Home</b> screen. See View menu section for the options and option items that can be set as the default on the <b>Home</b> screen.

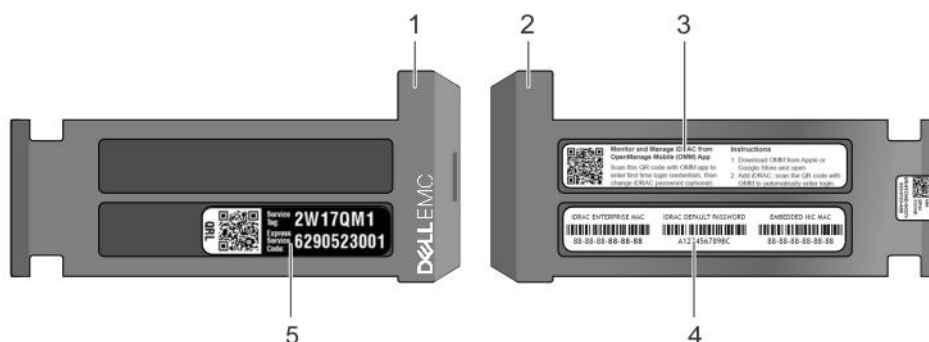
## View menu

**NOTE:** When you select an option in the **View** menu, you must confirm the option before proceeding to the next action.

Option	Description
<b>iDRAC IP</b>	Displays the <b>IPv4</b> or <b>IPv6</b> addresses for iDRAC9. Addresses include <b>DNS (Primary and Secondary)</b> , <b>Gateway, IP</b> , and <b>Subnet</b> (IPv6 does not have Subnet).
<b>MAC</b>	Displays the MAC addresses for <b>iDRAC, iSCSI</b> , or <b>Network</b> devices.
<b>Name</b>	Displays the name of the <b>Host, Model</b> , or <b>User String</b> for the system.
<b>Number</b>	Displays the <b>Asset tag</b> or the <b>Service tag</b> for the system.
<b>Power</b>	Displays the power output of the system in BTU/hr or Watts. The display format can be configured in the <b>Set home</b> submenu of the <b>Setup</b> menu.
<b>Temperature</b>	Displays the temperature of the system in Celsius or Fahrenheit. The display format can be configured in the <b>Set home</b> submenu of the <b>Setup</b> menu.

## Locating the Service Tag of your system

You can identify your system using the unique Express Service Code and Service Tag. Pull out the information tag in front of the system to view the Express Service Code and Service Tag. Alternatively, the information may be on a sticker on the chassis of the system. The mini Enterprise Service Tag (EST) is found on the back of the system. This information is used by Dell to route support calls to the appropriate personnel.



**Figure 14. Locating Service Tag of your system**

1. Information tag (front view)
2. Information tag (back view)
3. OpenManage Mobile (OMM) label
4. iDRAC MAC address and iDRAC secure password label
5. Service Tag

# System Label Information

## Service and Memory Information Label

### Service Information

**System Touchpoints**

- Hot swap touchpoints: Components with terracotta touchpoints can be serviced while the system is running.
- Cold swap touchpoints: Components with blue touchpoints require a full system shutdown before servicing.

**Mechanical Overview**

**Top View**  
3.5" x 4" Hot Swap HDD Fans

**2.5" x 8" Hot Swap HDD Fans**

**2.5" x 10" Hot Swap HDD Fans**

**Rear View**

Serial ID/RAID USBs NICs PCIe Card Slot\*\*

System ID CMA Jack VGA NICs Power Supplies\*

PCIe Card Slots\*\*

\*Your system may be configured with either hot- or cold-swap components. Follow the corresponding instructions.  
\*\*Your system may be configured with Riser or non-Riser in PCIe Card Slots. Follow the corresponding instructions.

### Memory Information

**Caution:** Memory (DIMMs) and CPUs may be hot during servicing

**Memory Population Configuration**

Configuration	Sequence
Memory-Optimized	C1[1], C2[1], C1[2], C2[2], C1[3], C2[3]
Mirroring	C1[1,2,3,4,5,6], C2[1,2,3,4,5,6]

**Caution:** Many repairs may only be done by a certified service technician. You should only perform troubleshooting and simple repairs as authorized in your product documentation, or as directed by the online or telephone service and support team. Damage due to servicing that is not authorized by Dell is not covered by your warranty. Read and follow the safety instructions that came with the product.

To learn more about this Dell product or to order additional or replacement parts, go to [Dell.com/support](http://Dell.com/support)  
Copyright © 2017 Dell Inc. or its subsidiaries. All Rights Reserved. Rev A00, Label Part No. 5X0X6

**System Tasks**

**Internal Riser**

**2.5" x 10" Disk Backplane**

### Electrical Overview

**System Board Connections**

1 System Power	13 TPM	27 Fan 6
2 SATA_C	14 PCIe Card Slot 4 (CPU 2)	28 DIMMs For CPU 1 Channels 0, 1, 2
3 SATA_B	15 LOM Riser Card	29 CPU 1
4 PIB Signal 1	16 Backplane Signal 2 (Rear)	30 DIMMs For CPU 1 Channels 3, 4, 5
5 PIB Signal 2	17 PCIe Internal Storage (CPU 1)	31 Fan 5
6 SATA_A	18 CPU 2	32 Fan 4
7 IDSDM + vFlash	19 Riser 1 (CPU 1)	33 CPU 1 Power
8 Front USB	20 ODD/Rear Backplane Power	34 Intrusion Switch
9 ODD/Rear Backplane Power	21 DIMMs For CPU 2 Channels 0, 1, 2	35 Fan 3
10 VGA	22 CPU 2	36 Fan 2
11 Internal USB 3.0 (PCH)	23 DIMMs For CPU 2 Channels 3, 4, 5	37 Backplane Signal 1
12 PCIe Card Slot 6 (PCH)	24 Slimline (PCIe_A0)	38 Left Control Panel
13 Jumpers	25 CPU 2 Power	39 Right Control Panel
14 PCIe Card Slot 5 (CPU 1)		

### Quick Resource Locator

Dell.com/GRL/Server/PER440

**Icon Legend**

EST Express Service Tag	Hard Drive Activity
Memory Bank	Mgmt Port
Power Supply	Push
System Status	Fan
System Info	CPU

Figure 15. Service and memory information label

# Initial system setup and configuration

## Topics:

- [Setting up your system](#)
- [iDRAC configuration](#)
- [Options to install the operating system](#)

## Setting up your system

Perform the following steps to set up your system:

### Steps

1. Unpack the system.
2. Install the system into the rack. For more information about installing the system into the rack, see the *Rail Installation Guide* at [www.dell.com/poweredgemanuals](http://www.dell.com/poweredgemanuals).
3. Connect the peripherals to the system.
4. Connect the system to its electrical outlet.
5. Power on the system by pressing the power button or by using iDRAC.
6. Power on the attached peripherals.

For more information about setting up your system, see the *Getting Started Guide* that shipped with your system.


For information on how to manage basic settings and features of the system, see the Dell EMC PowerEdge R440 BIOS and UEFI Reference Guide on the product documentation page.

## iDRAC configuration

The Integrated Dell Remote Access Controller (iDRAC) is designed to make system administrators more productive and improve the overall availability of Dell systems. iDRAC alerts administrators about system issues and enables them to perform remote system management. This reduces the need for physical access to the system.

## Options to set up iDRAC IP address

To enable communication between your system and iDRAC, you must first configure the network settings based on your network infrastructure.

 **NOTE:** For static IP configuration, you must request for it at the time of purchase.

This option is set to **DHCP** by Default. You can set up the IP address by using one of the following interfaces:

Interfaces	Document/Section
<b>iDRAC Settings utility</b>	<i>Dell Integrated Dell Remote Access Controller User's Guide</i> at <a href="http://www.dell.com/poweredgemanuals">www.dell.com/poweredgemanuals</a>
<b>Dell Deployment Toolkit</b>	<i>Dell Deployment Toolkit User's Guide</i> at <a href="http://www.dell.com/openmanagemanuals">www.dell.com/openmanagemanuals</a> > OpenManage Deployment Toolkit
<b>Dell Lifecycle Controller</b>	<i>Dell Lifecycle Controller User's Guide</i> at <a href="http://www.dell.com/poweredgemanuals">www.dell.com/poweredgemanuals</a>
<b>Server LCD panel</b>	<a href="#">LCD panel</a> section

**NOTE:** To access iDRAC, ensure that you connect the ethernet cable to the iDRAC9 dedicated network port. You can also access iDRAC through the shared LOM mode, if you have opted for a system that has the shared LOM mode enabled.

## Log in to iDRAC

You can log in to iDRAC as:

- iDRAC user
- Microsoft Active Directory user
- Lightweight Directory Access Protocol (LDAP) user

If you have opted for secure default access to iDRAC, you must use the iDRAC secure default password available on the system Information tag. If you have not opted for secure default access to iDRAC, then use the default user name and password `-root` and `calvin`. You can also log in by using your Single Sign-On or Smart Card.

**NOTE:** You must have the iDRAC credentials to log in to iDRAC.

**NOTE:** Ensure that you change the default username and password after setting up the iDRAC IP address.

For more information about logging in to the iDRAC and iDRAC licenses, see the latest *Integrated Dell Remote Access Controller User's Guide* at [www.dell.com/poweredgemanuals](http://www.dell.com/poweredgemanuals).

You can also access iDRAC by using RACADM. For more information, see the *RACADM Command Line Interface Reference Guide* at [www.dell.com/poweredgemanuals](http://www.dell.com/poweredgemanuals).

## Options to install the operating system

If the system is shipped without an operating system, install a supported operating system by using one of the following resources:

**Table 16. Resources to install the operating system**

Resources	Location
iDRAC	<a href="http://www.dell.com/idracmanuals">www.dell.com/idracmanuals</a>
Lifecycle Controller	<a href="http://www.dell.com/idracmanuals">www.dell.com/idracmanuals</a> > Lifecycle Controller
OpenManage Deployment Toolkit	<a href="http://www.dell.com/openmanagemanuals">www.dell.com/openmanagemanuals</a> > OpenManage Deployment Toolkit
Dell certified VMware ESXi	<a href="http://www.dell.com/virtualizationsolutions">www.dell.com/virtualizationsolutions</a>
Installation and How-to videos for supported operating systems on PowerEdge systems	<a href="#">Supported Operating Systems for Dell EMC PowerEdge systems</a>

## Methods to download firmware and drivers

You can download the firmware and drivers by using any of the following methods:

**Table 17. Firmware and drivers**

Methods	Location
From the Dell EMC support site	<a href="http://www.dell.com/support/home">www.dell.com/support/home</a>
Using Dell Remote Access Controller Lifecycle Controller (iDRAC with LC)	<a href="http://www.dell.com/idracmanuals">www.dell.com/idracmanuals</a>
Using Dell Repository Manager (DRM)	<a href="http://www.dell.com/openmanagemanuals">www.dell.com/openmanagemanuals</a> > Repository Manager
Using Dell OpenManage Essentials	<a href="http://www.dell.com/openmanagemanuals">www.dell.com/openmanagemanuals</a> > OpenManage Essentials
Using Dell OpenManage Enterprise	<a href="http://www.dell.com/openmanagemanuals">www.dell.com/openmanagemanuals</a> > OpenManage Enterprise

**Table 17. Firmware and drivers (continued)**

Methods	Location
Using Dell Server Update Utility (SUU)	<a href="http://www.dell.com/openmanagemanuals">www.dell.com/openmanagemanuals</a> > Server Update Utility
Using Dell OpenManage Deployment Toolkit (DTK)	<a href="http://www.dell.com/openmanagemanuals">www.dell.com/openmanagemanuals</a> > OpenManage Deployment Toolkit
Using iDRAC virtual media	<a href="http://www.dell.com/idracmanuals">www.dell.com/idracmanuals</a>

## Downloading drivers and firmware

Dell EMC recommends that you download and install the latest BIOS, drivers, and systems management firmware on your system.

### Prerequisites

Ensure that you clear the web browser cache before downloading the drivers and firmware.

### Steps

1. Go to [www.dell.com/support/home](http://www.dell.com/support/home).
2. In the **Drivers & Downloads** section, type the Service Tag of your system in the **Enter a Service Tag or product ID** box, and then click **Submit**.

 **NOTE:** If you do not have the Service Tag, select **Detect Product** to allow the system to automatically detect the Service Tag, or click **View products**, and navigate to your product.

3. Click **Drivers & Downloads**.  
The drivers that are applicable to your system are displayed.
4. Download the drivers to a USB drive, CD, or DVD.




# Installing and removing system components

## Topics:


- Safety instructions
- Before working inside your system
- After working inside your system
- Recommended tools
- Optional front bezel
- System cover
- Inside the system
- Backplane cover
- Air shroud
- Cooling fans
- Intrusion switch
- Drives
- System memory
- Processors and heat sinks
- Internal PERC riser
- Expansion cards and expansion card risers
- M.2 SSD module
- Optional MicroSD or vFlash card
- Optional IDSDM or vFlash module
- LOM riser card
- Hard drive backplane
- Cable routing
- System battery
- Optional internal USB memory key
- Optical drive (optional)
- Power supply units
- Power interposer board
- Control panel
- System board
- Trusted Platform Module


## Safety instructions


 **NOTE:** Whenever you need to lift the system, get others to assist you. To avoid injury, do not attempt to lift the system by yourself.

 **WARNING:** Opening or removing the system cover while the system is powered on may expose you to a risk of electric shock.

 **CAUTION:** Do not operate the system without the cover for a duration exceeding five minutes. Operating the system without the system cover can result in component damage.

 **CAUTION:** Many repairs may only be done by a certified service technician. You should only perform troubleshooting and simple repairs as authorized in your product documentation, or as directed by the online or telephone service and support team. Damage due to servicing that is not authorized by Dell is not covered by your warranty. Read and follow the safety instructions that are shipped with your product.

 **NOTE:** It is recommended that you always use an antistatic mat and antistatic strap while working on components inside the system.

 **CAUTION:** To ensure proper operation and cooling, all bays in the system and system fans must be always populated with a component or a blank.

## Before working inside your system

### Prerequisites

Follow the safety guidelines listed in [Safety instructions](#).

### Steps

1. Turn off the system, including all attached peripherals.
2. Disconnect the system from the electrical outlet and disconnect the peripherals.
3. Remove the system cover.

## After working inside your system

### Prerequisites

Follow the safety guidelines listed in [Safety instructions](#).

### Steps

1. Install the system cover.
2. Reconnect the peripherals and connect the system to the electrical outlet.
3. Turn on the attached peripherals and then turn on the system.

## Recommended tools

You need the following tools to perform the removal and installation procedures:

- Key to the bezel lock  
The key is required only if your system includes a bezel.
- Phillips #1 screwdriver
- Phillips #2 screwdriver
- Torx #T30 screwdriver
- Torx #T8 screwdriver
- Wrist grounding strap

## Optional front bezel

### Removing the front bezel

The procedure to remove the front bezel with and without the LCD panel is the same.

### Prerequisites

Follow the safety guidelines listed in [Safety instructions](#).

### Steps

1. Unlock the bezel by using the bezel key.
2. Press the release button, and pull the left end of the bezel.
3. Unhook the right end, and remove the bezel.



Figure 16. Removing the front bezel with the LCD panel

## Installing the front bezel

The procedure to install the front bezel with and without the LCD panel is the same.

### Prerequisites

Follow the safety guidelines listed in [Safety instructions](#).

### Steps

1. Locate and remove the bezel key.
  - NOTE:** The bezel key is part of the LCD bezel package.
2. Align and insert the tabs on the bezel into the slots on the system.
3. Press the bezel until the button clicks in place.
4. Lock the bezel by using the key.

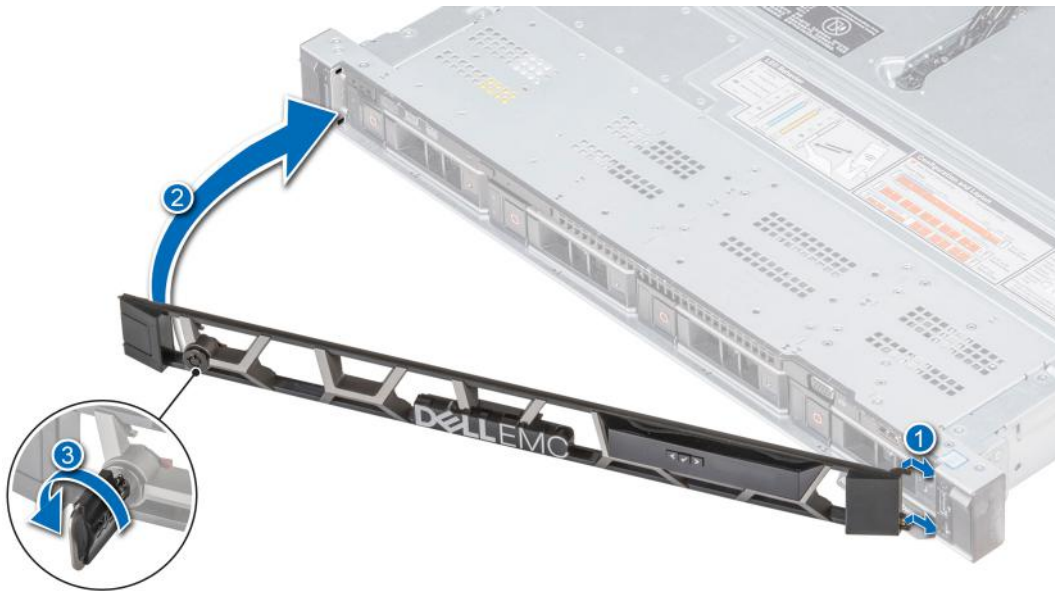


Figure 17. Installing the front bezel with the LCD panel

## System cover

### Removing the system cover

#### Prerequisites

1. Follow the safety guidelines listed in [Safety instructions](#).
2. Turn off the system, including any attached peripherals.
3. Disconnect the system from the electrical outlet and disconnect the peripherals.

#### Steps

1. Using a 1/4 inch flat head or a Phillips #2 screwdriver, rotate the latch release lock counter clockwise to the unlocked position.
2. Lift the latch till the system cover slides back and the tabs on the system cover disengage from the guide slots on the system.
3. Hold the cover on both sides, and lift the cover away from the system.



Figure 18. Removing the system cover

## Installing the system cover

### Prerequisites

1. Follow the safety guidelines listed in [Safety instructions](#).
2. Ensure that all internal cables are routed correctly and connected, and no tools or extra parts are left inside the system.

### Steps

1. Align the tabs on the system cover with the guide slots on the system.
2. Push the system cover latch down.  
The system cover slides forward, the tabs on the system cover engage with the guide slots on the system and the system cover latch locks into place.
3. Using a 1/4 inch flat head or Phillips #2 screwdriver, rotate the latch release lock clockwise to the locked position.



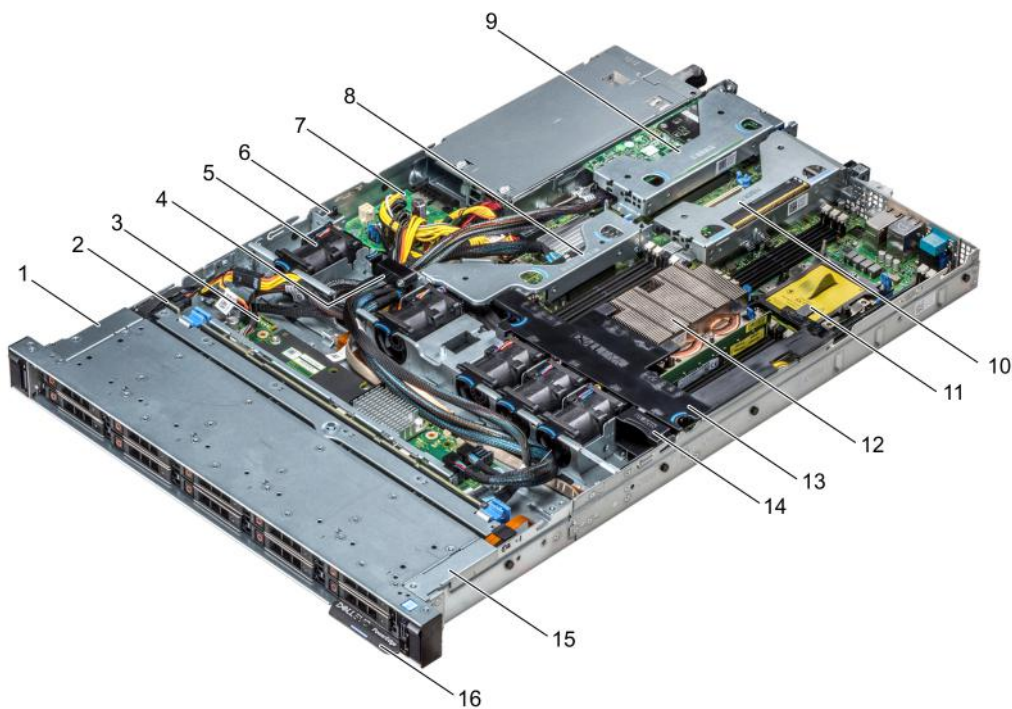
Figure 19. Installing the system cover

#### Next steps

1. Reconnect the peripherals and connect the system to the electrical outlet.
2. Turn on the system, including any attached peripherals.

## Inside the system

**CAUTION:** Many repairs may only be done by a certified service technician. You should only perform troubleshooting and simple repairs as authorized in your product documentation, or as directed by the online or telephone service and support team. Damage due to servicing that is not authorized by Dell is not covered by your warranty. Read and follow the safety instructions that are shipped with your product.



**Figure 20. Inside the system**

- |                                    |                                   |
|------------------------------------|-----------------------------------|
| 1. left control panel cable cover  | 2. hard drive backplane           |
| 3. backplane expander board        | 4. cabling latch                  |
| 5. air shroud                      | 6. intrusion switch               |
| 7. power interposer board          | 8. internal expansion riser       |
| 9. low profile expansion riser 1   | 10. low profile expansion riser 2 |
| 11. processor blank                | 12. heat sink                     |
| 13. air shroud                     | 14. cooling fan blank             |
| 15. left control panel cable cover | 16. information tag               |

## Backplane cover

### Removing the backplane cover

#### Prerequisites

1. Follow the safety guidelines listed in [Safety instructions](#).
2. Follow the procedure listed in [Before working inside your system](#).
3. [Remove the system cover](#).

#### Steps

1. Slide the backplane cover in the direction of the arrows marked on the backplane cover.
2. Lift the backplane cover away from the system.

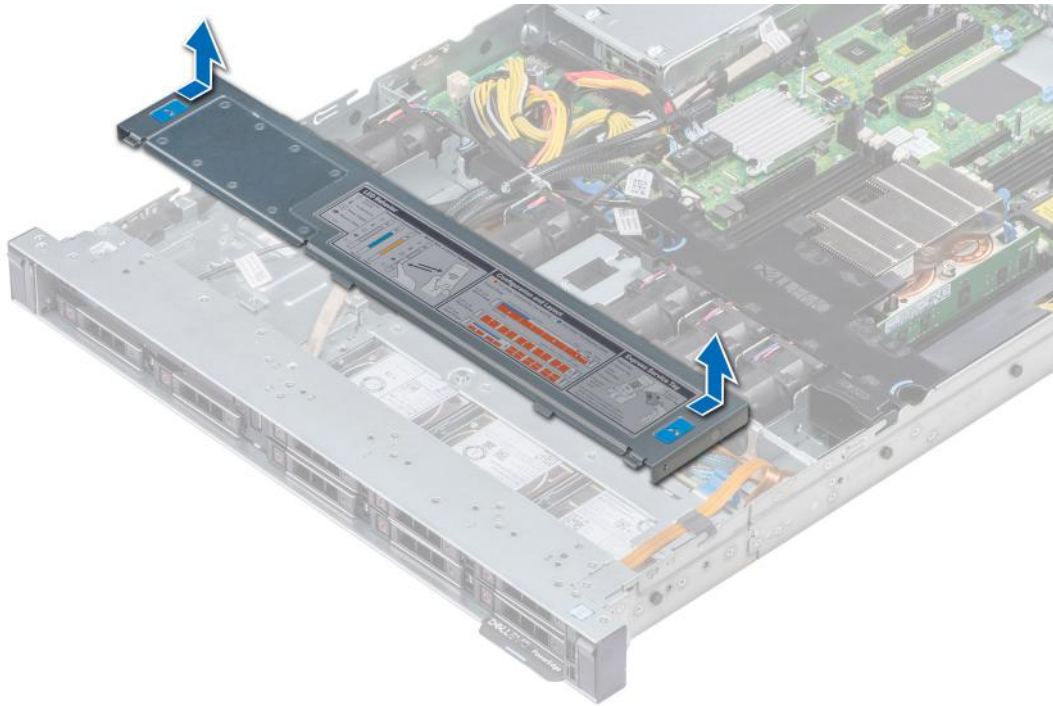


Figure 21. Removing backplane cover

## Installing the backplane cover

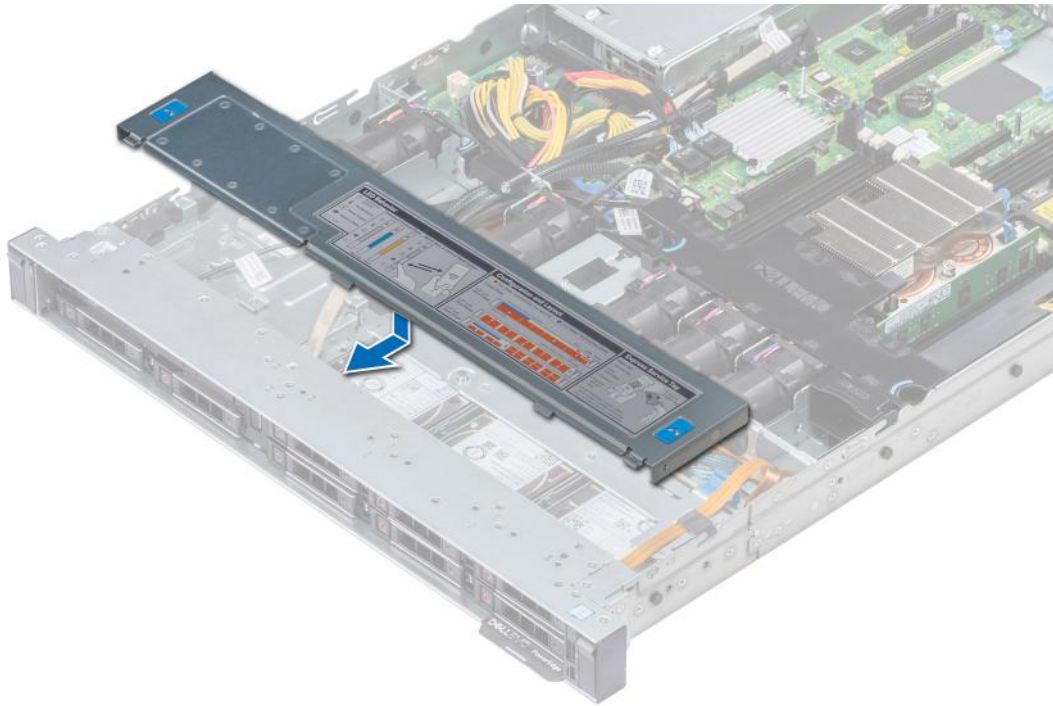
### Prerequisites

1. Follow the safety guidelines listed in [Safety instructions](#).
2. Follow the procedure listed in [Before working inside your system](#).
3. [Install the system cover](#).

### Steps

1. Align the tabs on the backplane cover with the guide slots on the system.
2. Slide the backplane cover toward the front of the system until the cover locks into place.





**Figure 22. Installing backplane cover**

**Next steps**

Follow the procedure listed in [After working inside your system.](#)

# Air shroud

## Removing the air shroud

### Prerequisites

**CAUTION:** Never operate your system with the air shroud removed. The system may get overheated quickly, resulting in shutdown of the system and loss of data.

1. Follow the safety guidelines listed in [Safety instructions](#).
2. Follow the procedure listed in [Before working inside your system](#).

### Steps

Holding the blue touch points, lift the air shroud away from the system.

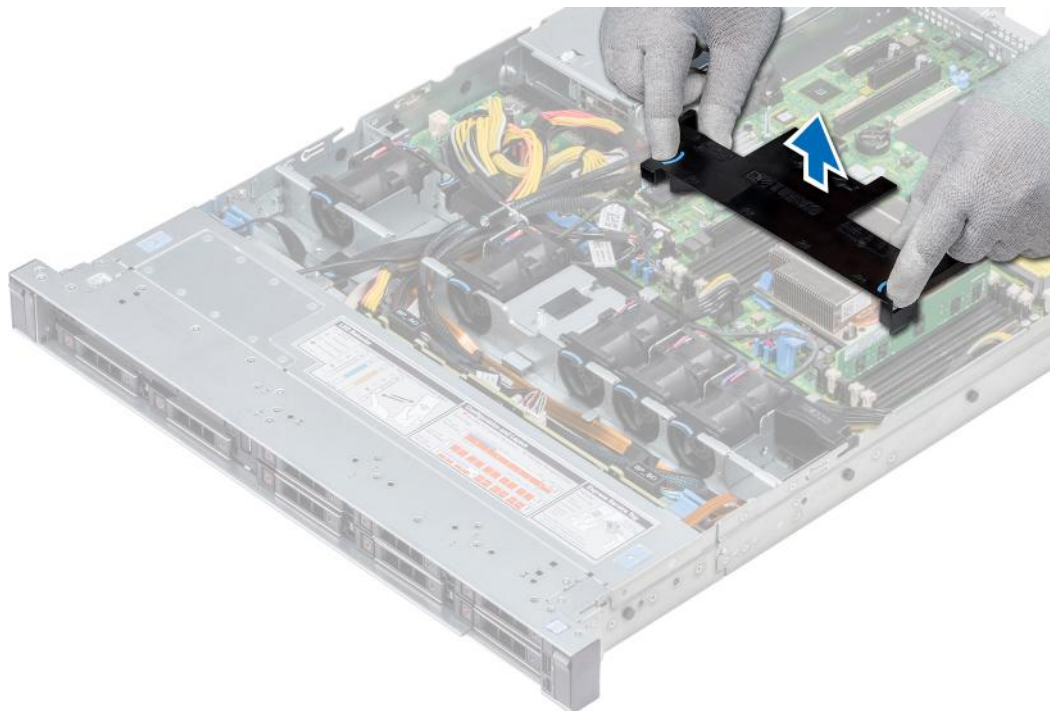


Figure 23. Removing the air shroud

### Next steps

1. If applicable, [install the air shroud](#).
2. Follow the procedure listed in [After working inside your system](#).

## Installing the air shroud

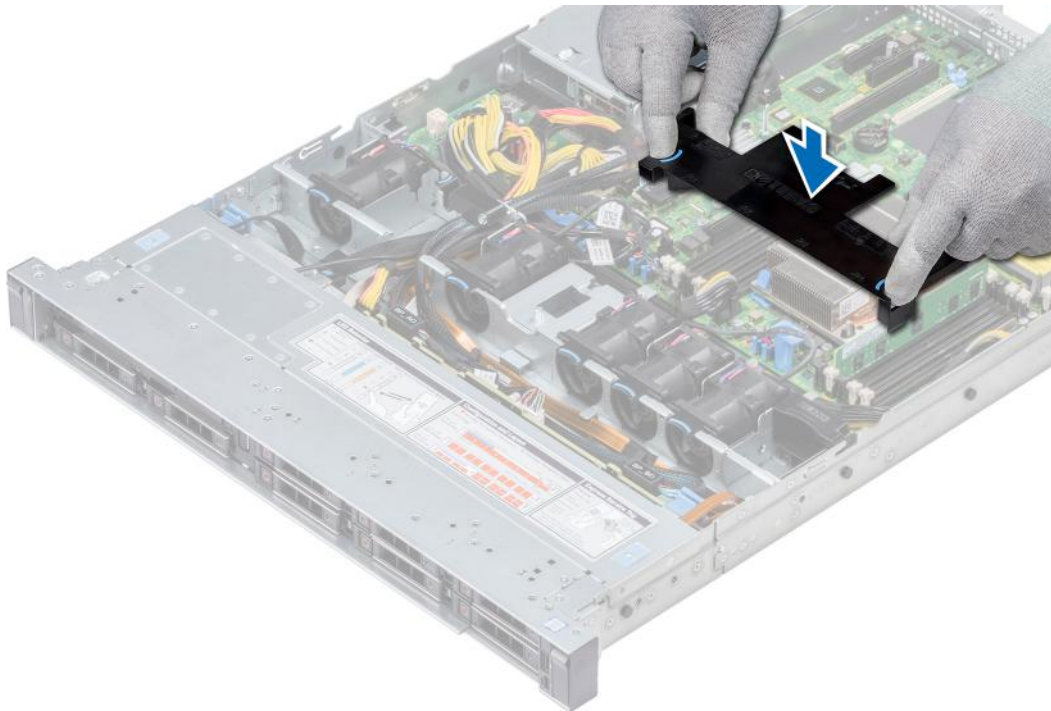
### Prerequisites

1. Follow the safety guidelines listed in [Safety instructions](#).
2. Follow the procedure listed in [Before working inside your system](#).
3. If applicable, route the cables inside the system along the system wall and secure the cables by using the cable latch.

### Steps

1. Align the tabs on the air shroud with the slots on the system.

2. Lower the air shroud into the system until it is firmly seated.  
When firmly seated, the memory socket numbers marked on the air shroud align with the respective memory sockets.



**Figure 24. Installing the air shroud**

#### Next steps

1. Follow the procedure listed in [After working inside your system](#).

## Cooling fans

### Removing the cooling fan

#### Prerequisites

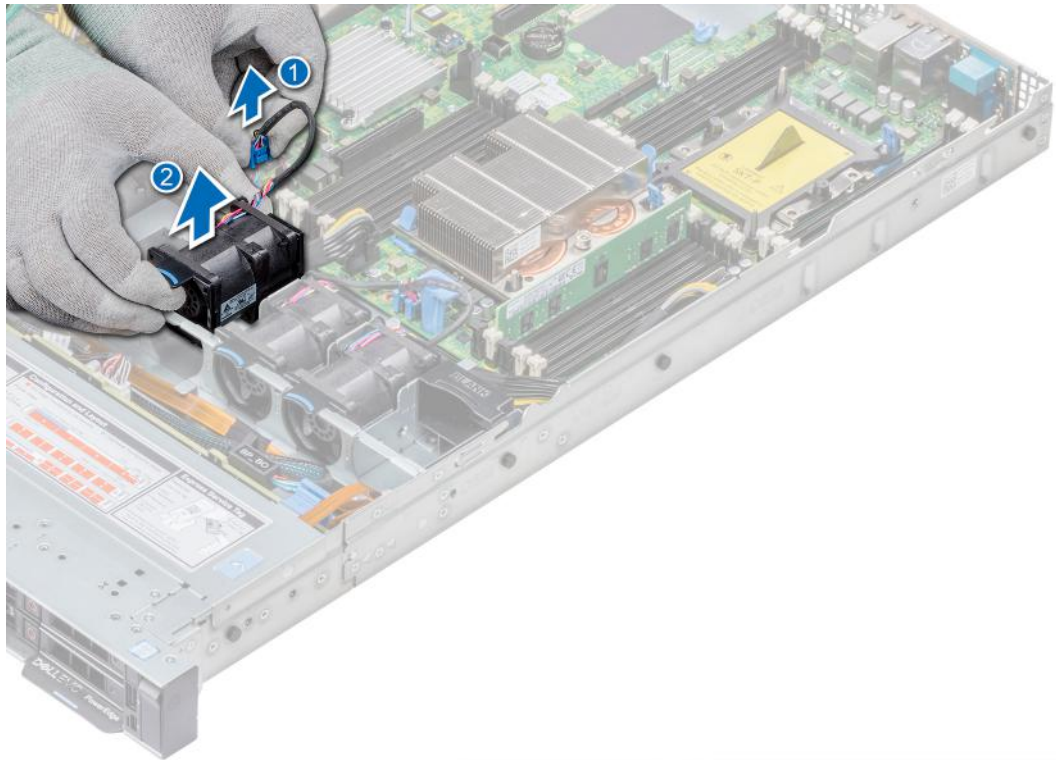
1. Follow the safety guidelines listed in [Safety instructions](#).
2. Follow the procedure listed in [Before working inside your system](#).
3. [Remove the air shroud](#).
4. [Remove the internal riser](#).
5. Disconnect the fan cable from the system board.
6. Move the cables out of the way to access the cooling fan cable connector on the system board.

#### Steps

1. Press the tabs on the side of the cable connector to disconnect the cable from the connector on the system board.

**NOTE:** Ensure that you disconnect the fan 1 cable from the power interposer board.

**NOTE:** Ensure that you note the routing of the cables as you remove them from the system board.



**Figure 25. Removing the cooling fan**

2. Lift the fan out holding the blue touch point.

#### **Next steps**

1. [Install the cooling fan.](#)
2. [Install the internal riser.](#)
3. Connect the power cable to the system board.
4. Ensure the cables are routed correctly.
5. [Install the air shroud.](#)
6. Follow the procedure listed in [After working inside your system.](#)

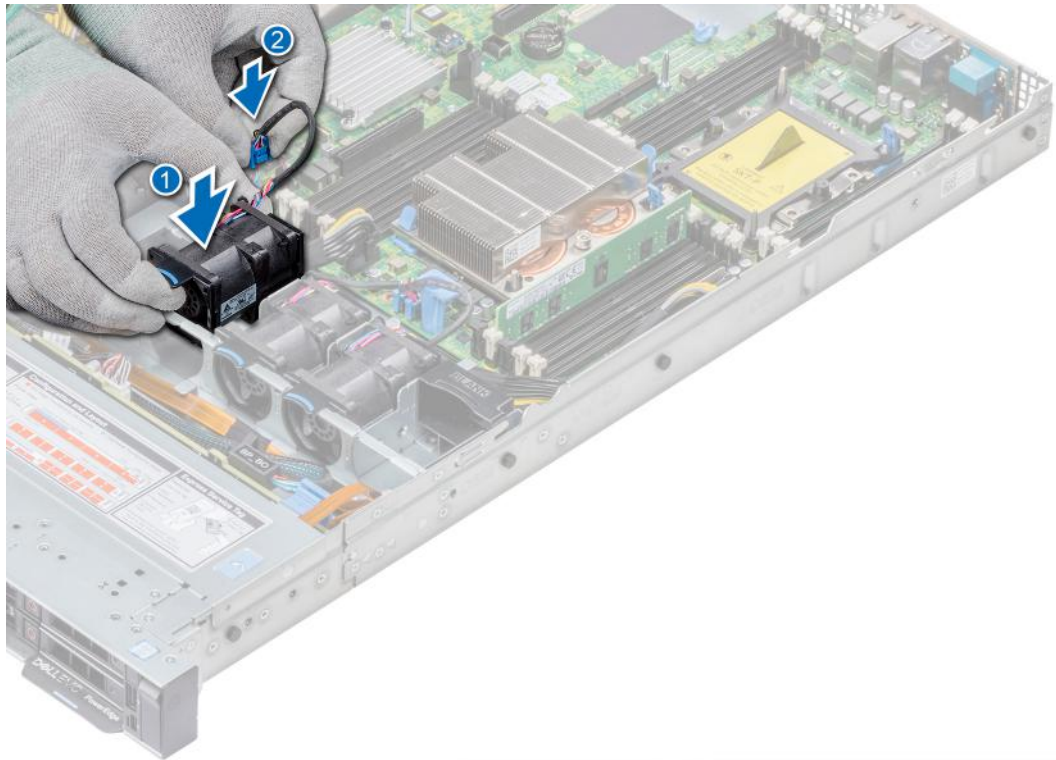
## **Installing cooling fan**

#### **Prerequisites**

1. Follow the safety guidelines listed in [Safety instructions.](#)
2. Follow the procedure listed in [Before working inside your system.](#)
3. [Remove the air shroud.](#)
4. [Remove the internal riser.](#)
5. Remove the power cable.
6. Move the cables out of the way to access the cooling fan cable connector on the system board.

#### **Steps**

1. Holding the blue touch point, place the cooling fan into the cooling fan cage.
2. Route the cooling fan cable and connect it to the connector on the system board.



**Figure 26. Installing cooling fan**

#### **Next steps**

1. [Install the internal riser.](#)
2. Connect the power cable.
3. Ensure all the cables are routed correctly.
4. [Install the air shroud.](#)
5. Follow the procedure listed in [After working inside your system.](#)

## **Intrusion switch**

### **Removing the intrusion switch**

#### **Prerequisites**

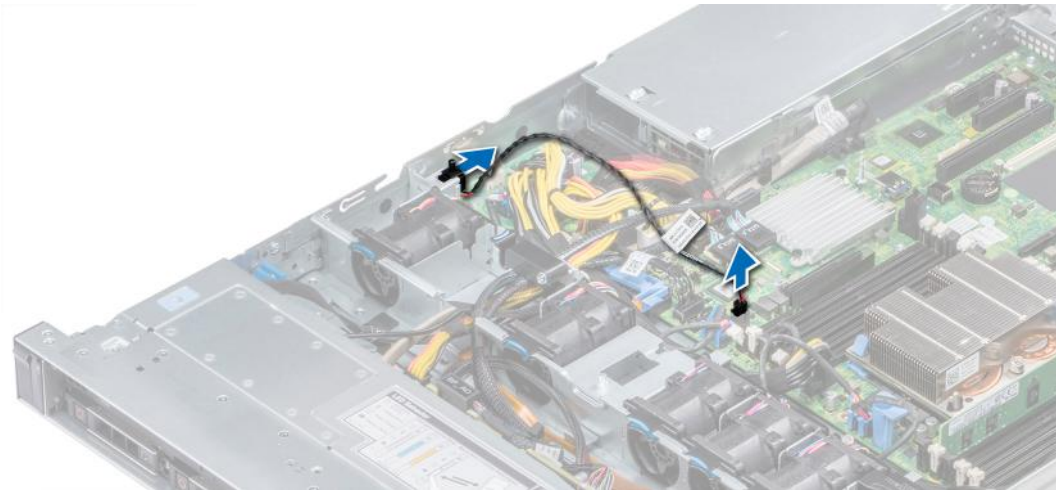
1. Follow the safety guidelines listed in [Safety instructions.](#)
2. Follow the procedure listed in [Before working inside your system.](#)
3. [Remove air shroud.](#)
4. [Remove internal PERC riser.](#)

#### **Steps**

1. Disconnect the intrusion switch cable connected to the system board.

**NOTE:** Ensure that you note the routing of the cables as you remove them from the system board.

2. Slide the intrusion switch out of the intrusion switch slot.



**Figure 27. Removing an intrusion switch**

### Next steps

Install intrusion switch.

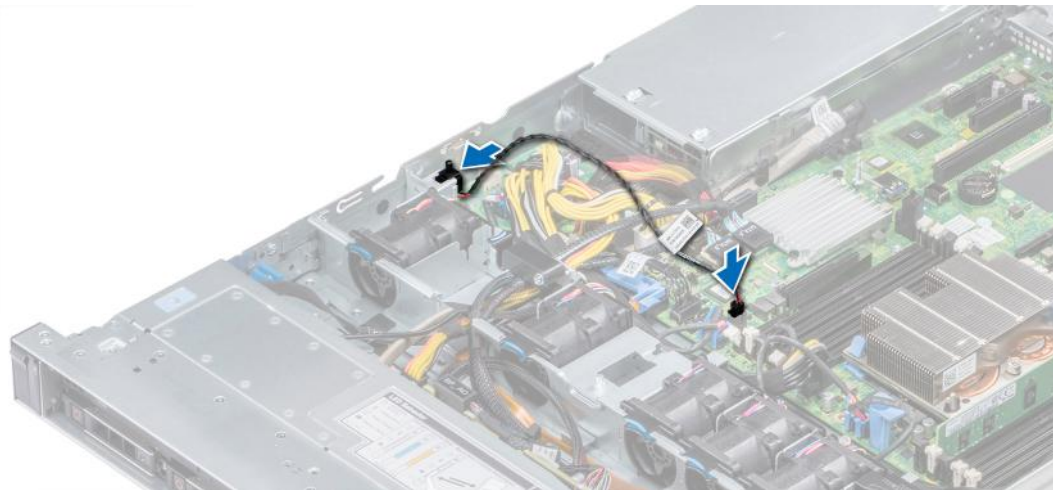
## Installing the intrusion switch

### Prerequisites

1. Follow the safety guidelines listed in [Safety instructions](#).
2. Follow the procedure listed in [Before working inside your system](#).

### Steps

1. Align the intrusion switch with the intrusion switch slot.



**Figure 28. Installing intrusion switch**

2. Slide the intrusion switch until it is firmly seated in the intrusion switch slot.
3. Connect the intrusion switch cable to the connector on the system board.

### Next steps

1. [Install internal PERC riser](#).
2. Follow the procedure listed in [After working inside your system](#).

# Drives

## Removing a drive blank

The procedure for removing 2.5-inch and 3.5-inch drive blanks is identical.

### Prerequisites

1. Follow the safety guidelines listed in [Safety instructions](#).
2. If installed, [remove the front bezel](#).

**CAUTION:** To maintain proper system cooling, drive blanks must be installed in all empty drive slots.

**CAUTION:** Mixing drive blanks from previous generations of PowerEdge servers is not supported.

### Steps

Press the release button, and slide the drive blank out of the drive slot.



Figure 29. Removing a drive blank

### Next steps

1. [Install a drive](#) or [Installing the hard drive backplane](#)

## Installing a drive blank

The procedure for installing 2.5-inch and 3.5-inch drive blanks is identical.

### Prerequisites

1. Follow the safety guidelines listed in [Safety instructions](#).
2. If installed, [remove the front bezel](#).

**CAUTION:** Mixing drive blanks from previous generations of PowerEdge servers is not supported.

### Steps

Insert the drive blank into the drive slot, and push the blank until the release button clicks into place.



Figure 30. Installing a drive blank

#### Next steps

If removed, install the front bezel.

## Removing a 2.5-inch drive from a 3.5-inch drive adapter

#### Prerequisites

1. Follow the safety guidelines listed in [Safety instructions](#).
2. Remove the 3.5-inch drive adapter from the 3.5-inch drive carrier.

**NOTE:** A 2.5-inch drive is installed in a 3.5-inch drive adapter, which is then installed in the 3.5-inch drive carrier.

#### Steps

1. Using a Phillips #2 screwdriver, remove the screws from the side of the 3.5-inch drive adapter.  
**NOTE:** If the 2.5-inch drive has Torx screw, use Torx 6 screwdriver to remove the drive from a 3.5-inch drive adapter.
2. Remove the 2.5-inch drive from the 3.5-inch drive adapter.

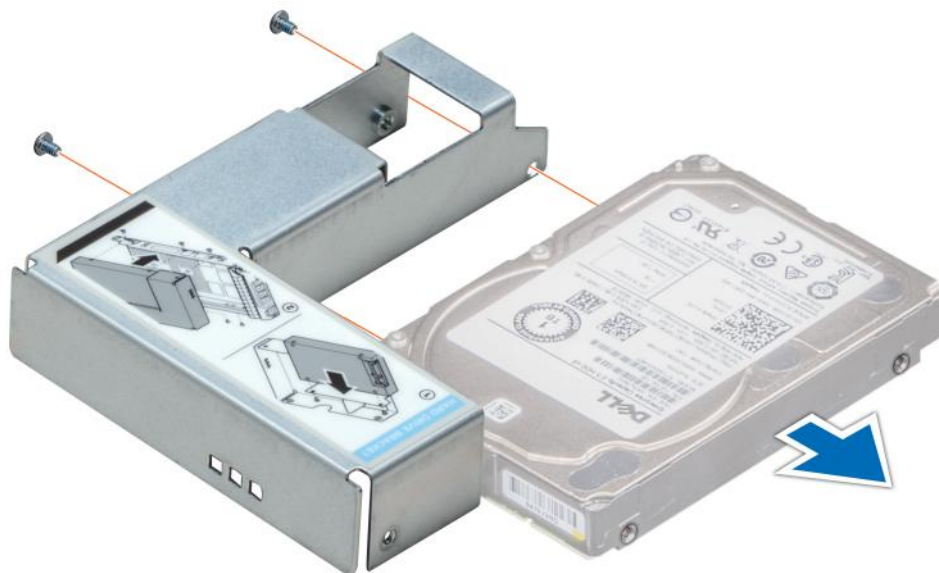


Figure 31. Removing a 2.5 inch drive from a 3.5-inch drive adapter



### Next steps

Install a 2.5-inch drive into a 3.5-inch drive adapter.

## Installing a 2.5-inch drive into a 3.5-inch drive adapter

### Prerequisites

1. Follow the safety guidelines listed in [Safety instructions](#).
2. Remove the 3.5-inch drive adapter from the 3.5-inch hot swappable drive carrier.

### Steps

1. Align the screw holes on the 2.5-inch drive with the screw holes on the 3.5-inch drive adapter.
2. Using a Phillips #2 screwdriver, secure the 2.5-inch drive to the 3.5-inch drive adapter.

**NOTE:** If the 3.5-inch drive has Torx screw, use Torx 6 screwdriver to remove the drive from a 3.5-inch drive adapter.

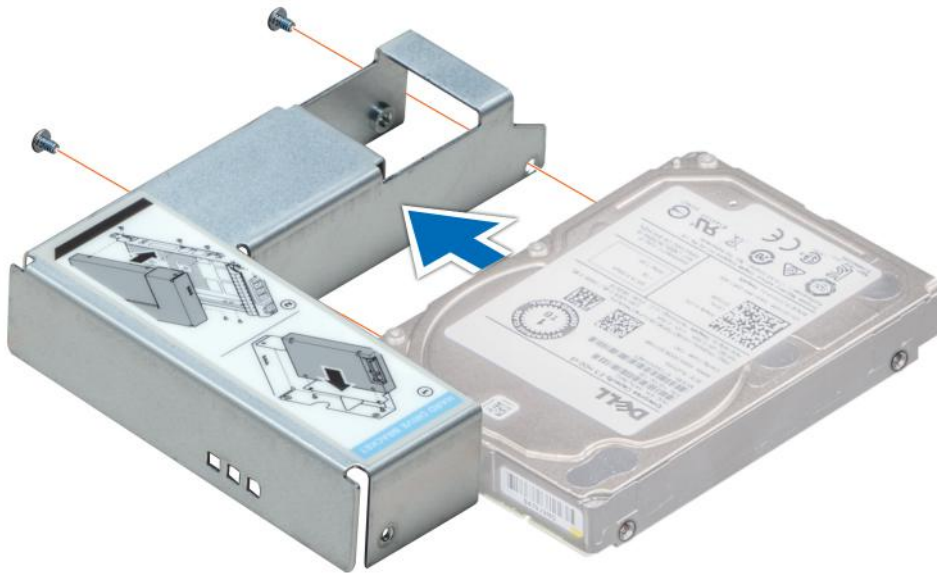


Figure 32. Installing a 2.5-inch drive into a 3.5-inch drive adapter

## Removing a 3.5-inch drive adapter from a 3.5-inch drive carrier

### Prerequisites

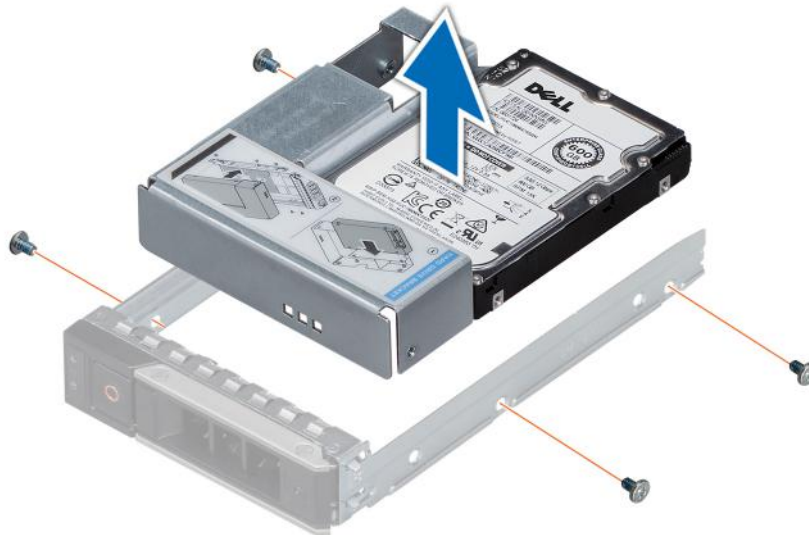
1. Follow the safety guidelines listed in [Safety instructions](#).
2. If installed, [remove the front bezel](#).
3. Remove the 3.5-inch drive carrier from the system.

### Steps

1. Using a Phillips #1 screwdriver, remove the screws from the rails on the drive carrier.

**NOTE:** If the 3.5-inch drive has Torx screw, use Torx 6 screwdriver to remove the drive from a 3.5-inch drive adapter.

2. Lift the 3.5-inch drive adapter out of the 3.5-inch drive carrier.



**Figure 33. Removing a 3.5 inch drive adapter from a 3.5-inch drive carrier**

### Next steps

Install the 3.5-inch drive carrier or -inch

## Installing a 3.5-inch drive adapter into the 3.5-inch drive carrier

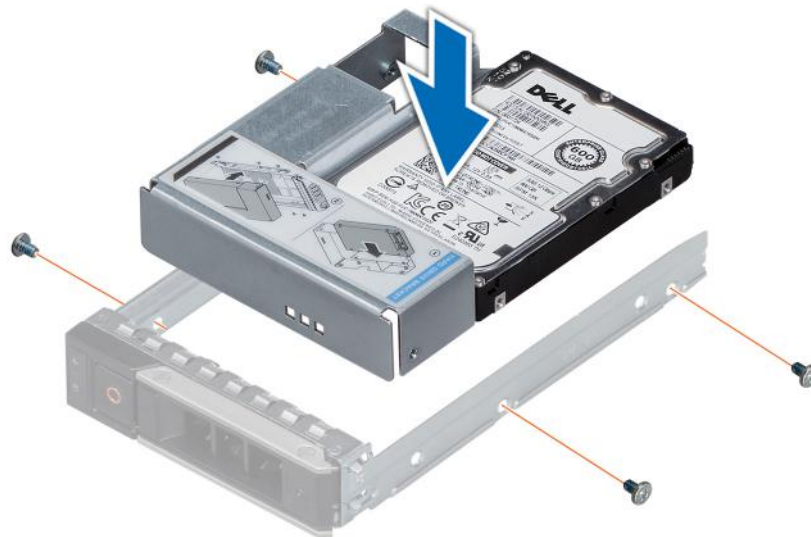
### Prerequisites

1. Follow the safety guidelines listed in [Safety instructions](#).
2. [Install the 2.5-inch drive into the 3.5-inch drive adapter](#).

### Steps

1. Insert the 3.5-inch drive adapter into the 3.5-inch drive carrier with the connector end of the drive toward the back of the 3.5-inch drive carrier.
2. Align the screw holes on the 3.5-inch drive adapter with the holes on the 3.5-inch drive carrier.
3. Using a Phillips #1 screwdriver, secure the 3.5-inch drive adapter to the 3.5-inch carrier.

**NOTE:** If the 2.5-inch drive has Torx screw, use Torx 6 screwdriver to remove the drive from a 3.5-inch drive adapter.



**Figure 34. Installing a 3.5-inch drive adapter into the 3.5-inch drive carrier**

### Next steps

1. Install the 3.5-inch drive carrier into the system.
2. If removed, [install the front bezel](#).

## Removing a hard drive

### Prerequisites

1. Follow the safety guidelines listed in [Safety instructions](#).
2. If applicable, [remove the front bezel](#).
3. Using the management software, prepare the hard drive for removal.

If the hard drive is online, the green activity or fault indicator flashes while the drive is turning off. When the hard drive indicators are off, the hard drive is ready for removal. For more information, see the documentation for the storage controller.

**CAUTION:** Before attempting to remove or install a hard drive while the system is running, see the documentation for the storage controller card to ensure that the host adapter is configured correctly to support hard drive removal and insertion.

**CAUTION:** Mixing hard drives from previous generations of PowerEdge servers is not supported.

**CAUTION:** To prevent data loss, ensure that your operating system supports drive installation. See the documentation supplied with your operating system.

### Steps

1. Press the release button to open the hard drive release handle.
2. Holding the handle, slide the hard drive out of the hard drive slot.



Figure 35. Removing a hard drive

### Next steps

1. [Install a hard drive.](#)
2. If you are not replacing the hard drive immediately, insert a hard drive blank in the empty hard drive slot to maintain proper system cooling.

## Installing a hard drive

### Prerequisites

- ⚠ **CAUTION:** Before attempting to remove or install a hard drive while the system is running, see the documentation for the storage controller card to ensure that the host adapter is configured correctly to support hard drive removal and insertion.
- ⚠ **CAUTION:** Mixing hard drives from previous generations of PowerEdge servers is not supported.
- ⚠ **CAUTION:** Combining SAS and SATA hard drives in the same RAID volume is not supported.
- ⚠ **CAUTION:** When installing a hard drive, ensure that the adjacent drives are fully installed. Inserting a hard drive carrier and attempting to lock its handle next to a partially installed carrier can damage the partially installed carrier's shield spring and make it unusable.
- ⚠ **CAUTION:** To prevent data loss, ensure that your operating system supports hot-swap drive installation. See the documentation supplied with your operating system.
- ⚠ **CAUTION:** When a replacement hot swappable drive is installed and the system is powered on, the drive automatically begins to rebuild. Ensure that the replacement drive is blank or contains data that you wish to overwrite. Any data on the replacement drive is immediately lost after the drive is installed.

1. Follow the safety guidelines listed in [Safety instructions](#).
2. If applicable, [remove the hard drive blank](#).

### Steps

1. Press the release button on the front of the hard drive carrier to open the release handle.
2. Insert the hard drive carrier into the hard drive slot and slide until the hard drive connects with the backplane.
3. Close the hard drive carrier release handle to lock the hard drive in place.



Figure 36. Installing a hard drive

#### Next steps

If applicable, [install the front bezel](#).

## Removing the drive from the drive carrier

#### Prerequisites

**CAUTION:** Mixing drives from previous generations of PowerEdge servers is not supported.

#### Steps

1. Using a Phillips #1 screwdriver, remove the screws from the slide rails on the drive carrier.
2. Lift the drive out of the drive carrier.



Figure 37. Removing the drive from the drive carrier

## Next steps

If applicable, install the drive into the drive carrier.

# Installing a drive into the drive carrier

## Prerequisites

**CAUTION:** Mixing drive carriers from other generations of PowerEdge servers is not supported.

**NOTE:** When installing a drive into the drive carrier, ensure that the screws are torqued to 4 in-lbs.

## Steps

1. Insert the drive into the drive carrier with the connector end of the drive towards the back of the carrier.
2. Align the screw holes on the drive with the screws holes on the drive carrier.  
When aligned correctly, the back of the drive is flush with the back of the drive carrier.
3. Using a Phillips #1 screwdriver, secure the drive to the drive carrier with screws.



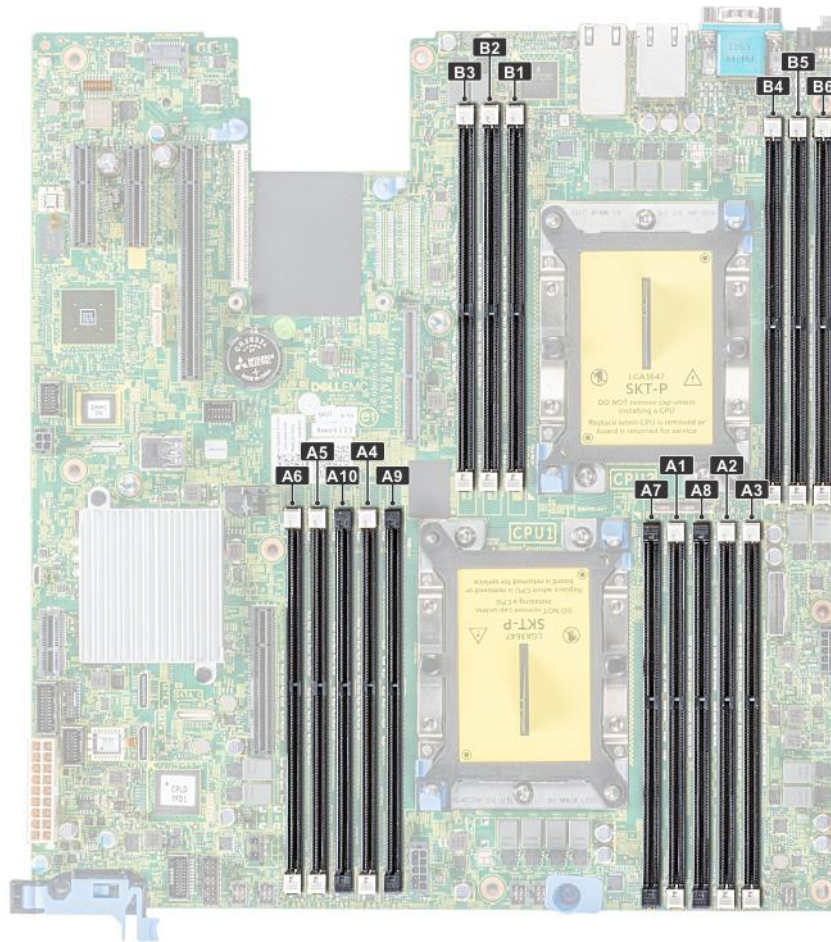
Figure 38. Installing a drive into the drive carrier

# System memory

## System memory guidelines

The PowerEdge systems support DDR4 Registered DIMMs (RDIMMs), and Load Reduced DIMMs (LRDIMMs). System memory holds the instructions that are executed by the processor.

Your system contains 16 memory sockets. Processor 1 supports up to 10 memory sockets and Processor 2 supports up to 6 memory sockets. Six memory channels are allocated to each processor. Processor 1 has four 2 DIMM slots per channel and two 1 DIMM slot per channel, Processor 2 has six 1 DIMM per channel.



**Figure 39. Memory socket locations**

Memory channels are organized as follows:

**Table 18. Memory channels**

Processor	Channel 0	Channel 1	Channel 2	Channel 3	Channel 4	Channel 5
Processor 1	Slots A1 and A7	Slots A2 and A8	Slots A3	Slots A4 and A9	Slots A5 and A10	Slots A6
Processor 2	Slots B1	Slots B2	Slots B3	Slots B4	Slots B5	Slots B6

**Table 19. Memory population**

DIMM Type	DIMMs Populated/ Channel	Voltage	Operating Frequency (in MT/s)	Maximum DIMM Rank/ Channel
RDIMM	1	1.2 V	2666, 2400, 2133, 1866	Dual rank or single rank
	2		2666, 2400, 2133, 1866	Dual rank or single rank
LRDIMM	1	1.2 V	2666, 2400, 2133, 1866	Quad rank
	2		2666, 2400, 2133, 1866	Quad rank

## General memory module installation guidelines

To ensure optimal performance of your system, observe the following general guidelines when configuring your system memory. If your system's memory configurations fail to observe these guidelines, your system might not boot, stop responding during memory configuration, or operate with reduced memory.

- System profile selected (for example, Performance Optimized, or Custom [can be run at high speed or lower])
- Maximum supported DIMM speed of the processors.
- Maximum supported DIMM speed of the processors.
- Maximum supported speed of the DIMMs

**i** **NOTE:** MT/s indicates DIMM speed in MegaTransfers per second.

The system supports Flexible Memory Configuration, enabling the system to be configured and run in any valid chipset architectural configuration. The following are the recommended guidelines for installing memory modules:

- All DIMMs must be DDR4.
- RDIMMs and LRDIMMs must not be mixed.
- 64 GB LRDIMMs that are DDP (Dual Die Package) LRDIMMs must not be mixed with 128 GB LRDIMMs that are TSV (Through Silicon Via/3DS) LRDIMMs.
- x4 and x8 DRAM based memory modules can be mixed.
- Up to two RDIMMs can be populated per channel regardless of rank count.
- Up to two LRDIMMs can be populated per channel regardless of rank count.
- A maximum of two different ranked DIMMs can be populated in a channel regardless of rank count.
- If memory modules with different speeds are installed, they will operate at the speed of the slowest installed memory module(s).
- Populate memory module sockets only if a processor is installed.
  - For single-processor systems, sockets A1 to A10 are available.
  - For dual-processor systems, sockets A1 to A10 and sockets B1 to B6 are available.
- Populate all the sockets with white release tabs first, followed by the black release tabs.
- When mixing memory modules with different capacities, populate the sockets with memory modules with the highest capacity first.

**i** **NOTE:** For example, if you want to mix 8 GB and 16 GB memory modules, populate 16 GB memory modules in the sockets with white release tabs and 8 GB memory modules in the sockets with black release tabs.

- Memory modules of different capacities can be mixed provided other memory population rules are followed.

**i** **NOTE:** For example, 8 GB and 16 GB memory modules can be mixed.

- In a dual-processor configuration, the memory configuration for each processor must be identical.

**i** **NOTE:** For example, if you populate socket A1 for processor 1, then populate socket B1 for processor 2, and so on.

- Mixing of more than two memory module capacities in one system is not supported.
- Unbalanced memory configurations will result in a performance loss so always populate memory channels identically with identical DIMMs for best performance.
- Populate six identical memory modules per processor (one DIMM per channel) at a time to maximize performance.

DIMM population update for Performance Optimized mode with quantity of 4 and 8 DIMMs per processor.

- When the DIMM quantity is 4 per processor, the population is slot 1, 2, 4, 5.
- When the DIMM quantity is 8 per processor, the population is slot 1, 2, 4, 5, 7, 8, 9, 10.

## Mode-specific guidelines





The configurations allowed depend on the memory mode selected in the System BIOS.

**Table 20. Memory operating modes**

Memory Operating Mode	Description
<b>Optimizer Mode</b>	The <b>Optimizer Mode</b> if enabled, the DRAM controllers operate independently in the 64-bit mode and provide optimized memory performance.
<b>Mirror Mode</b>	The <b>Mirror Mode</b> if enabled, the system maintains two identical copies of data in memory, and the total available system memory is one half of the total installed physical




**Table 20. Memory operating modes (continued)**

Memory Operating Mode	Description
	memory. Half of the installed memory is used to mirror the active memory modules. This feature provides maximum reliability and enables the system to continue running even during a catastrophic memory failure by switching over to the mirrored copy. The installation guidelines to enable Mirror Mode require that the memory modules be identical in size, speed, and technology, and they must be populated in sets of 6 per processor.
<b>Single Rank Spare Mode</b>	<b>Single Rank Spare Mode</b> allocates one rank per channel as a spare. If excessive correctable errors occur in a rank or channel, while the operating system is running, they are moved to the spare area to prevent errors from causing an uncorrectable failure. Requires two or more ranks to be populated in each channel.
<b>Multi Rank Spare Mode</b>	<p><b>Multi Rank Spare Mode</b> allocates two ranks per channel as a spare. If excessive correctable errors occur in a rank or channel, while the operating system is running, they are moved to the spare area to prevent errors from causing an uncorrectable failure. Requires three or more ranks to be populated in each channel.</p> <p>With single rank memory sparing enabled, the system memory available to the operating system is reduced by one rank per channel.</p> <p>For example, in a dual-processor configuration with sixteen 16 GB dual-rank memory modules, the available system memory: 16 GB x 16(memory modules) - 8GB(1 rank sparing/channel) x 12(channel) = 256 GB - 96 GB = 160 GB. For multi rank sparing, in a dual-processor configuration with sixteen 64 GB quad-rank memory modules, the available system memory: 64 GB x 16(memory modules) - 32 GB(2 rank sparing/channel) x 12 (channel) = 1024 GB - 384 GB = 640 GB.</p> <p> <b>NOTE:</b> To use memory sparing, this feature must be enabled in the BIOS menu of System Setup.</p> <p> <b>NOTE:</b> Memory sparing does not offer protection against a multi-bit uncorrectable error.</p>
<b>Dell Fault Resilient Mode</b>	<p>The <b>Dell Fault Resilient Mode</b> if enabled, the BIOS creates an area of memory that is fault resilient. This mode can be used by an OS that supports the feature to load critical applications or enables the OS kernel to maximize system availability.</p> <p> <b>NOTE:</b> This feature is only supported in Gold and Platinum Intel processors.</p> <p> <b>NOTE:</b> Memory configuration has to be of same size DIMM, speed, and rank.</p>

## Optimizer Mode

This mode supports Single Device Data Correction (SDDC) only for memory modules that use x4 device width. It does not impose any specific slot population requirements.

- Dual processor: Populate the slots in round robin sequence starting with processor 1.

 **NOTE:** Processor 1 and processor 2 population should match.

**Table 21. Memory population rules**

Processor	Configuration	Memory population	Memory population information
Single processor	Optimizer (Independent channel) population order	1, 2, 3, 4, 5, 6, 7, 8, 9, 10	<ul style="list-style-type: none"> <li>• Populate in this order, odd amount allowed.</li> <li>• Odd number of DIMM population is allowed.</li> </ul>

**Table 21. Memory population rules (continued)**

Processor	Configuration	Memory population	Memory population information
			<p><b>i</b> <b>NOTE:</b> Odd number of DIMMs will result in unbalanced memory configurations, which in turn will result in performance loss. It is recommended to populate all memory channels identically with identical DIMMs for best performance.</p> <ul style="list-style-type: none"> <li>• Optimizer population order is not traditional for 4 and 8 DIMM installations of single processor.                             <ul style="list-style-type: none"> <li>○ For 4 DIMMs: A1, A2, A4, A5</li> <li>○ For 8 DIMMs: A1, A2, A4, A5, A7, A8, A9, A10</li> </ul> </li> </ul>
	Mirror population order	{1, 2, 3, 4, 5, 6}	Mirroring is supported with 6 DIMM slots per processor.
	Single rank sparing population order	1, 2, 3, 4, 5, 6, 7, 8, 9, 10	Populate in this order, odd amount allowed. Requires two ranks or more per channel.
	Multi rank sparing population order	1, 2, 3, 4, 5, 6, 7, 8, 9, 10	Populate in this order, odd amount allowed. Requires three ranks or more per channel.
Dual processor (Populate round robin starting with processor1)	Optimized (Independent channel) population order	A{1}, B{1}, A{2}, B{2}, A{3}, B{3}...	<ul style="list-style-type: none"> <li>• Odd amount of DIMM slots per processor allowed.</li> <li>• Odd number of DIMM population is allowed.</li> </ul> <p><b>i</b> <b>NOTE:</b> Odd number of DIMMs will result in unbalanced memory configurations, which in turn will result in performance loss. It is recommended to populate all memory channels identically with identical DIMMs for best performance.</p> <ul style="list-style-type: none"> <li>• Optimizer population order is not traditional for 8 and 14 DIMM installations of dual processor.                             <ul style="list-style-type: none"> <li>○ For 8 DIMMs: A1, A2, A4, A5, B1, B2, B4, B5</li> <li>○ For 14 DIMMs: A1, A2, A4, A5, A7, A8, A9, A10, B1, B2, B3, B4, B5, B6</li> </ul> </li> </ul>
	Mirroring population order	A{1, 2, 3, 4, 5, 6}, B{1, 2, 3, 4, 5, 6}	Mirroring is supported with 6 DIMM slots per processor.

**Table 21. Memory population rules (continued)**

Processor	Configuration	Memory population	Memory population information
	Single rank sparing population order	A{1}, B{1}, A{2}, B{2}, A{3}, B{3}...	Populate in this order, odd amount per processor allowed. Requires two ranks or more per channel.
	Multi rank sparing population order	A{1}, B{1}, A{2}, B{2}, A{3}, B{3}...	Populate in this order, odd amount per processor allowed. Requires three ranks or more per channel.

## Removing a memory module

### Prerequisites

1. Follow the safety guidelines listed in [Safety instructions](#).
2. Follow the procedure listed in [Before working inside your system](#).
3. If applicable, [remove the air shroud](#).

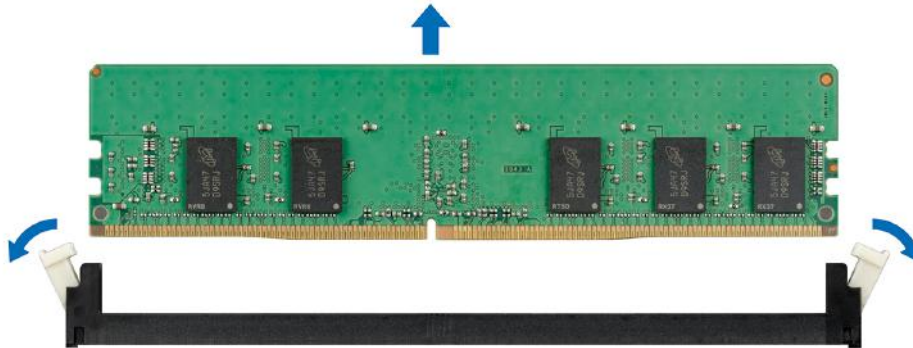
**⚠ WARNING:** Allow the memory modules to cool after you power off the system. Handle the memory modules by the card edges and avoid touching the components or metallic contacts on the memory module.

### Steps

1. Locate the appropriate memory module socket.

**⚠ CAUTION:** Handle each memory module only by the card edges, ensuring not to touch the middle of the memory module or metallic contacts.

2. Push the ejectors outward on both ends of the memory module socket to release the memory module from the socket.
3. Lift and remove the memory module from the system.



**Figure 40. Removing a memory module**

### Next steps

1. [Install the memory module](#).

## Installing a memory module

### Prerequisites

Follow the safety guidelines listed in [Safety instructions](#)

### Steps

1. Locate the appropriate memory module socket.

**CAUTION:** Handle each memory module only by the card edges, ensuring not to touch the middle of the memory module or metallic contacts.

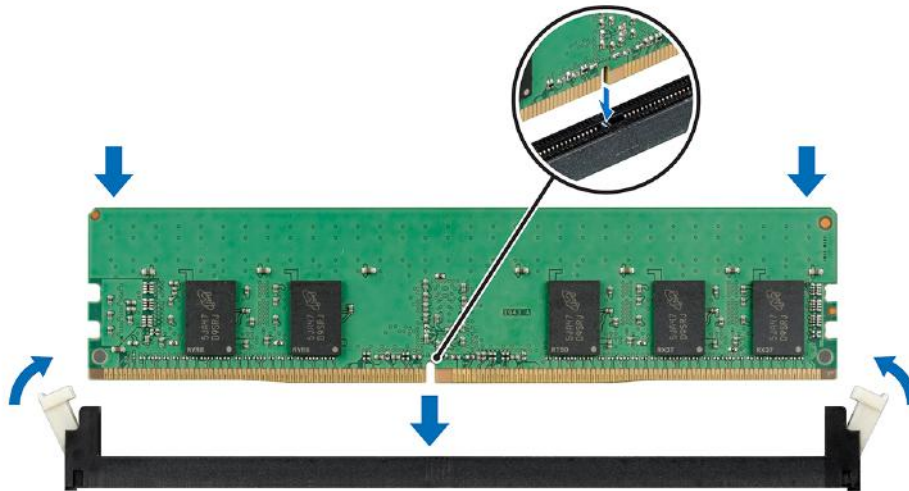
**CAUTION:** To prevent damage to the memory module or the memory module socket during installation, do not bend or flex the memory module. You must insert both ends of the memory module simultaneously.

2. Open the ejectors on the memory module socket outward to allow the memory module to be inserted into the socket.
3. Align the edge connector of the memory module with the alignment key of the memory module socket, and insert the memory module in the socket.

**CAUTION:** Do not apply pressure at the center of the memory module; apply pressure at both ends of the memory module evenly.

**NOTE:** The memory module socket has an alignment key that enables you to install the memory module in the socket in only one orientation.

4. Press the memory module with your thumbs until the socket levers firmly click into place.



**Figure 41. Installing a memory module**

#### Next steps

1. [Install the air shroud.](#)
2. Follow the procedure listed in [After working inside your system.](#)
3. To verify if the memory module has been installed properly, press F2 and navigate to **System Setup Main Menu > System BIOS > Memory Settings**. In the **Memory Settings** screen, the System Memory Size must reflect the updated capacity of the installed memory.
4. If the value is incorrect, one or more of the memory modules may not be installed properly. Ensure that the memory module is firmly seated in the memory module socket.
5. Run the system memory test in system diagnostics.

## Processors and heat sinks

### Removing a processor and heat sink module

#### Prerequisites

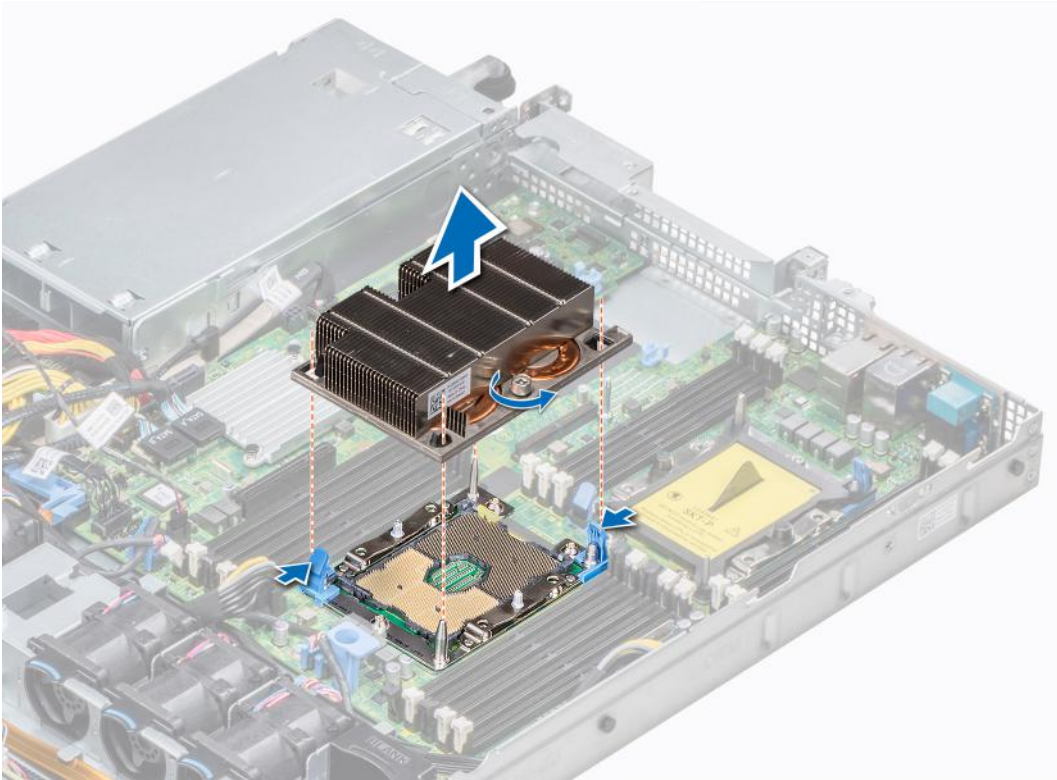
**WARNING:** The heat sink may be hot to touch for some time after the system is powered down. Allow the heat sink to cool before removing it.

1. Follow the safety guidelines listed in [Safety instructions.](#)

2. Follow the procedure listed in [Before working inside your system](#).
3. If applicable, [remove the air shroud](#).

### Steps

1. Using a Torx #T30 screwdriver, loosen the screws on the heat sink in the order below:
  - a. Loosen the first screw three turns.
  - b. Loosen the second screw completely.
  - c. Return to the first screw and loosen it completely.
2. Pushing both blue retention clips simultaneously, lift the processor and heat sink module (PHM) processor and heat sink module
3. Set the PHM aside with the processor side facing up.



**Figure 42. Removing processor and heat sink module**

### Next steps

[Install the PHM.](#)

## Installing a processor and heat sink module

### Prerequisites

**CAUTION:** Never remove the heat sink from a processor unless you intend to replace the processor. The heat sink is necessary to maintain proper thermal conditions.

1. Follow the safety guidelines listed in [Safety instructions](#).
2. If installed, remove the processor blank and CPU dust cover.

### Steps

1. Align the pin 1 indicator of the heat sink to the system board and then place the processor and heat sink module (PHM) on the processor socket.

**CAUTION:** To avoid damaging the fins on the heat sink, do not press down on the heat sink fins.

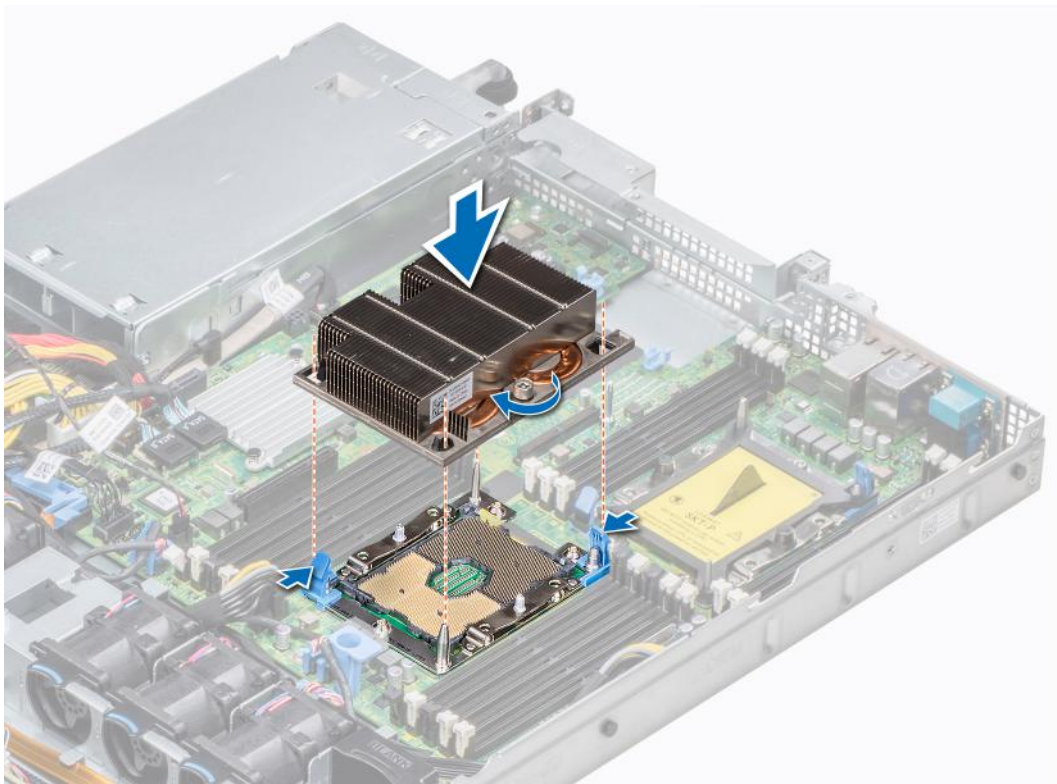
**NOTE:** Ensure that the PHM is held parallel to the system board to prevent damaging the components.

2. Push the blue retention clips inward to allow the heat sink to drop into place.
3. Using the Torx #T30 screwdriver, tighten the screws on the heat sink in the order below:
  - a. Partially tighten the first screw (approximately 3 turns).
  - b. Tighten the second screw completely.
  - c. Return to the first screw and tighten it completely.

If the PHM slips off the blue retention clips when the screws are partially tightened, follow these steps to secure the PHM:

- a. Loosen both the heat sink screws completely.
- b. Lower the PHM on to the blue retention clips, following the procedure described in step 2.
- c. Secure the PHM to the system board, following the replacement instructions listed in this step above. 4.

**NOTE:** The processor and heat sink module retention screws should not be tightened to more than 0.13 kgf-m (1.35 N.m or 12 in-lbf).



**Figure 43. Installing the processor and heat sink module**

#### Next steps

1. Follow the procedure listed in [After working inside your system](#).

## Removing the processor from the processor and heat sink module

#### Prerequisites

**NOTE:** Only remove the processor from the processor and heat sink module if you are replacing the processor or heat sink. This procedure is not required when replacing a system board.

1. Follow the safety guidelines listed in [Safety instructions](#).

2. Follow the procedure listed in [Before working inside your system](#).
3. [remove the air shroud](#).
4. [Remove the processor and heat sink module](#).

### Steps

1. Place the heat sink with the processor side facing up.
2. Insert a flat blade screwdriver into the release slot marked with a yellow label. Twist (do not pry) the screwdriver to break the thermal paste seal.
3. Push the retaining clips on the processor bracket to unlock the bracket from the heat sink.
4. Lift the bracket and the processor away from the heat sink, and place the processor connector side down on the processor tray.
5. Flex the outer edges of the bracket to release the bracket from the processor.

**i** **NOTE:** Ensure that the processor and the bracket are placed in the tray after you remove the heat sink.



**Figure 44. Removing the processor bracket**

### Next steps

[Install the processor into the processor and heat sink module](#).

## Installing the processor into a processor and heat sink module

### Prerequisites

Follow the safety guidelines listed in [Safety instructions](#)

### Steps

1. Place the processor in the processor tray.  
**i** **NOTE:** Ensure that the pin 1 indicator on the processor tray is aligned with the pin 1 indicator on the processor.
2. Flex the outer edges of the bracket around the processor ensuring that the processor is locked into the clips on the bracket.  
**i** **NOTE:** Ensure that the pin 1 indicator on the bracket is aligned with the pin 1 indicator on the processor before placing the bracket on the processor.  
**i** **NOTE:** Ensure that the processor and the bracket are placed in the tray before you install the heat sink.

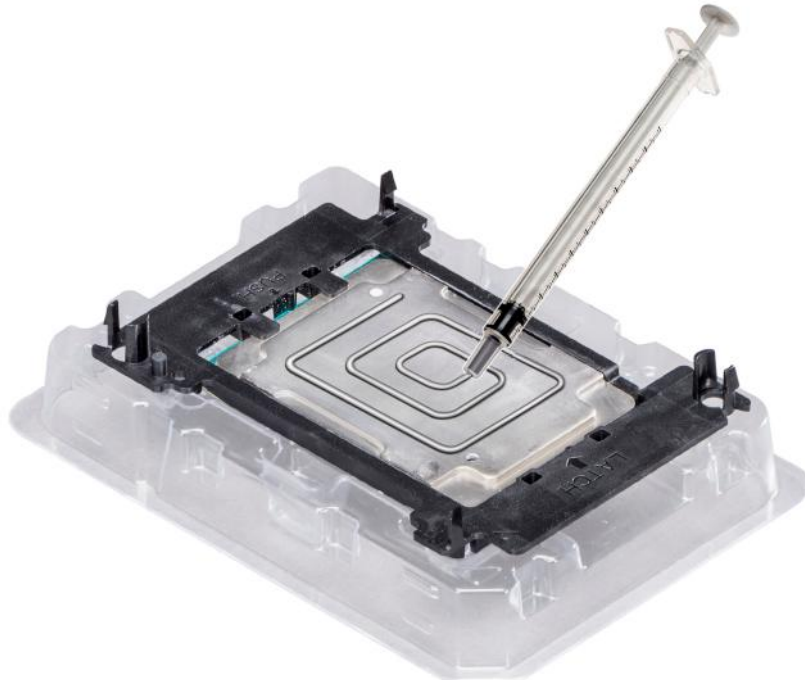


**Figure 45. Installing the processor bracket**

3. If you are using an existing heat sink, remove the thermal grease from the heat sink by using a clean lint-free cloth.
4. Use the thermal grease syringe included with your processor kit to apply the grease in a quadrilateral design on the top of the processor.

**⚠ CAUTION:** Applying too much thermal grease can result in excess grease coming in contact with and contaminating the processor socket.

**ℹ NOTE:** The thermal grease syringe is intended for single use only. Dispose the syringe after you use it.



**Figure 46. Applying thermal grease on top of the processor**

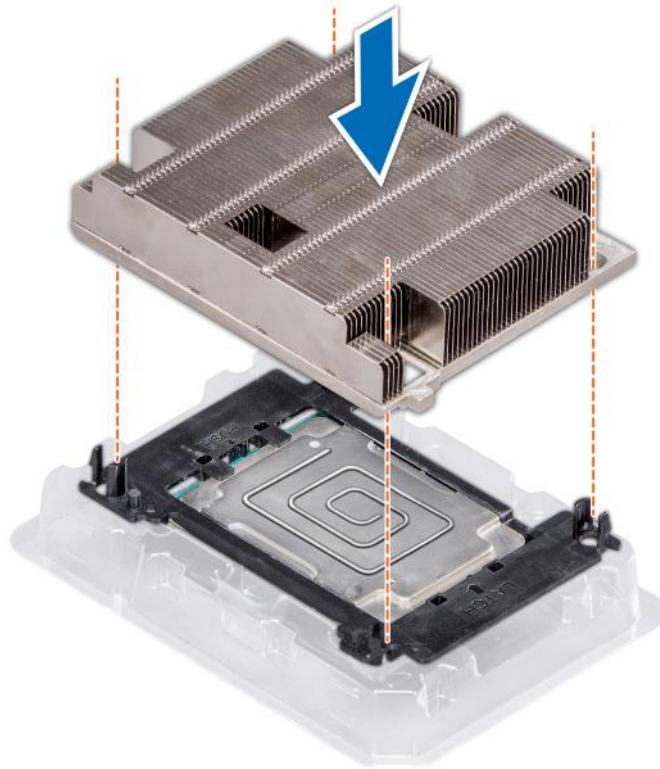
5. Place the heat sink on the processor and push down on the base of the heat sink until the bracket locks onto the heat sink.

**ℹ NOTE:**

- Ensure that the two guide pin holes on the bracket match the guide holes on the heat sink.



- Do not press on the heat sink fins.
- Ensure that the pin 1 indicator on the heat sink is aligned with the pin 1 indicator on the bracket before placing the heat sink onto the processor and bracket.



**Figure 47. Installing the heat sink onto the processor**

#### Next steps

1. Install the processor and heat sink module.
2. Install the air shroud.
3. Follow the procedure listed in [After working inside your system](#).

## Internal PERC riser

### Removing the internal PERC riser

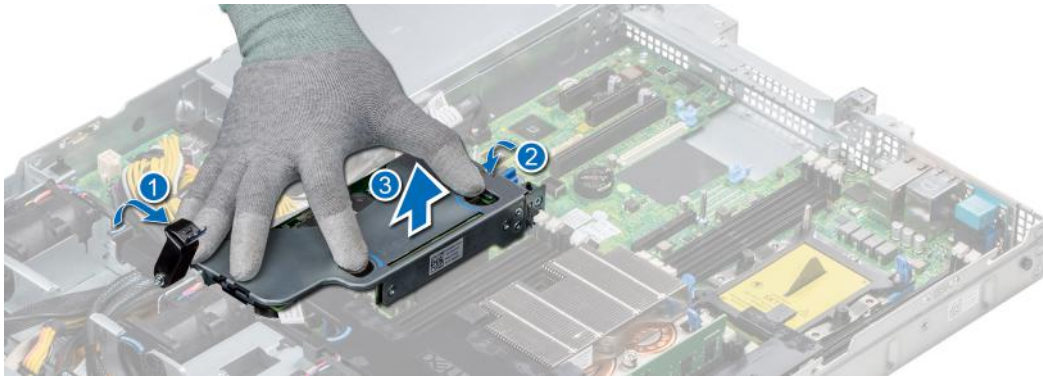
**NOTE:** The new generation PERC 11 H750, H350, and HBA350i adapters cannot be mixed with the PERC H740P, H730P, H330, HBA330 adapters of the previous generations in one system. For more information, see [Cable routing](#).

#### Prerequisites

1. Follow the safety guidelines listed in [Safety instructions](#).
2. Follow the procedure listed in [Before working inside your system](#).
3. [Remove the air shroud](#).

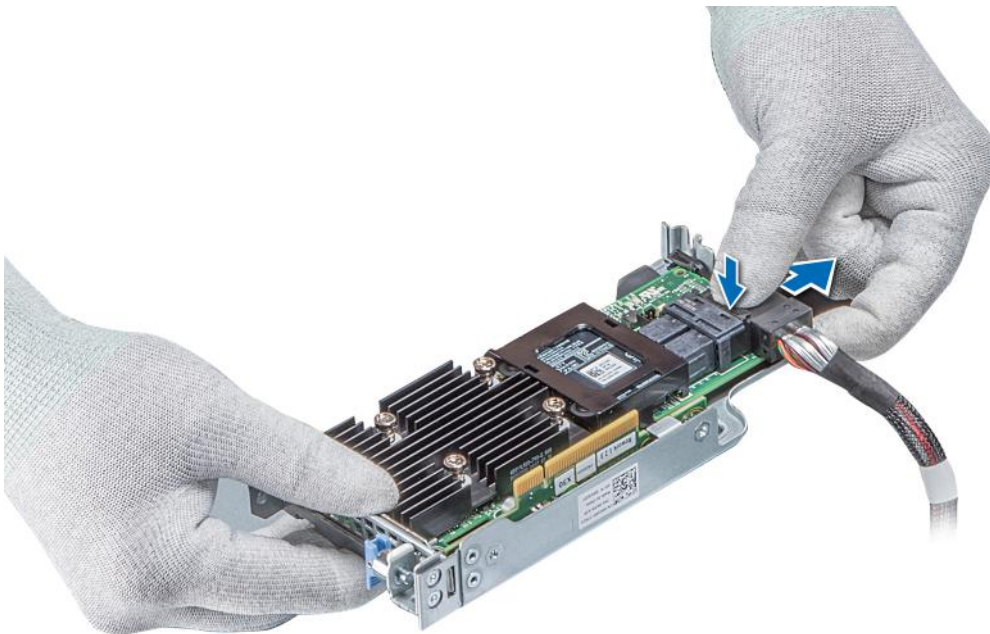
#### Steps

1. Open the cable guiding latch for easy access.
2. Lower the plunger.
3. Press the cable connector and disconnect the PERC cable from the backplane.
4. Hold the blue touch points and lift the internal PERC riser out of the system.



**Figure 48. Removing internal PERC riser**

5. Turn the internal riser so that the PERC card is facing up.
6. Press the cable connector and disconnect the cable that is connected to the internal PERC card.



**Figure 49. Disconnecting the cable from internal PERC card**

### Next steps

1. [Install the air shroud.](#)
2. Follow the procedure listed in [After working inside your system.](#)
3. [Install the internal PERC card.](#)

## Installing the internal PERC riser

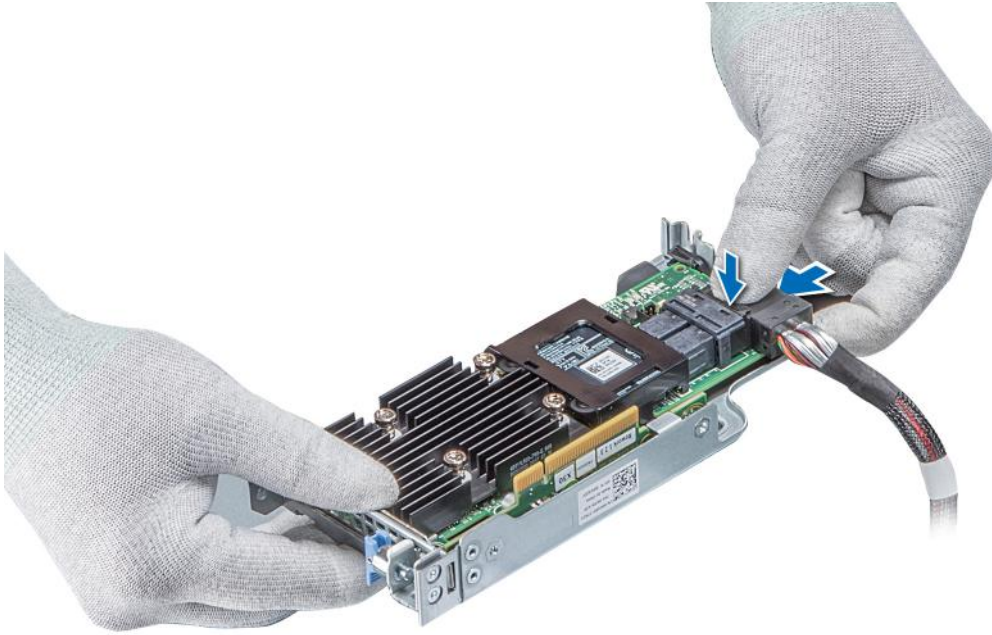
**NOTE:** The new generation PERC 11 H750, H350, and HBA350i adapters cannot be mixed with the PERC H740P, H730P, H330, HBA330 adapters of the previous generations in one system. For more information, see [Cable routing.](#)

### Prerequisites

Follow the safety guidelines listed in [Safety instructions.](#)

## Steps

1. Connect the cable to the internal PERC card.



**Figure 50. Connecting the cable to internal PERC riser**

2. Holding the blue touch points, align the slot on the internal PERC riser to the guide on the system board.
3. Insert the internal riser card's edge connector firmly into the system board connector until the riser is fully seated.
4. Lift the plunger to lock the riser in place.



**Figure 51. Installing internal PERC riser**

5. Connect the cables to the backplane and then route the cables to the cable guiding latch to close the latch.

## Next steps

1. [Install the air shroud.](#)
2. Follow the procedure listed in [After working inside your system.](#)

## Removing the PERC card from the internal PERC riser

### Prerequisites

1. Follow the safety guidelines listed in [Safety instructions](#).
2. Follow the procedure listed in [Before working inside your system](#).
3. [Remove the air shroud](#).
4. [Remove the internal PERC riser](#).

### Steps

1. Using a Phillips #2 screwdriver, remove the screw that secures the PERC card to the internal PERC riser.
2. Pull the PERC card out of the connector on the internal PERC riser.

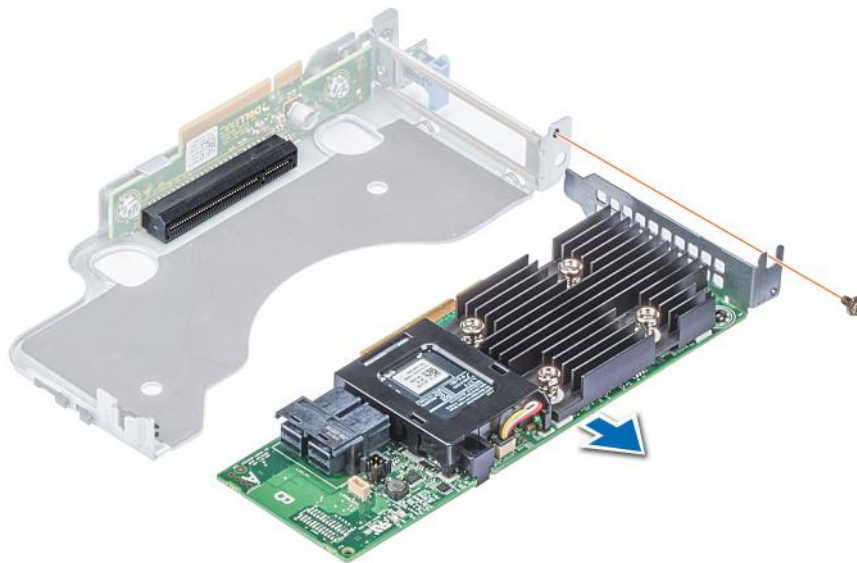


Figure 52. Removing the PERC card from the internal PERC riser

### Next steps

1. [Install the PERC card into the internal PERC riser](#).
2. [Replace the air shroud](#).
3. Follow the procedure listed in [After working inside your system](#).

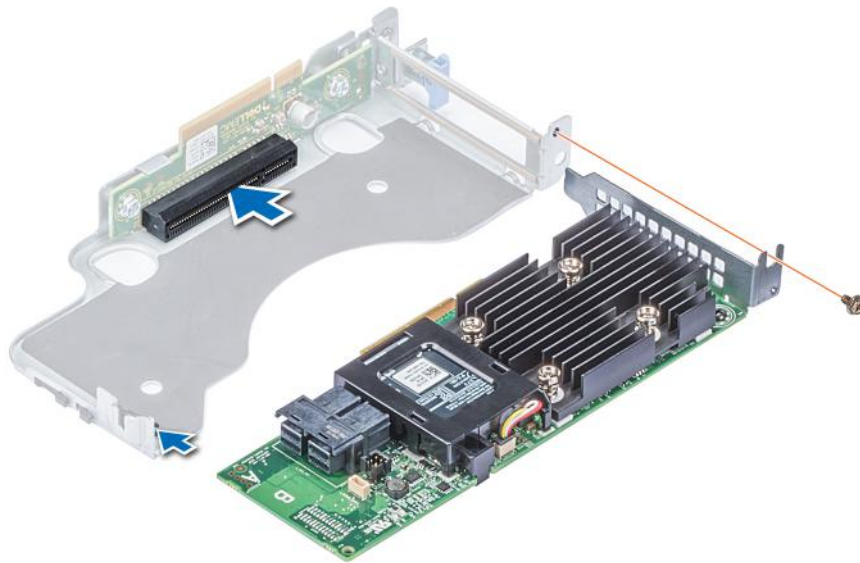
## Installing PERC card into the internal PERC riser

### Prerequisites

1. Follow the safety guidelines listed in [Safety instructions](#).

### Steps

1. Insert the PERC card into the internal PERC riser and push the card in.
2. Using a Phillips #2 screwdriver, replace the screw to secure the PERC card on the internal PERC riser.



**Figure 53. Installing PERC card into internal PERC riser**

**Next steps**

1. Install the internal PERC riser.
2. Install the air shroud.
3. Follow the procedure listed in [After working inside your system](#).

## Expansion cards and expansion card risers

**NOTE:** A System Event Log (SEL) event is logged if an expansion card riser is not supported or missing. It does not prevent your system from turning on. However, if a F1/F2 pause occurs, an error message is displayed.

### Expansion card installation guidelines

Depending on your system configuration, the following PCI Express (PCIe) generation 3 expansion cards are supported:

**Table 22. Expansion card riser configurations**

Expansion card riser	PCIe slots on the riser	Height	Length	Link
LOM riser	Slot 1	Mezz type	Mezz type	x8
Right riser	Slot 2	Low Profile	Half Length	x16
Right riser	Slot 2	Full Height	Half Length	x16
PCIe passive bridge	Slot-integrated	Low Profile	Half Length	x8
Internal riser	Slot-integrated	Low Profile	Half Length	x8
Left riser	Slot 3	Low Profile	Half Length	x16

**NOTE:** The expansion card slots are not hot-swappable.

The following table provides guidelines for installing expansion cards to ensure proper cooling and mechanical fit. The expansion cards with the highest priority should be installed first using the slot priority indicated. All the other expansion cards should be installed in the card priority and slot priority order.

**Table 23. Riser configurations: No riser**

Card Type	Slot Priority	Form Factor
PERC9.14G(Foxconn)	Integrated Slot	Low Profile
RAID - PERC9.14G/PERC10 (Internal)/ PERC11 (Dell)	Integrated Slot	Low Profile
Non-RAID - PERC 11 (Internal) (Dell)	Integrated Slot	Low Profile
1 Gb NIC Foxconn	1	OCP

**Table 24. Riser configurations: FH (Full Height riser\*1)**

Card Type	Slot Priority	Form Factor
PERC9.14G (Foxconn)	2	Full Height
PERC9.14G (Foxconn)	Integrated Slot	Low Profile
RAID - PERC9.14G/PERC10 (Internal)/ PERC11 (Dell)	Integrated Slot	Low Profile
Non-RAID - PERC 11 (Internal) (Dell)	Integrated Slot	Low Profile
Non-RAID - PERC 11 (External) (Dell)	2	Full Height
RAID PERC10 (External) (Dell)	2	Full Height
NVMe PCIe SSD (Samsung, Intel)	2	Full Height
1G NICs (Broadcom)	2	Full Height
10G NICs (Broadcom)	2	Full Height
25G NICs (Broadcom)	2	Full Height
1G NICs (Intel)	2	Full Height
10G NICs (Intel)	2	Full Height
25G NICs (Intel)	2	Full Height
40G NICs (Intel)	2	Full Height
FC8 HBA (Emulex)	2	Full Height
FC16 HBA (Emulex)	2	Full Height
InfiniBand HCA FDR (Mellanox)	2	Full Height
10G NICs (Mellanox)	2	Full Height
25G NICs (Mellanox)	2	Full Height
40G NICs (Mellanox)	2	Full Height
100G NICs (Mellanox)	2	Full Height
FC8 HBA (QLogic)	2	Full Height
FC16 HBA (QLogic)	2	Full Height
10G NICs (QLogic)	2	Full Height
25G NICs (QLogic)	2	Full Height
Omni-Path HFI (Intel)	2	Full Height
10G NICs (Solarflare)	2	Full Height

**Table 24. Riser configurations: FH (Full Height riser\*1) (continued)**

25G NICs (Solarflare)	2	Full Height
1 Gb NIC (Broadcom)	1	OCP
10 Gb NIC (Broadcom)	1	OCP
25 Gb NIC (Broadcom)	1	OCP
HWRAID BOSS	2	Full Height

**Table 25. Riser configurations: LP (Low Profile riser\*1)**

<b>Card Type</b>	<b>Slot Priority</b>	<b>Form Factor</b>
PERC9.14G (Foxconn)	Integrated Slot	Low Profile
HBA: External adapter (Dell)	3	Low Profile
RAID - PERC9.14G/PERC10 (Internal)/ PERC11 (Dell)	Integrated Slot	Low Profile
Non-RAID - PERC 11 (Internal) (Dell)	Integrated Slot	Low Profile
Non-RAID - PERC 11 (External) (Dell)	3	Low Profile
PERC 10 External adapter (Dell)	3	Low Profile
RAID PERC10 (External) (Dell)	3	Low Profile
NVMe PCIe SSD (Samsung, Intel)	3	Low Profile
1G NICs (Broadcom)	3	Low Profile
10G NICs (Broadcom)	3	Low Profile
25G NICs (Broadcom)	3	Low Profile
1G NICs (Intel)	3	Low Profile
10G NICs (Intel)	3	Low Profile
25G NICs (Intel)	3	Low Profile
40G NICs (Intel)	3	Low Profile
FC8 HBA (Emulex)	3	Low Profile
FC16 HBA (Emulex)	3	Low Profile
InfiniBand HCA FDR (Mellanox)	3	Low Profile
10G NICs (Mellanox)	3	Low Profile
25G NICs (Mellanox)	3	Low Profile
40G NICs (Mellanox)	3	Low Profile
100G NICs (Mellanox)	3	Low Profile
FC8 HBA (QLogic)	3	Low Profile
FC16 HBA (QLogic)	3	Low Profile
10G NICs (QLogic)	3	Low Profile
25G NICs (QLogic)	3	Low Profile
Omni-Path HFI (Intel)	3	Low Profile
10G NICs (Solarflare)	3	Low Profile
25G NICs (Solarflare)	3	Low Profile
1 Gb NIC (Broadcom)	1	OCP

**Table 25. Riser configurations: LP (Low Profile riser\*1) (continued)**

10 Gb NIC (Broadcom)	1	OCP
25 Gb NIC (Broadcom)	1	OCP
HWRAID BOSS	3	Low Profile

**Table 26. Riser configurations: LP+LP (Low Profile riser\*2)**

<b>Card Type</b>	<b>Slot Priority</b>	<b>Form Factor</b>
PERC9.14G (Foxconn)	Integrated Slot	Low Profile
HBA: External adapter (Dell)	3, 2	Low Profile
RAID - PERC9.14G/PERC10 (Internal)/PERC11 (Dell)	Integrated Slot	Low Profile
Non-RAID - PERC 11 (Internal) (Dell)	Integrated Slot	Low Profile
Non-RAID - PERC 11 (External) (Dell)	3, 2	Low Profile
PERC 10 External adapter (Dell)	3, 2	Low Profile
RAID PERC10 (External) (Dell)	3, 2	Low Profile
NVMe PCIe SSD (Samsung, Intel)	3, 2	Low Profile
1G NICs (Broadcom)	3, 2	Low Profile
10G NICs (Broadcom)	3, 2	Low Profile
25G NICs (Broadcom)	3, 2	Low Profile
1G NICs (Intel)	3, 2	Low Profile
10G NICs (Intel)	3, 2	Low Profile
25G NICs (Intel)	3, 2	Low Profile
40G NICs (Intel)	3, 2	Low Profile
FC8 HBA (Emulex)	3, 2	Low Profile
FC16 HBA (Emulex)	3, 2	Low Profile
InfiniBand HCA FDR (Mellanox)	3, 2	Low Profile
10G NICs (Mellanox)	3, 2	Low Profile
25G NICs (Mellanox)	3, 2	Low Profile
40G NICs (Mellanox)	3, 2	Low Profile
100G NICs (Mellanox)	3, 2	Low Profile
FC8 HBA (QLogic)	3, 2	Low Profile
FC16 HBA (QLogic)	3, 2	Low Profile
10G NICs (QLogic)	3, 2	Low Profile
25G NICs (QLogic)	3, 2	Low Profile
Omni-Path HFI (Intel)	3, 2	Low Profile
10G NICs (Solarflare)	3, 2	Low Profile
25G NICs (Solarflare)	3, 2	Low Profile
1 Gb NIC (Broadcom)	1	OCP
10 Gb NIC (Broadcom)	1	OCP
25 Gb NIC (Broadcom)	1	OCP



**Table 26. Riser configurations: LP+LP (Low Profile riser\*2) (continued)**

HWRAID BOSS	3, 2	Low Profile
-------------	------	-------------

**Table 27. Riser configurations: LP+LP+NVMme Bridge (Low Profile riser\*2)**

Card Type	Slot Priority	Form Factor
PERC9.14G (Foxconn)	3	Low Profile
HBA: External adapter (Dell)	2	Low Profile
RAID - PERC9.14G/PERC10 (Internal)/ PERC11 (Dell)	3	Low Profile
Non-RAID - PERC 11 (Internal) (Dell)	3	Low Profile
Non-RAID - PERC 11 (External) (Dell)	2	Low Profile
PERC 10 External adapter (Dell)	2	Low Profile
RAID PERC10 (External) (Dell)	2	Low Profile
NVMe PCIe SSD (Samsung, Intel)	2	Low Profile
1G NICs (Broadcom)	2	Low Profile
10G NICs (Broadcom)	2	Low Profile
25G NICs (Broadcom)	2	Low Profile
1G NICs (Intel)	2	Low Profile
10G NICs (Intel)	2	Low Profile
25G NICs (Intel)	2	Low Profile
40G NICs (Intel)	2	Low Profile
FC8 HBA (Emulex)	2	Low Profile
FC16 HBA (Emulex)	2	Low Profile
InfiniBand HCA FDR (Mellanox)	2	Low Profile
10G NICs (Mellanox)	2	Low Profile
25G NICs (Mellanox)	2	Low Profile
40G NICs (Mellanox)	2	Low Profile
100G NICs (Mellanox)	2	Low Profile
FC8 HBA (QLogic)	2	Low Profile
FC16 HBA (QLogic)	2	Low Profile
10G NICs (QLogic)	2	Low Profile
25G NICs (QLogic)	2	Low Profile
Omni-Path HFI (Intel)	2	Low Profile
10G NICs (Solarflare)	2	Low Profile
25G NICs (Solarflare)	2	Low Profile
1 Gb NIC (Broadcom)	1	OCP
10 Gb NIC (Broadcom)	1	OCP
25 Gb NIC (Broadcom)	1	OCP
HWRAID BOSS	2	Low Profile

## Expansion bus specifications

The PowerEdge R440 system supports PCI express (PCIe) generation three expansion cards, which must be installed on the system board using expansion card risers. The R440 system supports four types of expansion card risers.

- ○ LOM riser - One x8 PCIe Gen 3 for OCP form factor cards - connected to Processor1
- Right riser - One x16 PCIe Gen3 for low-profile half-length cards or One x16 PCIe Gen3 for full height half-length cards - connected to Processor1
- Left riser - One x16 PCIe Gen3 for low-profile half-length cards - connected to Processor2
- Internal riser - One x8 PCIe Gen3 for low-profile half-length cards - connected to Processor1

**Table 28. Expansion card riser configurations**

Expansion card riser	PCIe slots on the riser	Height	Length	Link
LOM riser	Slot 1	Mezz type	Mezz type	x8
Right riser	Slot 2	Low Profile	Half Length	x16
Right riser	Slot 2	Full Height	Half Length	x16
PCIe passive bridge	Slot-integrated	Low Profile	Half Length	x8
Internal riser	Slot-integrated	Low Profile	Half Length	x8
Left riser	Slot 3	Low Profile	Half Length	x16

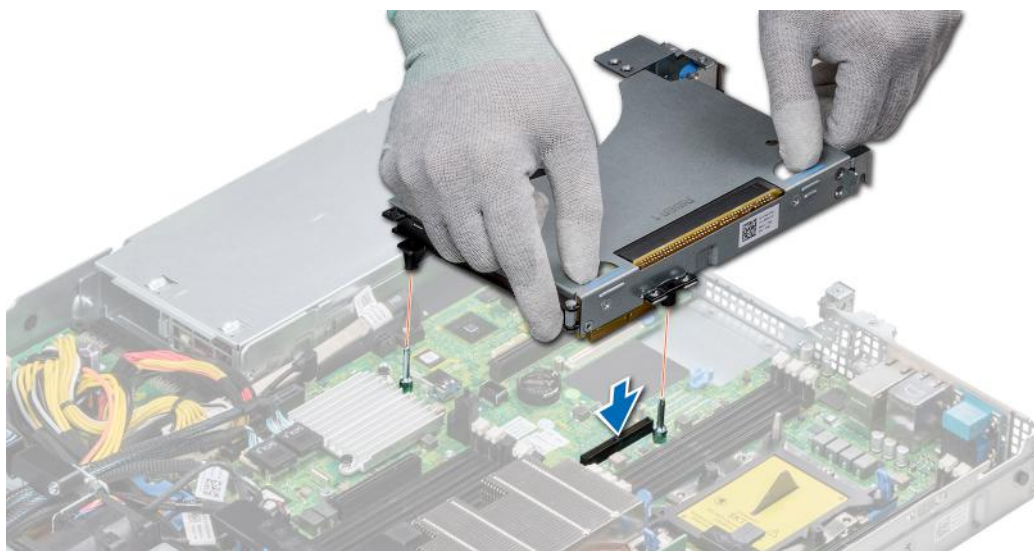
## Installing an expansion card riser

### Prerequisites

1. Follow the safety guidelines listed in [Safety instructions](#).

### Steps

1. If removed, install the expansion cards into the expansion card riser.
2. Holding the touch points, align the slot on the riser with the guide in the system board.
3. Lower the expansion card riser into place until the expansion card riser connector is fully seated in the connector.



**Figure 54. Installing an expansion card riser 1A**

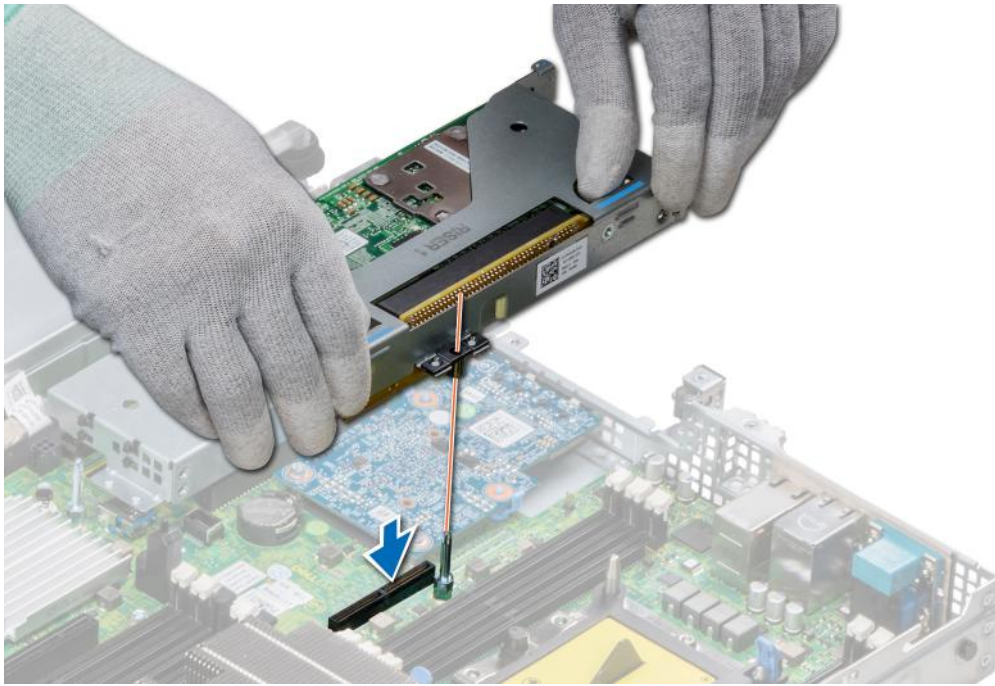


Figure 55. Installing an expansion card riser 1

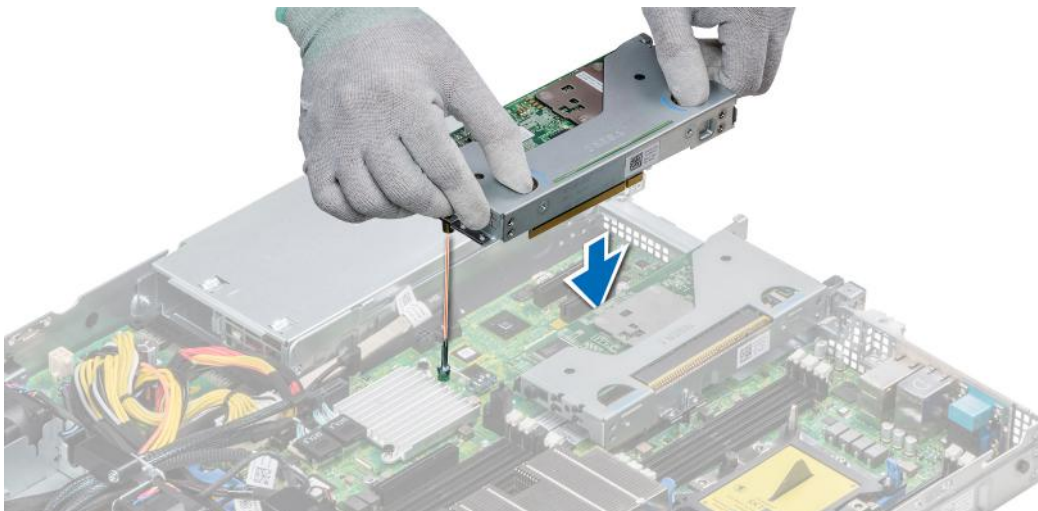


Figure 56. Installing an expansion card riser 2

### Next steps

1. Follow the procedure listed in [After working inside your system](#).
2. Install any device drivers required for the card as described in the documentation for the card.

## Removing an expansion card riser

### Prerequisites

1. Follow the safety guidelines listed in [Safety instructions](#).
2. Follow the procedure listed in [Before working inside your system](#).
3. Disconnect any cables connected to the expansion card.

## Steps

Hold the touch points, and lift the expansion card riser, from the riser connector, on the system board.

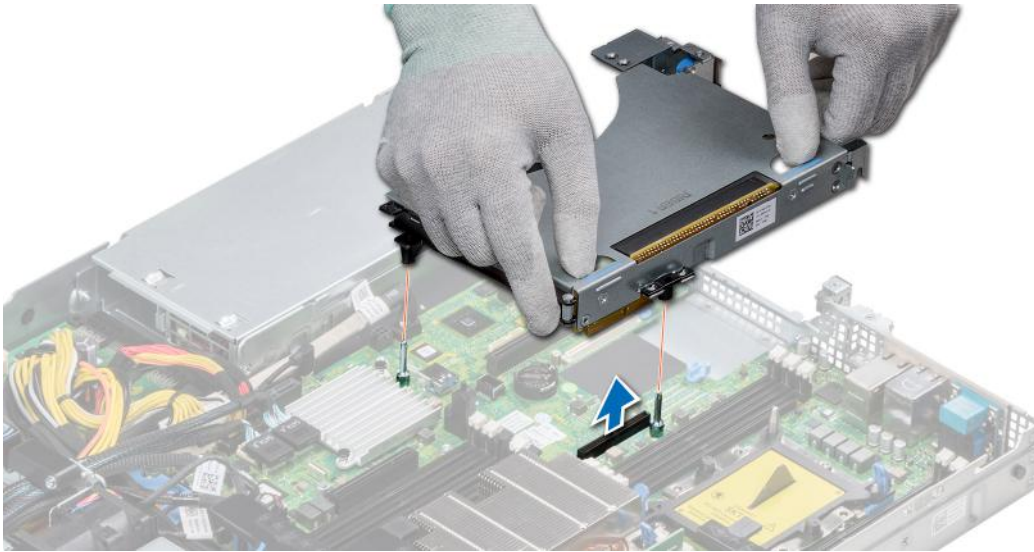


Figure 57. Removing an expansion card riser 1A

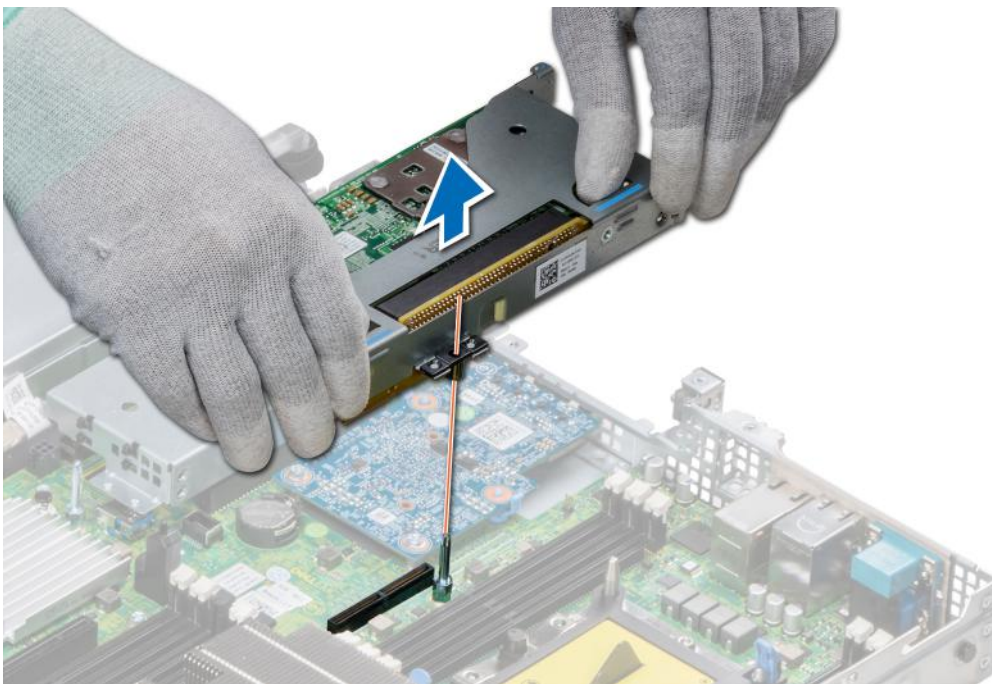
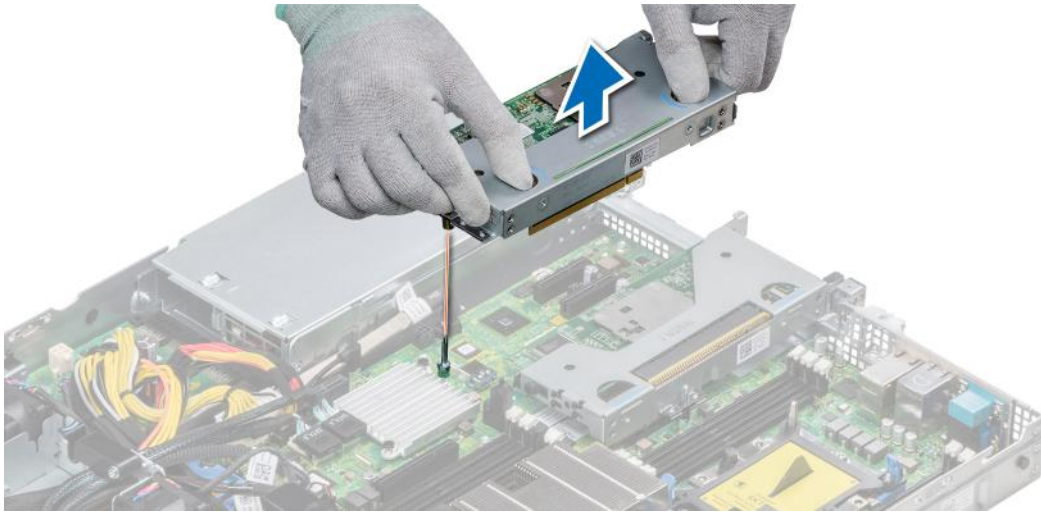


Figure 58. Removing an expansion card riser 1



**Figure 59. Removing an expansion card riser 2**

**Next steps**

Install the expansion card riser.

## Removing the expansion card from the expansion card riser

**Prerequisites**

1. Follow the safety guidelines listed in [Safety instructions](#).
2. Follow the procedure listed in [Before working inside your system](#).
3. If applicable, [remove the air shroud](#).
4. Remove the expansion card riser.
5. If applicable, disconnect the cables from the expansion card.

**Steps**

1. Open the PCIe card holder latch.
2. Hold the expansion card by its edges, and pull the card until the card edge connector disengages from the expansion card connector on the riser.

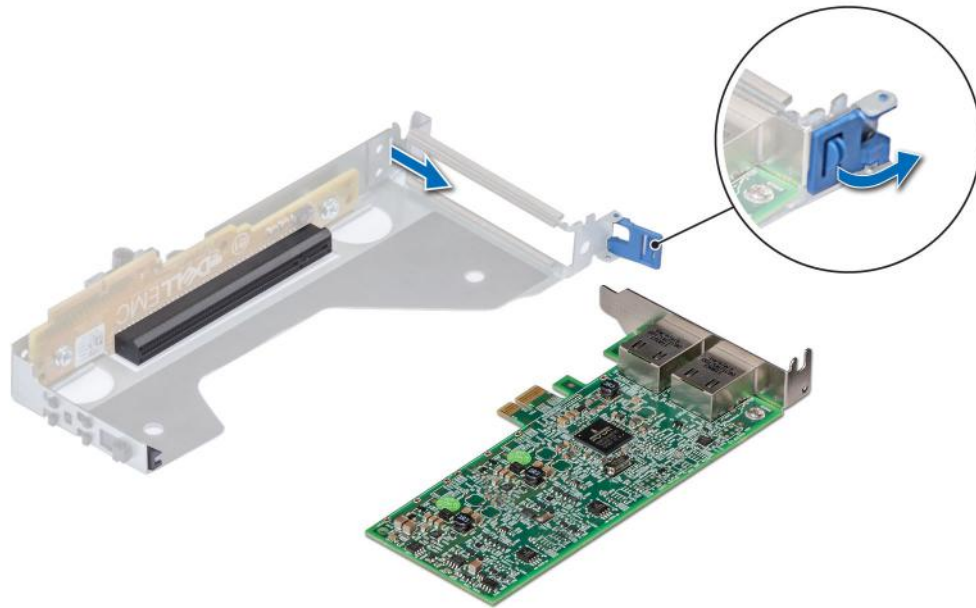


Figure 60. Removing expansion card from riser 2

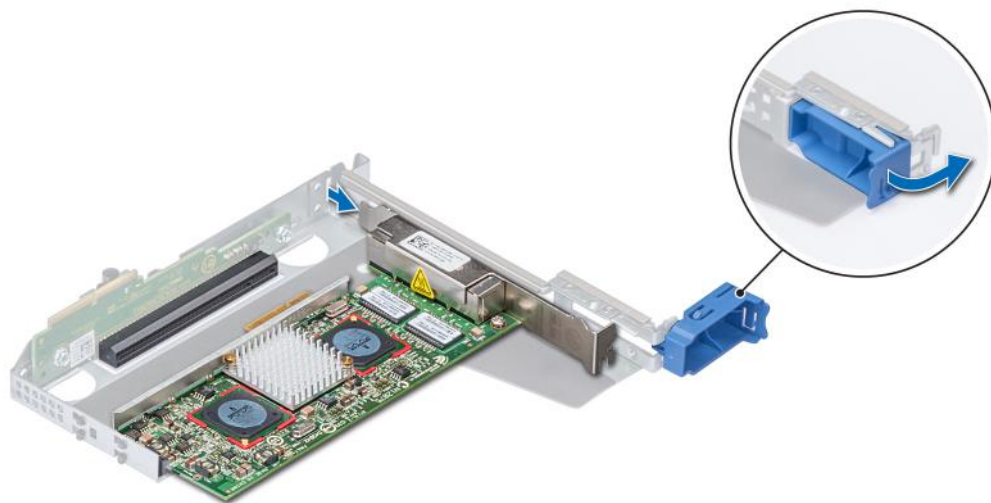


Figure 61. Removing expansion card from riser 1

3. Install a filler bracket if you are not replacing the expansion card.

**i** **NOTE:** You must install a filler bracket over an empty expansion card slot to maintain Federal Communications Commission (FCC) certification of the system. The brackets also keep dust and dirt out of the system and aid in proper cooling and airflow inside the system.

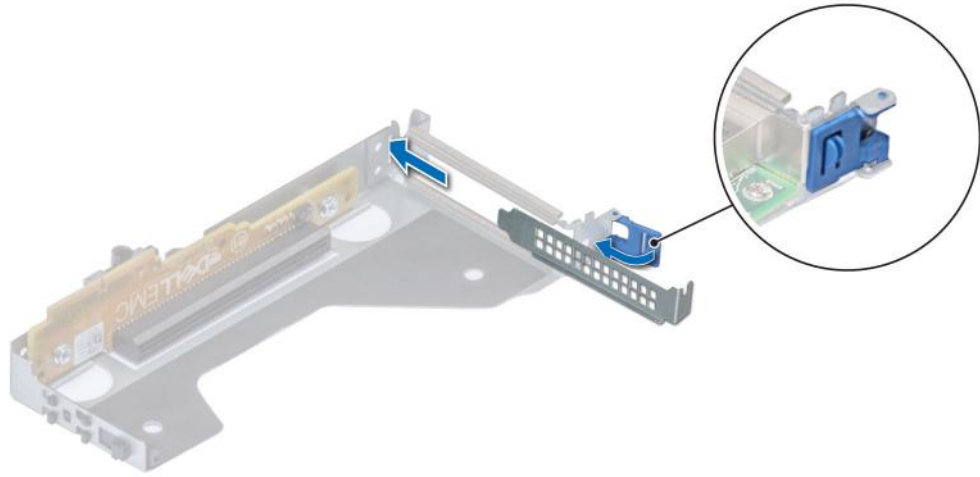


Figure 62. Installing filler bracket for riser 2

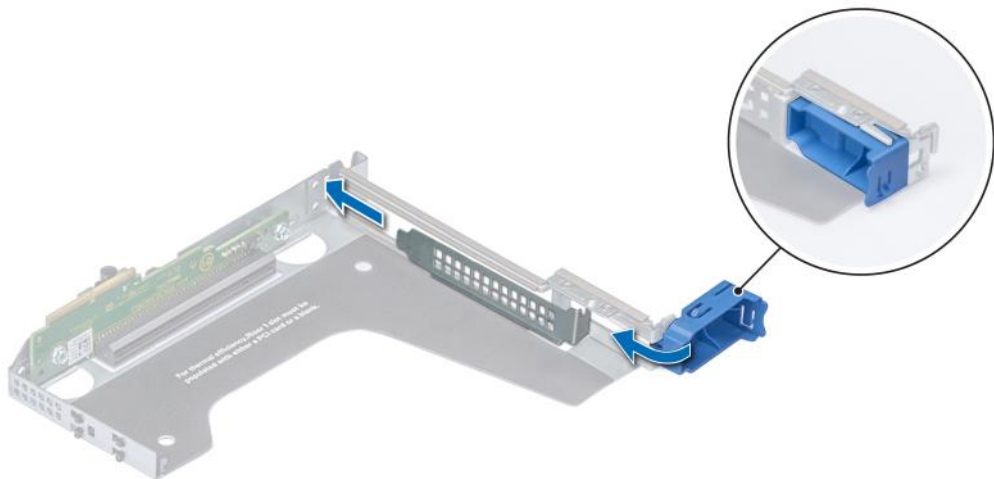


Figure 63. Installing filler bracket for riser 1

**Next steps**

Install the expansion card riser.

# Installing the expansion card into the expansion card riser

## Prerequisites

1. Follow the safety guidelines listed in [Safety instructions](#).
2. If installing a new expansion card, unpack it and prepare the card for installation.
  - i** **NOTE:** For instructions, see the documentation accompanying the card.
3. Remove the expansion card riser.

## Steps

1. Open the PCIe card holder latch.
2. If installed, remove the filler bracket.
  - i** **NOTE:** Store the filler bracket for future use. Filler brackets must be installed in empty expansion card slots to maintain Federal Communications Commission (FCC) certification of the system. The brackets also keep dust and dirt out of the system and aid in proper cooling and airflow inside the system.

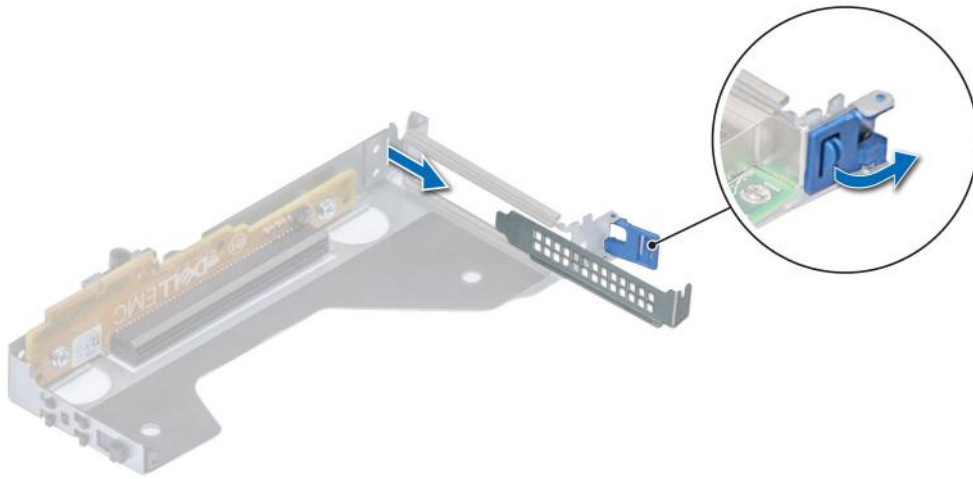
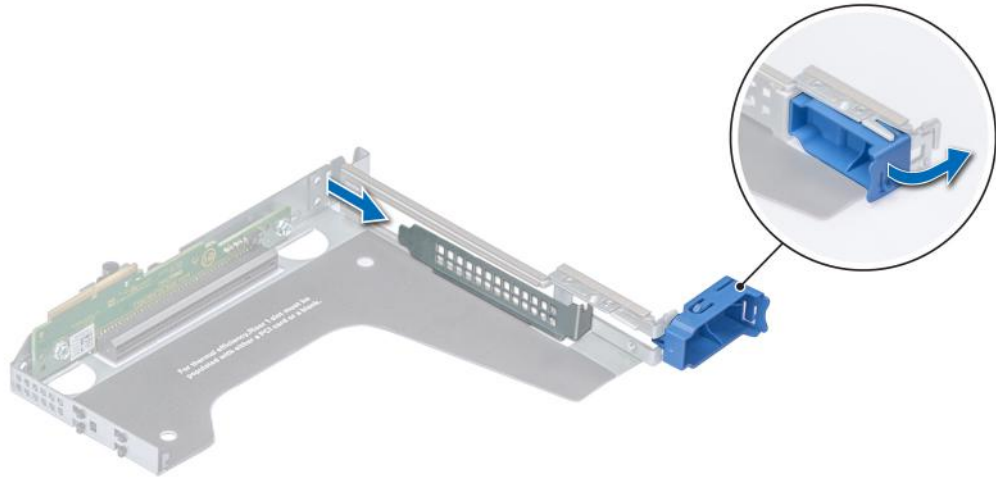


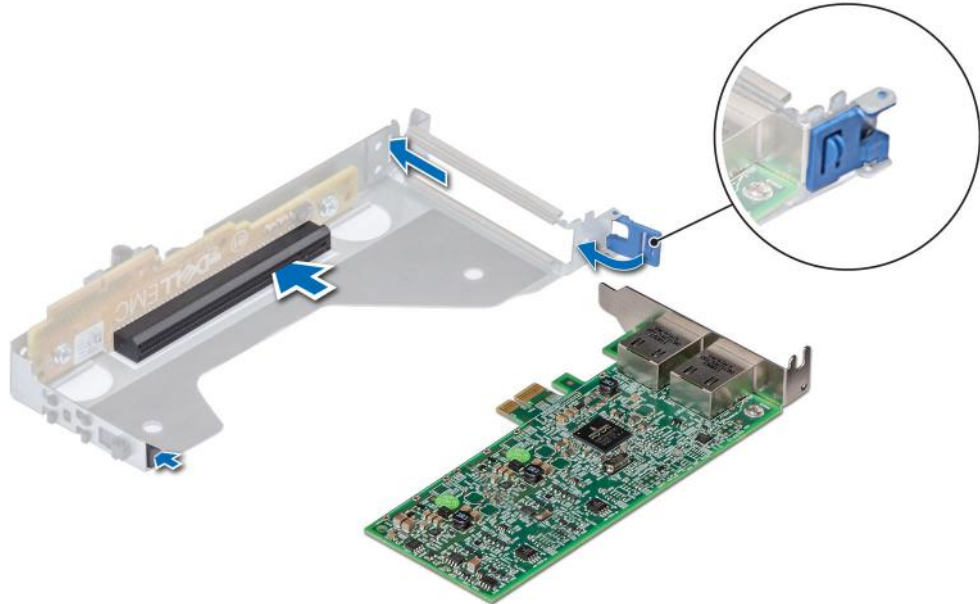
Figure 64. Removing filler bracket for riser 2



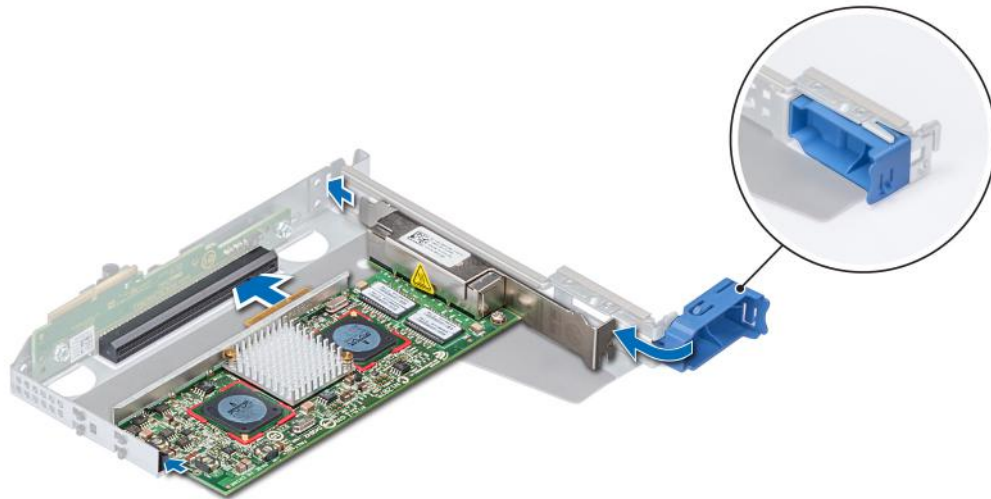


**Figure 65. Removing filler bracket for riser 1**

3. Hold the card by its edges, and align the card edge connector with the expansion card connector on the riser.
4. Insert the card edge connector firmly into the expansion card connector until the card is fully seated.
5. Close the expansion card latch.



**Figure 66. Installing expansion card into riser 2**



**Figure 67. Installing expansion card into riser 1**

#### Next steps

1. If applicable, connect the cables to the expansion card.
2. Install the expansion card riser
3. If applicable, [install the air shroud](#).
4. Follow the procedure listed in [After working inside your system](#).
5. Install any device drivers required for the card as described in the documentation for the card.

## Internal PERC riser

### Removing the internal PERC riser

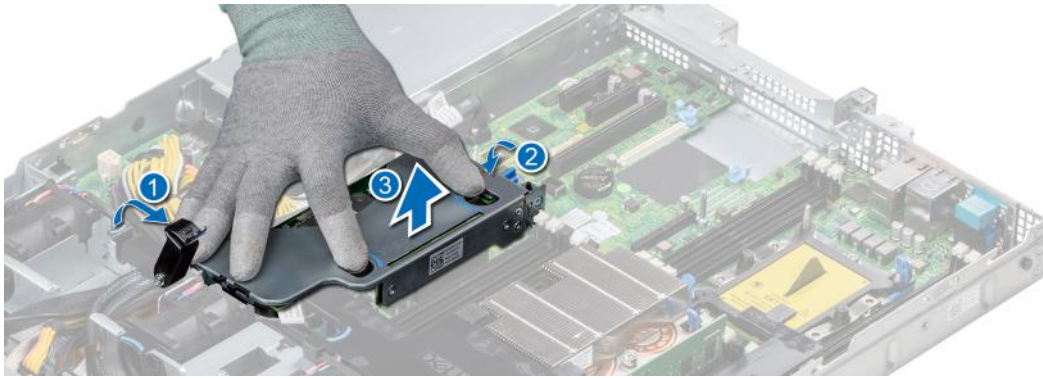
**NOTE:** The new generation PERC 11 H750, H350, and HBA350i adapters cannot be mixed with the PERC H740P, H730P, H330, HBA330 adapters of the previous generations in one system. For more information, see [Cable routing](#).

#### Prerequisites

1. Follow the safety guidelines listed in [Safety instructions](#).
2. Follow the procedure listed in [Before working inside your system](#).
3. [Remove the air shroud](#).

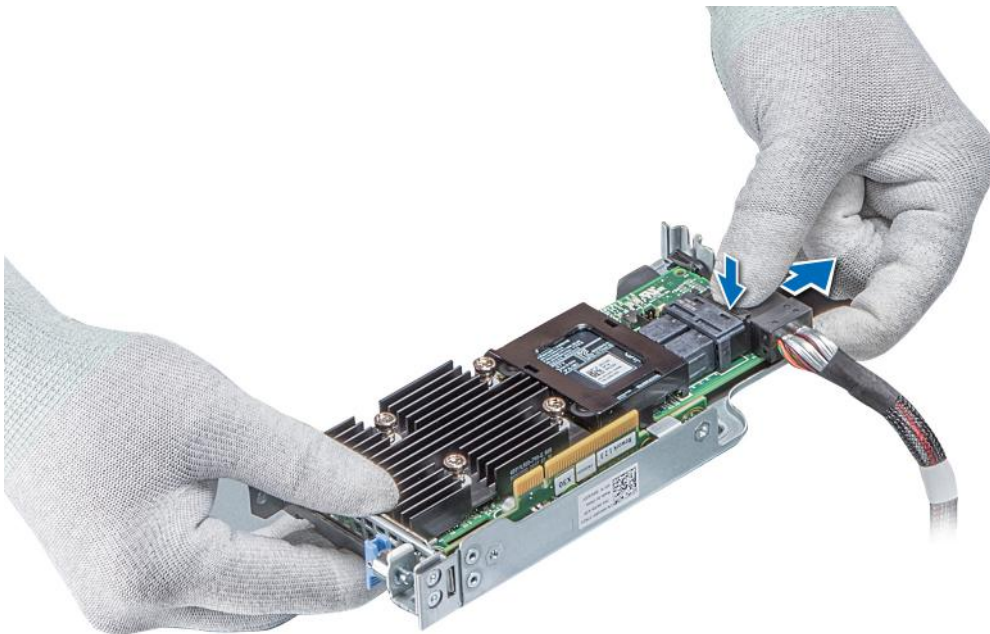
#### Steps

1. Open the cable guiding latch for easy access.
2. Lower the plunger.
3. Press the cable connector and disconnect the PERC cable from the backplane.
4. Hold the blue touch points and lift the internal PERC riser out of the system.



**Figure 68. Removing internal PERC riser**

5. Turn the internal riser so that the PERC card is facing up.
6. Press the cable connector and disconnect the cable that is connected to the internal PERC card.



**Figure 69. Disconnecting the cable from internal PERC card**

#### Next steps

1. [Install the air shroud.](#)
2. Follow the procedure listed in [After working inside your system.](#)
3. [Install the internal PERC card.](#)

## Installing the internal PERC riser

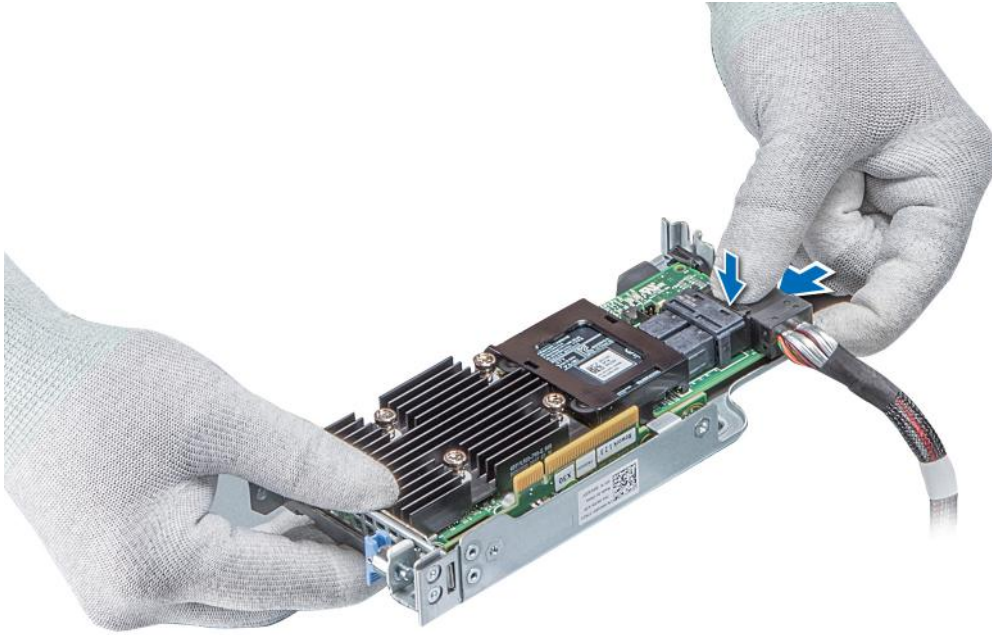
**NOTE:** The new generation PERC 11 H750, H350, and HBA350i adapters cannot be mixed with the PERC H740P, H730P, H330, HBA330 adapters of the previous generations in one system. For more information, see [Cable routing.](#)

#### Prerequisites

Follow the safety guidelines listed in [Safety instructions.](#)

## Steps

1. Connect the cable to the internal PERC card.



**Figure 70. Connecting the cable to internal PERC riser**

2. Holding the blue touch points, align the slot on the internal PERC riser to the guide on the system board.
3. Insert the internal riser card's edge connector firmly into the system board connector until the riser is fully seated.
4. Lift the plunger to lock the riser in place.



**Figure 71. Installing internal PERC riser**

5. Connect the cables to the backplane and then route the cables to the cable guiding latch to close the latch.

## Next steps

1. [Install the air shroud.](#)
2. Follow the procedure listed in [After working inside your system.](#)

## Removing the PERC card from the internal PERC riser

### Prerequisites

1. Follow the safety guidelines listed in [Safety instructions](#).
2. Follow the procedure listed in [Before working inside your system](#).
3. [Remove the air shroud](#).
4. [Remove the internal PERC riser](#).

### Steps

1. Using a Phillips #2 screwdriver, remove the screw that secures the PERC card to the internal PERC riser.
2. Pull the PERC card out of the connector on the internal PERC riser.

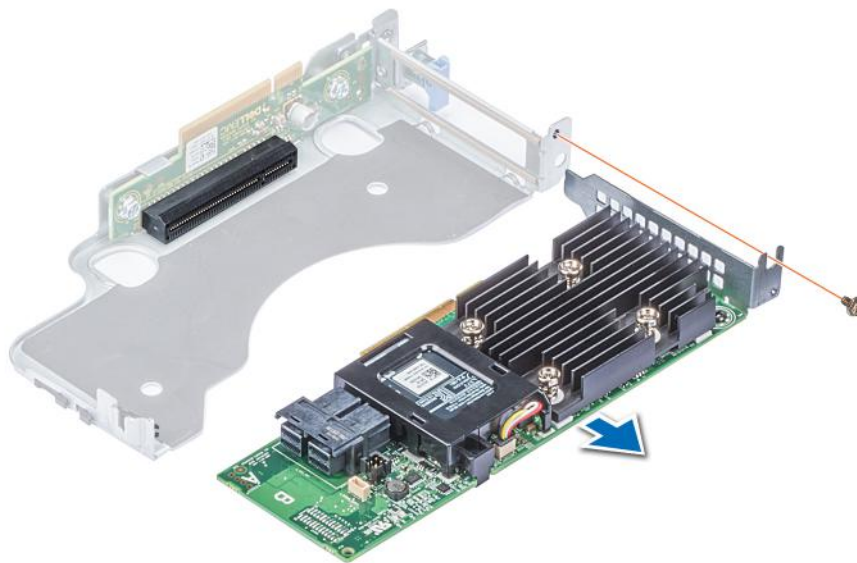


Figure 72. Removing the PERC card from the internal PERC riser

### Next steps

1. [Install the PERC card into the internal PERC riser](#).
2. [Replace the air shroud](#).
3. Follow the procedure listed in [After working inside your system](#).

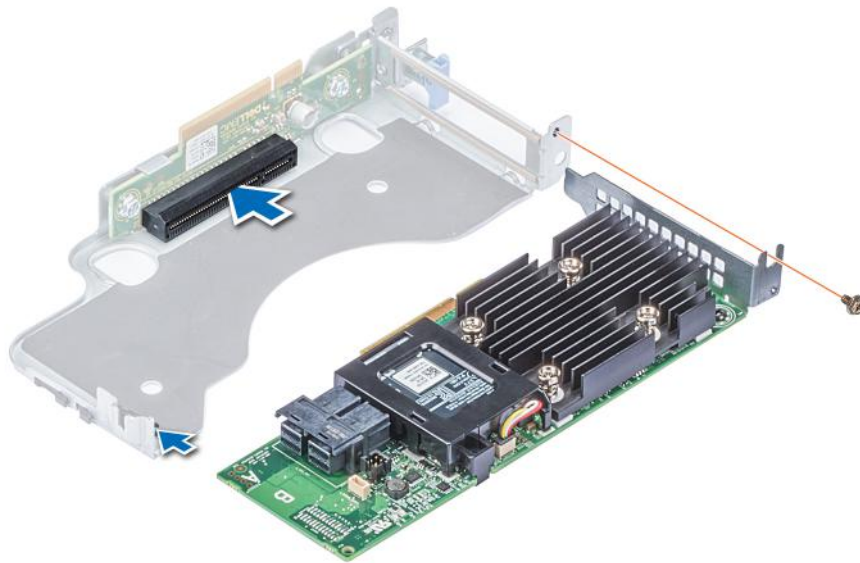
## Installing PERC card into the internal PERC riser

### Prerequisites

1. Follow the safety guidelines listed in [Safety instructions](#).

### Steps

1. Insert the PERC card into the internal PERC riser and push the card in.
2. Using a Phillips #2 screwdriver, replace the screw to secure the PERC card on the internal PERC riser.



**Figure 73. Installing PERC card into internal PERC riser**

#### Next steps

1. [Install the internal PERC riser.](#)
2. [Install the air shroud.](#)
3. Follow the procedure listed in [After working inside your system.](#)

## M.2 SSD module

**NOTE:** The write-protect switch is on the IDSDM or vFlash module.

### Installing the M.2 SSD module

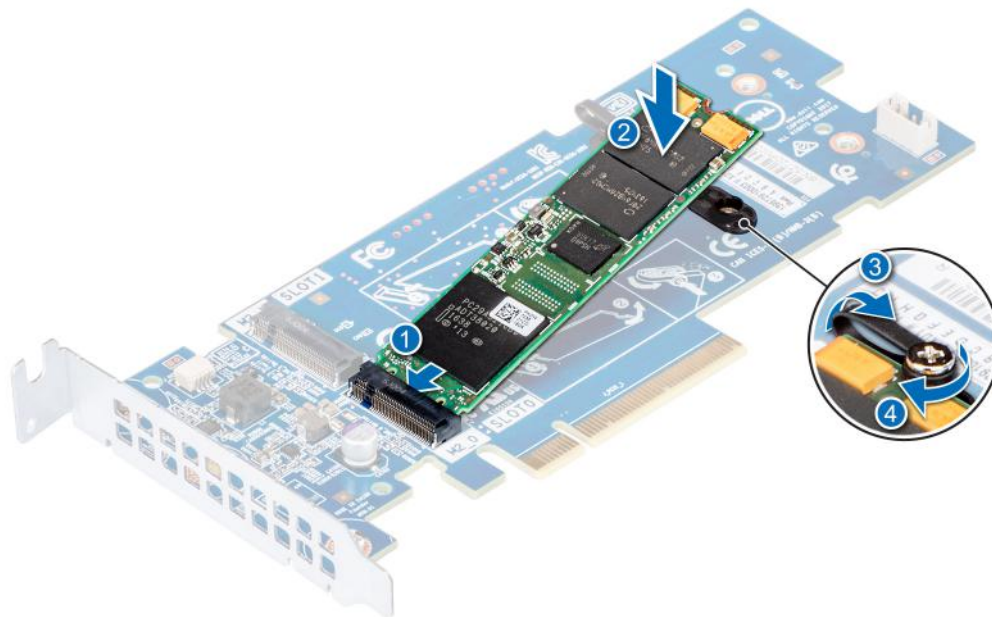
#### Prerequisites

1. Follow the safety guidelines listed in [Safety instructions](#)
2. [Remove the air shroud.](#)
3. Remove the BOSS card.

**NOTE:** The procedure to remove the BOSS card is similar to the [removing an expansion card.](#)

#### Steps

1. Connect the M.2 SSD module to the connector on the BOSS card.
2. Place the retention strap on the M.2 SSD module, and tighten the screw to secure the module.



**Figure 74. Installing the M.2 SSD module**

### Next steps

1. Install the BOSS card.  
**i** **NOTE:** The procedure to install the BOSS card is similar to the [removing an expansion card](#).
2. [Install the air shroud](#).
3. Follow the procedure listed in [After working inside your system](#).

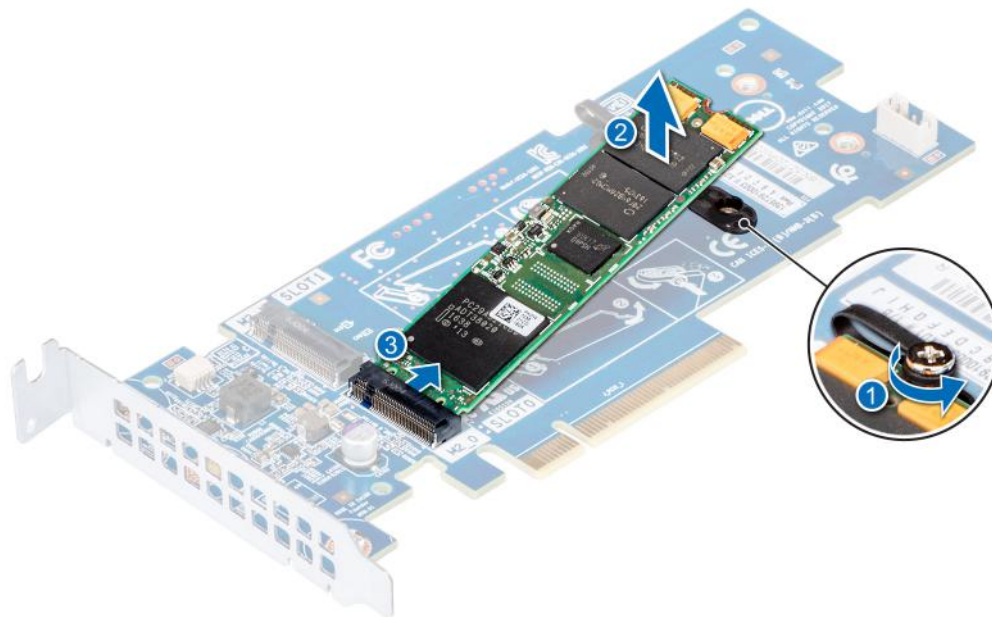
## Removing the M.2 SSD module

### Prerequisites

1. Follow the safety guidelines listed in [Safety instructions](#)
2. Follow the procedure listed in [Before working inside your system](#).
3. [Remove the air shroud](#).
4. Remove the BOSS card.  
**i** **NOTE:** The procedure to remove the BOSS card is similar to the [removing an expansion card](#).

### Steps

1. Loosen the screw and lift the retention strap that secures the M.2 SSD module on the BOSS card.
2. Lift the M.2 SSD module and slide it out of the connector on the BOSS card.



**Figure 75. Removing the M.2 SSD module**

#### **Next steps**

Replace the M.2 SSD module.

## **Optional MicroSD or vFlash card**

### **Removing the MicroSD card**

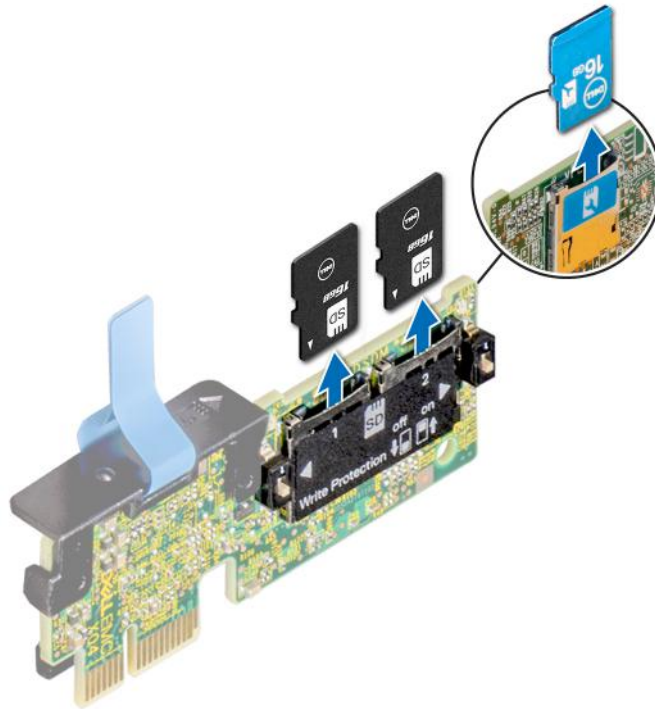
#### **Prerequisites**

1. Follow the safety guidelines listed in [Safety instructions](#).
2. Follow the procedure listed in [Before working inside your system](#).

#### **Steps**

1. Locate the MicroSD card slot on the vFlash/IDSDM module, and press the card to partially release it from the slot. To locate IDSDM/vFlash module, see the System board jumpers and connectors section.
2. Hold the MicroSD card and remove it from the slot.





**Figure 76. Removing the MicroSD card**

**NOTE:** Temporarily label each MicroSD card with its corresponding slot number after removal.

#### Next steps

1. Follow the procedure listed in [After working inside your system](#).
2. [Install a MicroSD card](#).

## Installing the MicroSD card

#### Prerequisites

Follow the safety guidelines listed in [Safety instructions](#).

**NOTE:** To use an MicroSD card with your system, ensure that the **Internal SD Card Port** is enabled in System Setup.

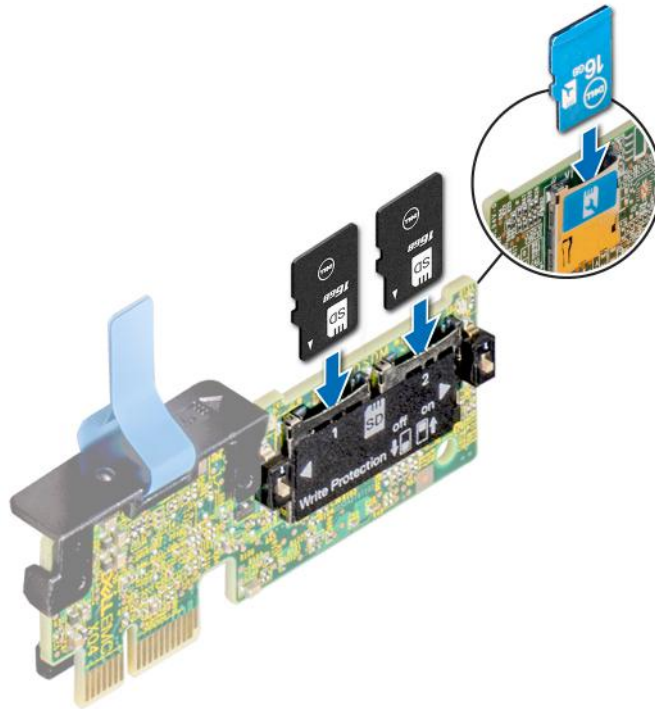
**NOTE:** If reinstalling, ensure that you install the MicroSD cards into the same slots based on the labels you had marked on the cards during removal.

#### Steps

1. Locate the MicroSD card connector on the IDSDM/vFlash module. Orient the MicroSD card appropriately and insert the contact-pin end of the card into the slot. To locate IDSDM/vFlash, see the System board jumpers and connectors section.

**NOTE:** The slot is keyed to ensure correct insertion of the card.

2. Press the card into the card slot to lock it into place.



**Figure 77. Installing the MicroSD card**

### Next steps

Follow the procedure listed in [After working inside your system](#).

## Optional IDSDM or vFlash module

### Removing the optional IDSDM or vFlash card

#### Prerequisites

1. Follow the safety guidelines listed in [Safety instructions](#).
2. Follow the procedure listed in [Before working inside your system](#).
3. If you are replacing the IDSDM/vFlash card, remove the MicroSD cards.  
**NOTE:** Temporarily label each MicroSD card with its corresponding slot number after removal.

#### Steps

1. Locate the IDSDM/vFlash connector on the system board.  
To locate IDSDM/vFlash connector, see the System board jumpers and connectors section.
2. Holding the pull tab, lift the IDSDM/vFlash card out of the system.



**Figure 78. Removing the optional IDSDM/vFlash card**

**NOTE:** There are two dip switches on the IDSDM/vFlash card for write-protection.

#### Next steps

Install the optional IDSDM/vFlash card.

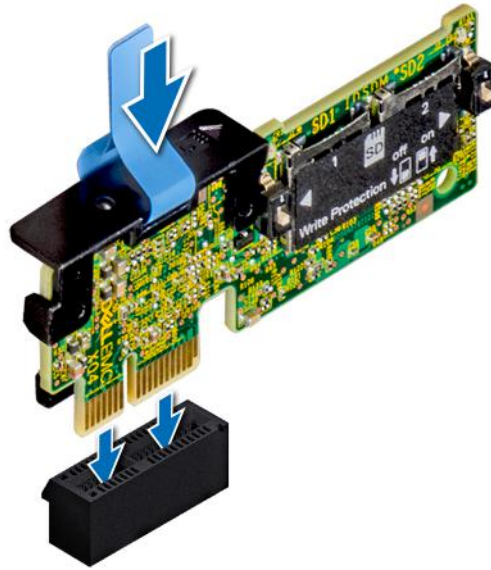
## Installing optional IDSDM or vFlash card

#### Prerequisites

Follow the safety guidelines listed in [Safety instructions](#) .

#### Steps

1. Locate the IDSDM/vFlash connector on the system board.  
To locate IDSDM/vFlash connector, see the [Jumpers and connectors](#) section.
2. Align the IDSDM/vFlash card with the connector on the system board.
3. Push the IDSDM/vFlash card until it is firmly seated on the system board.



**Figure 79. Installing optional IDSDM/vFlash card**

### Next steps

1. Install the MicroSD cards.  
**NOTE:** Reinstall the MicroSD cards into the same slots based on the labels you had marked on the cards during removal.
2. Follow the procedure listed in [After working inside your system](#) .

## LOM riser card

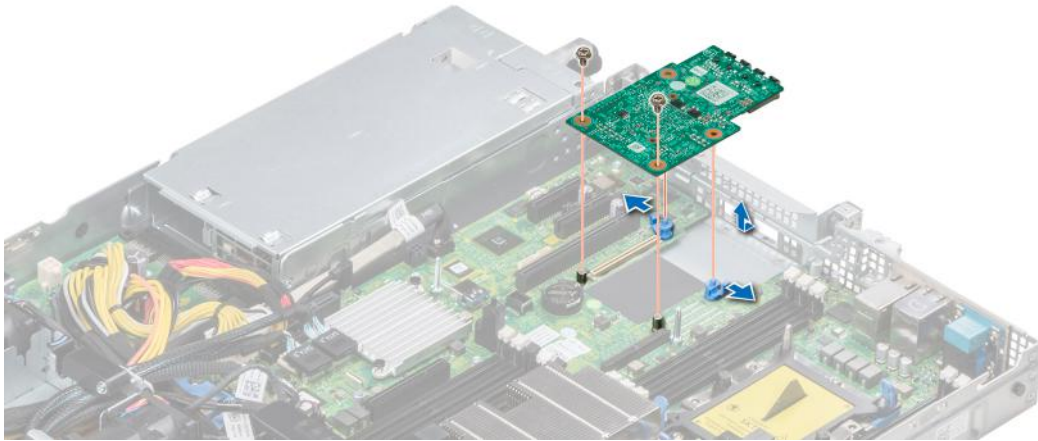
### Removing the LOM riser card

#### Prerequisites

1. Follow the safety guidelines listed in [Safety instructions](#).
2. Follow the procedure listed in [Before working inside your system](#).
3. If installed, remove the risers.

#### Steps

1. Using a Phillips #2 screwdriver, loosen the screws that secure the LOM riser card to the system board.
2. Release the two blue side plastic snaps holding the LOM riser card.
3. Hold the LOM riser card by the edges on either side, and lift to remove it from the connector on the system board.
4. Slide the LOM riser card towards the front of the system until the Ethernet connectors or the Small form-factor pluggable (SFP) are clear of the slot in the back of the system.



**Figure 80. Removing LOM riser card**

### Next steps

Install the LOM riser card.

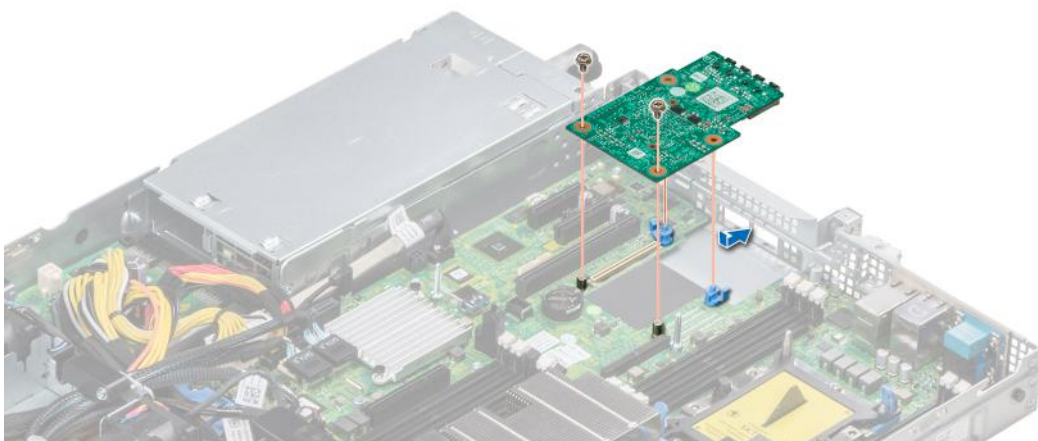
## Installing the LOM riser card

### Prerequisites

Follow the safety guidelines listed in [Safety instructions](#)

### Steps

1. Align the connectors on the LOM riser card with the slot on the system.
2. Press the LOM riser card until the card is firmly seated on the system board connector and the two blue plastic snap hold the LOM riser card in place.
3. Using a Phillips #2 screwdriver, replace the screws to secure the LOM riser card to the system board.



**Figure 81. Installing LOM riser card**

### Next steps

1. If removed, install the risers.

- Follow the procedure listed in [After working inside your system](#)

# Hard drive backplane

## Hard drive backplane details

Depending on your system configuration, the hard drive backplanes supported in PowerEdge R440 are listed here:

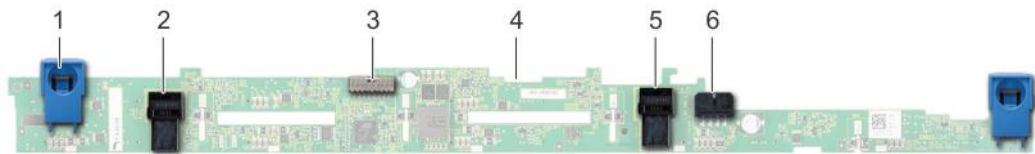
**Table 29. Supported backplane options for PowerEdge R440 systems**

System	Supported hard drives options
PowerEdge R440	3.5-inch (x4) SAS, SATA backplane
	2.5-inch (x10) SAS, SATA or NVMe backplane
	2.5-inch (x8) SAS, SATA or Nearline SAS drives



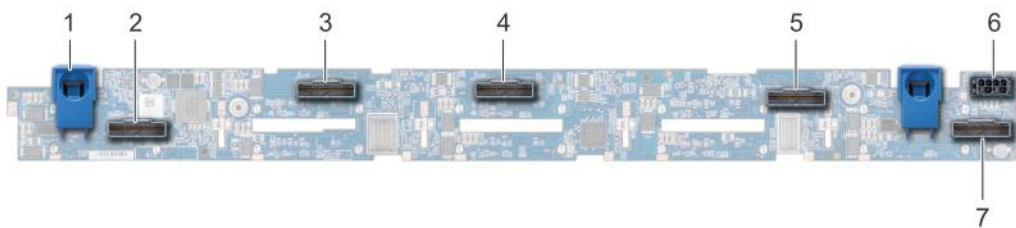
**Figure 82. 4 x 3.5 backplane**

- release tab
- SAS\_A connector on the backplane
- backplane power cable connector
- power connector



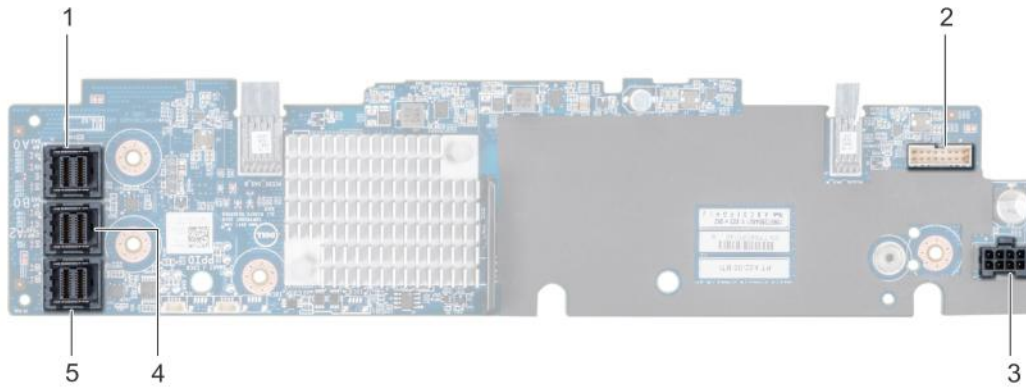
**Figure 83. 8 x 2.5-inch backplane**

- release tab
- SATA\_A cable connector
- backplane signal cable connector
- backplane
- SATA\_B cable connector
- backplane power cable connector



**Figure 84. 10 x 2.5 backplane**

- release tab
- bridge PCIe cable connector
- internal PCIe cable connector
- NVMe cable connector
- NVMe cable connector
- backplane power cable connector



**Figure 85. 10 x 2.5 backplane with expander**

- |                                    |                                     |
|------------------------------------|-------------------------------------|
| 1. SAS_A connector                 | 2. backplane signal cable connector |
| 3. backplane power cable connector | 4. SAS_B connector                  |
| 5. SAS_C connector                 |                                     |

## Installing the hard drive backplane

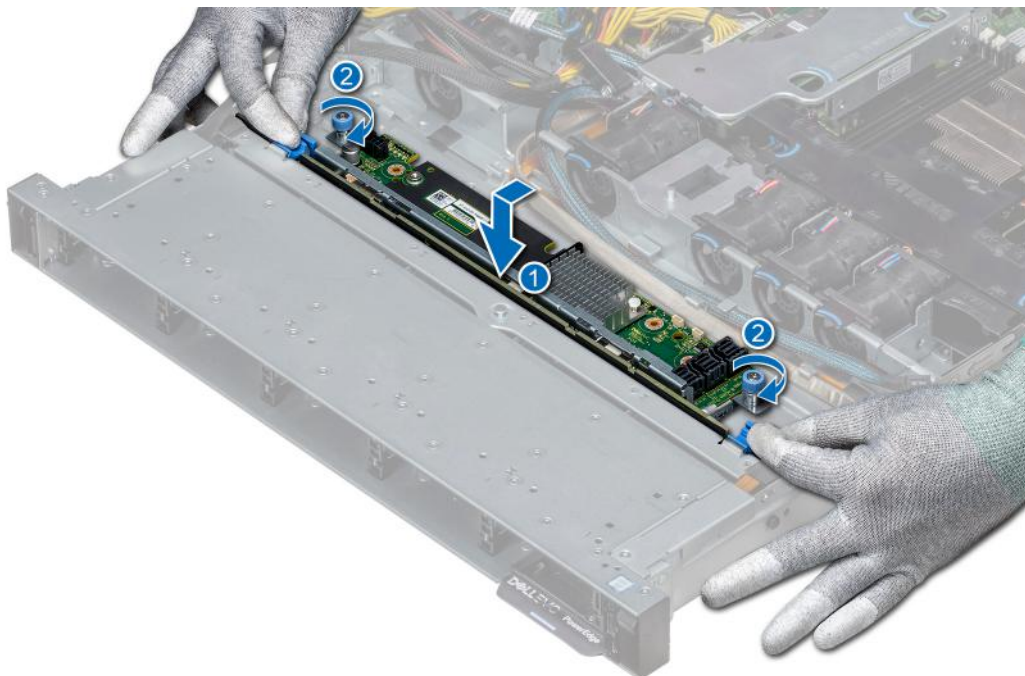
### Prerequisites

Follow the safety guidelines listed in [Safety instructions](#).

**NOTE:** The procedure to install the backplane is similar for all backplane configurations.

### Steps

1. Align the slots on the backplane with the hooks on the system.
2. Lower the hard drive backplane until the blue release tabs snap into place.
3. If your backplane has an expander board, then tighten the captive screws to secure the expander board to the system.



**Figure 86. Installing the hard drive backplane**

### Next steps

1. Connect all the cables to the backplane.
2. Install all the hard drives.
3. [Install the backplane cover.](#)
4. [Install the air shroud.](#)
5. Follow the procedure listed in [After working inside your system](#)

## Removing the hard drive backplane

### Prerequisites

**CAUTION:** To prevent damage to the drives and backplane, remove the hard drives from the system before removing the backplane.

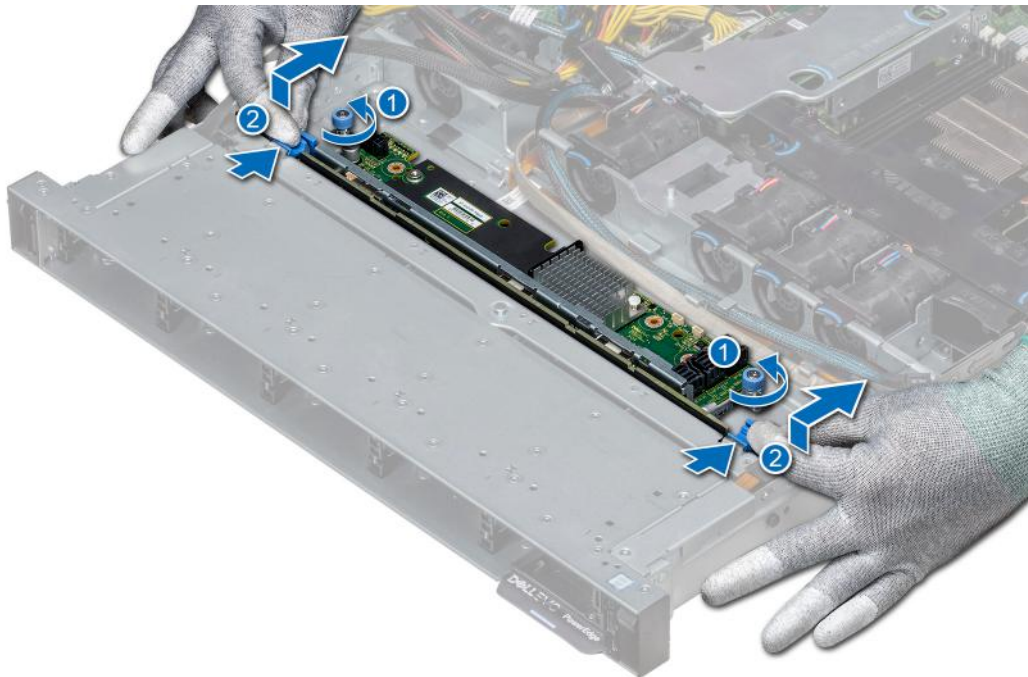
**CAUTION:** Note the number of each hard drive and temporarily label them before you remove the hard drive so that you can replace them in the same location.

**NOTE:** The procedure to remove the backplane is similar for all backplane configurations.

1. Follow the safety guidelines listed in [Safety instructions.](#)
2. Follow the procedure listed in [Before working inside your system.](#)
3. [Remove the air shroud.](#)
4. [Remove the backplane cover.](#)
5. Remove all hard drives from the hard drive slot.
6. Disconnect all the cables from the backplane.

### Steps

1. Press the blue release tabs and lift the backplane to disengage the backplane from the hooks on the system.
2. To remove a backplane with an expander board:
  - a. Loosen the captive screws that secure the expander board.
  - b. Press the release tabs and lift the backplane to disengage the slots on the backplane from the hooks on the system.



**Figure 87. Removing the hard drive backplane**

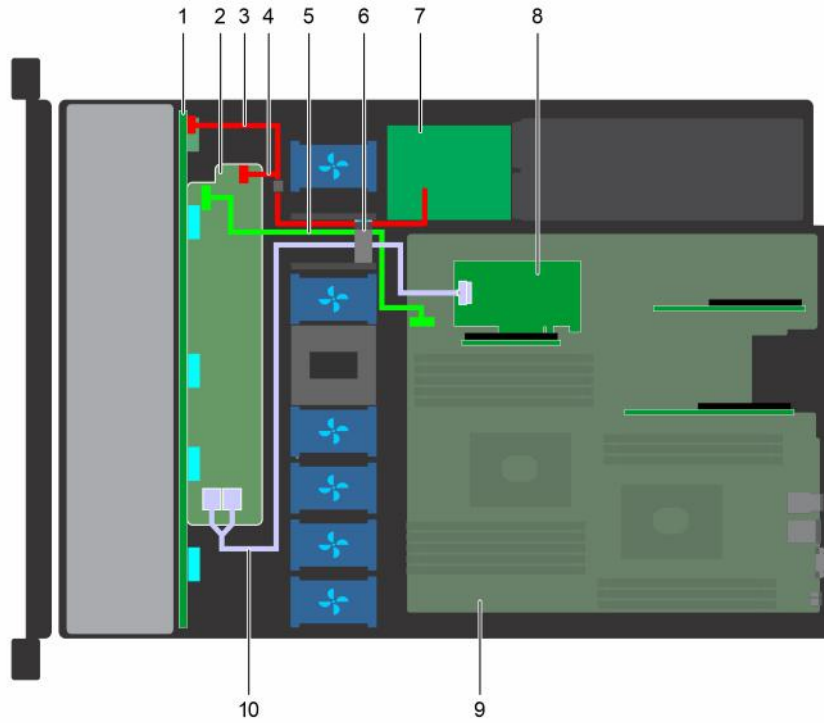
3. Lift the backplane out of the system.



### Next steps

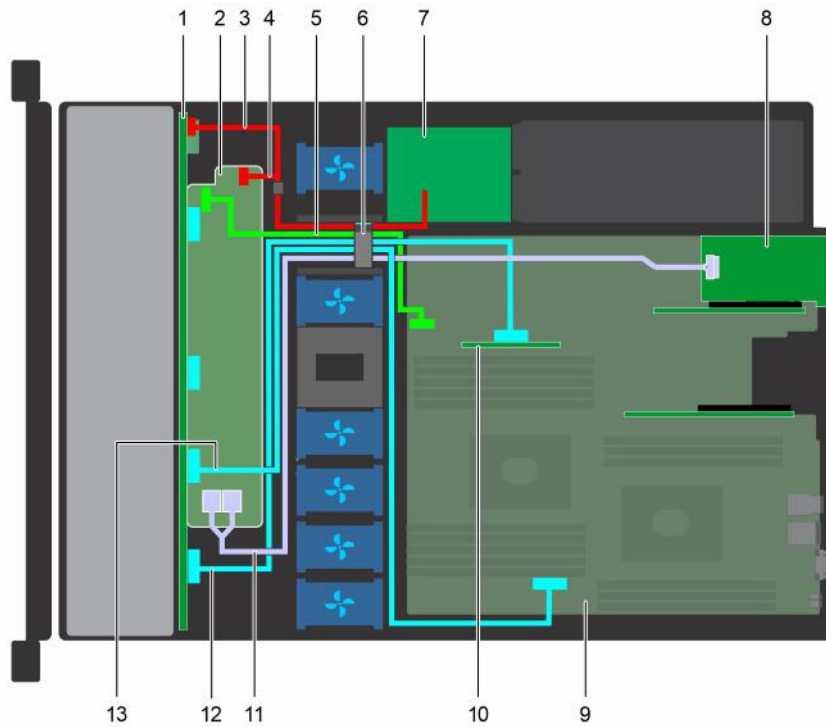
Install the hard drive backplane.

## Cable routing



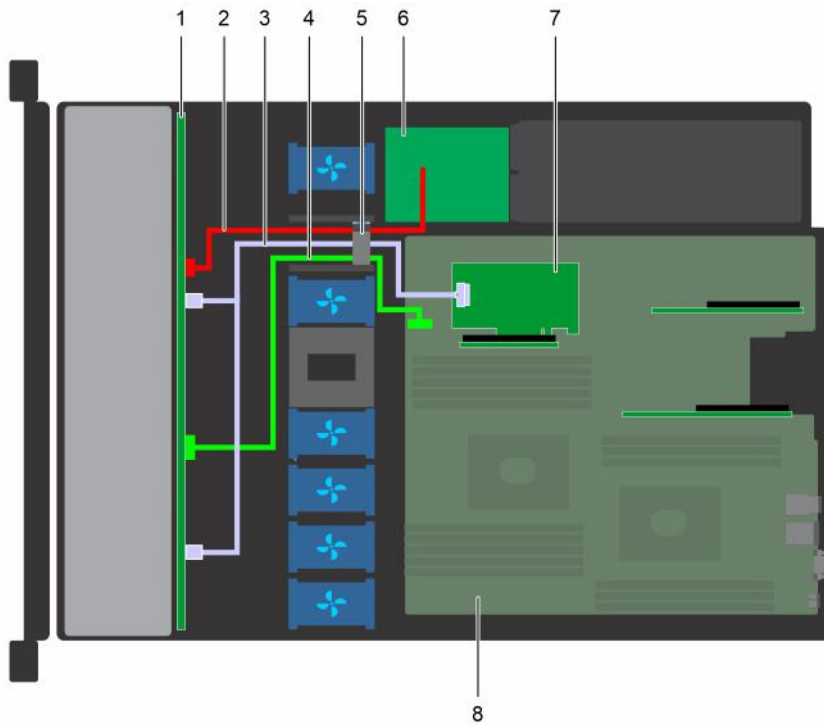
**Figure 88. Cable routing - 10 x 2.5 hard drive backplane with PERC riser**

- |                                    |   |
|------------------------------------|---|
| 1. Backplane                       | 2. Backplane expander                           |
| 3. Backplane power cable           | 4. Backplane signal cable                       |
| 5. Backplane expander signal cable | 6. Cable routing clip                           |
| 7. Power interposer board          | 8. Internal PERC                                |
| 9. System board                    | 10. SAS cable (BP: SAS cable to internal riser) |



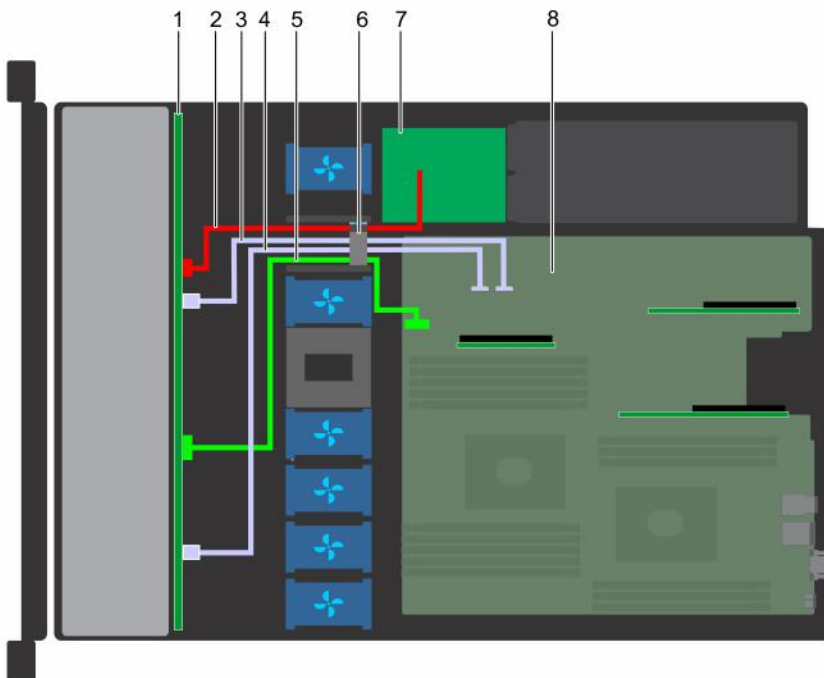
**Figure 89. Cable routing - 10 x 2.5 hard drive backplane with NVMe**

- |   |   |
|---|---|
| 1. Backplane  | 2. Backplane expander                                 |
| 3. Backplane power cable                                    | 4. Backplane power cable                              |
| 5. Backplane expander signal cable                          | 6. Cable routing clip                                 |
| 7. Power interposer board                                   | 8. Expansion card riser                               |
| 9. System board   | 10. Internal riser                                    |
| 11. SAS cable (BP: SAS_A and SAS_B to expansion card riser) | 12. NVMe cable connector (BP: PCIe to internal riser) |
| 13. NVMe cable connector (BP: PCIe to MB)                   |   |



**Figure 90. Cable routing - 8 x 2.5 hard drive backplane with PERC riser**

- |   |                           |
|---|---------------------------|
| 1. Hard drive backplane   | 2. Backplane power cable  |
| 3. SAS cable (SAS_A and SAS_B cable connectors to internal riser) | 4. Backplane signal cable |
| 5. Cable routing clip   | 6. Power interposer board |
| 7. Internal PERC  | 8. System board           |

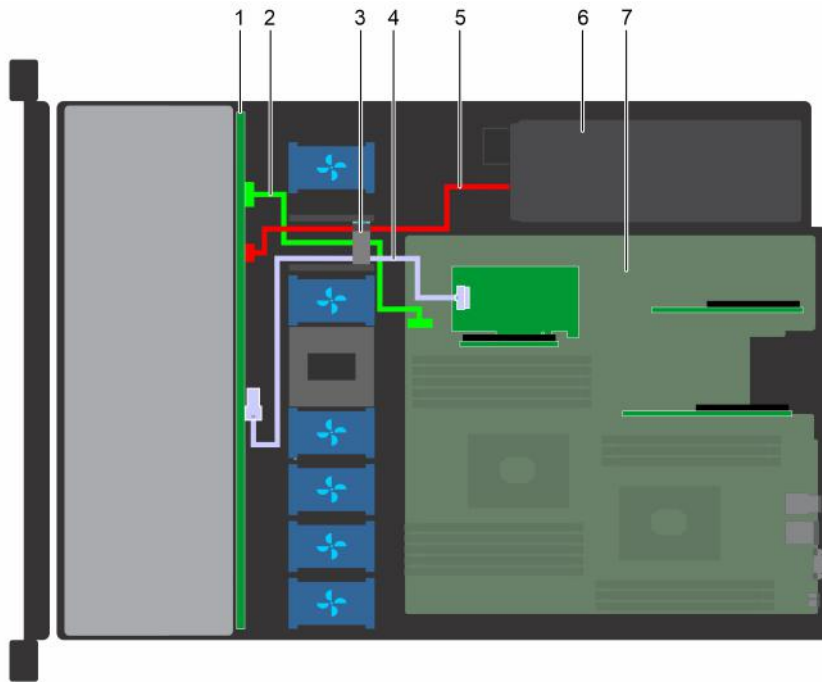


**Figure 91. Cable routing - 8 x 2.5 hard drive backplane with onboard SATA**

- |                                  |                                  |
|----------------------------------|----------------------------------|
| 1. hard drive backplane          | 2. backplane power cable         |
| 3. SATA cable (BP: SATA_B to MB) | 4. SATA cable (BP: SATA_A to MB) |

- 5. backplane signal cable
- 7. power interposer board

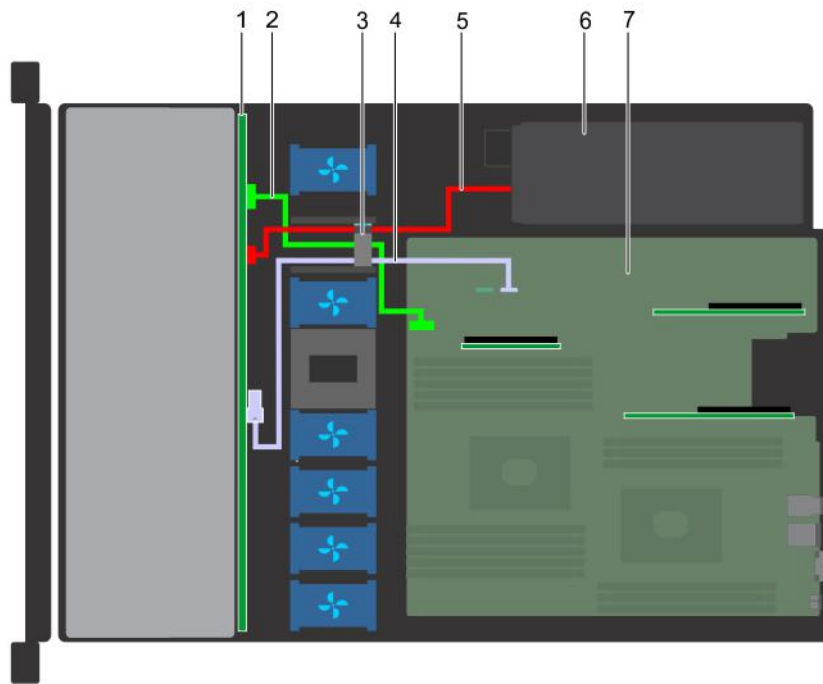
- 6. cable routing clip
- 8. system board



**Figure 92. Cable routing - 4 x 3.5 hard drive backplane with PERC riser**

- 1. hard drive backplane
- 3. cable routing clip
- 5. backplane power cable
- 7. system board

- 2. backplane signal cable
- 4. SAS cable (BP: SAS\_A to PERC riser)
- 6. power supply unit



**Figure 93. Cable routing - 4 x 3.5 hard drive backplane with SATA**

- |                          |                                  |
|--------------------------|----------------------------------|
| 1. hard drive backplane  | 2. backplane signal cable        |
| 3. cable routing clip    | 4. SATA cable (BP: SATA_A to MB) |
| 5. backplane power cable | 6. power supply unit             |
| 7. system board          |                                  |

## System battery

The Dell EMC PowerEdge R440 system supports CR 2032 3.0-V lithium coin cell system battery.

## Replacing the system battery

### Prerequisites

**⚠ WARNING:** There is a danger of a new battery exploding if it is incorrectly installed. Replace the battery only with the same or equivalent type recommended by the manufacturer. For more information, see the safety information that shipped with your system.

1. Follow the safety guidelines listed in [Safety instructions](#).
2. Follow the procedure listed in [Before working inside your system](#).
3. If applicable, disconnect the power or data cables from expansion card(s).

### Steps

1. Locate the battery socket. For more information, see the [System board jumpers and connectors](#) section.

**⚠ CAUTION:** To avoid damage to the battery connector, you must firmly support the connector while installing or removing a battery.

2. Use a plastic scribe to pry out the system battery.



**Figure 94. Removing the system battery**

3. To install a new system battery, hold the battery with the positive side facing up and slide it under the securing tabs.
4. Press the battery into the connector until it snaps into place.




**Figure 95. Installing the system battery**

#### Next steps


1. If applicable, connect the cables to the expansion card(s).
2. Follow the procedure listed in [After working inside your system](#).
3. While booting, press F2 to enter the System Setup and ensure that the battery is operating properly.
4. Enter the correct time and date in the System Setup **Time** and **Date** fields.
5. Exit the System Setup.

## Optional internal USB memory key

 **NOTE:** To locate the internal USB port on the system board, see the [System board jumpers and connectors](#) section.

## Replacing the optional internal USB memory key

#### Prerequisites

 **CAUTION:** To avoid interference with other components in the server, the maximum permissible dimensions of the USB memory key are 15.9 mm wide x 57.15 mm long x 7.9 mm high.

1. Follow the safety guidelines listed in [Safety instructions](#).
2. Follow the procedure listed in [Before working inside your system](#).

#### Steps

1. Locate the USB port or USB memory key on the system board.  
To locate the USB port, see the [Jumpers and connectors](#).
2. If installed, remove the USB memory key from the USB port.
3. Insert the replacement USB memory key into the USB port.

### Next steps

1. Follow the procedure listed in [After working inside your system](#).
2. While booting, press F2 to enter **System Setup** and verify that the system detects the USB memory key.

## Optical drive (optional)

### Removing the optical drive

#### Prerequisites

1. Follow the safety guidelines listed in [Safety instructions](#).
2. Follow the procedure listed in [Before working inside your system](#).
3. If applicable, remove the front bezel.
4. Disconnect the power and data cables from the connectors on the optical drive.  
**NOTE:** Ensure that you note the routing of the power and data cable on the side of the system and drive. Route these cables properly when you replace them to prevent them from being pinched or crimped.

#### Steps

1. Press the release tab to release the optical drive.
2. Slide the optical drive out of the system until it is out of the optical drive slot.
3. If you are not adding a new optical drive, install the optical drive blank. The procedure to install the optical drive blank is the same as the optical drive.

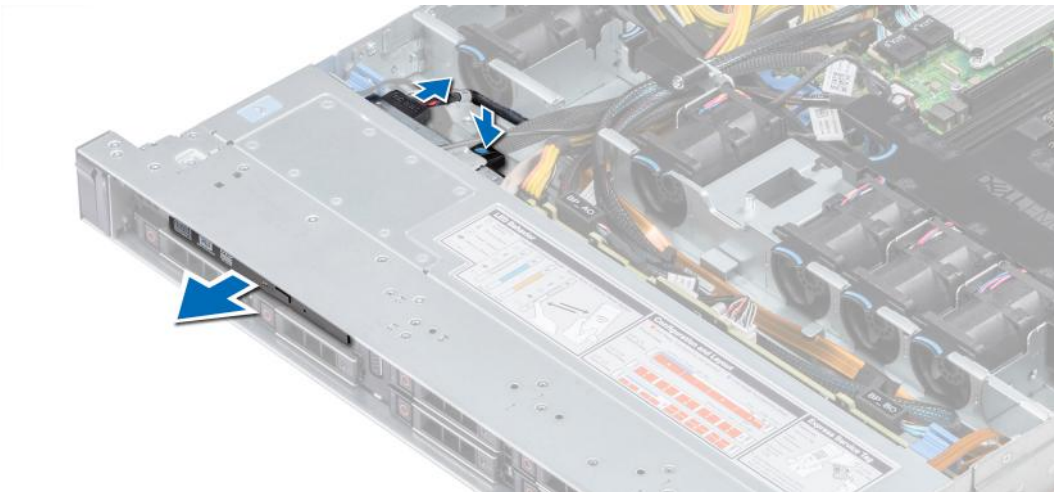


Figure 96. Removing optical drive

### Next steps

Install an optical drive.

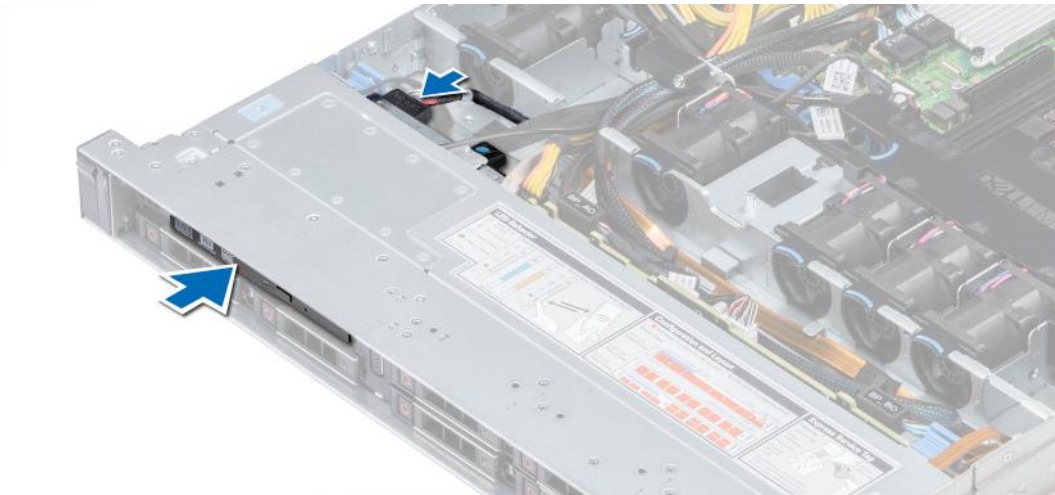
## Installing the optical drive

#### Prerequisites

Follow the safety guidelines listed in [Safety instructions](#).

#### Steps

1. Align the optical drive with the optical drive slot on the front of the system.
2. Slide in the optical drive until the release tab snaps into place.



**Figure 97. Installing optical drive**

3. Connect the power and data cables to the connector on the optical drive.  
**i** **NOTE:** Route the cable properly to prevent it from being pinched or crimped.
4. Replace the front Bezel.

#### Next steps

1. Follow the procedure listed in [After working inside your system](#).

## Power supply units

**i** **NOTE:** For more information, see the PowerEdge R440 Technical Specs at [www.dell.com/poweredgemanuals](http://www.dell.com/poweredgemanuals).

**⚠ CAUTION:** If two PSUs are installed, both the PSUs must have the same type of label. For example, **Extended Power Performance (EPP) label. Mixing PSUs from previous generations of PowerEdge servers is not supported, even if the PSUs have the same power rating. Mixing PSUs will result in mismatch condition or failure to turn the system on.**

**i** **NOTE:** When two identical PSUs are installed, power supply redundancy (1+1 – with redundancy or 2+0 – without redundancy) is configured in system BIOS. In redundant mode, power is supplied to the system equally from both PSUs when Hot Spare is disabled. When Hot Spare is enabled, one of the PSUs is put into the sleep mode when system utilization is low in order to maximize efficiency.

**i** **NOTE:** If two PSUs are used, they must be of the same maximum output power.

## Removing a power supply unit blank

#### Prerequisites

Follow the safety guidelines listed in [Safety instructions](#).

#### Steps

If you are installing a second power supply unit, remove the power supply unit blank in the bay by pulling the blank outward.

**⚠ CAUTION:** To ensure proper system cooling, the power supply unit blank must be installed in the second power supply unit bay in a non-redundant configuration. Remove the power supply unit blank only if you are installing a second power supply unit.





Figure 98. Removing a power supply unit blank

#### Next steps

Install the second power supply unit blank.

## Installing a power supply unit blank

#### Prerequisites

1. Follow the safety guidelines listed in [Safety instructions](#).

**NOTE:** Install the power supply unit (PSU) blank only in the second PSU bay.

#### Steps

Align the PSU blank with the PSU slot and push it into the PSU slot until it clicks into place.

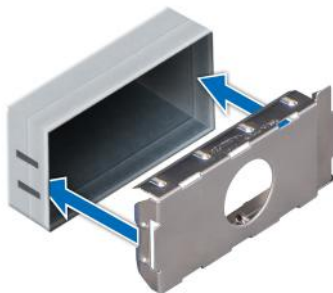


Figure 99. Installing a power supply unit blank

#### Next steps

Follow the procedure listed in [After working inside your system](#).

## Removing a power supply unit

#### Prerequisites

**CAUTION:** The system needs one power supply unit (PSU) for normal operation. On power-redundant systems, remove and replace only one PSU at a time in a system that is powered on.

1. Follow the safety guidelines listed in [Safety instructions](#)
2. Disconnect the power cable from the power source and from the PSU you intend to remove, and then remove the cable from the strap on the PSU handle.
3. Unlatch and lift the optional cable management arm if it interferes with the PSU removal.

For information about the cable management arm, see the system's rack documentation at [www.dell.com/poweredgemanuals](http://www.dell.com/poweredgemanuals).

### Steps

Press the release latch and slide the PSU out of the system by using the PSU handle.



Figure 100. Removing a power supply unit

### Next steps

Install the PSU.

## Installing a power supply unit

### Prerequisites

1. Follow the safety guidelines listed in [Safety instructions](#)
2. For systems that support redundant PSU, ensure that both the PSUs are of the same type and have the same maximum output power.

**NOTE:** The maximum output power (shown in watts) is listed on the PSU label.

### Steps

Slide the PSU into the system until the PSU is fully seated and the release latch snaps into place.



**Figure 101. Installing a power supply unit**

#### Next steps

1. If you have unlatched the cable management arm, relatch it. For information about the cable management arm, see the system's rack documentation at [www.dell.com/poweredgemanuals](http://www.dell.com/poweredgemanuals).
2. Connect the power cable to the PSU, and plug the cable into a power outlet.

**CAUTION:** When connecting the power cable to the PSU, secure the cable to the PSU with the strap.

**NOTE:** When installing, hot swapping, or hot adding a new PSU, wait for 15 seconds for the system to recognize the PSU and determine its status. The PSU redundancy may not occur until discovery is complete. Wait until the new PSU is discovered and enabled before you remove the other PSU. The PSU status indicator turns green to signify that the PSU is functioning properly.

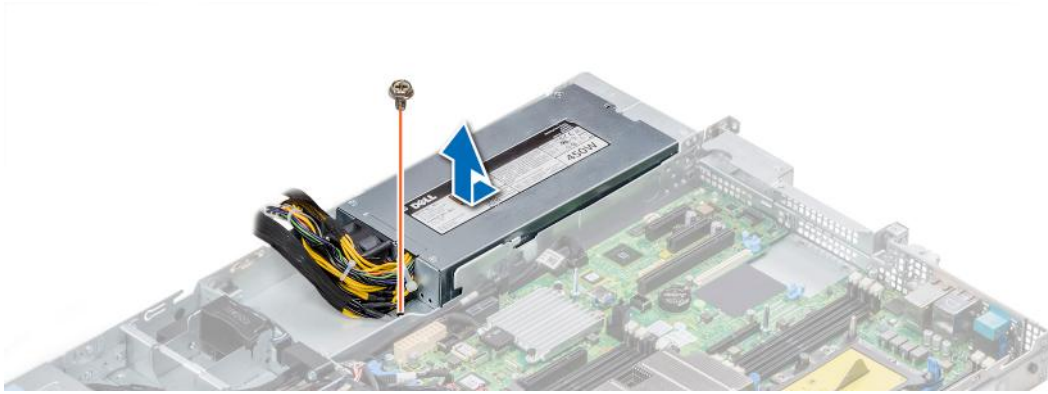
## Removing a non-redundant cabled AC power supply unit

#### Prerequisites

1. Follow the safety guidelines listed in [Safety instructions](#).
2. Follow the procedure listed in [Before working inside your system](#).
3. [Remove the air shroud](#)
4. Disconnect the system from the electrical outlet.
5. Disconnect all the cables connected from the PSU to the system board.
6. If applicable, [remove the expansion card riser](#).

#### Steps

1. Using a Phillips #2 screwdriver, remove the screw securing the PSU to the system.
2. Slide the PSU out of the PSU cage.



**Figure 102. Removing non-redundant cabled AC PSU**

#### Next steps

1. [Install a non-redundant cabled AC power supply.](#)

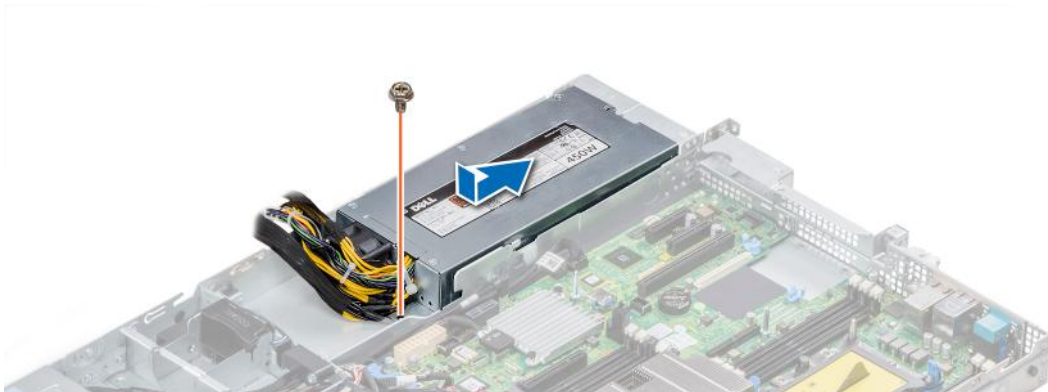
## Installing a non-redundant cabled AC power supply unit

#### Prerequisites

1. Follow the safety guidelines listed in [Safety instructions](#).

#### Steps

1. Unpack the new power supply unit (PSU).
2. Slide the new PSU into the PSU cage until the PSU is fully seated.
3. Using a Phillips #2 screwdriver, replace the screw to secure the PSU to the system.



**Figure 103. Installing a non-redundant cabled AC PSU**

#### Next steps

1. Connect the PSU cables to the connectors on the system board.
2. If applicable, [install the expansion card riser](#).
3. [Install the air shroud](#).
4. Follow the procedure listed in [After working inside your system](#).

# Power interposer board

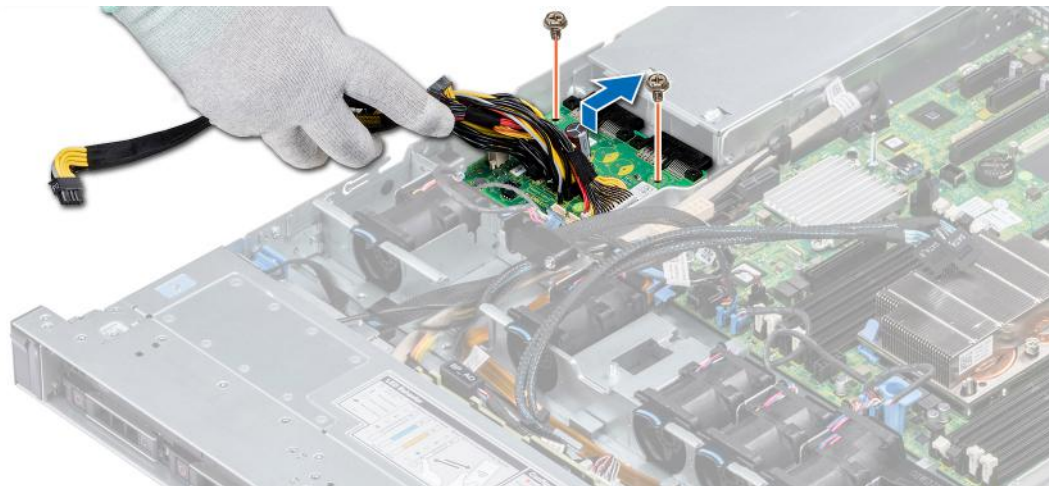
## Removing power interposer board

### Prerequisites

1. Follow the safety guidelines listed in [Safety instructions](#).
2. Follow the procedure listed in [Before working inside your system](#).
3. [Remove the air shroud](#)
4. Disconnect all the cables connected from the PIB to the system board.  
**i** **NOTE:** Ensure that you note the routing of the cables as you remove them from the system board.
5. [Remove the PSU](#).

### Steps

1. Using a Phillips #2 screwdriver, remove the two screws securing the Power Interposer Board (PIB) to the system.
2. Lift the board and slide it out at an angle to disengage the guide pins on the board.



**Figure 104. Removing power interposer board**

3. Lift the board away from the system.

### Next steps

1. [Install the power interposer board](#).

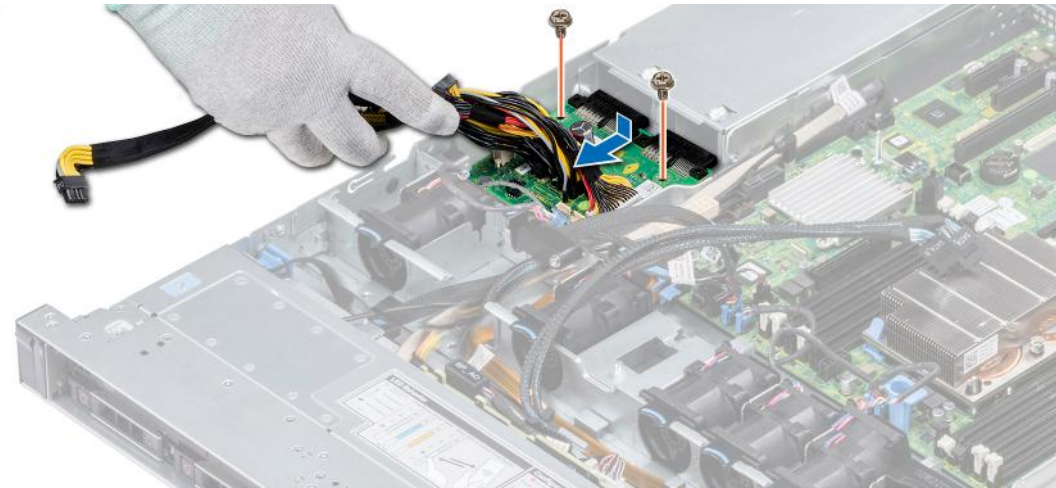
## Installing power interposer board

### Prerequisites

Follow the safety guidelines listed in [Safety instructions](#).

### Steps

1. Align the slots on the PIB with the guides on the system.
2. Using a Phillips #2 screwdriver, replace the two screws to secure the PIB to the system.
3. Route the cables and connect it to the system board.



**Figure 105. Installing power interposer board**

### Next steps

1. [Install the PSU.](#)
2. [Install the air shroud.](#)
3. Follow the procedure listed in [After working inside your system.](#)

## Control panel

### Removing the left control panel

#### Prerequisites

1. Follow the safety guidelines listed in [Safety instructions.](#)
2. Follow the procedure listed in [Before working inside your system.](#)
3. [Remove the air shroud.](#)
4. [Remove the internal PERC riser.](#)

#### Steps

1. Disconnect the control panel cable from the system board connector.

**i** **NOTE:** Ensure that you note the routing of the cables as you remove them from the system board. You must route the cables properly when you replace them to prevent the cables from being pinched or crimped.

2. Using a Phillips #1 screwdriver, remove the screws that secure the cable cover.



**Figure 106. Removing the cable cover**

3. Using a Phillips #1 screwdriver, remove the screws that connect the control panel to the system.



**Figure 107. Removing left control panel**

4. Holding by the sides, remove the left control panel assembly away from the system.

#### **Next steps**

Install the left control panel.

## **Installing the left control panel**

#### **Prerequisites**

Follow the safety guidelines listed in [Safety instructions](#).

#### **Steps**

1. Route the control panel cable through the side wall of the system.
2. Align the left control panel assembly with the control panel slot on the system and place the assembly in the slot on the system.
3. Connect the control panel cable to the system board connector.
4. Using Phillips #1 screwdriver, install the screws that secure the cable cover to the system.



**Figure 108. Installing the cable cover**

### Next steps

1. Follow the safety guidelines listed in [Safety instructions](#).
2. [Install the air shroud](#).
3. [Install the internal PERC riser](#).
4. Follow the procedure listed in [Before working inside your system](#).

## Removing the right control panel

### Prerequisites

1. Follow the safety guidelines listed in [Safety instructions](#).
2. Follow the procedure listed in [Before working inside your system](#).
3. [Remove the internal PERC riser](#).

### Steps

1. Lift the cable latch and disconnect the control panel cable from the connector on the system board.

**NOTE:** Ensure that you note the routing of the cables as you remove them from the system board. You must route the cables properly when you replace them to prevent the cables from being pinched or crimped.

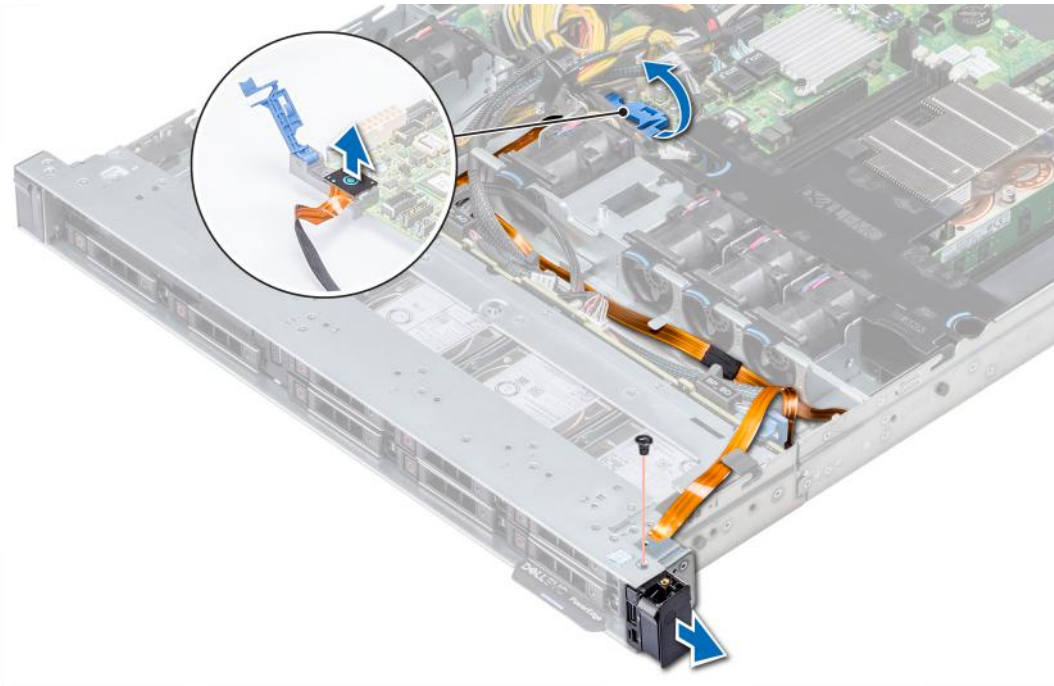
2. Using a Phillips #1 screwdriver, remove the screws that secure the cable cover to the system.



**Figure 109. Removing the cable cover**

3. Using a Phillips #1 screwdriver, remove the screw that secures the control panel to the system.





**Figure 110. Removing right control panel**

4. Holding the control panel by its sides, remove the control panel away from the system.

**Next steps**

Install the right control panel.

## Installing the right control panel

**Prerequisites**

Follow the safety guidelines listed in [Safety instructions](#).

**Steps**

1. Route the control panel cable through the side wall of the system.
2. Align the right control panel with the control panel slot on the system and place the assembly in the slot on the system.
3. Connect the control panel cable to the connector on the system board and lower the cable latch to secure the cable in place.
4. Using a Phillips #1 screwdriver, install the screws that secure the cable cover to the system.



**Figure 111. Installing the cable cover**


## Next steps


1. [Install the internal PERC riser.](#)
2. Follow the procedure listed in [After working inside your system.](#)

# System board

## Removing the system board

### Prerequisites


 **CAUTION:** If you are using the Trusted Platform Module (TPM) with an encryption key, you may be prompted to create a recovery key during program or System Setup. Be sure to create and safely store this recovery key. If you replace this system board, you must supply the recovery key when you restart your system or program before you can access the encrypted data on your hard drives.


 **CAUTION:** Do not attempt to remove the TPM plug-in module from the system board. Once the TPM plug-in module is installed, it is cryptographically bound to that specific system board. Any attempt to remove an installed TPM plug-in module breaks the cryptographic binding, and it cannot be re-installed or installed on another system board.


1. Follow the safety guidelines listed in [Safety instructions.](#)
2. Follow the procedure listed in [Before working inside your system.](#)
3. Remove the following:
  - a. [Air shroud](#)
  - b. [All expansion cards and risers](#)
  - c. [Internal PERC riser](#)
  - d. [IDSDM/vFlash module card](#)
  - e. [Internal USB key \(if installed\)](#)
  - f. [Processors and heat sink modules](#)
  - g. [Memory modules](#)
  - h. [LOM riser card](#)

### Steps

1. Disconnect all cables from the system board.

 **NOTE:** Ensure that you note the routing of the cables as you remove them from the system board.

 **CAUTION:** Take care not to damage the system identification button while removing the system board from the chassis.

 **CAUTION:** Do not lift the system board by holding a memory module, processor, or other components.

2. Using a Phillips #2 screwdriver, remove the screws that secure the system board to the chassis.
3. Hold the system board holder, slightly lift the system board, and then slide it toward the front of the chassis.
4. Using the system board holder, lift the system board out of the chassis.

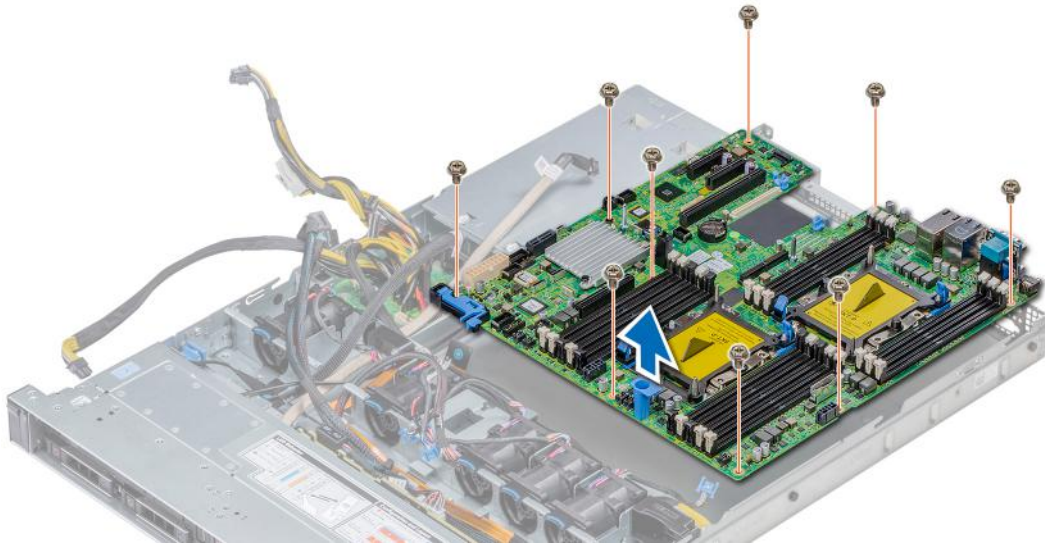


Figure 112. Removing the system board

### Next steps

Install the system board.

## Installing the system board

### Prerequisites

Follow the safety guidelines listed in [Safety instructions](#).

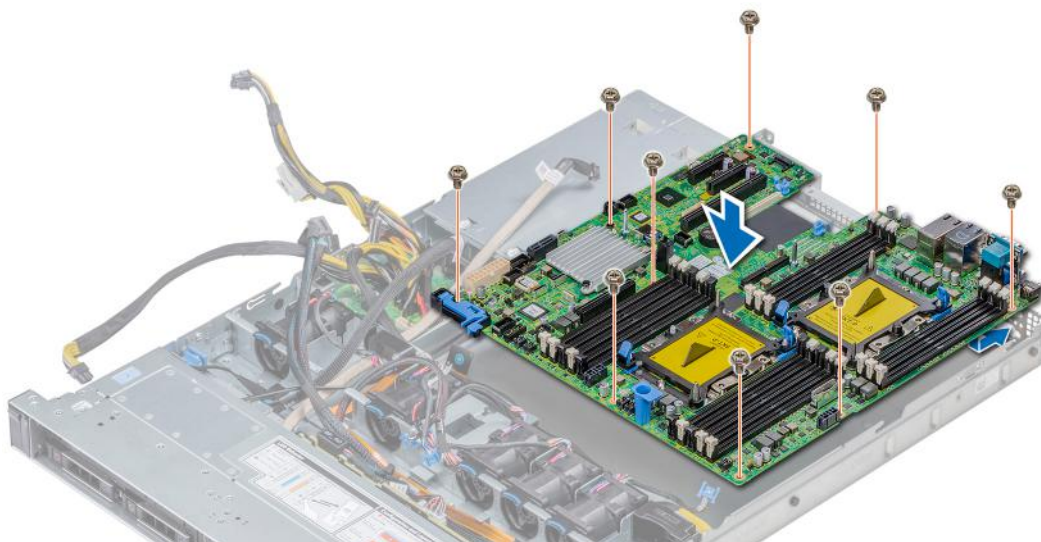
### Steps

1. Unpack the new system board assembly.

**CAUTION:** Do not lift the system board by holding a memory module, processor, or other components.

**CAUTION:** Take care not to damage the system identification button while placing the system board into the chassis.

2. Holding the system board holder, align the connector on the system board with the slots on the back of the chassis and place the system board in place.
3. Using a Phillips #2 screwdriver, replace the screws that secure the system board to the chassis.



**Figure 113. Installing the system board**

### Next steps

1. Replace the following:
  - a. Install the Trusted Platform Module (TPM).
  - b. [Internal PERC riser](#)
  - c. Internal USB key (if applicable)
  - d. USB 3.0 module (if applicable)
  - e. [IDSDM/vFlash module card](#)
  - f. [All expansion cards and risers](#)
  - g. [Processors and heat sink modules](#)
  - h. Processors blanks (if applicable)
  - i. [Memory modules](#)
  - j. [LOM riser card](#)
  - k. [Air shroud](#)
2. Reconnect all cables to the system board.
 

**NOTE:** Ensure that the cables inside the system are routed along the chassis wall and secured using the cable securing bracket.
3. Follow the procedure listed in [Before working inside your system](#).
4. Ensure that you:
  - a. Use the Easy Restore feature to restore the Service Tag. For more information, see the [Restoring the Service Tag by using the Easy Restore feature](#) section.
  - b. If the Service Tag is not backed up in the backup flash device, enter the Service Tag manually. For more information, see the [Restoring the Service Tag by using the Easy Restore feature](#) section.
  - c. Update the BIOS and iDRAC versions.
  - d. Re-enable the Trusted Platform Module (TPM). For more information, see the [Upgrading the Trusted Platform Module](#) section.
5. Import your new or existing iDRAC Enterprise license.

For more information, see *Integrated Dell Remote Access Controller User's Guide*, at [www.dell.com/poweredgemanuals](http://www.dell.com/poweredgemanuals)

## Restoring the system using Easy Restore

The easy restore feature enables you to restore your service tag, license, UEFI configuration, and the system configuration data after replacing the system board. All data is backed up in a backup flash device automatically. If BIOS detects a new system board, and the service tag in the backup flash device, BIOS prompts the user to restore the backup information.

### About this task

Below is a list of options available:

- Restore the service tag, license, and diagnostics information, press **Y**
- Navigate to the Lifecycle Controller based restore options, press **N**.
- Restore data from a previously created **Hardware Server Profile**, press **F10**  
**i** **NOTE:** When the restore process is complete, BIOS prompts to restore the system configuration data.
- To restore the system configuration data, press **Y**
- To use the default configuration settings, press **N**  
**i** **NOTE:** After the restore process is complete, system reboots.

## Manually update the Service Tag

After replacing a system board, if Easy Restore fails, follow this process to manually enter the Service Tag, using **System Setup**.

### About this task

If you know the system service tag, use the **System Setup** menu to enter the service tag.

#### Steps

1. Power on the system.
2. To enter the **System Setup**, press **F2**.
3. Click **Service Tag Settings**.
4. Enter the service tag.  
**i** **NOTE:** You can enter the service tag only when the **Service Tag** field is empty. Ensure that you enter the correct service tag. Once the service tag is entered, it cannot be updated or changed.
5. Click **OK**.

## Entering the system Service Tag by using System Setup

If Easy Restore fails to restore the Service Tag, use System Setup to enter the Service Tag.

#### Steps

1. Turn on the system.
2. Press F2 to enter System Setup.
3. Click **Service Tag Settings**.
4. Enter the Service Tag.  
**i** **NOTE:** You can enter the Service Tag only when the **Service Tag** field is empty. Ensure that you enter the correct Service Tag. After the Service Tag is entered, it cannot be updated or changed.
5. Click **OK**.
6. Import your new or existing iDRAC Enterprise license.  
For more information, see the *Integrated Dell Remote Access Controller User's Guide* at [www.dell.com/poweredgemanuals](http://www.dell.com/poweredgemanuals).

# Trusted Platform Module

## Upgrading the Trusted Platform Module


### Prerequisites


1. Follow the safety guidelines listed in [Safety instructions](#).
2. Follow the procedure listed in [Before working inside your system](#).

### NOTE:

- Ensure that your operating system supports the version of the TPM module being installed.
- Ensure that you download and install the latest BIOS firmware on your system.
- Ensure that the BIOS is configured to enable UEFI boot mode.

### About this task

 **CAUTION:** If you are using the Trusted Platform Module (TPM) with an encryption key, you may be prompted to create a recovery key during program or System Setup. Work with the customer to create and safely store this recovery key. When replacing this system board, you must supply the recovery key when you restart your system or program before you can access the encrypted data on your hard drives.

 **CAUTION:** Once the TPM plug-in module is installed, it is cryptographically bound to that specific system board. Any attempt to remove an installed TPM plug-in module breaks the cryptographic binding, the removed TPM cannot be reinstalled or installed on another system board.

## Removing the TPM

### Steps

1. Locate the TPM connector on the system board.
2. Press to hold the module down and remove the screw using the security Torx 8-bit shipped with the TPM module.
3. Slide the TPM module out from its connector.
4. Push the plastic rivet away from the TPM connector and rotate it 90° counterclockwise to release it from the system board.
5. Pull the plastic rivet out of its slot on the system board.

## Installing the TPM

### Steps

1. To install the TPM, align the edge connectors on the TPM with the slot on the TPM connector.
2. Insert the TPM into the TPM connector such that the plastic rivet aligns with the slot on the system board.
3. Press the plastic rivet until the rivet snaps into place.



Figure 114. Installing the TPM

#### Next steps

1. Install the system board.
2. Follow the procedure listed in [After working inside your system](#).

## Initializing TPM for BitLocker users

#### Steps

Initialize the TPM.

For more information, see .

The **TPM Status** changes to **Enabled, Activated**.

## Initializing the TPM 1.2 for TXT users

#### Steps

1. While booting your system, press F2 to enter System Setup.
2. On the **System Setup Main Menu** screen, click **System BIOS > System Security Settings**.
3. From the **TPM Security** option, select **On with Pre-boot Measurements**.
4. From the **TPM Command** option, select **Activate**.
5. Save the settings.
6. Restart your system.
7. Enter **System Setup** again.
8. On the **System Setup Main Menu** screen, click **System BIOS > System Security Settings**.
9. From the **Intel TXT** option, select **On**.

# Jumpers and connectors

This topic provides specific information about the jumpers. It also provides some basic information about jumpers and switches and describes the connectors on the board in the system. Jumpers on the system board help to disable the system and setup passwords. You must know the connectors on the system board to install components and cables correctly.

## Topics:

- System board jumpers and connectors
- System board jumper settings
- Disabling forgotten password

## System board jumpers and connectors

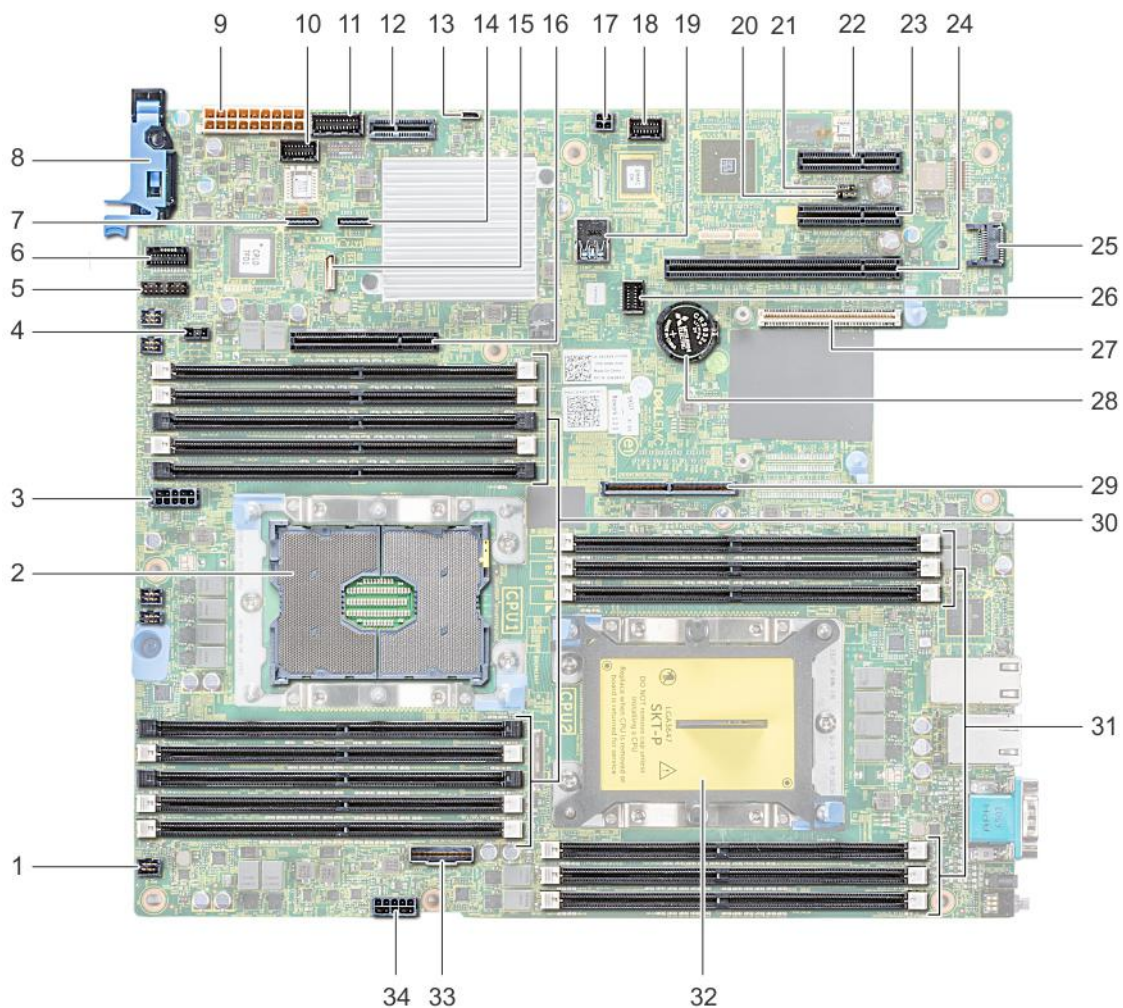


Figure 115. System board jumpers and connectors



**Table 30. System board jumpers and connectors**

Item	Connector	Description
1.	FAN6	Cooling fan 6 connector
2.	CPU1	Processor socket 1
3.	CPU1_PWR_CONN(P2)	CPU1 power connector
4.	J_INTRU	Intrusion switch connector
5.	J_BP_SIG1	Backplane signal connector 1
6.	LFT_CP_CONN	Left control panel connector
7.	J_SATA_B1	Internal SATA B connector
8.	RGT_CP_CONN	Right panel connector
9.	SYS_PWR_CONN(P1)	System power connector
10.	J_PIB_SIG1	Power interposer board signal connector 1
11.	J_PIB_SIG2	Power interposer board signal connector 2
12.	J_ACE	Internal Dual SD Module
13.	J_CP_USB2	Front USB connector
14.	J_SATA_A1	Internal SATA A connector
15.	J_SATA_C1	Internal SATA C connector
16.	PCIE_G3_X8(CPU1)	Internal PERC controller connector
17.	J_REAR_BP_PWR1	Rear backplane power connector
18.	J_FRONT_VIDEO	VGA connector
19.	INT_USB_3.0	USB connector
20.	NVRAM_CLR	Clear NVRAM
21.	PWRD_EN	Reset BIOS password
22.	SLOT5	PCIe slot 5
23.	SLOT4	PCIe slot 4
24.	SLOT3	PCIe slot 3
25.	J_TPM_MODULE	TPM module connector
26.	J_BP_SIG0	Backplane signal connector
27.	J_MEZZ_A1	LOM riser card connector
28.	BATTERY	Battery connector
29.	PCIE_G3_X16(CPU1)	Riser 1 connector
30.	A6, A5, A10, A4, A9, A7, A1, A8, A2, A3	Memory module sockets
31.	B3, B2, B1, B4, B5, B6	Memory module sockets
32.	CPU2	Processor socket 2
33.	PCIE_A0	NVMe connector
34.	CPU2_PWR_CONN(P3)	CPU2 power connector


## System board jumper settings

For information on resetting the password jumper to disable a password, see the [Disabling a forgotten password](#) section.

# Disabling forgotten password

The software security features of the system include a system password and a setup password. The password jumper enables or disables password features and clears any password(s) currently in use.


## Prerequisites

 **CAUTION:** Many repairs may only be done by a certified service technician. You should only perform troubleshooting and simple repairs as authorized in your product documentation, or as directed by the online or telephone service and support team. Damage due to servicing that is not authorized by Dell is not covered by your warranty. Read and follow the safety instructions that are shipped with your product.

## Steps

1. Power off the system, including any attached peripherals, and disconnect the system from the electrical outlet.
2. Remove the system cover.
3. Move the jumper on the system board jumper from pins 2 and 4 to pins 4 and 6.
4. Install the system cover.

The existing passwords are not disabled (erased) until the system boots with the jumper on pins 4 and 6. However, before you assign a new system and/or setup password, you must move the jumper back to pins 2 and 4.

 **NOTE:** If you assign a new system and/or setup password with the jumper on pins 4 and 6, the system disables the new password(s) the next time it boots.

5. Reconnect the system to its electrical outlet and power on the system, including any attached peripherals.
6. Power off the system, including any attached peripherals, and disconnect the system from the electrical outlet.
7. Remove the system cover.
8. Move the jumper on the system board jumper from pins 4 and 6 to pins 2 and 4.
9. Install the system cover.
10. Reconnect the system to its electrical outlet and power on the system, including any attached peripherals.
11. Assign a new system and/or setup password.

# System diagnostics

If you experience a problem with your system, run the system diagnostics before contacting Dell for technical assistance. The purpose of running system diagnostics is to test your system hardware without using additional equipment or risking data loss. If you are unable to fix the problem yourself, service and support personnel can use the diagnostics results to help you solve the problem.

## Topics:

- [Dell Embedded System Diagnostics](#)

## Dell Embedded System Diagnostics

**NOTE:** The Dell Embedded System Diagnostics is also known as Enhanced Pre-boot System Assessment (ePSA) diagnostics.

The Embedded System Diagnostics provides a set of options for particular device groups or devices allowing you to:

- Run tests automatically or in an interactive mode
- Repeat tests
- Display or save test results
- Run thorough tests to introduce additional test options to provide extra information about the failed device(s)
- View status messages that inform you if tests are completed successfully
- View error messages that inform you of problems encountered during testing

## Running the Embedded System Diagnostics from Boot Manager

Run the Embedded System Diagnostics (ePSA) if your system does not boot.

### Steps

1. When the system is booting, press F11.
2. Use the up arrow and down arrow keys to select **System Utilities > Launch Diagnostics**.
3. Alternatively, when the system is booting, press F10, select **Hardware Diagnostics > Run Hardware Diagnostics**. The **ePSA Pre-boot System Assessment** window is displayed, listing all devices detected in the system. The diagnostics starts executing the tests on all the detected devices.

## Running the Embedded System Diagnostics from the Dell Lifecycle Controller

### Steps

1. As the system boots, press F10.
2. Select **Hardware Diagnostics → Run Hardware Diagnostics**. The **ePSA Pre-boot System Assessment** window is displayed, listing all devices detected in the system. The diagnostics starts executing the tests on all the detected devices.

## System diagnostic controls

Menu	Description
<b>Configuration</b>	Displays the configuration and status information of all detected devices.

<b>Menu</b>	<b>Description</b>
<b>Results</b>	Displays the results of all tests that are run.
<b>System health</b>	Provides the current overview of the system performance.
<b>Event log</b>	Displays a time-stamped log of the results of all tests run on the system. This is displayed if at least one event description is recorded.

# Getting help

## Topics:

- [Contacting Dell EMC](#)
- [Documentation feedback](#)
- [Accessing system information by using QRL](#)
- [Receiving automated support with SupportAssist](#)
- [Recycling or End-of-Life service information](#)

## Contacting Dell EMC

Dell EMC provides several online and telephone based support and service options. If you do not have an active internet connection, you can find contact information about your purchase invoice, packing slip, bill, or Dell EMC product catalog. Availability varies by country and product, and some services may not be available in your area. To contact Dell EMC for sales, technical assistance, or customer service issues:

### Steps

1. Go to [www.dell.com/support/home](http://www.dell.com/support/home).
2. Select your country from the drop-down menu on the lower right corner of the page.
3. For customized support:
  - a. Enter your system Service Tag in the **Enter your Service Tag** field.
  - b. Click **Submit**.  
The support page that lists the various support categories is displayed.
4. For general support:
  - a. Select your product category.
  - b. Select your product segment.
  - c. Select your product.  
The support page that lists the various support categories is displayed.
5. For contact details of Dell EMC Global Technical Support:
  - a. Click [Contact Technical Support](#).
  - b. Enter your system Service Tag in the **Enter your Service Tag** field on the Contact Us webpage.

## Documentation feedback

You can rate the documentation or write your feedback on any of our Dell EMC documentation pages and click **Send Feedback** to send your feedback.

## Accessing system information by using QRL

You can use the Quick Resource Locator (QRL) located on the information tag in the front of the system, to access the information about the PowerEdge system.

### Prerequisites

Ensure that your smartphone or tablet has the QR code scanner installed.

The QRL includes the following information about your system:

- How-to videos

- Reference materials, including the Installation and Service Manual, LCD diagnostics, and mechanical overview
- Your system service tag to quickly access your specific hardware configuration and warranty information
- A direct link to Dell to contact technical assistance and sales teams

### Steps

1. Go to [www.dell.com/qrl](http://www.dell.com/qrl) and navigate to your specific product or
2. Use your smartphone or tablet to scan the model-specific Quick Resource (QR) code on your system or in the Quick Resource Locator section.

## Quick Resource Locator for Dell EMC PowerEdge R440 system



Figure 116. Quick Resource Locator for Dell EMC PowerEdge R440 system

## Receiving automated support with SupportAssist

Dell EMC SupportAssist is an optional Dell EMC Services offering that automates technical support for your Dell EMC server, storage, and networking devices. By installing and setting up a SupportAssist application in your IT environment, you can receive the following benefits:

- **Automated issue detection** — SupportAssist monitors your Dell EMC devices and automatically detects hardware issues, both proactively and predictively.
- **Automated case creation** — When an issue is detected, SupportAssist automatically opens a support case with Dell EMC Technical Support.
- **Automated diagnostic collection** — SupportAssist automatically collects system state information from your devices and uploads it securely to Dell EMC. This information is used by Dell EMC Technical Support to troubleshoot the issue.
- **Proactive contact** — A Dell EMC Technical Support agent contacts you about the support case and helps you resolve the issue.

The available benefits vary depending on the Dell EMC Service entitlement purchased for your device. For more information about SupportAssist, go to [www.dell.com/supportassist](http://www.dell.com/supportassist).


## Recycling or End-of-Life service information

Take back and recycling services are offered for this product in certain countries. If you want to dispose of system components, visit [www.dell.com/recyclingworldwide](http://www.dell.com/recyclingworldwide) and select the relevant country.

## Documentation resources

This section provides information about the documentation resources for your system.

To view the document that is listed in the documentation resources table:

- From the Dell EMC support site:
  1. Click the documentation link that is provided in the Location column in the table.
  2. Click the required product or product version.
-  **NOTE:** To locate the product name and model, see the front of your system.
- 3. On the Product Support page, click **Manuals & documents**.
- Using search engines:
  - Type the name and version of the document in the search box.

**Table 31. Documentation resources**

Task	Document	Location
Setting up your system	<p>For more information about installing and securing the system into a rack, see the Rail Installation Guide included with your rack solution.</p> <p>For information about setting up your system, see the <i>Getting Started Guide</i> document that is shipped with your system.</p>	<a href="https://www.dell.com/poweredgemanuals">https://www.dell.com/poweredgemanuals</a>
Configuring your system	<p>For information about the iDRAC features, configuring and logging in to iDRAC, and managing your system remotely, see the Integrated Dell Remote Access Controller User's Guide.</p> <p>For information about understanding Remote Access Controller Admin (RACADM) subcommands and supported RACADM interfaces, see the RACADM CLI Guide for iDRAC.</p> <p>For information about Redfish and its protocol, supported schema, and Redfish Eventing implemented in iDRAC, see the Redfish API Guide.</p> <p>For information about iDRAC property database group and object descriptions, see the Attribute Registry Guide.</p> <p>For information about Intel QuickAssist Technology, see the Integrated Dell Remote Access Controller User's Guide.</p>	<a href="https://www.dell.com/poweredgemanuals">https://www.dell.com/poweredgemanuals</a>
	<p>For information about earlier versions of the iDRAC documents.</p> <p>To identify the version of iDRAC available on your system, on the iDRAC web interface, click <b>? &gt; About</b>.</p>	<a href="https://www.dell.com/idracmanuals">https://www.dell.com/idracmanuals</a>
	For information about installing the operating system, see the operating system documentation.	<a href="https://www.dell.com/operatingsystemmanuals">https://www.dell.com/operatingsystemmanuals</a>

**Table 31. Documentation resources (continued)**

Task	Document	Location
	For information about updating drivers and firmware, see the Methods to download firmware and drivers section in this document.	<a href="http://www.dell.com/support/drivers">www.dell.com/support/drivers</a>
Managing your system	For information about system management software offered by Dell, see the Dell OpenManage Systems Management Overview Guide.	<a href="https://www.dell.com/poweredgemanuals">https://www.dell.com/poweredgemanuals</a>
	For information about setting up, using, and troubleshooting OpenManage, see the Dell OpenManage Server Administrator User's Guide.	<a href="http://www.dell.com/openmanagemanuals">www.dell.com/openmanagemanuals</a> > OpenManage Server Administrator
	For information about installing, using, and troubleshooting Dell OpenManage Enterprise, see the Dell OpenManage Enterprise User's Guide.	<a href="https://www.dell.com/openmanagemanuals">https://www.dell.com/openmanagemanuals</a>
	For information about installing and using Dell SupportAssist, see the Dell EMC SupportAssist Enterprise User's Guide.	<a href="https://www.dell.com/serviceabilitytools">https://www.dell.com/serviceabilitytools</a>
	For information about partner programs enterprise systems management, see the OpenManage Connections Enterprise Systems Management documents.	<a href="https://www.dell.com/openmanagemanuals">https://www.dell.com/openmanagemanuals</a>
Working with the Dell PowerEdge RAID controllers	For information about understanding the features of the Dell PowerEdge RAID controllers (PERC), Software RAID controllers, or BOSS card and deploying the cards, see the Storage controller documentation.	<a href="http://www.dell.com/storagecontrollermanuals">www.dell.com/storagecontrollermanuals</a>
Understanding event and error messages	For information about the event and error messages generated by the system firmware and agents that monitor system components, go to <a href="http://qrl.dell.com">qrl.dell.com</a> > <b>Look Up</b> > <b>Error Code</b> , type the error code, and then click <b>Look it up</b> .	<a href="http://www.dell.com/qrl">www.dell.com/qrl</a>
Troubleshooting your system	For information about identifying and troubleshooting the PowerEdge server issues, see the Server Troubleshooting Guide.	<a href="https://www.dell.com/poweredgemanuals">https://www.dell.com/poweredgemanuals</a>