

Dell Precision Tower 5810

Owner's Manual



Notes, cautions, and warnings

 **NOTE:** A NOTE indicates important information that helps you make better use of your product.

 **CAUTION:** A CAUTION indicates either potential damage to hardware or loss of data and tells you how to avoid the problem.

 **WARNING:** A WARNING indicates a potential for property damage, personal injury, or death.

© 2016 2018 Dell Inc. or its subsidiaries. All rights reserved. Dell, EMC, and other trademarks are trademarks of Dell Inc. or its subsidiaries. Other trademarks may be trademarks of their respective owners.

1 Working on your computer.....	5
Safety instructions.....	5
Before working inside your computer.....	5
Turning off your computer.....	6
After working inside your computer.....	6
2 Removing and installing components.....	7
Recommended Tools.....	7
System Overview.....	7
Removing the Power Supply Unit - PSU.....	9
Installing the Power Supply Unit - PSU.....	9
Removing the Computer Cover.....	10
Installing the Computer Cover.....	10
Removing the PSU Card.....	10
Installing the PSU Card.....	11
Removing the Front Bezel.....	11
Installing the Front Bezel.....	12
Removing the Slim Line Optical Drive	12
Installing the Slim Line Optical Drive	15
Removing the Hard Drive.....	15
Installing the Hard Drive	17
Removing the Speaker.....	17
Installing the Speaker.....	18
Removing the HDD Thermal Sensor.....	18
Installing the HDD Thermal Sensor.....	19
Removing the Input-Output Panel.....	19
Installing the Input-Output Panel.....	21
Removing the Memory Shroud.....	21
Installing the Memory Shroud.....	22
Removing the Memory.....	22
Installing the Memory.....	22
Removing the Coin-Cell Battery.....	23
Installing the Coin-Cell Battery.....	23
Removing the PCI Card.....	23
Installing the PCI Card.....	24
Removing the PCIe-Card Retention.....	24
Installing the PCIe card retention.....	24
Removing the System-Fan Assembly.....	25
Installing the System-Fan Assembly.....	28
Removing the Heatsink Assembly.....	28
Installing the Heatsink Assembly.....	28
Removing the Heatsink Fan.....	29
Installing the Heatsink Fan.....	29
Removing the Processor.....	29

Installing the Processor.....	30
System Board Components.....	30
Removing the System Board.....	32
Installing the System Board.....	33
3 Additional Information.....	34
Memory Module Guidelines.....	34
Power Supply Unit - PSU Lock.....	34
4 System setup.....	36
Boot Sequence.....	36
Navigation keys.....	36
System Setup Options.....	37
Updating the BIOS in Windows	43
System and setup password.....	43
Assigning a system password and setup password.....	43
Deleting or changing an existing system and or setup password.....	44
Disabling a System Password.....	44
5 Diagnostics.....	45
Enhanced Pre-Boot System Assessment - ePSA Diagnostics.....	45
6 Troubleshooting your computer.....	46
Diagnostic LEDs.....	46
Error Messages.....	47
7 Technical Specifications.....	49
8 Contacting Dell.....	54

Working on your computer

Safety instructions

Use the following safety guidelines to protect your computer from potential damage and to ensure your personal safety. Unless otherwise noted, each procedure included in this document assumes that the following conditions exist:

- You have read the safety information that shipped with your computer.
- A component can be replaced or, if purchased separately, installed by performing the removal procedure in reverse order.

NOTE: Disconnect all power sources before opening the computer cover or panels. After you finish working inside the computer, replace all covers, panels, and screws before connecting to the power source.

NOTE: Before working inside your computer, read the safety information that shipped with your computer. For additional safety best practices information, see the Regulatory Compliance Homepage at www.Dell.com/regulatory_compliance

CAUTION: Many repairs may only be done by a certified service technician. You should only perform troubleshooting and simple repairs as authorized in your product documentation, or as directed by the online or telephone service and support team. Damage due to servicing that is not authorized by Dell is not covered by your warranty. Read and follow the safety instructions that came with the product.

CAUTION: To avoid electrostatic discharge, ground yourself by using a wrist grounding strap or by periodically touching an unpainted metal surface at the same time as touching a connector on the back of the computer.

CAUTION: Handle components and cards with care. Do not touch the components or contacts on a card. Hold a card by its edges or by its metal mounting bracket. Hold a component such as a processor by its edges, not by its pins.

CAUTION: When you disconnect a cable, pull on its connector or on its pull-tab, not on the cable itself. Some cables have connectors with locking tabs; if you are disconnecting this type of cable, press in on the locking tabs before you disconnect the cable. As you pull connectors apart, keep them evenly aligned to avoid bending any connector pins. Also, before you connect a cable, ensure that both connectors are correctly oriented and aligned.

NOTE: The color of your computer and certain components may appear differently than shown in this document.

Before working inside your computer

To avoid damaging your computer, perform the following steps before you begin working inside the computer.

1. Ensure that you follow the [Safety instructions](#).
2. Ensure that your work surface is flat and clean to prevent the computer cover from being scratched.
3. Ensure you follow the [Turning off your computer](#).
4. Disconnect all network cables from the computer.







CAUTION: To disconnect a network cable, first unplug the cable from your computer and then unplug the cable from the network device.

5. Disconnect your computer and all attached devices from their electrical outlets.
6. Press and hold the power button while the computer is unplugged to ground the system board.

NOTE: To avoid electrostatic discharge, ground yourself by using a wrist grounding strap or by periodically touching an unpainted metal surface at the same time as touching a connector on the back of the computer.

Turning off your computer

 **CAUTION:** To avoid losing data, save and close all open files and exit all open programs before you turn off your computer.

- Turning off your computer (Windows 8.1):
 - Using a touch enabled device:
 - Swipe in from the right edge of the screen, opening the **Charms** menu and select **Settings**.
 - Select  and then select **Shut down**.
or
 - On the **Home** screen, touch  and then select **Shut down**.
 - Using a mouse:
 - Point to upper-right corner of the screen and click **Settings**.
 - Click  and then select **Shut down**.
or
 - On the **Home** screen, click  and then select **Shut down**.
- Turning off your computer (Windows 7):
 - Click **Start** .
 - Click **Shut Down**.
or
 - Click **Start** .
 - Click the arrow in the lower-right corner of the **Start** menu, and then click **Log off**.
- Ensure that the computer and all attached devices are turned off. If your computer and attached devices did not automatically turn off when you shut down your operating system, press and hold the power button for about 6 seconds to turn them off.

After working inside your computer

After you complete any replacement procedure, ensure that you connect any external devices, cards, and cables before turning on your computer.

- Connect any telephone or network cables to your computer.

 **CAUTION:** To connect a network cable, first plug the cable into the network device and then plug it into the computer.
- Connect your computer and all attached devices to their electrical outlets.
- Turn on your computer.
- If required, verify that the computer works correctly by running **ePSA diagnostics**.

Removing and installing components

Recommended Tools

The procedures in this document may require the following tools:

- Small slotted-tip screwdriver
- #2 Phillips screwdriver
- #1 Phillips screwdriver
- Small plastic scribe

For how-to videos, documentation, and troubleshooting solutions, scan this QR code, or click here: <http://www.Dell.com/QRL/>



Workstation/T5810

System Overview

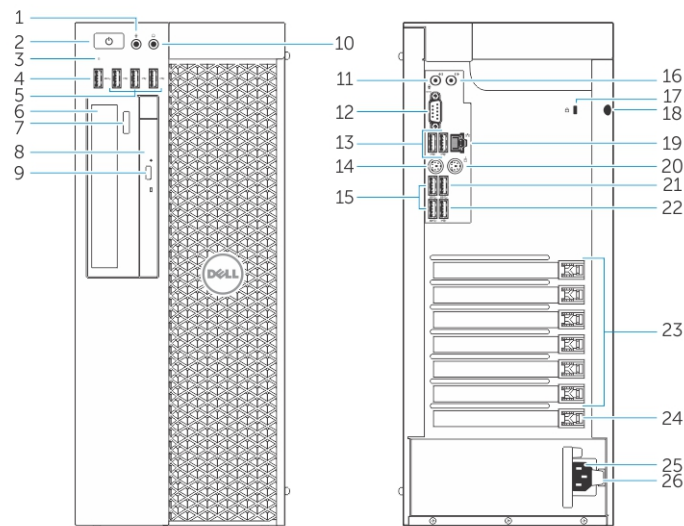

Figure 1. Front and Back View of T5810 Computer

1. microphone connector
2. power button/Power light
3. hard-drive activity light
4. USB 3.0 connector
5. USB 2.0 connectors
6. optical-drive (optional)
7. optical-drive eject button (optional)
8. optical-drive (optional)

- 9. optical-drive eject button (optional)
- 10. headphone connector
- 11. line-in/microphone connector
- 12. serial connector
- 13. USB 2.0 connectors
- 14. PS/2 Keyboard connector
- 15. USB 3.0 connectors
- 16. line-out connector
- 17. security cable slot
- 18. padlock ring
- 19. network connector
- 20. PS/2 Mouse connector
- 21. USB 3.0 connector
- 22. USB 2.0 connector
- 23. active expansion card slots
- 24. mechanical slot
- 25. power cable connector
- 26. power-supply unit (PSU) release latch

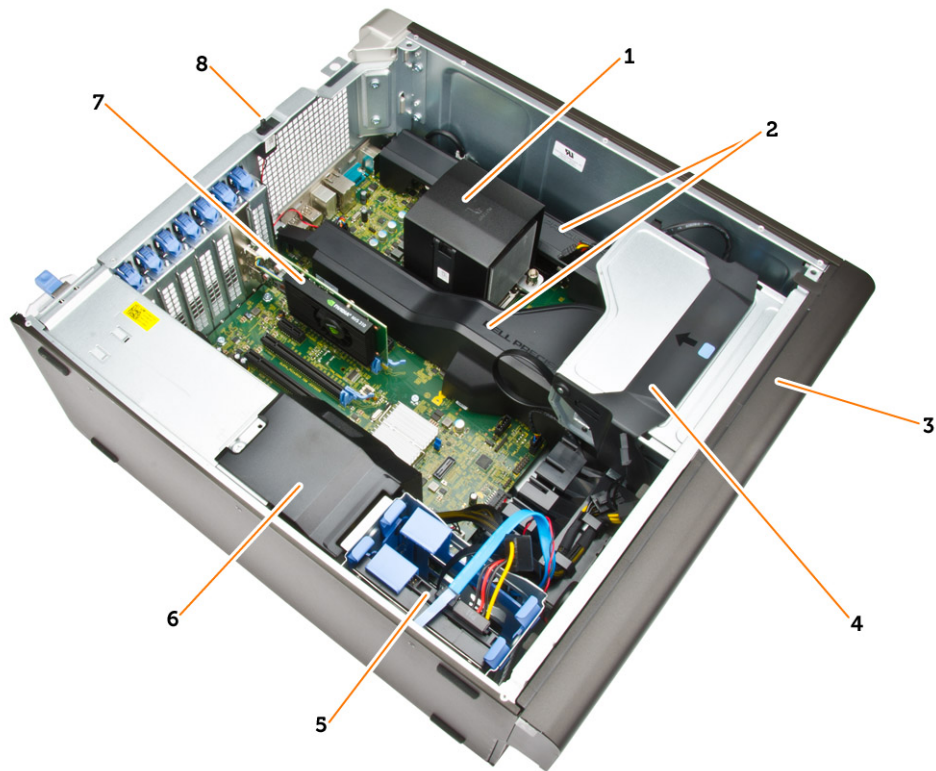

Figure 2. Inside View of T5810 Computer

- 1. heatsink with integrated fan
- 2. memory shrouds
- 3. front bezel
- 4. optical drive bay (5.25") and slimline optical drive bay
- 5. primary hard-drive slots (3.5" or 2.5")
- 6. PSU-cable shroud
- 7. graphics card
- 8. intrusion switch

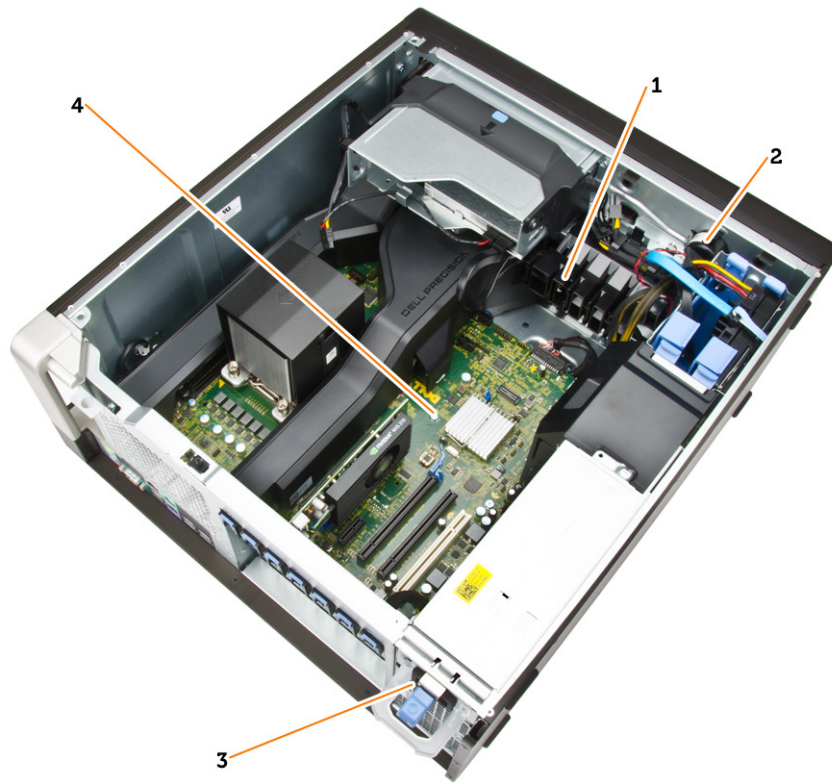
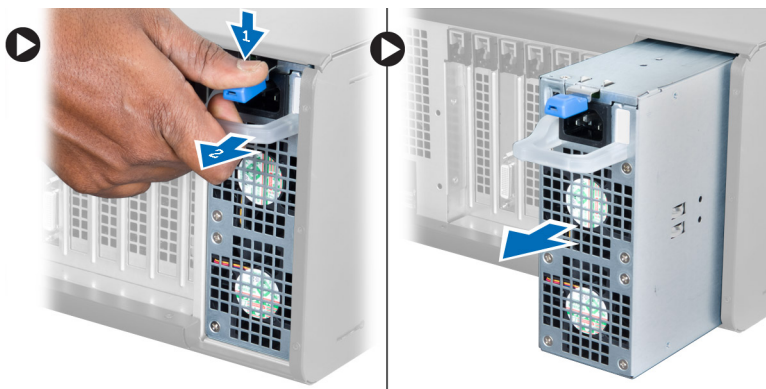

Figure 3. Inside View of T5810 Computer

- 1. PCIe-card retention
- 2. internal speaker
- 3. power-supply unit
- 4. motherboard

Removing the Power Supply Unit - PSU

- 1. Follow the procedures in [Before Working Inside Your Computer](#).
- 2. If the PSU is locked, remove the screw to unlock the PSU. For more information, see the [PSU Lock Feature](#).
- 3. Perform the following steps as shown in the illustration:
 - a) Hold the handle bar and press down on the blue latch to release the PSU [1,2].
 - b) Hold the handle bar to slide the PSU out of the computer.



Installing the Power Supply Unit - PSU

- 1. Hold the PSU handle and slide the PSU into the computer.

2. Follow the procedures in [After Working Inside Your Computer](#).

Removing the Computer Cover

1. Follow the procedures in [Before Working Inside Your Computer](#).
2. Lift up the cover-release latch.

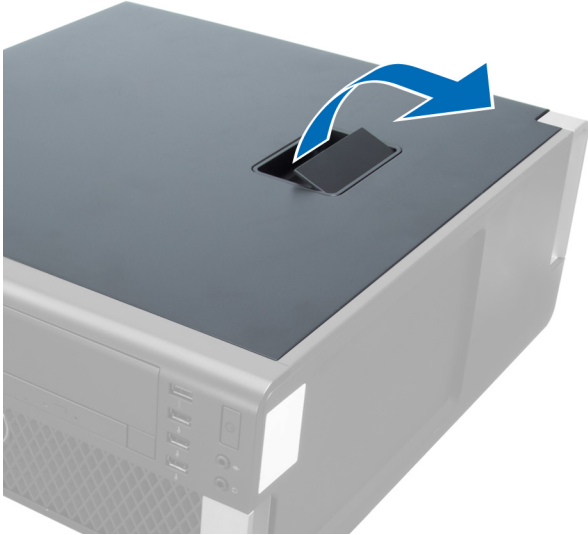

3. Lift the cover upward to a 45-degree angle, and remove it from the computer.



Installing the Computer Cover

1. Place the computer cover on the chassis.
2. Press down on the computer cover until it clicks into place.
3. Follow the procedures in [After Working Inside Your Computer](#).

Removing the PSU Card

1. Follow the procedures in [Before Working Inside Your Computer](#).
2. Remove:
 - a) [computer cover](#)
 - b) [PSU](#)
3. Perform the following steps as shown in the illustration:

- a) Slide the PSU cable shroud from its slot towards the front [1].
- b) Remove the PSU cable shroud from the computer [2].

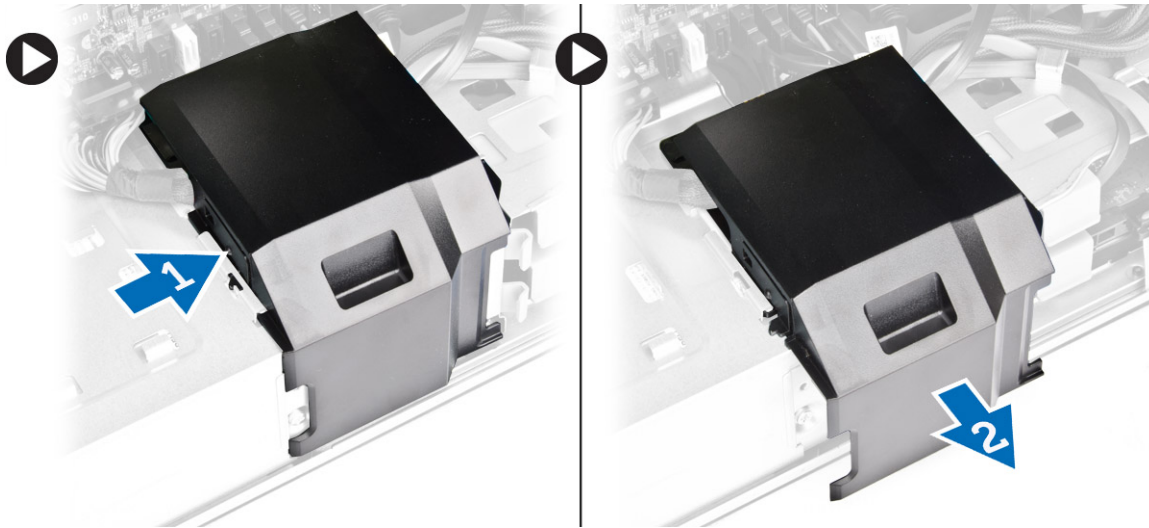

4. Perform the following steps as shown in the illustration:
 - a) Disconnect the power cables from the system board [1].
 - b) Remove the screws securing the PSU card to the slot [2].
 - c) Remove the PSU card from the computer [3].

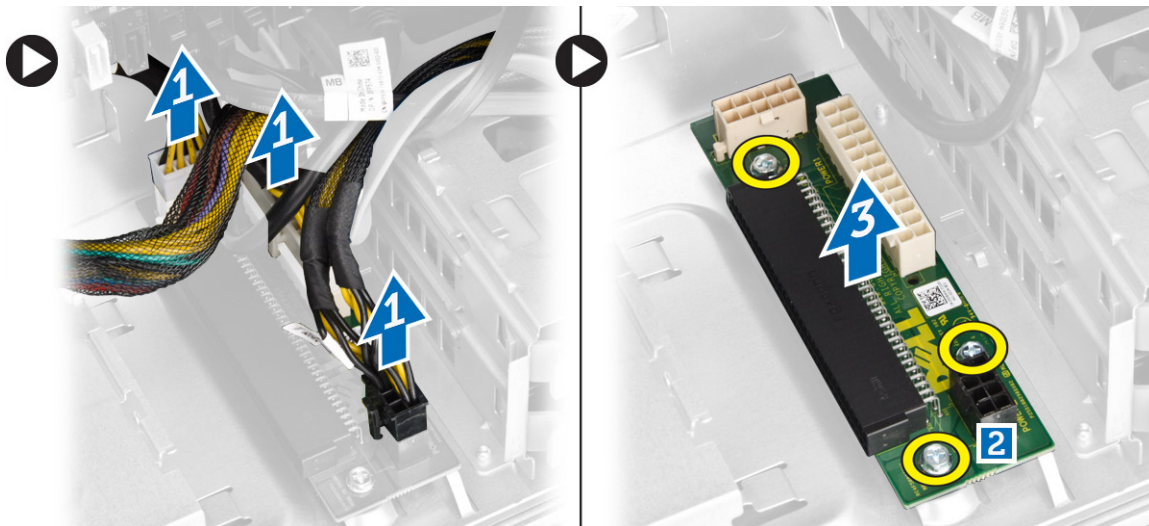

Installing the PSU Card

1. Replace the PSU card in its slot.
2. Tighten the screws to secure the PSU card in its slot.
3. Connect the power cables to the connectors on the PSU card.
4. Replace the PSU cable shroud in its slot.
5. Install:
 - a) [PSU](#)
 - b) [computer cover](#)
6. Follow the procedures in [After Working Inside Your Computer](#).

Removing the Front Bezel

1. Follow the procedures in [Before Working Inside Your Computer](#).
2. Remove the [computer cover](#).

3. Pry the front bezel retention clips away from the chassis located at the edge of front bezel.

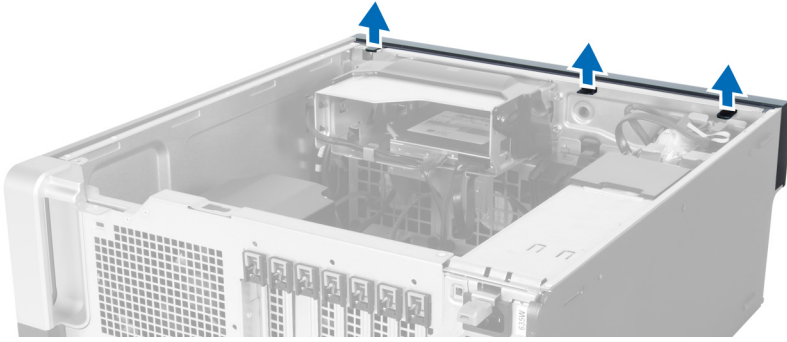

4. Rotate and pull the bezel panel away from the computer to release the hooks on the opposite edge of the bezel from the chassis.

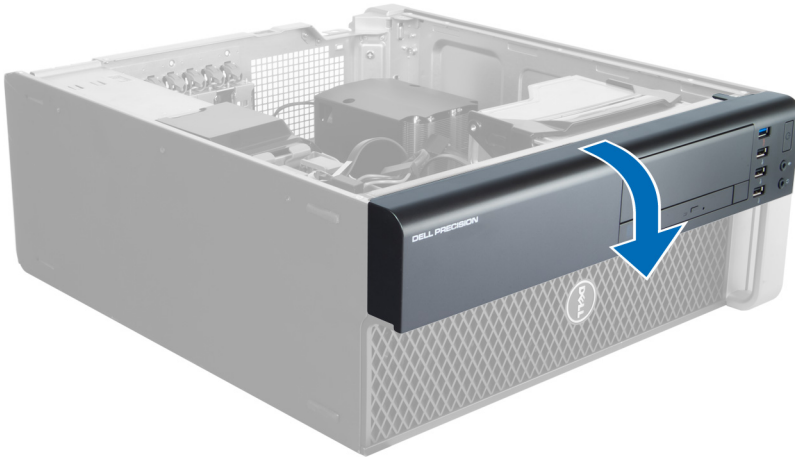

Installing the Front Bezel

1. Insert the hooks along the bottom edge of the front panel into the slots on the chassis front.
2. Rotate the bezel towards the computer to engage the front-bezel retention clips until they click into place.
3. Install the [computer cover](#).
4. Follow the procedures in [After Working Inside Your Computer](#).

Removing the Slim Line Optical Drive

1. Follow the procedures in [Before Working Inside Your Computer](#).
2. Remove the [computer cover](#).
3. Disconnect the data and power cables from the optical drive.

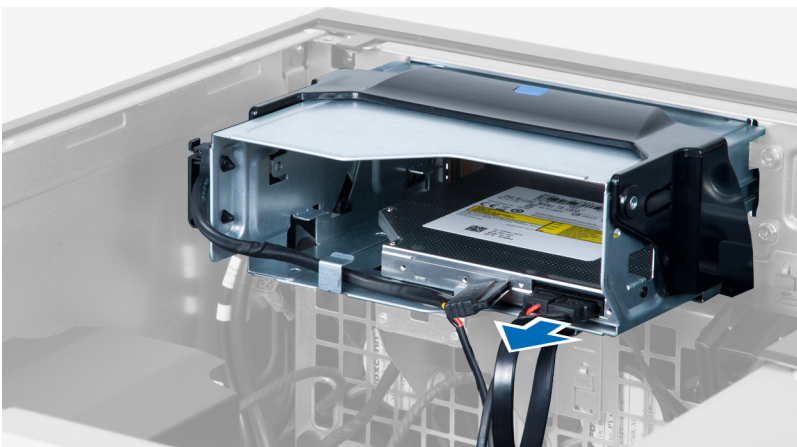

4. Unthread the cables from the latches.

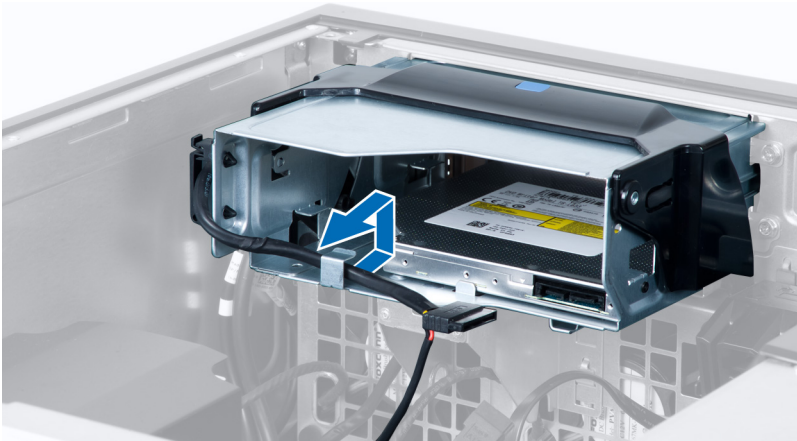

5. Press on the clasp to release the latch holding the cables on the side of the optical-drive cage.

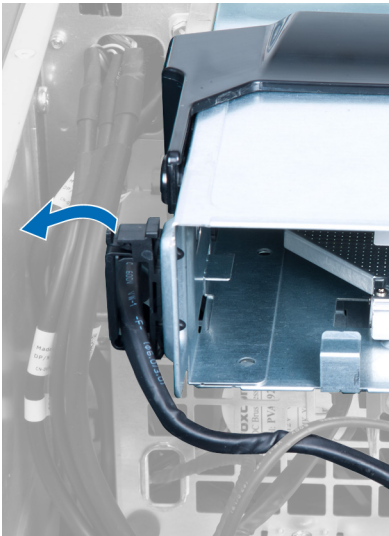

6. Lift up the cables.

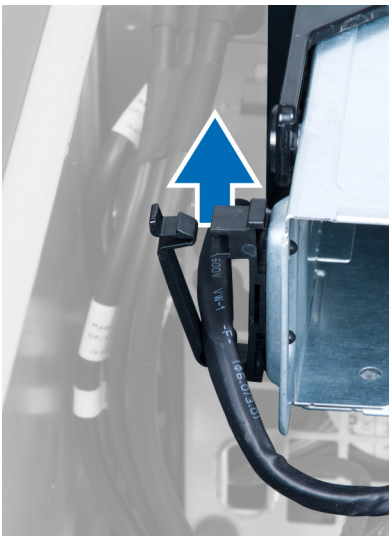

7. Lift the release latch on top of the optical-drive cage.

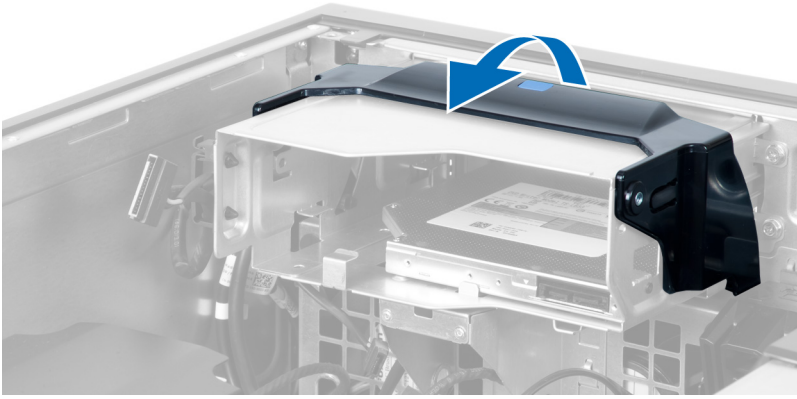

8. Holding the release latch, slide the optical-drive cage from the optical-drive compartment.

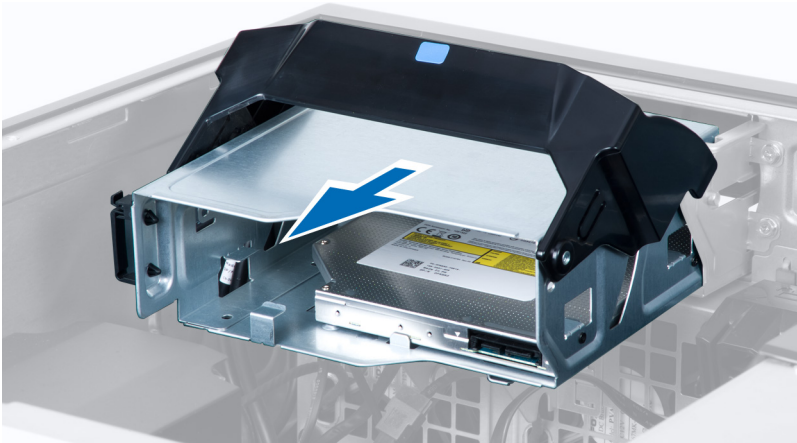

9. Remove the screws that secure the optical drive to the optical-drive cage.

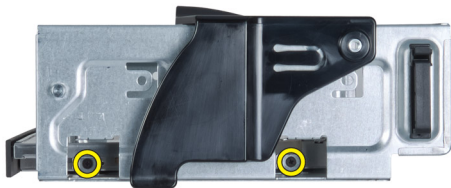

10. Remove the screws that secure the optical drive to the optical-drive cage.



11. Remove the optical drive from the optical-drive cage.

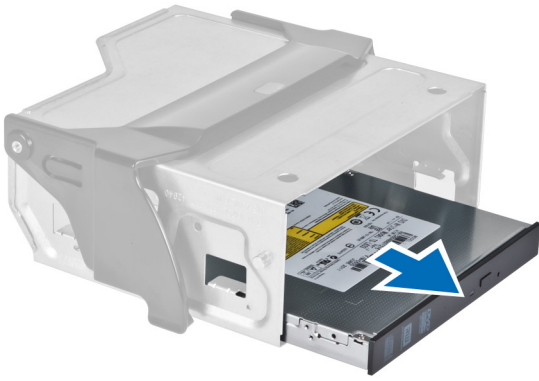

Installing the Slim Line Optical Drive

1. Lift the release latch, and slide the optical-drive cage inside the compartment.
2. Press on the clasp to release the latch and thread the cables into the holder.
3. Connect the power cable to the back of the optical drive.
4. Connect the data cable to the back of the optical drive.
5. Install the [computer cover](#).
6. Follow the procedures in [After Working Inside Your Computer](#).

Removing the Hard Drive

1. Follow the procedures in [Before Working Inside Your Computer](#).
2. Remove the [computer cover](#).
3. Disconnect the power supply and data cables from the hard drive.



4. Press in on the latches on both sides of the hard-drive bracket.

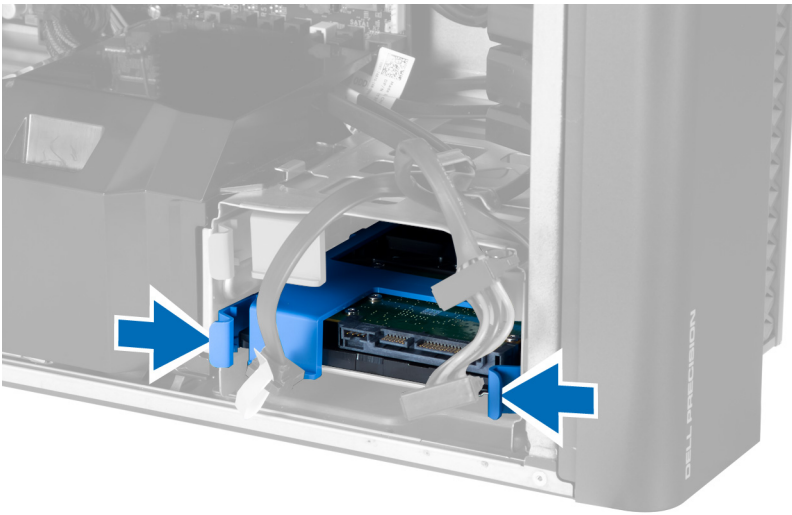

5. Slide the hard drive out of the compartment.

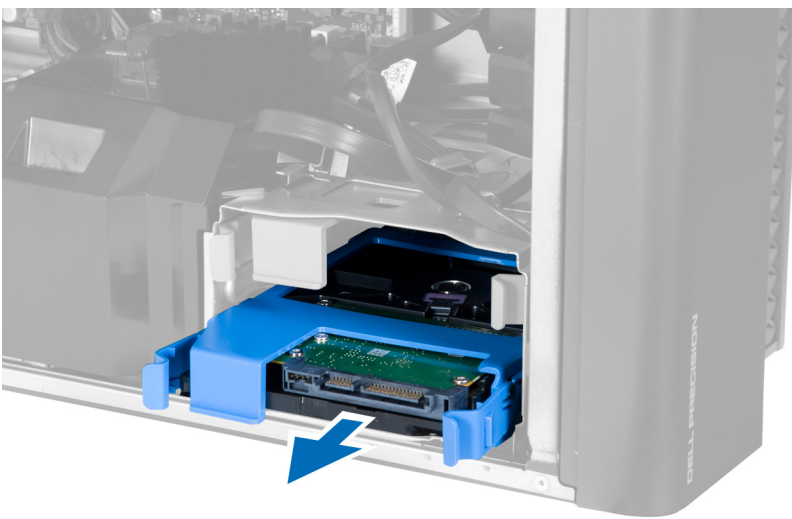

6. If a 2.5-inch hard drive is installed, flex the hard-drive bracket on both sides to loosen the hard drive and lift it to remove it from the hard-drive bracket [1, 2].

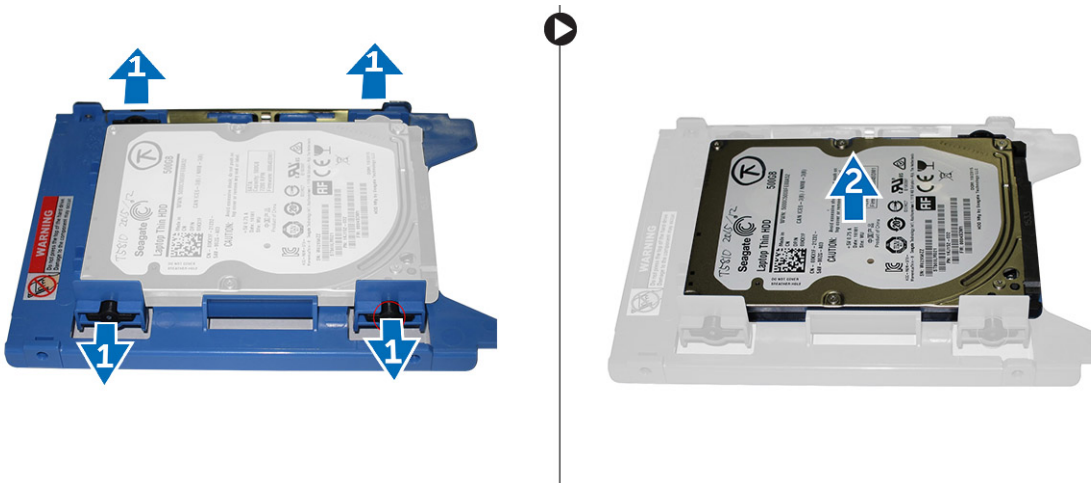

7. If a 3.5-inch hard drive is installed, flex the hard-drive bracket on both sides to loosen the hard drive.

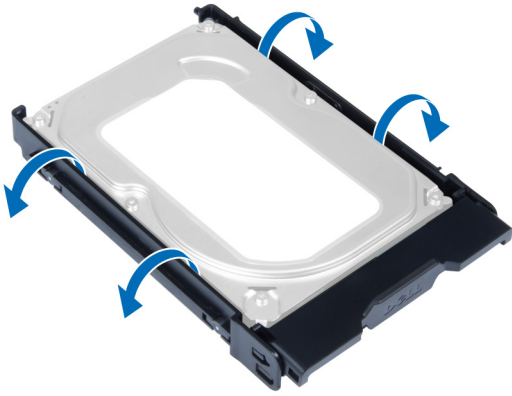

8. Lift the hard drive in an upward direction to remove it from the hard-drive bracket.

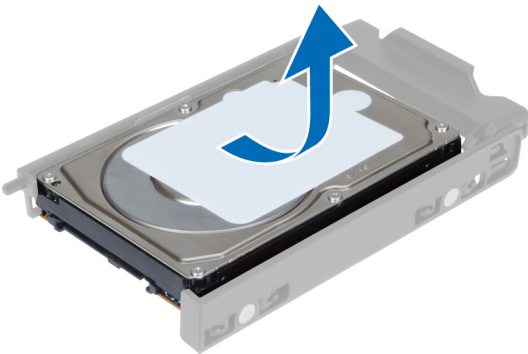

Installing the Hard Drive

1. If a 3.5-inch hard drive is installed on the computer, place the hard drive and press in on the latches of the hard-drive caddy.
2. If a 2.5-inch hard drive is installed on the computer, place the hard drive on the hard-drive caddy and tighten the screws to secure the hard drive.
3. Secure the hard-drive in the hard-drive cage and slide it inside the compartment.
4. Connect the hard-drive power supply cable and data cable.
5. Install the [computer cover](#).
6. Follow the procedures in [After Working Inside Your Computer](#).

Removing the Speaker

1. Follow the procedures in [Before Working Inside Your Computer](#).
2. Remove the [computer cover](#).
3. Perform the following steps as shown in the illustration:
 - a) Disconnect the speaker cable from the system board [1].
 - b) Press down the clasp, lift and remove the speaker [2,3].

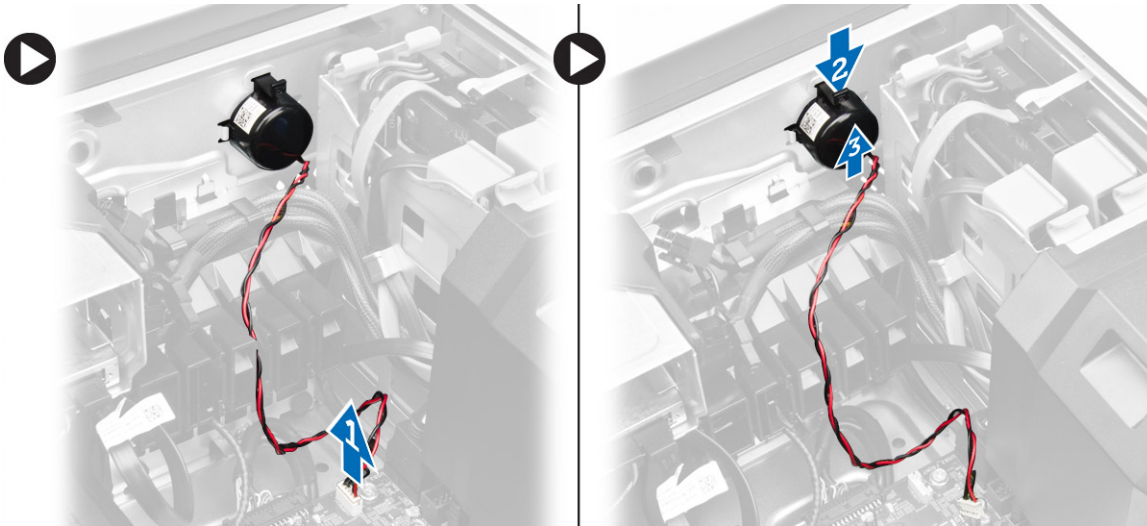

Installing the Speaker

1. Replace the speaker and fix the clasp.
2. Connect the speaker cable to the system board.
3. Install the [computer cover](#).
4. Follow the procedures in [After Working Inside Your Computer](#).

Removing the HDD Thermal Sensor

i **NOTE:** The HDD thermal sensor is an optional component and your computer may not ship with it.

1. Follow the procedures in [Before Working Inside Your Computer](#).
2. Remove the [computer cover](#).
3. Identify the HDD thermal sensor connected to the system board.

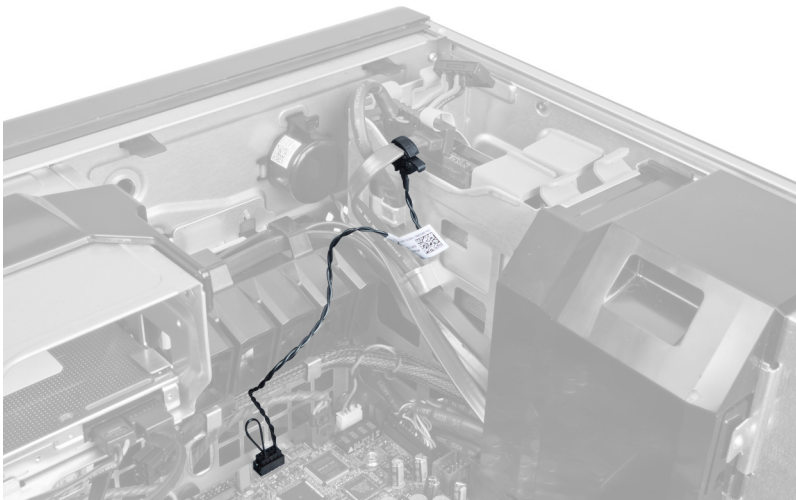

4. Disconnect the HDD thermal sensor cable from the system board.

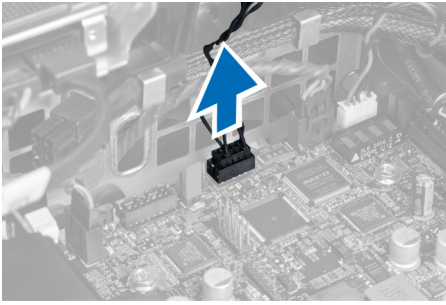

5. Release the latch that secures the HDD thermal sensor. Here, the HDD thermal sensor is attached to the hard drive.



Installing the HDD Thermal Sensor

i **NOTE:** The HDD thermal sensor is an optional component and your computer may not ship with it.

1. Connect the HDD thermal sensor to the SAS HDD component that you wish to monitor the temperature, and secure it with the latch.
2. Attach the HDD thermal sensor cable to the system board.
3. Install the [computer cover](#).
4. Follow the procedures in [After Working Inside Your Computer](#).

Removing the Input-Output Panel

1. Follow the procedures in [Before Working Inside Your Computer](#).
2. Remove:
 - a) [computer cover](#)
 - b) [front bezel](#)
3. Remove the screws that secure the Input/Output (I/O) panel cage to the chassis.

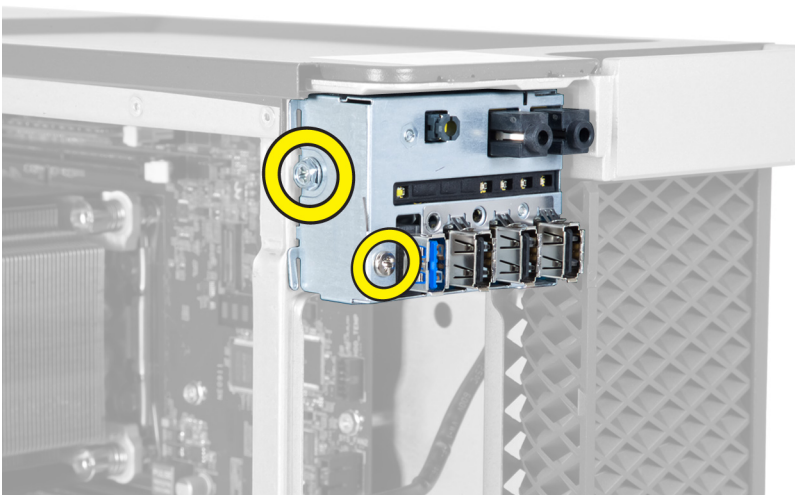

4. Remove the I/O panel cage from the chassis.

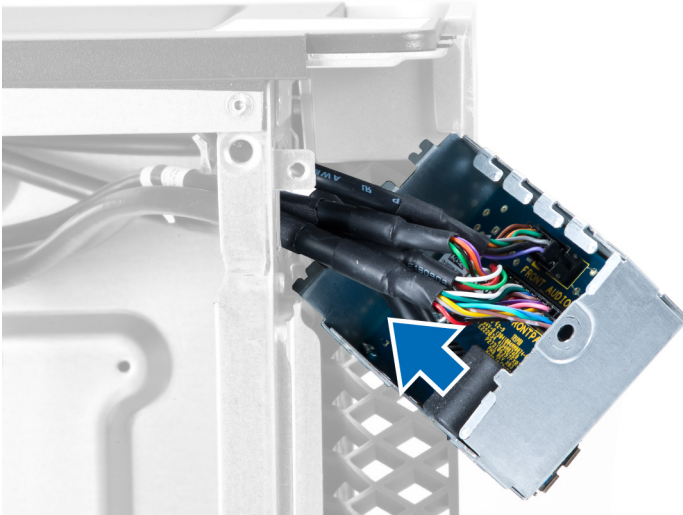

5. Disconnect the cables to release the I/O panel to remove it from the computer.

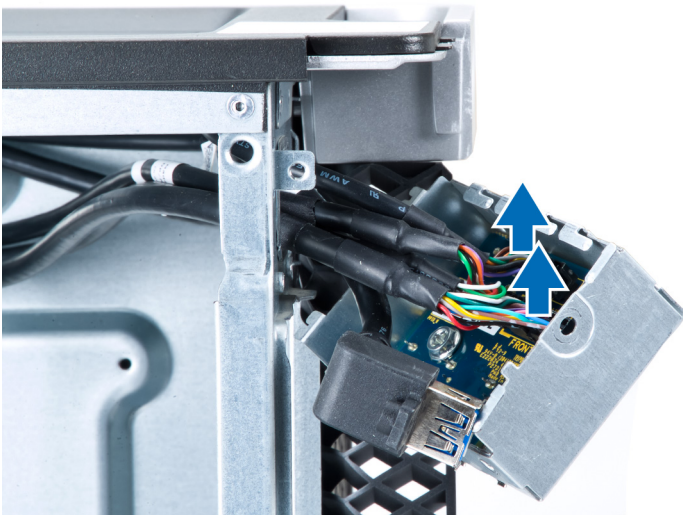

6. Remove the screws that secure the I/O panel to the I/O panel cage.

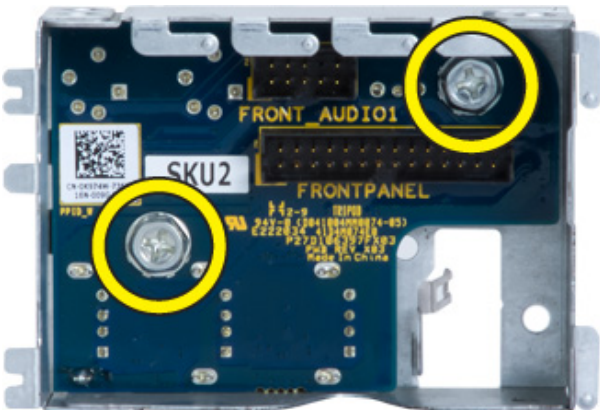

7. Remove the I/O panel from the I/O panel cage.



Installing the Input-Output Panel

1. Replace the Input/Output (I/O) panel in the I/O panel cage.
2. Tighten the screws to secure the I/O panel to the I/O panel cage.
3. Connect the cables to the I/O panel.
4. Place the USB 3.0 module in its slot.
5. Tighten the screws that secure the USB 3.0 module to the I/O panel cage.
6. Replace the I/O panel cage into its slot.
7. Tighten the screws that secure I/O panel cage to the chassis.
8. Install:
 - a) [front bezel](#)
 - b) [computer cover](#)
9. Follow the procedures in [After Working Inside Your Computer](#).

Removing the Memory Shroud

1. Follow the procedures in [Before Working Inside Your Computer](#).
2. Remove:
 - a) [computer cover](#)
 - b) [optical drive](#)
3. Press down on the blue retaining tab.

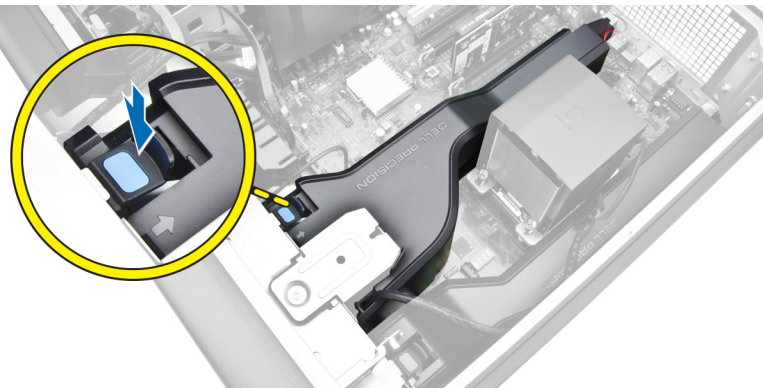

4. Lift the memory shroud module upwards to remove it from the computer.



5. Repeat **Step 3** and **Step 4** to remove the second memory shroud module from the computer.

Installing the Memory Shroud

1. Install the memory shroud module and press downwards until it clicks into place.
2. Install:
 - a) [optical drive](#)
 - b) [computer cover](#)
3. Follow the procedures in [After Working Inside Your Computer](#).

Removing the Memory

1. Follow the procedures in [Before Working Inside Your Computer](#).
2. Remove:
 - a) [computer cover](#)
 - b) [optical drive](#)
 - c) [memory shroud](#)
3. Press down on the memory-securing clips on each side of the memory module, and lift the memory module upwards to remove it from the computer.

NOTE: Tilting of DIMM during removal can cause damage to the DIMM.

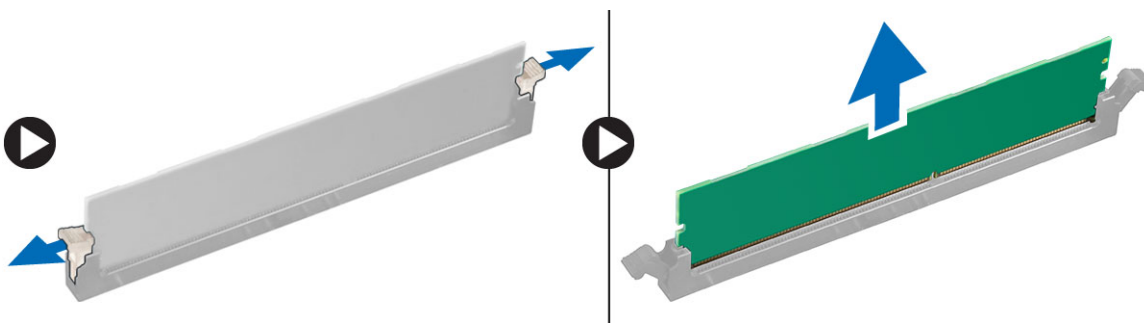

Installing the Memory

1. Insert the memory module into the memory socket.
 2. Press down on the memory module until the securing clips secure the memory in place.
- NOTE:** Tilting of DIMM during insertion can cause damage to the DIMM.
3. Install:
 - a) [memory shroud](#)
 - b) [optical drive](#)
 - c) [computer cover](#)

4. Follow the procedures in [After Working Inside Your Computer](#).

Removing the Coin-Cell Battery

1. Follow the procedures in [Before Working Inside Your Computer](#).
2. Remove:
 - a) [computer cover](#)
 - b) [optical drive](#)
 - c) [memory shroud](#)
3. Press the release latch away from the battery to allow the battery to pop-up from the socket. Lift the coin-cell battery out of the computer.

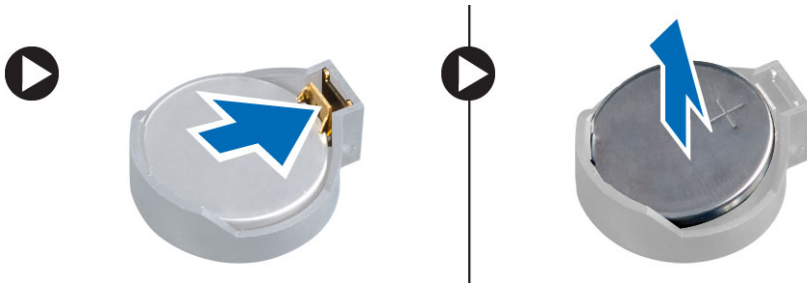

Installing the Coin-Cell Battery

1. Place the coin-cell battery into the slot on the system board.
2. Press the coin-cell battery downward until the release latch springs back into place and secures it.
3. Install:
 - a) [memory shroud](#)
 - b) [optical drive](#)
 - c) [computer cover](#)
4. Follow the procedures in [After Working Inside Your Computer](#).

Removing the PCI Card

1. Follow the procedures in [Before Working Inside Your Computer](#).
2. Remove the [computer cover](#).
3. Open the plastic latch fastening the PCI card in its slot.



4. Press down the latch and pull the PCI card away from the computer.

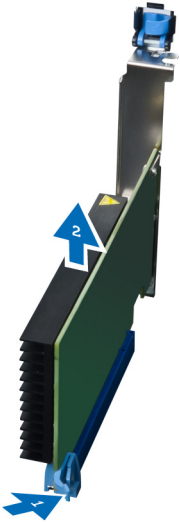

Installing the PCI Card

1. Push the expansion card into the card slot and secure the latch.
2. Install the plastic latch that secures the PCI card to the card slot.
3. Install the [computer cover](#).
4. Follow the procedures in [After Working Inside Your Computer](#).

Removing the PCIe-Card Retention

1. Follow the procedures in [Before Working Inside Your Computer](#).
2. Remove:
 - a) [computer cover](#)
 - b) [PCIe cards](#)
3. Perform the following steps as shown in the illustration:
 - a) Unthread the cable from the clips [1].
 - b) Press and slide the latch out to release the PCIe-card retention [2].
 - c) Remove the PCIe-card retention out of the computer [3].

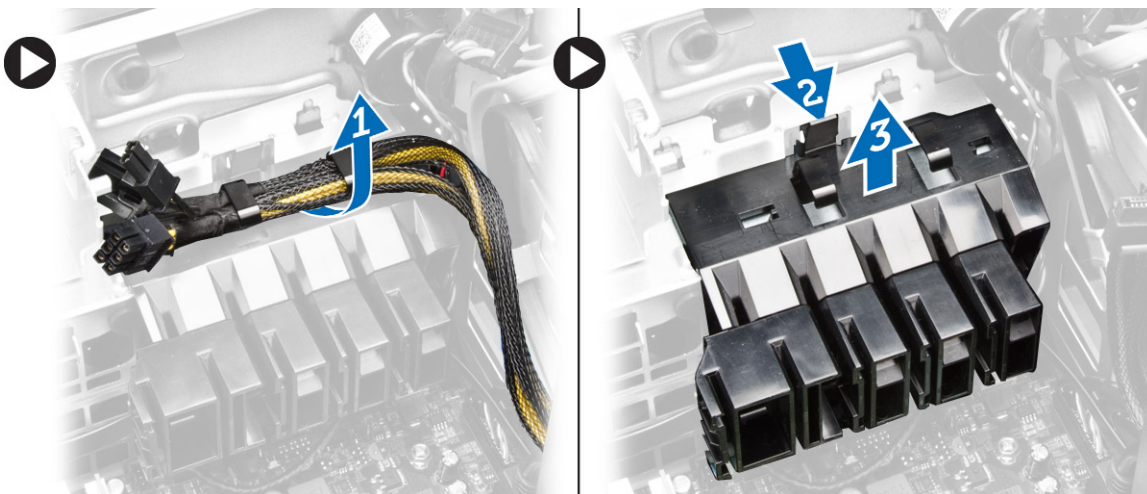

Installing the PCIe card retention

1. Place the PCIe card retention in its slot and insert the latches.

2. Route the cables through the clips to secure them.
3. Install:
 - a) [PCIe cards](#)
 - b) [computer cover](#)
4. Follow the procedures in [After Working Inside Your Computer](#).

Removing the System-Fan Assembly

1. Follow the procedures in [Before Working Inside Your Computer](#).
2. Remove:
 - a) [computer cover](#)
 - b) [optical drive](#)
 - c) [PCIe-card retention](#)
 - d) [memory shroud](#)
3. Unthread the system-board cable from the clips.

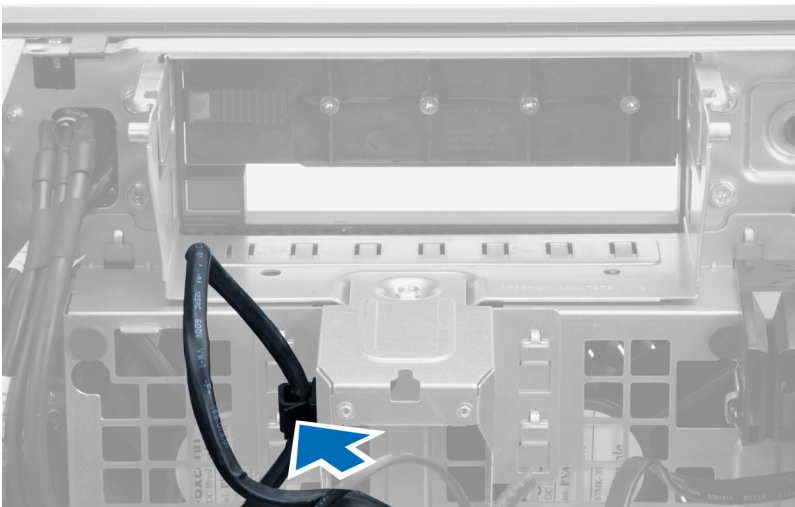

4. Remove the screw that secures metal plate to the system fan.

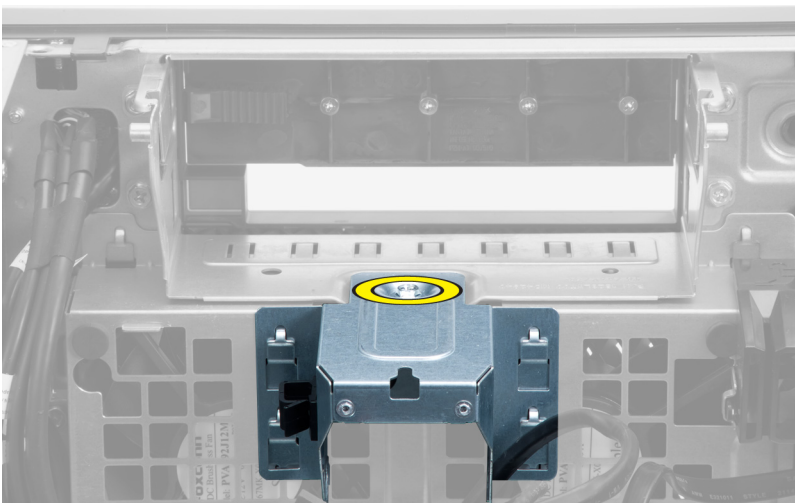

5. Press the latches on either side of the metal plate to release it.

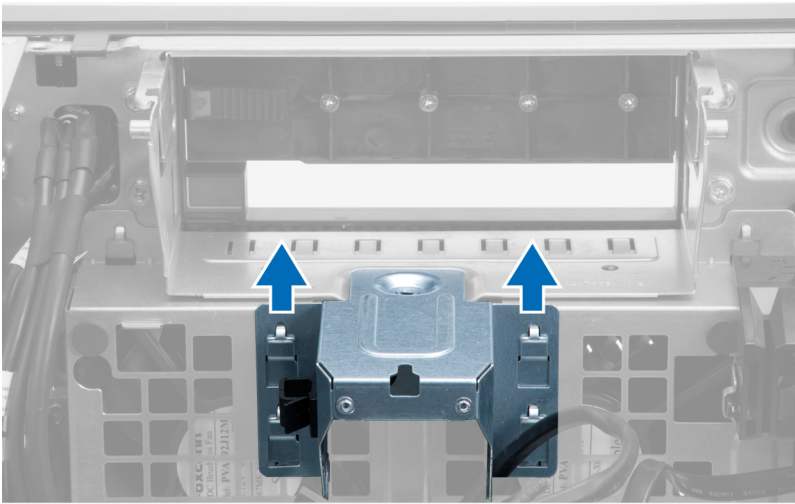

6. Lift the metal plate out of the chassis.

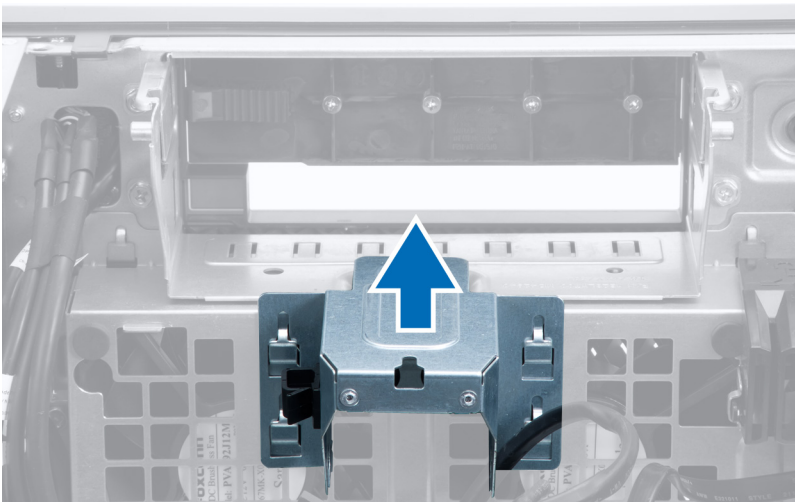

7. Remove the screws that secure the drive bay.

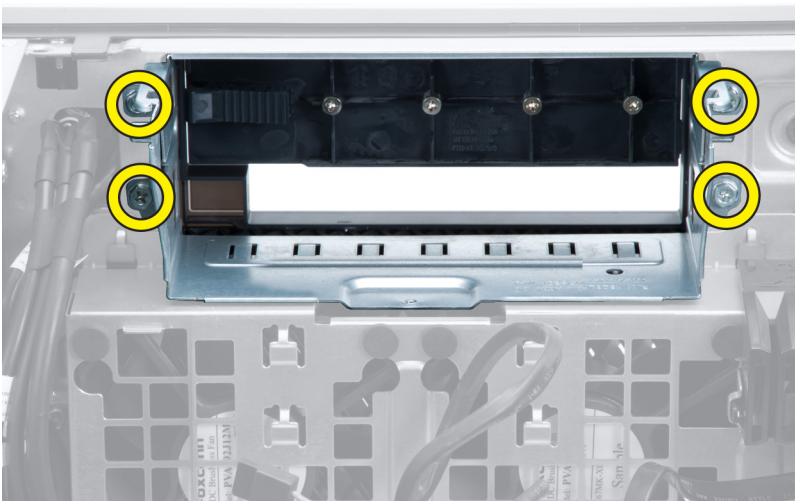

8. Disconnect the system-fan cables from the system board.

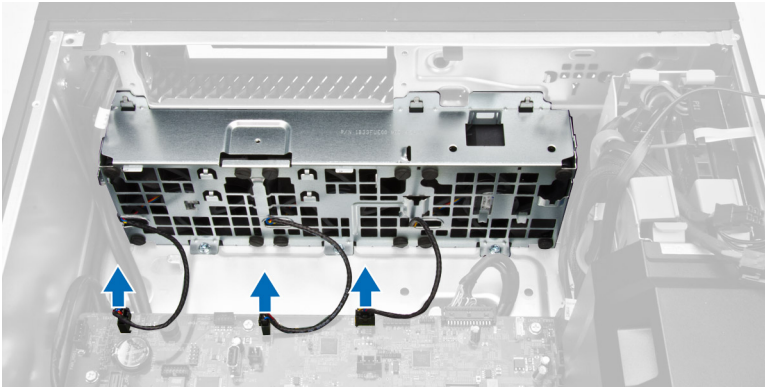

9. Perform the following steps as shown in the illustration:
- Remove the screws that secure system-fan assembly to the chassis [1].
 - Lift the system-fan assembly from the chassis [2].

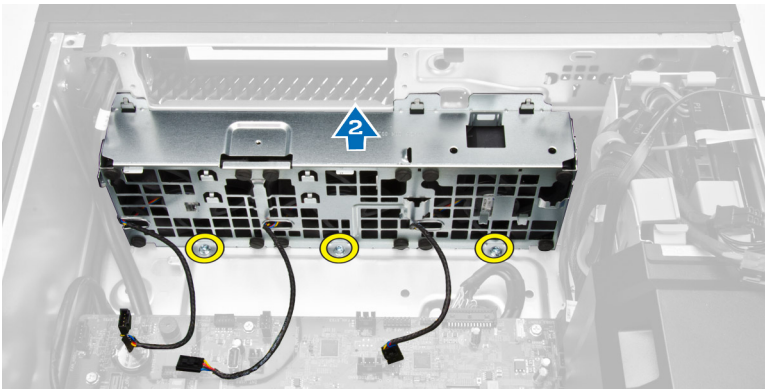

10. Pry away the grommets to remove the system fans from the system-fan assembly.

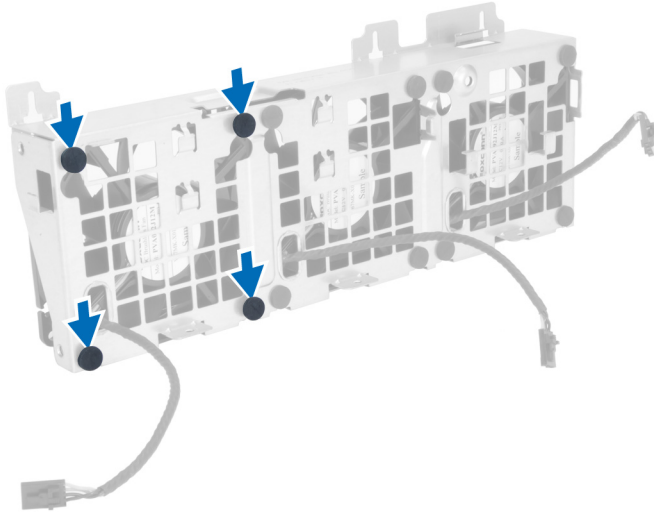

CAUTION: Using excessive force may damage the grommets.

11. Remove the system fans from the system-fan assembly.

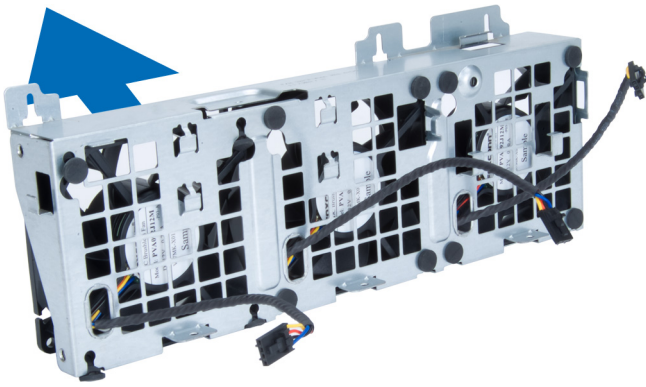

Installing the System-Fan Assembly

1. Place the fans in the fan assembly and attach the grommets.
2. Place the fan assembly in the chassis.
3. Tighten the screws to secure the fan assembly to the chassis.
4. Connect the system-fan cables to their connectors on the system board.
5. Route the system-fan cables out of the opening in the system-fan module in the direction of the system board.
6. Tighten the screws that secure the drive bay.
7. Replace the metal plate and install the screw that secures metal plate to the system fan.
8. Route and connect the system-board cable to its connector.
9. Install:
 - a) [PCIe-card retention](#)
 - b) [memory shroud](#)
 - c) [optical drive](#)
 - d) [computer cover](#)
10. Follow the procedures in [After Working Inside Your Computer](#).

Removing the Heatsink Assembly

1. Follow the procedures in [Before Working Inside Your Computer](#).
2. Remove the [computer cover](#).
3. Perform the following steps:
 - a) Disconnect the heatsink fan cable from the system board [1].
 - b) Loosen the captive screws that secure the heatsink assembly [2].
 - c) Lift the heatsink assembly and remove it from the computer [3].

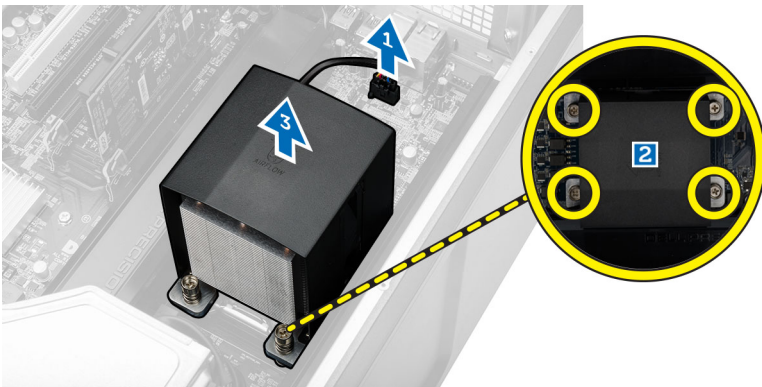

Installing the Heatsink Assembly

1. Place the heatsink assembly inside the computer.

2. Tighten the captive screws to secure the heatsink assembly to the system board.

i | **NOTE: Mis-alignment of screws can damage the system.**

3. Connect the heatsink cable to the system board.
4. Install the [computer cover](#).
5. Follow the procedures in [After Working Inside Your Computer](#).

Removing the Heatsink Fan

1. Follow the procedures in [Before Working Inside Your Computer](#).
2. Remove:
 - a) [computer cover](#)
 - b) [heatsink assembly](#)
3. Perform the following steps:
 - a) Remove the screws that secure the heatsink fan from the assembly.
 - b) Push the grommets outward to release the heatsink fan from the assembly.
 - c) Remove the heatsink fan from the heatsink assembly.

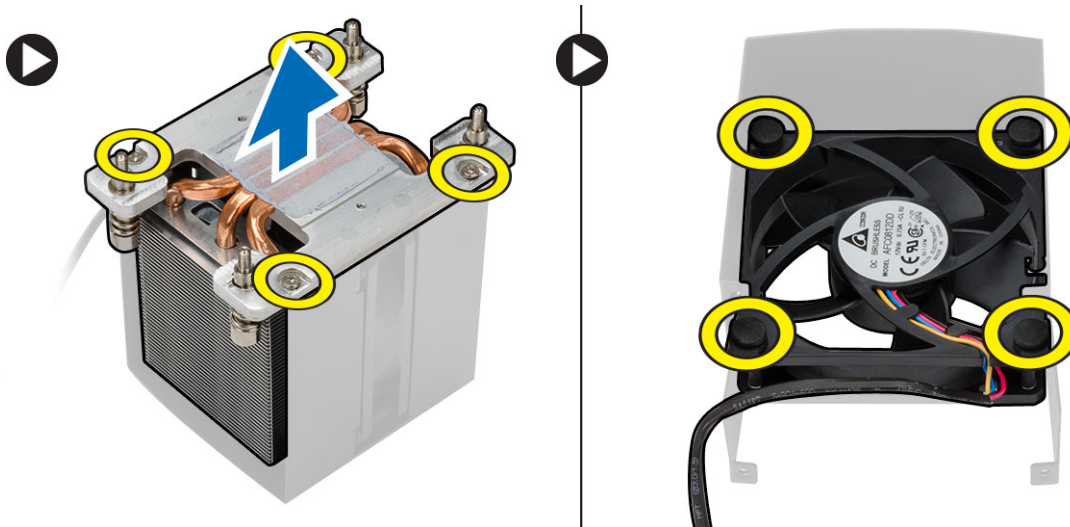

Installing the Heatsink Fan

1. Slide the heatsink fan into heatsink assembly.
2. Install the screws that secure the heatsink fan to the heatsink assembly.
3. Plug in the grommets to secure the heatsink fan to the heatsink assembly.
4. Install:
 - a) [heatsink assembly](#)
 - b) [computer cover](#)
5. Follow the procedures in [After Working Inside Your Computer](#).

Removing the Processor

1. Follow the procedures in [Before Working Inside Your Computer](#).
2. Remove:
 - a) [computer cover](#)
 - b) [heatsink assembly](#)
3. To remove the processor:

i | **NOTE: The processor cover is secured by two levers. They have icons that indicate which lever needs to be opened first and which lever closes first.**

- Press down on the first lever that holds the processor cover in place and release it sideways from its retention hook [1].
- Repeat step 'a' to release the second lever from its retention hook [2].
- Lift the lever from its retention hook [3].
- Press down on the first lever [4].
- Lift and remove the processor cover [5].
- Lift the processor to remove it from the socket and place it in antistatic package [6].

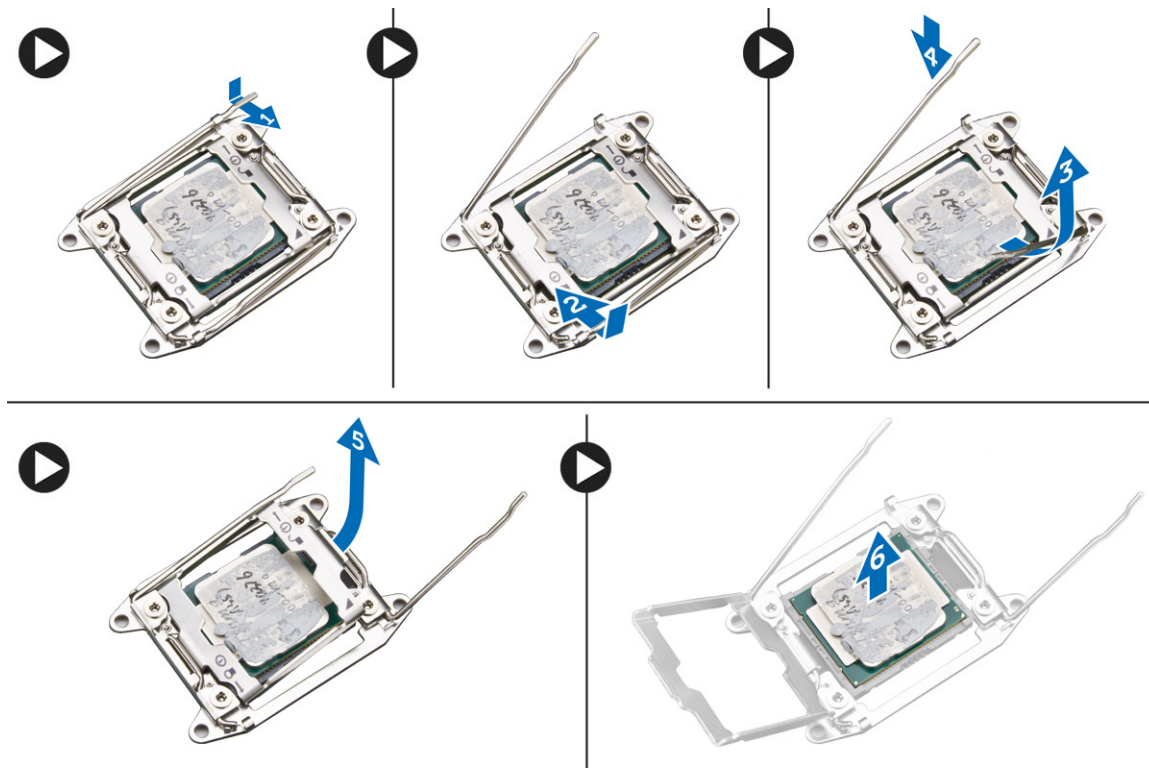

NOTE: Damaging pins during removal of the processor can cause damage to the processor.

- Repeat the above steps to remove the second processor (if available) from the computer.
To verify if your computer has dual processor slots, see the [System Board components](#).

Installing the Processor

- Place the processor in its socket.
- Replace the processor cover.

NOTE: The processor cover is secured by two levers. They have icons that indicate which lever needs to be opened first and which lever closes first.
- Slide the first lever sideways into the retention hook to secure the processor.
- Repeat step '3' to slide the second lever into the retention hook.
- Install:
 - heatsink assembly
 - computer cover
- Follow the procedures in [After Working Inside Your Computer](#).

System Board Components

The following image displays the system board components .

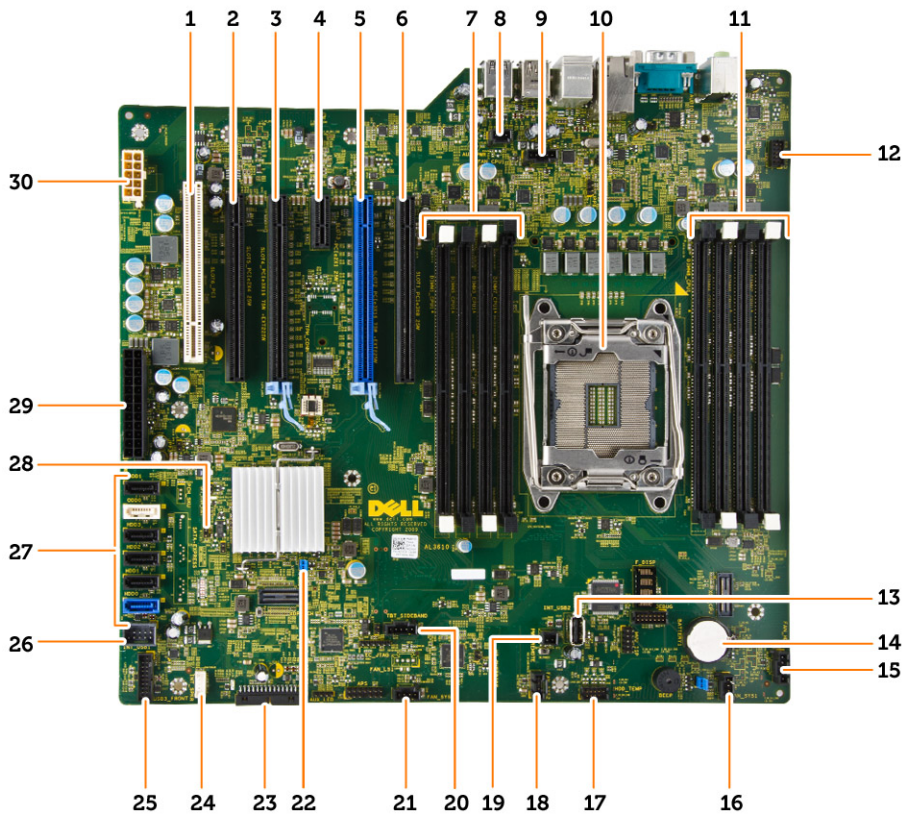

1. PCI slot (slot 6)
2. PCIe x16 slot (PCIe 2.0 wired as x4) (slot 5)
3. PCIe 3.0 x16 slot (slot 4)
4. PCIe 2.0 x1 slot (slot 3)
5. PCIe 3.0 x16 slot (slot 2)
6. PCIe x16 slot (PCIe 3.0 wired as x8) (slot 1)
7. DIMM slots
8. intrusion-switch connector
9. CPU heatsink fan connector
10. processor socket
11. DIMM slots
12. front-panel audio connector
13. internal USB 2.0 connector
14. coin-cell battery
15. optional hard-drive fan connector
16. system-fan connector
17. HDD temperature sensor connector
18. system-fan connector
19. PWR_REMOTE connector (for Teradici Host Card)
20. thunderbolt sideband connector
21. system-fan connector
22. password jumper
23. front panel and USB 2.0 connector
24. internal speaker connector
25. USB 3.0 front-panel connector
26. internal USB 2.0 connector for flexbay
27. SATA Connectors (HDD0-HDD3 & SATA0-1)
28. RTC_RST Jumper
29. 24-pin system power connector
30. CPU power connector

Removing the System Board

1. Follow the procedures in [Before Working Inside Your Computer](#).
2. Remove:
 - a) computer cover
 - b) optical drive
 - c) graphics card and other PCI adapters
 - d) heatsink assembly
 - e) memory shrouds
 - f) memory module(s)
 - g) processor
3. Disconnect all the cables from the system board.

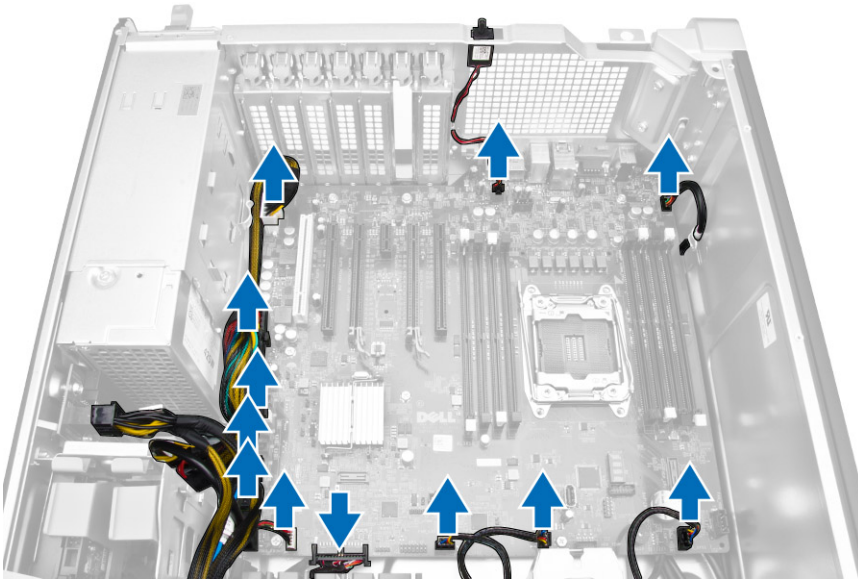

4. Remove the screws that secure the system board to the chassis.

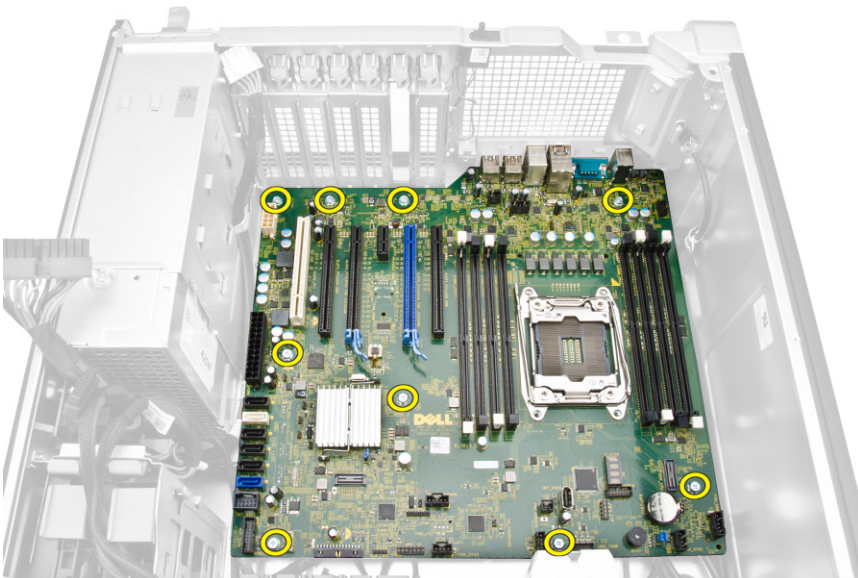

5. Perform the following steps:
 - a) Slide the system board towards front direction [1].
 - b) Tilt the system board [2].

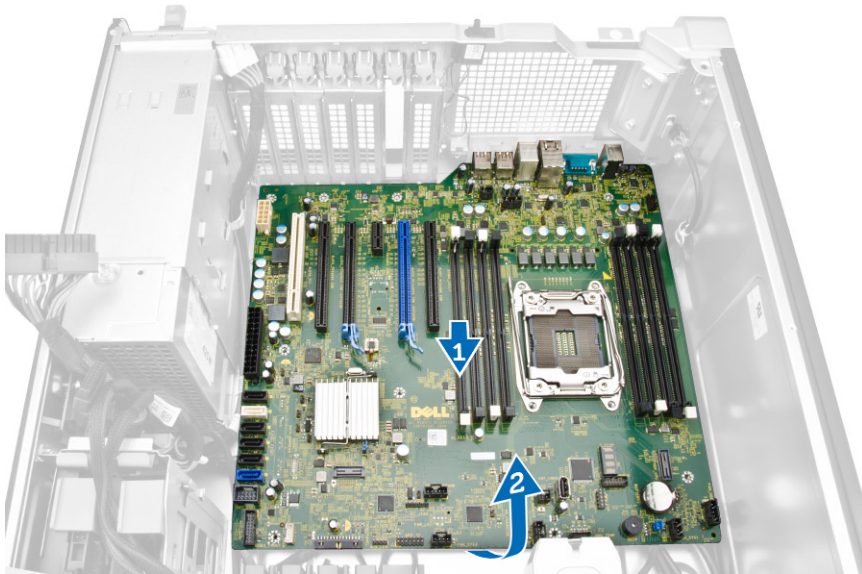

6. Lift the system board in an upward direction and remove it from the computer.

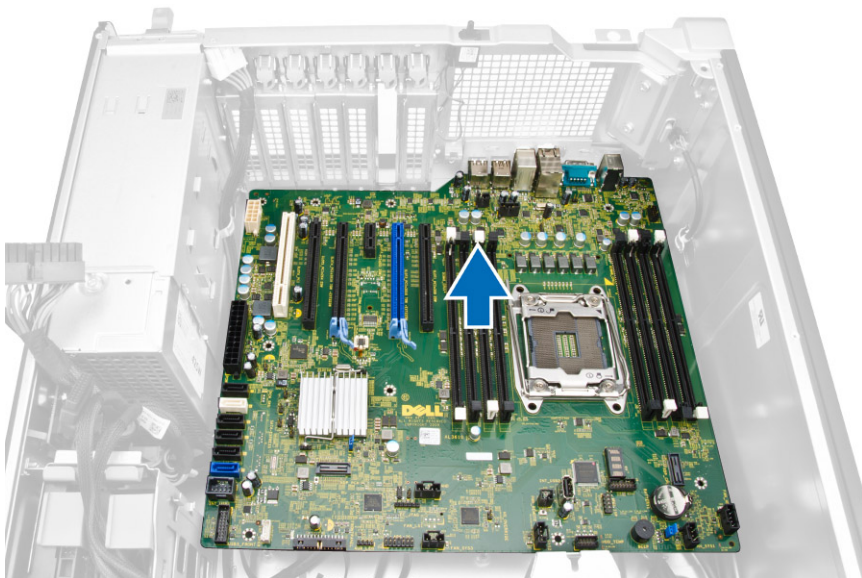

Installing the System Board

1. Align the system board to the port connectors on the back of the chassis and place the system board in the chassis.
2. Tighten the screws to secure the system board to the chassis.
3. Connect the cables to the system board.
4. Install:
 - a) processor
 - b) memory module (s)
 - c) memory shrouds
 - d) heatsink assembly
 - e) graphics card and other PCI adapters
 - f) optical drive
 - g) computer cover
5. Follow the procedures in [After Working Inside Your Computer](#).

Additional Information

Memory Module Guidelines

To ensure optimal performance of your computer, observe the following general guidelines when configuring your system memory:

- Memory modules of different sizes can be mixed (for example, 2 GB and 4 GB). But, all populated channels must have identical configurations.
- Memory modules must be installed beginning with the first socket.
- If memory modules with different speeds are installed, they operate at the speed of the slowest installed memory modules.

NOTE: If all DIMMs are 2133, the CPU ordered may run the memory at a slower speed.

Memory Configuration

Table 1. Memory configuration

Tower 5810		Chassis 0		Chassis 1		Chassis 2		Chassis 3		RDIMM
Configuration	Total (GB)	0	1	0	1	0	1	0	1	
S4	4	4								2133
S8	8	4		4						2133
S16	16	4		4		4		4		2133
S32	32	8		8		8		8		2133
S32B	32	4	4	4	4	4	4	4	4	1856(2133)
S64	64	8	8	8	8	8	8	8	8	1856(2133)
S128	128	16	16	16	16	16	16	16	16	1866(2133)
S256	256	32	32	32	32	32	32	32	32	1866(2133)

Table 2. Single CPU configuration

DIMM1	CPU1
DIMM2	CPU1
DIMM3	CPU1
DIMM4	CPU1

Table 3. Dual CPU configuration

DIMM1	CPU1
DIMM1	CPU2
DIMM2	CPU1
DIMM2	CPU2

Power Supply Unit - PSU Lock

The PSU lock prevents the removal of the PSU from the chassis.

NOTE: To lock or unlock the PSU, always ensure that the cover of the chassis is removed.

To secure the PSU, remove the screw from the unlock screw location and tighten the screw to the lock location. Similarly, to unlock the PSU, remove the screw from the lock screw location and tighten the screw to the unlock screw location.

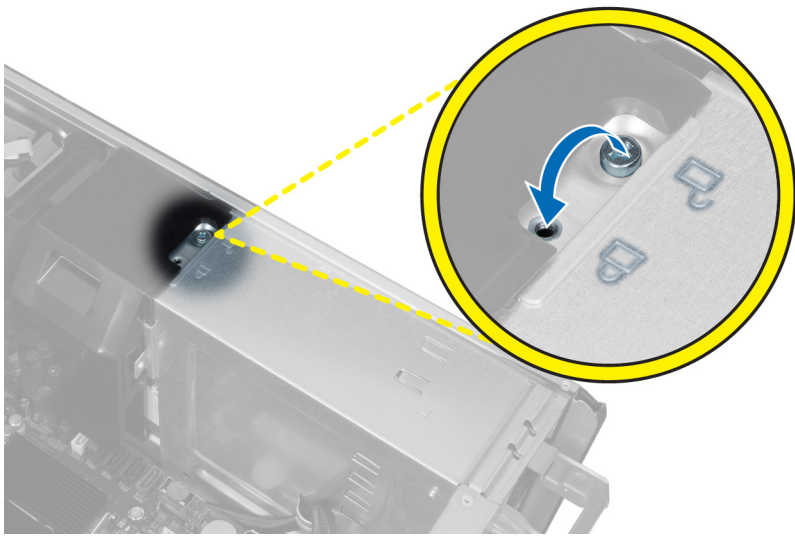

System setup

System setup enables you to manage your hardware and specify BIOS level options. From the System setup, you can:

- Change the NVRAM settings after you add or remove hardware
- View the system hardware configuration
- Enable or disable integrated devices
- Set performance and power management thresholds
- Manage your computer security

Topics:

- [Boot Sequence](#)
- [Navigation keys](#)
- [System Setup Options](#)
- [Updating the BIOS in Windows](#)
- [System and setup password](#)

Boot Sequence

Boot Sequence allows you to bypass the System Setup–defined boot device order and boot directly to a specific device (for example: optical drive or hard drive). During the Power-on Self Test (POST), when the Dell logo appears, you can:

- Access System Setup by pressing F2 key
- Bring up the one-time boot menu by pressing F12 key

The one-time boot menu displays the devices that you can boot from including the diagnostic option. The boot menu options are:

- Removable Drive (if available)
- STXXXX Drive

 **NOTE: XXX denotes the SATA drive number.**

- Optical Drive (if available)
- SATA Hard Drive (if available)
- Diagnostics

 **NOTE: Choosing Diagnostics, will display the ePSA diagnostics screen.**

The boot sequence screen also displays the option to access the System Setup screen.

Navigation keys

 **NOTE: For most of the System Setup options, changes that you make are recorded but do not take effect until you restart the system.**

Keys	Navigation
Up arrow	Moves to the previous field.
Down arrow	Moves to the next field.
Enter	Selects a value in the selected field (if applicable) or follow the link in the field.
Spacebar	Expands or collapses a drop-down list, if applicable.
Tab	Moves to the next focus area.

 **NOTE: For the standard graphics browser only.**

Keys

Esc

Navigation

Moves to the previous page until you view the main screen. Pressing Esc in the main screen displays a message that prompts you to save any unsaved changes and restarts the system.



System Setup Options

 **NOTE:** Depending on your computer and its installed devices, the items listed in this section may or may not appear.

Table 4. General

Option	Description
System Information	This section lists the primary hardware features of your computer. <ul style="list-style-type: none">• System Information• Memory Configuration• Processor Information• Device Information• PCI Information
Boot Sequence	Allows you to change the order in which the computer attempts to find an operating system. <ul style="list-style-type: none">• Diskette Drive• USB Storage Device• CD/DVD/CD-RW Drive• Onboard NIC• Internal HDD
Boot List Option	Allows you to change the boot list option. <ul style="list-style-type: none">• Legacy• UEFI
Advanced Boot Options	Allows you to Enable Legacy Option ROMs <ul style="list-style-type: none">• Enable Legacy Option ROMs (Default)
Date/Time	Allows you to set the date and time. The changes to the system date and time takes effect immediately.

Table 5. System Configuration

Option	Description
Integrated NIC	Allows you to configure the integrated network controller. The options are: <ul style="list-style-type: none">• Enable UEFI Network Stack• Disabled<ul style="list-style-type: none"> NOTE: You can use the Disabled option, only if Active Management Technology (AMT) option is disabled.• Enabled• Enabled w/PXE (Default)
Integrated NIC 2	Allows you to configure the integrated network controller. The options are: <ul style="list-style-type: none">• Enabled (Default)• Enabled w/PXE <p> NOTE: This feature is supported only on Tower 7910.</p>
Serial Port	Identifies and defines the serial port settings. You can set the serial port to: <ul style="list-style-type: none">• Disabled• COM1 (Default)• COM2• COM3

Option	Description
	<ul style="list-style-type: none"> COM4 <p>NOTE: The operating system may allocate resources even if the setting is disabled.</p>
SATA Operation	
Tower 5810 and Tower 7810	<p>Allows you to configure the internal SATA hard-drive controller. The options are:</p> <ul style="list-style-type: none"> Disabled ATA AHCI RAID On (Default) <p>NOTE: SATA is configured to support RAID mode. No SATA operation support in Tower 7910.</p>
Tower 7910	<p>Allows you to configure the internal SATA hard-drive controller. The options are:</p> <ul style="list-style-type: none"> Disabled ATA AHCI (Default) <p>NOTE: SATA is configured to support RAID mode. No SATA operation support in Tower 7910.</p>
Drives	
Tower 5810 and Tower 7810	<p>Allows you to configure the SATA drives on board. The options are:</p> <ul style="list-style-type: none"> HDD-0 HDD-1 HDD-2 HDD-3 ODD-0 ODD-1 <p>Default Setting: All drives are enabled.</p> <p>NOTE: If the hard drives are connected to a RAID controller card, the hard drives will display {none} in all the fields. The hard drives can be seen in the RAID controller card BIOS.</p>
Tower 7910	<ul style="list-style-type: none"> SATA-0 SATA-1 <p>Default Setting: All drives are enabled.</p> <p>NOTE: If the hard drives are connected to a RAID controller card, the hard drives will display {none} in all the fields. The hard drives can be seen in the RAID controller card BIOS.</p>
SMART Reporting	<p>This field controls if the hard drive errors for the integrated drives are reported during system startup. This technology is part of the SMART (Self Monitoring Analysis and Reporting Technology) specification.</p> <ul style="list-style-type: none"> Enable SMART Reporting - This option is disabled by default.
USB Configuration	<p>Allows you to enable or disable the internal USB configuration. The options are:</p> <ul style="list-style-type: none"> Enable Boot Support Enable Front USB Ports Enable internal USB ports Enable rear USB Ports
SAS RAID Controller (Tower 7910 only)	<p>Allows you to control the operation of the integrated SAS RAID HDD controller.</p> <ul style="list-style-type: none"> Enabled (Default) Disabled.

Option	Description
HDD Fans	Allows you to control the HDD fans. Default Setting: depends on the system configuration
Audio	Allows you enable or disable the audio feature. <ul style="list-style-type: none"> • Enable Audio (Default)
Memory Map IO above 4GB	Allows you enable or disable Memory Map IO above 4GB. <ul style="list-style-type: none"> • Memory Map IO above 4GB - This option is disabled by default.
Thunderbolt	Allows you to enable or disable Thunderbolt device support capability. <ul style="list-style-type: none"> • Enabled • Disabled (Default)
Miscellaneous devices	Allows you to enable or disable various on board devices. <ul style="list-style-type: none"> • Enable PCI Slot
PCI MMIO Space Size	This table gives you POST diagnostic LED pattern information.

Table 6. Video

Option	Description
Primary Video Slot	Allows you to configure primary boot video device. The options are: <ul style="list-style-type: none"> • Auto (Default) • SLOT 1 • SLOT 2: VGA Compatible • SLOT 3 • SLOT 4 • SLOT 5 • SLOT 6 (Tower 5810 and Tower 7810 only) • SLOT1_CPU2: VGA Compatible (Tower 7910 only) • SLOT2_CPU2 (Tower 7910 only)

Table 7. Security

Option	Description
Strong Password	Allows you to enforce the option to always set strong passwords. Default Setting: Enable Strong Password is not selected.
Password Configuration	You can define the length of your password. Min = 4 , Max = 32
Password Bypass	Allows you to enable or disable the permission to bypass the System password, when it is set. The options are: <ul style="list-style-type: none"> • Disabled (Default) • Reboot bypass
Password Change	Allows you to enable the disable permission to the System passwords when the administrator password is set. Default Setting: Allow Non-Admin Password Changes is selected
TPM Security	Allows you to enable the Trusted Platform Module (TPM) during POST. Default Setting: The option is disabled.
Computrace (R)	Allows you to activate or disable the optional Computrace software. The options are: <ul style="list-style-type: none"> • Deactivate (Default) • Disable • Activate

Option	Description
CPU XD Support	Allows you to enable the Execute Disable mode of the processor. <ul style="list-style-type: none"> • Enable CPU XD Support (Default)
OROM Keyboard Access	Allows you to determine whether users are able to enter Option ROM Configuration screens via hotkeys during boot. The options are: <ul style="list-style-type: none"> • Enable (Default) • One Time Enable • Disable
Admin Setup Lockout	Allows you to prevent users from entering Setup when an administrator password is set. <ul style="list-style-type: none"> • Enable Admin Setup Lockout Default Setting: The option is disabled.

Table 8. Secure Boot

Option	Description
Secure Boot Enable	Allows you to enable or disable the Secure Boot Feature. The options are: <ul style="list-style-type: none"> • Disabled (Default) • Enabled
Expert Key Management	Allows you to enable or disable Custom Mode Key Management. <ul style="list-style-type: none"> • Disabled (Default)

Table 9. Performance

Option	Description
Multi Core Support	This field specifies whether the processor will have one or all cores enabled. The performance of some applications will improve with the additional cores. This option is enabled by default. Allows you to enable or disable multi-core support for the processor. The options are: <ul style="list-style-type: none"> • All (Default) • 1 • 2 • 4 • 5 • 6 • 7 • 8 • 9 <div style="border-left: 1px solid black; padding-left: 10px; margin-top: 10px;"> <p>NOTE:</p> <ul style="list-style-type: none"> • The options displayed could be different depending on the installed processor(s). • The options depend on the number of cores supported by the installed processor (All, 1, 2, N-1 for N-Core Processors) </div>
Intel SpeedStep	Allows you to enable or disable the Intel SpeedStep feature. Default Setting: Enable Intel SpeedStep
C States	Allows you to enable or disable the additional processor sleep states. Default Setting: Enabled
Limit CPUID Value	This field limits the maximum value the processor Standard CPUID Function will support. <ul style="list-style-type: none"> • Enable CPUID Limit Default Setting: The option is disabled.
Intel TurboBoost	Allows you to enable or disable the Intel TurboBoost mode of the processor.

Option	Description
	Default Setting: Enable Intel TurboBoost
Hyper-Thread Control	Allows you to enable or disable the HyperThreading in the processor. Default Setting: Enabled
Cache Prefetch	Default Setting: Enable Hardware Prefetch and Adjacent Cache Line Prefetch
Dell Reliable Memory Technology (RMT)	Allows you to identify and isolate memory errors in system RAM.. Default Setting: Enable Dell Reliable Memory Technology (RMT)

Table 10. Power Management

Option	Description
AC Recovery	Specifies how the computer will respond when AC power is applied after a AC power loss. You can set the AC Recovery to: <ul style="list-style-type: none"> • Power Off (Default) • Power On • Last Power State
Auto On Time	Allows you to set the time at which the computer must turn on automatically. The options are: <ul style="list-style-type: none"> • Disabled (Default) • Every Day • Weekdays • Select Days
Deep Sleep Control	Allows you to define the controls when Deep Sleep is enabled. <ul style="list-style-type: none"> • Disabled (Default) • Enabled in S5 only • Enabled in S4 and S5
Fan Speed Control	Allows you to control the speed of the system fan. The options are: <ul style="list-style-type: none"> • Auto (Default) • Medium low • Medium high • Medium • High • Low
USB Wake Support	Allows you to enable USB devices to wake the system from standby. <ul style="list-style-type: none"> • Enable USB Wake Support Default Setting: The option is disabled.
Wake on LAN	This option allows the computer to power up from the off state when triggered by a special LAN signal. Wake-up from the Standby state is unaffected by this setting and must be enabled in the operating system. This feature only works when the computer is connected to AC power supply. <ul style="list-style-type: none"> • Disabled - Does not allow the system to power on by special LAN signals when it receives a wake-up signal from the LAN or wireless LAN. • LAN Only - Allows the system to be powered on by special LAN signals. • LAN with PXE Boot - Allows the system to power on and immediately boot to PXE when it receives a wake-up packet sent to the system in either the S4 or S5 state. This option is Disabled by default.
Block Sleep	Allows you to block entering to sleep (S3 state) in OS Environment. Default Setting: Disabled

Table 11. POST Behavior

Option	Description
Numlock LED	Specifies if the NumLock function can be enabled when the system boots. This option is enabled by default.
Keyboard Errors	Specifies whether keyboard related errors are reported when it boots. This option is enabled by default.
Fastboot	Allows you to speed up the boot process by bypassing some compatibility steps. The options are: <ul style="list-style-type: none">MinimalThorough - This option is enabled by default.Auto

Table 12. Virtualization Support

Option	Description
Virtualization	This option specifies whether a Virtual Machine Monitor (VMM) can utilize the additional hardware capabilities provided by Intel Virtualization technology. <ul style="list-style-type: none">Enable Intel Virtualization Technology - This option is enabled by default.
VT for Direct I/O	Enables or disables the Virtual Machine Monitor (VMM) from utilizing the additional hardware capabilities provided by Intel Virtualization technology for direct I/O. <ul style="list-style-type: none">Enable VT for Direct I/O - This option is enabled by default.
Trusted Execution	Allows you to specify whether a Measured Virtual Machine Monitor (MVMM) can utilize the additional hardware capabilities provided by Intel Trusted Execution Program. <ul style="list-style-type: none">Trusted Execution - This option is disabled by default.

Table 13. Maintenance

Option	Description
Service Tag	Displays the service tag of your computer.
Asset Tag	Allows you to create a system asset tag if an asset tag is not already set. This option is not set by default.
SERR Messages	Controls the SERR message mechanism. This option is not set by default. Some graphics cards require that the SERR message mechanism be disabled.

Table 14. System Logs

Option	Description
BIOS events	Displays the system event log and allows you to clear the log. <ul style="list-style-type: none">Clear Log

Table 15. Engineering Configurations

Option	Description
ASPM	<ul style="list-style-type: none">Auto (Default)L1 OnlyDisabledL0s and L1L0s Only
Pcie LinkSpeed	<ul style="list-style-type: none">Auto (Default)Gen1Gen2Gen3

Updating the BIOS in Windows

It is recommended to update your BIOS (System Setup), when you replace the system board or if an update is available. For laptops, ensure that your computer battery is fully charged and connected to a power outlet

 **NOTE: If BitLocker is enabled, it must be suspended prior to updating the system BIOS, and then re-enabled after the BIOS update is completed.**

1. Restart the computer.
2. Go to **Dell.com/support**.
 - Enter the **Service Tag** or **Express Service Code** and click **Submit**.
 - Click **Detect Product** and follow the instructions on screen.
3. If you are unable to detect or find the Service Tag, click **Choose from all products**.
4. Choose the **Products** category from the list.

 **NOTE: Choose the appropriate category to reach the product page**

5. Select your computer model and the **Product Support** page of your computer appears.
6. Click **Get drivers** and click **Drivers and Downloads**.
The Drivers and Downloads section opens.
7. Click **Find it myself**.
8. Click **BIOS** to view the BIOS versions.
9. Identify the latest BIOS file and click **Download**.
10. Select your preferred download method in the **Please select your download method below** window, click **Download File**.
The **File Download** window appears.
11. Click **Save** to save the file on your computer.
12. Click **Run** to install the updated BIOS settings on your computer.
Follow the instructions on the screen.

 **NOTE: It is recommended not to update the BIOS version for more than three revisions. For example: If you want to update the BIOS from 1.0 to 7.0, then install version 4.0 first and then install version 7.0.**

System and setup password

You can create a system password and a setup password to secure your computer.

Password type Description

System password Password that you must enter to log on to your system.

Setup password Password that you must enter to access and make changes to the BIOS settings of your computer.

 **CAUTION: The password features provide a basic level of security for the data on your computer.**

 **CAUTION: Anyone can access the data stored on your computer if it is not locked and left unattended.**

 **NOTE: System and setup password feature is disabled.**

Assigning a system password and setup password

You can assign a new **System Password** only when the status is in **Not Set**.

To enter the system setup, press F2 immediately after a power-on or re-boot.

1. In the **System BIOS** or **System Setup** screen, select **Security** and press Enter.
The **Security** screen is displayed.
2. Select **System Password** and create a password in the **Enter the new password** field.
Use the following guidelines to assign the system password:
 - A password can have up to 32 characters.

- The password can contain the numbers 0 through 9.
 - Only lower case letters are valid, upper case letters are not allowed.
 - Only the following special characters are allowed: space, ("), (+), (,), (-), (.), (/), (:), ([), (\), (]), (`).
3. Type the system password that you entered earlier in the **Confirm new password** field and click **OK**.
 4. Press Esc and a message prompts you to save the changes.
 5. Press Y to save the changes.
The computer reboots.

Deleting or changing an existing system and or setup password

Ensure that the **Password Status** is Unlocked (in the System Setup) before attempting to delete or change the existing System and/or Setup password. You cannot delete or change an existing System or Setup password, if the **Password Status** is Locked.

To enter the System Setup, press F2 immediately after a power-on or reboot.

1. In the **System BIOS** or **System Setup** screen, select **System Security** and press Enter.
The **System Security** screen is displayed.
2. In the **System Security** screen, verify that **Password Status** is **Unlocked**.
3. Select **System Password**, alter or delete the existing system password and press Enter or Tab.
4. Select **Setup Password**, alter or delete the existing setup password and press Enter or Tab.

NOTE: If you change the System and/or Setup password, re-enter the new password when prompted. If you delete the System and/or Setup password, confirm the deletion when prompted.

5. Press Esc and a message prompts you to save the changes.
6. Press Y to save the changes and exit from System Setup.
The computer reboots.

Disabling a System Password

The system's software security features include a system password and a setup password. The password jumper disables any password(s) currently in use. There are 2-pins for the PSWD jumper.

NOTE: The password jumper is disabled by default.

1. Follow the procedures in *Before Working Inside Your Computer*.
2. Remove the cover.
3. Identify the PSWD jumper on the system board. For identifying the PSWD jumper on the system board, see the System Board Components.
4. Remove the PSWD jumper from the system board.

NOTE: The existing passwords are not disabled (erased) until the computer boots without the jumper.

5. Install the cover.

NOTE: If you assign a new system and/or setup password with the PSWD jumper installed, the system disables the new password(s) the next time it boots.

6. Connect the computer to the electrical outlet and power-on the computer.
7. Power-off the computer and disconnect the power cable from the electrical outlet.
8. Remove the cover.
9. Replace the jumper on the pins.
10. Install the cover.
11. Follow the procedures in *After Working Inside Your Computer*.
12. Power-on the computer.
13. Go to the system setup, and assign a new system or setup password.

Diagnostics

If you experience a problem with your computer, run the ePSA diagnostics before contacting Dell for technical assistance. The purpose of running diagnostics is to test your computer's hardware without requiring additional equipment or risking data loss. If you are unable to fix the problem yourself, service and support personnel can use the diagnostics results to help you solve the problem.

Topics:

- [Enhanced Pre-Boot System Assessment - ePSA Diagnostics](#)

Enhanced Pre-Boot System Assessment - ePSA Diagnostics

The ePSA diagnostics (also known as system diagnostics) performs a complete check of your hardware. The ePSA is embedded with the BIOS and is launched by the BIOS internally. The embedded system diagnostics provides a set of options for particular devices or device groups allowing you to:

- Run tests automatically or in an interactive mode
- Repeat tests
- Display or save test results
- Run thorough tests to introduce additional test options to provide extra information about the failed device(s)
- View status messages that inform you if tests are completed successfully
- View error messages that inform you of problems encountered during testing

 **CAUTION: Use the system diagnostics to test only your computer. Using this program with other computers may cause invalid results or error messages.**

 **NOTE: Some tests for specific devices require user interaction. Always ensure that you are present at the computer terminal when the diagnostic tests are performed.**

1. Power-on the computer.
2. As the computer boots, press the <F12> key as the Dell logo appears.
3. On the boot menu screen, select the **Diagnostics** option.
The **Enhanced Pre-boot System Assessment** window is displayed, listing all devices detected in the computer. The diagnostics starts running the tests on all the detected devices.

 **NOTE: System may reboot before entering diagnostics depending on the configuration.**

4. If you wish to run a diagnostic test on a specific device, press <Esc> and click **Yes** to stop the diagnostic test.
5. Select the device from the left pane and click **Run Tests**.
6. If there are any issues, error codes are displayed.
Note the error code and contact Dell.

Troubleshooting your computer

Diagnostic LEDs

NOTE: The diagnostic LEDs only serve as an indicator of the progress through the Power-On Self Test (POST) process. These LEDs do not indicate the problem that caused the POST routine to stop.

The diagnostic LEDs are located on the front of the chassis next to the power button. These diagnostic LEDs are only active and visible during the POST process. Once the operating system starts to load, they turn off and are no longer visible.

Each LED has two possible states of OFF or ON.

NOTE: The diagnostic lights will blink when the power button is amber or off, and will not blink when it is white.

Table 16. POST Diagnostic LED Patterns

Power LED State	System State	Notes
Off	S5/S4	Normal- System is Off/Hibernate
Blinking White	S3	Normal- System is in Standby/Suspend
Blinking Amber	N/A	Abnormal- PSU cannot turn on, recommend PSU BIST. Replace PSU.
Steady White	S0	Normal- System is on functioning
Steady Amber	N/A	Abnormal- System cannot turn on, recommend check motherboard components or replace motherboard.

NOTE: Amber LED blinking scheme pattern is 2 or 3 blinks followed by a short pause then X number of blinks up to 7. Pattern has a long pause inserted in the middle. For example 2,3 = 2 amber blinks, short pause, 3 amber blinks followed by long pause then repeats.

Table 17. POST Diagnostic LED Patterns

Blink Patter	System State	Notes
2,1	A possible system motherboard failure has occurred.	Recommend replace motherboard.
2,2	A possible PSU or cabling issue has occurred.	Run PSU BIST. Check the PSU cabling to Motherboard to make sure that all cables are installed correctly.
2,3	A possible Motherboard, Memory, or CPU failure has occurred	If two or more memory modules are installed, remove the modules, then reinstall one module and restart the computer. If the computer starts normally, continue to install additional memory modules (one at a time) until you have identified a faulty module or reinstalled all modules without error.
2,4	A possible coin cell failure has occurred.	
2,5	System is in Recovery Mode	BIOS checksum failure was detected and the system is now in recovery mode.
2,6	A possible processor failure has occurred	Re-seat the processor
2,7	Memory modules are detected, but a memory power failure has occurred.	If two or more memory modules are installed, remove the modules, then reinstall one module and restart the computer. If the computer starts normally, continue to install additional memory modules (one at a time) until you have identified a faulty module or reinstalled all modules without error.

3,1	PCI device configuration activity is in progress or PCI device failure was detected.	Remove all peripheral cards from the PCI and PCI-E slots and reboot the computer. If the computer boots, add the peripheral cards back one by one until you find the bad one.
3,2	A possible HDD or USB failure has occurred.	Re-seat all power and data cables to HDD's. Reinstall all USB devices and check all cable connections.
3,3	No memory modules installed	If two or more memory modules are installed, remove the modules, then reinstall one module and restart the computer. If the computer starts normally, continue to install additional memory modules (one at a time) until you have identified all modules without error. If available, install working memory of the same type into your computer.
3,4	Power connector not installed properly.	Re-seat the 2x2 power connector from the power supply unit.
3,5	Memory modules are detected, but a memory configuration or compatibility error has occurred.	Ensure that no special requirements for memory module or connector placement exist. Ensure that the memory you are using is supported by your computer.
3,6	A possible system board resource and/or hardware failure has occurred.	Clear CMOS (re-seat the coin-cell battery. See removing and Installing Coin-Cell battery).
3,7	Some other failure has occurred.	Ensure that the display or monitor is plugged into a discrete graphics card. Ensure that all hard drives and optical-drive cables are properly connected to the system board. If there is an error message on the screen identifying a problem with a device (such as the floppy drive or hard drive), check the device to make sure it is functioning properly. If the operating system is attempting to boot from a device (such as the floppy drive or optical drive), check system setup to ensure the boot sequence is correct for the devices installed on your computer.

Error Messages

There are three types of BIOS error messages that are displayed depending on the severity of the issue. They are:

Errors That Halt Your Computer Completely

These error messages will halt the computer requiring you to cycle the system's power. The following table lists the error messages.

Table 18. Errors that halt your computer completely

Error Message
Error! Non-ECC DIMMs are not supported on this system.
Alert! Processor cache size is mismatched. Install like processor or one processor.
Alert! Processor type mismatch. Install like processor or one processor.
Alert! Processor speed mismatch Install like processor or one processor.
Alert! Incompatible Processor detected. Install like processor or one processor.

Errors That Do Not Halt Your Computer

These error messages will not halt your computer, but will display a warning message, pause for a few seconds, and then continue to boot. The following table lists the error messages.

Table 19. Errors that do not halt your computer

Error Message
Alert! Cover was previously removed.

Errors That Soft Halt Your Computer

These error messages will cause a soft halt of your computer and you will be prompted to press <F1> to continue or <F2 > to enter the system setup. The following table lists the error messages.

Table 20. — Errors that soft halt your computer

Error Message
Alert! Front I/O Cable failure.
Alert! Left Memory fan failure.
Alert! Right Memory fan failure.
Alert! PCI fan failure.
Alert! Chipset heat sink not detected.
Alert! Hard Drive fan1 failure.
Alert! Hard Drive fan2 failure.
Alert! Hard Drive fan3 failure.
Alert! CPU 0 fan failure.
Alert! CPU 1 fan failure.
Alert! Memory related failure detected.
Alert! Correctable memory error has been detected in memory slot DIMMx.
Warning: Non-optimal memory population detected. For increased memory bandwidth populate DIMM connectors with white latches before those with black latches.
Your current power supply does not support the recent configuration changes made to your system. Please contact Dell Technical support team to learn about upgrading to a higher wattage power supply.
Dell Reliable Memory Technology (RMT) has discovered and isolated errors in system memory. You may continue to work. Memory module replacement is recommended. Please refer to the RMT Event log screen in BIOS setup for specific DIMM information.
Dell Reliable Memory Technology (RMT) has discovered and isolated errors in system memory. You may continue to work. Additional errors will not be isolated. Memory module replacement is recommended. Please refer to the RMT Event log screen in BIOS setup for specific DIMM information.

Technical Specifications

NOTE: Offerings may vary by region. The following specifications are only those required by law to ship with your computer. For more information about the configuration of your computer, go to [Help and Support](#) in your Windows operating system and select the option to view information about your computer.

Table 21. Processor

Feature	Specification
Type	4, 6, 8, 10, 12, and 14 core Intel Xeon processor.
Cache	
Instruction Cache	32 KB
Data Cache	<ul style="list-style-type: none"> · 32 KB · 256 KB Mid-Level Cache per core · Up to 35 MB last level cache (LLC) shared among all cores (2.5 MB per core)

Table 22. System Information

Feature	Specification
Chipset	Intel(R) C610 , C612 chipset
BIOS chip (NVRAM)	16 MB serial flash EEPROM

Table 23. Memory

Feature	Specification
Memory module connector	8 DIMM slots
Memory module capacity	4 GB, 8 GB, 16 GB, and 32 GB
Type	2133/ 2400/ 2666 DDR4 RDIMM with ECC
Minimum memory	4 GB
Maximum memory	256 GB

Table 24. Video

Feature	Specification
Discrete (PCIe 3.0/2.0 x16)	up to 2 full-height, full-length (maximum of 225 W)

Table 25. Audio

Feature	Specification
Integrated	Realtek ALC3220 audio codec

Table 26. Network

Feature	Specification
Tower 5810	Intel i217

Table 27. Expansion Interfaces

Feature	Specification
PCI:	
SLOT1	PCI Express 3.0 x8, 8 GB/s
SLOT2	PCI Express 3.0 x16, 16 GB/s
SLOT3	PCI Express 2.0 x1, 0.5 GB/s
SLOT4	PCI Express 3.0 x16, 16 GB/s
SLOT5	PCI Express 2.0 x4, 2 GB/s
SLOT6	PCI 2.3 (32 bit, 33 MHz), 133 MB/s
Storage (HDD/SSD):	
SATA3-HDD0	Intel AHCI SATA 3.0, 6 Gbps
SATA3-HDD1	Intel AHCI SATA 3.0, 6 Gbps
SATA2-HDD2	Intel ACHI SATA 3.0, 6 Gbps
SATA2-HDD3	Intel ACHI SATA 3.0, 6 Gbps
Storage (ODD):	
SATA2-ODD0	Intel AHCI SATA 3.0, 6Gbps
SATA2-ODD1	Intel AHCI SATA 3.0, 6 Gbps
USB:	
Front ports	USB 3.0, 5 Gbps (1 port) USB 2.0, 480 Mbps (3 ports)
Rear ports	USB 3.0, 5 Gbps (3 ports)
Internal ports	USB 2.0, 480 Mbps (3 ports)

Table 28. Drives

Feature	Specification
Tower 5810	
Externally accessible:	
Slimline SATA optical bays	one
5.25-inch drive bays	one: <ul style="list-style-type: none"> • supports one 5.25-inches SATA optical device or supports one 3.25-inches SATA HDD device • supports one media card reader • supports up to two 2.5-inches SAS/SATA/HDDs/SSDs (with optional adapters)
Internally accessible	
3.5-inch hard drive bays	two: <ul style="list-style-type: none"> • supports two 3.25-inches SATA • supports 2.5-inches SAS/SATA/HDD/SSDs

Table 29. External Connectors

Feature	Specification
Audio	<ul style="list-style-type: none"> • front panel — mic-in, headphone-out • back panel — line-out, mic in/line In
Network	

Feature	Specification
Tower 5810	one RJ-45
Serial	one 9-pin connector
USB	
Tower 5810	<ul style="list-style-type: none"> • front panel — three USB 2.0, and one USB 3.0 • back panel — three USB 2.0, and one USB 3.0 • internal — three USB 2.0
Video	Video card dependent <ul style="list-style-type: none"> • DVI connector • mini DisplayPort • DisplayPort • DMS-59

Table 30. Internal Connectors

Feature	Specification
System power	one 28-pin connector
System fans	three 4-pin connectors
Processor fans	one 5-pin connector
HDD fans	one 5-pin connector
Thunderbolt side band connector	one 5-pin Connector
Memory	eight 288-pin connectors
Processor	one LGA-2011 socket
Back I/O:	
PCI Express	
PCI Express x4	
Tower 5810	two 164-pin connectors
PCI Express x16	
Tower 5810	two 164-pin connectors
PCI 2.3	one 124-pin connector
Front I/O:	
Front USB	one 14-pin connector
Internal USB	one type A female, one dual-port 2x5 header
Front panel control	one 2x14 pin connector
Front panel audio HDA header	one 2x5 pin connector
Hard drive/ Optical drive:	
SATA	
Tower 5810	<ul style="list-style-type: none"> • four 7-pin SATA connectors for HDD • two 7-pin SATA connectors for ODD
Power	
Tower 5810	one 24-pin and one 10-pin connector

Table 31. Controls and Lights

Feature	Specification
Power button light:	off — system is off or unplugged. solid white light — computer is operating normally. blinking white light — computer is in stand by. solid amber light — the computer does not start, indicating a problem with the system board or power supply. blinking amber light — indicates a problem has occurred with the system board.
Drive activity light	white light — blinking white light indicates that the computer is reading data from, or writing data to the hard drive.
Network link integrity lights (back panel)	green light — A good connection at 10 Mbps exists between the network and the computer orange light — A good connection at 100 Mbps exists between the network and the computer. yellow light — A good connection at 1000 Mbps exists between the network and the computer.
Network activity lights (back panel)	yellow light — flashes when there is network activity on the connection.

Table 32. Power

Feature	Specification
Voltage	100 VAC to 240 VAC
Wattage	
Tower 5810	685 / 425 W (input voltage of 100 VAC – 240 VAC)
Maximum heat dissipation	
685 W	2750.5 BTU/Hr
425 W	1706.5 BTU/Hr

 **NOTE: Heat dissipation is calculated by using the power supply wattage rating.**

Coin-cell battery	3 V CR2032 lithium coin cell
-------------------	------------------------------

Table 33. Physical

Feature	Specification
Tower 5810	
Height (with feet)	416.90 mm (16.41 inches)
Height (without feet)	414.00 mm (16.30 inches)
Width	172.60 mm (6.79 inches)
Depth	471.00 mm (18.54 inches)
Weight (minimum):	13.50 kg (29.80 lb) / 12.40 kg (27.40 lb)

Table 34. Environmental

Feature	Specification
Temperature:	
Operating	10 °C to 35 °C (50 °F to 95 °F)
Storage	-40 °C to 65 °C (-40 °F to 149 °F)
Relative humidity (maximum)	20% to 80% (noncondensing)

Feature	Specification
Maximum vibration:	
Operating	5 Hz to 350 Hz at 0.0002 G ² /Hz
Storage	5 Hz to 500 Hz at 0.001 to 0.01 G ² /Hz
Maximum shock:	
Operating	40 G +/- 5% with pulse duration of 2 msec +/- 10% (equivalent to 51 cm/sec [20 in/sec])
Storage	105 G +/- 5% with pulse duration of 2 msec +/- 10% (equivalent to 127 cm/sec [50 in/sec])
Altitude:	
Operating	-15.2 m to 3048 m (-50 ft to 10,000 ft)
Storage	-15.2 m to 10,668 m (-50 ft to 35,000 ft)
Airborne contaminant level	G1 as defined by ISA-S71.04-1985

Contacting Dell

 **NOTE:** If you do not have an active Internet connection, you can find contact information on your purchase invoice, packing slip, bill, or Dell product catalog.

Dell provides several online and telephone-based support and service options. Availability varies by country and product, and some services may not be available in your area. To contact Dell for sales, technical support, or customer service issues:

1. Go to **Dell.com/support**.
2. Select your support category.
3. Verify your country or region in the **Choose a Country/Region** drop-down list at the bottom of the page.
4. Select the appropriate service or support link based on your need.