

Dell Precision 7920 Rack

Owner's Manual

Notes, cautions, and warnings

 **NOTE:** A NOTE indicates important information that helps you make better use of your product.

 **CAUTION:** A CAUTION indicates either potential damage to hardware or loss of data and tells you how to avoid the problem.

 **WARNING:** A WARNING indicates a potential for property damage, personal injury, or death.

Chapter 1: Working on your computer	6
Safety instructions.....	6
Before working inside your computer.....	6
After working inside your computer.....	7
Chapter 2: Chassis View	8
Front chassis view.....	8
Back chassis view.....	9
Inside the system.....	9
LCD panel.....	10
Viewing Home screen.....	11
Setup menu.....	11
View menu.....	12
Chapter 3: Product Overview	13
Technical specifications.....	13
System dimensions.....	13
Chassis weight.....	14
Processor specifications.....	14
PSU specifications.....	14
System battery specifications.....	15
Expansion bus specifications.....	15
Memory specifications.....	15
Ports and connectors specifications.....	16
Video specifications.....	17
Environmental specifications.....	17
Operating system.....	19
System information label.....	19
Chapter 4: Disassembly and reassembly	21
Product Positioning.....	21
Recommended tools.....	22
Need to know.....	22
Common error messages.....	22
Startup-Shutdown sequence.....	24
Chassis LEDs.....	24
Status LED indicators.....	24
Hard drive indicator codes.....	26
NIC indicator codes.....	27
Power supply unit indicator codes.....	27
iDRAC Direct LED indicator codes.....	28
iDRAC Quick Sync 2 indicator codes.....	29
Enhanced Preboot System Assessment.....	30
Jumpers and connectors	32

System board jumpers and connectors.....	32
System board jumper settings.....	34
Disabling forgotten password.....	34
Disassembly and reassembly.....	35
Front Bezel.....	35
System cover.....	36
Optical drive.....	37
Air shroud.....	38
Cooling fan assembly.....	39
Cooling fans.....	39
Intrusion switch.....	40
Hard drive.....	41
Memory modules.....	49
Processors and heat sinks.....	51
Expansion card.....	55
vFlash card – optional.....	63
Network daughter card.....	64
Hard drive backplane.....	65
Front USB module.....	66
Internal USB memory key (optional).....	67
Power supply unit.....	67
System board.....	69
Trusted Platform Module.....	71
Control panel	72
GPU Host Card Installation.....	74
Alternate Riser Installation.....	74
Teradici Tera2220 Host Cards Installation.....	76
NVIDIA Quadro K4200 Graphics Cards Installation	81
Cabling Teradici Host Cards to GPUs.....	86
Updating BIOS	88
Restoring the Service Tag using Easy Restore	88
Manually update the Service Tag	89
Installation.....	89
Rack Rails.....	89
Initialization.....	97
Basic configuration.....	98
Accessing system information by using QRL.....	98
Quick Resource Locator for 7920R.....	99
Chapter 5: Technology and components.....	100
iDRAC9.....	100
iDRAC 9 - New features.....	100
Dell Lifecycle Controller.....	101
Processors.....	102
Supported processors.....	102
Chipset.....	108
System memory.....	109
General memory module installation guidelines.....	110
Memory.....	110
LCD panel.....	111

Viewing Home screen.....	112
Setup menu.....	112
View menu.....	112
Expansion cards and expansion card risers.....	113
Expansion card installation guidelines.....	113
Storage.....	114
Power supply units.....	115
Hot spare feature.....	115
Trusted platform module	116
Chapter 6: BIOS and UEFI.....	117
Options to manage the pre-operating system applications.....	117
System Setup.....	117
Viewing System Setup.....	117
System Setup Main Menu.....	118
System BIOS screen.....	118
System information screen details.....	119
Memory settings screen details.....	119
Processor settings screen details.....	120
SATA settings screen details.....	121
Boot settings screen details.....	123
Network settings screen details.....	124
Integrated devices screen details.....	125
Serial Communication screen details.....	127
System profile settings screen details.....	127
System security settings screen details.....	128
Miscellaneous settings screen details.....	130
Updating the BIOS.....	130
Updating the BIOS in Windows.....	130
Updating the BIOS in Linux and Ubuntu.....	131
Updating the BIOS using the USB drive in Windows.....	131
Updating the BIOS from the F12 One-Time boot menu.....	131
Chapter 7: Troubleshooting your system.....	133
System diagnostics.....	133
Dell Embedded System Diagnostics.....	133
Updating the BIOS using the USB drive in Windows.....	134
Updating the BIOS in Windows.....	134
Backup media and recovery options.....	135
WiFi power cycle.....	135
Chapter 8: Getting help and contacting Dell.....	136

Working on your computer

Topics:

- [Safety instructions](#)
- [Before working inside your computer](#)
- [After working inside your computer](#)

Safety instructions

Prerequisites

Use the following safety guidelines to protect your computer from potential damage and to ensure your personal safety. Unless otherwise noted, each procedure included in this document assumes that the following conditions exist:

- You have read the safety information that shipped with your computer.
- A component can be replaced or, if purchased separately, installed by performing the removal procedure in reverse order.

About this task

 **NOTE:** Disconnect all power sources before opening the computer cover or panels. After you finish working inside the computer, replace all covers, panels, and screws before connecting to the power source.

 **WARNING:** Before working inside your computer, read the safety information that shipped with your computer. For additional safety best practices information, see the [Regulatory Compliance Homepage](#)

 **CAUTION:** Many repairs may only be done by a certified service technician. You should only perform troubleshooting and simple repairs as authorized in your product documentation, or as directed by the online or telephone service and support team. Damage due to servicing that is not authorized by Dell is not covered by your warranty. Read and follow the safety instructions that came with the product.

 **CAUTION:** To avoid electrostatic discharge, ground yourself by using a wrist grounding strap or by periodically touching an unpainted metal surface at the same time as touching a connector on the back of the computer.

 **CAUTION:** Handle components and cards with care. Do not touch the components or contacts on a card. Hold a card by its edges or by its metal mounting bracket. Hold a component such as a processor by its edges, not by its pins.

 **CAUTION:** When you disconnect a cable, pull on its connector or on its pull-tab, not on the cable itself. Some cables have connectors with locking tabs; if you are disconnecting this type of cable, press in on the locking tabs before you disconnect the cable. As you pull connectors apart, keep them evenly aligned to avoid bending any connector pins. Also, before you connect a cable, ensure that both connectors are correctly oriented and aligned.

 **NOTE:** The color of your computer and certain components may appear differently than shown in this document.

Before working inside your computer

About this task

To avoid damaging your computer, perform the following steps before you begin working inside the computer.

Steps

1. Ensure that you follow the **Safety instructions**.
2. Turn off the system, including any attached peripherals.
3. Disconnect the system from the electrical outlet and disconnect the peripherals.
4. If applicable, remove the system from the rack.
5. Remove the system cover.

After working inside your computer

About this task

After you complete any replacement procedure, ensure that you connect any external devices, cards, and cables before turning on your computer.

Steps

1. Replace the cover.
2. If applicable, install the system into the rack.
3. Reconnect the peripherals and connect the system to the electrical outlet.
4. Turn on the system, including any attached peripherals.

Chassis View

Topics:

- Front chassis view
- Back chassis view
- Inside the system
- LCD panel

Front chassis view

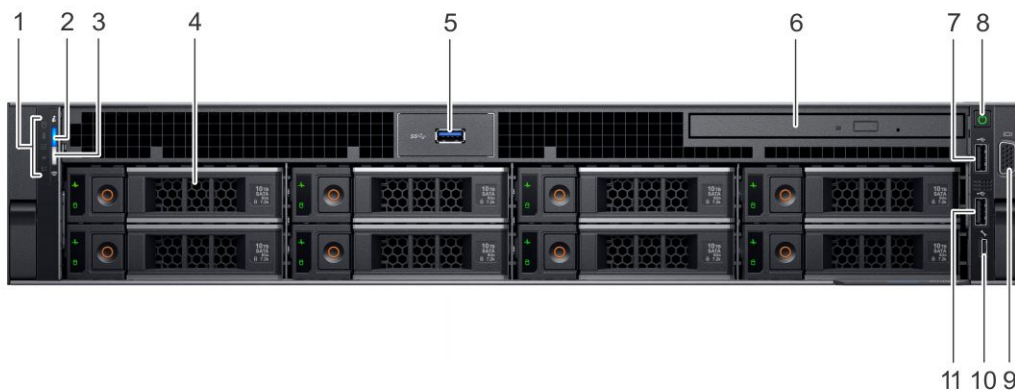

- | | |
|--|--------------------------------------|
| 1. System Status Indicator | 2. System health and system ID |
| 3. iDRAC Quick Sync 2 wireless indicator | 4. Hard drive (x8) |
| 5. USB 3.0 connector | 6. Optical-drive (optional) |
| 7. USB 2.0 connector | 8. Power button/Power light |
| 9. VGA connector | 10. USB management port/iDRAC Direct |
| 11. USB 2.0 connector | |

Back chassis view

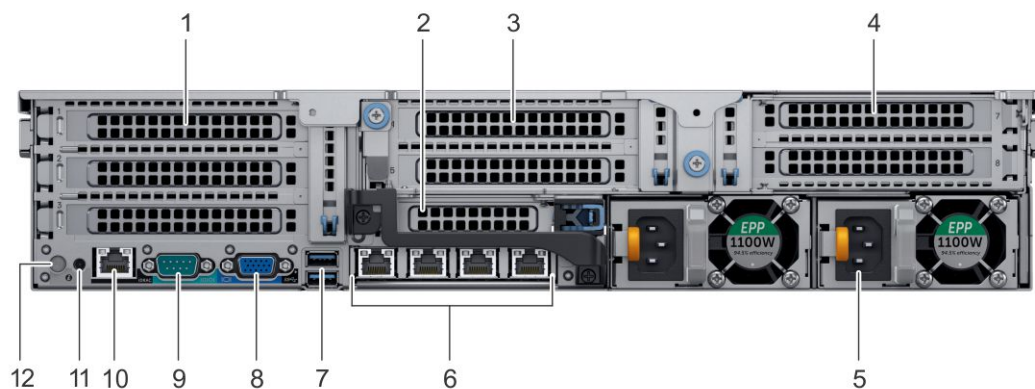

- | | |
|-------------------------------------|---|
| 1. PCIe expansion card slots | 2. PCIe expansion card slots |
| 3. PCIe expansion card slots | 4. PCIe expansion card slots |
| 5. Power supply (x2) | 6. Network connectors (x4) |
| 7. USB 3.0 connectors (x2) | 8. VGA connector |
| 9. Serial connector | 10. iDRAC9 Enterprise Network connector |
| 11. System identification connector | 12. System identification button |

Inside the system

NOTE: Many repairs may only be done by a certified service technician. You should only perform troubleshooting and simple repairs as authorized in your product documentation, or as directed by the online or telephone service and support team. Damage due to servicing that is not authorized by Dell is not covered by your warranty. Read and follow the safety instructions that are shipped with your product.

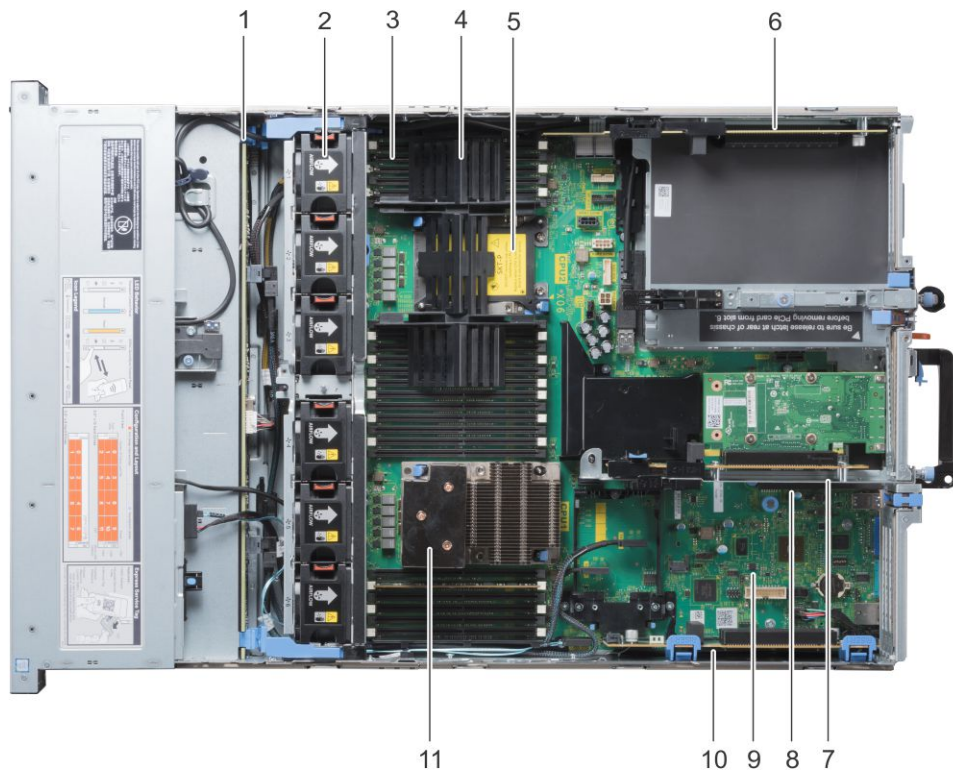

Figure 1. Inside chassis view

1. hard drive backplane
2. cooling fan (6) in the cooling fan assembly
3. DIMM sockets
4. CPU DIMM blank
5. CPU 2
6. expansion card riser 3A
7. expansion card riser 2A
8. VFlash connector
9. system board
10. expansion card riser 1C
11. CPU 1

LCD panel

The LCD panel provides system information, status, and error messages to indicate if the system is functioning correctly or requires attention. The LCD panel can also be used to configure or view the system's iDRAC IP address. For information about the event and error messages generated by the system firmware and agents that monitor system components, see the Error Code Lookup page at qrl.dell.com.

The LCD panel is available only on the optional front bezel. The optional front bezel is hot pluggable.

The statuses and conditions of the LCD panel are outlined here:

- The LCD backlight is white during normal operating conditions.

- When the system needs attention, the LCD backlight turns amber, and displays an error code followed by descriptive text.
 - NOTE:** If the system is connected to a power source and an error is detected, the LCD turns amber regardless of whether the system is turned on or off.
- When the system turns off and there are no errors, LCD enters the standby mode after five minutes of inactivity. Press any button on the LCD to turn it on.
- If the LCD panel stops responding, remove the bezel and reinstall it.
 - If the problem persists, see [Getting help](#) section.
- The LCD backlight remains off if LCD messaging is turned off using the iDRAC utility, the LCD panel, or other tools.

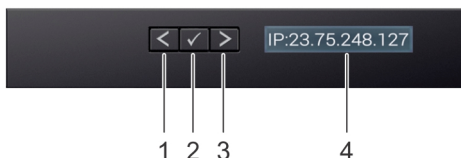

Figure 2. LCD panel features



Table 1. LCD panel features

Item	Button or display	Description
1	Left	Moves the cursor back in one-step increments.
2	Select	Selects the menu item highlighted by the cursor.
3	Right	Moves the cursor forward in one-step increments. During message scrolling: <ul style="list-style-type: none"> Press and hold the right button to increase scrolling speed. Release the button to stop. NOTE: The display stops scrolling when the button is released. After 45 seconds of inactivity, the display starts scrolling.
4	LCD display	Displays system information, status, and error messages or iDRAC IP address.

Viewing Home screen

The **Home** screen displays user-configurable information about the system. This screen is displayed during normal system operation when there are no status messages or errors. When the system turns off and there are no errors, LCD enters the standby mode after five minutes of inactivity. Press any button on the LCD to turn it on.

Steps

- To view the **Home** screen, press one of the three navigation buttons (Select, Left, or Right).
- To navigate to the **Home** screen from another menu, complete the following steps:
 - Press and hold the navigation button until the up arrow  is displayed.
 - Navigate to the **Home** icon  using the up arrow .
 - Select the **Home** icon.
 - On the **Home** screen, press the **Select** button to enter the main menu.

Setup menu

- NOTE:** When you select an option in the **Setup** menu, you must confirm the option before proceeding to the next action.

Option	Description
iDRAC	Select DHCP or Static IP to configure the network mode. If Static IP is selected, the available fields are IP , Subnet (Sub) , and Gateway (Gtw) . Select Setup DNS to enable DNS and to view domain addresses. Two separate DNS entries are available.
Set error	Select SEL to view LCD error messages in a format that matches the IPMI description in the SEL. This enables you to match an LCD message with an SEL entry. Select Simple to view LCD error messages in a simplified user-friendly description.
Set home	Select the default information to be displayed on the Home screen. See View menu section for the options and option items that can be set as the default on the Home screen.

View menu

 **NOTE:** When you select an option in the **View** menu, you must confirm the option before proceeding to the next action.

Option	Description
iDRAC IP	Displays the IPv4 or IPv6 addresses for iDRAC9. Addresses include DNS (Primary and Secondary) , Gateway , IP , and Subnet (IPv6 does not have Subnet).
MAC	Displays the MAC addresses for iDRAC , iSCSI , or Network devices.
Name	Displays the name of the Host , Model , or User String for the system.
Number	Displays the Asset tag or the Service tag for the system.
Power	Displays the power output of the system in BTU/hr or Watts. The display format can be configured in the Set home submenu of the Setup menu.
Temperature	Displays the temperature of the system in Celsius or Fahrenheit. The display format can be configured in the Set home submenu of the Setup menu.

Product Overview

The following pages contain information about Dell Precision 7920 Rack product overview.

Topics:

- [Technical specifications](#)
- [System information label](#)

Technical specifications

The technical and environmental specifications of your system are outlined in this section.

System dimensions

Table 2. Dimensions

System	Xa	Xb	Y	Za (with bezel)	Za (without bezel)	Zb	Zc
Precision 7920 Rack	482.0 mm (18.98 inches)	434.0 mm (17.09 inches)	86.8 mm (3.42 inches)	35.84 mm (1.41 inches)	22.0 mm (0.87 inches)	678.8 mm (26.72 inches)	715.5 mm (28.17 inches)

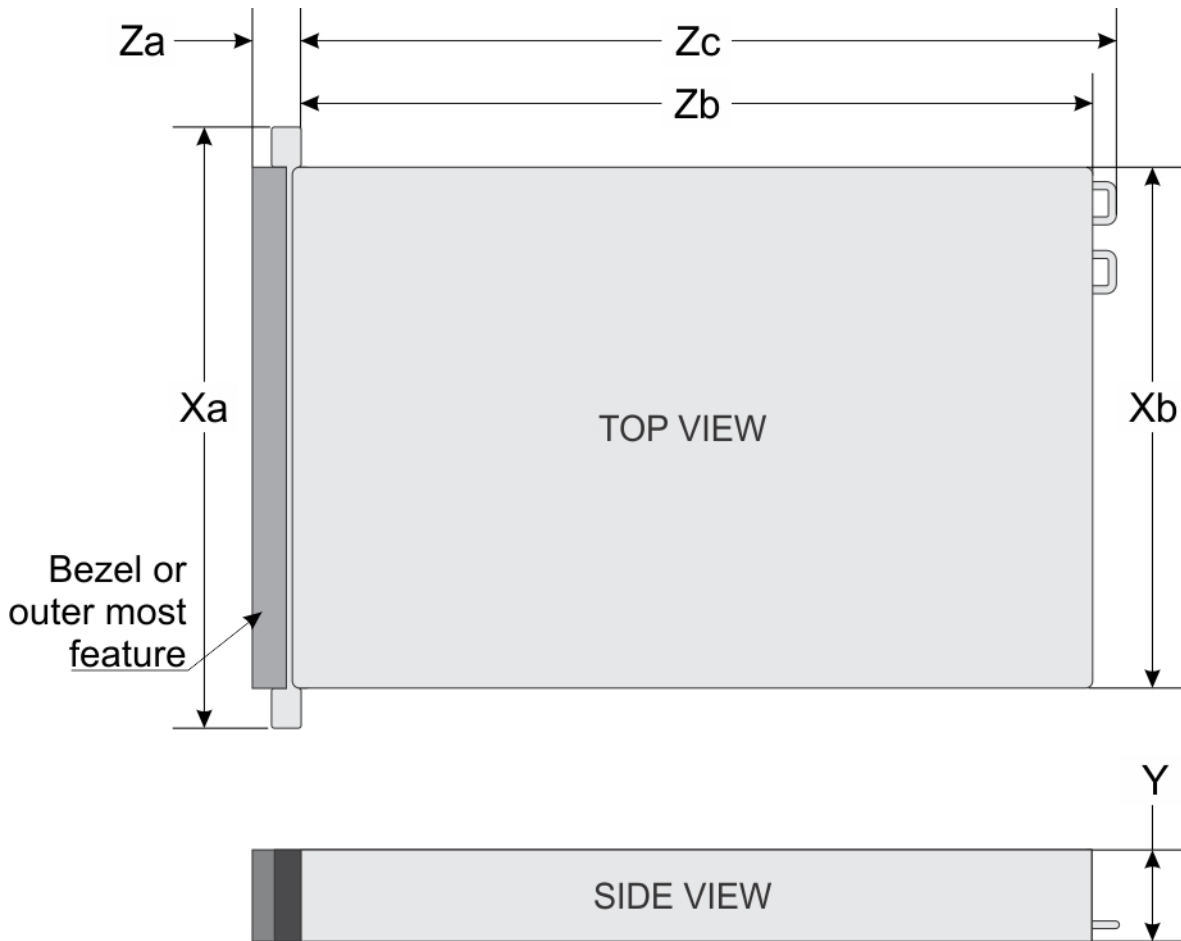

Chassis weight

Table 3. Chassis weight

System	Maximum weight (with all hard drives/SSDs)
3.5 inch hard drive systems	28.6 kg (63.05 lb)

Processor specifications

The Precision 7920 Rack system supports the following processors:

- Intel Xeon E5-26xx v5 processor
- Intel Xeon E5-26xx v6 processor
- Intel Xeon Gold 52xx processors
- Intel Xeon Silver 42xx processors
- Intel Xeon Bronze 32xx processors
- Intel Xeon Platinum 82xx processors
- Intel Xeon Gold 62xx series processors

PSU specifications

The Precision 7920 Rack system supports up to two AC power supply units (PSUs).

Table 4. PSU specifications

PSU	Class	Heat dissipation (maximum)	Frequency	Voltage	Current
1100 W AC	Platinum	4100 BTU/hr	50/60 Hz	100–240 V AC, autoranging	12 A–6.5 A
1600 W AC	Platinum	6000 BTU/hr	50/60 Hz	100–240 V AC, autoranging	10 A

NOTE: Heat dissipation is calculated using the PSU wattage rating.

NOTE: This system is also designed to connect to the IT power systems with a phase to phase voltage not exceeding 230 V.

NOTE: If a system with 1600 W AC PSU operates at low line 100–120 V AC, then the power rating per PSU is derated to 800 W.

System battery specifications

The Precision 7920 Rack system supports CR 2032 3.0-V lithium coin cell system battery.

Expansion bus specifications

The Precision 7920 Rack system supports up to eight PCI express (PCIe) generation 3 expansion cards, that can be installed on the system board using expansion card risers. The following table provides detailed information about the expansion card riser specifications:

Table 5. Expansion card riser configurations

Expansion card riser	PCIe slots on the riser	Height	Length	Link	CPU
Riser 1C	Slot 1	Full Height	Full Length	x16	CPU1
	Slot 2	Full Height	Full Length	x8	CPU1
	Slot 3	Full Height	Half Length	x8	CPU1
Riser 2A	Slot 4	Full Height	Full Length	x16	CPU2
	Slot 5	Full Height	Full Length	x8	CPU2
	Slot 6	Low Profile	Half Length	x8	CPU1
Riser 3A	Slot 7	Full Height	Full Length	x8	CPU2
	Slot 8	Full Height	Full Length	x16	CPU2

Memory specifications

Table 6. Memory specifications

Features	Specifications
Minimum memory configuration	8 GB
Maximum memory configuration	3072 GB
Number of slots	24
Maximum memory supported per slot	128 GB
Memory options	<ul style="list-style-type: none"> 1DPC (One DIMM per channel) 2DPC (Two DIMM per channel)

Table 6. Memory specifications (continued)

Features	Specifications
Type	DDR4 ECC or Non-ECC memory
Speed	<ul style="list-style-type: none"> Sky Lake Processors: 2666 MHz Cascade Lake Processors: 2933 MHz

Main Memory			CPU2												CPU1											
			iMC1						iMC0						iMC1						iMC0					
Total (GB)	DPC	Frequency	Ch5	Ch4	Ch3	Ch0	Ch1	Ch2	Ch5	Ch4	Ch3	Ch0	Ch1	Ch2	Ch5	Ch4	Ch3	Ch0	Ch1	Ch2	Ch5	Ch4	Ch3	Ch0	Ch1	Ch2
8	1DPC	2667																								
16	1DPC	2667																								
32	1DPC	2667																								
48	1DPC	2667																								
96	2DPC	2667																								
192	2DPC	2667																								
384	2DPC	2667																								
54	1DPC	2667																								
128	1DPC	2667																								
384	1DPC	2667																								
512	2DPC	2667																								
768	2DPC	2667																								
16	1DPC	2667																								
32	1DPC	2667																								
64	1DPC	2667																								
96	1DPC	2667																								
128	2DPC	2667																								
192	2DPC	2667																								
256	2DPC	2667																								
384	2DPC	2667																								
512	2DPC	2667																								
768	2DPC	2667																								
128	1DPC	2667																								
256	1DPC	2667																								
512	1DPC	2667																								
768	1DPC	2667																								
1024	2DPC	2667																								
1536	2DPC	2667																								

Main Memory			CPU2												CPU1											
			iMC1						iMC0						iMC1						iMC0					
Total (GB)	DPC	Frequency	Ch5	Ch4	Ch3	Ch0	Ch1	Ch2	Ch5	Ch4	Ch3	Ch0	Ch1	Ch2	Ch5	Ch4	Ch3	Ch0	Ch1	Ch2	Ch5	Ch4	Ch3	Ch0	Ch1	Ch2
0	1	0	1	0	1	1	0	1	0	1	0	0	1	0	1	0	1	1	0	1	0	1	0	1	0	
W	B	W	B	W	B	B	W	B	W	B	W	W	B	W	B	W	B	B	W	B	W	B	W	B	W	
Motherboard	Silk	Screen	B6	B12	B5	B11	B4	B10	B7	B1	B8	B2	B9	B3	A6	A12	A5	A11	A4	A10	A7	A1	A8	A2	A9	A3

Ports and connectors specifications

USB ports

The Precision 7920 Rack system supports:

- Two USB 2.0-compliant ports on the front panel
- One internal USB 3.0-compliant port
- One USB 3.0-compliant port on the front panel
- One micro USB 2.0-compliant port in the front panel for iDRAC Direct
- Two USB 3.0-compliant ports on the back panel

NIC ports

The Precision 7920 Rack system supports up to four Network Interface Controller (NIC) ports on the back panel, which are available in the following configurations:

- Four RJ-45 ports that support different combinations of 1Gbps and 10Gbps
- One RJ-45 ports that support iDRAC9 Enterprise Network connector

NOTE: vFlash card have dedicated slots on the system board.

VGA ports

The Video Graphic Array (VGA) port enables you to connect the system to a VGA display. The Precision 7920 Rack system supports two 15-pin VGA ports on the front and back panels.

Serial connector

The Precision 7920 Rack system supports one serial connector on the back panel, which is a 9-pin connector, Data Terminal Equipment (DTE), 16550-compliant.

Internal Dual SD module vFlash card

The Precision 7920 Rack system supports vFlash card.

Video specifications

The Precision 7920 Rack system supports integrated Matrox G200eW3 graphics controller with 16 MB of video frame buffer.

Table 7. Supported video resolution options

Resolution	Refresh rate (Hz)	Color depth (bits)
1024 x 768	60	8, 16, 32
1280 x 800	60	8, 16, 32
1280 x 1024	60	8, 16, 32
1360 x 768	60	8, 16, 32
1440 x 900	60	8, 16, 32
1600 x 900	60	8, 16, 32
1600 x 1200	60	8, 16, 32
1680 x 1050	60	8, 16, 32
1920 x 1080	60	8, 16, 32
1920 x 1200	60	8, 16, 32

 **NOTE:** 1920 x 1080 and 1920 x 1200 resolutions are only supported in reduced blanking mode.

Environmental specifications

 **NOTE:** For additional information about environmental measurements for specific system configurations, see Dell.com/environmental_datasheets.

Table 8. Temperature specifications

Temperature	Specifications
Storage	-40°C to 65°C (-40°F to 149°F)
Continuous operation (for altitude less than 950 m or 3117 ft)	10°C to 35°C (50°F to 95°F) with no direct sunlight on the equipment.
Maximum temperature gradient (operating and storage)	20°C/h (68°F/h)

Table 9. Relative humidity specifications

Relative humidity	Specifications
Storage	5% to 95% RH with 33°C (91°F) maximum dew point. Atmosphere must be non-condensing at all times.
Operating	10% to 80% relative humidity with 29°C (84.2°F) maximum dew point.

Table 10. Maximum vibration specifications

Maximum vibration	Specifications
Operating	0.26 G _{rms} at 5 Hz to 350 Hz (all three axes).
Storage	1.88 G _{rms} at 10 Hz to 500 Hz for 15 min (all six sides tested).

Table 11. Maximum shock specifications

Maximum shock	Specifications
Operating	Six consecutively executed shock pulses in the positive and negative x, y, and z axes of 6 G for up to 11 ms.
Storage	Six consecutively executed shock pulses in the positive and negative x, y, and z axes (one pulse on each side of the system) of 71 G for up to 2 ms.

Table 12. Maximum altitude specifications

Maximum altitude	Specifications
Operating	3048 m (10,000 ft)
Storage	12,000 m (39,370 ft)

Table 13. Operating temperature de-rating specifications

Operating temperature de-rating	Specifications
Up to 35°C (95°F)	Maximum temperature is reduced by 1°C/300 m (1°F/547 ft) above 950 m (3,117 ft).
35°C to 40°C (95°F to 104°F)	Maximum temperature is reduced by 1°C/175 m (1°F/319 ft) above 950 m (3,117 ft).
40°C to 45°C (104°F to 113°F)	Maximum temperature is reduced by 1°C/125 m (1°F/228 ft) above 950 m (3,117 ft).

Particulate and gaseous contamination specifications

The following table defines the limitations that help avoid any equipment damage or failure from particulate and gaseous contamination. If the levels of particulate or gaseous pollution exceed the specified limitations and result in equipment damage or failure, you may need to rectify the environmental conditions. Remediation of environmental conditions is the responsibility of the customer.

Table 14. Particulate contamination specifications

Particulate contamination	Specifications
Air filtration	Data center air filtration as defined by ISO Class 8 per ISO 14644-1 with a 95% upper confidence limit. <i>i</i> NOTE: The ISO Class 8 condition applies to data center environments only. This air filtration requirement does not apply to IT equipment designed to be used outside a data center, in environments such as an office or factory floor.

Table 14. Particulate contamination specifications (continued)

Particulate contamination	Specifications
	<p>i NOTE: Air entering the data center must have MERV11 or MERV13 filtration.</p>
Conductive dust	<p>Air must be free of conductive dust, zinc whiskers, or other conductive particles.</p> <p>i NOTE: This condition applies to data center and non-data center environments.</p>
Corrosive dust	<ul style="list-style-type: none"> Air must be free of corrosive dust. Residual dust present in the air must have a deliquescent point less than 60% relative humidity. <p>i NOTE: This condition applies to data center and non-data center environments.</p>

Table 15. Gaseous contamination specifications

Gaseous contamination	Specifications
Copper coupon corrosion rate	<300 Å/month per Class G1 as defined by ANSI/ISA71.04-2013.
Silver coupon corrosion rate	<200 Å/month as defined by ANSI/ISA71.04-2013.

i **NOTE:** Maximum corrosive contaminant levels measured at ≤50% relative humidity.

Operating system

Your Precision 7920 Rack supports the following operating systems:

- Windows 11 Pro, 64-bit
- Windows 11 Pro for Workstations, 64-bit
- Windows 10 Pro, 64-bit
- Windows 7 Pro, 32-bit (downgradable)
- Windows 7 Pro, 64-bit (downgradable)
- RHEL 8.0
- Ubuntu 16.04 LTS, 64-bit

System information label

Precision 7920 Rack – Front system information label

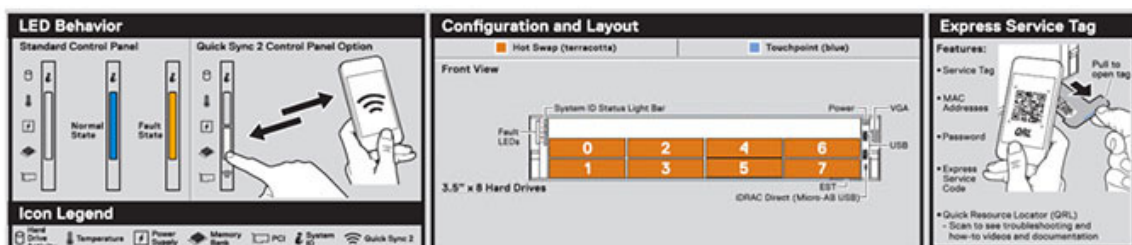

Figure 3. LED Behavior, Express Service Tag, Configuration and Layout

Precision 7920 Rack – Service information

Service Information

System Touchpoints

- Components with orange touchpoints can be serviced while the system is running (hot swap).
- Components with blue touchpoints require a full system shutdown before servicing (cold swap).

Mechanical Overview

Top View

Front of system

Electrical Overview

System Board Connections

- ADC
- KL_Riser 2
- TPM
- Coin Cell Battery
- KL_Riser 1
- SATA_B
- KL_Riser M/MiniPCIe Option
- SATA_A
- SATA_Optical Drive
- CPU1 DIMM Channels 0/1/2
- CPU2 DIMM Channels 0/1/2
- CPU3 DIMM Channels 0/1/2
- KL_Riser 3
- PLU1
- Backuplite 2 Power/ Rear 2 PCIe 2280 Power
- Backuplite 3 Power/ Rear 3 PCIe 2280 Power
- PSU1
- Backuplite 1 Power
- Fan 8
- Fan 4
- Internal USB
- Fan 3
- Fan 2
- Backuplite 1 Power
- Fan 1
- Left Control Panel
- CPU1 DIMM Channels 3/4/5
- CPU2 DIMM Channels 3/4/5
- Backuplite 3 Signal
- Backuplite 2 Signal
- KL_Riser 3
- PLU2
- Backuplite 2 Power/ Rear 2 PCIe 2280 Power
- Backuplite 3 Power/ Rear 3 PCIe 2280 Power
- PSU2
- Backuplite 1 Signal
- KL_Riser 2
- PLU1
- Backuplite 2 Power/ Rear 2 PCIe 2280 Power
- Backuplite 3 Power/ Rear 3 PCIe 2280 Power
- PSU1
- Backuplite 1 Signal
- Fan 8
- Fan 4
- Internal USB
- Fan 3
- ESDKit v of Flash

Rear View Configurations

Jumper Settings

Jumper	Setting	Description
FWL1_SW	(Default)	BIOS password is enabled.
	(Default)	BIOS password is disabled. iDRAC 'root' access unlocked at next AC power cycle.
FWL2_SW	(Default)	BIOS configuration settings retained at system boot.
	(Default)	BIOS configuration settings cleared at system boot.

Memory Information

Caution: Memory (DIMMs) and CPUs may be hot during servicing.

Memory Population Configuration

Configuration	Sequence
Memory-Optimized	1, 2, 3, 4, 5, 6, 7, 8, 9, 10, 11, 12
Advanced ECC or Mirroring	(1,2) (3,4) (5,6) (7,8) (9,10) (11,12)

Memory sparing details are documented in the Owner's Manual.

Service Tasks

- Reinstall System Board
- Reinstall System Board
- Reinstall System Board

Caution: Many repairs may only be done by a certified service technician. You should only perform troubleshooting and simple repairs as authorized in your product documentation, or as directed by the online or telephone service and support team. Damage due to servicing that is not authorized by Dell is not covered by your warranty. Read and follow the safety instructions that came with the product.

Copyright © 2012 Dell Inc. or its subsidiaries. All Rights Reserved. Dell, the Dell logo, and Precision are trademarks of Dell Inc. or its subsidiaries.

Figure 4. System touchpoint, electrical overview, jumper settings and memory information

Disassembly and reassembly

Topics:

- [Product Positioning](#)
- [Recommended tools](#)
- [Need to know](#)
- [Chassis LEDs](#)
- [Jumpers and connectors](#)
- [Disassembly and reassembly](#)
- [GPU Host Card Installation](#)
- [Updating BIOS](#)
- [Restoring the Service Tag using Easy Restore](#)
- [Installation](#)
- [Accessing system information by using QRL](#)

Product Positioning

The Precision 7920 Rack is a general-purpose platform with highly expandable memory (up to 1536 GB), massive storage capacity and impressive I/O capability to match. The Precision 7920 Rack adds extraordinary storage capacity options, making it well-suited for data intensive applications that require greater storage, while not sacrificing I/O performance.

• **Performance**

- Two Intel Xeon Skylake Processor Scalable Family processors
- Twenty four DIMM Slot supporting up total up to 1.5TB of memory
- Support total up to eight hard drives.

• **Availability**



- Redundant power supply units (PSUs)
- Hot-plug and hot-swappable PSUs, hard disk drives, and fans
- PERC9/PERC10/Chipset SATA.
- Internal vFLASH card
- iDRAC9 Express or Enterprise with Dell Lifecycle Controller
- Optional iDRAC Quick Sync II

• **Expandability, I/O Storage**

- Only 8x 3.5" SAS,SATA(front) hard drives
- Up to eight optional NVMe Express Flash PCIe SSDs with two PCIe Zoom4 cards.
- System Network Architecture (SNA): 4x 1GbE or 2x 10GbE + 2x 1GbE
- Choice of RAID options for even higher performance

Recommended tools

Table 16. Recommended tools and optional tools

Recommended tools	Optional tools
	
	
<ul style="list-style-type: none"> • Key to the system keylock • #1 and #2 Phillips screwdriver • T30 and T8 Torx screwdrivers • Wrist-grounding strap connected to the ground • ESD Mat 	<ul style="list-style-type: none"> • Needle-nose pliers to disconnect cables and connectors in hard-to-reach locations • Small flat-head screwdriver to disconnect small cables from boards

Need to know

Before you begin servicing the system, you must read the following information:

- Critical callouts
- Common error codes
- Version control for BIOS/ Firmware/ Software
- Startup/Shutdown sequence

Common error messages

The Event Message Reference contains the error and event information generated by firmware and other agents that monitor system components. These events might be logged, presented to the user on one of the system management consoles, or both logged and displayed.

Each event consists of the following fields:

Table 17. Common error messages

Event Message Fields	
Item	Description
Message ID	The unique alphanumeric identifier for the event. This identifier can be up to eight characters long and consist of two parts: <ul style="list-style-type: none"> • Message ID Prefix — Up to four alphabetic characters. • Message ID Sequence — Up to four numeric digits.
Message	The message text that is displayed to the user or logged as a result of the event. If the message has variable content in it, the variable substitution is reflected by text in <i>italics</i> . The substitution variables are described in the Arguments field of the event.
Arguments	Describes the values for any substitution variables appearing in the event message text. If there is no variable content in the message, this field is omitted from the event description.
Detailed Description	Additional information describing the event.
Recommended Response Action	The recommended action to remedy the event described. The response action can vary based on the specific platform.
Category	Dell Lifecycle Controller log filter used to select a subset of messages from different domains or agents.
Subcategory	Additional filter to further subset the event.
Trap/EventID	The identification number used as the Trap ID for SNMP alert traps and as the Event ID when the message is logged in operating system logs.
Severity	The classification of the event based on its impact to the platform or system. The severity can be: <ul style="list-style-type: none"> • Severity 1 Critical — Indicates a catastrophic production problem that might severely impact production systems or components, or systems are down or not functioning. • Severity 2 Warning — Indicates a high-impact problem where a system or component is disrupted but can remain productive and perform business-level operations. • Severity 3 Information — Indicates a medium-to-low impact problem that involves a partial or noncritical loss of functionality; operations are impaired but can continue to function.
LCD Message	The event message text that is displayed on the system's LCD.
Initial Default	Event messages result in event actions such as logging, SNMP or email alerts. Generally, the event actions are configurable using the Dell iDRAC event action filtering feature. This item describes the initial default and possible event actions for the message.
Event Action Filter	Describes additional configurable actions that are available for the event action for this message. This information is presented in a table, and each entry has a value of TRUE or FALSE to indicate its applicability. <ul style="list-style-type: none"> • Filter Visibility — Event visible to iDRAC event filtering. • IPMI Alert — Event can generate an IMPI alert. • SNMP Alert — Event can generate an SNMP trap. • Email Alert — Event can generate an email alert. • LC Log — Event can generate a Dell Lifecycle Controller log entry. • LCD — Event is displayed on the system's LCD. • Power Off — Event can cause the system to power off. • Power Cycle — Event can cause the system to perform a power cycle. • Reset — Event can cause the system to perform a reset.

For more information on the list of error and event messages, see the [Dell Event Messages Reference Guide](#)

Startup-Shutdown sequence

 **NOTE:** Precision 7920 Rack BIOS is pure UEFI with a legacy compatibility layer. This layer is called the Compatibility Support Module.

New POST display

The following are the POST display enhancements:

- The look of the boot process has been revamped for Precision 7920 Rack.
- The Dell high-resolution splash screen displays instantly after power-on.
- Both a progress bar and descriptive text appear on-screen.
- Hotkey behavior remains unchanged (**<F2>** still takes you to System Setup).
- There is a uniform look and feel through the boot process (one exception — the system will drop to text mode briefly to run legacy option ROMs when booting in legacy mode).
- POST error messages are now compliant with Error Exception Message Initiative (EEMI).
 **NOTE:** All POST error and warning messages will be logged in the LC log.
- UEFI option ROMs display error/warning messages on the screen via the Driver Health Protocol (DHP). The auto-repair logic is also included in Boot Device Selection (BDS) just before booting. Show the repair GUI and load the controller formset if EfiDriverHealthStatusConfigurationRequired status is returned.

Enhanced boot support

The following lists the boot support enhancements:

- Enhanced method to change the boot list based on Fully Qualified Descriptors (FQDDs). This allows for systems management consoles and the factory to specify a boot list for devices that are not currently present, for example, disabled NDC or other boot mode.
- New ability to toggle between LC and BIOS.
- The Boot Manager (**<F11>**) and BIOS Setup (**<F2>**) will only contain the boot option enumeration of the current Boot mode.
- Completely revised boot flow.

Chassis LEDs

The following pages contain the information about the chassis LEDs.

Status LED indicators

 **NOTE:** The diagnostic indicators are not present if the system is equipped with an LCD display.

 **NOTE:** The status LED indicators are always off and only turns on to a solid amber if any error occurs.

Table 18. Status LED indicators and descriptions







Icon	Description	Condition	Corrective action
	Health indicator	The indicator turns solid blue if the is in good health. The indicator blinks amber: <ul style="list-style-type: none">• When the is turned on.• When the is in standby.• If any error condition exists. For example, a failed fan, PSU, or a hard drive.	None required. Check the System Event Log or system messages for the specific issue. For more information about error messages, see the <i>Dell Event and Error Messages Reference Guide</i> at Dell.com/openmanagemanuals > OpenManage software .

Table 18. Status LED indicators and descriptions (continued)

Icon	Description	Condition	Corrective action
	Drive indicator	The indicator turns solid amber if there is a drive error.	<p>The POST process is interrupted without any video output due to invalid memory configurations. See the Getting help section.</p> <ul style="list-style-type: none"> • Check the System Event Log to determine if the drive has an error. • Run the appropriate Online Diagnostics test. Restart the system and run embedded diagnostics (ePSA). • If the drives are configured in a RAID array, restart the system, and enter the host adapter configuration utility program.
	Temperature indicator	The indicator turns solid amber if the system experiences a thermal error (for example, the ambient temperature is out of range or there is a fan failure).	<p>Ensure that none of the following conditions exist:</p> <ul style="list-style-type: none"> • A cooling fan has been removed or has failed. • System cover, air shroud, memory module blank, or back filler bracket is removed. • Ambient temperature is too high. • External airflow is obstructed. <p>If the problem persists, see the Getting help section.</p>
	Electrical indicator	The indicator turns solid amber if the system experiences an electrical error (for example, voltage out of range, or a failed power supply unit (PSU) or voltage regulator).	<p>Check the System Event Log or system messages for the specific issue. If it is due to a problem with the PSU, check the LED on the PSU. Reseat the PSU. If the problem persists, see the Getting help section.</p>
	Memory indicator	The indicator turns solid amber if a memory error occurs.	<p>Check the System Event Log or system messages for the location of the failed memory. Reseat the memory module. If the problem persists, see the Getting help section.</p>
	PCIe indicator	The indicator turns solid amber if a PCIe card experiences an error.	<p>Restart the system. Update any required drivers for the PCIe card. Reinstall the card. If the problem persists, see the Getting help section.</p> <p>NOTE: For more information about the supported PCIe cards, see the Expansion card installation guidelines section.</p>

Hard drive indicator codes

Each hard drive carrier has an activity LED indicator and a status LED indicator. The indicators provide information about the current status of the hard drive. The activity LED indicator indicates whether the hard drive is currently in use or not. The status LED indicator indicates the power condition of the drive.

Hard drive indicators

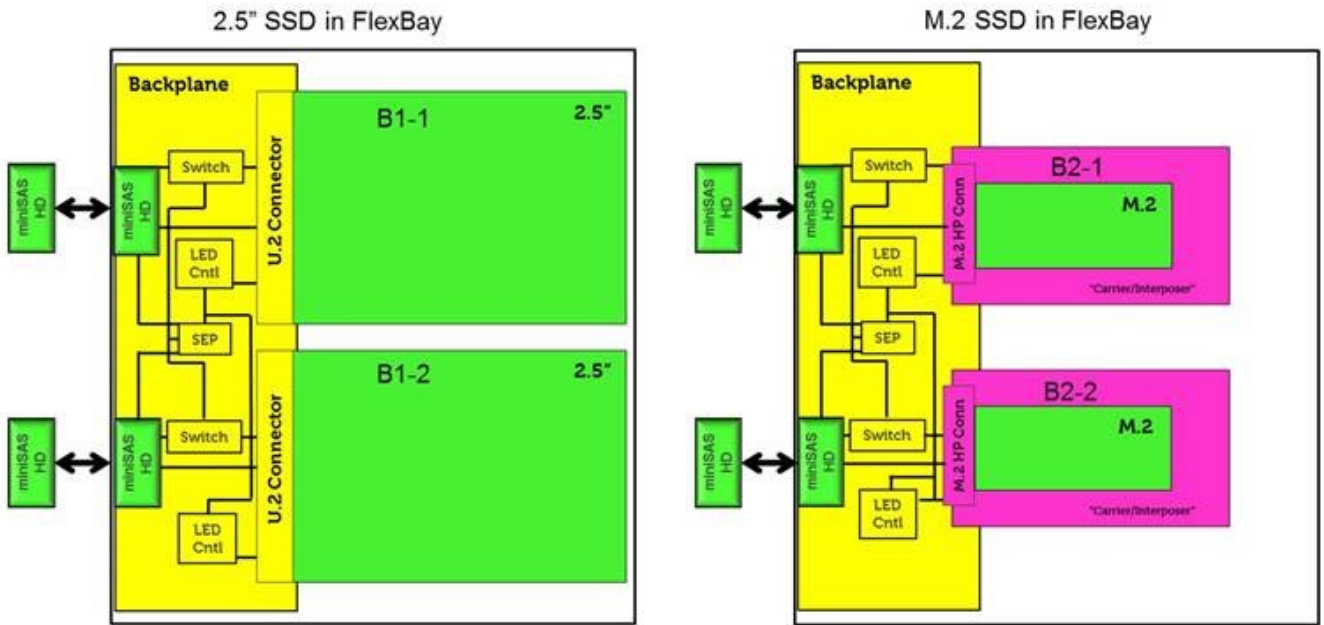

NOTE: LED status or activity indicators will only work with a backplane with each carriers shown below.

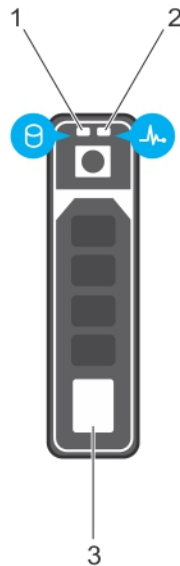

Figure 5. Hard drive indicators

1. hard drive activity LED indicator
2. hard drive status LED indicator
3. hard drive

NOTE: If the hard drive is in the Advanced Host Controller Interface (AHCI) mode, the status LED indicator does not turn on.

NOTE: Drive status indicator behavior is managed by Storage Spaces Direct. Not all drive status indicators may be used.

Table 19. Hard drive indicator codes

Hard drive status indicator code	Condition
Flashes green twice per second	Identifying drive or preparing for removal.
Off	Drive ready for removal. NOTE: The drive status indicator remains off until all drives are initialized after the system is turned on. Drives are not ready for removal during this time.
Flashes green, amber, and then turns off	Predicted drive failure.
Flashes amber four times per second	Drive failed.
Flashes green slowly	Drive rebuilding.
Solid green	Drive online.
Flashes green for three seconds, amber for three seconds, and then turns off after six seconds	Rebuild stopped.

NIC indicator codes

Each NIC on the back of the system has indicators that provide information about the activity and link status. The activity LED indicator indicates if data is flowing through the NIC, and the link LED indicator indicates the speed of the connected network.

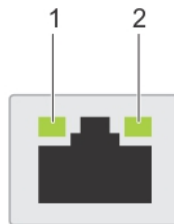

Figure 6. NIC indicator codes

1. Link LED indicator
2. Activity LED indicator

Table 20. NIC indicator codes

Status	Condition
Link and activity indicators are off.	The NIC is not connected to the network.
Link indicator is green, and activity indicator is blinking green.	The NIC is connected to a valid network at its maximum port speed, and data is being sent or received.
Link indicator is amber, and activity indicator is blinking green.	The NIC is connected to a valid network at less than its maximum port speed, and data is being sent or received.
Link indicator is green, and activity indicator is off.	The NIC is connected to a valid network at its maximum port speed, and data is not being sent or received.
Link indicator is amber, and activity indicator is off.	The NIC is connected to a valid network at less than its maximum port speed, and data is not being sent or received.
Link indicator is blinking green, and activity is off.	NIC identify is enabled through the NIC configuration utility.

Power supply unit indicator codes

AC power supply units (PSUs) have an illuminated translucent handle that serves as an indicator. The indicator shows whether power is present or a power fault has occurred.

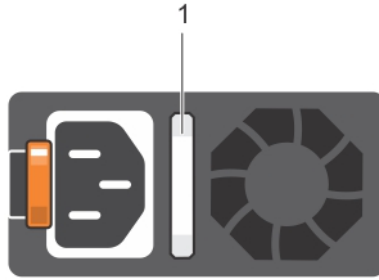

Figure 7. AC PSU status indicator

1. AC PSU status indicator/handle

Table 21. AC PSU status indicator codes

Power indicator codes	Condition
Green	A valid power source is connected to the PSU and the PSU is operational.
Blinking amber	Indicates a problem with the PSU.
Not illuminated	Power is not connected to the PSU.
Blinking green	When the firmware of the PSU is being updated, the PSU handle blinks green. ⚠ CAUTION: Do not disconnect the power cord or unplug the PSU when updating firmware. If firmware update is interrupted, the PSUs do not function.
Blinking green and turns off	When hot-plugging a PSU, the PSU handle blinks green five times at a rate of 4 Hz and turns off. This indicates a PSU mismatch with respect to efficiency, feature set, health status, or supported voltage. ⚠ CAUTION: If two PSUs are installed, both the PSUs must have the same type of label. For example, Extended Power Performance (EPP) label. Mixing PSUs from previous generations of Precision Workstation is not supported, even if the PSUs have the same power rating. This results in a PSU mismatch condition or failure to turn the system on. ⚠ CAUTION: When correcting a PSU mismatch, replace only the PSU with the blinking indicator. Swapping the PSU to make a matched pair can result in an error condition and unexpected system shutdown. To change from a high output configuration to a low output configuration or vice versa, you must turn off the system. ⚠ CAUTION: AC PSUs support both 240 V and 120 V input voltages with the exception of Titanium PSUs, which support only 240 V. When two identical PSUs receive different input voltages, they can output different wattages, and trigger a mismatch. ⚠ CAUTION: If two PSUs are used, they must be of the same type and have the same maximum output power. ℹ NOTE: Ensure that both the PSUs are of the same capacity. ℹ NOTE: Mixing PSUs (even the PSUs that have the same power rating) from previous generations of Precision Workstation is not supported. This results in a PSU mismatch condition or failure to turn the system on.

iDRAC Direct LED indicator codes

The iDRAC Direct LED indicator lights up to indicate that the port is connected and is being used as a part of the iDRAC subsystem.

You can configure iDRAC Direct by using a USB to micro USB (type AB) cable, which you can connect to your laptop or tablet. The following table describes iDRAC Direct activity when the iDRAC Direct port is active:

Table 22. iDRAC Direct LED indicator codes

iDRAC Direct LED indicator code	Condition
Solid green for two seconds	Indicates that the laptop or tablet is connected.
Flashing green (on for two seconds and off for two seconds)	Indicates that the laptop or tablet connected is recognized.
Turns off	Indicates that the laptop or tablet is unplugged.

iDRAC Quick Sync 2 indicator codes

iDRAC Quick Sync 2 module (optional) is on the front panel of your system.



Figure 8. iDRAC Quick Sync 2 indicator

Table 23. iDRAC Quick Sync 2 indicators and descriptions

iDRAC Quick Sync 2 indicator code	Condition	Corrective action
Off (default state)	Indicates that the iDRAC Quick Sync 2 feature is turned off. Press the iDRAC Quick Sync 2 button to turn on the iDRAC Quick Sync 2 feature.	If the LED fails to turn on, reset the left control panel flex cable and check. If the problem persists, see the Getting help section.
Solid white	Indicates that iDRAC Quick Sync 2 is ready to communicate. Press the iDRAC Quick Sync 2 button to turn off.	If the LED fails to turn off, restart the system. If the problem persists, see the Getting help section.
Blinks white rapidly	Indicates data transfer activity.	NA If the problem persists, see the Getting help section.
Blinks white slowly	Indicates that firmware update is in progress.	NA If the indicator continues to blink indefinitely, see the Getting help section.
Blinks white five times rapidly and then turns off	Indicates that the iDRAC Quick Sync 2 feature is disabled.	Check if iDRAC Quick Sync 2 feature is configured to be disabled by iDRAC. If the problem persists, see the Getting help section. For more information, see <i>Integrated Dell Remote Access Controller User's Guide</i> at dell.com/idracmanuals or <i>Dell OpenManage Server Administrator User's Guide</i> at dell.com/openmanagemanuals .
Solid amber	Indicates that the system is in fail-safe mode.	Restart the system. If the problem persists, see the Getting help section.
Blinking amber	Indicates that the iDRAC Quick Sync 2 hardware is not responding properly.	Restart the system. If the problem persists, see the Getting help section.

Enhanced Preboot System Assessment

If you experience a problem with your system, run the system diagnostics before contacting Dell for technical assistance. The purpose of running system diagnostics is to test your system hardware without requiring more equipment or risking data loss. If you are unable to fix the problem yourself, service and support personnel can use the diagnostics results to help you solve the problem.

Dell Embedded system diagnostics

NOTE: The Dell Embedded System Diagnostics is also known as Enhanced Preboot System Assessment (ePSA) diagnostics.

The embedded system diagnostics provides a set of options for particular device groups or devices allowing you to:

- Run tests automatically or in an interactive mode.
- Repeat tests
- Display or save test results.
- Introduce more test options for extra information about the failed devices, run a thorough test.
- View status messages that inform you if tests are completed successfully.
- View error messages that inform you of problems encountered during testing.

Running the Embedded system diagnostics from Boot Manager

To run the embedded system diagnostics from Boot Manager:

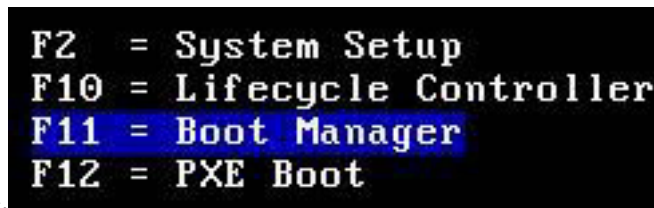

1. As the system boots, press <F11>.
2. Using the arrow keys select **System Utilities** → **Launch Diagnostics**.

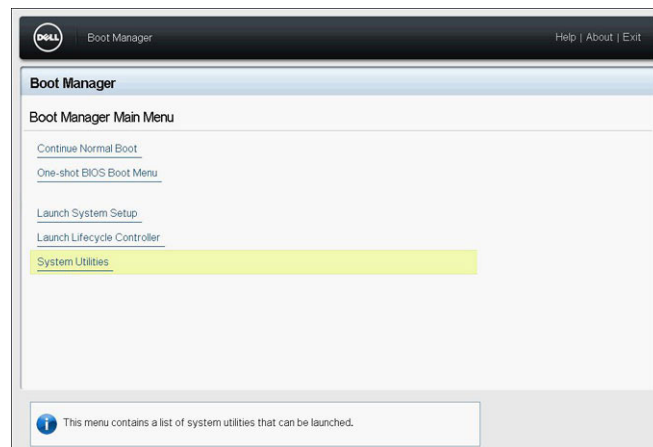

Figure 9. Boot Manager Main Menu

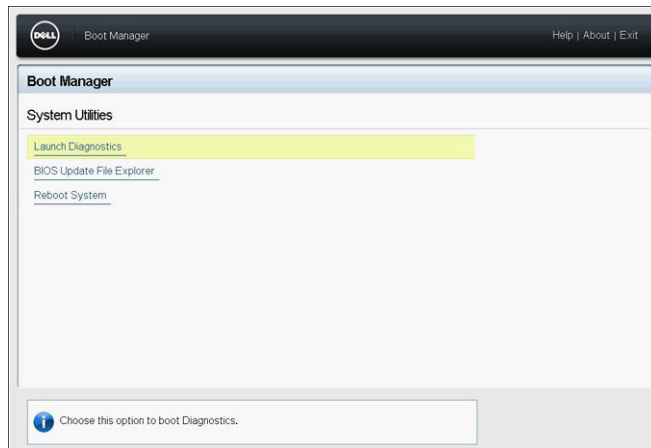

Figure 10. System Utilities

3. Wait while the Quick Tests automatically run.

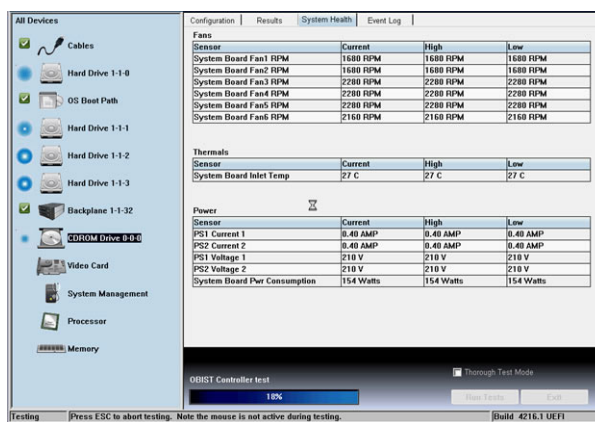
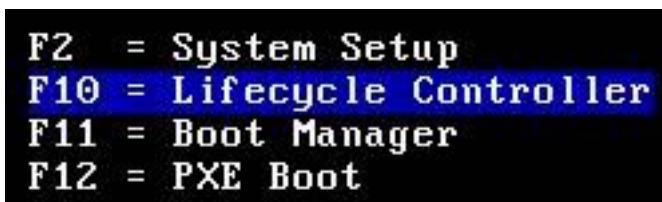

Figure 11. Quick Test

4. Once the tests have been completed, you can view the results and additional information on the **Results** tab, the **System Health** tab, the **Configuration** tab, and the **Event Log** tab.
5. Close the **Embedded System Diagnostics** utility.
6. To leave the diagnostics, click **Exit**.
7. Click **OK** when prompted, and the system reboots.

Running the Embedded System Diagnostics from the Dell Lifecycle Controller

To run the embedded system diagnostics from the Dell Lifecycle Controller:



1. As the system boots, press **F10**.

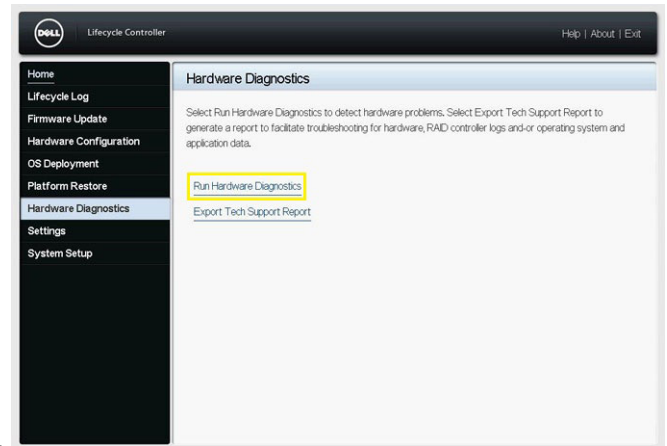

2. Select **Hardware Diagnostics** → **Run Hardware Diagnostics**.

Jumpers and connectors

System board jumpers and connectors

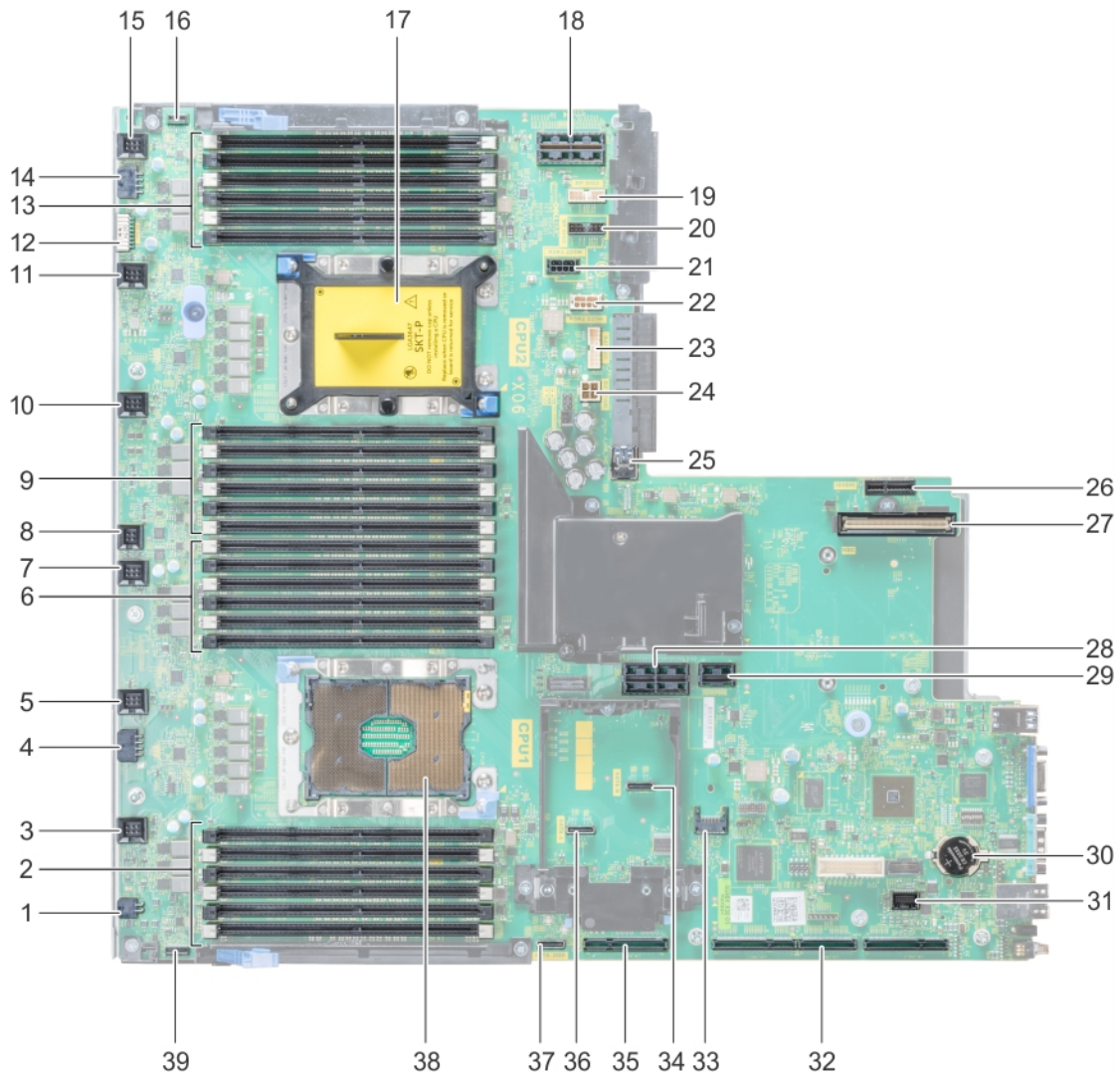

Figure 12. System board jumpers and connectors

Table 24. System board jumpers and connectors

Item	Connector	Description
1	J_ODD	Optical drive power connector
2	A7, A1, A8, A2, A9, A3	Memory module sockets
3	J_FAN2U_6	Cooling fan 6 connector
4	J_BP3	Backplane 3 power connector
5	J_FAN2U_5	Cooling fan 5 connector
6	A6, A12, A5, A11, A4, A10	Memory module sockets
7	J_FAN2U_4	Cooling fan 4 connector
8	INTRUSION_DET	Intrusion switch connector
9	B7, B1, B8, B2, B9, B3	Memory module sockets
10	J_FAN2U_3	Cooling fan 3 connector
11	J_FAN2U_2	Cooling fan 2 connector
12	J_BP_SIG1	Backplane 1 signal connector
13	B6, B12, B5, B11, B4, B10	Memory module sockets
14	J_BP1	Backplane 1 power connector
15	J_FAN2U_1	Cooling fan 1 connector
16	P_LFT_CP	Left control panel connector
17	CPU2	CPU2 processor and heat sink module socket (with dust cover)
18	J_R3_X24	Riser 3 connector
19	J_BP_SIG2	Backplane 2 signal connector
20	J_BP_SIG0	Backplane 0 signal connector
21	J_BP0 (RSR3_225W)	Backplane 0 power connector (Riser 3 PCIe 225 W power)
22	J_BP2 (RSR2_225W)	Backplane 2 power connector (Riser 2 PCIe 225 W power)
23	J_BATT_SIG	NVDIMM-N battery signal connector
24	J_BATT_PWR	NVDIMM-N battery power connector
25	J_USB_INT	Internal USB connector
26	J_IDSDM	IDSMD/vFlash connector
27	J_NDC	NDC connector
28	J_R2_X24_IT9	Riser 2 connector
29	J_R2_3R_X8_IT9	Riser 2 connector
30	BATTERY	Battery connector
31	J_FRONT_VIDEO	Video connector
32	J_R1_SS82_3 and J_R1_SS60_1	Riser 1 connector
33	J_TPM_MODULE	TPM connector
34	J_SATA_B	SATA B connector
35	J_R1_SS82_1	Riser 1 connector (Mini PERC option)





Table 24. System board jumpers and connectors (continued)

Item	Connector	Description
36	J_SATA_A	SATA A connector
37	J_SATA_C	SATA C connector (Optical drive SATA connector)
38	CPU1	CPU1 processor and heat sink module
39	P_RGT_CP	Right control panel connector

System board jumper settings

For information on resetting the password jumper to disable a password, see the Disabling a forgotten password section.

Table 25. System board jumper settings

Jumper	Setting	Description
PWRD_EN	 2 4 6 (default)	The BIOS local access is protected with the software security features.
	 2 4 6	The BIOS local access security features are unlocked on the next AC power cycle.
NVRAM_CLR	 1 3 5 (default)	The BIOS configuration settings are retained at system boot.
	 1 3 5	The BIOS configuration settings are cleared at system boot.

Disabling forgotten password

The software security features of the system include a system password and a setup password. The password jumper enables or disables password features and clears any password(s) currently in use.

Prerequisites

CAUTION: Many repairs may only be done by a certified service technician. You should only perform troubleshooting and simple repairs as authorized in your product documentation, or as directed by the online or telephone service and support team. Damage due to servicing that is not authorized by Dell is not covered by your warranty. Read and follow the safety instructions that are shipped with your product.

Steps

1. Turn off the system, including any attached peripherals, and disconnect the system from the electrical outlet.
2. Remove the system cover.
3. Move the jumper on the system board jumper from pins 2 and 4 (default) to pins 4 and 6.
4. Install the system cover.

The existing passwords are not disabled (erased) until the system boots with the jumper on pins 4 and 6. However, before you assign a new system and/or setup password, you must move the jumper back to pins 2 and 4.

NOTE: If you assign a new system and/or setup password with the jumper on pins 4 and 6, the system disables the new password(s) the next time it boots.

5. Reconnect the system to its electrical outlet and turn on the system, including any attached peripherals.
6. Turn off the system, including any attached peripherals, and disconnect the system from the electrical outlet.
7. Remove the system cover.
8. Move the jumper on the system board jumper from pins 4 and 6 to pins 2 and 4 (default).
9. Install the system cover.
10. Reconnect the system to its electrical outlet and turn on the system, including any attached peripherals.

11. Assign a new system and/or setup password.

Disassembly and reassembly

The following sections contain the procedures for removing and replacing system components.

Front Bezel

Removing the optional front bezel

Steps

1. Locate and remove the bezel key.
NOTE: The bezel key is attached to the LCD bezel package.
2. Unlock the bezel by using the key.
3. Press the release button to release the bezel, and pull the left end of the bezel.
4. Unhook the right end, and remove the bezel.

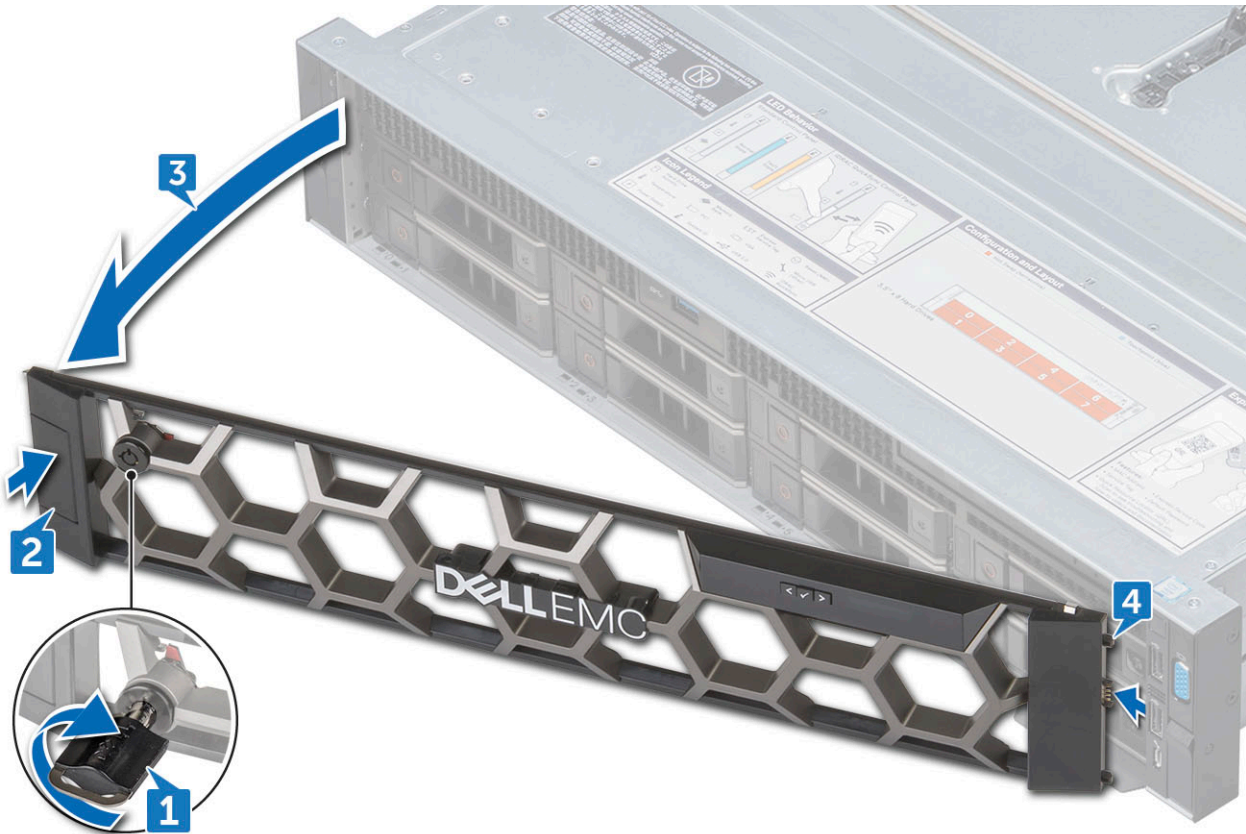

Installing the optional front bezel

Steps

1. Locate and remove the bezel key.
NOTE: The bezel key is attached to the LCD bezel package.
2. Align and insert the right end of the bezel onto the system .

3. Press the release button and fit the left end of the bezel onto the system.
4. Lock the bezel by using the key.

System cover

Removing system cover

Prerequisites

1. Turn off the system, including any attached peripherals.
2. Disconnect the system from the electrical outlet and disconnect the peripherals.

Steps

1. Using a flat head screwdriver, rotate the latch release lock counter clockwise to the unlocked position.
2. Lift the latch till the system cover slides back and the tabs on the system cover disengage from the slots on the system.
3. Hold the cover on both sides, and lift the cover away from the system.



Installing system cover

Prerequisites

1. Ensure that all internal cables are routed correctly and connected, and no tools or extra parts are left inside the system.

Steps

1. Align the tabs on the system cover with the slots on the system.
2. Push the system cover latch down.
3. Using a flat head screwdriver, rotate the latch release lock clockwise to the locked position.

Next steps

1. Reconnect the peripherals and connect the system to the electrical outlet.
2. Turn on the system, including any attached peripherals.

Optical drive

Removing optical drive

Prerequisites

1. If installed, remove the front bezel.
2. Remove the system cover.

Steps

1. Disconnect the optical drive cable from the optical drive.
2. Press the blue latch and slide the optical drive from the system.

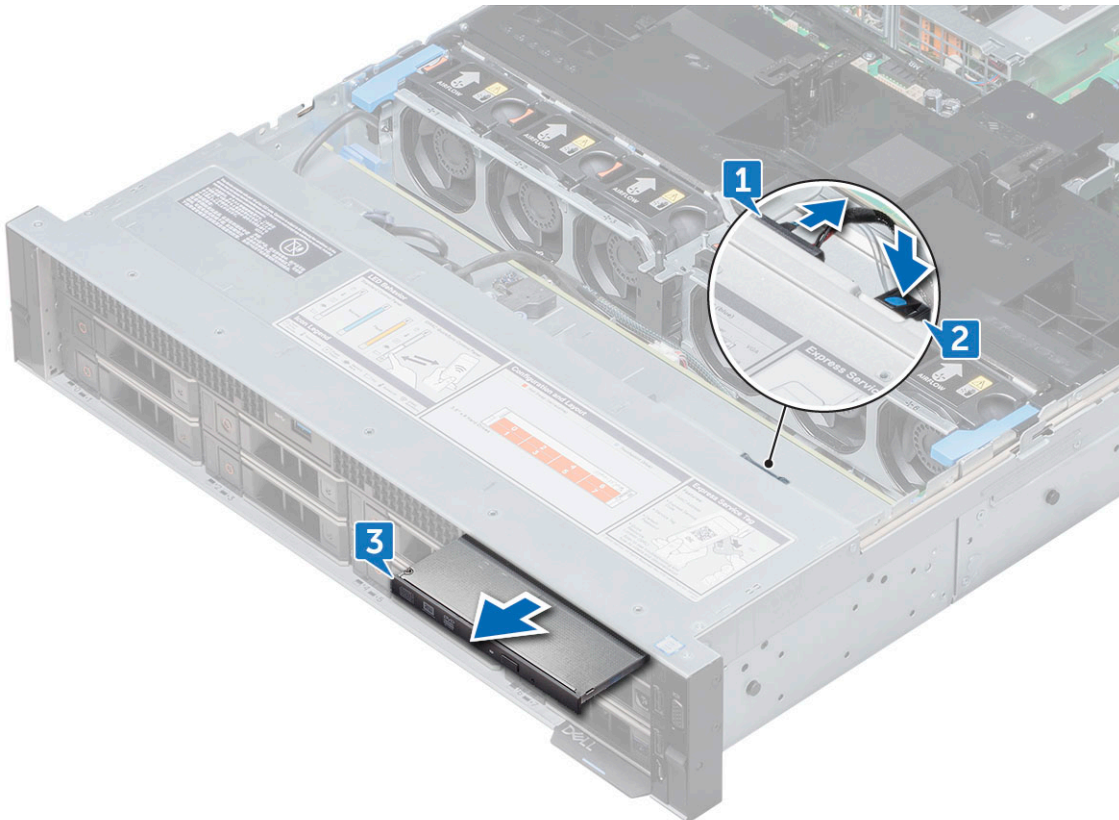

Next steps

Install the optical drive.

Installing optical drive

Steps

1. Slide the optical drive to the system, until the locks into place.
2. Connect the optical drive cable on the optical drive.
3. Install system cover and front bezel if applicable.

Air shroud

Removing air shroud

Prerequisites

CAUTION:

Never operate your system with the air shroud removed. The system may get overheated quickly, resulting in shutdown of the system and loss of data.

1. If installed, remove the full length PCIe cards.
2. If applicable, remove the GPU cards.

Steps

Hold the shroud at both ends and lift it away from the system.

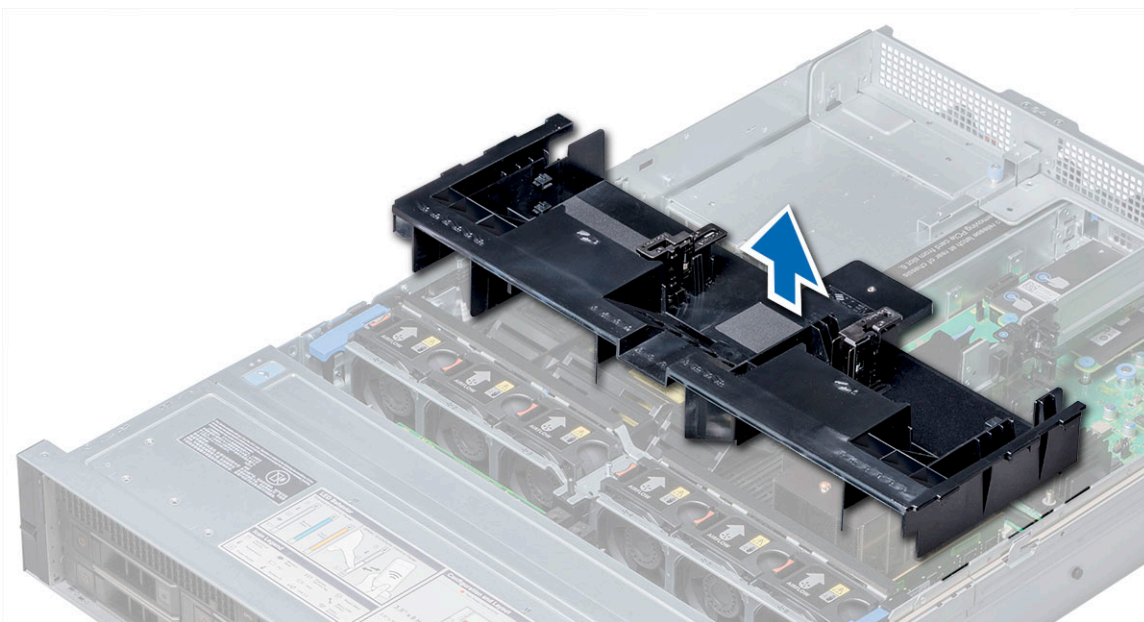

Next steps

Install the shroud.

Installing air shroud

Prerequisites

1. If applicable, route the cables inside the system along the system wall and secure the cables by using the cable securing bracket.

Steps

1. Align the tabs on the air shroud with the slots on the system.
2. Lower the air shroud into the system until it is firmly seated.
When firmly seated, the memory socket numbers marked on the air shroud align with the respective memory sockets.

Next steps

1. If removed, install the full length PCIe cards.
2. If applicable, install the GPU cards.

Cooling fan assembly

Removing cooling fan assembly

Steps

1. Lift the release levers to unlock the cooling fan assembly from the system.
2. Hold the release levers and lift the cooling fan assembly away of the system.

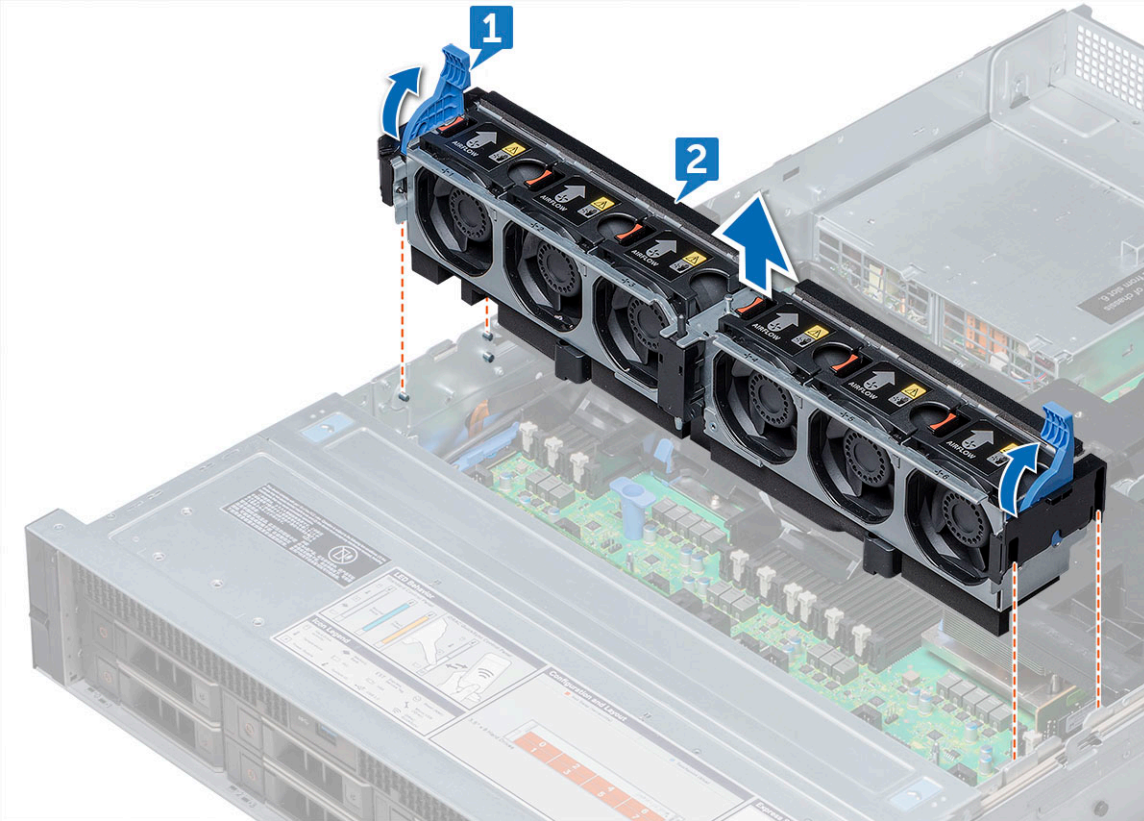

Installing cooling fan assembly

Steps

1. Align the guide rails on the cooling fan assembly with the standoffs on the system.
2. Lower the cooling fan assembly into the system until the cooling fan connectors engage with the connectors on the system board.
3. Press the release levers to lock the cooling fan assembly into the system.

Cooling fans

Removing cooling fan

Prerequisites

NOTE: Opening or removing the system cover when the system is ON may expose you to a risk of electric shock. Exercise utmost care while removing or installing cooling fans.

NOTE: The system will shutdown if the system cover is removed before shutting down the system

CAUTION: The cooling fans are hot swappable. To maintain proper cooling while the system is on, replace only one fan at a time.

Steps

Press the release tab and lift the cooling fan out of the cooling fan assembly.

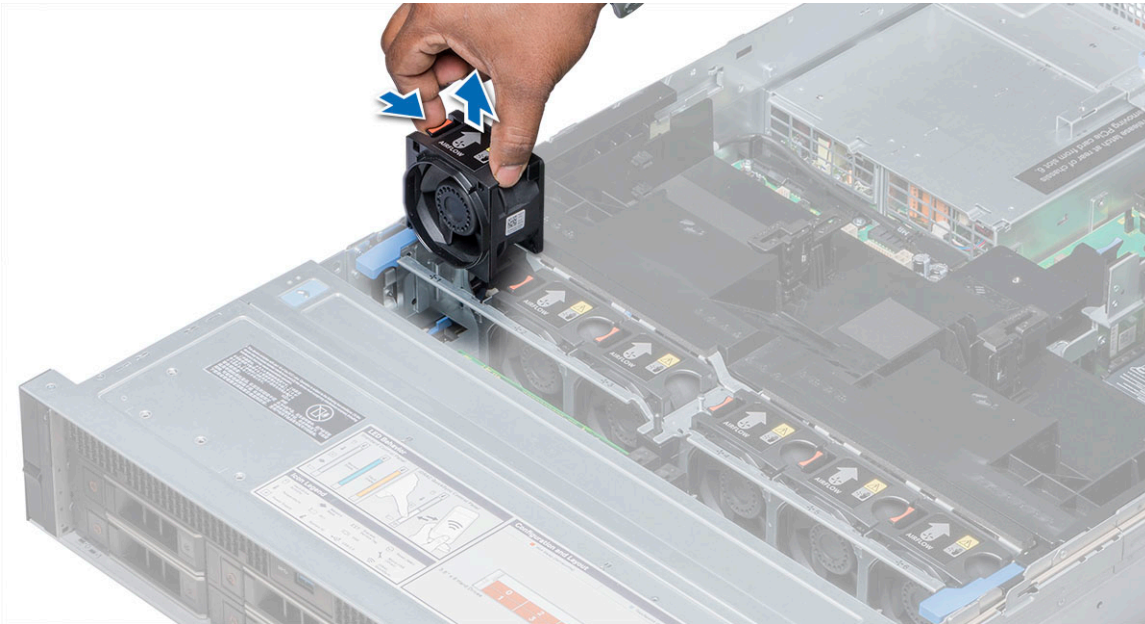

Installing cooling fan

Steps

1. Holding the release tab, align the connector at the base of the cooling fan with the connector on the system board.
2. Slide the cooling fan into the cooling fan assembly until the release tab locks into place.

Intrusion switch

Removing intrusion switch

Prerequisites

1. Remove the cooling fan assembly.

Steps

Press the intrusion switch and slide it out of the from the intrusion switch slot.

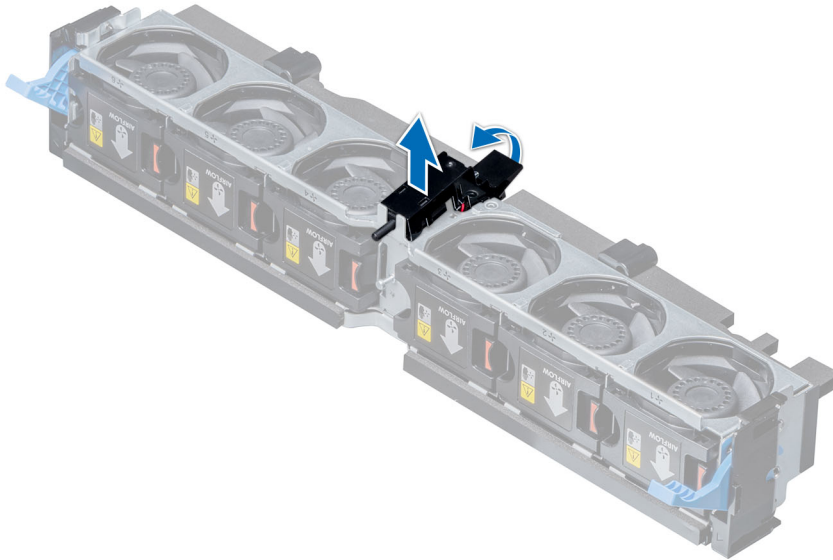

Installing intrusion switch

Steps

1. Align the tabs on the intrusion switch with the slots on the cooling fan assembly.
2. Pull the intrusion switch up and push it until the switch locks in place.

Next steps

1. Install the cooling fan assembly.

Hard drive

Removing hard drive blank

Prerequisites

1. If installed, remove the front bezel.

 **CAUTION: To maintain proper system cooling, all empty hard drive slots must have hard drive blanks installed.**

Steps

Press the release button and slide the hard drive blank out of the hard drive slot.

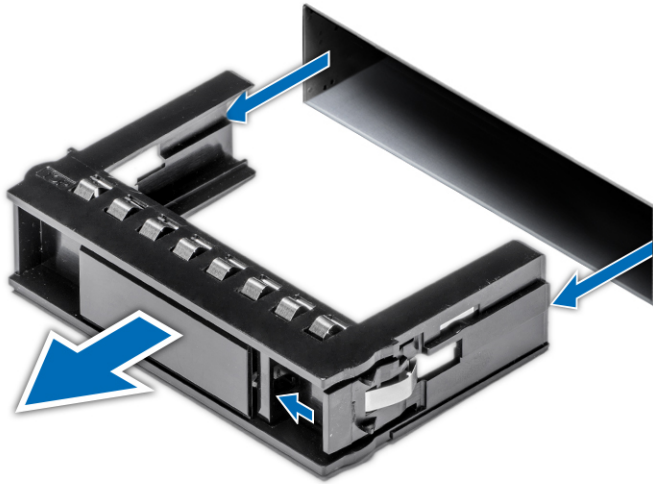

Installing hard drive blank

Steps

Insert the hard drive blank into the hard drive slot and push until the release button clicks into place.

Next steps

1. If removed, install the front bezel.

Removing hard drive

Prerequisites

1. If applicable, remove the front bezel.
2. Using the management software, prepare the hard drive for removal. If the hard drive is online, the green activity or fault indicator flashes while the drive is turning off. When the hard drive indicators are off, the hard drive is ready for removal. For more information, see the documentation for the storage controller.

CAUTION: To prevent data loss, ensure that your operating system supports hot swappable drive installation. See the documentation supplied with your operating system.

CAUTION: Before attempting to remove or install a hard drive while the system is running, see the documentation for the storage controller card to ensure that the host adapter is configured correctly to support hard drive removal and insertion.

CAUTION: Mixing hard drives from previous generations of Precision Workstations is not supported.

Steps

1. Press the release button to open the hard drive release handle.
2. Holding the handle, slide the hard drive out of the hard drive slot.

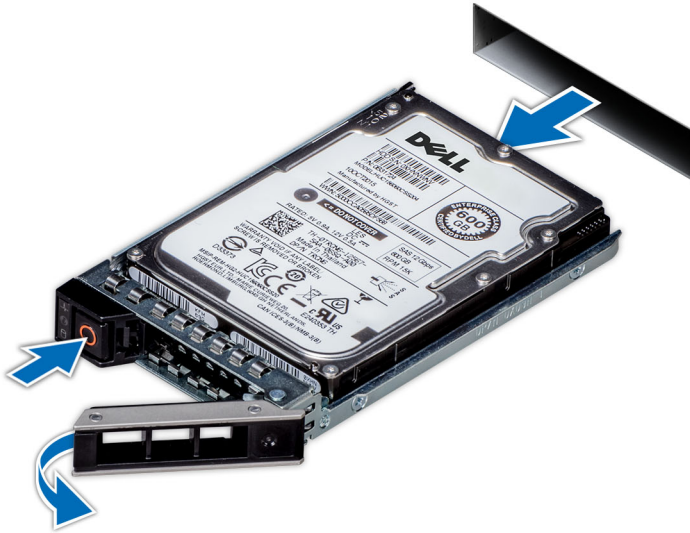

Next steps

Install the hard drive.

i **NOTE:** If you are not replacing the hard drive immediately, insert a hard drive blank in the empty hard drive slot.

Installing hard drive

Prerequisites

⚠ CAUTION: When installing a hard drive, ensure that the adjacent drives are fully installed. Inserting a hard drive carrier and attempting to lock its handle next to a partially installed carrier can damage the partially installed carrier's shield spring and make it unusable.

i **NOTE:** To prevent data loss, ensure that your operating system supports hot-swap drive installation. See the documentation supplied with your operating system.

i **NOTE:** When a replacement hot swappable hard drive is installed and the system is powered on, the hard drive automatically begins to rebuild. Make absolutely sure that the replacement hard drive is blank or contains data that you wish to have over-written. Any data on the replacement hard drive is immediately lost after the hard drive is installed.

Steps

1. Press the release button on the front of the hard drive to open the release handle.
2. Insert the hard drive into the hard drive slot until the hard drive connects with the backplane.
3. Close the hard drive handle to lock the hard drive in place.



Figure 13. Installing hard drive

Next steps

If applicable, install the front bezel.

Removing 3.5 inch hard drive from hard drive carrier

Steps

1. Using Phillips #1 screwdriver, remove the screws from the slide rails on the hard drive carrier.
2. Lift the hard drive out of the hard drive carrier.



Next steps

Install hard drive into the hard drive carrier.

Installing 3.5 inch hard drive into hard drive carrier

Steps

1. Insert the hard drive into the hard drive carrier with the connector end of the hard drive toward the back of the carrier.
2. Align the screw holes on the hard drive with the screws holes on the hard drive carrier.
When aligned correctly, the back of the hard drive is flush with the back of the hard drive carrier.
3. Using the Phillips #1 screwdriver, tighten the screws to secure the hard drive to the hard drive carrier.



Removing hard drive

Prerequisites

1. If applicable, remove the front bezel.
2. Using the management software, prepare the hard drive for removal. If the hard drive is online, the green activity or fault indicator flashes while the drive is turning off. When the hard drive indicators are off, the hard drive is ready for removal. For more information, see the documentation for the storage controller.

CAUTION: To prevent data loss, ensure that your operating system supports hot swappable drive installation. See the documentation supplied with your operating system.

CAUTION: Before attempting to remove or install a hard drive while the system is running, see the documentation for the storage controller card to ensure that the host adapter is configured correctly to support hard drive removal and insertion.

CAUTION: Mixing hard drives from previous generations of Precision Workstations is not supported.

Steps

1. Press the release button to open the hard drive release handle.
2. Holding the handle, slide the hard drive out of the hard drive slot.

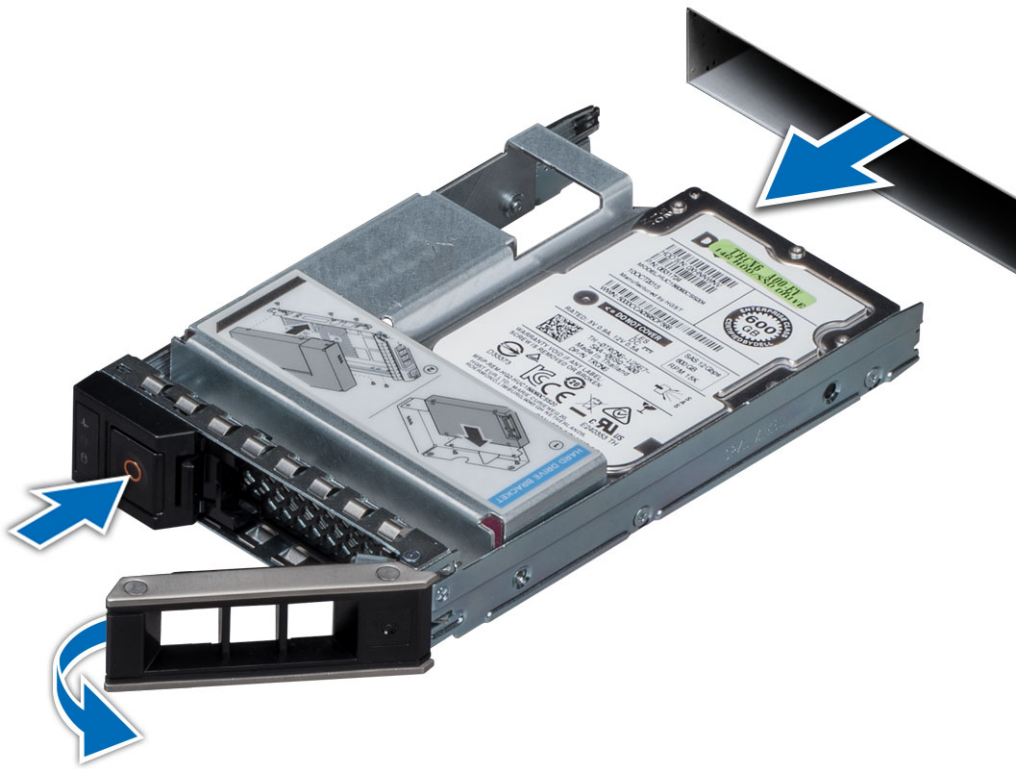

Next steps

Install the hard drive.

i **NOTE:** If you are not replacing the hard drive immediately, insert a hard drive blank in the empty hard drive slot.

Installing 2.5 inch hard drive

Prerequisites

⚠ CAUTION: When installing a hard drive, ensure that the adjacent drives are fully installed. Inserting a hard drive carrier and attempting to lock its handle next to a partially installed carrier can damage the partially installed carrier's shield spring and make it unusable.

i **NOTE:** To prevent data loss, ensure that your operating system supports hot-swap drive installation. See the documentation supplied with your operating system.

i **NOTE:** When a replacement hot swappable hard drive is installed and the system is powered on, the hard drive automatically begins to rebuild. Make absolutely sure that the replacement hard drive is blank or contains data that you wish to have over-written. Any data on the replacement hard drive is immediately lost after the hard drive is installed.

Steps

1. Press the release button on the front of the hard drive to open the release handle.
2. Insert the hard drive into the hard drive slot until the hard drive connects with the backplane.
3. Close the hard drive handle to lock the hard drive in place.

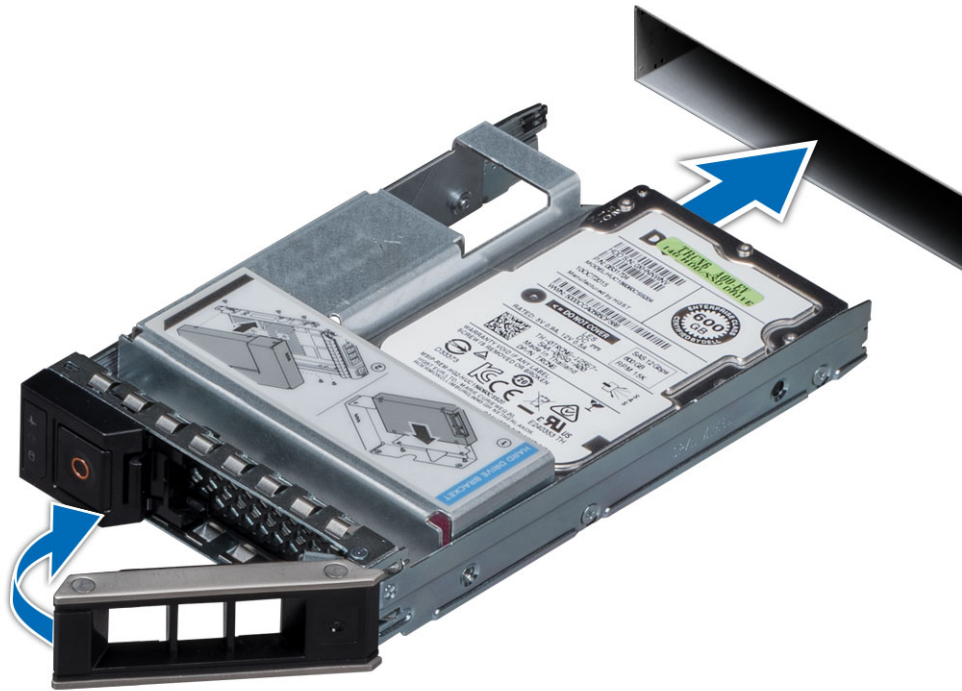

Figure 14. Installing hard drive

Next steps

If applicable, install the front bezel.

Removing 2.5 inch hard drive from 3.5 inch hard drive carrier

Steps

1. Using Phillips #1 screwdriver, remove the screws from the slide rails on the 3.5 inch hard drive carrier and lift the hard drive.

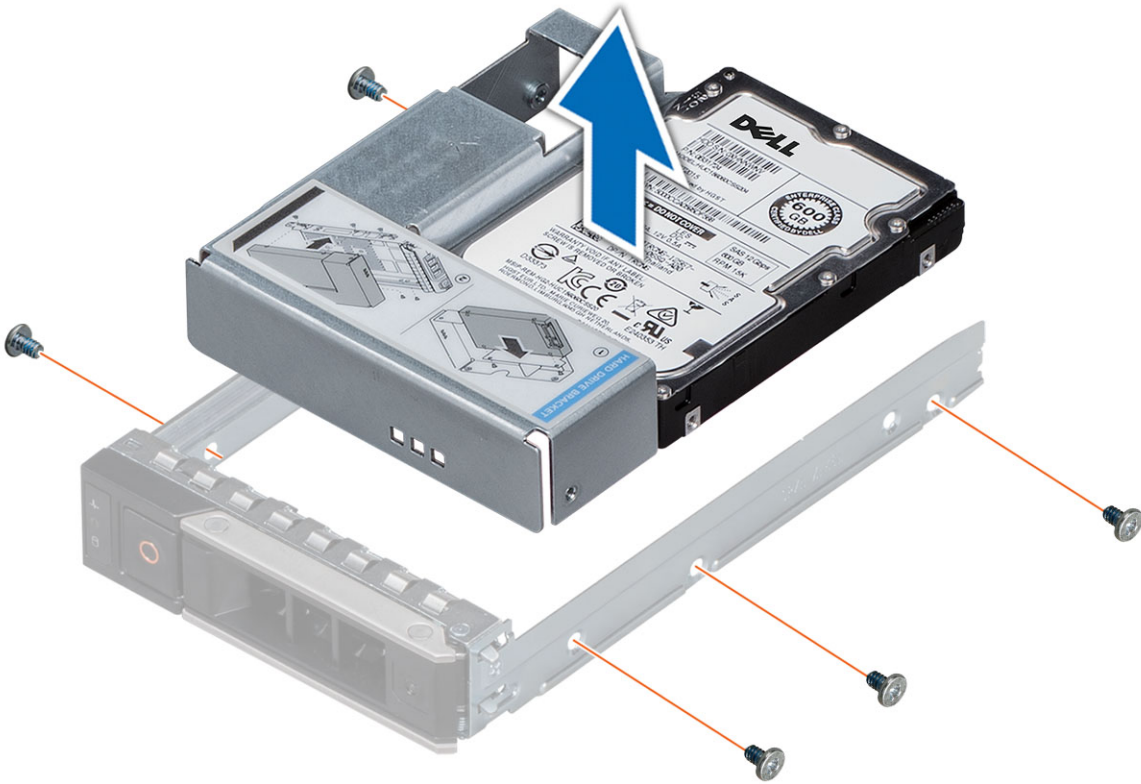

2. Remove the screws that secures 2.5 inch hard drive to the hard drive assembly and remove the hard drive.

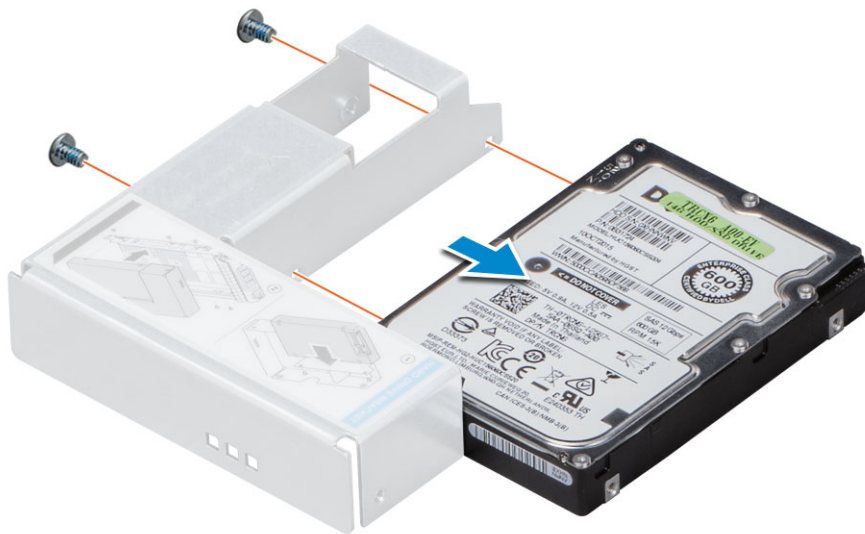

Next steps

Install hard drive into the hard drive carrier.

Installing 2.5 inch hard drive into 3.5 inch hard drive carrier

Steps

1. Insert the 2.5 inch hard drive into the hard drive carrier and tighten the screws.

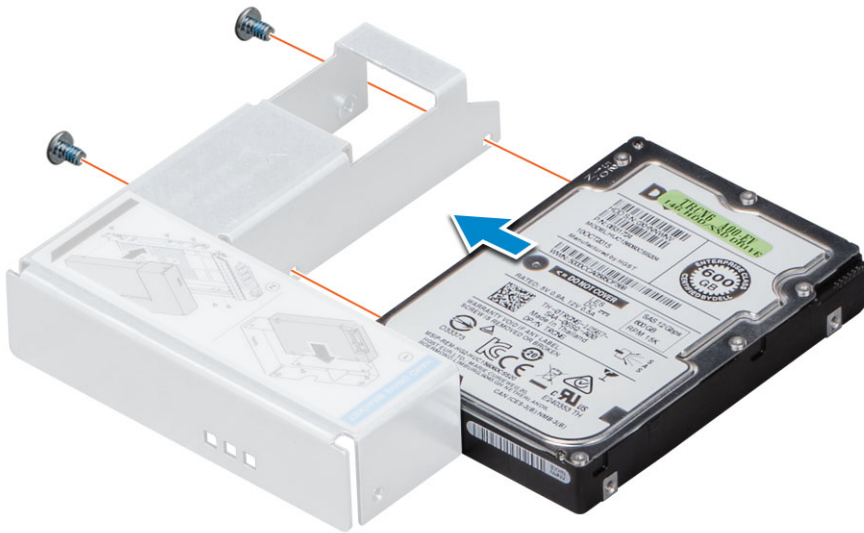

2. Place the 2.5 inch hard drive into the 3.5 inch hard drive carrier.
3. Align the screw holes on the hard drive with the screws holes on the hard drive carrier.

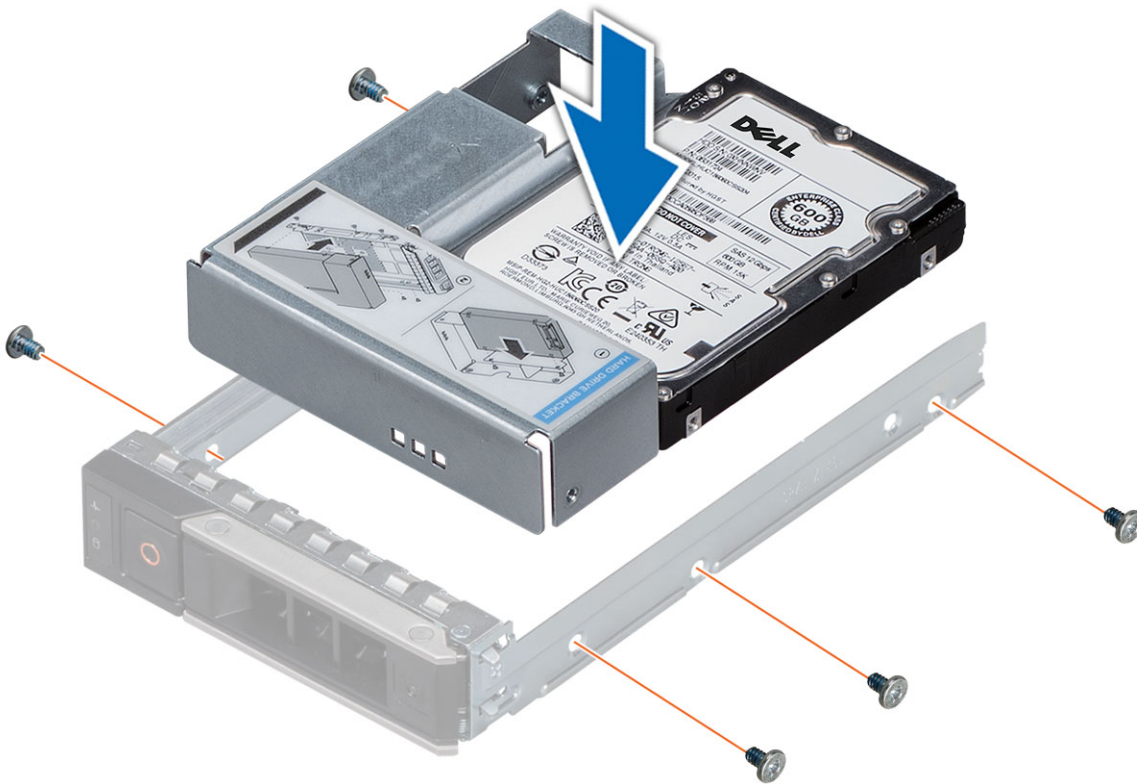

Memory modules

Removing memory modules

Prerequisites

1. If applicable, remove the air shroud.

⚠ WARNING: Allow the memory modules to cool after you power off the system. Handle the memory modules by the card edges and avoid touching the components or metallic contacts on the memory module.

CAUTION: To ensure proper system cooling, memory module blanks must be installed in any memory socket that is not occupied. Remove memory module blanks only if you intend to install memory modules in those sockets.

Steps

1. Locate the appropriate memory module socket.
2. Push the ejectors outward on both ends of the memory module socket, to release the memory module from the socket.

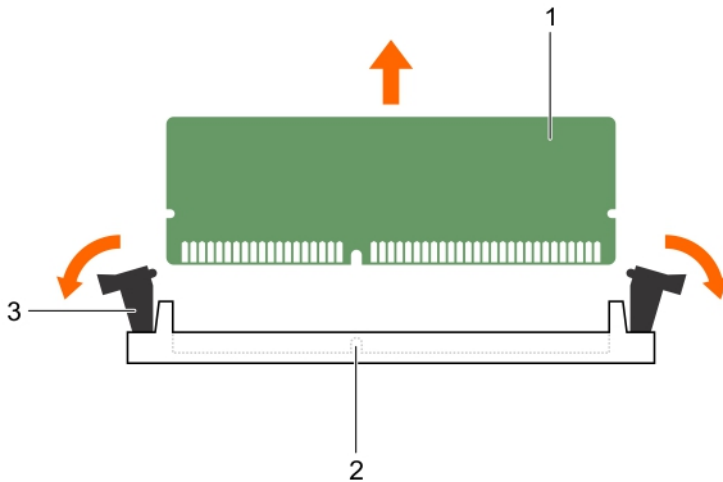

3. Lift and remove the memory module from the system.

Installing memory modules

Steps

1. Locate the appropriate memory module socket.
2. Open the ejectors on the memory module socket outward to allow the memory module to be inserted into the socket.
3. Align the edge connector of the memory module with the alignment key of the memory module socket, and insert the memory module in the socket.

CAUTION: Do not apply pressure at the center of the memory module; apply pressure at both ends of the memory module evenly.

NOTE: The memory module socket has an alignment key that enables you to install the memory module in the socket in only one orientation.

4. Press the memory module with your thumbs until the socket levers firmly click into place.
5. Repeat step 1 through step 4 of this procedure to install the remaining memory modules.

Next steps

1. If applicable, install the air shroud.
2. To verify if the memory module has been installed properly, press F2 and navigate to **System Setup Main Menu > System BIOS > Memory Settings**. In the Memory Settings screen, the System Memory Size must reflect the updated capacity of the installed memory.
3. If the value is incorrect, one or more of the memory modules may not be installed properly. Ensure that the memory module is firmly seated in the memory module socket.
4. Run the system memory test in system diagnostics.

Processors and heat sinks

Removing processor and heat sink module

Steps

1. Using Torx #T30 screwdriver, loosen the screws.

NOTE: Ensure that the screw is completely loosened before moving on to the next screw.

2. Pushing both retention clips simultaneously, lift the processor heat sink module out of the system
3. Set the module aside with processor side facing up.

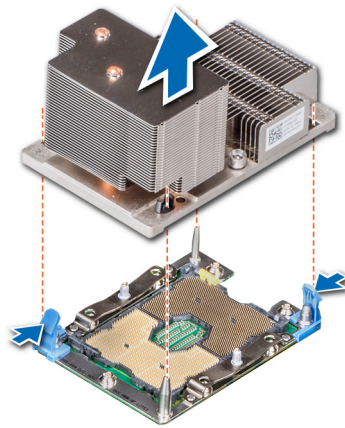
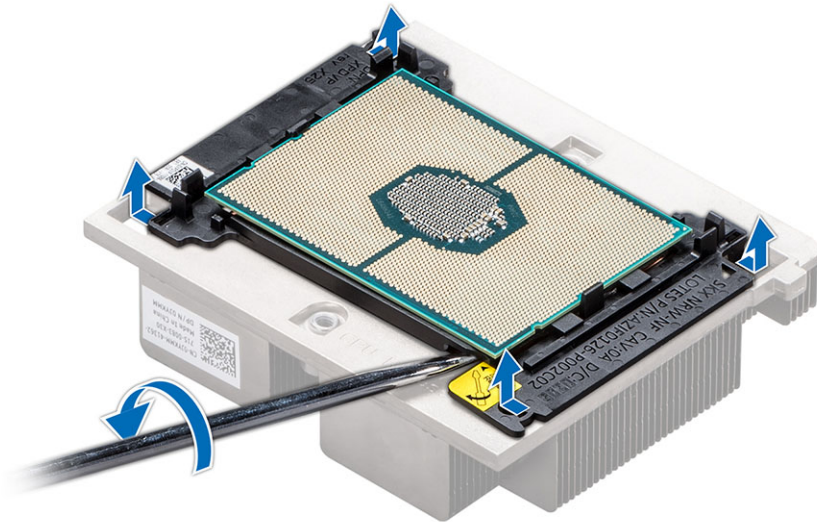

Figure 15. Removing heat sink (2U)

Removing processor from processor heat sink module

Steps

1. Place the heat sink with the processor side facing up.
2. Insert a flat blade screwdriver into the release slot marked with a yellow label. Twist (do not pry) the screwdriver to break the thermal paste seal.
3. Push the retaining clips on the processor bracket to unlock the bracket from the heat sink.



4. Lift the bracket and the processor away from the heat sink, and place the processor connector side down on the processor tray.
5. Flex the outer edges of the bracket to release the processor from the bracket.

NOTE: Ensure that the processor and the bracket are placed in the tray after you remove the heat sink.



Installing processor into processor heat sink module

Steps

1. Place the processor in the processor tray.

NOTE: Ensure that pin 1 indicator on the CPU tray is aligned with the pin 1 indicator on the processor.
2. Flex the outer edges of the bracket around the processor ensuring that the processor is locked into the clips on the bracket.

NOTE: Ensure pin 1 indicator on the bracket is aligned with the pin 1 indicator on the processor before placing the bracket on the processor.



Figure 16. Installing the processor bracket

3. If you are using an existing heat sink, remove the thermal grease from the heat sink by using a clean lint-free cloth.
4. Use the thermal grease syringe included with your processor kit to apply the grease in a spiral quadrilateral design on the top of the processor.

CAUTION: Applying too much thermal grease can result in excess grease coming in contact with and contaminating the processor socket.

NOTE: The thermal grease syringe is intended for single use only. Dispose the syringe after you use it.

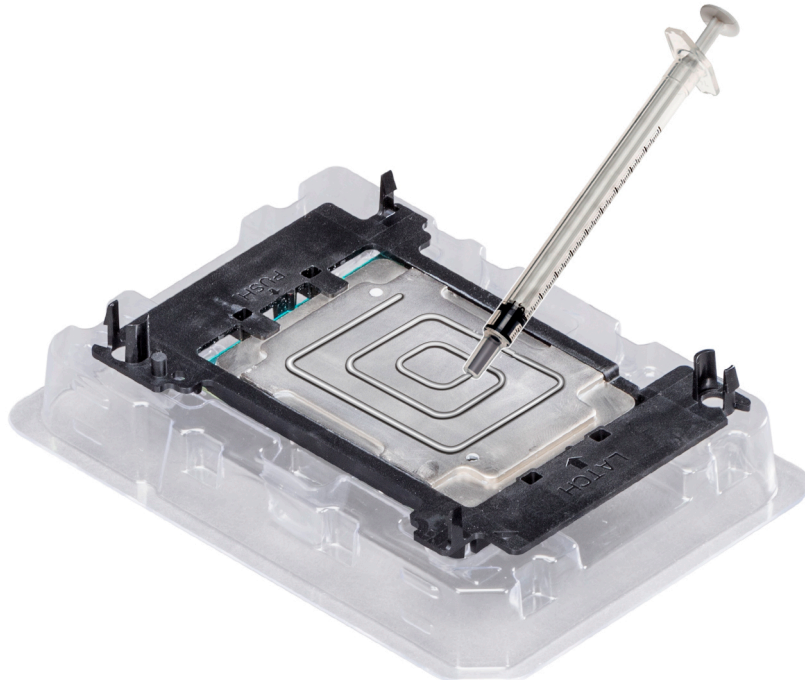
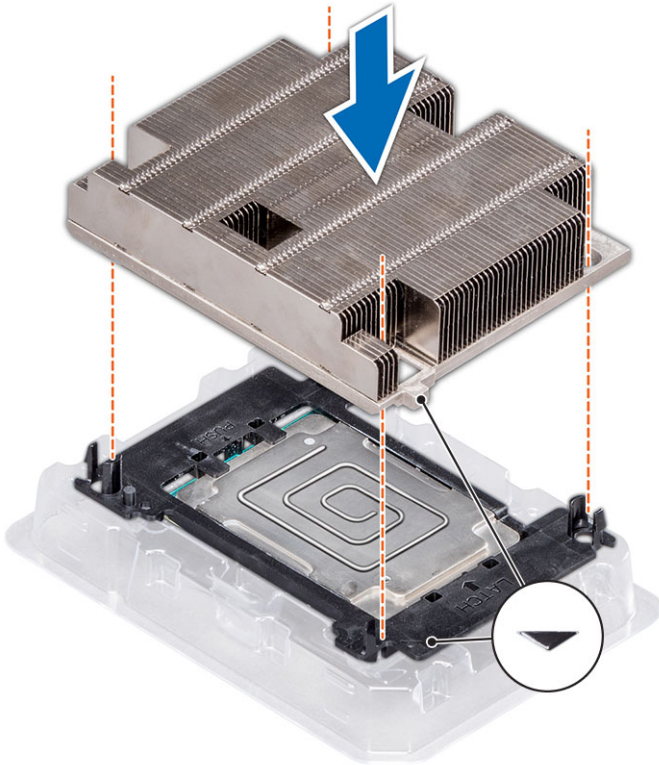

Figure 17. Applying thermal grease on top of the processor

5. Place the heat sink on the processor and push down until the bracket locks onto the heat sink.



i NOTE:

- Ensure that the two guide pin holes on the bracket match the guide holes on the heat sink.

Next steps

1. Install the processor and heat sink module.
2. Install air shroud.

Installing processor and heat sink module

Steps

1. Align the pin 1 indicator of the heat sink to the system board and then place the processor and heat sink module on the processor socket.

⚠ CAUTION: To avoid damaging the fins on the heat sink, do not press down on the heat sink fins.

i NOTE:

Ensure that the processor and heat sink is held parallel to the system board to prevent damaging the components.

2. Push the blue retention clips inward to allow the heat sink to drop into place.
3. Using the #Torx T30 screwdriver, tighten one screw at a time.

i NOTE:

Ensure that the screw is tightened completely before moving onto the next screw.

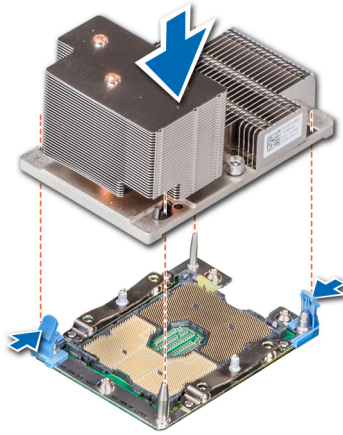

Figure 18. Installing the processor and heat sink module (2U)

Expansion card

Removing expansion card from expansion card riser

Prerequisites

1. If applicable, disconnect the cables from the expansion card.

Steps

1. Lift the expansion card latch out of the slot.
2. Hold the expansion card by its edges, and pull the card until the card edge connector disengages from the expansion card connector on the riser.

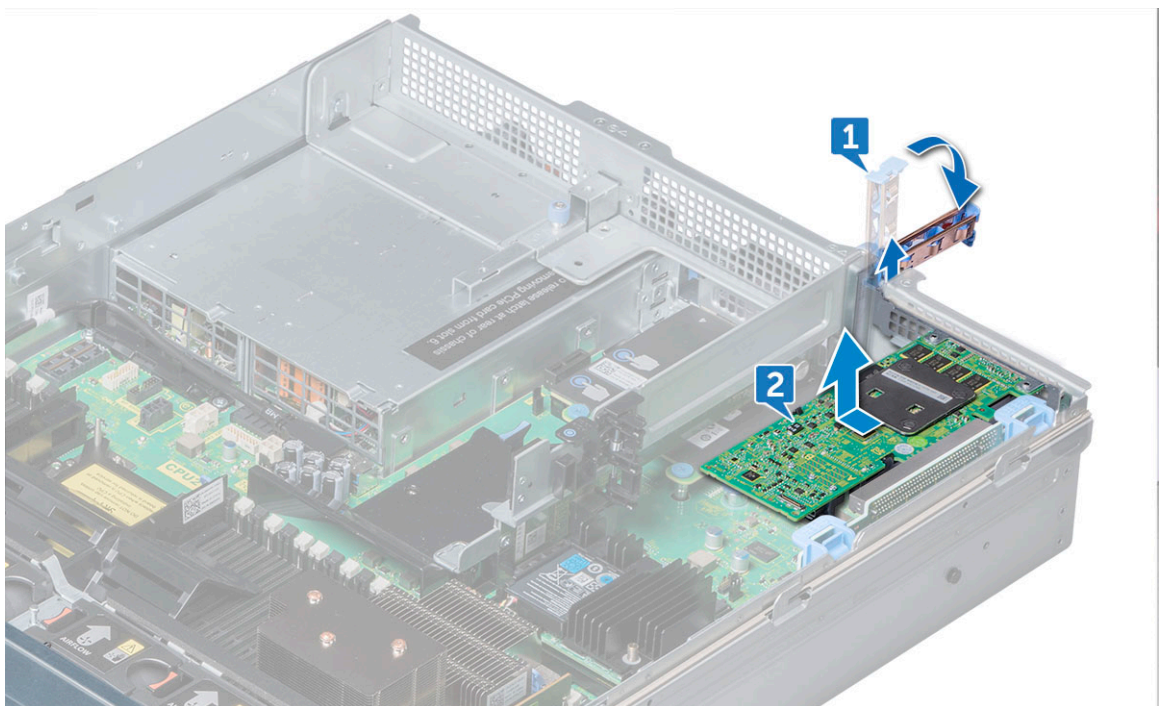

Figure 19. Removing expansion card from expansion card riser 1

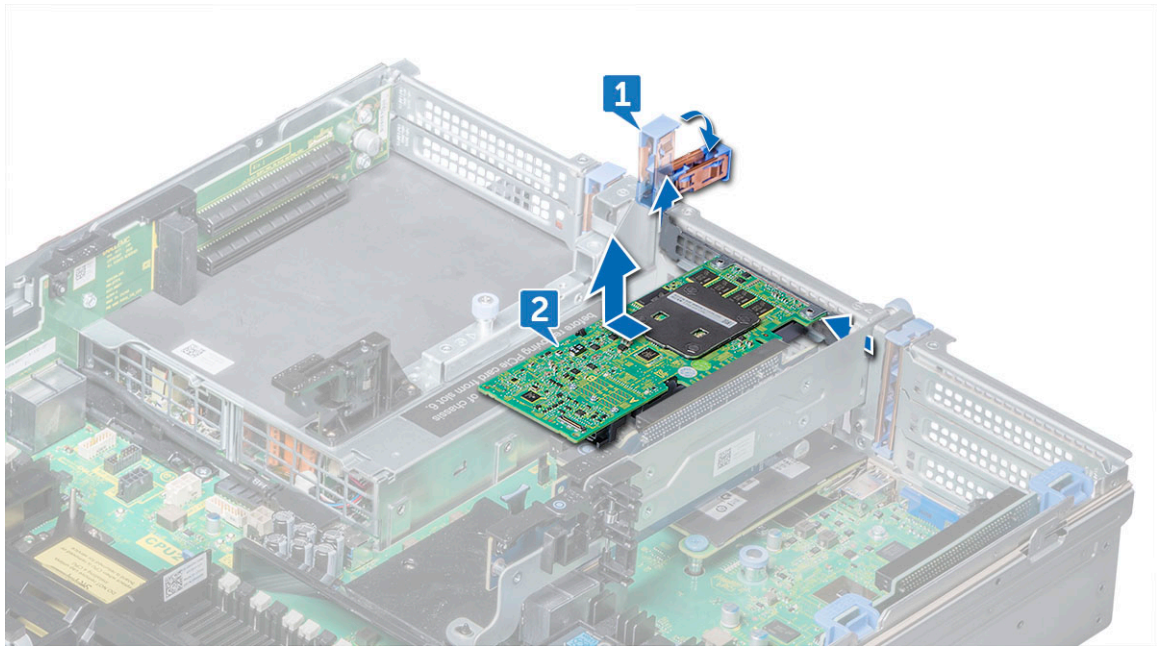

Figure 20. Removing expansion card from expansion card riser 2

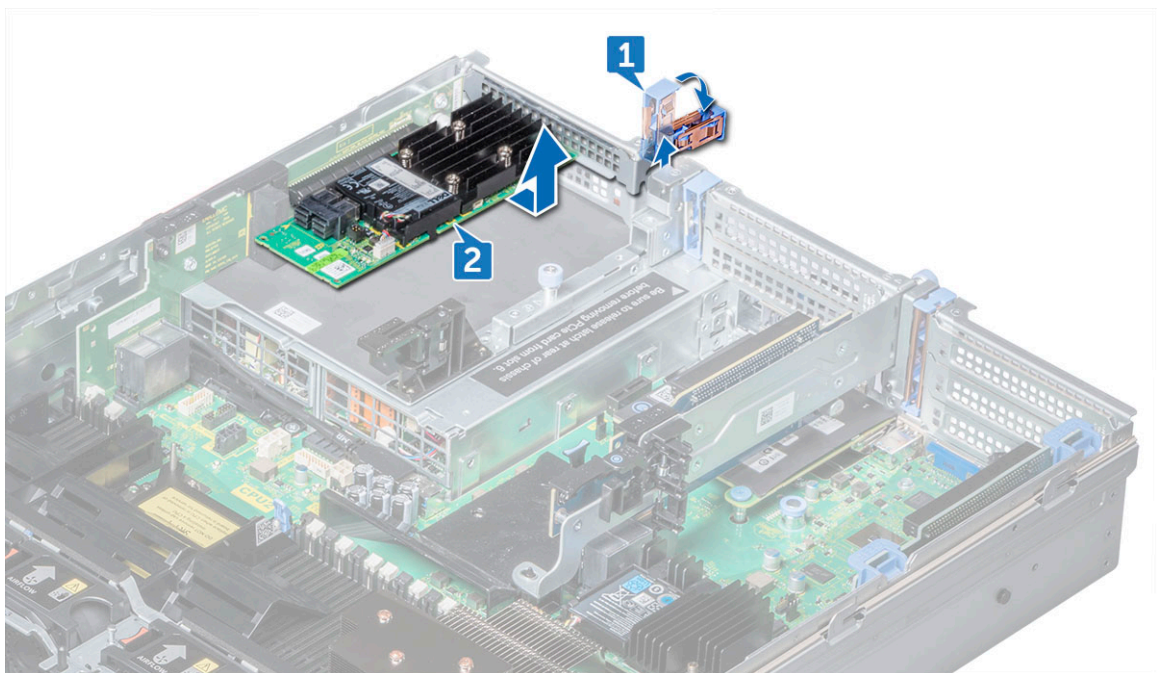

Figure 21. Removing expansion card from expansion card riser 3

3. If you are removing the card permanently, install a metal filler bracket over the empty expansion slot opening and close the expansion card latch.

NOTE: You must install a filler bracket over an empty expansion card slot to maintain Federal Communications Commission (FCC) certification of the system. The brackets also keep dust and dirt out of the system and aid in proper cooling and airflow inside the system.

4. Insert the expansion card latch into the slot to secure the bracket.

Installing expansion card into expansion card riser

Prerequisites

1. Unpack the expansion card and prepare it for installation.

NOTE: For instructions, see the documentation accompanying the card.

Steps

1. Lift the expansion card latch and remove the filler bracket.
2. Hold the card by its edges, and align the card edge connector with the expansion card connector on the riser.
3. Insert the card edge connector firmly into the expansion card connector until the card is fully seated.
4. Close the expansion card latch.

Next steps

1. If applicable, connect the cables to the expansion card.
2. Install any device drivers required for the card as described in the documentation for the card.

Opening and closing the full length PCIe card holder latch

About this task

NOTE: Before installing a full length PCIe card, the PCIe card holder latch must be open.

Steps

1. To open the PCIe card holder latch, press the release tab.
2. To close the PCIe card holder latch, rotate the latch until it locks.

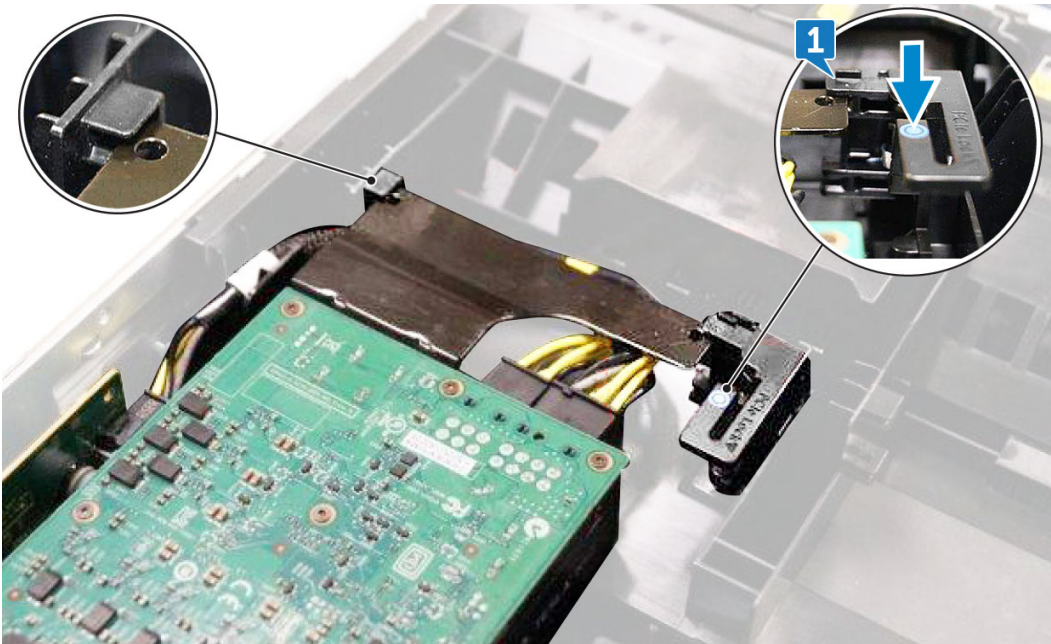

Removing expansion card riser 1

Prerequisites

1. If installed, remove expansion cards from the riser.
2. Disconnect any cables connected to the riser card.

About this task

NOTE: If installing a replacement expansion card riser 1 make sure the VROC key is transferred from the old card to the new card.

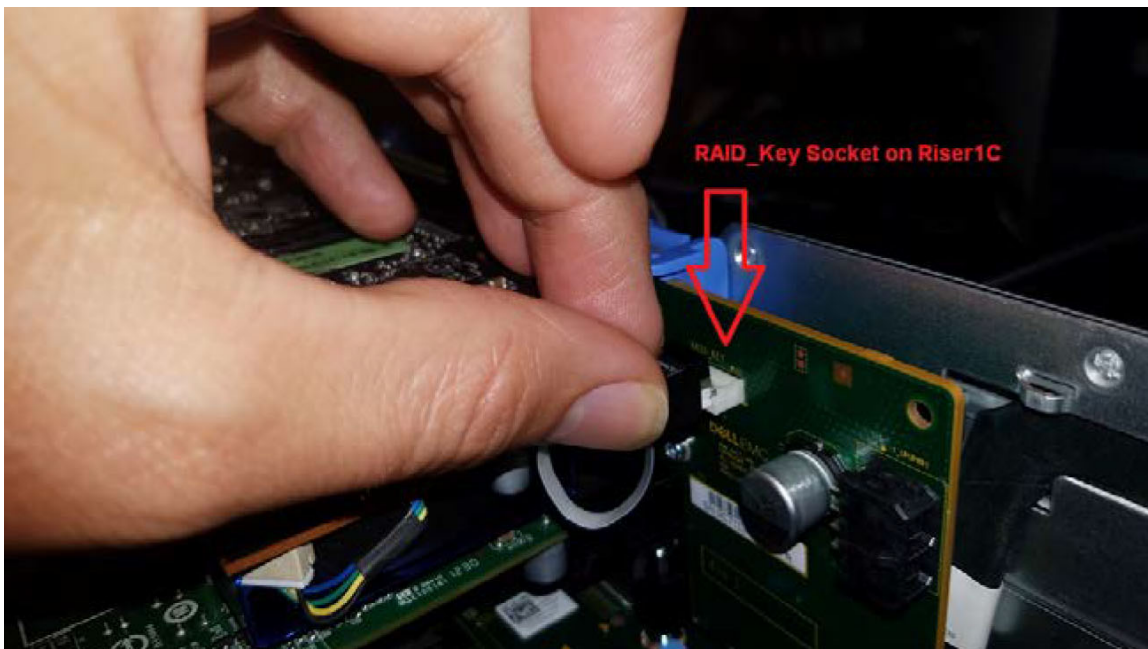
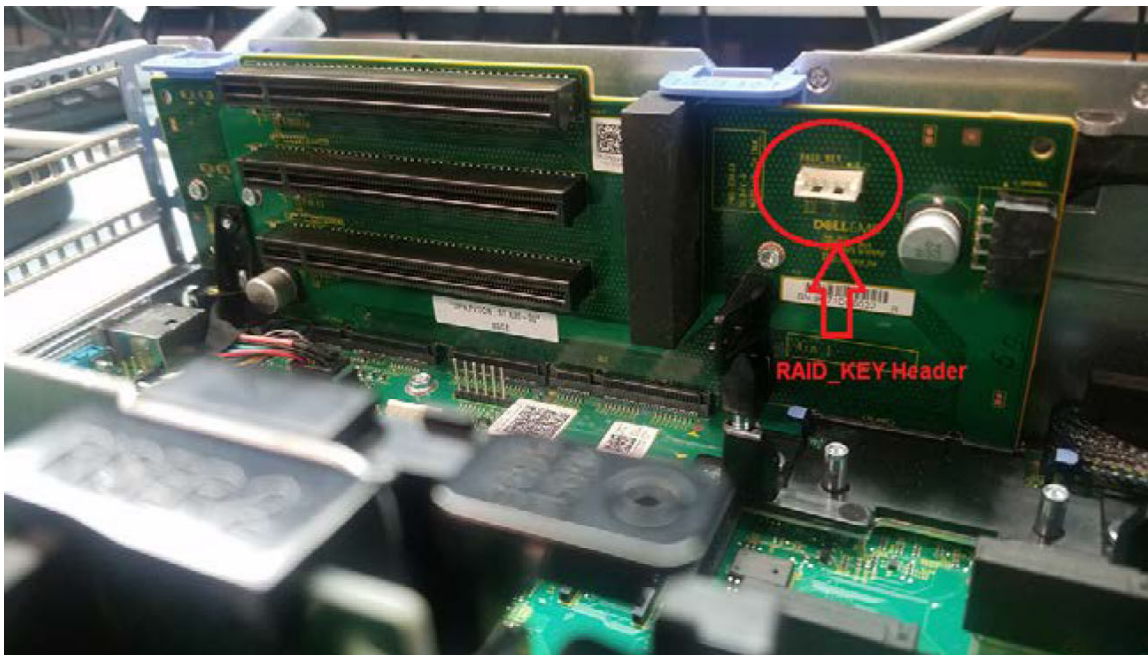

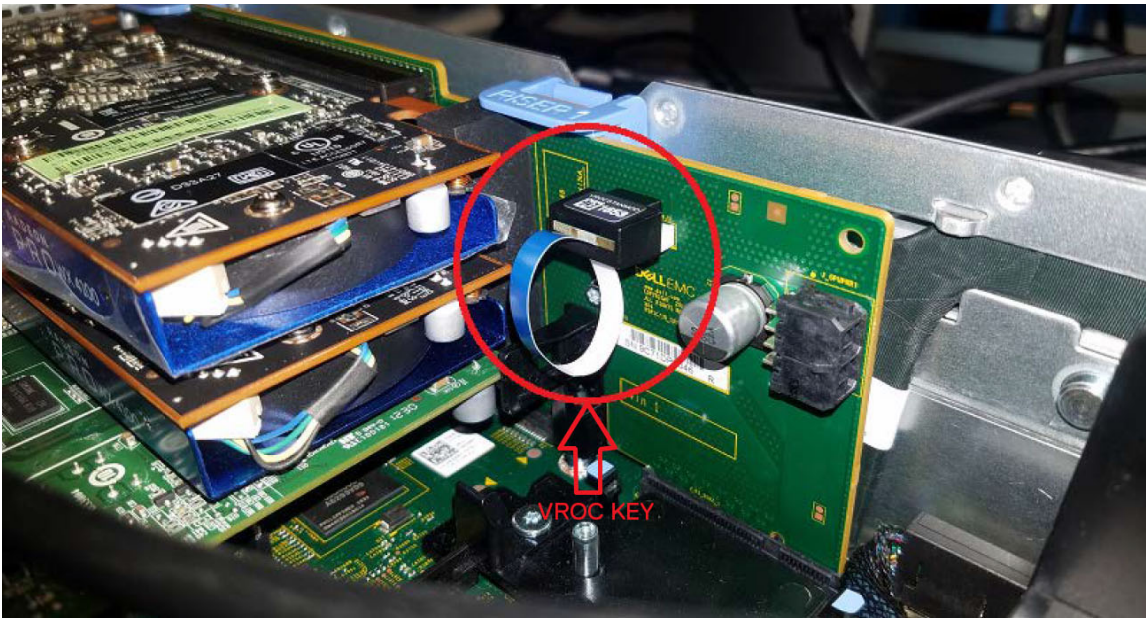

Steps

1. Pull the expansion card latch out of the slot.
2. Hold the expansion card by its edges, and pull the card until the card edge connector disengages from the expansion card connector on the riser.

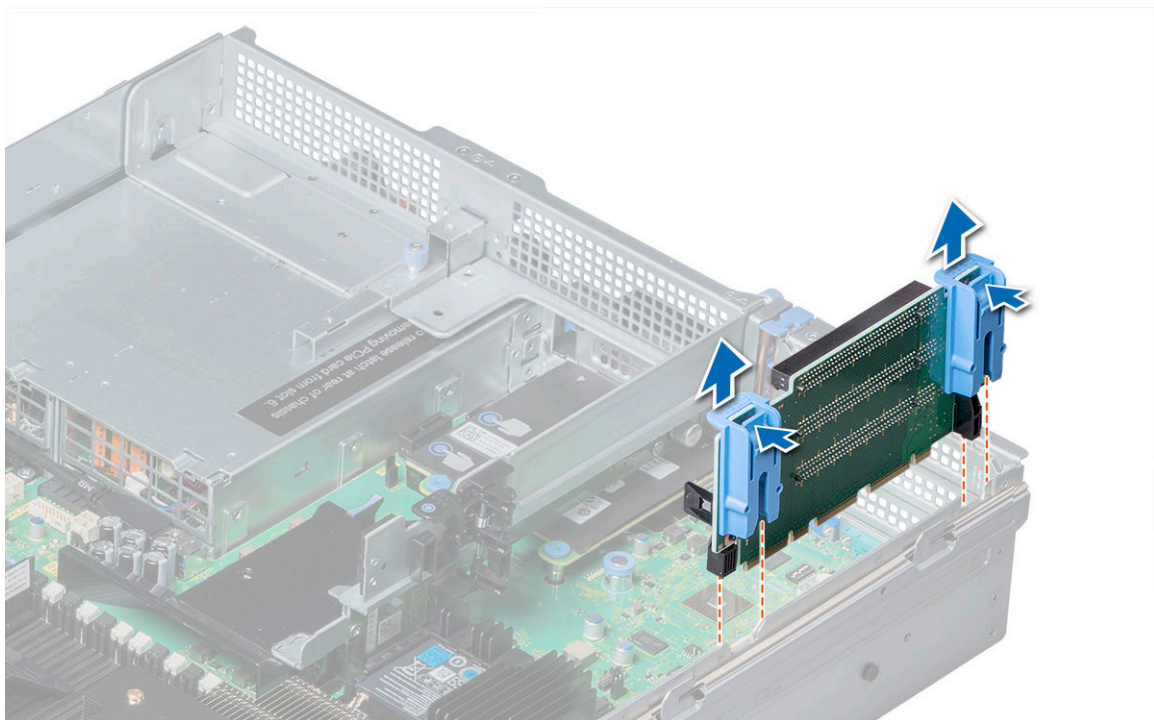

Figure 22. Removing expansion card riser 1

Installing expansion card riser 1

About this task

NOTE: If installing a replacement expansion card riser 1 make sure the VROC key is transferred from the old card to the new card.

Steps

1. Align the guide rails on the riser with the standoffs on the side of the system.
2. Lower the riser into the system until the riser card connector engages with the connector on the system board.

Next steps

1. If removed, install expansion cards into the riser.
2. Connect the cable which disconnected from the expansion card.
3. Install any device drivers required for the card as described in the documentation for the card.

Removing expansion card riser 2

Prerequisites

1. If applicable, remove the air shroud.
 1. **NOTE:** If applicable, close the PCIe card holder latch on the air shroud to release the full length card.
2. If installed, remove expansion cards installed on the riser.
3. Disconnect any cables connected to the riser card.

Steps

1. To remove expansion card riser 2A:
 - a. Using Phillips #2 screwdriver, loosen the screws that secure the riser to the system.
 - b. Press the release tab, and holding the riser by its edges, lift the riser from the riser connector on the system board.

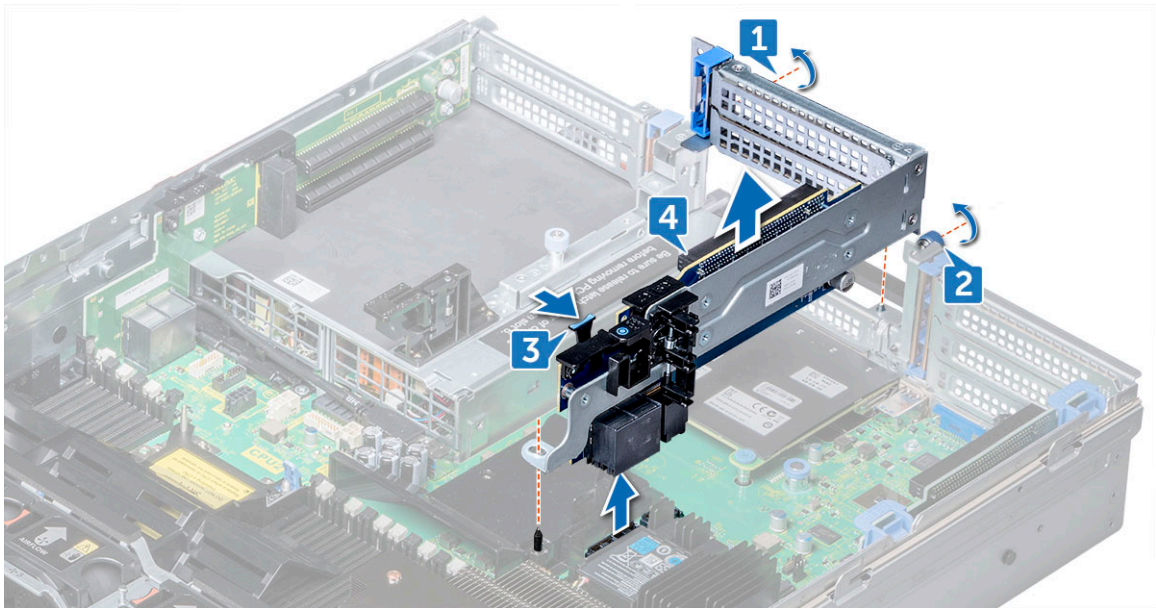

Figure 23. Removing expansion card riser 2A

2. Remove the expansion card riser.

Installing expansion card riser 2

Steps

To install expansion card riser 2A:

- a. Align the screw and tab on the riser with the screw hole and slot on the system.
- b. Lower the riser into the system until the riser connector engages with the connector on the system board.
- c. Using Phillips #2 screwdriver, tighten the screws to secure the riser to the system.

Next steps

1. If removed, install expansion cards into the riser and connect any cable disconnected.
2. If applicable, install the air shroud.
 - NOTE:** If applicable, open the PCIe card holder latch on the air shroud to install the full length card.
3. Install any device drivers required for the card as described in the documentation for the card.

Removing expansion card riser 3

Prerequisites

1. If applicable, remove the air shroud.
 - NOTE:** If applicable, close the PCIe card holder latch on the air shroud to release the full length card.
2. If installed, remove expansion cards installed on the riser.
3. Disconnect any cables connected to the riser card.

Steps

1. Using Phillips #2 screwdriver, loosen the screw that secures the riser to the system.
2. Press the release tab, and holding the riser by its edges, lift the riser from the riser connector on the system board.

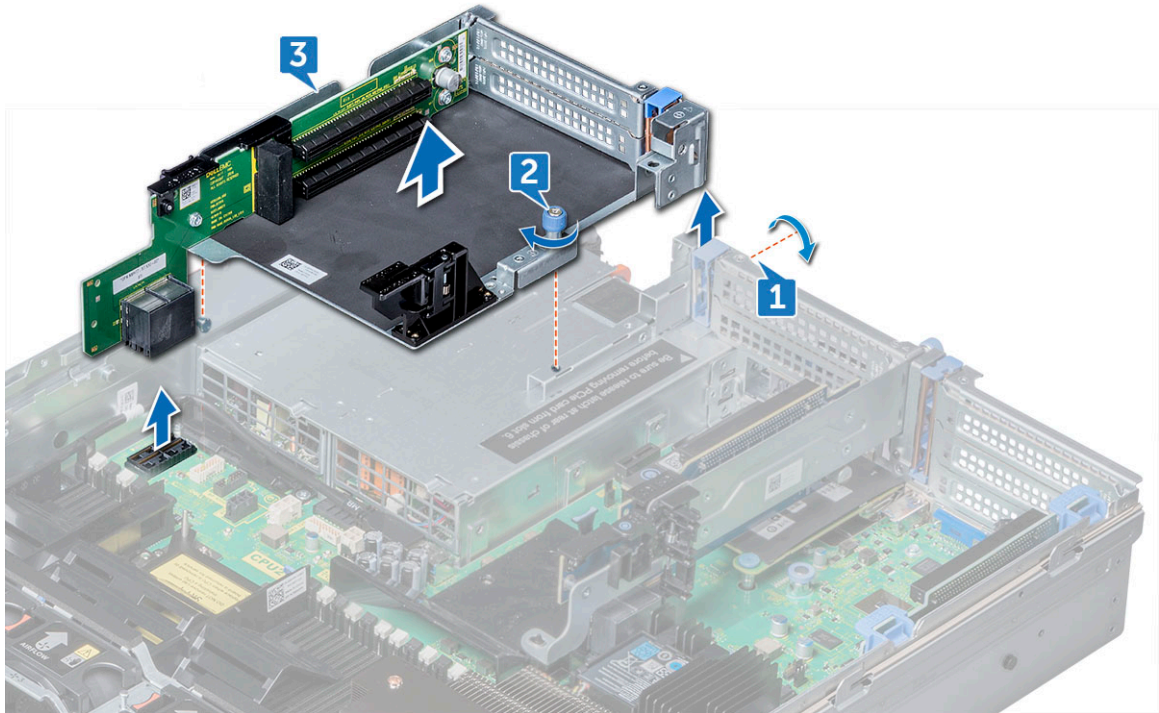

Figure 24. Removing expansion card riser 3

Installing expansion card riser 3

Steps

1. Align the following:
 - a. Tab on the riser with the slot on the system and guide rails on the riser with the standoffs on the side of the system.
 - b. Lower the riser into the system until the riser edge connector engages with the connector on the system board. The riser card edge engages with the riser guide on the system.
2. Using Phillips #2 screwdriver, tighten the screw to secure the riser to the system.

Next steps

1. If removed, install expansion cards into the riser and connect any cable disconnected.
2. If applicable, install the air shroud.
 - NOTE:** If applicable, open the PCIe card holder latch on the air shroud to install the full length card.
3. Install any device drivers required for the card as described in the documentation for the card.

Removing the Dell ultraspeed drive duo card from the expansion card shroud

Prerequisites

- Remove the [System cover](#)
- Remove the [Riser 2 module](#)

Steps

1. Press the tab at the end of the shroud and lift the expansion card shroud.
2. Remove the (M2x2.5) screw.
3. Remove the Dell ultraspeed drive duo card from the slot.

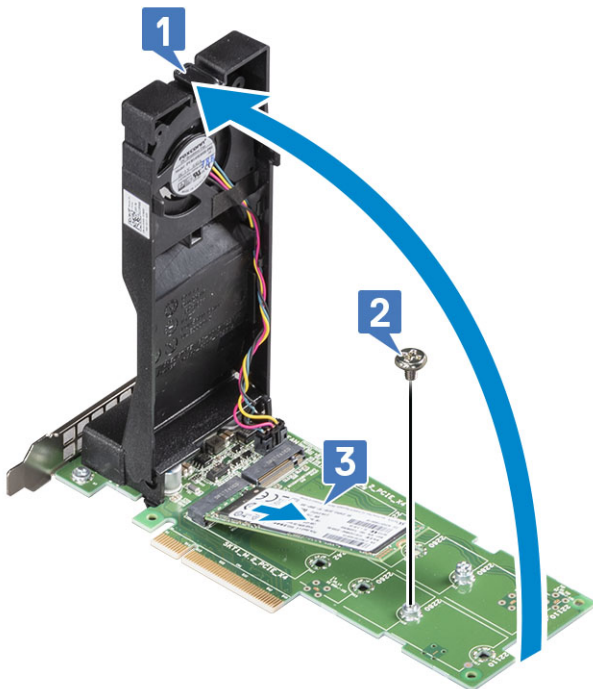

Installing the Dell ultraspeed drive duo card into the expansion card shroud

Steps

1. Remove the (M2x2.5) mounting screw.
2. Insert the dell ultraspeed drive duo card into the slot and replace the SSD mounting screw.
3. Close the shroud until the latch "clicks".
4. Slide the Dell Ultraspeed Drive Duo Card into the riser slot.
5. Close the riser 1 module release latch.

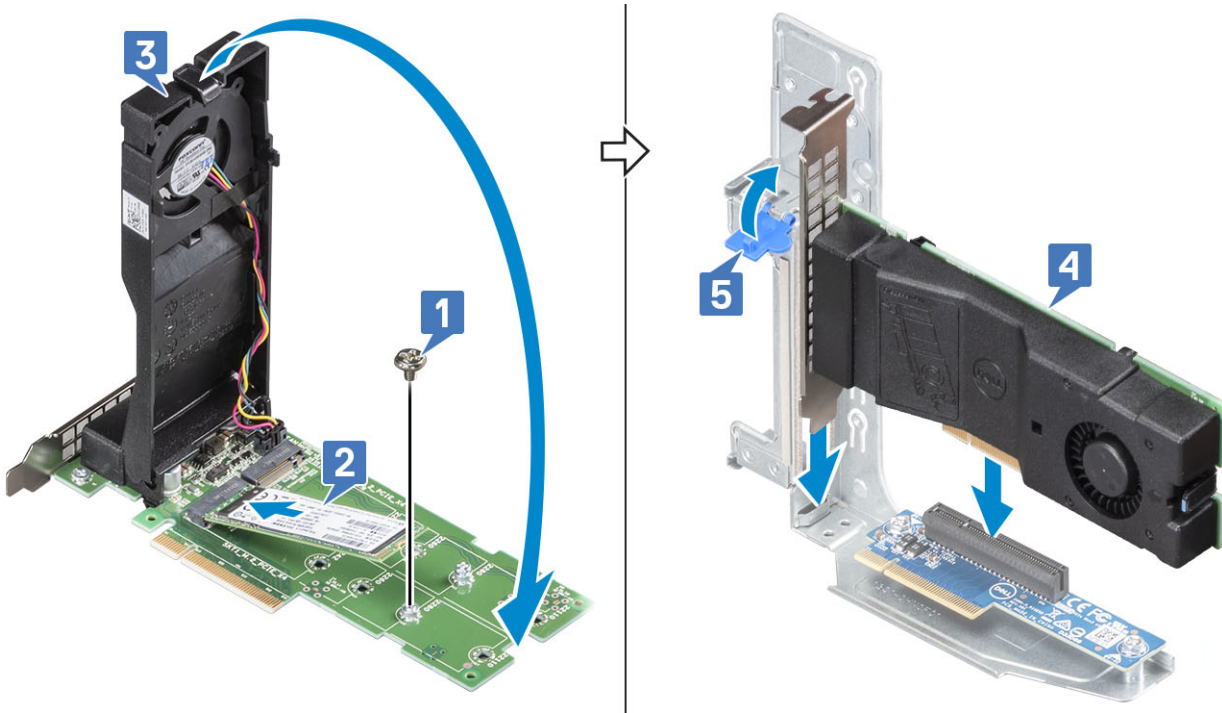

6. Install the:
 - a. Riser 2 module
 - b. System cover

vFlash card – optional

Removing vFlash card

Prerequisites

1. If applicable, remove the full height PCIe card in expansion card riser 2.

Steps

1. Locate the vFlash connector on the system board. To locate vFlash connector, see [System board jumpers and connectors](#) section.
2. Remove the vFlash card from its slot [1].
3. Holding the pull tab, lift the vFlash expansion card out of the system [2].

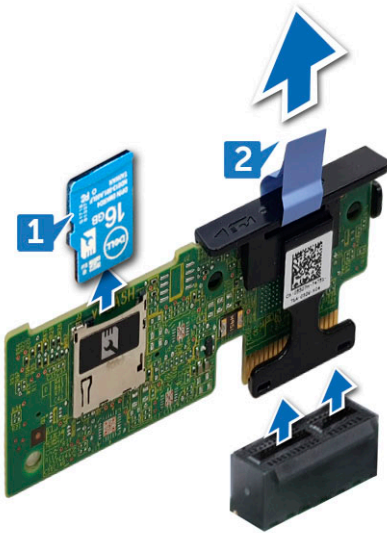

Installing vFlash card

Steps

1. Locate the vFlash connector on the system board. To locate vFlash connector, see [System board jumpers and connectors](#) section.
2. Align the vFlash expansion card with the connector on the system board and push until it is firmly seated on the system board.
3. Insert the vFlash card into the slot on the vFlash expansion card.

Next steps

1. If applicable, install the full height PCIe card in expansion card riser 2.

Network daughter card

Removing network daughter card

Prerequisites

1. Remove the expansion card riser 2.

Steps

1. Using a Phillips #2 screwdriver, loosen the captive screws that secure the Network Daughter Card (NDC) to the system board.
2. Hold the NDC by the edges on either side of the touch points and lift to remove it from the connector on the system board.
3. Slide the NDC away from the back of the system until the Ethernet connectors are clear of the slot in the back panel.

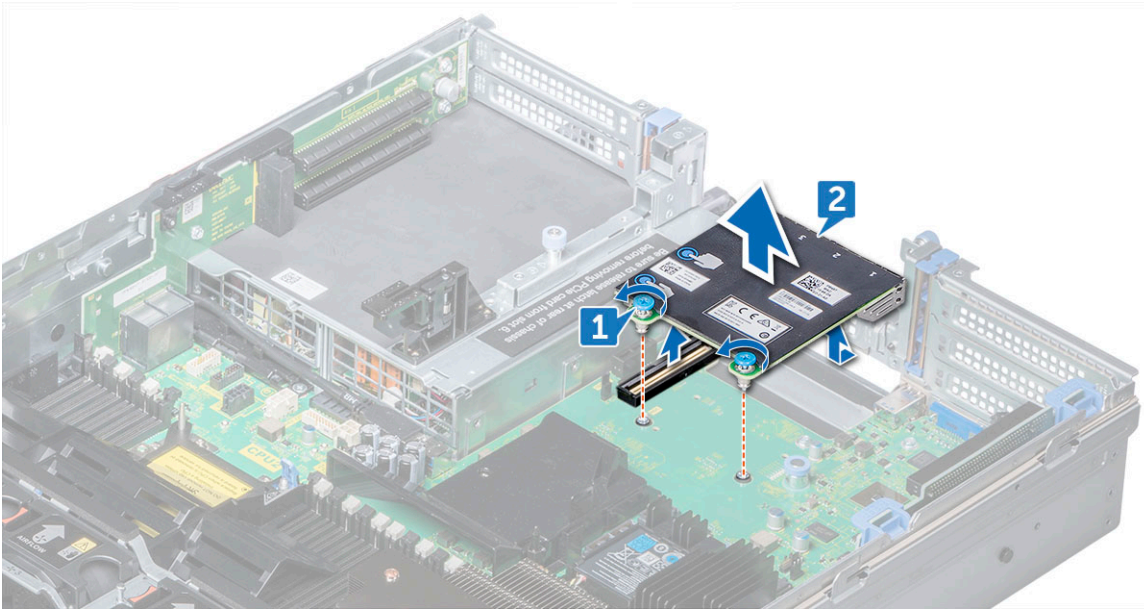

Installing network daughter card

Steps

1. Orient the NDC so that the Ethernet connectors fit through the slot in the back panel.
2. Align the captive screws at the back-end of the card with the screw holes on the system board.
3. Press the touch points on the card until the card connector is firmly seated on the system board connector.
4. Using a Phillips #2 screwdriver, tighten the captive screws to secure the NDC to the system board.

Next steps

1. Install the expansion card riser 2.

Hard drive backplane

Removing hard drive backplane

Prerequisites

CAUTION: To prevent damage to the drives and backplane, remove the hard drives from the system before removing the backplane.

CAUTION: Note the number of each hard drive and temporarily label them before you remove the hard drive so that you can replace them in the same locations.

1. Remove the air shroud.
2. Remove the cooling fan assembly.
3. Remove the backplane cover.
4. Remove all hard drive.
5. Disconnect all the cables from the backplane.

Steps

Press the release tabs and lift the backplane to disengage the backplane from the hooks on the system.

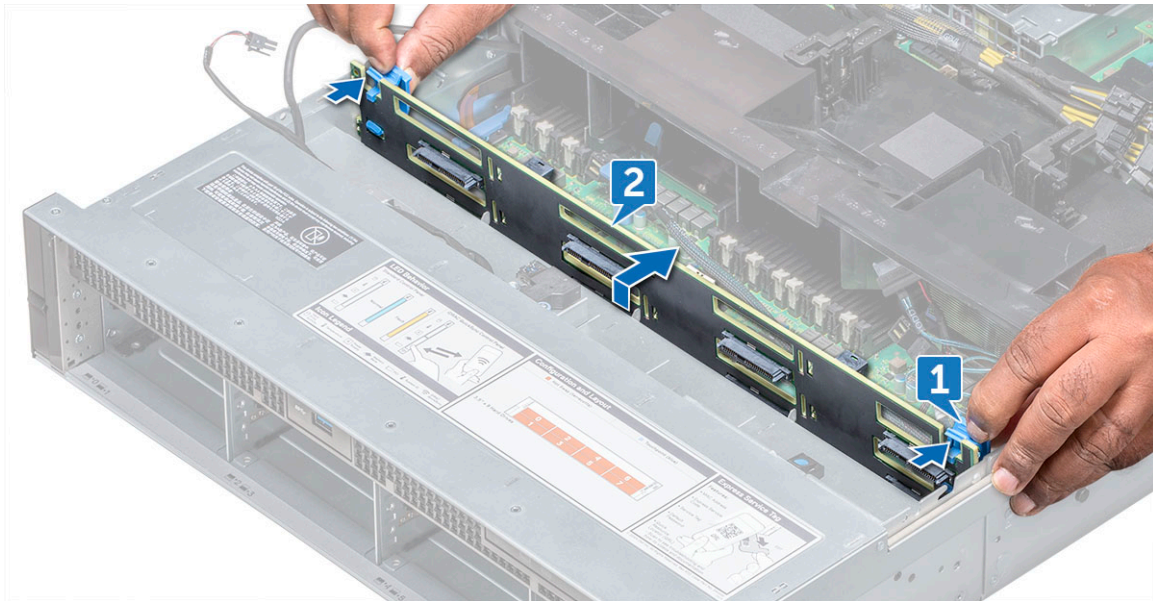

Figure 25. Removing hard drive backplane

Installing hard drive backplane

Steps

1. Use the hooks on the system as guides to align the hard drive backplane.
2. Lower the hard drive backplane until the release tabs snap into place. If applicable, tighten the captive screws on the backplane.

Next steps

1. Connect all the cables to the backplane.
2. Install all the hard drives.
3. Install the backplane cover.
4. Install the cooling fan assembly.
5. Install the air shroud.

Front USB module

Removing front USB module

Prerequisites

1. Remove the front bezel.
2. Remove the system cover.

Steps

1. Unroute the cable and remove the screw that secures the USB module on the system.
2. Push the cable and disconnect it from the system.
3. Remove the front USB module from the system.



Installing front USB module

Steps

1. Place the front USB module in the slot on the system.
2. Connect and slide the USB module cable and tighten the screw.
3. Route the cable through the routing channel.

Next steps

1. Install the system cover.
2. Install the front bezel.

Internal USB memory key (optional)

Replacing optional internal USB memory key

Steps

1. Locate the USB connector or USB key on the system board.
2. If installed, remove the USB key.
3. Insert the new USB key into the USB connector.

Next steps

1. While booting, press <F2> to enter the System Setup and verify that the USB key is detected by the system.

Power supply unit

Removing power supply unit blank

Install the power supply unit (PSU) blank only in the second PSU bay.

Steps

If you are installing a second PSU, remove the PSU blank in the bay by pulling the blank outward.

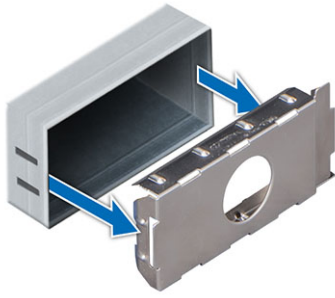

CAUTION: To ensure proper system cooling, the PSU blank must be installed in the second PSU bay in a non-redundant configuration. Remove the PSU blank only if you are installing a second PSU.

Installing power supply unit blank

Install the power supply unit (PSU) blank only in the second PSU bay.

Steps

Align the PSU blank with the PSU slot and push it into the PSU slot until it clicks into place.

Removing AC power supply unit

Prerequisites

CAUTION: The needs one power supply unit (PSU) for normal operation. On power-redundant systems, remove and replace only one PSU at a time in a system that is powered on.

1. Disconnect the power cable from the power source and from the PSU you intend to remove, and then remove the cable from the strap on the PSU handle.

Steps

Press the release latch and slide the PSU out of the system by using the PSU handle.

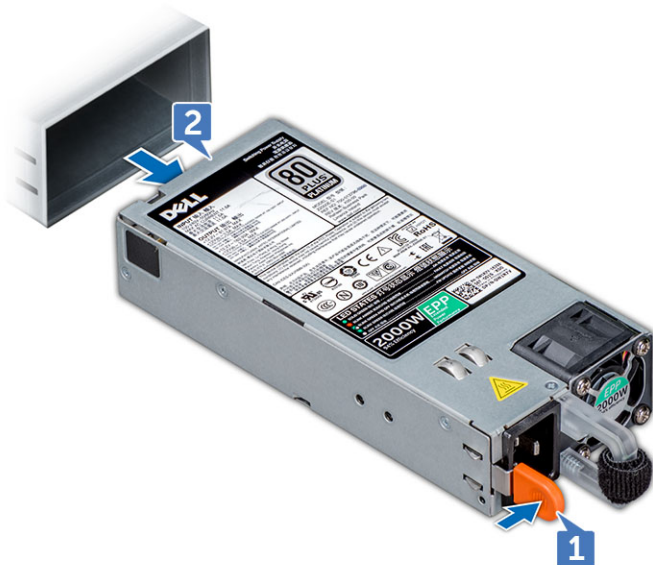

Installing AC power supply unit

Steps

Slide the PSU into the system until the PSU is fully seated and the release latch snaps into place.

Next steps

1. Connect the power cable to the PSU, and plug the cable into a power outlet.

 **CAUTION:** When connecting the power cable to the PSU, secure the cable to the PSU with the strap.

System board

Removing system board

Prerequisites

 **CAUTION:** If you are using the Trusted Platform Module (TPM) with an encryption key, you may be prompted to create a recovery key during program or System Setup. Be sure to create and safely store this recovery key. If you replace this system board, you must supply the recovery key when you restart your system or program before you can access the encrypted data on your hard drives.

 **CAUTION:** Do not attempt to remove the TPM plug-in module from the system board. Once the TPM plug-in module is installed, it is cryptographically bound to that specific system board. Any attempt to remove an installed TPM plug-in module breaks the cryptographic binding, and it cannot be re-installed or installed on another system board.

1. Remove the following:
 - a. Air shroud
 - b. Cooling fan assembly
 - c. Optical drive
 - d. Power supply unit(s)
 - e. All expansion card risers
 - f. vFlash card
 - g. USB 3.0 module
 - h. Internal USB key (if installed)
 - i. Processor and heat sink module
 - j. Processors and memory blank

 **CAUTION:** To prevent damage to the processor pins when replacing a faulty system board, ensure that you cover the processor socket with the processor protective cap.

- k. Memory modules
- l. Network daughter card

Steps

1. Disconnect all cables from the system board.

 **CAUTION:** Take care not to damage the system identification button while removing the system board from the chassis.

 **CAUTION:** Do not lift the system board by holding a memory module, processor, or other components.

2. Holding the system board holder, pull the blue release pin, lift the system board, and then slide it toward the front of the chassis.
Sliding the system board toward the front of the chassis disengages the connectors from the back of the chassis slots.
3. Lift the system board out of the chassis.

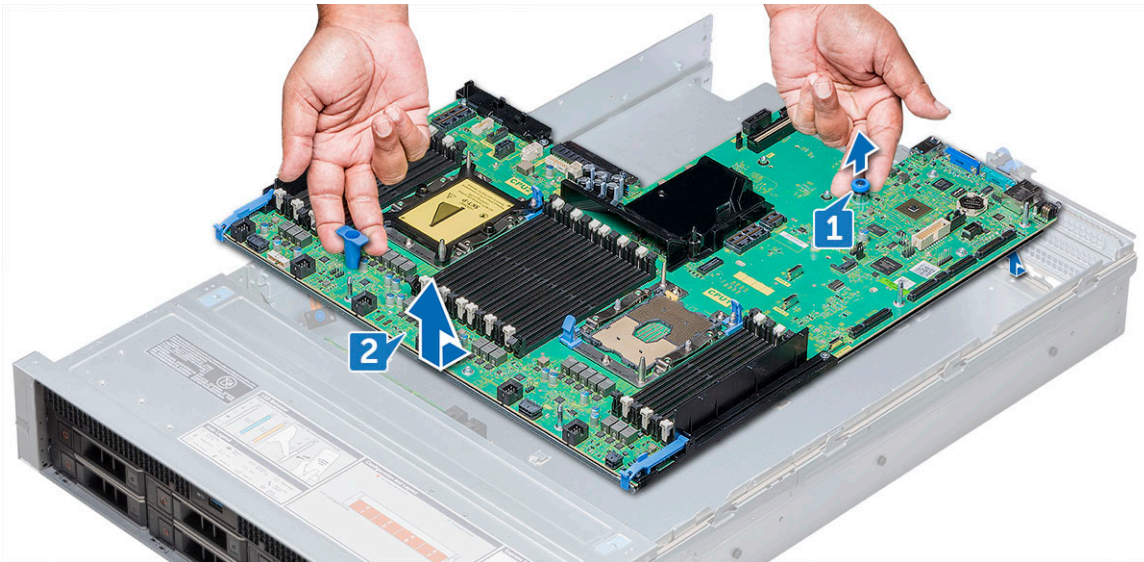

Installing system board

Steps

1. Unpack the new system board assembly.

CAUTION: Do not lift the system board by holding a memory module, processor, or other components

CAUTION: Take care not to damage the system identification button while placing the system board into the chassis.

2. Holding the system board holder, push the system board toward the back of the system until the release pin clicks into place.

Next steps

1. Install the Trusted Platform Module (TPM).

NOTE: The TPM plug-in module is attached to the system board and cannot be removed. A replacement TPM plug-in module will be provided for all system board replacements where a TPM plug-in module was installed.

2. Replace the following:

- a. Network daughter card
- b. Internal USB key (if applicable)
- c. USB 3.0 module
- d. vFlash card
- e. Optical drive
- f. All expansion card risers
- g. Processor and heat sink module
- h. Processor and memory blank
- i. Memory modules
- j. Cooling fan assembly
- k. Air shroud
- l. Power supply unit(s)

3. Reconnect all cables to the system board.

NOTE: Ensure that the cables inside the system are routed along the chassis wall and secured using the cable securing bracket.

4. The Easy Restore feature restores several configuration settings, most notably the Service Tag, iDRAC Licenses, and OEM ID Modules (if needed for the last two). Refer to the Restoring the Service Tag Using Easy Restore page. When the system board is booted for the first time it will present a screen with settings it can restore.

NOTE: If for any reason Easy Restore does not execute, you must enter the service tag manually. Refer to the Update the Service Tag page. Other configuration issues must also be done manually, for instance importing iDRAC License through iDRAC GUI

5. Import your new or existing iDRAC Enterprise license. For more information, see Integrated Dell Remote Access Controller User's Guide, at Dell.com/esmmanuals.
6. Ensure that you:
 - a. Use the Easy Restore feature to restore the Service Tag. For more information, see the Easy restore section.
 - b. If the Service Tag is not backed up in the backup flash device, enter the Service Tag manually. For more information, see the Entering the Service Tag section.
 - c. Update the BIOS and iDRAC versions.
 - d. Re-enable the Trusted Platform Module (TPM). For more information, see the Re-enabling the Trusted Platform Module (TPM) section.

Trusted Platform Module

Replacing the Trusted Platform Module

Prerequisites

CAUTION: Do not attempt to remove the Trusted Platform Module (TPM) from the system board. Once the TPM is installed, it is cryptographically bound to that specific system board. Any attempt to remove an installed TPM breaks the cryptographic binding, and it cannot be re-installed or installed on another system board.

NOTE: This is a Field Replaceable Unit (FRU). Removal and installation procedures should be performed only by Dell certified service technicians.

NOTE: There is a TPM slot on the system board of each sled.

Steps

1. Locate the TPM connector on the system board.

NOTE: To locate the TPM connector on the system board, see the System board connectors section.
2. Align the edge connectors on the TPM with the slot on the TPM connector.
3. Insert the TPM into the TPM connector such that the plastic rivet aligns with the slot on the system board.
4. Press the plastic rivet until the rivet snaps into place.

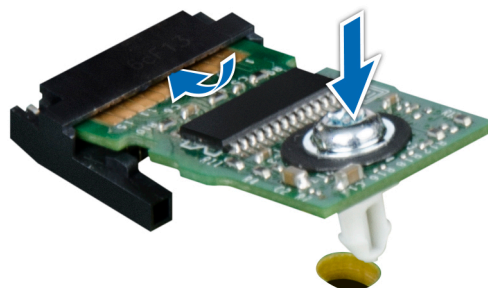

Figure 26. Installing the TPM

Next steps

1. Install the system board.

Initializing TPM for BitLocker users

Steps

Initialize the TPM.

For more information, see <https://technet.microsoft.com/library/cc753140.aspx>.

The **TPM Status** changes to **Enabled, Activated**.

Initializing the TPM 1.2 for TXT users

Steps

1. While booting your system, press F2 to enter System Setup.
2. On the **System Setup Main Menu** screen, click **System BIOS > System Security Settings**.
3. From the **TPM Security** option, select **On with Pre-boot Measurements**.
4. From the **TPM Command** option, select **Activate**.
5. Save the settings.
6. Restart your system.
7. Enter **System Setup** again.
8. On the **System Setup Main Menu** screen, click **System BIOS > System Security Settings**.
9. From the **Intel TXT** option, select **On**.

Control panel

Removing left control panel

Prerequisites

1. Remove air shroud.
2. For ease of removal of the left control panel, remove the cooling fan assembly #1 to access the cable latch.

Steps

1. Pull the cable latch and disconnect the control panel cable from the system board.
2. Using Phillips #1 screwdriver, remove the screws(6) that secure the control panel and cable tube to the system.
3. Holding the control panel and cable tube by its sides, remove the control panel and cable tube away from the system.

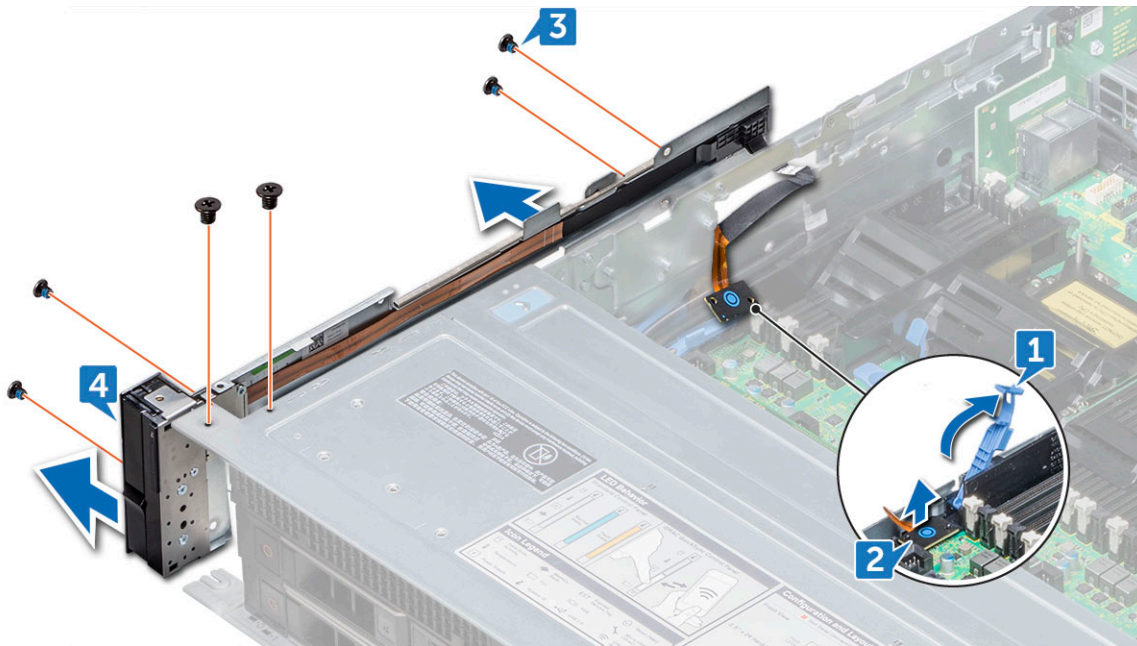

Installing left control panel

Steps

1. Route the control panel cable through the side wall of the system.
2. Align the control panel with the control panel slot on the system and attach the control panel to the system.
3. Connect the control panel cable to the system board and secure it using cable latch.
4. Using Phillips #1 screwdriver, install the screws(6) that secure the control panel and cable tube to the system.

Next steps

1. If applicable, install the cooling fan #1.
2. Install air shroud.

Removing right control panel

Prerequisites

1. Remove air shroud.
2. Remove cooling fan assembly.

Steps

1. Disconnect the VGA cable from the system board.
2. Pull the cable latch and disconnect the control panel cable from the system board.
3. Using Phillips #1 screwdriver, remove the screws(6) that secure the control panel and cable tube to the system.
4. Holding the control panel and cable tube by its sides, remove the control panel and cable tube away from the system.

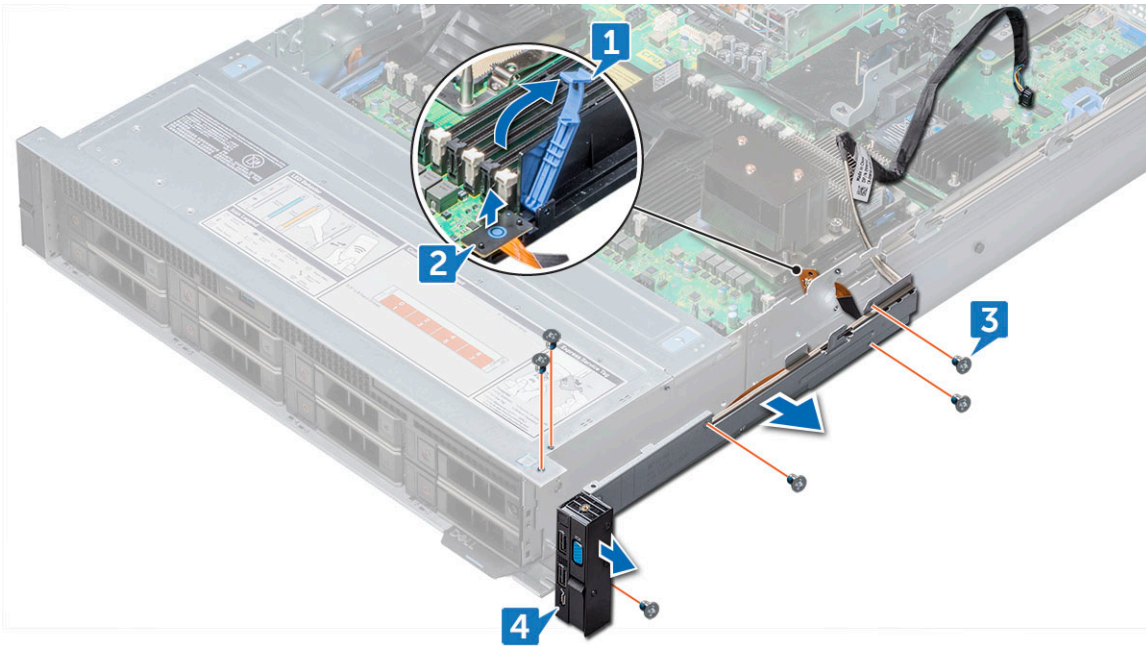

Installing right control panel

Steps

1. Route the control panel cable and VGA cable through the side wall of the system.
2. Align the control panel with the control panel slot on the system and attach the control panel to the system.
3. Connect the VGA cable to the system board.
4. Connect the control panel cable to the system board and secure it using cable latch.
5. Using Phillips #1 screwdriver, install the screws(6) that secure the control panel and cable tube to the system.

Next steps

1. Install cooling fan assembly.
2. Install air shroud.

GPU Host Card Installation

This section describes the following hardware installation processes

Alternate Riser Installation

This section describes the installation of the alternate riser to the system board. The alternate riser 3 is required for the PCIe X 16 lane operating with the NVIDIA Quadro K4200 GPU. This provides the best performance for this card.



To install the alternate riser, complete the following steps:

1. Remove any existing risers and GPU power cables from the chassis in slot 3.
2. Insert and firmly press the alternate riser 3 into the appropriate slot on the motherboard until it is seated properly.

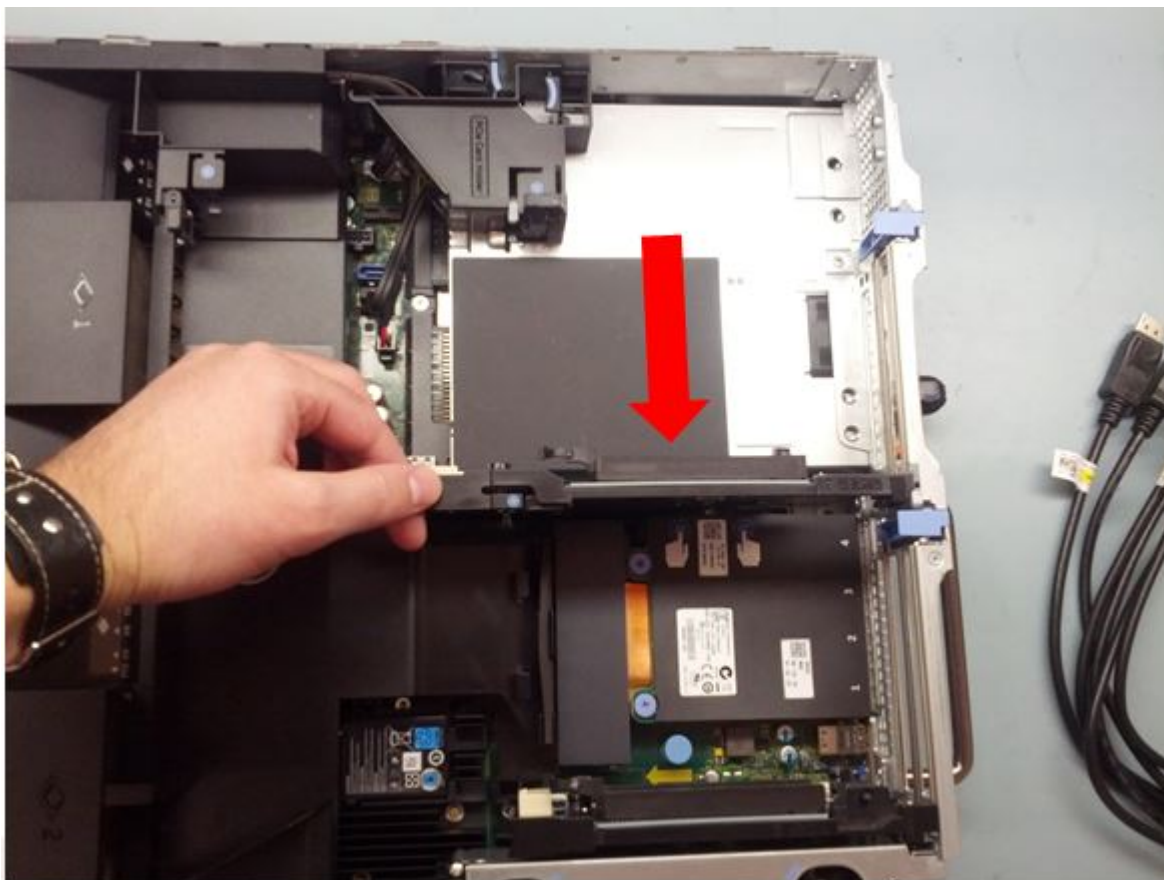

Teradici Tera2220 Host Cards Installation

This section describes the installation of Teradici host cards into the system. The host cards should have the low-profile PCI card brackets installed to fit into riser 1 on the Dell Precision Rack 7910.

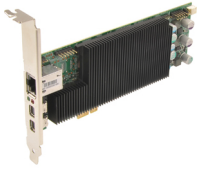

To install the host card, complete the following steps:

1. Remove the low-profile module that contains riser 1 from the chassis.
2. Open the PCI card support bracket on the back of the module.

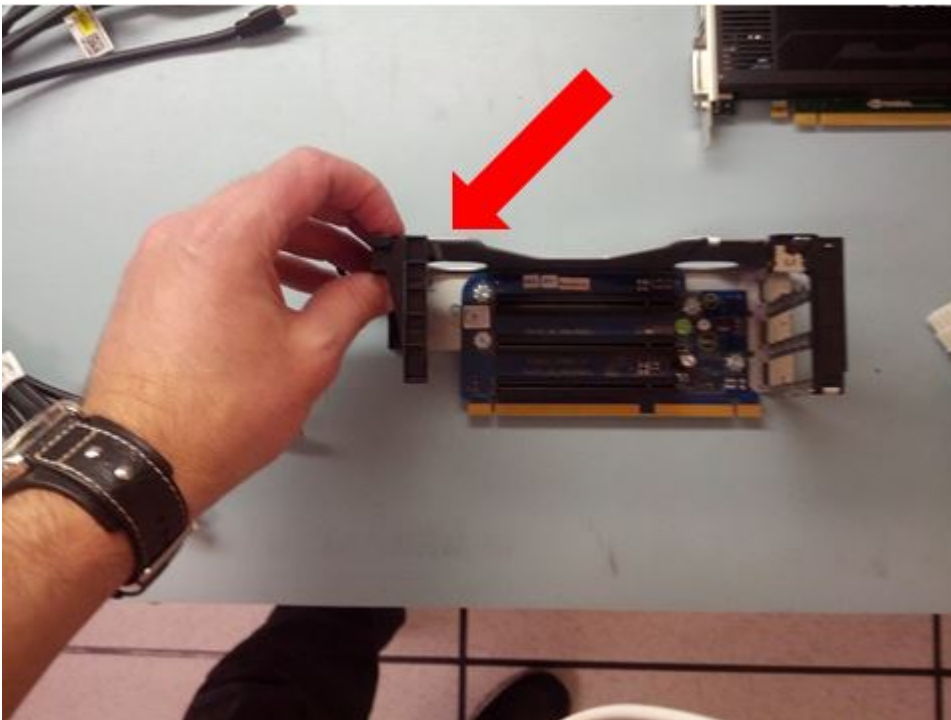

3. Open the retention clip for the low-profile PCI cards.

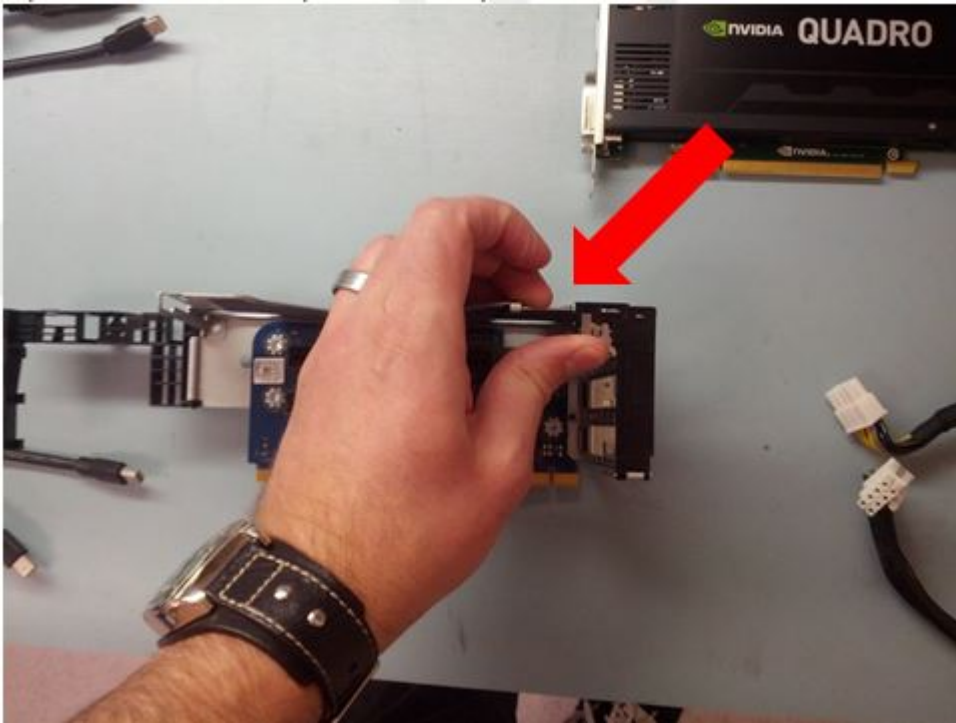

4. Install the three Teradici host cards into their respective PCIe slots.
5. Make sure the cards are sitting flush, and press the retaining bracket and the support bracket back into place.

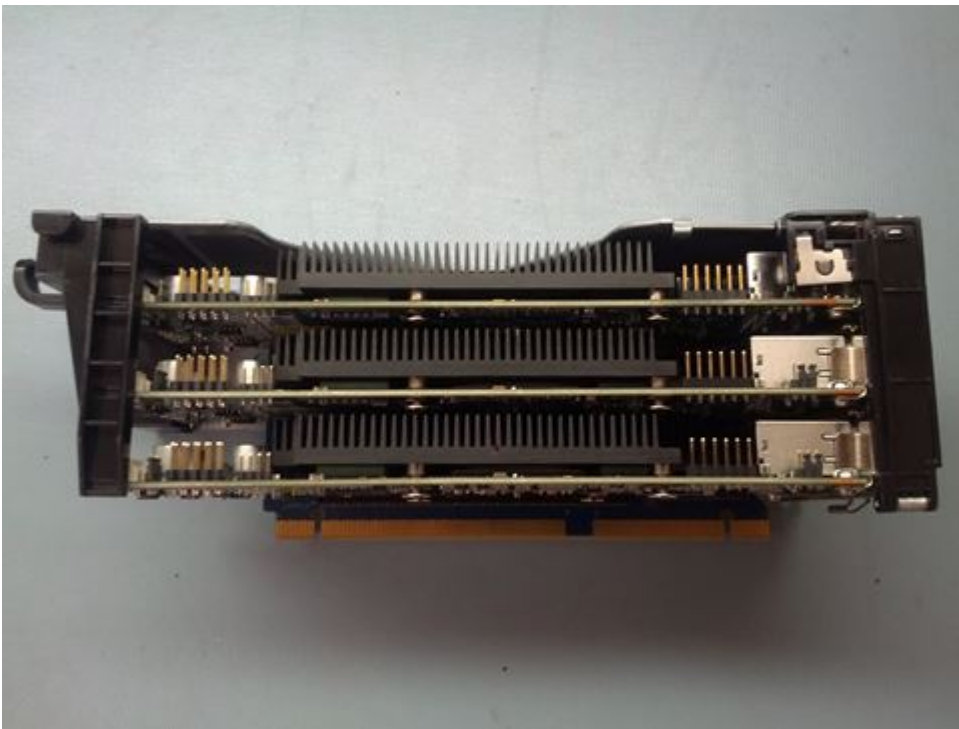

6. Install the host card's power button cables into the rear of the Teradici host cards. The image below shows the rear of the low-profile module and host cards

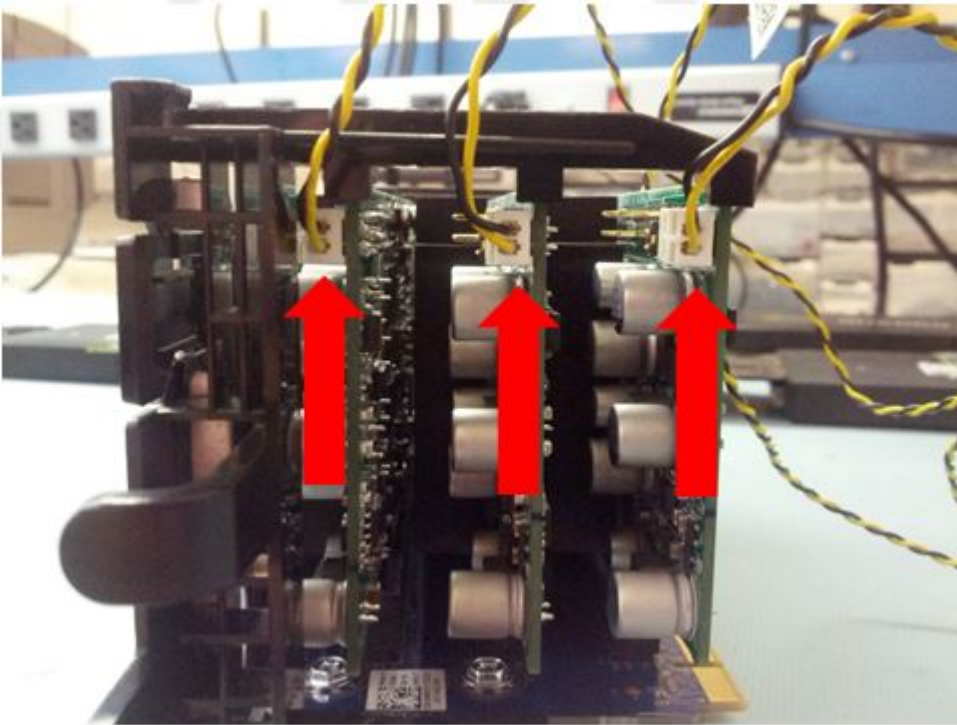

7. Install the low-profile module back into the chassis in slot 1. Make sure the power button cables are not pinched between the module and the chassis case.



8. Make sure the module is aligned correctly and press down firmly to seat it in the slot.



9. Remove the CPU air baffle from the chassis.
10. Route the power button cable from the closest Teradici host card as shown below, and insert the 2-pin female receptacle into P34 on the motherboard.

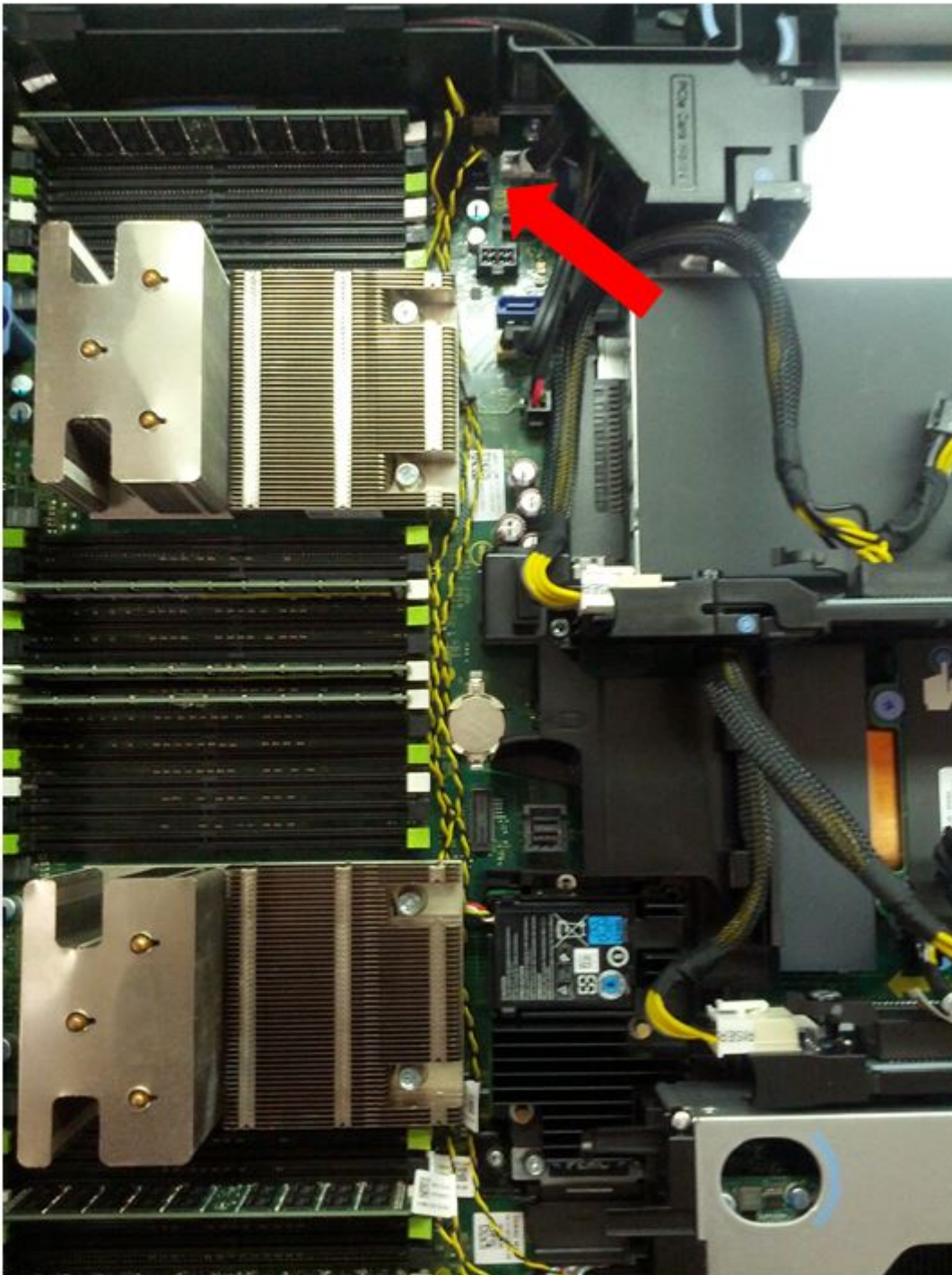

11. Daisy-chain the remaining connectors by connecting the 2-pin female connector on the additional cables to the male connector on the previous cable.
12. Reinstall the air baffle over the CPU heat sinks

NVIDIA Quadro K4200 Graphics Cards Installation

This section describes the installation of NVIDIA graphics cards into the system.

The host cards should have the low-profile PCI card brackets installed to fit into riser 1 on the Dell Precision Rack 7910.



To install the graphics cards, complete the following steps:

1. Install the GPU power cables into risers 2 and 3 as shown below.

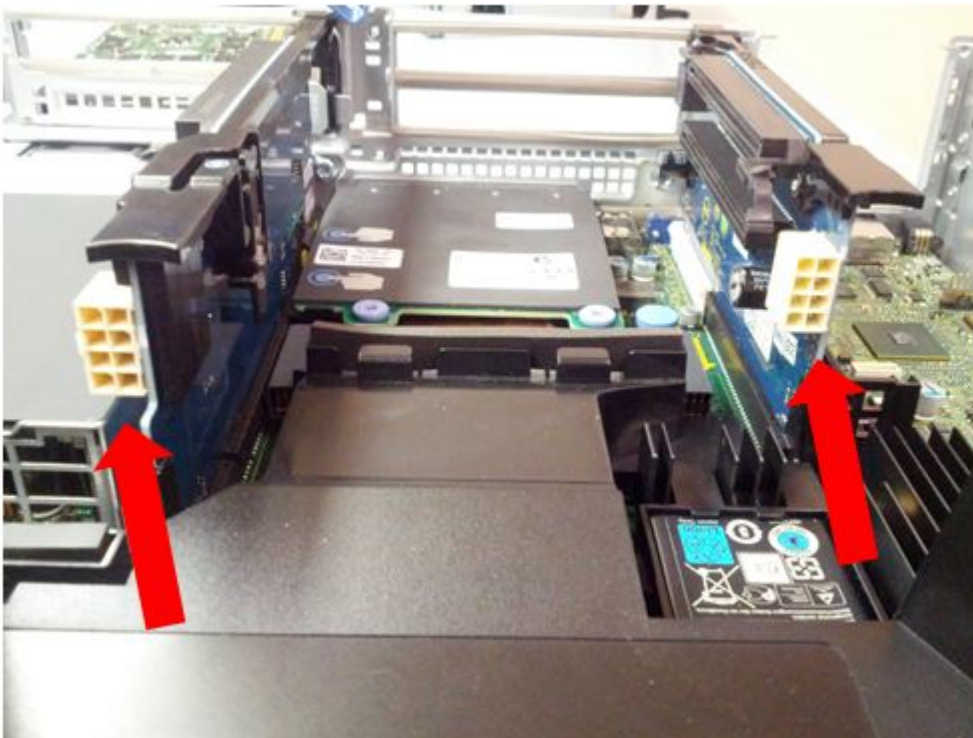



2. Connect one of the 6-pin power connectors to the first GPU and install the GPU into the bottom slot on riser 2.

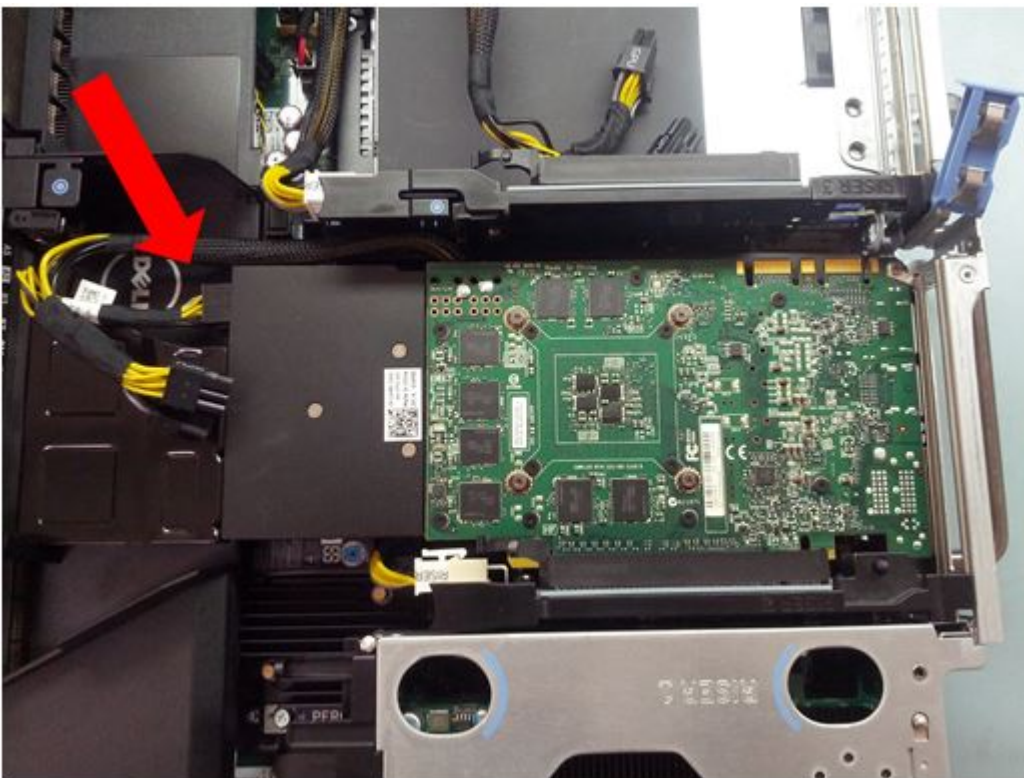

3. Connect the second 6-pin connector on the same power lead to the second card and install it into the top slot on riser 2.

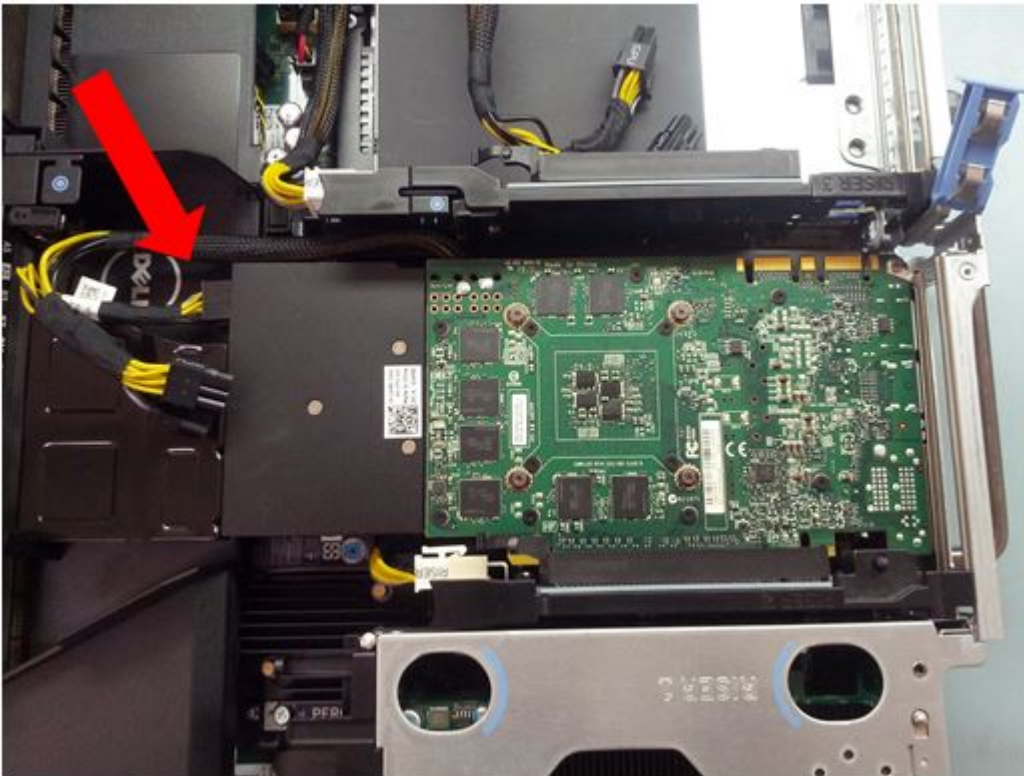

4. Press down the PCI retention mechanism and supporting clips.

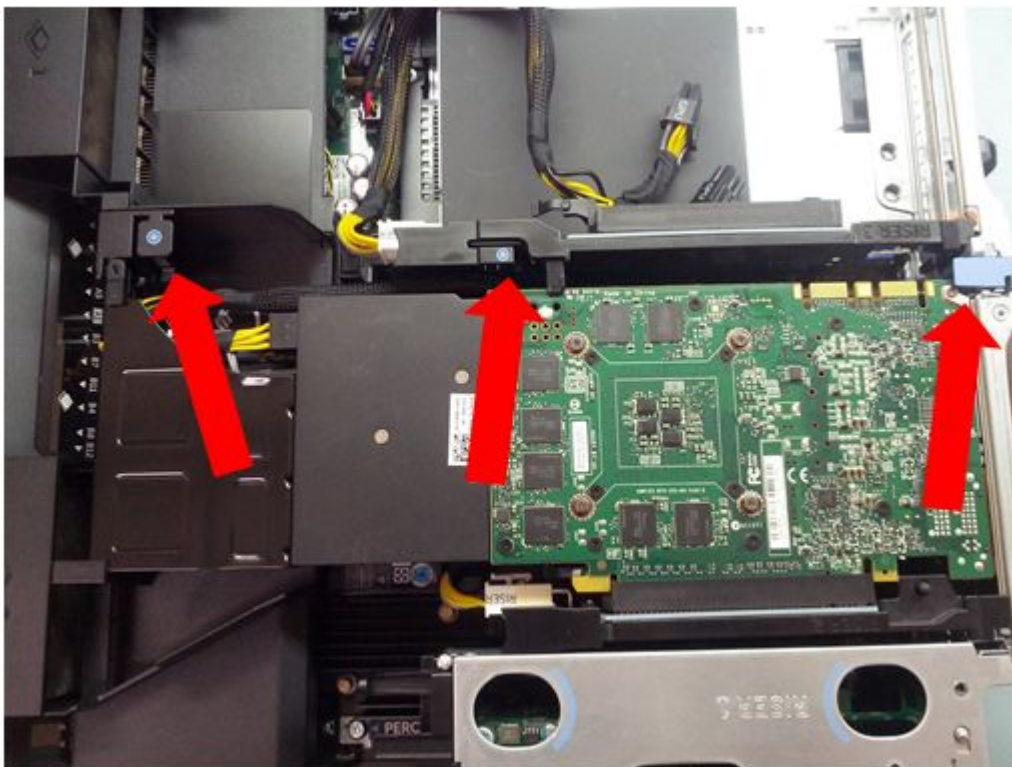

5. Connect a 6-pin connector from the power lead to the third card and install it into the top slot on riser 3.

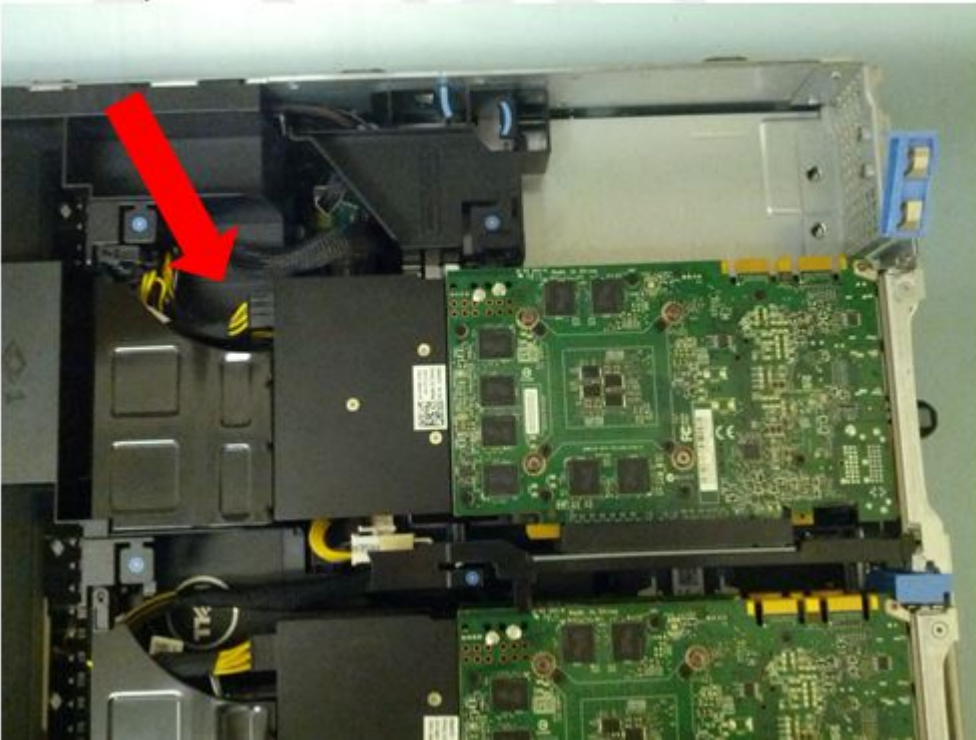

6. Press down the PCI retention mechanism and supporting clips.

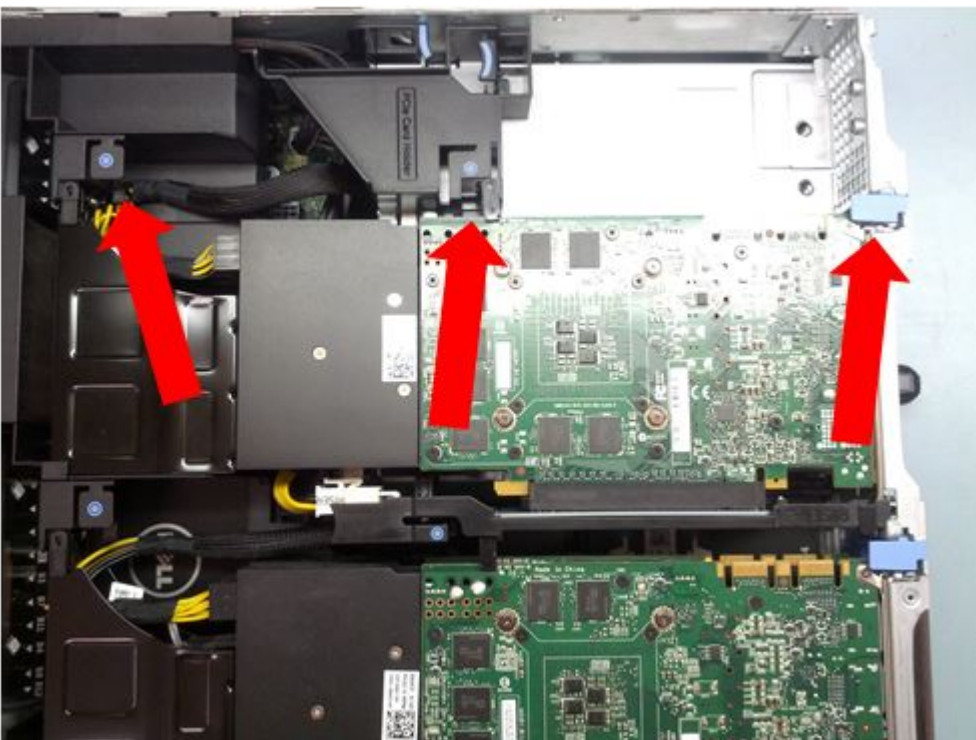

7. The back of the system should now look like the below diagram with slots 1-6 populated with PCI cards.

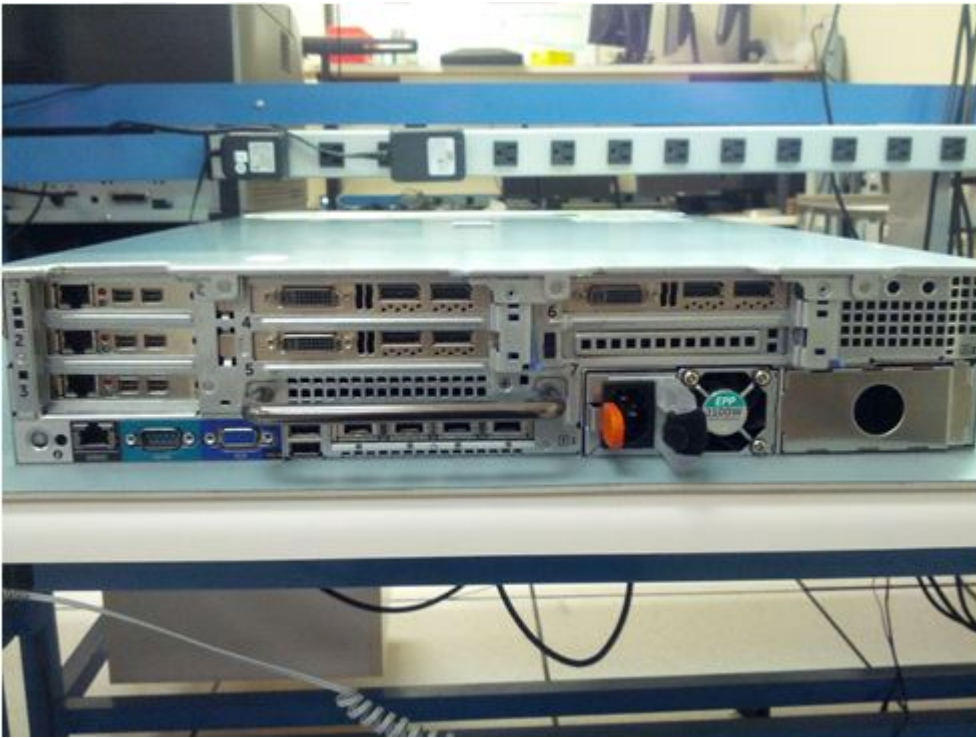

Cabling Teradici Host Cards to GPUs

This section outlines the installation of mini-DisplayPort (mDP)-to-DisplayPort (DP) cables for the Teradici host cards into the system.

Table 26. Cabling Teradici Host cards

Teradici 2220 Host Card		NVIDIA Quadro K4200
PCI Slot 1	<->	PCI Slot 4
PCI Slot 2	<->	PCI Slot 5
PCI Slot 3	<->	PCI Slot 6

For cable installation, complete the following steps:

1. Connect the mDP-to-DP cables from port 2 on the GPUs to port 1 on the Teradici host cards as shown below.



2. Connect the mDP-to-DP cables from port 3 on the GPUs to port 2 on the Teradici host cards as shown below.



3. Ensure all cables are firmly seated, and tidy them up if desired.



4. The system is now ready for setup and configuration.

Updating BIOS

To update the BIOS, perform the following steps:

Steps

1. Copy the BIOS update file on a USB device.
2. Plug in the USB device into any of the USB ports on your system.
3. Turn on your system.
4. While booting, press **F11** to enter the **Boot Manager**.
5. Go to **System Utilities** → **BIOS Update File Explorer**, and select the plugged in USB device.
6. From the **BIOS Update File Explorer**, select the **BIOS update file**.
The **BIOS Update Utility** with the current and new version of BIOS is displayed.
7. Select **Continue BIOS Update** to install the BIOS update.

Restoring the Service Tag using Easy Restore

The easy restore feature allows you to restore your service tag, license, UEFI configuration, and the system configuration data after replacing the system board. All data is backed up in a backup flash device automatically. If BIOS detects a new system board, and the service tag in the backup flash device, BIOS prompts the user to restore the backup information.

About this task

Below is a list of options available:

- Restore the service tag, license, and diagnostics information, press **Y**.
 - Navigate to the Lifecycle Controller based restore options, press **N**.
 - Restore data from a previously created **Hardware Server Profile**, press **F10**.
- i** **NOTE:** When the restore process is complete, BIOS prompts to restore the system configuration data.
- To restore the system configuration data, press **Y**.

- To use the default configuration settings, press **N**.

i **NOTE:** After the restore process is complete, system reboots

Manually update the Service Tag

After replacing a system board, if Easy Restore fails, follow this process to manually enter the Service Tag, using **System Setup**.

About this task

If you know the system service tag, use the System Setup menu to enter the service tag.

1. Turn on the system.
2. To enter the **System Setup**, press **F2**.
3. Click **Service Tag Settings**.
4. Enter the service tag.

i **NOTE:** You can enter the service tag only when the Service Tag field is empty. Ensure that you enter the correct service tag. Once the service tag is entered, it cannot be updated or changed.

5. Click **OK**.

Installation

Installing the Precision 7920 Rack requires information about the following topics:

- Rack Rails
- System Initialization
- Basic Configuration

Rack Rails

The rail offerings consist of two types of rails — sliding and static.

The sliding rails allow the system to be fully extended out of the rack for service. They are available with or without the optional cable management arm (CMA).

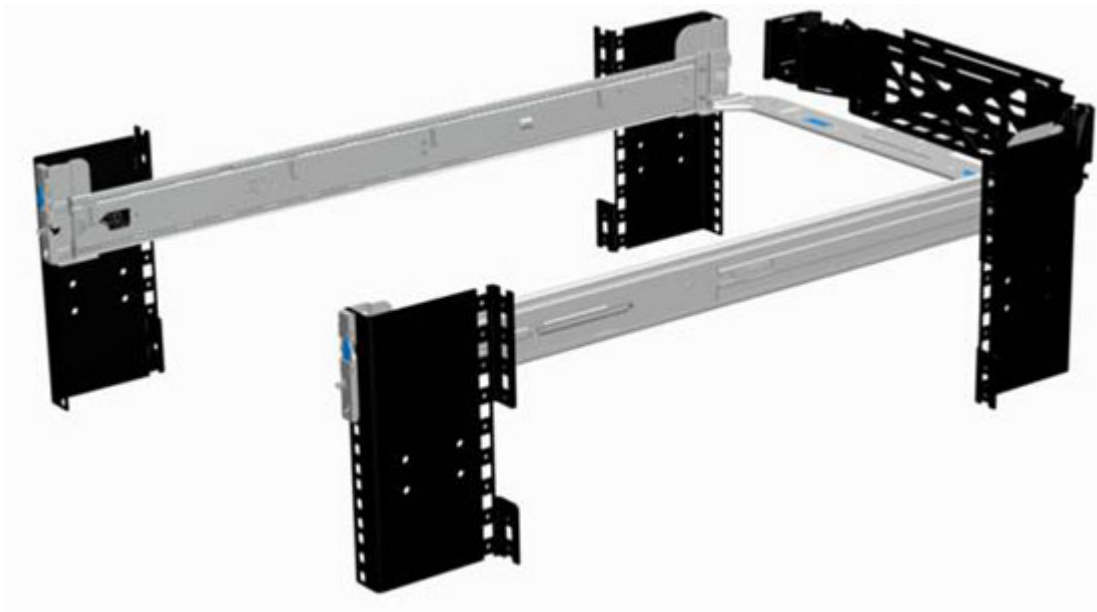

The static rails support a wider variety of racks than the sliding rails. However, they do not support serviceability in the rack and are thus not compatible with the CMA.

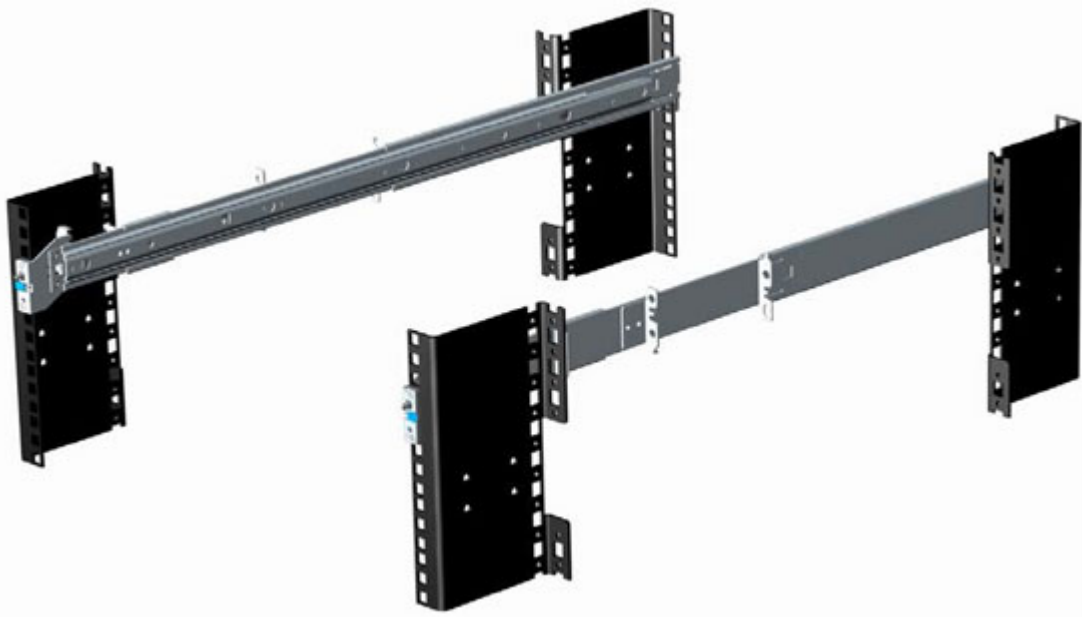

One key factor in selecting the proper rails is identifying the type of rack in which they will be installed. Both the sliding rails and the static rails support tool-less mounting in 19" wide, EIA-310-E-compliant square hole and unthreaded round hole 4-post racks. Both also support tooled mounting in threaded hole 4-post racks, but only the static rails, as the more universal solution, support mounting in 2-post (Telco) racks.

The table below shows the sliding and static rail configurations and supported racks:

Table 27. Sliding and Static Rails

Rail identifier	Mounting interface	Rail type	Supported rack types				
			4-Post			2-Post	
			Square	Round	Thread	Flush	Center
B6	Ready Rails II	Sliding	√	√	√	X	X
B4	Ready Rails	Static	√	√	√	√	√

NOTE: Screws are not included in either kit due to the fact that threaded racks are offered with a variety of thread designations. Users must therefore provide their own screws when mounting the rails in threaded racks.

NOTE: Screw head diameter for the sliding rails must be 10 mm or less.

Other key factors governing proper rail selection include the following:

- Spacing between the front and rear mounting flanges of the rack
- Type and location of any equipment mounted in the back of the rack such as power distribution units (PDUs)
- Overall depth of the rack

The static rails offer a greater adjustability range and a smaller overall mounting footprint than the sliding rails. This is because of their reduced complexity and lack of need for CMA support.

Table 28. Static Rails Adjustability

Rail Identifier	Rail Type	Rail Adjustable Range (mm)						Rail Depth (mm)	
		Square		Round		Threaded		without CMA	with CMA
		Min	Max	Min	Max	Min	Max		
B6	Sliding	676	868	662	861	676	883	714	845
B4	Static	608	879	594	872	604	890	622	N/A

Note that the adjustment range of the rails is a function of the type of rack in which they are being mounted. The Min/Max values listed above represent the allowable distance between the front and rear mounting flanges in the rack. Rail depth without

the CMA represents the minimum depth of the rail with the outer CMA brackets removed (if applicable) as measured from the front mounting flanges of the rack.

Cable management arm (CMA)

The optional cable management arm (CMA) organizes and secures the cords and cables exiting the back of the systems. It unfolds to allow the systems to extend out of the rack without having to detach the cables. Some key features of the CMA include:

- Large U-shaped baskets to support dense cable loads
- Open vent pattern for optimal airflow
- Ability to be mounted on either side by simply swinging the spring-loaded brackets from one side to the other
- Utilizes hook-and-loop straps rather than plastic tie wraps to eliminate the risk of cable damage during cycling
- Includes a low-profile fixed tray to both support and retain the CMA in its fully closed position
- Both the CMA and the tray mount without the use of tools via simple and intuitive snap-in designs

The CMA can be mounted to either side of the sliding rails without the use of tools or the need for conversion. However, it is recommended that it be mounted on the side opposite to the power supplies to allow easier access to the power supplies and rear hard drives (if applicable) for service or replacement.



Rack Installation

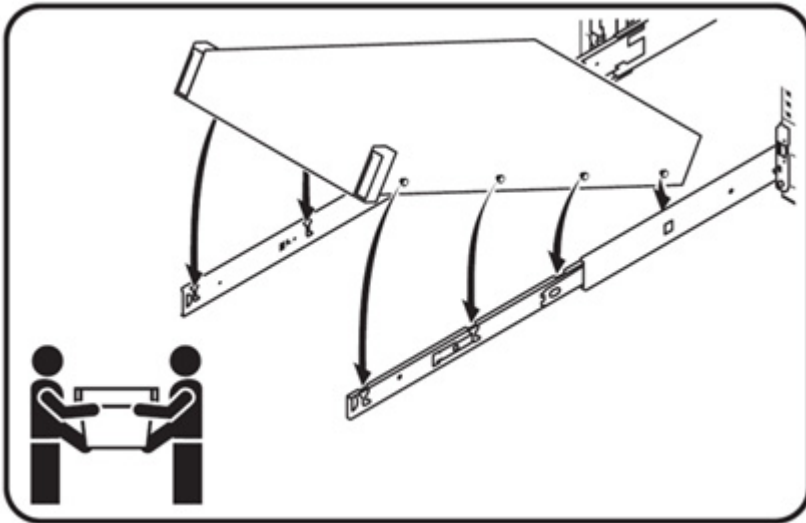

NOTE: The 2U system requires two people for installation due to its heavier weight.

Installing the system into the rack (option A: Drop-In)

The sliding rails are a "drop-in" design. This means that the system is installed vertically into the rails by inserting the standoffs on the sides of the system into the "J-slots" in the inner rail members with the rails in the fully extended position. As with all 2U systems, a minimum of two people are required in order to properly install the system in the rails.

1. Pull the inner rails out of the rack until they lock into place.



Figure 27. Pull out inner rail

2. Locate the rear rail standoff on each side of the system and lower them into the rear J-slots on the slide assemblies.
3. Rotate the system downward until all the rail standoffs are seated in the J-slots.

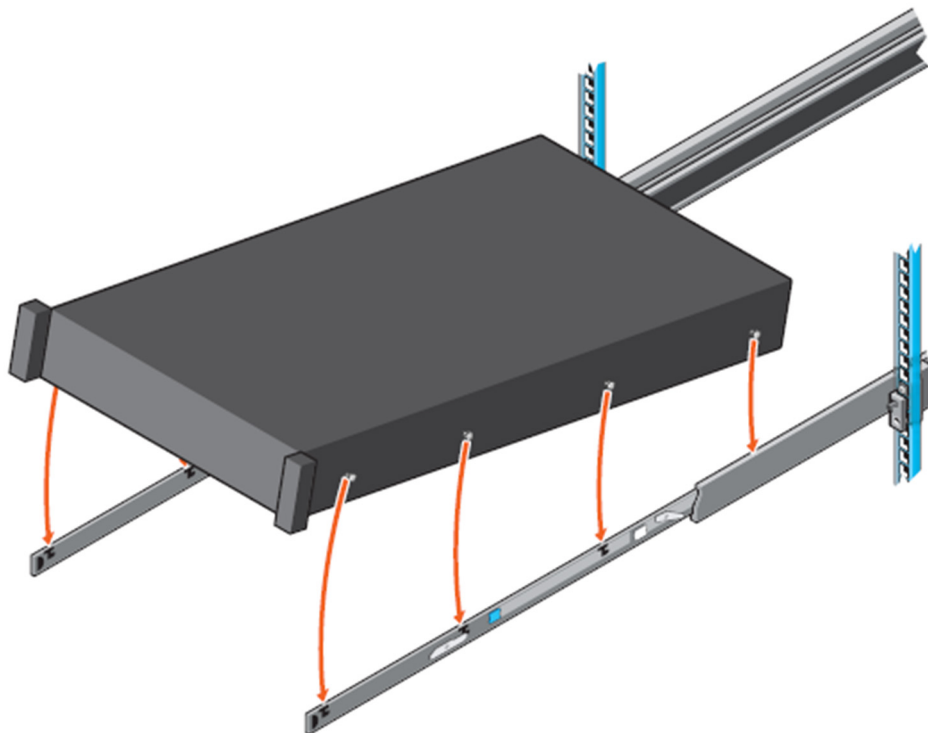

Figure 28. Rail standoffs seated in J-slots

4. Push the system inward until the lock levers click into place
5. Pull the blue slide release lock tabs forward on both rails and slide the system into the rack until the system is in the rack.

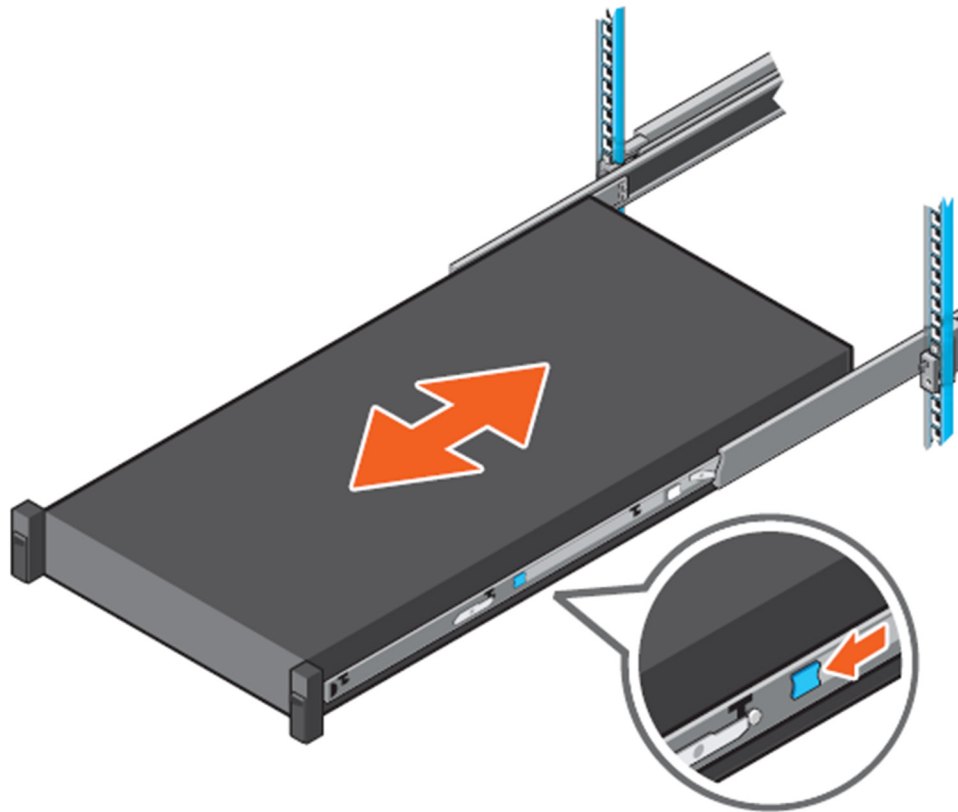

Figure 29. Slide system into the rack

Installing the system into the rack (option B: Stab-In)

The static rails are a "stab-in" design. This means that the inner (chassis) rail members must first be attached to the sides of the system and then inserted into the outer (cabinet) members installed in the rack.

1. Pull the intermediate rails out of the rack until they lock into place.
2. Release the inner rail lock by pulling forward on the white tabs and sliding the inner rail out of the intermediate rails.

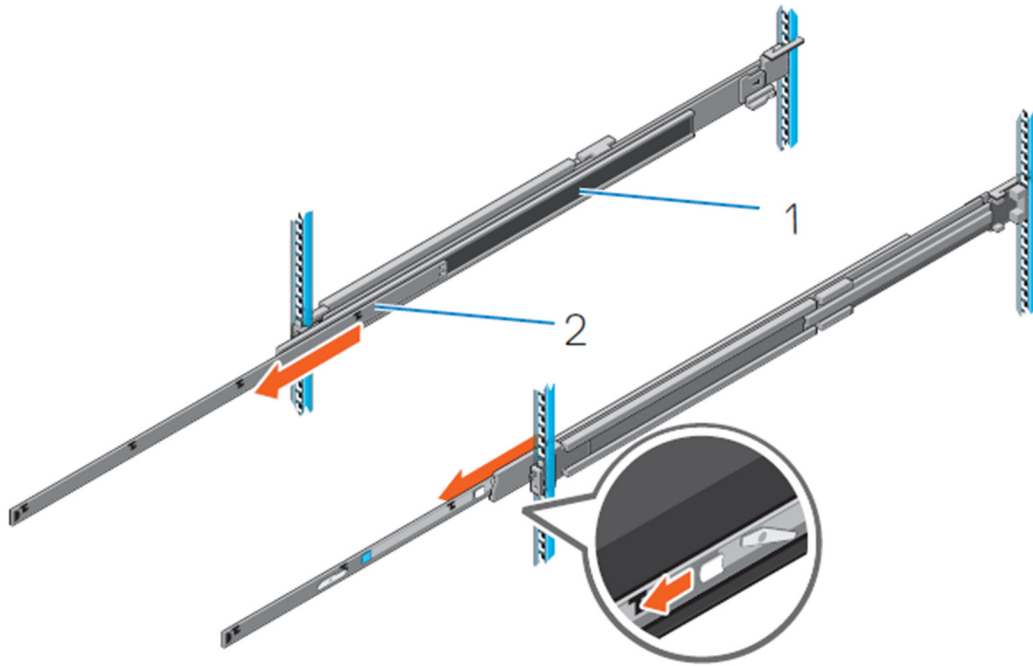

Figure 30. Pull out the intermediate rail

Table 29. Rail component

Rail component	
1	Intermediate rail
2	Inner rail

3. Attach the inner rails to the sides of the system by aligning the J-slots on the rail with the standoffs on the system and sliding forward on the system until they lock into place.

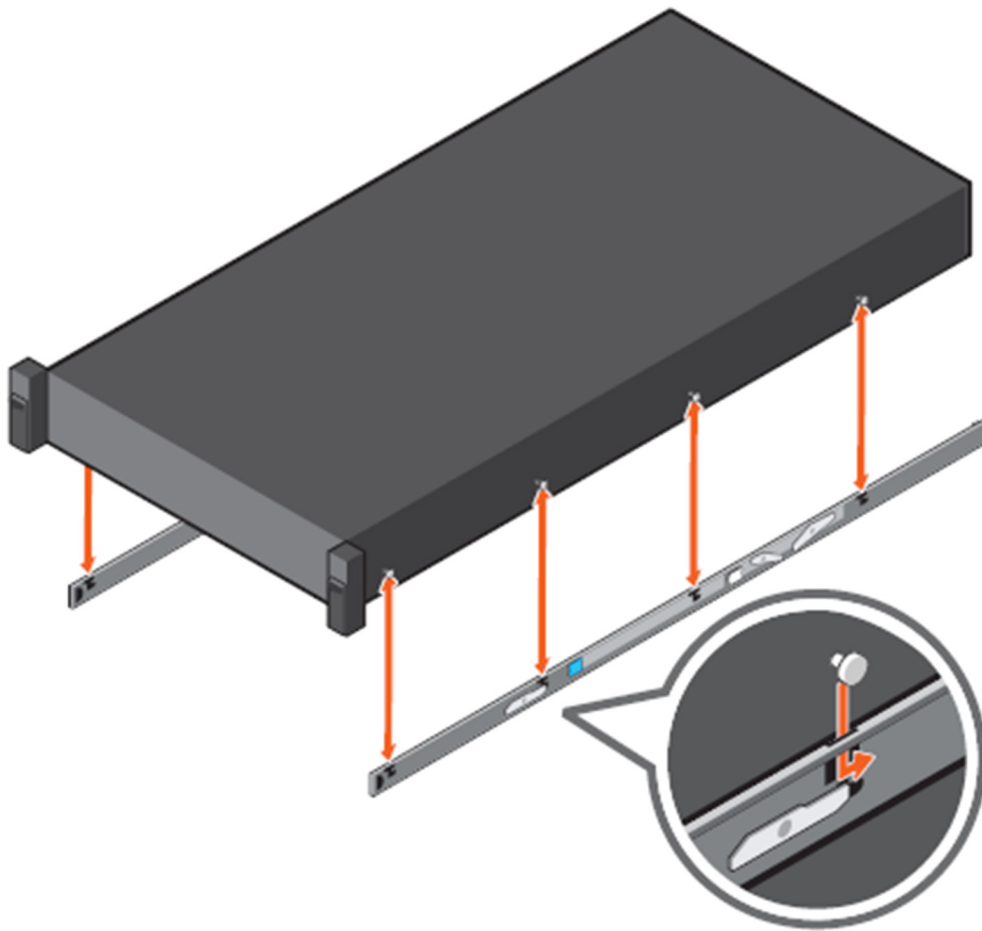

Figure 31. Attach the inner rails to the system

4. With the intermediate rails extended, install the system into the extended rails.

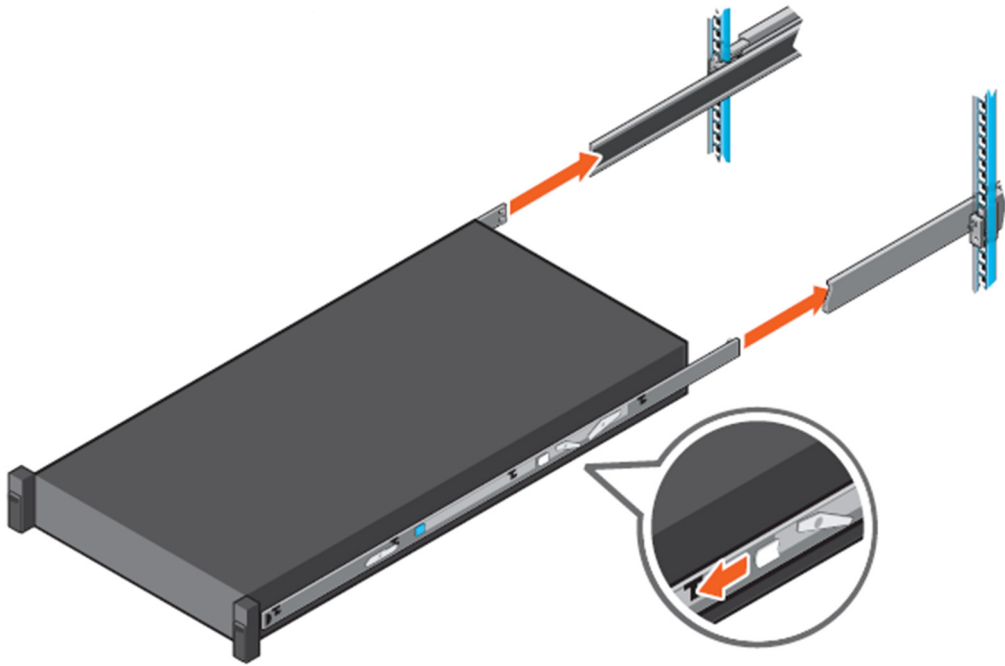

Figure 32. Install system into the extended rails

5. Pull the blue slide release lock tabs forward on both the rails ,and slide the system into the rack.

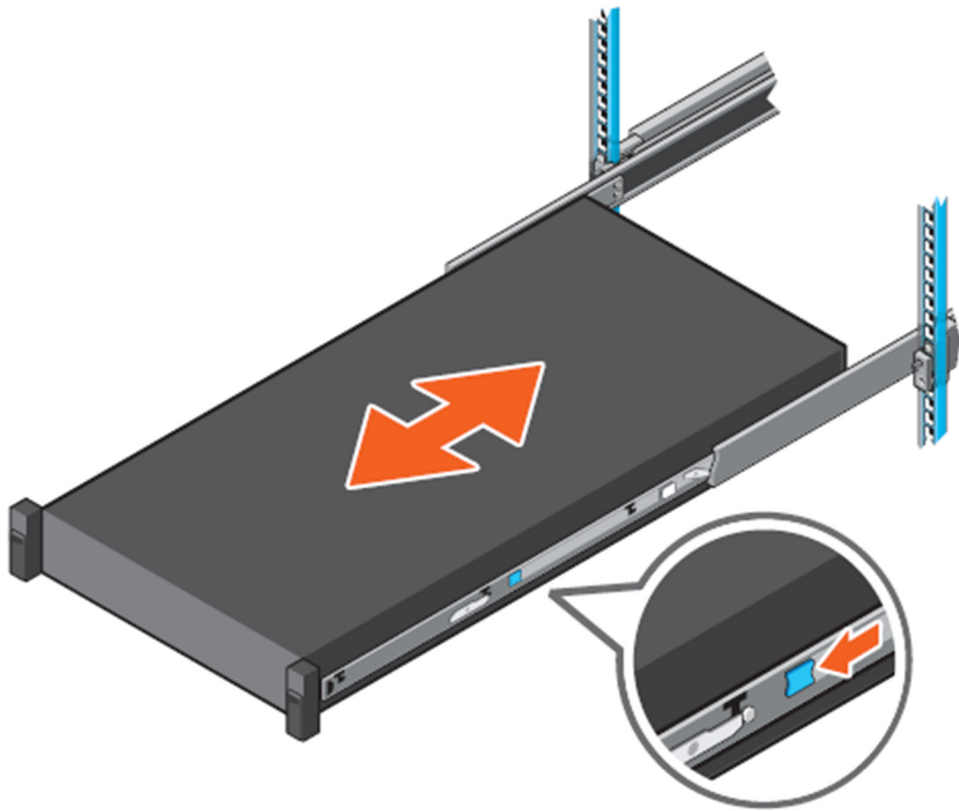

Figure 33. Slide system into the rack

Initialization

After you receive your system, you must set up your system, install the operating system, and set up and configure the system iDRAC IP address for system management.

Setting up your system

- Unpack the system.
- If applicable, install the system into the rack.
- Connect any peripherals to the system.
- Connect the system to its electrical outlet.
- Power on the system by pressing the power button.
- Power on the attached peripherals.

Methods of setting up and configuring the iDRAC IP address

You can set up the Integrated Dell Remote Access Controller (iDRAC) IP address by using one of the following interfaces:

1. iDRAC Settings utility
2. Lifecycle Controller
3. Dell Deployment Toolkit

To enable communication between your system and iDRAC, you must first configure the network settings based on your network infrastructure.

 **NOTE:** For static iDRAC IP configuration, you must request for it at the time of purchase.

This option is set to **DHCP** by Default. You can set up the IP address by using one of the following interfaces:

1. iDRAC Web Interface
2. Remote Access Controller Admin (RACADM)
3. Remote Services that include Web Services Management -WSMAN

For more information on setting up and configuring iDRAC, see the [Integrated Dell Remote Access Control User's Guide](#).

Information about logging in to iDRAC

You can log in to iDRAC as an iDRAC local user, as a Microsoft Active Directory user, or as a Lightweight Directory Access Protocol (LDAP) user. You can also log in using Single Sign-On or a Smart Card. The default user name is **root**, and default password is random unless customer choose to use **calvin** as password at the point of sales. For more information on logging in to the iDRAC and iDRAC licenses, see [Integrated Dell Remote Access Control User's Guide](#).

You can also access iDRAC using RACADM. For more information, see [RACADM Command Line Interface Reference Guide and Integrated Dell Remote Access Controller User's Guide](#).

Basic configuration

Once the system has been set up correctly, users may perform further configurations such as operating system installation, remote management, and also drivers/firmware installation.

Methods of installing the operating system

You can install the supported operating system on the system, if the system has been shipped without an operating system, use the following methods:

- Dell Systems Management Tools and Documentation media-See the operating system documentation at Dell.com/operatingsystemmanuals.
- Dell Lifecycle Controller-See the Lifecycle Controller documentation at Dell.com/esmanuals.
- Dell OpenManage Deployment Toolkit-See the OpenManage documentation at Dell.com/openmanagemanuals

For information on the list of operating systems supported on your system, see the operating systems support matrix at Dell.com/ossupport.

Remote management

To perform out-of-band systems management using iDRAC, you must configure iDRAC for remote accessibility, set up the management station and managed system, and configure the supported web browsers. For more information, see the iDRAC User's Guide at Dell.com/esmanuals.

You can also remotely monitor and manage the system, using the Dell OpenManage Server Administrator (OMSA) software and OpenManage Essentials (OME) systems management console. For more information, see Dell.com/openmanagemanuals.

Downloading and installing drivers and firmware

It is recommended that you download and install the latest BIOS, drivers, and systems management firmware on your system.

 **NOTE:** Ensure that you clear the web browser cache.

1. Go to Dell.com/support/drivers.
2. In the **Product Selection** section, enter the service tag of your system in the **Service Tag** or **Express Service Code** field.

 **NOTE:** If you do not have the service tag, select **Automatically detect my Service Tag for me** to allow the system to automatically detect your service tag, or select **Choose from a list of all Dell products** to select your product from the **Product Selection** page.

3. Click Get drivers and downloads. The drivers that are applicable to your selection are displayed.
4. Repeat steps 1 through 3 to download the HDD zoning configuration utility.
5. Search by Category and click the **System utilities. HDD Zoning Configuration Utility** is displayed.

Accessing system information by using QRL

You can use the Quick Resource Locator (QRL) to get immediate access to the information about your system. The QRL is located on the top of the system cover.

Prerequisites

Ensure that your smartphone or tablet has the QR code scanner installed.

The QRL includes the following information about your system:

- How-to videos
- Reference materials, including the Owner's Manual, LCD diagnostics, and mechanical overview.
- Your system service tag to quickly access your specific hardware configuration and warranty information.

- A direct link to Dell to contact technical assistance and sales teams

Steps

1. Go to **Dell.com/QRL** and navigate to your specific product or
2. Use your smartphone or tablet to scan the model-specific Quick Resource (QR) code on your Dell system or in the Quick Resource Locator section.

Quick Resource Locator for 7920R



Technology and components

The following sections contain information about the technology and components in the system.

Topics:

- [iDRAC9](#)
- [Dell Lifecycle Controller](#)
- [Processors](#)
- [Chipset](#)
- [System memory](#)
- [LCD panel](#)
- [Expansion cards and expansion card risers](#)
- [Storage](#)
- [Power supply units](#)
- [Trusted platform module](#)

iDRAC9

The Integrated Dell Remote Access Controller (iDRAC) is designed to make system administrators more productive and improve the overall availability of Dell system. iDRAC alerts administrators to system issues, helps them perform remote system management, and reduces the need for physical access to the system.

iDRAC with Lifecycle Controller technology is part of a larger data center solution that helps keep business critical applications and workloads available always. The technology allows administrators to deploy, monitor, manage, configure, update, troubleshoot and remediate Dell system from any location, and without the use of agents. It accomplishes this regardless of operating system or hypervisor presence or state.

iDRAC9 is available in the following variants:

- **iDRAC9 Express** - available by default on all 600 and higher series of rack or tower systems, and all sled systems.
- **iDRAC9 Enterprise** - available on all system models.

For more information, see the [Integrated Dell Remote Access Control User's Guide](#).

iDRAC 9 - New features

The following list contains the key new features available on iDRAC9:

- Added support for Redfish 2016.R1 and .R2, a RESTful Application Programming Interface (API), which is standardized by the Distributed Management Task Force (DMTF). It provides a scalable and secure systems management interface.
- Enhanced iDRAC RESTful API support for System Configuration Profiles with access via local file streaming and via HTTP/S file transfer.
- Added System Configuration Profile support for firmware repository-based updates and JSON file format.
- Export and import System Configuration Profiles from the iDRAC GUI.
- Quick Sync 2 replaces Quick Sync NFC (Near Field Communication) with BLE (Bluetooth Low Energy) and Wi-Fi for high throughput. Supports iDRAC GUI and Virtual Console access.
- Added support for HTTP/HTTPS file transfers
- Added support for WSman streaming for System Configuration Profiles.
- Added new feature Group Manager. All iDRACs in the same subnet can be grouped together and the systems can be grouped and managed by one master iDRAC of the group.
- Added Security Banner for GUI log in page.
- Multi Vector Cooling for better air flow cooling of 3rd party PCIe cards.
- DHCP is the default iDRAC IP address (static was the default on previous generations).

- Default password is randomly generated and printed on the pull out information tag, unless the legacy “root/calvin” was ordered from the factory.
- iDRAC Direct USB on the front of the system is now a Micro B slot, and is hard wired to iDRAC only for increased security.
- Added new System Lockdown feature to restrict use of Dell tools to make changes to BIOS, iDRAC, firmware, etc.
- iDRAC Service Module (iSM) is pre-installed on the iDRAC and can be surfaced to the OS; nothing to download.
- SupportAssist can be set up through the iDRAC for 1x1 ‘phone home’ service to Dell Support.
- SupportAssist Collector now includes iDRAC core dumps, hardware crash dumps, and ESXi logs.
- SupportAssist viewer - option to export HTML5 formatted report for customer viewing by standard web browsers.
- Full HTML5 web interface for faster page loading and ease of use.
- BIOS configuration in the iDRAC GUI.
- Expanded storage functions via iDRAC, such as Online Capacity Expansion (OCE) and RAID Level Migration (RLM) without the use of agents, via GUI or CLI.
- Improved add/delete of iDRAC Users.
- Streamlined alerts configuration.
- Added Power Control and Next Boot options in HTML5 vConsole.
- Added feature Connection View provide the switch and port for iDRAC, LOM’s and Dell supported PCIe cards.
- Internal 16GB vFlash card (optional).
- Bezel with LCD panel (optional).

Dell Lifecycle Controller

 **NOTE:** This is an overview of the Lifecycle Controller. For more information about Dell LifeCycle Controller, see dell.com/idracmanuals.

iDRAC9 with Lifecycle Controller

Dell Lifecycle Controller provides advanced embedded systems management to perform systems management tasks such as deploy, configure, maintain, and diagnose by using a graphical user interface (GUI). It is delivered as part of integrated Dell Remote Access Controller (iDRAC) out-of-band solution and embedded Unified Extensible Firmware Interface (UEFI) applications in the latest Dell systems. iDRAC works with the UEFI firmware to access and manage every aspect of the hardware, including component and subsystem management that is beyond the traditional Baseboard Management Controller (BMC) capabilities.

 **NOTE:** Out-of-band lifecycle management are no longer supported as of December 2019. Read KB article [SLN321599](https://support.dell.com/kb/SLN321599) .

Benefits of using iDRAC with Lifecycle Controller

The benefits of using iDRAC with Lifecycle Controller includes:

- Increased availability—Early notification of potential or actual failures that help prevent a system failure or reduce recovery time after failure.
- Improved productivity and lower Total Cost of Ownership (TCO) — Extending the reach of administrators to larger numbers of distant systems can make the IT staff more productive while driving down operational costs such as travel.
- Secure environment—By providing secure access to remote systems, administrators can perform critical management functions while maintaining system and network security.
- Enhanced embedded management through Lifecycle Controller - Lifecycle Controller provides deployment and simplified serviceability through Lifecycle Controller GUI for local deployment and remote services (Redfish, Racadm, and WS-Man) interfaces for remote deployment integrated with Dell OpenManage Essentials and partner consoles.

Key features

The key features of Lifecycle Controller are:

- System erase - Deletes the system and storage-related data on selected components of a system. You can delete information pertaining to BIOS, Lifecycle Controller logs, iDRAC settings, and storage components on the system. However, you cannot delete the iDRAC license information.
- Security - Support local key encryption.
- Restoring the system - Back up the system profile, including RAID configuration, and restore the system to a previously known state. Importing a system license, firmware rollback, and restoring system configuration if there is system board replacement.
- Easy Restore - Automatically restore hardware configuration and license information after a system board replacement
- SupportAssist Collection - Gathers all hardware and OS logs and inventory information required for technical support.
- Lifecycle Controller logs for troubleshooting.
- Hardware inventory - Provides information about the current and factory system configuration.

Starting Lifecycle Controller

To start Lifecycle Controller, restart the system and press **<F10>** during POST to select Lifecycle Controller from the list displayed. When Lifecycle Controller is started for the first time, the Settings wizard is displayed which allows you to configure the language and network settings.

Processors

The Precision 7920 Rack systems feature the Intel Xeon scalable processor family(Skylake-SP) offers versatility across diverse workloads. These processors are designed for next-generation data centers running on, software defined infrastructure supercharged for efficiency, performance, and agile services delivery across cloud-native and traditional applications. The Intel Xeon scalable processor family support workloads for cloud, high-performance computing, networking, and also storage for data centers.

Processor features

The new Intel Xeon scalable processor family is the next generation core architecture with improved Instructions per Cycle (IPC) and other architectural improvements. The Intel Xeon scalable processor family not only adds new features, but also improves upon many features of the predecessor Intel Xeon processor E5-2600 v4 product family, including:

- Virtual address space of 48 bits and a physical address space of 46 bits.
- Intel Hyper-Threading Technology (Intel® HT Technology) when enabled allow each core to support two threads.
- First Level Cache (FLC) 64 KB total. The FLC is comprised of a 32 KB ICU (Instruction Cache) and 32 KB DCU (Data Cache)
- MB Mid-Level Cache (MLC) per core (non-inclusive with the LLC).
- Intel® Advanced Vector Extensions 512 (Intel® AVX-512) with a single AVX512 fused multiply-add (FMA) execution units. processors which support Advanced RAS enable a 2nd FMA execution unit.

Supported processors

Table 30. Supported Processors for Precision 7920 Rack

Model	Intel SKU	SKU type	Dell DPN	Speed(G Hz)	Cache(M B)	QPI(GT/s)	Max Memory Speed(MT/s)	Cores	Turbo	TDP
Intel Xeon Scalable Processor	3106	Bronze	FH30X	1.7	24.75	9.6	2133	8	No Turbo	85W

Table 30. Supported Processors for Precision 7920 Rack (continued)

Model	Intel SKU	SKU type	Dell DPN	Speed(GHz)	Cache(MB)	QPI(GT/s)	Max Memory Speed(MT/s)	Cores	Turbo	TDP
Intel Xeon Scalable Processor	3104	Bronze	JNFW5	1.7	19.25	9.6	2133	6	No Turbo	85W
Intel Xeon Scalable Processor	6148	Gold	MXCY0	2.4	27.5	10.4	2400	20	Turbo	150W
Intel Xeon Scalable Processor	6154	Gold	0H31R	3	24.75	10.4	2400	18	Turbo	200W
Intel Xeon Scalable Processor	6150	Gold	J9C40	2.7	24.75	10.4	2400	18	Turbo	165W
Intel Xeon Scalable Processor	6142	Gold	1JJHM	2.6	22	10.4	2400	16	Turbo	150W
Intel Xeon Scalable Processor	6132	Gold	PYJN7	2.6	19.25	10.4	2400	14	Turbo	140W
Intel Xeon Scalable Processor	6136	Gold	CVWTJ	3	24.75	10.4	2400	12	Turbo	150W
Intel Xeon Scalable Processor	6126	Gold	F56GN	2.6	19.25	10.4	2400	12	Turbo	125W
Intel Xeon Scalable Processor	6134	Gold	NFXK9	3.2	24.75	10.4	2400	8	Turbo	130W
Intel Xeon Scalable Processor	6128	Gold	M6PT0	3.4	19.25	10.4	2400	6	Turbo	115W

Table 30. Supported Processors for Precision 7920 Rack (continued)

Model	Intel SKU	SKU type	Dell DPN	Speed(GHz)	Cache(MB)	QPI(GT/s)	Max Memory Speed(MT/s)	Cores	Turbo	TDP
Intel Xeon Scalable Processor	5122	Gold	6JMR6	3.6	16.5	10.4	2400	4	Turbo	105W
Intel Xeon Scalable Processor	6152	Gold	Y1HH1	2.1	30.25	10.4	2400	22	Turbo	140W
Intel Xeon Scalable Processor	6138	Gold	5R52V	2	27.5	10.4	2400	20	Turbo	125W
Intel Xeon Scalable Processor	6140	Gold	DTTYM	2.3	24.75	10.4	2400	18	Turbo	140W
Intel Xeon Scalable Processor	6130	Gold	XJ73T	2.1	22	10.4	2400	16	Turbo	125W
Intel Xeon Scalable Processor	5120	Gold	7051X	2.2	19.25	10.4	2400	14	Turbo	105W
Intel Xeon Scalable Processor	5118	Gold	4J8WW	2.3	16.5	10.4	2400	12	Turbo	105W
Intel Xeon Scalable Processor	5115	Gold	9JV7H	2.4	13.75	10.4	2400	10	Turbo	85W
Intel Xeon Scalable Processor	8180	Platinum	K2XNJ	2.5	38.5	10.4	2666	28	Turbo	205W
Intel Xeon Scalable Processor	8168	Platinum	1PCFM	2.7	33	10.4	2666	24	Turbo	205W

Table 30. Supported Processors for Precision 7920 Rack (continued)

Model	Intel SKU	SKU type	Dell DPN	Speed(GHz)	Cache(MB)	QPI(GT/s)	Max Memory Speed(MT/s)	Cores	Turbo	TDP
Intel Xeon Scalable Processor	8156	Platinum	HV7Y2	3.6	16.5	10.4	2666	4	Turbo	105W
Intel Xeon Scalable Processor	8176	Platinum	35TP4	2.1	22	10.4	2666	16	Turbo	120W
Intel Xeon Scalable Processor	8170	Platinum	0Y6D1	2.1	35.75	10.4	2666	26	Turbo	165W
Intel Xeon Scalable Processor	8164	Platinum	6X9YX	2	35.75	10.4	2666	26	Turbo	150W
Intel Xeon Scalable Processor	8160	Platinum	6DKVT	2.1	33	10.4	2666	24	Turbo	150W
Intel Xeon Scalable Processor	4116	Silver	D4NCN	2.1	16.5	9.6	2400	12	Turbo	85W
Intel Xeon Scalable Processor	4114	Silver	C6RY1	2.2	13.75	9.6	2400	10	Turbo	85W
Intel Xeon Scalable Processor	4112	Silver	6YC56	2.6	16.5	9.6	2400	4	Turbo	85W
Intel Xeon Scalable Processor	4110	Silver	7KW7T	2.1	24.75	9.6	2400	8	Turbo	85W
Intel Xeon Scalable Processor	4108	Silver	6YFV1	1.8	24.75	9.6	2400	8	Turbo	85W

Table 30. Supported Processors for Precision 7920 Rack (continued)

Model	Intel SKU	SKU type	Dell DPN	Speed(GHz)	Cache(MB)	QPI(GT/s)	Max Memory Speed(MT/s)	Cores	Turbo	TDP
Intel Xeon processor	3204	Gold	MTH64	1.9	8.25	9.6	2133	6	No Turbo	85W
Intel Xeon processor	4208	Silver	G1M20	2.10	11	9.6	2400	8	Turbo	85W
Intel Xeon processor	4210	Silver	MWPK2	2.2	13.75	9.6	2400	10	Turbo	85W
Intel Xeon processor	4214	Silver	71N63	2.2	16.5	9.6	2400	12	Turbo	85W
Intel Xeon processor	4215	Silver	HWMRK	2.5	11	9.6	2400	8	Turbo	85W
Intel Xeon processor	4216	Silver	5T94K	2.1	22	9.6	2400	16	Turbo	100W
Intel Xeon processor	5215	Gold	NG67F	2.5	13.75	10.4	2667	10	Turbo	85W
Intel Xeon processor	5215L	Gold	6K1Y0	2.5	13.75	10.4	2667	10	Turbo	85W
Intel Xeon processor	5215M	Gold	67J07	2.5	13.75	10.4	2667	10	Turbo	85W
Intel Xeon processor	5217	Gold	22K8M	3.0	11	10.4	2667	8	Turbo	115W
Intel Xeon processor	5218	Gold	T4V7N	2.3	22	10.4	2667	16	Turbo	125W
Intel Xeon processor	5220	Gold	2KXG9	2.2	24.75	10.4	2667	18	Turbo	125W
Intel Xeon	5222	Gold	98VCX	3.8	16.5	10.4	2667	4	Turbo	105W

Table 30. Supported Processors for Precision 7920 Rack (continued)

Model	Intel SKU	SKU type	Dell DPN	Speed(GHz)	Cache(MB)	QPI(GT/s)	Max Memory Speed(MT/s)	Cores	Turbo	TDP
processor										
Intel Xeon processor	6230	Gold	95XN2	2.1	27.5	10.4	2933	20	Turbo	125W
Intel Xeon processor	6240	Gold	T5T3W	2.16	24.75	10.4	2933	18	Turbo	150W
Intel Xeon processor	6242	Gold	MT2VR	2.8	22	10.4	2933	16	Turbo	150W
Intel Xeon processor	6244	Gold	436R7	3.6	24.75	10.4	2933	8	Turbo	150W
Intel Xeon processor	6248	Gold	VDKWR	27.5	27.5	10.4	2933	20	Turbo	150W
Intel Xeon processor	6252	Gold	5G75W	2.1	35.75	10.4	2933	24	Turbo	150W
Intel Xeon processor	6254	Gold	HNYX1	3.1	24.75	10.4	2933	18	Turbo	200
Intel Xeon processor	8253	Platinum	75KJ1	2.2	22	10.4		16	Turbo	125W
Intel Xeon processor	8256	Platinum	3D9K3	3.8	16.5	10.4		4	Turbo	105W
Intel Xeon processor	8260	Platinum	657WT	2.4	35.75	10.4		24	Turbo	165W
Intel Xeon processor	8260L	Platinum	CWDV3	2.4	35.75	10.4		24	Turbo	165W
Intel Xeon processor	8260M	Platinum	XY239	2.4	35.75	10.4		24	Turbo	165W

Table 30. Supported Processors for Precision 7920 Rack (continued)

Model	Intel SKU	SKU type	Dell DPN	Speed(GHz)	Cache(MB)	QPI(GT/s)	Max Memory Speed(MT/s)	Cores	Turbo	TDP
Intel Xeon processor	8268	Platinum	RGDKN	2.9	35.75	10.4		24	Turbo	205W
Intel Xeon processor	8270	Platinum	KKGKH	2.7	35.75	10.4		26	Turbo	205W
Intel Xeon processor	8276	Platinum	6FRK6	2.2	38.5	10.4		28	Turbo	165W
Intel Xeon processor	8276L	Platinum	2TY70	2.2	38.5	10.4		28	Turbo	165W
Intel Xeon processor	8276M	Platinum	2VXY4	2.2	38.5	10.4		28	Turbo	165W
Intel Xeon processor	8280	Platinum	CNRY3	2.7	38.5	10.4		28	Turbo	205W
Intel Xeon processor	8280L	Platinum	7HY3W	2.7	38.5	10.4		28	Turbo	205W
Intel Xeon processor	8280M	Platinum	X7R7Y	2.7	38.5	10.4		28	Turbo	205W

Processor Configurations

The Precision 7920 Rack supports up to two processors with up to 28 cores per processor.

Single CPU Configuration

The Precision 7920 Rack will function normally if there is just a single processor placed in the CPU1 socket . However, CPU and memory blank associated with CPU2 are required to be populated for thermal reasons. The system will not boot if only CPU2 socket is populated. With single CPU configuration all three PCIe slots in Riser 1C and PCIe slot 6 in Riser 2A will be functional.

Chipset

The Precision 7920 Rack systems use the Intel C620 chipset (Lewisburg PCH) that provides extensive I/O support. Functions and capabilities include:

- ACPI Power Management Logic Support, Revision 4.0a

- PCI Express* Base Specification Revision 3.0
- Integrated Serial ATA host controller, supports data transfer rates of up to 6 Gb/s on all ports.
- xHCI USB controller with SuperSpeed USB 3.0 ports
- Direct Media Interface
- Serial Peripheral Interface
- Enhanced Serial Peripheral Interface
- Flexible I/O - Allows some high speed I/O signals to be configured as PCIe root ports, PCIe uplink for use with certain PCH SKUs, SATA (and sSATA), or USB 3.0.
- General Purpose Input Output (GPIO)
- Low Pin Count interface, interrupt controller, and timer functions
- System Management Bus Specification, Version 2.0
- Integrated Clock Controller / Real Time Clock Controller
- Intel® High Definition Audio and Intel® Smart Sound Technology
- Integrated 10/1 Gb Ethernet
- Integrated 10/100/1000 Mbps Ethernet MAC
- Supports Intel® Rapid Storage Technology Enterprise
- Supports Intel® Active Management Technology and System Platform Services
- Supports Intel® Virtualization Technology for Directed I/O
- Supports Intel® Trusted Execution Technology
- JTAG Boundary Scan support
- Intel® QuickAssist Technology
- Intel® Trace Hub for debug

For more information, visit [Intel.com](https://www.intel.com)

System memory

The system supports DDR4 registered DIMMs (RDIMMs) and load reduced DIMMs (LRDIMMs). System memory holds the instructions that are executed by the processor.

i **NOTE:** MT/s indicates DIMM speed in MegaTransfers per second.

Memory bus operating frequency can be 2133 MT/s, 2400 MT/s, or 2666 MT/s depending on the following factors:

- DIMM type (RDIMM or LRDIMM)
- Number of DIMMs populated per channel
- System profile selected (for example, Performance Optimized, Custom, or Dense Configuration Optimized)
- Maximum supported DIMM frequency of the processors

Your system contains 24 memory sockets split into two sets of 12 sockets, one set per processor. Each 12-sockets is organized into six channels. Two sockets per channel with the release tabs of the first socket marked white and the second socket black.

i **NOTE:** DIMMs in sockets A1 to A12 are assigned to processor 1 and DIMMs in sockets B1 to B12 are assigned to processor 2.

Table 31. Maximum memory module

Frequency supported	Processors
2133	31xx series
2400	41xx series
2400	51xx series
2666	61xx series

Memory channels are organized as follows:

Table 32. Memory channels

Processor	Channel 0	Channel 1	Channel 2	Channel 3	Channel 4	Channel 5
CPU 1	Slots A1, A7	Slots A2, A8	Slots A3, A9	Slots A4, A10	Slots B5, A11	Slots A6, A12

Table 32. Memory channels (continued)

Processor	Channel 0	Channel 1	Channel 2	Channel 3	Channel 4	Channel 5
CPU2	Slots B1, B7	Slots B2, B8	Slots B3, B9	Slots B4, B10	Slots B5, B11	Slots B6, B12

General memory module installation guidelines

NOTE: Memory configurations that fail to observe these guidelines can prevent your system from booting, stop responding during memory configuration, or operating with reduced memory.

Enabling the system to be configured and run in any valid chipset architectural configuration. The following are the recommended guidelines for installing memory modules:

- RDIMMs and LRDIMMs must not be mixed.
- x4 and x8 DRAM based memory modules can be mixed.
- Up to two RDIMMs can be populated per channel regardless of rank count.
- Up to two LR DIMMs can be populated per channel regardless of rank count.
- If memory modules with different speeds are installed, they will operate at the speed of the slowest installed memory module(s) or slower depending on the system DIMM configuration.
- Populate memory module sockets only if a processor is installed. For single-processor systems, sockets A1-A12 are available. For dual-processor systems, sockets A1 to A12 and sockets B1 to B12 are available.
- Populate all the sockets with white release tabs first, followed by the black release tabs.
- In a dual-processor configuration, the memory configuration for each processor should be identical. For example, if you populate socket A1 for processor 1, then populate socket B1 for processor 2, and so on.
- Populate six memory modules per processor (one DIMM per channel) at a time to maximize performance.

Memory

The Precision 7920 Rack supports up to 24 DIMMs, with up to 1536GB of memory and speeds of up to 2666MT/s.

The Precision 7920 Rack supports registered (RDIMMs) and load reduced DIMMs (LRDIMMs) which use a buffer to reduce memory loading and provide greater density, allowing for the maximum platform memory capacity.

DIMMs supported

Table 33. Memory technologies supported

Feature	Precision 7920 Rack (DDR4)
DIMM Type	RDIMM
	LRDIMM
Transfer Speed	2666 MT/s
	2400 MT/s
	2133 MT/s
Voltage	1.2V (DDR4)

NOTE: Unbuffered DIMMs (UDIMMs) are not supported in Precision 7920 Rack

The Precision 7920 Rack supports the following DIMMs.

Table 34. DIMMs supported

DIMM Capacity(GB)	DIMM Speed	DIMM Type	Ranks per DIMM	Data Width	SDDC Support	DIMM Voltage
8	2666MT/s	RDIMM	1	x8	Advanced ECC	1.2
16	2666MT/s	RDIMM	2	x8	Advanced ECC	1.2

Table 34. DIMMs supported (continued)

DIMM Capacity(GB)	DIMM Speed	DIMM Type	Ranks per DIMM	Data Width	SDDC Support	DIMM Voltage
32	2666MT/s	RDIMM	2	x4	All Modes	1.2
64	2666MT/s	LRDIMM	4	x4	All Modes	1.2

Memory Speed

The Precision 7920 Rack supports memory speeds of 2666 MT/s, 2400 MT/s, and 2133 MT/s depending on the DIMM types installed and the configuration. All memory on all processors and channels run at the same speed and voltage. By default, this speed will be the highest speed supported by the CPU and the DIMMs. The operating speed of the DIMMs is also determined by the maximum speed supported by the processor, speed settings in the BIOS and the operating voltage of the system. Not all processors support 2666MT/s memory speed.

The table below lists the memory configuration and performance details for the Precision 7920 Rack, based on the quantity and type of DIMMs per memory channel.

Table 35. DIMM Performance Details

DIMM Type	DIMM Ranking	Capacity	DIMM Rated Voltage, Speed	1 DPC	2 DPC
RDIMM	1R/2R	8GB, 16GB, 32GB	DDR4 (1.2V)	i: 2666 D:2666	i: 2400 D:2666
LRDIMM	4R	64GB	DDR4 (1.2V)	i: 2666 D:2666	i: 2400 D:2666

LCD panel

The LCD panel provides system information, status, and error messages to indicate if the system is functioning correctly or requires attention. The LCD panel can also be used to configure or view the system's iDRAC IP address. For information about the event and error messages generated by the system firmware and agents that monitor system components, see the Error Code Lookup page at url.dell.com.

The LCD panel is available only on the optional front bezel. The optional front bezel is hot pluggable.

The statuses and conditions of the LCD panel are outlined here:

- The LCD backlight is white during normal operating conditions.
- When the system needs attention, the LCD backlight turns amber, and displays an error code followed by descriptive text.
 - ① **NOTE:** If the system is connected to a power source and an error is detected, the LCD turns amber regardless of whether the system is turned on or off.
- When the system turns off and there are no errors, LCD enters the standby mode after five minutes of inactivity. Press any button on the LCD to turn it on.
- If the LCD panel stops responding, remove the bezel and reinstall it.
 - If the problem persists, see [Getting help](#) section.
- The LCD backlight remains off if LCD messaging is turned off using the iDRAC utility, the LCD panel, or other tools.

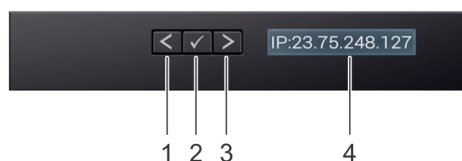



Figure 34. LCD panel features



Table 36. LCD panel features

Item	Button or display	Description
1	Left	Moves the cursor back in one-step increments.
2	Select	Selects the menu item highlighted by the cursor.
3	Right	<p>Moves the cursor forward in one-step increments.</p> <p>During message scrolling:</p> <ul style="list-style-type: none"> • Press and hold the right button to increase scrolling speed. • Release the button to stop. <p> NOTE: The display stops scrolling when the button is released. After 45 seconds of inactivity, the display starts scrolling.</p>
4	LCD display	Displays system information, status, and error messages or iDRAC IP address.

Viewing Home screen

The **Home** screen displays user-configurable information about the system. This screen is displayed during normal system operation when there are no status messages or errors. When the system turns off and there are no errors, LCD enters the standby mode after five minutes of inactivity. Press any button on the LCD to turn it on.

Steps

1. To view the **Home** screen, press one of the three navigation buttons (Select, Left, or Right).
2. To navigate to the **Home** screen from another menu, complete the following steps:
 - a. Press and hold the navigation button until the up arrow  is displayed.
 - b. Navigate to the **Home** icon  using the up arrow .
 - c. Select the **Home** icon.
 - d. On the **Home** screen, press the **Select** button to enter the main menu.

Setup menu

 **NOTE:** When you select an option in the **Setup** menu, you must confirm the option before proceeding to the next action.

Option	Description
iDRAC	Select DHCP or Static IP to configure the network mode. If Static IP is selected, the available fields are IP , Subnet (Sub) , and Gateway (Gtw) . Select Setup DNS to enable DNS and to view domain addresses. Two separate DNS entries are available.
Set error	<p>Select SEL to view LCD error messages in a format that matches the IPMI description in the SEL. This enables you to match an LCD message with an SEL entry.</p> <p>Select Simple to view LCD error messages in a simplified user-friendly description.</p>
Set home	Select the default information to be displayed on the Home screen. See View menu section for the options and option items that can be set as the default on the Home screen.

View menu

 **NOTE:** When you select an option in the **View** menu, you must confirm the option before proceeding to the next action.

Option	Description
iDRAC IP	Displays the IPv4 or IPv6 addresses for iDRAC9. Addresses include DNS (Primary and Secondary) , Gateway, IP , and Subnet (IPv6 does not have Subnet).
MAC	Displays the MAC addresses for iDRAC , iSCSI , or Network devices.
Name	Displays the name of the Host , Model , or User String for the system.
Number	Displays the Asset tag or the Service tag for the system.
Power	Displays the power output of the system in BTU/hr or Watts. The display format can be configured in the Set home submenu of the Setup menu.
Temperature	Displays the temperature of the system in Celsius or Fahrenheit. The display format can be configured in the Set home submenu of the Setup menu.

Expansion cards and expansion card risers

An expansion card in the appliance is an add-on card that can be inserted into an expansion slot on the system board or riser card to add enhanced functionality to the appliance through the expansion bus.

NOTE: A System Event Log (SEL) event is logged if an expansion card riser is unsupported or missing. It does not prevent your appliance from turning on and no BIOS POST message or F1/F2 pause is displayed.

Expansion card installation guidelines

Depending on your system configuration, the following PCI Express (PCIe) generation 3 expansion cards are supported:

Table 37. Expansion card riser specifications

Expansion card riser	PCIe slots on the riser	Processor connection	Height	Length	Link	Slot width
Riser 1C	Slot 1	Processor 1	Full Height	Full Length	x16	x16
Riser 1C	Slot 2	Processor 1	Full Height	Full Length	x8	x16
Riser 1C	Slot 3	Processor 1	Full Height	Half Length	x8	x16
Riser 2A	Slot 4	Processor 2	Full Height	Full Length	x16	x16
Riser 2A	Slot 5	Processor 2	Full Height	Full Length	x8	x16
Riser 2A	Slot 6	Processor 1	Low Profile	Half Length	x8	x16
Riser 3A	Slot 7	Processor 2	Full Height	Full Length	x8	x16
Riser 3A	Slot 8	Processor 2	Full Height	Full Length	x16	x16

NOTE: The expansion card slots are not hot-swappable.

The following table provides guidelines for installing expansion cards to ensure proper cooling and mechanical fit. The expansion cards with the highest priority should be installed first using the slot priority indicated. All the other expansion cards should be installed in the card priority and slot priority order.

Table 38. No riser configurations

Card Type	Slot priority	Maximum number of cards
NDC	NDC Slot	1
PERC	3, 1, 2	1
GFX/GPU Compute (DW)	1,4,8	3
GFX (FH/SW)	1,4,8,2,5,7	up to 6

Table 38. No riser configurations (continued)

Card Type	Slot priority	Maximum number of cards
GFX (LP)	6	1
PCIe SSD (LP) - Zoom 2	6	1
PCIe SSD (FH) - Zoom 2	1,2,3,4,5,7,8	1
PCIe SSD (FH) - Zoom 4	1,4,8	2 (*See Note 7)
Teradici (P25) (LP)	6	1
Teradici (P25 or P45) (FH)	1,2,4,5,7,8	2
Serial (FH)	1,2,4,5,7,8	1
Serial (LP)	6	1
Audio (FH)	1,2,4,5,7,8	1
Audio (LP)	6	1

Card Priority	Card Type - Category	Slot Priority	PCIe Cards																											
			PERC H330	PERC H730P	PERC H740P	nVidia GP100	nVidia P6000	FirePro W3100 / WX Box in 2018	nVidia P5000	nVidia P4000	nVidia P6000	nVidia P6000 LP	Radeon WX 7100	nVidia P2000	nVidia P4000 FH	WX 4100 LP	WX 4100 FH	WX 3100	Zoom2 LP	Zoom2 FH	Zoom4	Teradici P25 LP	Teradici P25 FH	Teradici P45 FH	Serial Port FH	Serial Port LP	Audio FH	Intel(R) Gigabit Ethernet 10GbE SFP P80C	Intel(R) Gigabit Ethernet 10GbE SFP P80C	
100	NDC	NDC Slot	1	1	1	1	1	1	1	1	1	1	1	1	1	1	1	1	1	1	1	1	1	1	1	1	1	1	1	1
200	PERC	3, 1, 2		X	X	X	X	X	X	X	X	X	X	X	X	X	X	X	X	X	X	X	X	X	X	X	X	X	X	
300	GFX (GPU Compute (DW)	1,4,8		X	X	X	X	X	X	X	X	X	X	X	X	X	X	X	X	X	X	X	X	X	X	X	X	X	X	
400	GFX (FH/SW)	1,4,8,2,5,7		X	X	X	X	X	X	X	X	X	X	X	X	X	X	X	X	X	X	X	X	X	X	X	X	X	X	
500	GFX (LP)	6		X	X	X	X	X	X	X	X	X	X	X	X	X	X	X	X	X	X	X	X	X	X	X	X	X	X	
600	PCIe SSD (LP) - Zoom 2	6		X	X	X	X	X	X	X	X	X	X	X	X	X	X	X	X	X	X	X	X	X	X	X	X	X	X	
700	PCIe SSD (FH) - Zoom 2	1,2,3,4,5,7,8		X	X	X	X	X	X	X	X	X	X	X	X	X	X	X	X	X	X	X	X	X	X	X	X	X	X	
800	PCIe SSD (FH) - Zoom 4	1,4,8		X	X	X	X	X	X	X	X	X	X	X	X	X	X	X	X	X	X	X	X	X	X	X	X	X	X	
900	Teradici (P25) (LP)	6		X	X	X	X	X	X	X	X	X	X	X	X	X	X	X	X	X	X	X	X	X	X	X	X	X	X	
1000	Teradici (P25 or P45) (FH)	1,2,4,5,7,8		X	X	X	X	X	X	X	X	X	X	X	X	X	X	X	X	X	X	X	X	X	X	X	X	X	X	
1100	Serial (FH)	1,2,3,4,5,7,8		X	X	X	X	X	X	X	X	X	X	X	X	X	X	X	X	X	X	X	X	X	X	X	X	X	X	
1200	Serial (LP)	6		X	X	X	X	X	X	X	X	X	X	X	X	X	X	X	X	X	X	X	X	X	X	X	X	X	X	
1300	Audio (FH)	1,2,3,4,5,7,8		X	X	X	X	X	X	X	X	X	X	X	X	X	X	X	X	X	X	X	X	X	X	X	X	X	X	
1400	Audio (LP)	6		X	X	X	X	X	X	X	X	X	X	X	X	X	X	X	X	X	X	X	X	X	X	X	X	X	X	

Notes:
1. Cards should be installed in the system, starting with the Card priority, then the slot priority. The first open slot priority should be used.
2. Low profile (LP), Half-Height cards can only be installed in Slot 6.
3. Slots 4, 5, 7, 8 require that CPU2 be installed in the system.
4. Any cards > 75W require one or more external power cables to be installed (power cables are included in base system BOM).
5. Graphics cards are of equal priority to each other. For multiple GPU card configs, cards must be matched (all same model).
6. nVidia GPU's using SLI must reside in slots 4 and 7 with a 2nd CPU installed. An SLI cable must also be installed.
7. Zoom4 - Dual Zoom4 requires dual CPU, and both Zoom cards must be populated on CPU2 (slots 4 & 8)

Risers	Slots							
	Slot 1	Slot 2	Slot 3	Slot 4	Slot 5	Slot 6	Slot 7	Slot 8
RSR1C - Bay 1 (right hand bay)	x16 FH/FL/DW	x8 FH/FL	x8 FH/HL					
RSR2A - Bay 2 (center bay)				x16 FH/FL/DW	x8 FH/FL	x8 LP		
RSR3A - Bay 4 (left hand bay)							x16 FH/FL	x16 FL/DW
Associated CPU	CPU1		CPU2		CPU 1		CPU 2	
Slot Power	225w + 75w	75w + 75w	75w	75w + 75w	75w	225w + 75w	75w + 75w	75w + 75w

- NOTE:**
1. Cards should be installed in the system, starting with the Card priority, then the slot priority. The first open slot priority should be used.
 2. Low profile (LP), Half-Height cards can only be installed in Slot 6.
 3. Slots 4, 5, 7, 8 require that CPU2 be installed in the system.
 4. Any cards > 75W require one or more external power cables to be installed (power cables are included in base system BOM).
 5. Graphics cards are of equal priority to each other. For multiple GPU card configs, cards must be matched (all same model).
 6. nVidia GPU's using SLI must reside in slots 4 and 7 with a 2nd CPU installed. An SLI cable must also be installed.
 7. Zoom4 - Dual Zoom4 requires dual CPU, and both Zoom cards must be populated on CPU2 (slots 4 & 8)
 8. No Teradici P25 or P45 in slot 3

Storage

The Precision 7920 Rack provide scalable storage that allows you to adapt to your workload and operational demands. The Precision 7920 Rack offers storage expansion with the front hard drive cage.

Hard Drive

The Precision 7920 Rack system supports SAS, SATA.

Supported Drives

Table 39. Supported Drives - SAS and SATA

Form Factor	Type	Speed	Rotational Speed	Capacities
2.5"	SATA, SSD	6Gb	N/A	256GB, 512GB, 480GB, 960GB
	SATA	6Gb	7.2K	500GB, 1TB, 2TB
	SAS,SSD	12Gb	N/A	400GB, 800GB
	SAS	12Gb	10K	1.8TB
	SAS	12Gb	15K	600GB
3.5"	SATA	6Gb	7.2K	1TB, 2TB, 8TB

Table 40. Supported Drives - NVMe PCIe SD

Description
256GB Device
512GB Device
1TB Device

Power supply units

The power supply unit (PSU) is an internal hardware component which supplies power to the components in the system.

Your system supports the following:

- Two 1600 W or 1100 W AC power supply units (PSUs)

 **NOTE:** For more information, see the Technical specifications section.

 **CAUTION:** If two PSUs are installed, both the PSUs must have the Extended Power Performance (EPP) label. Mixing PSUs (even the PSUs that have the same power rating) from previous generations of Precision workstation is not supported. This results in a PSU mismatch condition or failure to turn the system on.

 **NOTE:** When two identical PSUs are installed, power supply redundancy (1+1 – with redundancy or 2+0 – without redundancy) is configured in system BIOS. In redundant mode, power is supplied to the system equally from both PSUs when Hot Spare is disabled. When Hot Spare is enabled, one of the PSUs will be put into sleep mode when system utilization is low in order to maximize efficiency.

 **NOTE:** If two PSUs are used, they must be of the same maximum output power.

Hot spare feature

Your system supports the hot spare feature that significantly reduces the power overhead associated with power supply unit (PSU) redundancy.

When the hot spare feature is enabled, one of the redundant PSUs is switched to the sleep state. The active PSU supports 100 percent of the system load, thus operating at higher efficiency. The PSU in the sleep state monitors output voltage of the active PSU. If the output voltage of the active PSU drops, the PSU in the sleep state returns to an active output state.

If having both PSUs active is more efficient than having one PSU in the sleep state, the active PSU can also activate the sleeping PSU.

The default PSU settings are as follows:

- If the load on the active PSU is more than 50 percent of PSU rated power wattage, then the redundant PSU is switched to the active state.
- If the load on the active PSU falls below 20 percent of PSU rated power wattage, then the redundant PSU is switched to the sleep state.

You can configure the hot spare feature by using the iDRAC settings. For more information, see the iDRAC User's Guide available at Dell.com/idracmanuals.

Trusted platform module

The Trusted Platform Module (TPM) is used to generate and store keys, protect or authenticate passwords, and create and store digital certificates. The Intel's TXT (Trusted Execution Technology) functionality along with Microsoft's Platform Assurance feature in Windows Operating System is supported. TPM can also be used to enable the BitLocker hard drive encryption feature in Windows Operating System.

The TPM chip is on the Plug-in Module (PIM) and bound only to one system board.

The system board has a connector for the plug-in module, and it is factory-installed.

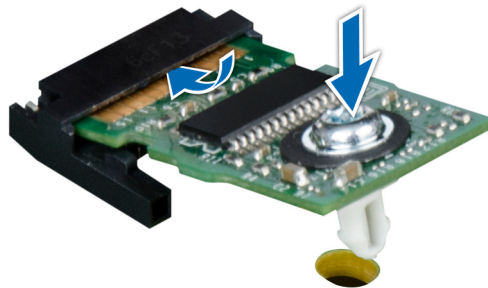

Figure 35. Trusted platform module

There are four types of TPM chip options:

- No TPM
- TPM 1.2 Nuvoton FIPS-CC-TCG
- TPM TPM 2.0 Nuvoton FIPS-CC-TCG
- TPM 2.0 NationZ

NOTE: In a scenario where both the control panel and system board are dispatched, Dell recommends you to replace the control panel first and try to turn on the system to complete the **Easy Restore** process (Service Tag, licenses, copy to the new control panel). Replace the system board.

BIOS and UEFI

You can manage basic settings and features of a system without booting to the operating system by using the system firmware.

Topics:

- [Options to manage the pre-operating system applications](#)
- [System Setup](#)
- [Updating the BIOS](#)

Options to manage the pre-operating system applications

Your system has the following options to manage the pre-operating system applications:

- System Setup
- Dell Lifecycle Controller
- Boot Manager
- Preboot Execution Environment (PXE)

System Setup

By using the **System Setup** screen, you can configure the BIOS settings, iDRAC settings, and device settings of your system.

These settings have already been preconfigured per solution requirements. Contact Dell before you change these settings.

 **NOTE:** Help text for the selected field is displayed in the graphical browser by default. To view the help text in the text browser, press F1.

You can access system setup by using two methods:

- Standard graphical browser — The browser is enabled by default.
- Text browser — The browser is enabled by using Console Redirection.

Viewing System Setup

To view the **System Setup** screen, perform the following steps:

Steps

1. Turn on, or restart your appliance.
2. Press F2 immediately after you see the following message:

```
F2 = System Setup
```

 **NOTE:** If your operating system begins to load before you press F2, wait for the system to finish booting, and then restart your appliance and try again.

System Setup Main Menu

Option	Description
System BIOS	Enables you to configure BIOS settings.
iDRAC Settings	Enables you to configure iDRAC settings. The iDRAC Settings utility is an interface to set up and configure the iDRAC parameters using UEFI. You can enable or disable various iDRAC parameters by using the iDRAC Settings utility. For more information about this utility, see the Integrated Dell Remote Access Controller User's Guide at dell.com/esmmanuals .
Device Settings	Enables you to configure device settings.
Service Tag Settings	Enables service tag of the system

System BIOS screen

You can use the **System BIOS** screen to view BIOS settings as well as edit specific functions such as boot order, system password, setup password, setting RAID mode, and enabling or disabling USB ports.

About this task

In the **System Setup Main Menu**, click **System BIOS**.

The **System BIOS** screen details are explained below.

Menu Item	Description
System Information	Displays information about the system such as the system model name, BIOS version, Service Tag, and so on.
Memory Settings	Displays information and options related to installed memory.
Processor Settings	Displays information and options related to the processor such as speed, cache size, and so on.
SATA Settings	Displays options to enable or disable the integrated SATA controller and ports.
NVMe Settings	Displays options to enable or disable the NVMe Settings.
Boot Settings	Displays options to specify the boot mode (BIOS or UEFI). Enables you to modify UEFI and BIOS boot settings.
Network Settings	Displays options to enable or disable the Network Settings
Integrated Devices	Displays options to enable or disable integrated device controllers and ports, and to specify related features and options.
Serial Communication	Displays options to enable or disable the serial ports and specify related features and options.
System Profile Settings	Displays options to change the processor power management settings, memory frequency, and so on.
System Security	Displays options to configure the system security settings like, system password, setup password, TPM security, and so on. It also enables or disables support for the power and NMI buttons on the system.
Redundant OS Control	Displays options to change the Redundant OS Control
Miscellaneous Settings	Displays options to change the system date, time, and so on.
Debug Menu Settings	This field controls serial debug output level for certain drivers.

System information screen details

You can use the **System Information** screen allows to view system properties such as Service Tag, system model, and BIOS version.

About this task

You can view the **System Information** screen by clicking **System Setup Main Menu > System BIOS > System Information**.

The **System Information** screen details are explained as follows:

Menu Item	Description
System Model Name	Displays the system model name.
System BIOS Version	Displays the BIOS version installed on the system.
System Management Engine Version	Displays the current revision of the Management Engine firmware.
System Service Tag	Displays the system Service Tag.
System Manufacturer	Displays the name of the system manufacturer.
System Manufacturer Contact Information	Displays the contact information of the system manufacturer.
System CPLD Version	Displays the current revision of the system CPLD firmware.
UEFI Compliance Version	Displays the system firmware UEFI compliance level.

Memory settings screen details

You can use the **Memory Settings** screen to view all the memory settings as well as to enable or disable specific memory functions such as system memory testing and node interleaving.

About this task

You can view the **Memory Setting** screen by clicking **System Setup Main Menu > System BIOS > Memory Settings**.

The **Memory Settings** screen details are explained as follows:

Menu Item	Description
System Memory Size	Displays the amount of memory installed in the system.
System Memory Type	Displays the type of memory installed in the system.
System Memory Speed	Displays the system memory speed.
System Memory Voltage	Displays the system memory voltage.
Video Memory	Displays the amount of video memory.

Menu Item	Description
System Memory Testing	Specifies whether system memory tests are run during system boot. Options are Enabled and Disabled . By default, the System Memory Testing option is set to Disabled .
Memory Operating Mode	Specifies the memory operating mode. By default Optimizer Mode . <i>i</i> NOTE: The Memory Operating Mode can have different defaults and available options based on the memory configuration of your system. <i>i</i> NOTE: The Dell Fault Resilient Mode establishes an area of memory that is fault resilient. This mode can be used by an operating system that supports the feature to load critical applications or enables the operating system kernel to maximize system availability.
Current State of Memory Operating Mode	Specifies current state of memory operating mode. Option is Optimizer .
Node Interleaving	Specifies if Non-Uniform Memory architecture (NUMA) is supported. If this field is Enabled , memory interleaving is supported if a symmetric memory configuration is installed. If Disabled , the system supports NUMA (asymmetric) memory configurations. By default, Node Interleaving option is set to Disabled .

Processor settings screen details



You can use the **Processor Settings** screen to view the processor settings and perform specific functions such as enabling virtualization technology, hardware prefetcher, and logical processor idling.

About this task

You can view the **Processor Settings** screen by clicking **System Setup Main Menu > System BIOS > Processor Settings**.

The **Processor Settings** screen details are explained as follows:

Menu Item	Description
Logical Processor	Enables or disables the logical processors and displays the number of logical processors. If the Logical Processor option is set to Enabled , the BIOS displays all the logical processors. If this option is set to Disabled , the BIOS only displays one logical processor per core. By default, the Logical Processor option is set to Enabled .
Virtualization Technology	Enables or disables the additional hardware capabilities provided for virtualization. By default, the Virtualization Technology option is set to Enabled .
Adjacent Cache Line Prefetch	Optimizes the system for applications that require high utilization of sequential memory access. By default, the Adjacent Cache Line Prefetch option is set to Enabled . You can disable this option for applications that require high utilization of random memory access.
Hardware Prefetcher	Enables or disables the hardware prefetcher. By default, the Hardware Prefetcher option is set to Enabled .
DCU Streamer Prefetcher	Allows you to enable or disable the Data Cache Unit (DCU) streamer prefetcher. By default, the DCU Streamer Prefetcher option is set to Enabled .
DCU IP Prefetcher	Enables or disables the Data Cache Unit (DCU) IP prefetcher. By default, the DCU IP Prefetcher option is set to Enabled .
Sub NUMA Cluster	Enables or disables the execute disable memory protection technology. By default, the Execute Disable Cluster option is set to Enabled .
Logical Processor Idling	Enables or disables the breaking up the LLC into disjoint clusters based on address range with each cluster bound to a subset the memory controllers. Option is set to Disabled .
Configurable TDP	Allows reconfiguration of Thermal Design Power (TDP) to lower levels. TDP refers to the maximum amount of power the cooling system is required to dissipate. The options are Normal (set by default) , Level 1 and Level 2
X2Apic Mode	Enables or disables the X2Apic mode.

Menu Item	Description
Dell Controlled Turbo	 NOTE: Depending on the number of installed CPUs, there may be up to four processor listings. Controls the turbo engagement. Enable this option only when System Profile is set to Performance .
Number of Cores per Processor	Controls the number of enabled cores in each processor. By default, the Number of Cores per Processor option is set to All .
Processor Core Speed	Displays the maximum core frequency of the processor.
Processor 1	 NOTE: Depending on the number of installed CPUs, there may be up to four processor listings. The following settings are displayed for each processor installed in the system.
Family-Model-Stepping	Displays the family, model and stepping of the processor as defined by Intel.
Brand	Displays the brand name reported by the processor.
Level 2 Cache	Displays the total L2 cache.
Level 3 Cache	Displays the total L3 cache.
Number of Cores	Displays the number of cores per processor.
Processor 2	 NOTE: Depending on the number of installed CPUs, there may be up to four processor listings. The following settings are displayed for each processor installed in the system.
Family-Model-Stepping	Displays the family, model and stepping of the processor as defined by Intel.
Brand	Displays the brand name reported by the processor.
Level 2 Cache	Displays the total L2 cache.
Level 3 Cache	Displays the total L3 cache.
Number of Cores	Displays the number of cores per processor.

SATA settings screen details

You can use the **SATA Settings** screen to view the SATA settings of SATA devices and enable RAID on your system.

About this task

You can view the **SATA Settings** screen by clicking **System Setup Main Menu > System BIOS > SATA Settings**.

The **SATA Settings** screen details are explained below.

Menu Item	Description
Embedded SATA	Enables the embedded SATA to be set to Off , AHCI Mode , or RAID Mode modes. By default, the Embedded SATA option is set to AHCI Mode .
Security Freeze Lock	Sends Security Freeze Lock command to the Embedded SATA drives during POST. This option is only AHCI mode not RAID mode. Options is set to Enabled
Write Cache	Enables or disables the command for Embedded SATA drives during POST. Options is set to Disabled
Port A	Sets the drive type of the selected device.
Model	Displays the drive model of the selected device.
Drive Type	Displays the type of drive attached to the SATA port.
Capacity	Displays the total capacity of the hard drive. The field is undefined for removable media devices such as optical drives.
Port B	Sets the drive type of the selected device.
Model	Displays the drive model of the selected device.

Menu Item	Description
Drive Type	Displays the type of drive attached to the SATA port.
Capacity	Displays the total capacity of the hard drive. The field is undefined for removable media devices such as optical drives.
Port C	Sets the drive type of the selected device.
Model	Displays the drive model of the selected device.
Drive Type	Displays the type of drive attached to the SATA port.
Capacity	Displays the total capacity of the hard drive. The field is undefined for removable media devices such as optical drives.
Port D	Sets the drive type of the selected device.
Model	Displays the drive model of the selected device.
Drive Type	Displays the type of drive attached to the SATA port.
Capacity	Displays the total capacity of the hard drive. The field is undefined for removable media devices such as optical drives.
Port E	Sets the drive type of the selected device.
Model	Displays the drive model of the selected device.
Drive Type	Displays the type of drive attached to the SATA port.
Capacity	Displays the total capacity of the hard drive. The field is undefined for removable media devices such as optical drives.
Port F	Sets the drive type of the selected device.
Model	Displays the drive model of the selected device.
Drive Type	Displays the type of drive attached to the SATA port.
Capacity	Displays the total capacity of the hard drive. The field is undefined for removable media devices such as optical drives.
Port G	Sets the drive type of the selected device.
Model	Displays the drive model of the selected device.
Drive Type	Displays the type of drive attached to the SATA port.
Capacity	Displays the total capacity of the hard drive. The field is undefined for removable media devices such as optical drives.
Port H	Sets the drive type of the selected device.
Model	Displays the drive model of the selected device.
Drive Type	Displays the type of drive attached to the SATA port.
Capacity	Displays the total capacity of the hard drive. The field is undefined for removable media devices such as optical drives.
Port I	Sets the drive type of the selected device.
Model	Displays the drive model of the selected device.
Drive Type	Displays the type of drive attached to the SATA port.
Capacity	Displays the total capacity of the hard drive. The field is undefined for removable media devices such as optical drives.
Port J	Sets the drive type of the selected device.
Model	Displays the drive model of the selected device.
Drive Type	Displays the type of drive attached to the SATA port.
Port K	Sets the drive type of the selected device.
Model	Displays the drive model of the selected device.

Menu Item	Description
Drive Type	Displays the type of drive attached to the SATA port.
Capacity	Displays the total capacity of the hard drive. The field is undefined for removable media devices such as optical drives.
Capacity	Displays the total capacity of the hard drive. The field is undefined for removable media devices such as optical drives.
Port L	Sets the drive type of the selected device.
Model	Displays the drive model of the selected device.
Drive Type	Displays the type of drive attached to the SATA port.
Capacity	Displays the total capacity of the hard drive. The field is undefined for removable media devices such as optical drives.
Port M	Sets the drive type of the selected device.
Model	Displays the drive model of the selected device.
Drive Type	Displays the type of drive attached to the SATA port.
Capacity	Displays the total capacity of the hard drive. The field is undefined for removable media devices such as optical drives.
Port N	Sets the drive type of the selected device.
Model	Displays the drive model of the selected device.
Drive Type	Displays the type of drive attached to the SATA port.
Capacity	Displays the total capacity of the hard drive. The field is undefined for removable media devices such as optical drives.



Boot settings screen details

You can use the **Boot Settings** screen to set the Boot mode to either **BIOS** or **UEFI**. It also allows you to specify the boot order.

About this task

You can view the **Boot Settings** screen by clicking **System Setup Main Menu > System BIOS > Boot Settings**.

The **Boot Settings** screen details are explained as follows:

Menu Item	Description
Boot Mode	<p>Enables you to set the boot mode of the system.</p> <p> CAUTION: Switching the boot mode may prevent the system from booting if the operating system is not installed in the same boot mode.</p> <p> NOTE: Setting this field to UEFI disables BIOS Boot Settings menu. Setting this field to BIOS disables the UEFI Boot Settings menu.</p> <p>If the operating system supports UEFI, you can set this option to UEFI. Setting this field to BIOS allows compatibility with non-UEFI operating systems. By default, the Boot Mode option is set to UEFI.</p>
Boot Sequence Retry	Enables or disables the boot sequence retry feature. If this field is enabled and the system fails to boot, the system reattempts the boot sequence after 30 seconds. By default, the Boot Sequence Retry option is set to Enabled .
Hard Disk Failover	Specifies which devices in the Hard-Disk Drive Sequence are attempted in the boot sequence. When the option is Disabled , only the first hard disk device in the list is attempted to boot. When set to Enabled , all hard disk devices are attempted in order, as listed in the Hard-Disk Drive Sequence . This option is not enabled for UEFI Boot Mode.
UEFI Boot Sequence	This field controls the UEFI boot order Integrated NIC 1 Port 1 Partition 1

Menu Item	Description
Boot option Enable/Disable	This field enables or disables the boot option in UEFI Boot Sequence.

Network settings screen details

You can use the **Network Settings** screen to set the Boot mode from **UEFI**. It also allows you to specify the boot order.

About this task

You can view the **Network Settings** screen by clicking **System Setup Main Menu > System BIOS > Network Settings**.

The **Network Settings** screen details are explained as follows:

Menu Item	Description
UEFI PXE settings	This field controls the system network settings.
PXE Device1	This field controls the system network settings. Option is set to Enabled .
PXE Device2	This field controls the system network settings. Option is set to Disabled
PXE Device3	This field controls the system network settings. Option is set to Disabled
PXE Device4	This field controls the system network settings. Option is set to Disabled
PXE Device1 Settings	NIC interface used for this PXE device. Option is set to Enabled
Interface	NIC interface used for this PXE device. Options are: Intergrated NIC Port 1 Partition 1 Intergrated NIC Port 2 Partition 1 Intergrated NIC Port 3 Partition 1 Intergrated NIC Port 4 Partition 1
Protocol	This field controls the PXE protocol used for PXE device. Options are IPv4 (set default) and IPv6
VLAN	Enables or disables PXE device. Options are Enabled and Disabled (set default)
VLAN ID	Displays the VLAN ID
VLAN Priority	Displays the VLAN Priority
UEFI HTTP Settings	This field enables the BIOS to create a UEFI boot option for the HTTP device. Option is set to Disabled
HTTP Device1	This field enables the BIOS to create a UEFI boot option for the HTTP device. Option is set to Disabled
HTTP Device2	This field enables the BIOS to create a UEFI boot option for the HTTP device. Option is set to Disabled
HTTP Device3	This field enables the BIOS to create a UEFI boot option for the HTTP device. Option is set to Disabled
HTTP Device4	This field enables the BIOS to create a UEFI boot option for the HTTP device. Option is set to Disabled
UEFI ISCSI Settigns	This field specifies the name of the ISCSI initiator (iqn format).
ISCSI Initiator Name	This field specifies the name of the ISCSI initiator (iqn format).
ISCSI Device1	This field controls the configuration for ISCSI device.

Integrated devices screen details

You can use the **Integrated Devices** screen to view and configure the settings of all integrated devices including the video controller, integrated RAID controller, and the USB ports.

About this task

You can view the **Integrated Devices** screen by clicking **System Setup Main Menu > System BIOS > Integrated Devices**.

The **Integrated Devices** screen details are explained below.

Menu Item	Description
User Accessible USB Ports	<p>Enables or disables the USB ports. Selecting Only Back Ports On disables the front USB ports, selecting All Ports Off disables all USB ports, selecting All Ports Off (Dynamic) disables all USB ports during P.O.S.T. The USB keyboard and mouse operates during boot process in certain operating systems. After the boot process is complete, the USB keyboard and mouse do not work if the ports are disabled.</p> <p>NOTE: Selecting Only Back Ports On and All Ports Off will disable the USB management port and also restrict access to iDRAC features.</p>
Internal USB Port	Enables or disables the internal USB port. By default, the option is set to On .
iDRAC Direct USB Port	iDRAC Direct USB Port managed by iDRAC exclusively with no host visibility. When set to off iDRAC would not detect any USB device installed. Option is set to On
Integrated Network Card 1	Enables or disables the integrated network card.
I/OAT DMA Engine	Enables or disables the I/OAT option. Enable only if the hardware and software support the feature.
Embedded Video Controller	<p>Enables or disables the Current state of Embedded Video Controller . By default the option Disabled. Current State of Embedded Video Controller is a read only field, indicating the current state for the Embedded Video Controller. If the Embedded Video Controller is the only display capability in the system (that is, no add-in graphics card is installed), then the Embedded Video Controller is automatically used as the primary display even if the Embedded Video Controller setting is Disabled.</p> <p>NOTE: 1. If the embedded video controller is DISABLED in BIOS and if you launch the Virtual Console from the iDRAC, the Virtual Console Viewer is blank.</p> <p>NOTE: 2. All monitors must be plugged into the GPU at power on, and must remain plugged into the GPU until the system is booted into the operating system with the driver loaded. Once the system is booted into the operating system the monitor can be unplugged, and then hot plugged. The monitor will not be hot pluggable unless this process is followed.</p> <ul style="list-style-type: none">• DP cable can be hot plugged• mDP cable can be hot plugged• DVI cable can be hot plugged• DP to VGA dongle cable cannot be hot plugged
Current State of Embedded Video Controller	Displays the current state of the Embedded Video Controller . Current State of Embedded Video Controller is a read only field, indicating the current state for the Embedded Video Controller
SR-IOV Global Enable	Enables or disables the BIOS configuration of Single Root I/O Virtualization (SR-IOV) devices. By default, the SR-IOV Global Enable option is set to Disabled .
OS Watchdog Timer	If your system stops responding, this watchdog timer aids in the recovery of your operating system. When this field is set to Enabled , the operating system is allowed to initialize the timer. When the option is set to Disabled (the default), the timer will have no effect on the system.
Memory Mapped I/O above 4GB	Enables or disables the support for PCIe devices that require large amounts of memory. By default, the option is set to Enabled .
Lower Memory Mapped I/O base to 512GB	When set to enabled system will map MMIO base to 512 GB and reduce the maximum support for memory to less than 512 GB.

Menu Item	Description
Slot Disablement	<p>Enables or disables the available PCIe slots on your system. The Slot Disablement feature controls the configuration of PCIe cards installed in the specified slot. Slot disablement must be used only when the installed peripheral card is preventing booting into the operating system or causing delays in system startup. If the slot is disabled, both the Option ROM and UEFI driver are disabled.</p> <p>This field controls the configuration of the card installed in the slot. You can set one of the following options for each of the(Press F1 for more information)</p> <ol style="list-style-type: none"> 1. Slot 1 Boot Driver <ul style="list-style-type: none"> ● Enabled (default) ● Disabled ● Boot Driver Disabled 2. Slot 2 Boot Driver <ul style="list-style-type: none"> ● Enabled (default) ● Disabled ● Boot Driver Disabled 3. Slot 3 Boot Driver <ul style="list-style-type: none"> ● Enabled (default) ● Disabled ● Boot Driver Disabled 4. Slot 4 Boot Driver <ul style="list-style-type: none"> ● Enabled (default) ● Disabled ● Boot Driver Disabled 5. Slot 5 Boot Driver <ul style="list-style-type: none"> ● Enabled (default) ● Disabled ● Boot Driver Disabled 6. Slot 6 Boot Driver <ul style="list-style-type: none"> ● Enabled (default) ● Disabled ● Boot Driver Disabled
Slot Bifurcation	<ol style="list-style-type: none"> 1. Slot 1 Bifurcation <ul style="list-style-type: none"> ● x16 Bifurcation (default) 2. Slot 2 Bifurcation <ul style="list-style-type: none"> ● x4 Bifurcation ● x8 Bifurcation (default) 3. Slot 3 Boot Driver <ul style="list-style-type: none"> ● x4 Bifurcation ● x8 Bifurcation (default) 4. Slot 4 Boot Driver <ul style="list-style-type: none"> ● x16 Bifurcation (default) 5. Slot 5 Boot Driver <ul style="list-style-type: none"> ● x4 Bifurcation ● x8 Bifurcation (default) 6. Slot 6 Boot Driver <ul style="list-style-type: none"> ● x4 Bifurcation ● x8 Bifurcation (default)



Serial Communication screen details

You can use the **Serial Communication** screen to view the properties of the serial communication port.

About this task

You can view the **Serial Communication** screen by clicking **System Setup Main Menu > System BIOS > Serial Communication**.

The **Serial Communication** screen details are explained below.

Menu Item	Description
Serial Communication	Selects serial communication devices (Serial Device 1 and Serial Device 2) in the BIOS. BIOS console redirection can also be enabled and the port address can be specified. By default, Serial Communication option is set to Auto .
Serial Port Address	Enables you to set the port address for serial devices. By default, the Serial Port Address option is set to Serial Device 1=COM2, Serial Device 2=COM1 .  NOTE: Only Serial Device 2 can be used for Serial Over LAN (SOL). To use console redirection by SOL, configure the same port address for console redirection and the serial device.
External Serial Connector	Enables you to associate the external serial connector to serial device 1, serial device 2, or remote access device. By default, the External Serial Connector option is set to Serial Device1 .  NOTE: Only Serial Device 2 can be used for SOL. To use console redirection by SOL, configure the same port address for console redirection and the serial device.
Failsafe Baud Rate	Displays the failsafe baud rate for console redirection. The BIOS attempts to determine the baud rate automatically. This failsafe baud rate is used only if the attempt fails and the value must not be changed. By default, the Failsafe Baud Rate option is set to 115200 .
Remote Terminal Type	Sets the remote console terminal type. By default, the Remote Terminal Type option is set to VT 100/VT 220 .
Redirection After Boot	Enables or disables the BIOS console redirection when the operating system is loaded. By default, the Redirection After Boot option is set to Enabled .

System profile settings screen details



You can use the **System Profile Settings** screen to enable specific system performance settings such as power management.

About this task

You can view the **System Profile Settings** screen by clicking **System Setup Main Menu > System BIOS > System Profile Settings**.

The **System Profile Settings** screen details are explained as follows:

Menu Item	Description
System Profile	Sets the system profile. If you set the System Profile option to a mode other than Custom , the BIOS automatically sets the rest of the options. You can only change the rest of the options if the mode is set to Custom . By default, the System Profile option is set to Workstation Performance .  NOTE: The following parameters are available only when the System Profile is set to Workstation Performance .
CPU Power Management	Sets the CPU power management. By default, the Maximum Performance option is set to Enabled .
Memory Frequency	Sets the memory frequency. By default, the Maximum Performance option is set to Enabled .
Turbo Boost	Enables or disables the processor to operate in turbo boost mode. By default, the Turbo Boost option is set to Enabled .

Menu Item	Description
Energy Efficient Turbo	Enables or disables the Energy Efficient Turbo . Energy Efficient Turbo (EET) is a mode of operation where a processor's core frequency is adjusted within the turbo range based on workload.
C1E	Enables or disables the processor to switch to a minimum performance state when it is idle. By default, the C1E option is set to Disabled .
C States	Enables or disables the processor to operate in all available power states. By default, the C States option is set to Enabled .
Write Data CRC	Enables or disables Write Data CRC. By default option is set to Disabled .
Collaborative CPU Performance Control	Enables or disables the CPU power management. When set to Enabled , the CPU power management is controlled by the OS DBPM and the System DBPM (DAPC). By default, the option is set to Disabled .
Memory Patrol Scrub	Sets the memory patrol scrub frequency. By default, the Memory Patrol Scrub option is set to Standard .
Memory Refresh Rate	Sets the memory refresh rate to either 1x or 2x. By default, the Memory Refresh Rate option is set to 1x .
Uncore Frequency	Selects the Processor Uncore Frequency . Dynamic mode allows the processor to optimize power resources across the cores and uncore during runtime. The optimization of the uncore frequency to either save power or optimize performance is influenced by the setting of the Energy Efficiency Policy .
Energy Efficient Policy	Selects the Energy Efficient Policy . The CPU uses the setting to manipulate the internal behavior of the processor and determines whether to target higher performance or better power savings.
Number of Turbo Boot Enabled Cores for Processor 1	 NOTE: If there are two processors installed in the system, you see an entry for Number of Turbo Boost Enabled Cores for Processor 2 . Controls the number of turbo boost enabled cores for processor 1. By default, the maximum number of cores is all.
Monitor/Mwait	Enables the Monitor/Mwait instructions in the processor. By default, the Monitor/Mwait option is set to Enabled for all system profiles, except Custom .  NOTE: This option can be disabled only if the C States option in Custom mode is disabled.  NOTE: When C States is enabled in Custom mode, changing the Monitor/Mwait setting does not impact system power/performance.
CPU Interconnect Bus Link Power Management	Enables or disables CPU Interconnect Bus Link Power Management By default, the option is set to Disabled .
PCI ASPM L1 Link Power Management	Enables or disables PCI ASPM L1 Link Power Management. By default, the option is set to Disabled .

System security settings screen details

You can use the **System Security** screen to perform specific functions such as setting the system password, setup password, and disabling the power button.

About this task

You can view the **System Security** screen by clicking **System Setup Main Menu > System BIOS > System Security Settings**.

The **System Security Settings** screen details are explained as follows:

Menu Item	Description
Intel AES-NI	Improves the speed of applications by performing encryption and decryption using the Advanced Encryption Standard Instruction Set and is set to Enabled by default.
System Password	Sets the system password. This option is set to Enabled by default and is read-only if the password jumper is not installed in the system.
Setup Password	Sets the setup password. This option is read-only if the password jumper is not installed in the system.
Password Status	Locks the system password. By default, the Password Status option is set to Unlocked .
TPM Information	Changes the operational state of the TPM. By default option is set to No TPM Present .
Intel TXT	Enables or disables the Intel Trusted Execution Technology (TXT). To enable Intel TXT , Virtualization Technology must be enabled and TPM Security must be Enabled with Pre-boot measurements. By default, the Intel TXT option is set to Off .
Power Button	Enables or disables the power button on the front of the system. By default, the Power Button option is set to Enabled .
AC Power Recovery	Sets how the system reacts after AC power is restored to the system. By default, the AC Power Recovery option is set to Last .
AC Power Recovery Delay	Sets how the system supports staggering of power up after AC power is restored to the system. By default, the AC Power Recovery Delay option is set to Immediate .
User Defined Delay (60s to 240s)	Sets the User Defined Delay when the User Defined option for 0 is selected.
UEFI Variable Access	Provides varying degrees of securing UEFI variables. When set to Standard (the default) UEFI variables are accessible in the Operating System per the UEFI specification. When set to Controlled , selected UEFI variables are protected in the environment and new UEFI boot entries are forced to be at the end of the current boot order.
Secure ME PCI Cfg Space	Enabled this setting will hide the PCU configuration space for the management engine (ME) HECI device and is set to Disabled by default.
Secure Boot	Enables Secure Boot, where the BIOS authenticates each pre-boot image using the certificates in the Secure Boot Policy. Secure Boot is disabled by default.
Secure Boot Policy	When Secure Boot policy is Standard , the BIOS uses the system manufacturer's key and certificates to authenticate pre-boot images. When Secure Boot policy is Custom , the BIOS uses the user-defined key and certificates. Secure Boot policy is Standard by default.
Secure Boot Mode	This field enabled how to use Secure boot policy object (PK, KEK, db, dbx).
Secure Boot Policy Summary	Views the list of certificates and hashes that secure boot uses to authenticated images.

Secure Boot Custom Policy Settings

Secure Boot Custom Policy Settings is displayed only when **Secure Boot Policy** is set to **Custom**.

About this task

In the **System Setup Main Menu**, click **System BIOS > System Security > Secure Boot Custom Policy Settings**.

The **Secure Boot Custom Policy Settings** screen details are explained as follows:

Menu Item	Description
Platform Key	Imports, exports, deletes, or restores the platform key (PK).
Key Exchange Key Database	Allows you to import, export, delete, or restore entries in the Key Exchange Key (KEK) Database

Menu Item	Description
Authorized Signature Database	Imports, exports, deletes, or restores entries in the Authorized Signature Database (db).
Forbidden Signature Database	Imports, exports, deletes, or restores entries in the Forbidden Signature Database (dbx).

Miscellaneous settings screen details

You can use the **Miscellaneous Settings** screen to perform specific functions such as updating the asset tag, and changing the system date and time.

About this task

You can view the **Miscellaneous Settings** screen by clicking **System Setup Main Menu > System BIOS > Miscellaneous Settings**.

The **Miscellaneous Settings** screen details are explained as follows:

Menu Item	Description
System Time	Enables you to set the time on the system.
System Date	Enables you to set the date on the system.
Asset Tag	Displays the asset tag and enables you to modify it for security and tracking purposes.
Keyboard NumLock	Enables you to set whether the system boots with the NumLock enabled or disabled. By default the Keyboard NumLock is set to On .  NOTE: This option does not apply to 84-key keyboards.
F1/F2 Prompt on Error	Enables or disables the F1/F2 prompt on error. By default, F1/F2 Prompt on Error is set to Enabled . The F1/F2 prompt also includes keyboard errors.
Load Legacy Video Option ROM	Enables you to determine whether the system BIOS loads the legacy video (INT 10H) option ROM from the video controller. Selecting Enabled in the operating system does not support UEFI video output standards. This field is only for UEFI boot mode. You cannot set this to Enabled if UEFI Secure Boot mode is enabled.
Dell Wyse P25BIOS Access	This option is enabled by default.
Power Cycle Request	Specifies how the system reacts when system transitions to S5 state and is set to None .

Updating the BIOS

Updating the BIOS in Windows

About this task

 **CAUTION:** If BitLocker is not suspended before updating the BIOS, the next time you reboot the system it will not recognize the BitLocker key. You will then be prompted to enter the recovery key to progress and the system will ask for this on each reboot. If the recovery key is not known this can result in data loss or an unnecessary operating system re-install. For more information on this subject, see Knowledge Article: <https://www.dell.com/support/article/sln153694>

Steps

1. Go to www.dell.com/support.
2. Click **Product support**. In the **Search support** box, enter the Service Tag of your computer, and then click **Search**.
 **NOTE:** If you do not have the Service Tag, use the SupportAssist feature to automatically identify your computer. You can also use the product ID or manually browse for your computer model.
3. Click **Drivers & Downloads**. Expand **Find drivers**.
4. Select the operating system installed on your computer.
5. In the **Category** drop-down list, select **BIOS**.
6. Select the latest version of BIOS, and click **Download** to download the BIOS file for your computer.
7. After the download is complete, browse the folder where you saved the BIOS update file.
8. Double-click the BIOS update file icon and follow the on-screen instructions.
For more information, see knowledge base article [000124211](https://www.dell.com/support/article/000124211) at www.dell.com/support.

Updating the BIOS in Linux and Ubuntu

To update the system BIOS on a computer that is installed with Linux or Ubuntu, see the knowledge base article [000131486](https://www.dell.com/support/article/000131486) at www.dell.com/support.

Updating the BIOS using the USB drive in Windows

About this task

 **CAUTION:** If BitLocker is not suspended before updating the BIOS, the next time you reboot the system it will not recognize the BitLocker key. You will then be prompted to enter the recovery key to progress and the system will ask for this on each reboot. If the recovery key is not known this can result in data loss or an unnecessary operating system re-install. For more information on this subject, see Knowledge Article: <https://www.dell.com/support/article/sln153694>

Steps

1. Follow the procedure from step 1 to step 6 in [Updating the BIOS in Windows](#) to download the latest BIOS setup program file.
2. Create a bootable USB drive. For more information, see the knowledge base article [000145519](https://www.dell.com/support/article/000145519) at www.dell.com/support.
3. Copy the BIOS setup program file to the bootable USB drive.
4. Connect the bootable USB drive to the computer that needs the BIOS update.
5. Restart the computer and press **F12**.
6. Select the USB drive from the **One Time Boot Menu**.
7. Type the BIOS setup program filename and press **Enter**.
The **BIOS Update Utility** appears.
8. Follow the on-screen instructions to complete the BIOS update.

Updating the BIOS from the F12 One-Time boot menu

Update your computer BIOS using the BIOS update.exe file that is copied to a FAT32 USB drive and booting from the F12 One-Time boot menu.

About this task

 **CAUTION:** If BitLocker is not suspended before updating the BIOS, the next time you reboot the system it will not recognize the BitLocker key. You will then be prompted to enter the recovery key to progress and the system will ask for this on each reboot. If the recovery key is not known this can result in data loss or an unnecessary operating system re-install. For more information on this subject, see Knowledge Article: <https://www.dell.com/support/article/sln153694>

BIOS Update

You can run the BIOS update file from Windows using a bootable USB drive or you can also update the BIOS from the F12 One-Time boot menu on the computer.

Most of the Dell computers built after 2012 have this capability, and you can confirm by booting your computer to the F12 One-Time Boot Menu to see if BIOS FLASH UPDATE is listed as a boot option for your computer. If the option is listed, then the BIOS supports this BIOS update option.

 **NOTE:** Only computers with BIOS Flash Update option in the F12 One-Time boot menu can use this function.

Updating from the One-Time boot menu

To update your BIOS from the F12 One-Time boot menu, you need the following:

- USB drive formatted to the FAT32 file system (key does not have to be bootable)
- BIOS executable file that you downloaded from the Dell Support website and copied to the root of the USB drive
- AC power adapter that is connected to the computer
- Functional computer battery to flash the BIOS

Perform the following steps to perform the BIOS update flash process from the F12 menu:

 **CAUTION:** Do not turn off the computer during the BIOS update process. The computer may not boot if you turn off your computer.

Steps

1. From a turn off state, insert the USB drive where you copied the flash into a USB port of the computer.
2. Turn on the computer and press F12 to access the One-Time Boot Menu, select BIOS Update using the mouse or arrow keys then press Enter.
The flash BIOS menu is displayed.
3. Click **Flash from file**.
4. Select external USB device.
5. Select the file and double-click the flash target file, and then click **Submit**.
6. Click **Update BIOS**. The computer restarts to flash the BIOS.
7. The computer will restart after the BIOS update is completed.

Troubleshooting your system

Safety first — for you and your system

NOTE: Many repairs may only be done by a certified service technician. You should only perform troubleshooting and simple repairs as authorized in your product documentation, or as directed by the online or telephone service and support team. Damage due to servicing that is not authorized by Dell is not covered by your warranty. Read and follow the safety instructions that are shipped with your product.

NOTE: Dell has optimized your appliance and recommends that you do not change any of these settings.

NOTE: Solution validation was performed by using the factory shipped hardware configuration.

Topics:

- [System diagnostics](#)
- [Updating the BIOS using the USB drive in Windows](#)
- [Updating the BIOS in Windows](#)
- [Backup media and recovery options](#)
- [WiFi power cycle](#)

System diagnostics

If you experience a problem with your system, run the system diagnostics before contacting Dell for technical assistance. The purpose of running system diagnostics is to test your system hardware without using additional equipment or risking data loss. If you are unable to fix the problem yourself, service and support personnel can use the diagnostics results to help you solve the problem.

Dell Embedded System Diagnostics

NOTE: The Dell Embedded System Diagnostics is also known as Enhanced Pre-boot System Assessment (ePSA) diagnostics.

The Embedded System Diagnostics provides a set of options for particular device groups or devices allowing you to:

- Run tests automatically or in an interactive mode
- Repeat tests
- Display or save test results
- Run thorough tests to introduce additional test options to provide extra information about the failed device(s)
- View status messages that inform you if tests are completed successfully
- View error messages that inform you of problems encountered during testing

Running the Embedded System Diagnostics from Boot Manager

Run the Embedded System Diagnostics (ePSA) if your system does not boot.

Steps

1. When the system is booting, press F11.
2. Use the up arrow and down arrow keys to select **System Utilities** > **Launch Diagnostics**.
3. Alternatively, when the system is booting, press F10, select **Hardware Diagnostics** > **Run Hardware Diagnostics**.

The **ePSA Pre-boot System Assessment** window is displayed, listing all devices detected in the system. The diagnostics starts executing the tests on all the detected devices.

Results

Running the Embedded System Diagnostics from the Dell Lifecycle Controller

Steps

1. As the system boots, press F10.
2. Select **Hardware Diagnostics** → **Run Hardware Diagnostics**.
The **ePSA Pre-boot System Assessment** window is displayed, listing all devices detected in the system. The diagnostics starts executing the tests on all the detected devices.

System diagnostic controls

Menu	Description
Configuration	Displays the configuration and status information of all detected devices.
Results	Displays the results of all tests that are run.
System health	Provides the current overview of the system performance.
Event log	Displays a time-stamped log of the results of all tests run on the system. This is displayed if at least one event description is recorded.

Updating the BIOS using the USB drive in Windows

Steps

1. Follow the procedure from step 1 to step 6 in [Updating the BIOS in Windows](#) to download the latest BIOS setup program file.
2. Create a bootable USB drive. For more information, see the knowledge base article [000145519](#) at www.dell.com/support.
3. Copy the BIOS setup program file to the bootable USB drive.
4. Connect the bootable USB drive to the computer that needs the BIOS update.
5. Restart the computer and press **F12**.
6. Select the USB drive from the **One Time Boot Menu**.
7. Type the BIOS setup program filename and press **Enter**.
The **BIOS Update Utility** appears.
8. Follow the on-screen instructions to complete the BIOS update.

Updating the BIOS in Windows

Steps

1. Go to www.dell.com/support.
2. Click **Product support**. In the **Search support** box, enter the Service Tag of your computer, and then click **Search**.
 **NOTE:** If you do not have the Service Tag, use the SupportAssist feature to automatically identify your computer. You can also use the product ID or manually browse for your computer model.
3. Click **Drivers & Downloads**. Expand **Find drivers**.
4. Select the operating system installed on your computer.
5. In the **Category** drop-down list, select **BIOS**.
6. Select the latest version of BIOS, and click **Download** to download the BIOS file for your computer.

7. After the download is complete, browse the folder where you saved the BIOS update file.
8. Double-click the BIOS update file icon and follow the on-screen instructions.
For more information, see knowledge base article [000124211](https://www.dell.com/support/000124211) at www.dell.com/support.

Backup media and recovery options

It is recommended to create a recovery drive to troubleshoot and fix problems that may occur with Windows. Dell proposes multiple options for recovering Windows operating system on your Dell PC. For more information, see [Dell Windows Backup Media and Recovery Options](#).

WiFi power cycle

About this task

If your computer is unable to access the internet due to WiFi connectivity issues a WiFi power cycle procedure may be performed. The following procedure provides the instructions on how to conduct a WiFi power cycle:

 **NOTE:** Some ISPs (Internet Service Providers) provide a modem/router combo device.

Steps



1. Turn off your computer.
2. Turn off the modem.
3. Turn off the wireless router.
4. Wait for 30 seconds.
5. Turn on the wireless router.
6. Turn on the modem.
7. Turn on your computer.

Getting help and contacting Dell

Self-help resources

You can get information and help on Dell products and services using these self-help resources:

Table 41. Self-help resources

Self-help resources	Resource location
Information about Dell products and services	www.dell.com
My Dell	
Tips	
Contact Support	In Windows search, type Contact Support , and press Enter.
Online help for operating system	www.dell.com/support/windows www.dell.com/support/linux
Troubleshooting information, user manuals, setup instructions, product specifications, technical help blogs, drivers, software updates, and so on.	www.dell.com/support
Dell knowledge base articles for a variety of computer concerns.	<ol style="list-style-type: none"> 1. Go to https://www.dell.com/support/home/?app=knowledgebase. 2. Type the subject or keyword in the Search box. 3. Click Search to retrieve the related articles.
Learn and know the following information about your product: <ul style="list-style-type: none"> • Product specifications • Operating system • Setting up and using your product • Data backup • Troubleshooting and diagnostics • Factory and system restore • BIOS information 	See <i>Me and My Dell</i> at www.dell.com/support/manuals . To locate the <i>Me and My Dell</i> relevant to your product, identify your product through one of the following: <ul style="list-style-type: none"> • Select Detect Product. • Locate your product through the drop-down menu under View Products. • Enter the Service Tag number or Product ID in the search bar.

Contacting Dell

To contact Dell for sales, technical support, or customer service issues, see www.dell.com/contactdell.

 **NOTE:** Availability varies by country and product, and some services may not be available in your country.

 **NOTE:** If you do not have an active internet connection, you can find contact information on your purchase invoice, packing slip, bill, or Dell product catalog.