

# Dell EMC PowerEdge R750xa

## Installation and Service Manual

## Notes, cautions, and warnings

 **NOTE:** A NOTE indicates important information that helps you make better use of your product.

 **CAUTION:** A CAUTION indicates either potential damage to hardware or loss of data and tells you how to avoid the problem.

 **WARNING:** A WARNING indicates a potential for property damage, personal injury, or death.

<b>Chapter 1: About this document.....</b>	<b>8</b>
<b>Chapter 2: Dell EMC PowerEdge R750xa system overview.....</b>	<b>9</b>
Front view of the system.....	9
Left control panel view.....	11
Right control panel view.....	12
Rear view of the system.....	13
Inside the system .....	15
Locating the Express Service Code and Service Tag.....	16
System information label.....	17
Rail sizing and rack compatibility matrix.....	20
<b>Chapter 3: Initial system setup and configuration.....</b>	<b>21</b>
Setting up the system.....	21
iDRAC configuration.....	21
Options to set up iDRAC IP address.....	21
Options to log in to iDRAC.....	22
Resources to install operating system.....	23
Options to download firmware .....	23
Options to download and install OS drivers .....	24
Downloading drivers and firmware.....	24
<b>Chapter 4: Minimum to POST and system management configuration validation.....</b>	<b>25</b>
Minimum configuration to POST .....	25
Configuration validation.....	25
Error messages.....	26
<b>Chapter 5: Installing and removing system components.....</b>	<b>27</b>
Safety instructions.....	27
Before working inside your system.....	28
After working inside your system.....	28
Recommended tools.....	28
Optional front bezel.....	29
Removing the front bezel.....	29
Installing the front bezel.....	30
System cover.....	30
Removing the system cover.....	30
Installing the system cover.....	31
Drive backplane cover.....	32
Removing the drive backplane cover.....	32
Installing the drive backplane cover.....	33
Air shroud.....	35
Removing the air shroud.....	35
Installing the air shroud.....	36

Removing the air shroud blank.....	38
Installing the air shroud blank.....	38
Cooling fans.....	39
Removing the cooling fan cage assembly .....	39
Installing the cooling fan cage assembly.....	40
Removing a cooling fan.....	41
Installing a cooling fan.....	42
Side wall brackets.....	43
Removing the side wall bracket.....	43
Installing the side wall bracket.....	44
Drives.....	45
Removing a drive blank.....	45
Installing a drive blank.....	46
Removing the drive carrier.....	47
Removing the drive from the drive carrier.....	47
Installing the drive into the drive carrier.....	48
Installing the drive carrier.....	49
Removing a NVMe drive blank.....	50
Installing a NVMe drive blank.....	51
PERC module.....	52
Removing the rear mounting front PERC module.....	52
Installing the rear mounting front PERC module.....	53
Drive backplane.....	54
Drive backplane.....	54
Removing the drive backplane .....	55
Installing the drive backplane.....	56
Removing a NVMe connector blank.....	57
Installing a NVMe connector blank.....	58
Cable routing.....	59
System memory.....	63
System memory guidelines.....	63
General memory module installation guidelines.....	64
Intel Persistent Memory 200 series (BPS) installation guidelines .....	65
Removing a memory module.....	70
Installing a memory module.....	71
Processor and heat sink module.....	72
Removing the processor and heat sink module.....	72
Removing the processor.....	74
Installing the processor.....	76
Installing the processor and heat sink module.....	79
Removing the liquid cooling module.....	81
Installing the liquid cooling module.....	82
Expansion cards and expansion card risers.....	84
Expansion card installation guidelines.....	84
Removing the expansion card risers.....	93
Installing the expansion card risers.....	96
Removing expansion card from the expansion card riser.....	99
Installing an expansion card into the expansion card riser.....	101
Removing R1 and R4 paddle cards.....	102
Installing R1 and R4 paddle cards.....	103

Removing the R3 paddle card .....	104
Installing the R3 paddle cards.....	105
Replacing the GPU bracket.....	106
Removing the GPU riser module.....	108
Installing the GPU riser module.....	110
Removing the GPU.....	111
Installing the GPU.....	113
Removing the NVLink sponges.....	114
Installing the NVLink sponges.....	115
Removing the NVLink bridges.....	116
Installing the NVLink bridges.....	117
Removing the GPU riser module card holders.....	119
Installing the GPU riser module card holders.....	119
Optional serial COM port.....	121
Removing the serial COM port.....	121
Installing the serial COM port.....	122
Optional VGA port for liquid cooling module.....	124
Removing the VGA port.....	124
Installing the VGA port.....	125
Optional IDSDM module.....	127
Removing the IDSDM module.....	127
Installing the IDSDM module.....	127
MicroSD card.....	128
Removing the MicroSD card.....	128
Installing the MicroSD card.....	129
M.2 SSD module.....	130
Removing the M.2 SSD module.....	130
Installing the M.2 SSD module.....	131
Optional BOSS S2 module.....	132
Removing the BOSS S2 module blank.....	132
Installing the BOSS S2 module blank.....	133
Removing the BOSS S2 card carrier blank.....	134
Installing the BOSS S2 card carrier blank.....	135
Removing the BOSS S2 module.....	135
Installing the BOSS S2 module.....	138
System battery .....	140
Replacing the system battery.....	140
Optional internal USB card.....	142
Removing the internal USB card.....	142
Installing the internal USB card.....	142
Intrusion switch module.....	143
Removing the intrusion switch module.....	143
Installing the intrusion switch module.....	144
Optional OCP card.....	145
Removing the OCP card.....	145
Installing the OCP card.....	146
Power supply unit.....	147
Hot spare feature.....	148
Removing a power supply unit blank.....	148
Installing a power supply unit blank.....	148

Removing a power supply unit adapter.....	149
Installing a power supply unit adapter.....	150
Removing a power supply unit.....	150
Installing a power supply unit.....	151
Trusted Platform Module.....	152
Upgrading the Trusted Platform Module.....	152
Initializing TPM for users.....	153
Initializing the TPM 1.2 for users.....	153
Initializing the TPM 2.0 for users.....	154
System board.....	154
Removing the system board.....	154
Installing the system board.....	155
Restoring the system using Easy Restore.....	157
LOM card and rear I/O board.....	157
Removing the LOM card and rear I/O board.....	157
Installing the LOM card and rear I/O board.....	158
Control panel.....	160
Removing the right control panel.....	160
Installing the right control panel.....	161
Removing the left control panel.....	162
Installing the left control panel.....	163
<b>Chapter 6: Upgrade Kits.....</b>	<b>164</b>
BOSS S2 module kit.....	165
GPU kit.....	168
IDSDM kit.....	171
Internal USB card kit.....	172
Serial COM port kit.....	172
VGA port kit.....	172
<b>Chapter 7: Jumpers and connectors.....</b>	<b>173</b>
System board connectors.....	173
System board jumper settings.....	175
Disabling a forgotten password.....	175
<b>Chapter 8: System diagnostics and indicator codes.....</b>	<b>177</b>
Status LED indicators.....	177
System health and system ID indicator codes.....	178
iDRAC Quick Sync 2 indicator codes.....	179
iDRAC Direct LED indicator codes.....	179
LCD panel.....	180
Viewing Home screen.....	181
Setup menu.....	181
View menu.....	181
NIC indicator codes.....	182
Power supply unit indicator codes.....	182
Drive indicator codes.....	184
Using system diagnostics.....	185
Dell Embedded System Diagnostics.....	185

<b>Chapter 9: Getting help</b> .....	<b>187</b>
Recycling or End-of-Life service information.....	187
Contacting Dell Technologies.....	187
Accessing system information by using QRL.....	187
Quick Resource Locator for PowerEdge R750xa system.....	188
Receiving automated support with SupportAssist .....	188
 <b>Chapter 10: Documentation resources</b> .....	 <b>189</b>

# About this document

This document provides an overview about the system, information about installing and replacing components, technical specifications, diagnostic tools, and guidelines to be followed while installing certain components.



# Dell EMC PowerEdge R750xa system overview

The Dell EMC PowerEdge R750xa is a dual socket, 2U rack system that supports:

- Two 3<sup>rd</sup> Generation Intel Xeon Scalable processors, with up to 40 cores per processor
- 32 DDR4 DIMM slot
- Two redundant AC or DC power supply units
- Up to 8 x 2.5-inch SAS/SATA/NVMe drives or 6 x 2.5-inch NVMe drives

**NOTE:** For more information about how to hot swap NVMe PCIe SSD U.2 device, see the *Dell Express Flash NVMe PCIe SSD User's Guide* at <https://www.dell.com/support> **Browse all Products > Data Center Infrastructure > Storage Adapters & Controllers > Dell PowerEdge Express Flash NVMe PCIe SSD > Documentation > Manuals and Documents.**

**NOTE:** All instances of SAS, SATA drives, PCIe SSDs, and NVMe are referred to as drives in this document, unless specified otherwise.

**CAUTION:** Do not install GPUs, network cards, or other PCIe devices on your system that are not validated and tested by Dell. Damage caused by unauthorized and invalidated hardware installation will null and void the system warranty.

**NOTE:** For more information, see the *Dell EMC PowerEdge R750xa Technical Specifications* on the product documentation page.

## Topics:

- [Front view of the system](#)
- [Rear view of the system](#)
- [Inside the system](#)
- [Locating the Express Service Code and Service Tag](#)
- [System information label](#)
- [Rail sizing and rack compatibility matrix](#)

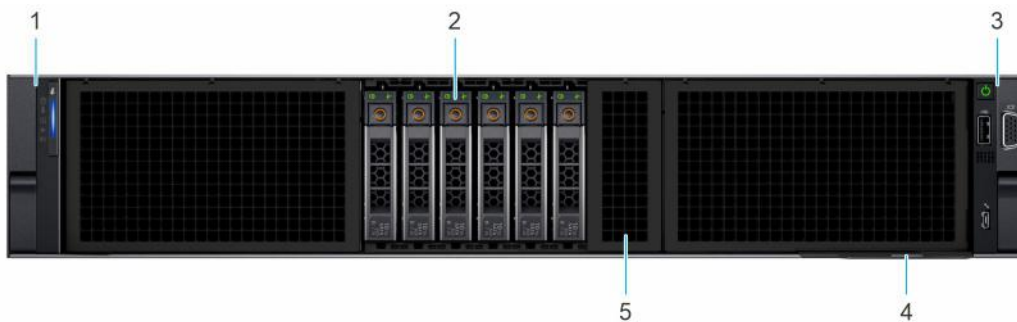
## Front view of the system



Figure 1. Front view of the 8 x 2.5-inch drive system

**Table 1. Features available on the front of the system**

Item	Ports, panels, and slots	Icon	Description
1	Left control panel	N/A	Contains the system health, system ID, status LED, and the iDRAC Quick Sync 2 (wireless) indicator. <i>i</i> <b>NOTE:</b> The iDRAC Quick Sync 2 indicator is available only on certain configurations. <ul style="list-style-type: none"> <li>• Status LED: Enables you to identify any failed hardware components. There are up to five status LEDs and an overall system health LED (Chassis health and system ID) bar. For more information, see the Status LED indicators section.</li> <li>• Quick Sync 2 (wireless): Indicates a Quick Sync enabled system. The Quick Sync feature is optional. This feature allows management of the system by using mobile devices called as OpenManage Mobile (OMM) feature. Using iDRAC Quick Sync 2 with OpenManage Mobile (OMM) aggregates hardware or firmware inventory and various system level diagnostic and error information that can be used in troubleshooting the system. For more information, see the <i>iDRAC User's Guide</i> available at <a href="https://www.dell.com/idracmanuals">https://www.dell.com/idracmanuals</a></li> </ul>
2	Drive	N/A	Enables you to install drives that are supported on your system. <i>i</i> <b>NOTE:</b> For more information, see the <i>Dell EMC PowerEdge R750xa Technical Specifications</i> on the product documentation page.
3	Right control panel	N/A	Contains the power button, USB port, iDRAC Direct micro port, and the iDRAC Direct status LED.
4	Information tag	N/A	The Information tag is a slide-out label panel that contains system information such as Service Tag, NIC, MAC address, and so on. If you have opted for the secure default access to iDRAC, then the Information tag will also contain the iDRAC secure default password.



**Figure 2. Front view of the 6 x 2.5-inch drive system**

**Table 2. Features available on the front of the system**

Item	Ports, panels, and slots	Icon	Description
1	Left control panel	N/A	Contains the system health, system ID, status LED, and the iDRAC Quick Sync 2 (wireless) indicator. <i>i</i> <b>NOTE:</b> The iDRAC Quick Sync 2 indicator is available only on certain configurations. <ul style="list-style-type: none"> <li>• Status LED: Enables you to identify any failed hardware components. There are up to five status LEDs and an overall system health LED (Chassis health and system ID) bar. For more information, see the Status LED indicators section.</li> </ul>

**Table 2. Features available on the front of the system (continued)**

Item	Ports, panels, and slots	Icon	Description
			<ul style="list-style-type: none"> <li>Quick Sync 2 (wireless): Indicates a Quick Sync enabled system. The Quick Sync feature is optional. This feature allows management of the system by using mobile devices called as OpenManage Mobile (OMM) feature. Using iDRAC Quick Sync 2 with OpenManage Mobile (OMM) aggregates hardware or firmware inventory and various system level diagnostic and error information that can be used in troubleshooting the system. For more information, see the <i>iDRAC User's Guide</i> available at <a href="https://www.dell.com/idracmanuals">https://www.dell.com/idracmanuals</a></li> </ul>
2	Drive	N/A	Enables you to install drives that are supported on your system.
3	Right control panel	N/A	Contains the power button, USB port, iDRAC Direct micro port, and the iDRAC Direct status LED.
4	Information tag	N/A	The Information tag is a slide-out label panel that contains system information such as Service Tag, NIC, MAC address, and so on. If you have opted for the secure default access to iDRAC, then the Information tag will also contain the iDRAC secure default password.
5	NVMe drive blank	N/A	NVMe drive blank for NVMe drive direct attached configuration.

**NOTE:** For more information, see the *Dell EMC PowerEdge R750xa Technical Specifications* on the product documentation page.

## Left control panel view



**Figure 3. Left control panel without optional iDRAC Quick Sync 2 indicator**

**Table 3. Left control panel without optional iDRAC Quick Sync 2 indicator**

Item	Indicator, button, or connector	Icon	Description
1	Status LED indicators	N/A	Indicates the status of the system. For more information, see the <a href="#">Status LED indicators</a> section.
2	System health and system ID indicator		Indicates the system health. For more information, see the <a href="#">System health and system ID indicator codes</a> section.

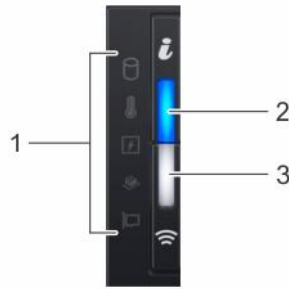


Figure 4. Left control panel with optional iDRAC Quick Sync 2 indicator

Table 4. Left control panel with optional iDRAC Quick Sync 2 indicator

Item	Indicator, button, or connector	Icon	Description
1	Status LED indicators	N/A	Indicates the status of the system. For more information, see the <a href="#">Status LED indicators</a> section.
2	System health and system ID indicator	i	Indicates the system health. For more information, see the <a href="#">System health and system ID indicator codes</a> section.
3	iDRAC Quick Sync 2 wireless indicator (optional)	Wi-Fi symbol	Indicates if the iDRAC Quick Sync 2 wireless option is activated. The Quick Sync 2 feature allows management of the system using mobile devices. This feature aggregates hardware/firmware inventory and various system level diagnostic/error information that can be used in troubleshooting the system. You can access system inventory, Dell Lifecycle Controller logs or system logs, system health status, and also configure iDRAC, BIOS, and networking parameters. You can also launch the virtual Keyboard, Video, and Mouse (KVM) viewer and virtual Kernel-based Virtual Machine (KVM), on a supported mobile device. For more information, see the Integrated Dell Remote Access Controller User's Guide at <a href="http://www.dell.com/poweredge manuals">www.dell.com/poweredge manuals</a> .

**NOTE:** For more information about the indicator codes, see the [System diagnostics and indicator codes](#) section.

## Right control panel view






Figure 5. Right control panel view

Table 5. Right control panel

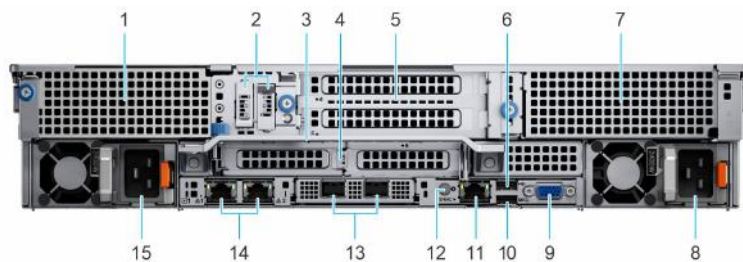
Item	Indicator or button	Icon	Description
1	Power button	Power symbol	Indicates if the system is powered on or off. Press the power button to manually power on or off the system.

**Table 5. Right control panel (continued)**

Item	Indicator or button	Icon	Description
			<b>NOTE:</b> Press the power button to gracefully shut down the ACPI-compliant operating system.
2	USB 2.0-compliant port		The USB port is a 4-pin connector and 2.0-compliant. This port enables you to connect USB devices to the system.
3	iDRAC Direct port (Micro-AB USB)		The iDRAC Direct port (Micro-AB USB) enables you to access the iDRAC Direct Micro-AB features. For more information, see the <i>iDRAC User's Guide</i> available at <a href="https://www.dell.com/idracmanuals">https://www.dell.com/idracmanuals</a> . <b>NOTE:</b> You can configure iDRAC Direct by using a USB to micro USB (type AB) cable, which you can connect to your laptop or tablet. Cable length should not exceed 3 feet (0.91 meters). Performance could be affected by cable quality.
4	VGA port		Enables you to connect a display device to the system.


**NOTE:** For more information, see the *Dell EMC PowerEdge R750xa Technical Specifications* on the product documentation page.

## Rear view of the system









**Figure 6. Rear view of the system**

**Table 6. Rear view of the system**

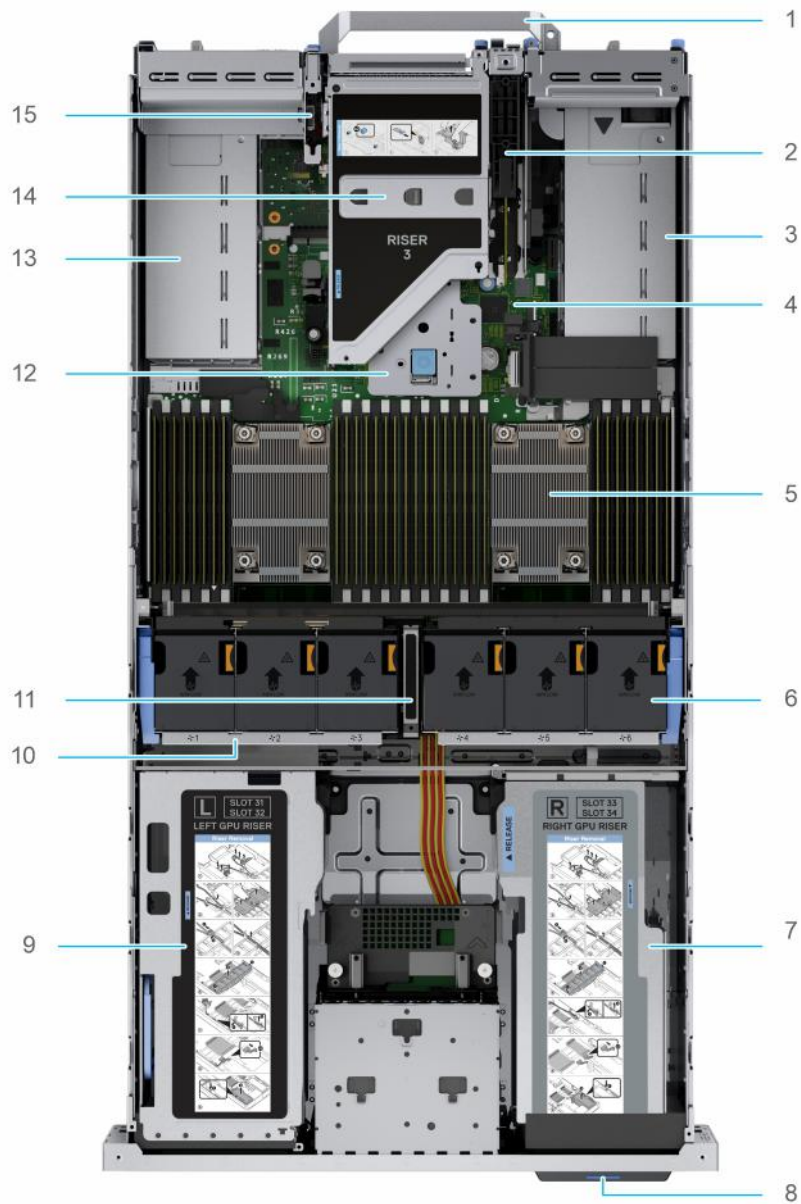
Item	Ports, panels, or slots	Icon	Description
1	PCIe expansion card riser 1 blank	N/A	Enables you to connect paddle card to support front GPU riser modules. For more information on the expansion cards supported on your system, see the <a href="#">Expansion card installation guidelines</a> section.
2	BOSS S2 module (optional)	N/A	This slot supports the BOSS S2 module.
3	Rear handle	N/A	To lift the system.
4	PCIe expansion card riser 2 (slot 3 and slot 6)	N/A	The expansion card riser enables you to connect PCI Express expansion cards. For more information on the expansion cards supported on your system, see <a href="#">Expansion card installation guidelines</a> section.
5	PCIe expansion card riser 3 (slot 4 and slot 5)	N/A	The expansion card riser enables you to connect PCI Express expansion cards. For more information on the expansion cards supported on your system, see <a href="#">Expansion card installation guidelines</a> section.
6	USB 2.0 port (1)		This port is USB 2.0-compliant.

**Table 6. Rear view of the system (continued)**

Item	Ports, panels, or slots	Icon	Description
7	PCIe expansion card riser 4 blank	N/A	Enables you to connect paddle card to support front GPU riser modules. For more information on the expansion cards supported on your system, see <a href="#">Expansion card installation guidelines</a> section.
8	Power supply unit (PSU 2)		For more information about the PSU configurations, see the <i>Dell EMC PowerEdge R750xa Technical Specifications</i> on the product documentation page.
9	VGA port		Enables you to connect a display device to the system. For more information, see the <i>Dell EMC PowerEdge R750xa Technical Specifications</i> on the product documentation page.
10	USB 3.0 port (1)		This port is USB 3.0-compliant.
11	iDRAC dedicated port	<b>iDRAC</b>	Enables you to remotely access iDRAC. For more information, see the iDRAC User's Guide at <a href="http://www.dell.com/poweredgemanuals">www.dell.com/poweredgemanuals</a> .
12	System identification button		<p>Press the system ID button:</p> <ul style="list-style-type: none"> <li>To locate a particular system within a rack.</li> <li>To turn the system ID on or off.</li> </ul> <p>To reset iDRAC, press and hold the button for more than 16 seconds.</p> <p><b>NOTE:</b></p> <ul style="list-style-type: none"> <li>To reset iDRAC using system ID, ensure that the system ID button is enabled in the iDRAC setup.</li> <li>If the system stops responding during POST, press and hold the system ID button (for more than 5 seconds) to enter the BIOS progress mode.</li> </ul>
13	OCP NIC port (optional)	N/A	This port supports OCP 3.0. The NIC ports are integrated on the OCP card which is connected to the system board.
14	NIC port (1,2)		The NIC ports are embedded on the LOM card that is connected to the system board.
15	Power supply unit (PSU 1)		For more information about the PSU configurations, see the <i>Dell EMC PowerEdge R750xa Technical Specifications</i> on the product documentation page.

 **NOTE:** For more information, see the *Dell EMC PowerEdge R750xa Technical Specifications* on the product documentation page.

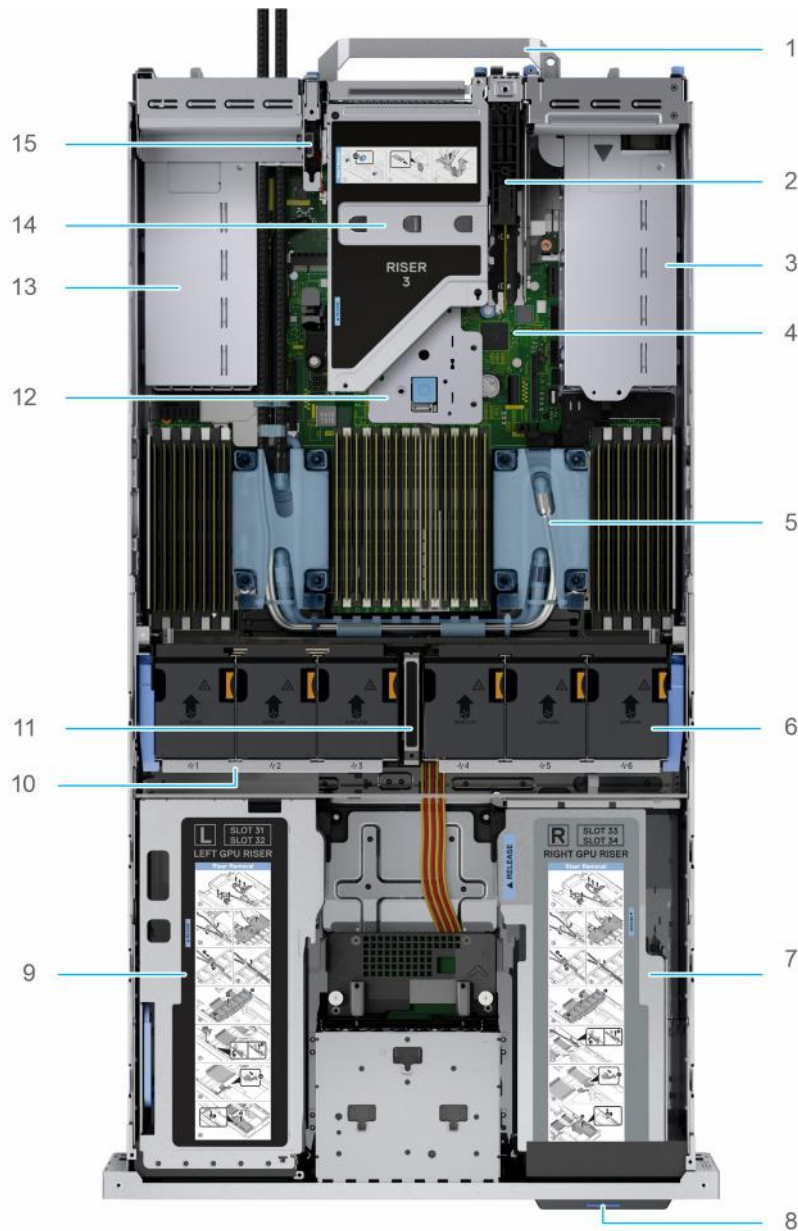
# Inside the system



**Figure 7. Inside the system**

- |                               |                               |
|-------------------------------|-------------------------------|
| 1. Handle                     | 2. BOSS S2 module             |
| 3. Power supply unit (PSU 1)  | 4. System board               |
| 5. Heat sink for processor 1  | 6. Cooling fan                |
| 7. GPU riser module right     | 8. Service tag                |
| 9. GPU riser module left      | 10. Cooling fan cage assembly |
| 11. Cable access latch        | 12. Riser 2 cage              |
| 13. Power supply unit (PSU 2) | 14. Riser 3 cage              |
| 15. Intrusion switch module   |                               |





**Figure 8. Inside the system with liquid cooling module**

- |                               |                               |
|-------------------------------|-------------------------------|
| 1. Handle                     | 2. BOSS S2 module             |
| 3. Power supply unit (PSU 1)  | 4. System board               |
| 5. Liquid cooling module      | 6. Cooling fan                |
| 7. GPU riser module right     | 8. Service tag                |
| 9. GPU riser module left      | 10. Cooling fan cage assembly |
| 11. Cable access latch        | 12. Riser 2 cage              |
| 13. Power supply unit (PSU 2) | 14. Riser 3 cage              |
| 15. Intrusion switch module   |                               |

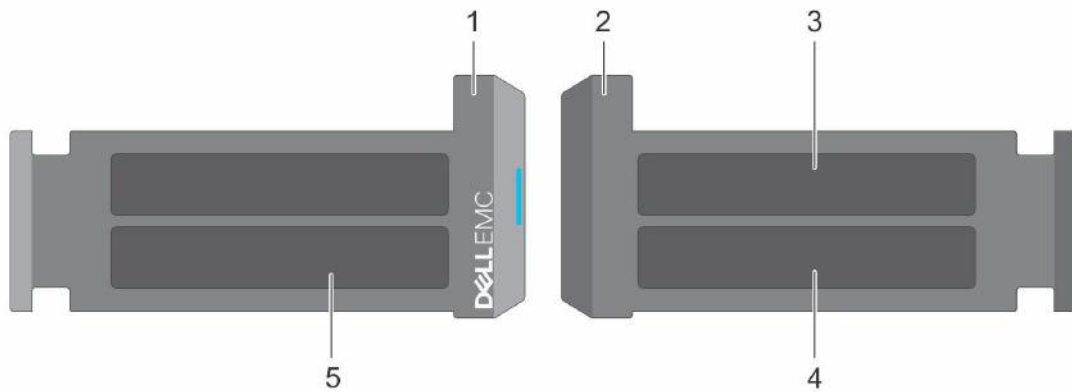
## Locating the Express Service Code and Service Tag

The unique Express Service Code and Service Tag are used to identify the system.

The information tag is located on the front of the system that includes system information such as the Service Tag, Express Service Code, Manufacture date, NIC, MAC address, QRL label, and so on. If you have opted for the secure default access to iDRAC, the Information tag also contains the iDRAC secure default password. If you have opted for iDRAC Quick Sync



2, the Information tag also contains the OpenManage Mobile (OMM) label, where administrators can configure, monitor, and troubleshoot the PowerEdge servers.



**Figure 9. Locating the Express Service Code and Service tag**

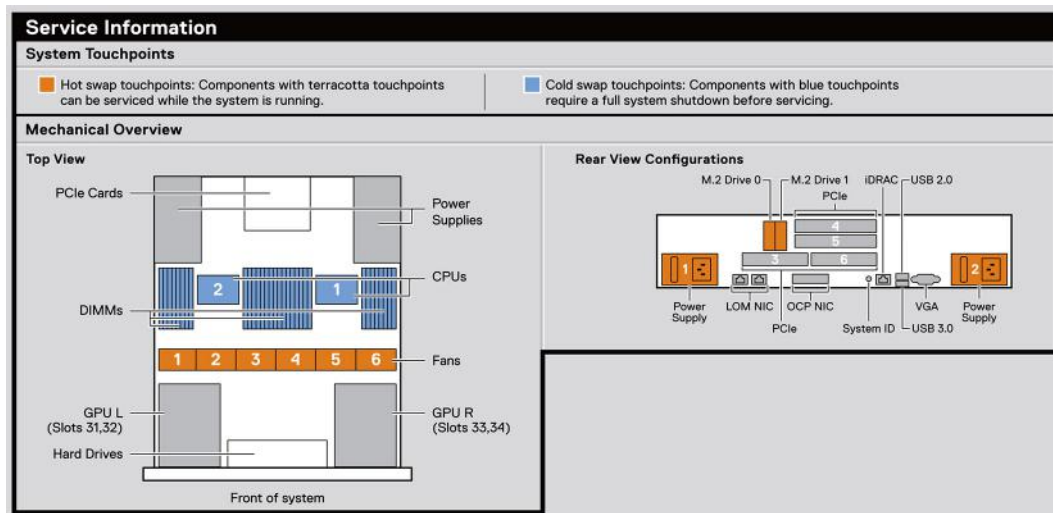
1. Information tag (front view)
2. Information tag (back view)
3. OpenManage Mobile (OMM) label
4. iDRAC MAC address and iDRAC secure password label
5. Service Tag, Express Service Code, QRL label

The Mini Enterprise Service Tag (MEST) label is located on the rear of the system that includes the Service Tag (ST), Express Service Code (Exp Svc Code), and Manufacture Date (Mfg. Date). The Exp Svc Code is used by Dell EMC to route support calls to the appropriate personnel.

Alternatively, the Service Tag information is located on a label on the left wall of the chassis.

## System information label

The system information label is located on the back side of the system cover.



**Figure 10. Service information**

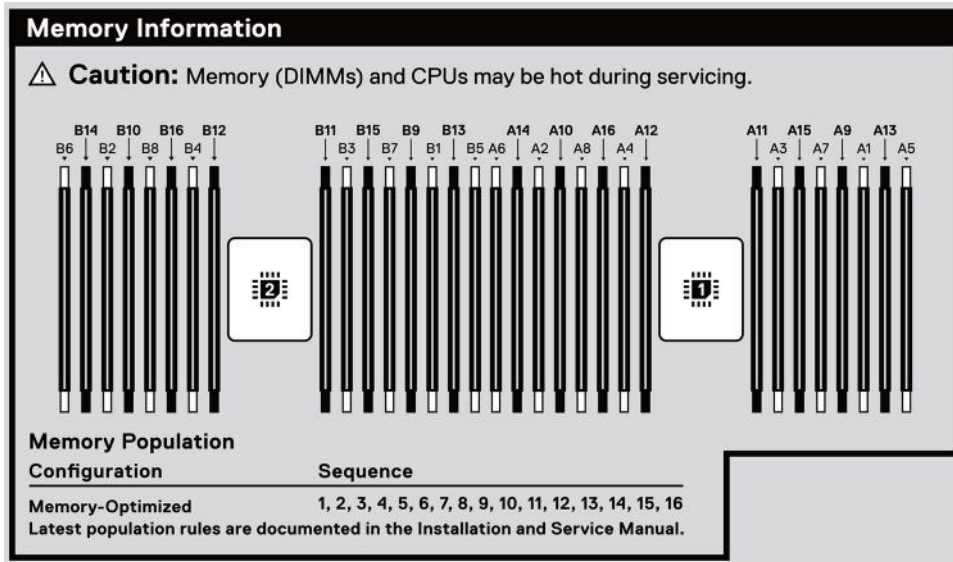


Figure 11. Memory information and system board connectors

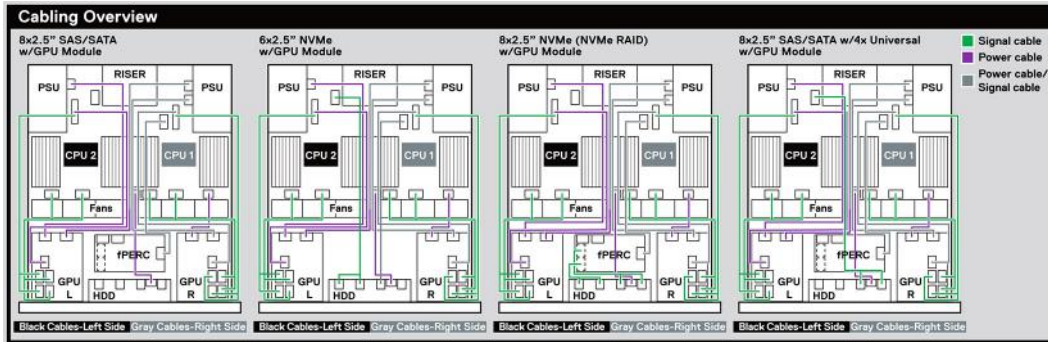


Figure 12. Cabling overview

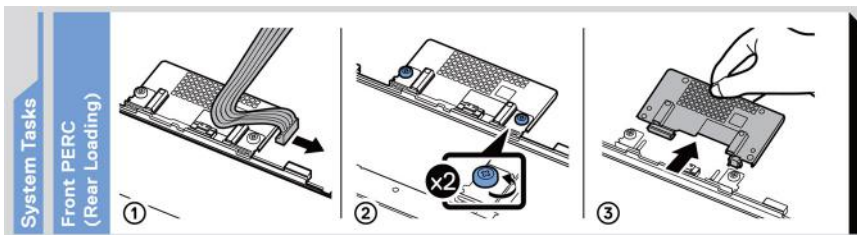


Figure 13. System tasks

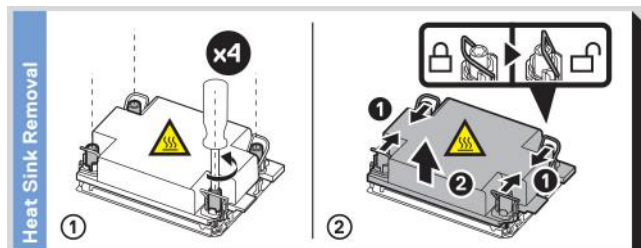


Figure 14. Heat sink

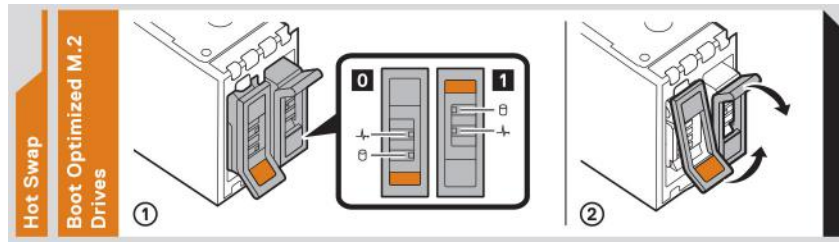


Figure 15. BOSS S2

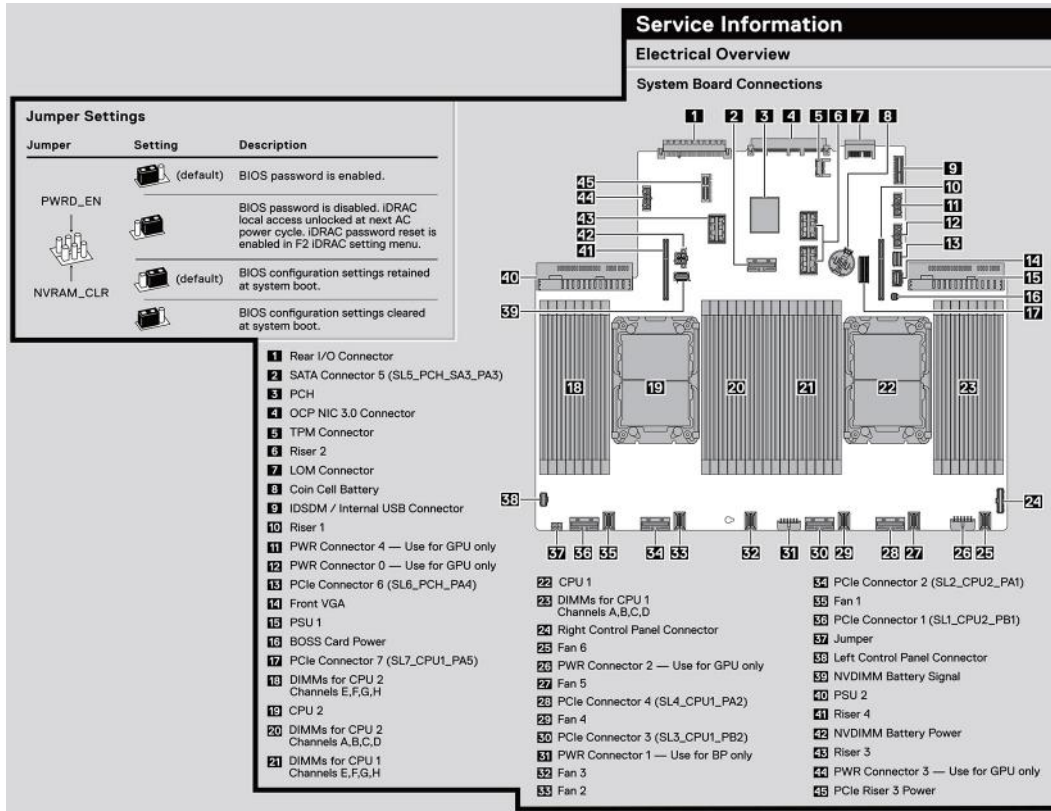


Figure 16. Electrical overview

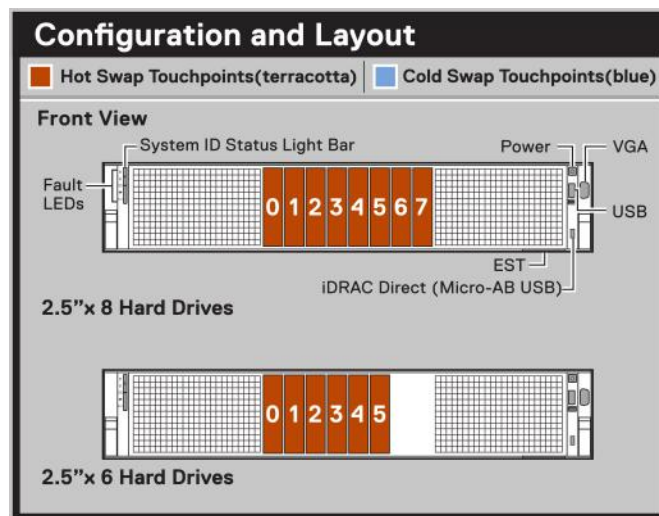


Figure 17. Configuration and layout

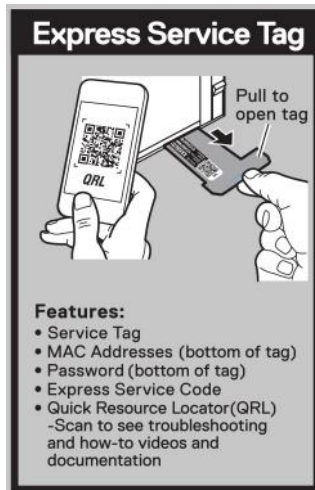


Figure 18. Express service tag

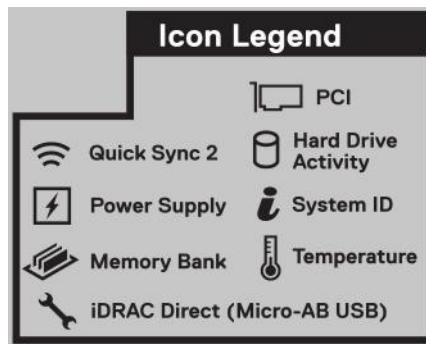


Figure 19. Icon legend

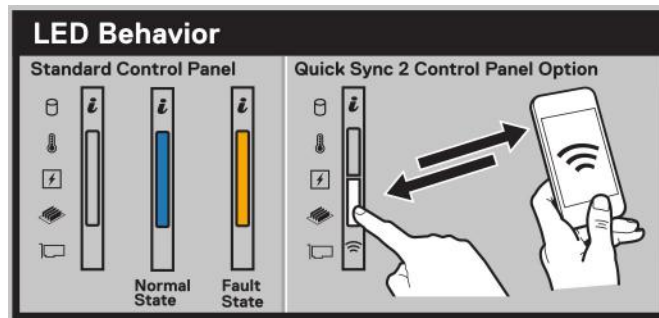


Figure 20. LED behavior

## Rail sizing and rack compatibility matrix

For specific information about the rail solutions compatible with your system, see the *Dell EMC Enterprise Systems Rail Sizing and Rack Compatibility Matrix* available at [https://i.dell.com/sites/csdocuments/Business\\_solutions\\_engineering-Docs\\_Documents/en/rail-rack-matrix.pdf](https://i.dell.com/sites/csdocuments/Business_solutions_engineering-Docs_Documents/en/rail-rack-matrix.pdf).

The document provides the information that is listed below:

- Specific details about rail types and their functionalities.
- Rail adjustability range for various types of rack mounting flanges.
- Rail depth with and without cable management accessories.
- Types of racks supported for various types of rack mounting flanges.

# Initial system setup and configuration

This section describes the tasks for initial setup and configuration of the Dell EMC system. The section also provides general steps to set up the system and the reference guides for detailed information.

## Topics:

- [Setting up the system](#)
- [iDRAC configuration](#)
- [Resources to install operating system](#)

## Setting up the system

Perform the following steps to set up the system:

### Steps

1. Unpack the system.
2. Install the system into the rack. For more information, see the rail installation and cable management accessory guides relevant to your rail and cable management solution at [www.dell.com/poweredgemanuals](http://www.dell.com/poweredgemanuals).
3. Connect the peripherals to the system and the system to the electrical outlet.
4. Power on the system.

For more information about setting up the system, see the *Getting Started Guide* that is shipped with your system.

**NOTE:** For information about managing the basic settings and features of the system, see the *Dell EMC PowerEdge R750xa BIOS and UEFI Reference Guide* on the product documentation page.

## iDRAC configuration

The Integrated Dell Remote Access Controller (iDRAC) is designed to make you more productive as a system administrator and improve the overall availability of Dell EMC servers. iDRAC alerts you to system issues, helps you to perform remote management, and reduces the need for physical access to the system.

### Options to set up iDRAC IP address

To enable communication between your system and iDRAC, you must first configure the network settings based on your network infrastructure. The network settings option is set to **DHCP**, by default.





**NOTE:** For static IP configuration, you must request for the settings at the time of purchase.


You can set up the iDRAC IP address using one of the interfaces in the table below. For information about setting up iDRAC IP address, see the documentation links provided in the table below.

**Table 7. Interfaces to set up iDRAC IP address**

Interface	Documentation links
iDRAC Settings utility	<i>Integrated Dell Remote Access Controller User's Guide</i> at <a href="https://www.dell.com/idracmanuals">https://www.dell.com/idracmanuals</a> or for system specific <i>Integrated Dell Remote Access Controller User's Guide</i> , go to <a href="https://www.dell.com/poweredgemanuals">https://www.dell.com/poweredgemanuals</a> > <b>Product Support</b> page of your system > <b>Documentation</b> .

**Table 7. Interfaces to set up iDRAC IP address (continued)**

Interface	Documentation links
	<p> <b>NOTE:</b> To determine the most recent iDRAC release for your platform and for latest documentation version, see KB article <a href="https://www.dell.com/support/article/sln308699">https://www.dell.com/support/article/sln308699</a>.</p>
OpenManage Deployment Toolkit	<p><i>OpenManage Deployment Toolkit User's Guide</i> available at <a href="https://www.dell.com/openmanagemanuals">https://www.dell.com/openmanagemanuals</a> &gt; Open Manage Deployment Toolkit.</p>
iDRAC Direct	<p><i>Integrated Dell Remote Access Controller User's Guide</i> at <a href="https://www.dell.com/idracmanuals">https://www.dell.com/idracmanuals</a> or for system specific <i>Integrated Dell Remote Access Controller User's Guide</i>, go to <a href="https://www.dell.com/poweredgemanuals">https://www.dell.com/poweredgemanuals</a> &gt; <b>Product Support</b> page of your system &gt; <b>Documentation</b>.</p> <p> <b>NOTE:</b> To determine the most recent iDRAC release for your platform and for latest documentation version, see KB article <a href="https://www.dell.com/support/article/sln308699">https://www.dell.com/support/article/sln308699</a>.</p>
Lifecycle Controller	<p><i>Lifecycle Controller User's Guide</i> at <a href="https://www.dell.com/idracmanuals">https://www.dell.com/idracmanuals</a> or for system specific <i>Lifecycle Controller User's Guide</i>, go to <a href="https://www.dell.com/poweredgemanuals">https://www.dell.com/poweredgemanuals</a> &gt; <b>Product Support</b> page of your system &gt; <b>Documentation</b>.</p> <p> <b>NOTE:</b> To determine the most recent iDRAC release for your platform and for latest documentation version, see KB article <a href="https://www.dell.com/support/article/sln308699">https://www.dell.com/support/article/sln308699</a>.</p>
Server LCD panel	<p>LCD panel section.</p>
iDRAC Direct and Quick Sync 2 (optional)	<p><i>Integrated Dell Remote Access Controller User's Guide</i> at <a href="https://www.dell.com/idracmanuals">https://www.dell.com/idracmanuals</a> or for system specific <i>Integrated Dell Remote Access Controller User's Guide</i>, go to <a href="https://www.dell.com/poweredgemanuals">https://www.dell.com/poweredgemanuals</a> &gt; <b>Product Support</b> page of your system &gt; <b>Documentation</b>.</p> <p> <b>NOTE:</b> To determine the most recent iDRAC release for your platform and for latest documentation version, see KB article <a href="https://www.dell.com/support/article/sln308699">https://www.dell.com/support/article/sln308699</a>.</p>

 **NOTE:** To access iDRAC, ensure that you connect the ethernet cable to the iDRAC dedicated network port or use the iDRAC Direct port by using the USB cable. You can also access iDRAC through the shared LOM mode, if you have opted for a system that has the shared LOM mode enabled.


## Options to log in to iDRAC

To log in to the iDRAC Web User Interface, open a browser and enter the IP address.

You can log in to iDRAC as:

- iDRAC user
- Microsoft Active Directory user
- Lightweight Directory Access Protocol (LDAP) user

In the login screen displayed, if you have opted for secure default access to iDRAC, enter the iDRAC secure default password available on back of the Information Tag. If you have not opted for secure default access to iDRAC, enter the default user name and password – `root` and `calvin`. You can also log in by using your Single Sign-On or Smart Card.

 **NOTE:** Ensure that you change the default username and password after setting up the iDRAC IP address.



For more information about logging in to the iDRAC and iDRAC licenses, see the latest *Integrated Dell Remote Access Controller User's Guide* at [www.dell.com/idracmanuals](http://www.dell.com/idracmanuals).

**NOTE:** To determine the most recent iDRAC release for your platform and for latest documentation version, see KB article <https://www.dell.com/support/article/sln308699>.

You can also access iDRAC using command-line protocol - RACADM. For more information, see the *iDRAC with Lifecycle Controller RACADM CLI Guide* available at [www.dell.com/idracmanuals](http://www.dell.com/idracmanuals).

You can also access iDRAC using automation tool - Redfish API. For more information, see the *iDRAC9 with Lifecycle Controller Redfish API Guide* available at <https://www.dell.com/idracmanuals>.

## Resources to install operating system

If the system is shipped without an operating system, you can install a supported operating system by using one of the resources provided in the table below. For information about how to install the operating system, see the documentation links provided in the table below.

**Table 8. Resources to install the operating system**

Resource	Documentation links
iDRAC	<i>Integrated Dell Remote Access Controller User's Guide</i> at <a href="https://www.dell.com/idracmanuals">https://www.dell.com/idracmanuals</a> or for system specific <i>Integrated Dell Remote Access Controller User's Guide</i> , go to <a href="https://www.dell.com/poweredgemanuals">https://www.dell.com/poweredgemanuals</a> > <b>Product Support</b> page of your system > <b>Documentation</b> . <b>NOTE:</b> To determine the most recent iDRAC release for your platform and for latest documentation version, see KB article at <a href="https://www.dell.com/support/article/sln308699">https://www.dell.com/support/article/sln308699</a> .
Lifecycle Controller	<i>Lifecycle Controller User's Guide</i> at <a href="https://www.dell.com/idracmanuals">https://www.dell.com/idracmanuals</a> or for system specific <i>Lifecycle Controller User's Guide</i> , go to <a href="https://www.dell.com/poweredgemanuals">https://www.dell.com/poweredgemanuals</a> > <b>Product Support</b> page of your system > <b>Documentation</b> . Dell recommends using Lifecycle Controller to install the OS, since all required drivers are installed on the system. <b>NOTE:</b> To determine the most recent iDRAC release for your platform and for latest documentation version, see KB article at <a href="https://www.dell.com/support/article/sln308699">https://www.dell.com/support/article/sln308699</a> .
OpenManage Deployment Toolkit	<a href="http://www.dell.com/openmanagemanuals">www.dell.com/openmanagemanuals</a> > OpenManage Deployment Toolkit
Dell certified VMware ESXi	<a href="http://www.dell.com/virtualizationsolutions">www.dell.com/virtualizationsolutions</a>

**NOTE:** For more information about Installation and How-to videos for supported operating systems on PowerEdge system, see [Supported Operating Systems for Dell EMC PowerEdge systems](#).

## Options to download firmware

You can download firmware from the Dell support site. For information about downloading firmware, see the [Downloading drivers and firmware](#) section.

You can also choose any one of the following options to download the firmware. For information about how to download the firmware, see the documentation links provided in the table below.

**Table 9. Options to download firmware**

Option	Documentation link
Using Integrated Dell Remote Access Controller Lifecycle Controller (iDRAC with LC)	<a href="http://www.dell.com/idracmanuals">www.dell.com/idracmanuals</a>
Using Dell Repository Manager (DRM)	<a href="http://www.dell.com/openmanagemanuals">www.dell.com/openmanagemanuals</a> > Repository Manager
Using Dell Server Update Utility (SUU)	<a href="http://www.dell.com/openmanagemanuals">www.dell.com/openmanagemanuals</a> > Server Update Utility
Using Dell OpenManage Deployment Toolkit (DTK)	<a href="http://www.dell.com/openmanagemanuals">www.dell.com/openmanagemanuals</a> > OpenManage Deployment Toolkit

**Table 9. Options to download firmware (continued)**

Option	Documentation link
Using iDRAC virtual media	<a href="http://www.dell.com/idracmanuals">www.dell.com/idracmanuals</a>

## Options to download and install OS drivers

You can choose any one of the following options to download and install OS drivers. For information about how to download or install OS drivers, see the documentation links provided in the table below.

**Table 10. Options to download and install OS drivers**

Option	Documentation
Dell EMC support site	<a href="#">Downloading drivers and firmware</a> section.
iDRAC virtual media	<i>Integrated Dell Remote Access Controller User's Guide</i> at <a href="https://www.dell.com/idracmanuals">https://www.dell.com/idracmanuals</a> or for system specific <i>Integrated Dell Remote Access Controller User's Guide</i> , go to <a href="https://www.dell.com/poweredgemanuals">https://www.dell.com/poweredgemanuals</a> > <b>Product Support</b> page of your system > <b>Documentation</b> . <b>NOTE:</b> To determine the most recent iDRAC release for your platform and for latest documentation version, see <a href="https://www.dell.com/support/article/sln308699">https://www.dell.com/support/article/sln308699</a> .

## Downloading drivers and firmware

It is recommended that you download and install the latest BIOS, drivers, and systems management firmware on the system.

### Prerequisites

Ensure that you clear the web browser cache before downloading the drivers and firmware.

### Steps

1. Go to [www.dell.com/support/drivers](http://www.dell.com/support/drivers).
2. Enter the Service Tag of the system in the **Enter a Dell Service Tag, Dell EMC Product ID or Model** field, and then press Enter.  
**NOTE:** If you do not have the Service Tag, click **Browse all products**, and navigate to your product.
3. On the displayed product page, click **Drivers & Downloads**.  
On the **Drivers & Downloads** page, all drivers that are applicable to the system are displayed.
4. Download the drivers to a USB drive, CD, or DVD.



# Minimum to POST and system management configuration validation

This section describes the minimum to POST system requirement and system management configuration validation of the Dell EMC system.

## Topics:

- [Minimum configuration to POST](#)
- [Configuration validation](#)

## Minimum configuration to POST

The components listed below are the minimum configuration to POST:

- One processor (CPU) in socket processor 1
- One memory module (DIMM) in socket A1
- One power supply unit
- System board + LOM card + RIO card

## Configuration validation

The new generation of PowerEdge systems have added interconnect flexibility and advanced iDRAC management features to collect precise system configuration information and report configuration errors.

When the system is powered on, information about installed cables, risers, backplanes, floating card (fPERC or BOSS), and processor is obtained from the CPLD and backplane memory maps is analyzed. This information forms a unique configuration, which is compared with one of the qualified configurations stored in a table maintained by iDRAC.

One or more sensors are assigned to each of the configuration elements. During POST, any configuration validation error is logged in the System Event Log (SEL)/LifeCycle (LC) log. The reported events are categorized in the configuration validation error table.

**Table 11. Configuration validation error**

Error	Description	Possible cause and recommendations	Example
Config Error	A configuration element within the closest match contains something that is unexpected and does not match any Dell qualified configuration.	Wrong configuration	Config Error: Backplane cable CTRS_SRC_SA1 and BP-DST_SA1
		The element reported in HWC8010 errors are assembled incorrectly. Verify element (cable, riser, etc) placement in the system.	Config Error : SL Cable PLANAR_SL7 and CTRL_DST_PA1
Config Missing	iDRAC found a configuration element missing within the closest match detected.	Missing or damaged cable, device, or part	Config Missing: Float card front PERC/HBA
		Missing element or cable is reported in HWC8010 error logs. Install the missing element (cable, riser, etc).	Config Missing : SL cable PLANAR_SL8 and CTRL_DST_PA1

**Table 11. Configuration validation error (continued)**

Error	Description	Possible cause and recommendations	Example
Comm Error	A configuration element is not responding to iDRAC using the management interface while running an inventory check.	System management sideband communication  Unplug AC Power, reseal the element and replace the element if the problem persists.	Comm Error: Backplane 2

## Error messages

This section describes the error messages displayed on the screen during POST or captured in the system event log (SEL)/ LifeCycle (LC) log.

**Table 12. Error message HWC8010**

Error code	HWC8010
Message	The System Configuration Check operation resulted in the following issue involving the indicated component type
Arguments	Riser, floating card (fPERC or BOSS), backplane, processor, cable, or other components
Detailed Description	The issue identified in the message is observed in the System Configuration Check operation.
Recommended Response Action	Do the following and retry the operation: <ol style="list-style-type: none"> <li>1. Disconnect the input power.</li> <li>2. Check for proper cable connection and component placement. If the issue persists, contact the service provider.</li> </ol>
Category	System Health (HWC = Hardware Config)
Severity	Critical
Trap/EventID	2329

**Table 13. Error message HWC8011**


Error code	HWC8011
Message	The System Configuration Check operation resulted in multiple issues involving the indicated component type
Arguments	Riser, floating card (fPERC or BOSS), backplane, processor, cable, or other components
Detailed Description	Multiple issues are observed in the System Configuration Check operation.
Recommended Response Action	Do the following and retry the operation: <ol style="list-style-type: none"> <li>1. Disconnect the input power.</li> <li>2. Check for proper cable connection and component placement. If the issue persists, contact the service provider.</li> </ol>
Category	System Health (HWC = Hardware Config)
Severity	Critical


# Installing and removing system components

## Topics:


- Safety instructions
- Before working inside your system
- After working inside your system
- Recommended tools
- Optional front bezel
- System cover
- Drive backplane cover
- Air shroud
- Cooling fans
- Side wall brackets
- Drives
- PERC module
- Drive backplane
- Cable routing
- System memory
- Processor and heat sink module
- Expansion cards and expansion card risers
- Optional serial COM port
- Optional VGA port for liquid cooling module
- Optional IDSDM module
- MicroSD card
- M.2 SSD module
- Optional BOSS S2 module
- System battery
- Optional internal USB card
- Intrusion switch module
- Optional OCP card
- Power supply unit
- Trusted Platform Module
- System board
- LOM card and rear I/O board
- Control panel

## Safety instructions

 **NOTE:** Whenever you need to lift the system, get others to assist you. To avoid injury, do not attempt to lift the system by yourself.

 **CAUTION:** Ensure to have two or more people to lift the system horizontally from the box and place it on a flat surface, rack lift, or into the rails.

 **WARNING:** Opening or removing the system cover while the system is powered on may expose you to a risk of electric shock.

 **WARNING:** Do not operate the system without the cover for a duration exceeding five minutes. Operating the system without the system cover can result in component damage.

**CAUTION:** Many repairs may only be done by a certified service technician. You should only perform troubleshooting and simple repairs as authorized in your product documentation, or as directed by the online or telephone service and support team. Damage due to servicing that is not authorized by Dell is not covered by your warranty. Read and follow the safety instructions that are shipped with your product.

**NOTE:** It is recommended that you always use an antistatic mat and antistatic strap while working on components inside the system.

**CAUTION:** To ensure proper operation and cooling, all system bays and fans must always be populated with a component or a blank.

**NOTE:** While replacing the hot swappable PSU, after next server boot; the new PSU automatically updates to the same firmware and configuration of the replaced one. For more information about the Part replacement configuration, see the *Lifecycle Controller User's Guide* at <https://www.dell.com/idracmanuals>.

**NOTE:** While replacing faulty storage controller, FC, or NIC card with the same type of card, after you power on the system; the new card automatically updates to the same firmware and configuration of the faulty one. For more information about the Part replacement configuration, see the *Lifecycle Controller User's Guide* at <https://www.dell.com/idracmanuals>.

## Before working inside your system

### Prerequisites

Follow the safety guidelines listed in the [Safety instructions](#).

### Steps

1. Power off the system and all attached peripherals.
2. Disconnect the system from the electrical outlet, and disconnect the peripherals.
3. If applicable, remove the system from the rack.

For more information, see the *Rail Installation Guide* relevant to your rail solutions at [www.dell.com/poweredgemanuals](http://www.dell.com/poweredgemanuals).

4. Remove the system cover.

## After working inside your system

### Prerequisites

Follow the safety guidelines listed in [Safety instructions](#).

### Steps

1. Replace the system cover.
2. If applicable, install the system into the rack.

For more information, see the *Rail Installation Guide* relevant to your rail solutions at [www.dell.com/poweredgemanuals](http://www.dell.com/poweredgemanuals).

3. Reconnect the peripherals and connect the system to the electrical outlet, and then power on the system.

## Recommended tools

You need the following tools to perform the removal and installation procedures:

- Key to the bezel lock. The key is required only if your system includes a bezel.
- Phillips #1 screwdriver
- Phillips #2 screwdriver
- Torx #T30 screwdriver
- Torx #T15 screwdriver
- 5 mm hex nut screwdriver
- Plastic scribe

- 1/4-inch flat blade screwdriver
- Wrist grounding strap connected to the ground
- ESD mat
- Needle-nose pliers

You need the following tools to assemble the cables for a DC power supply unit:

- AMP 90871-1 hand-crimping tool or equivalent
  - Tyco Electronics 58433-3 or equivalent
  - Wire-stripper pliers to remove insulation from size 10 AWG solid or stranded, insulated copper wire
- i** **NOTE:** Use alpha wire part number 3080 or equivalent (65/30 stranding).

## Optional front bezel

**i** **NOTE:** LCD panel is optional on the front bezel. If the front bezel has an LCD panel, see [LCD panel](#) section.

## Removing the front bezel

The procedure to remove the front bezel with and without the LCD panel is the same.

### Prerequisites

1. Follow the safety guidelines listed in the [Safety instructions](#).
2. Keep the bezel key handy.

**i** **NOTE:** The bezel key is part of the LCD bezel package.

### Steps

1. Unlock the bezel.
2. Press the release button, and disengage the left end of the bezel.
3. Unhook the right end, and remove the bezel.



**Figure 21. Removing the front bezel**

### Next steps


[Replace front bezel.](#)

## Installing the front bezel

The procedure to install the front bezel with and without the LCD panel is the same.

### Prerequisites

1. Follow the safety guidelines listed in the [Safety instructions](#).
2. Locate and remove the bezel key.

 **NOTE:** The bezel key is part of the LCD bezel package.

### Steps

1. Align and insert the tabs on the bezel into the slots on the system.
2. Press the bezel until the release button clicks in place.
3. Lock the bezel.



Figure 22. Installing the front bezel

## System cover

### Removing the system cover

#### Prerequisites

1. Follow the safety guidelines listed in the [Safety instructions](#).
2. Power off the system, and any attached peripherals.
3. Disconnect the system from the electrical outlet and peripherals.

### Steps

1. Using a 1/4-inch flat head or a Phillips #2 screwdriver, rotate the lock counterclockwise to the unlock position.
2. Lift the release latch until the system cover slides back.
3. Lift the cover from the system.



Figure 23. Removing the system cover

### Next steps

1. [Replace the system cover.](#)

## Installing the system cover

### Prerequisites

1. Follow the safety guidelines listed in the [Safety instructions](#).
2. Follow the procedure listed in [Before working inside your system](#).
3. Ensure that all internal cables are connected and routed properly, and no tools or extra parts are left inside the system.

### Steps

1. Align the tabs on the system cover with the guide slots on the system and slide the system cover.
2. Close the system cover release latch.
3. Using a 1/4-inch flat head or Phillips #2 screwdriver, rotate the lock clockwise to the lock position.



**Figure 24. Installing the system cover**

#### **Next steps**

1. Follow the procedure listed in [After working inside your system](#).

## **Drive backplane cover**

### **Removing the drive backplane cover**

#### **Prerequisites**

1. Follow the safety guidelines listed in the [Safety instructions](#).
2. Follow the procedure listed in [Before working inside your system](#).

#### **Steps**

1. Press the blue tab and slide the drive backplane cover.
2. Lift the drive backplane cover from the system.





**Figure 25. Removing the drive backplane cover**

#### **Next steps**

1. [Replace the drive backplane cover.](#)

## **Installing the drive backplane cover**

#### **Prerequisites**

1. Follow the safety guidelines listed in the [Safety instructions](#).
2. Follow the procedure listed in [Before working inside your system](#).

#### **Steps**

1. Align the drive backplane cover with the guide slots on the system.
2. Slide the drive backplane cover to the front of the system until the drive backplane cover fits into place.



**Figure 26. Installing the drive backplane cover**

**Next steps**

1. Follow the procedure listed in [After working inside your system.](#)

# Air shroud

## Removing the air shroud

### Prerequisites

**CAUTION:** Never operate your system with the air shroud removed. The system may get overheated quickly, resulting in shutdown of the system and loss of data.

1. Follow the safety guidelines listed in the [Safety instructions](#).
2. Follow the procedure listed in [Before working inside your system](#).
3. Remove the cables from the air shroud notch, place them on other shroud and opposite way.

### Steps

1. Press the latch on the air shroud.

**NOTE:** To remove left air shroud, press the latch on right air shroud and the opposite way.

2. Hold the edges of the air shroud, and lift the air shroud out of the system.

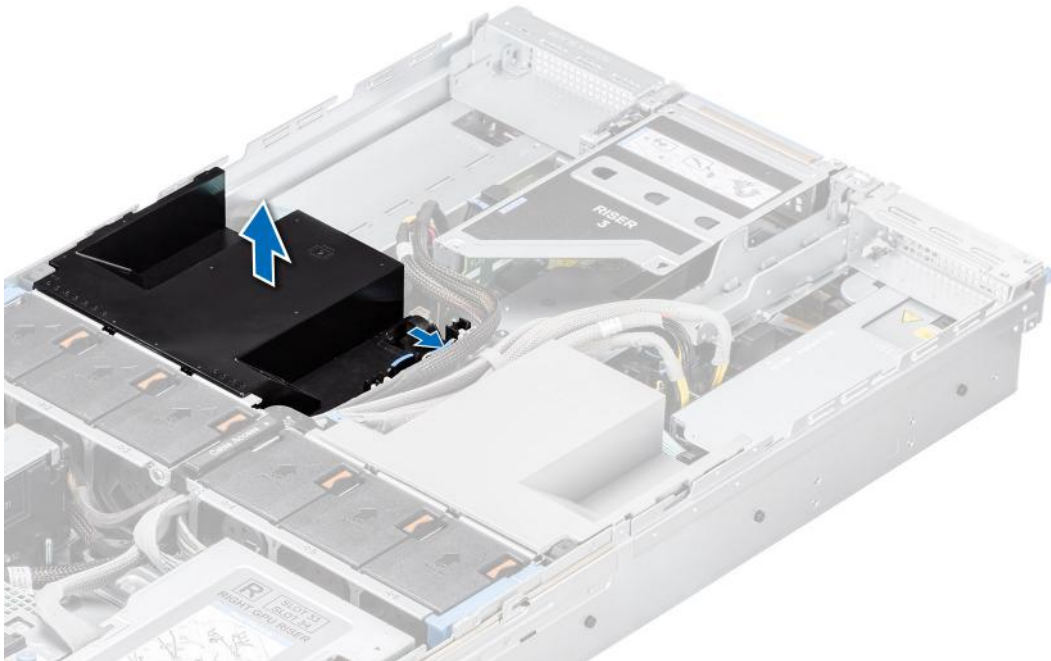
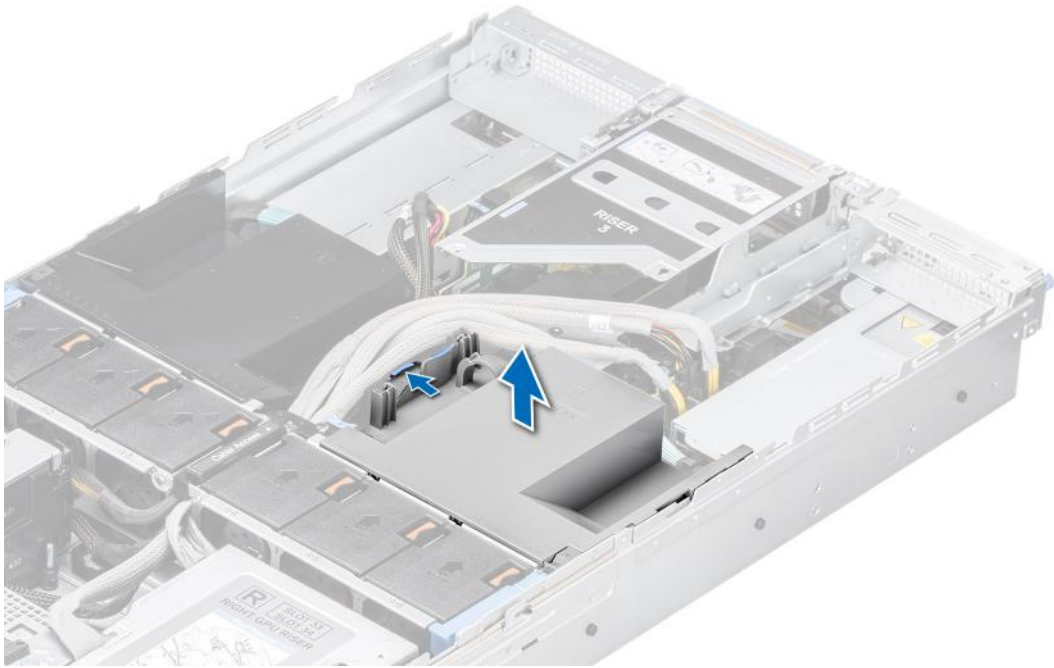


Figure 27. Removing the left air shroud



**Figure 28. Removing the right air shroud**

#### **Next steps**

1. [Replace the air shroud.](#)

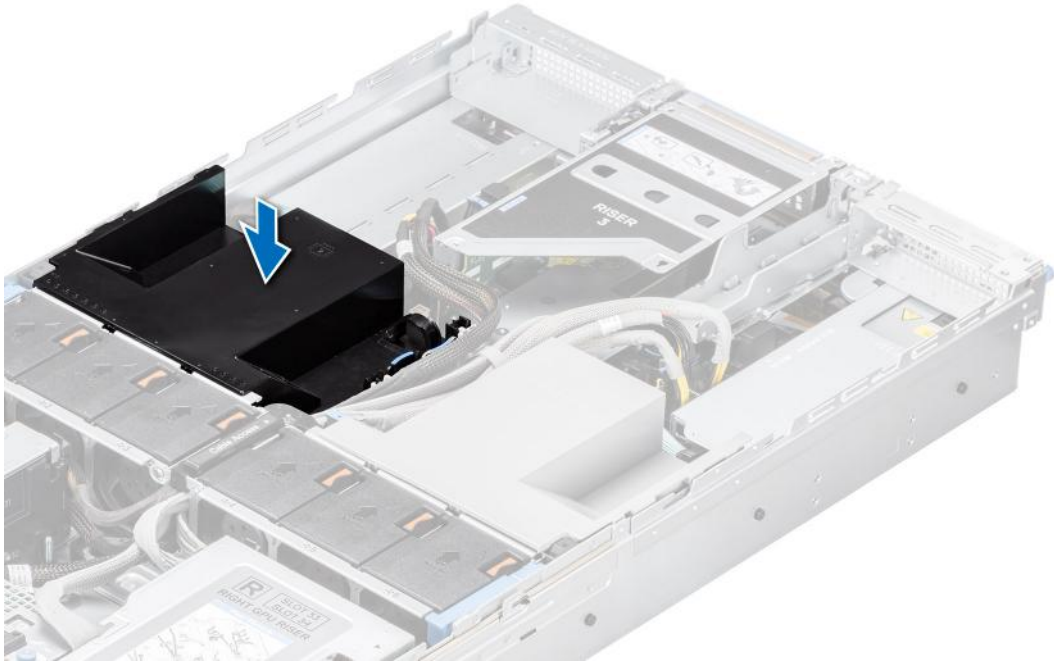
## **Installing the air shroud**

#### **Prerequisites**

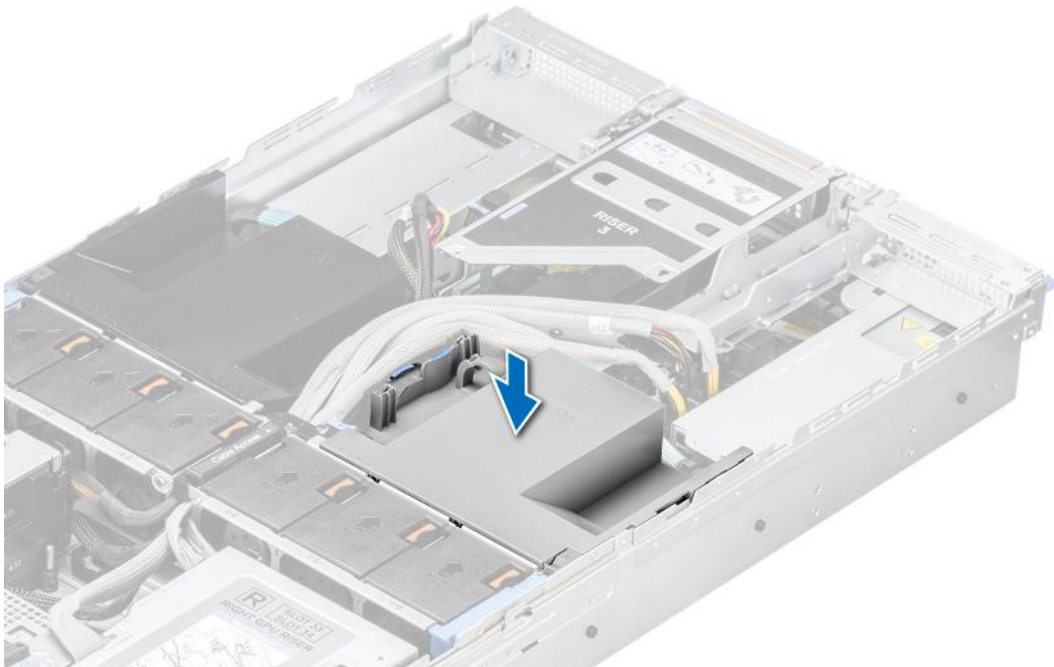
1. Follow the safety guidelines listed in the [Safety instructions](#).
2. Follow the procedure listed in [Before working inside your system](#).
3. Remove the cables from the air shroud notch, place them on other shroud and opposite way.

#### **Steps**

1. Align the slot on the air shroud with the tab on the left or right air shroud.
2. Lower the air shroud into the system until it is firmly seated.



**Figure 29. Installing the left air shroud**



**Figure 30. Installing the right air shroud**

**Next steps**

1. Insert the cables into the air shroud notch. Black cable goes to black air shroud notch and gray cables goes to gray air shroud notch.
2. Follow the procedure listed in [Safety instructions](#).

# Removing the air shroud blank

### Prerequisites

**CAUTION:** Never operate your system with the air shroud removed. The system may get overheated quickly, resulting in shutdown of the system and loss of data.

1. Follow the safety guidelines listed in the [Safety instructions](#).
2. Follow the procedure listed in [Before working inside your system](#).
3. Remove the cables from the air shroud notch and keep them aside.
4. [Remove the air shroud](#) and keep air shroud blank side facing up.

### Steps

Press the release tabs and lift the air shroud blank from air shroud .

**NOTE:** System with liquid cooling configuration must have air shroud blank installed for proper thermal management.

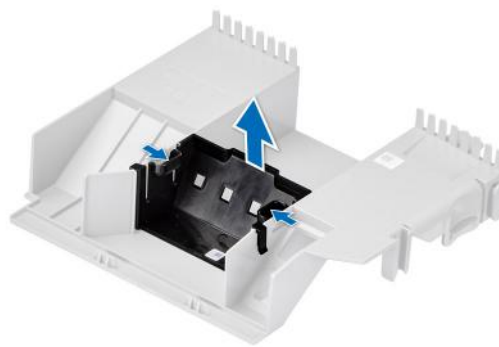


Figure 31. Removing the air shroud blank

### Next steps

1. [Replace the air shroud blank](#).

# Installing the air shroud blank

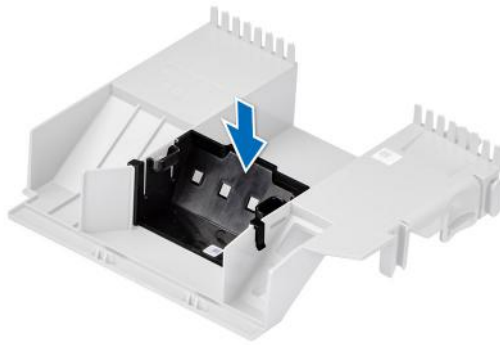
### Prerequisites

1. Follow the safety guidelines listed in the [Safety instructions](#).
2. Follow the procedure listed in [Before working inside your system](#).
3. Remove the cables from the air shroud notch and keep them aside .
4. [Remove the air shroud](#) and keep air shroud blank side facing up.

### Steps

Align and lower the air shroud blank into air shroud until it is firmly seated.

**NOTE:** System with liquid cooling configuration must have air shroud blank installed for proper thermal management.



**Figure 32. Installing the left air shroud**

**Next steps**

1. [Install the air shroud.](#)
2. Follow the procedure listed in [After working inside your system.](#)

## Cooling fans

### Removing the cooling fan cage assembly

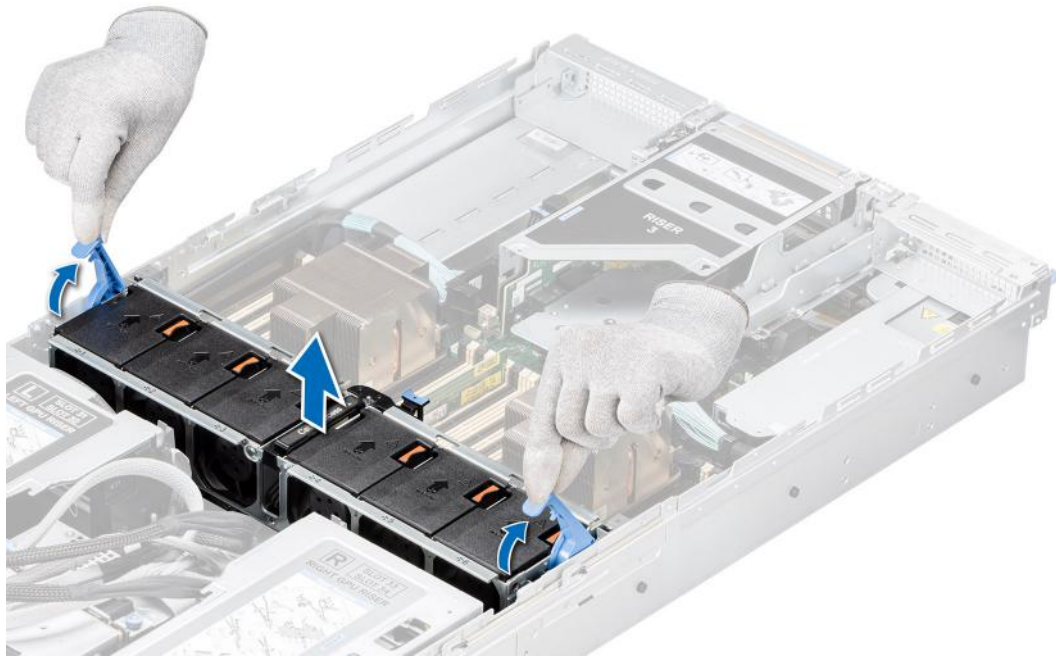
**Prerequisites**

1. Follow the safety guidelines listed in the [Safety instructions.](#)
2. Follow the procedure listed in the [Before working inside your system.](#)
3. If installed, [remove the air shroud.](#)
4. Disconnect the cables from system board that pass through the cooling fan cage assembly cable latch.
5. Open cable access latch to remove the cables and place them towards system front.

**Steps**

1. Lift the blue release levers to unlock the cooling fan cage assembly from the system.
2. Hold the release levers, and lift the cooling fan cage assembly away from the system.





**Figure 33. Removing the cooling fan cage assembly**

### Next steps

1. [Install the cooling fan cage assembly.](#)

## Installing the cooling fan cage assembly

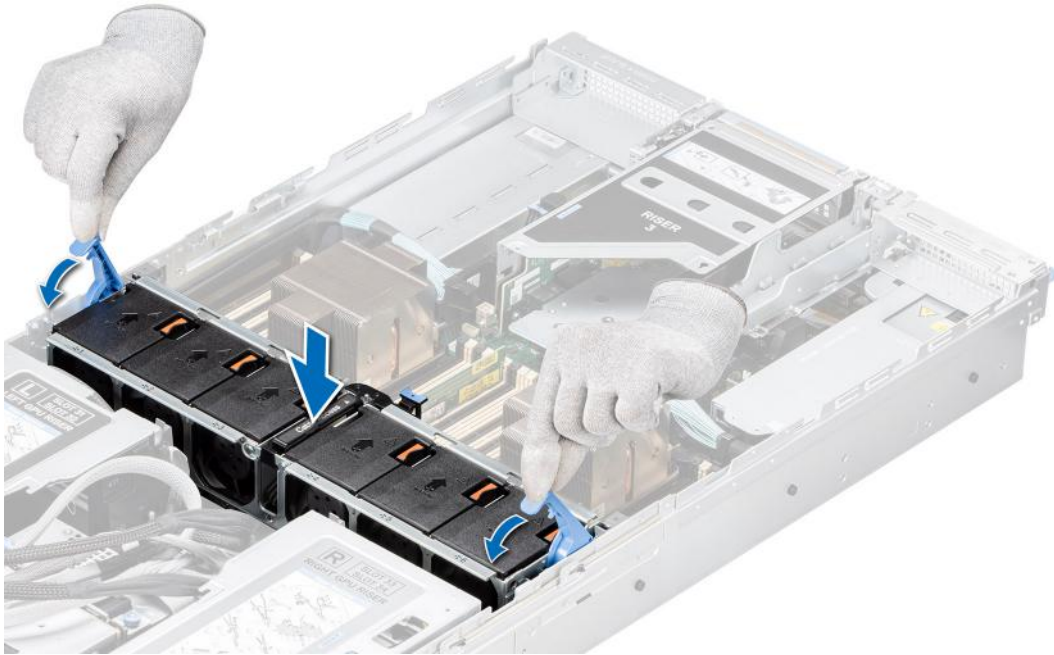
### Prerequisites

1. Follow the safety guidelines listed in the [Safety instructions](#).  
**CAUTION:** Ensure that the cables inside the system are correctly installed and retained by the cable retention bracket before installing the cooling fan cage assembly. Incorrectly installed cables may get damaged.
2. Follow the procedure listed in [Before working inside your system](#).
3. If installed, [remove the air shroud](#).
4. Disconnect the cables from system board that pass through the cooling fan cage assembly.
5. Open cable access latch to remove the cables and place them towards system front.
6. If opened close the cable side wall brackets on the system.

### Steps

1. Align the guide rails on the cooling fan cage assembly with the guides on the system.
2. Lower the cooling fan cage assembly into the system until seated firmly.
3. Lower the blue release lever and press to lock the cooling fan cage assembly into the system.





**Figure 34. Installing the cooling fan cage assembly**

#### **Next steps**

1. If removed, [install the air shroud](#).
2. Insert the cables into cables access latch and close cable access latch.
3. Connect the cables to system board that pass through the cooling fan cage assembly cable latch.
4. Follow the procedure listed in [After working inside your system](#).

## **Removing a cooling fan**

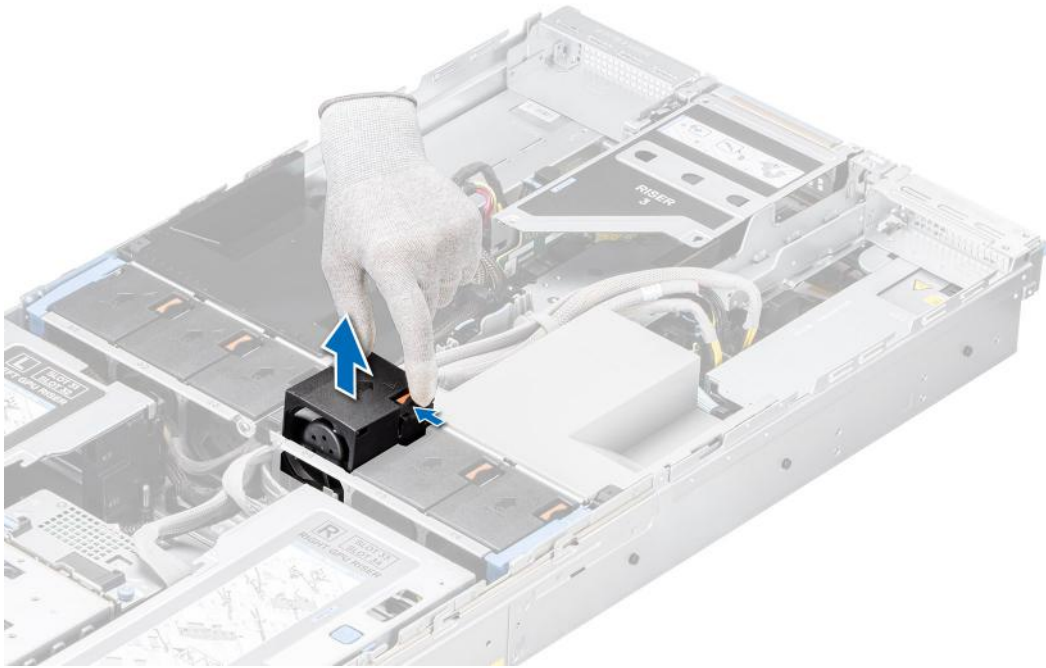
#### **Prerequisites**

1. Follow the safety guidelines listed in the [Safety instructions](#).
2. Follow the procedure listed in [Before working inside your system](#).

#### **Steps**

Press the orange release tab and lift the cooling fan to disconnect the fan from the connector on the system board.

**⚠️ WARNING: Ensure not to tilt or rotate the cooling fan while removing from the system.**



**Figure 35. Removing a cooling fan**

**Next steps**

1. [Replace a cooling fan.](#)

## Installing a cooling fan

**Prerequisites**

1. Follow the safety guidelines listed in the [Safety instructions](#).
2. Follow the procedure listed in [Before working inside your system](#).

**Steps**

Align and slide the cooling fan into the cooling fan cage assembly until the fan clicks into place.

**(i) NOTE:** The air flow arrow on the cooling fan must face towards rear side of the system.

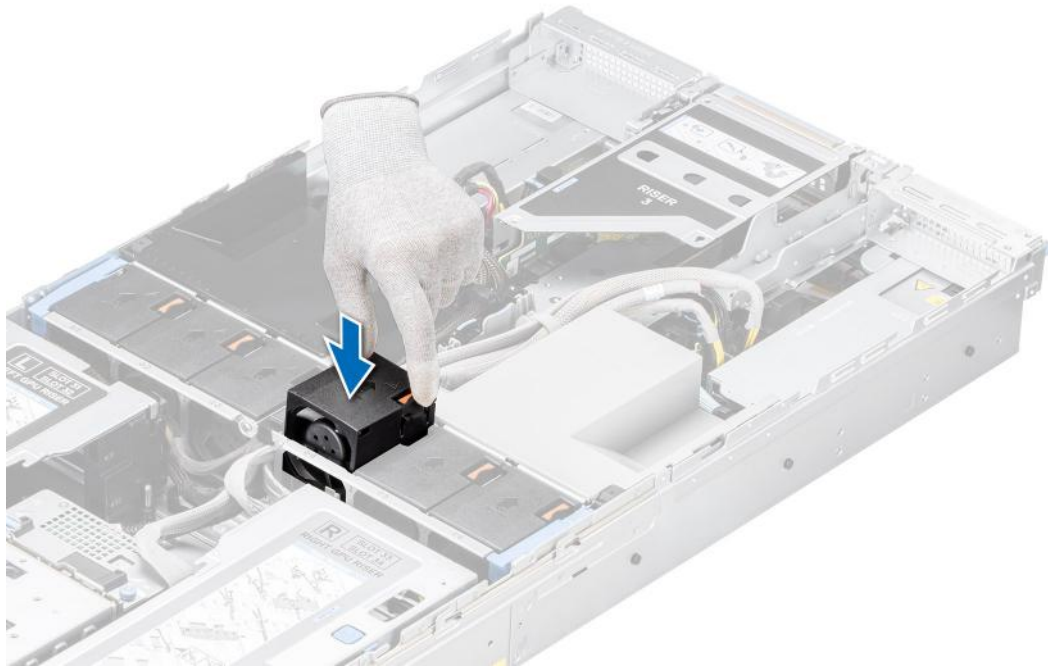


Figure 36. Installing a cooling fan

#### Next steps

1. Follow the procedure listed in [After working inside your system](#).

## Side wall brackets

### Removing the side wall bracket

There are two side wall brackets on either side of the system. The procedure to remove them is same.

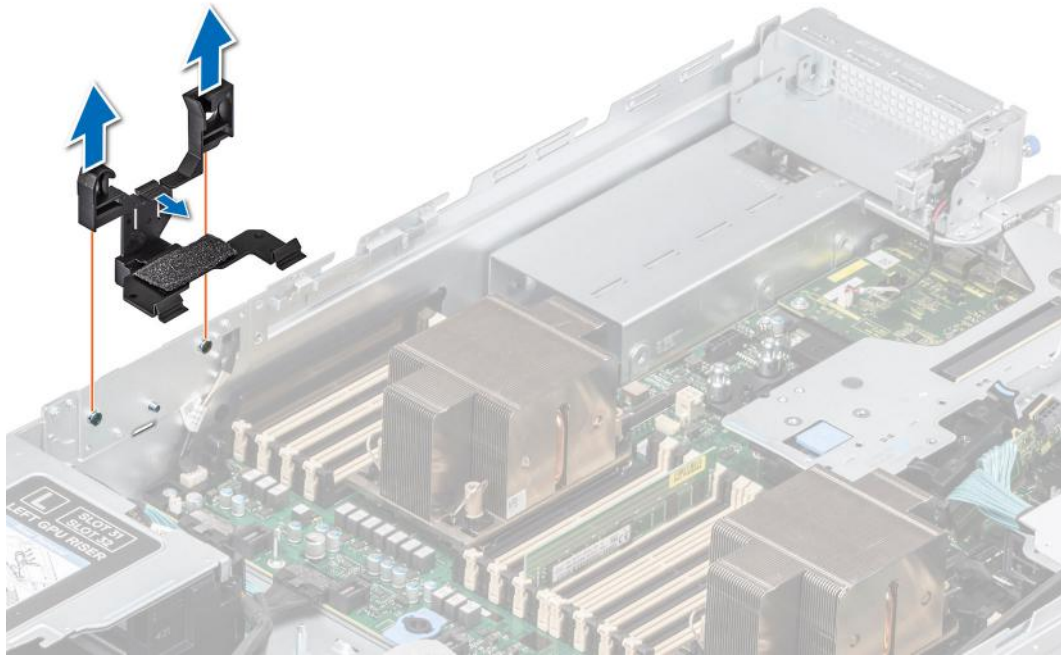
#### Prerequisites

1. Follow the safety guidelines listed in the [Safety instructions](#).
2. Follow the procedure listed in the [Before working inside your system](#).
3. If required, [remove the drive backplane cover](#).
4. If installed, [remove the air shroud](#).
5. [Remove the cooling fan cage assembly](#).

**i** **NOTE:** Ensure that you note the routing of the cables as you remove them from the system board. Route the cable properly when you replace it to prevent the cable from being pinched or crimped.

#### Steps

1. Press the blue side tabs to release the side wall cable holder.  
**i** **NOTE:** Move the cables out of the side wall cable holder.
2. Press the center tab to release the bracket from the system, and lift it away from the system.



**Figure 37. Removing the side wall bracket**

#### Next steps

1. [Replace the side wall bracket.](#)

## Installing the side wall bracket

There are two side wall brackets on either side of the system. The procedure to install them is same.

#### Prerequisites

1. Follow the safety guidelines listed in the [Safety instructions](#).
2. Follow the procedure listed in the [Before working inside your system](#).
3. If required, [remove the drive backplane cover](#).
4. If installed, [remove the air shroud](#).
5. [Remove the cooling fan cage assembly](#).

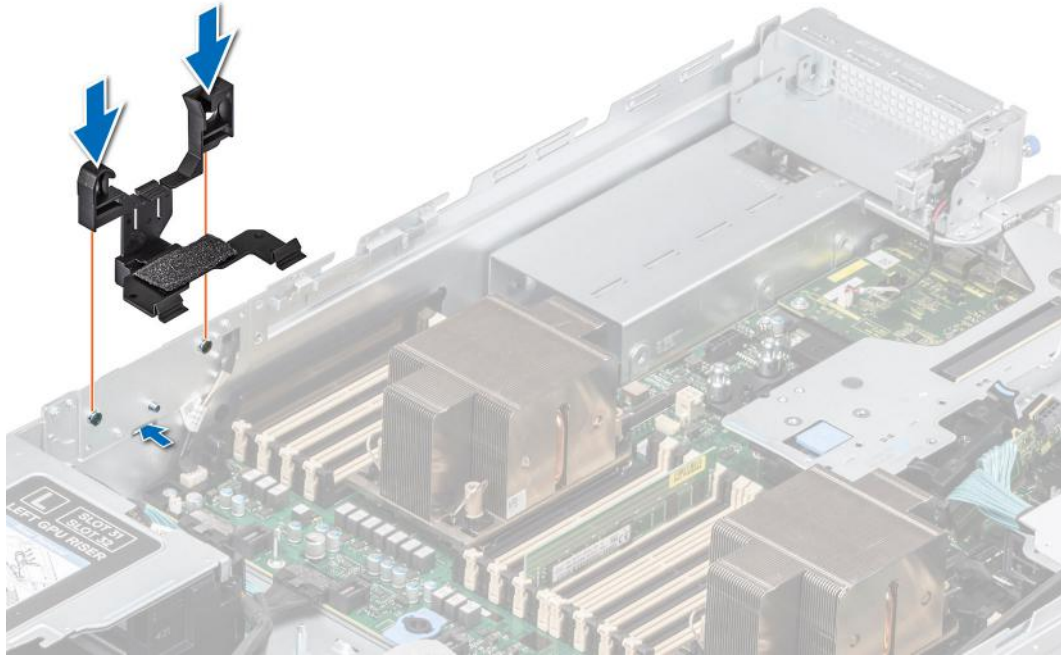
**i** **NOTE:** Ensure that you note the routing of the cables as you remove them from the system board. Route the cable properly when you replace it to prevent the cable from being pinched or crimped.

#### Steps

1. Align the guide slots on the side wall bracket with the guides on the system and slide until the cover is seated firmly.

**i** **NOTE:** Route the cables through the side wall cable holder.

2. Close the side wall cable holder until the holder clicks into place.



**Figure 38. Installing the side wall bracket**

#### Next steps

1. Install the cooling fan cage assembly.
2. If removed, install the air shroud.
3. If required, install the drive backplane cover.
4. Follow the procedure listed in the [After working inside your system](#).

## Drives

### Removing a drive blank

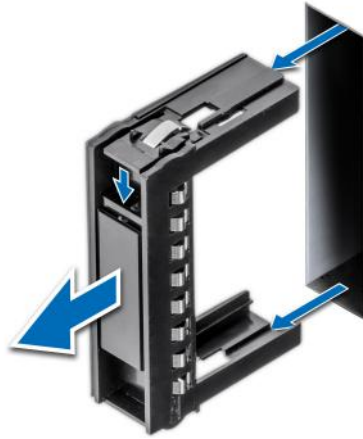
#### Prerequisites

1. Follow the safety guidelines listed in the [Safety instructions](#).
2. If installed, [remove the front bezel](#).

**CAUTION:** To maintain proper system cooling, drive blanks must be installed in all empty drive slots.

#### Steps

Press the release button, and slide the drive blank out of the drive slot.



**Figure 39. Removing a drive blank**

#### **Next steps**

1. [Replace the drive blank.](#)

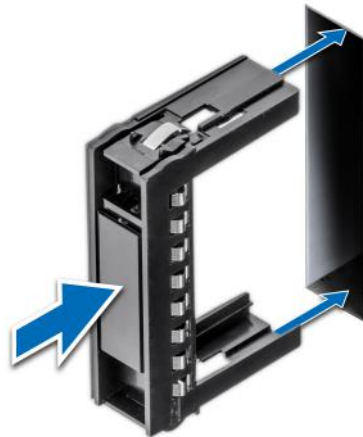
## **Installing a drive blank**

#### **Prerequisites**

1. Follow the safety guidelines listed in the [Safety instructions](#).
2. If installed, [remove the front bezel](#).

#### **Steps**

Slide the drive blank into the drive slot until the release button clicks into place.



**Figure 40. Installing a drive blank**

#### **Next steps**

1. If removed, [install the front bezel](#).



## Removing the drive carrier

### Prerequisites

1. Follow the safety guidelines listed in the [Safety instructions](#).
2. If installed, [remove the front bezel](#).
3. Using the management software, prepare the drive for removal. If the drive is online, the green activity or fault indicator blinks while the drive is powering off. When the drive indicators are off, the drive is ready for removal. For more information, see the documentation for the storage controller.

**CAUTION:** Before attempting to remove or install a drive while the system is running, see the documentation for the storage controller card to ensure that the host adapter is configured correctly to support drive removal and insertion.

**CAUTION:** To prevent data loss, ensure that your operating system supports drive installation. For more information about the drives installation or uninstallation requirements, see the operating system's user guide.

### Steps

1. Press the release button to open the drive carrier release handle.
2. Holding the drive carrier release handle, slide the drive carrier out of the drive slot.

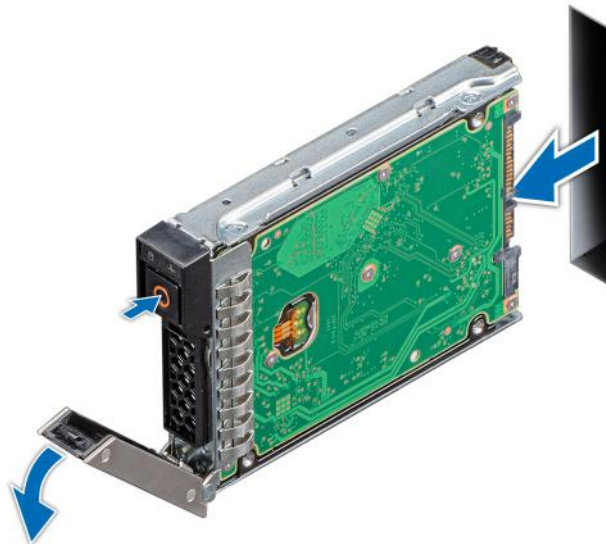


Figure 41. Removing a drive carrier

### Next steps

1. Install a drive carrier or drive blank.

## Removing the drive from the drive carrier

### Prerequisites

1. Follow the safety guidelines listed in the [Safety instructions](#).
2. [Remove the drive carrier](#).

### Steps

1. Using a Phillips #1 screwdriver, remove the screws from the slide rails on the drive carrier.

**NOTE:** If the drive carrier has Torx screw, use Torx 6 (for 2.5-inch drive) or Torx 8 (for 3.5-inch drive) screwdriver to remove the drive.



2. Lift the drive out of the drive carrier.



**Figure 42. Removing the drive from the drive carrier**

### Next steps

Install the drive into the drive carrier.

## Installing the drive into the drive carrier

### Prerequisites

1. Follow the safety guidelines listed in the [Safety instructions](#).
2. [Remove the drive carrier](#).

### Steps

1. Insert the drive into the drive carrier with the drive connector facing towards the rear of the carrier.
2. Align the screw holes on the drive with the screws holes on the drive carrier.
3. Using a Phillips #1 screwdriver, secure the drive to the drive carrier with the screws.

**NOTE:** When installing a drive into the drive carrier, ensure that the screws are torqued to 4 lbf-in.

**NOTE:** If the drive carrier has Torx screw, use Torx 6 (for 2.5-inch drive) or Torx 8 (for 3.5-inch drive) screwdriver to install the drive.







Figure 43. Installing a drive into the drive carrier

### Next steps

1. [Install the drive carrier.](#)

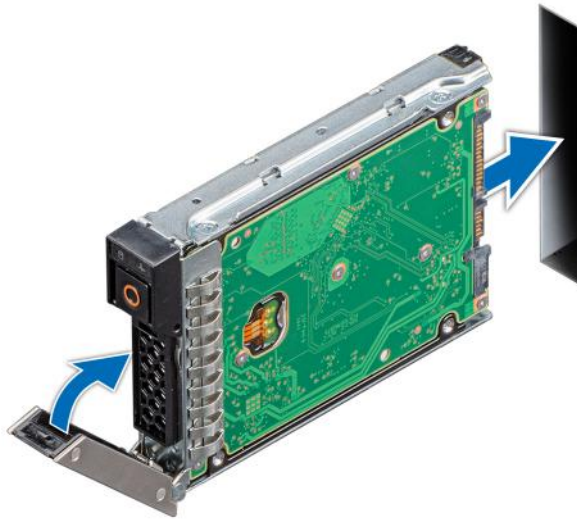
## Installing the drive carrier

### Prerequisites

- ⚠ **CAUTION:** Before removing or installing a drive while the system is running, see the documentation for the storage controller card to ensure that the host adapter is configured correctly to support drive removal and insertion.
  - ⚠ **CAUTION:** Combining SAS and SATA drives in the same RAID volume is not supported.
  - ⚠ **CAUTION:** When installing a drive, ensure that the adjacent drives are fully installed. Inserting a drive carrier and attempting to lock its handle next to a partially installed carrier can damage the partially installed carrier's shield spring and make it unusable.
  - ⚠ **CAUTION:** To prevent data loss, ensure that your operating system supports hot-swap drive installation. See the documentation supplied with your operating system.
  - ℹ **NOTE:** When a replacement hot swappable drive is installed while the system is powered on, the drive automatically begins to rebuild. Ensure that the replacement drive is blank. Any data on the replacement drive is immediately lost once the drive is installed.
  - ℹ **NOTE:** Ensure that the drive carrier's release handle is in the open position before inserting the carrier into the slot.
1. Follow the safety guidelines listed in the [Safety instructions](#).
  2. If installed, [remove the front bezel](#).
  3. Remove the drive carrier or remove the drive blank when you want to assemble the drives in to the system.

### Steps

1. Slide the drive carrier into the drive slot.
2. Close the drive carrier release handle to lock the drive in place.



**Figure 44. Installing a drive carrier**

### Next steps

If removed, [install the front bezel](#).

## Removing a NVMe drive blank

### Prerequisites

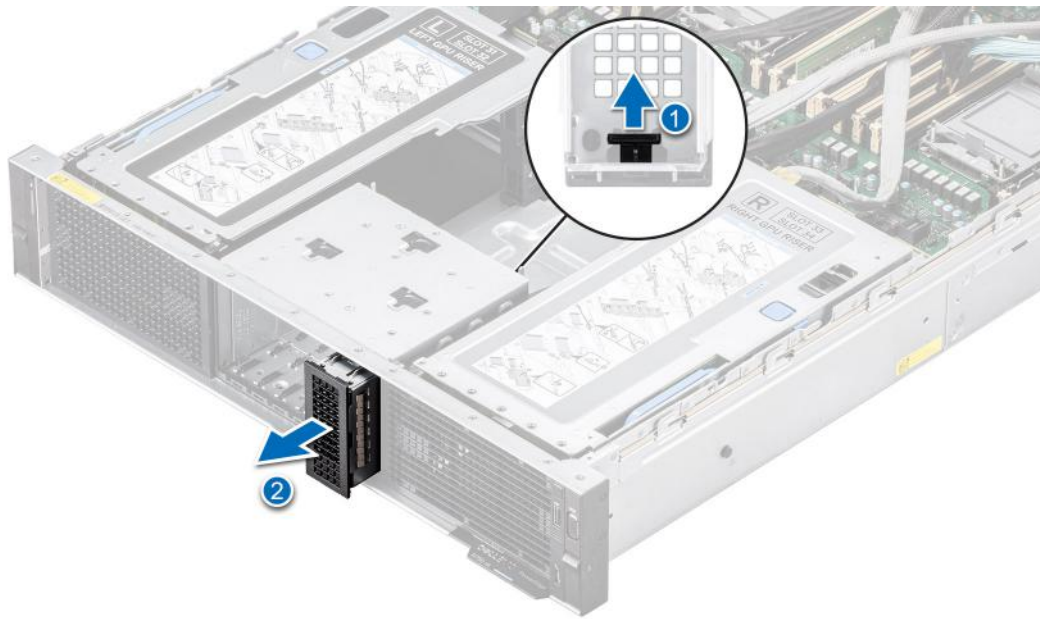
1. Follow the safety guidelines listed in the [Safety instructions](#).
  2. If installed, [remove the front bezel](#).
  3. [Remove all drives](#).
- NOTE:** All drives need to be installed to their original position.
4. [Remove the drive backplane cover](#).
  5. [Remove the drive backplane](#).

**CAUTION:** For proper system cooling, drive blanks must be installed in all empty drive slots.

**NOTE:** NVMe drive blank is applicable for the system with x6 NVMe drive configuration.

### Steps

Lift the release latch and push the NVMe drive blank out of the drive slot.



**Figure 45. Removing a NVMe drive blank**

#### Next steps

1. [Replace the NVMe drive blank.](#)

## Installing a NVMe drive blank

#### Prerequisites

1. Follow the safety guidelines listed in the [Safety instructions](#).
2. If installed, [remove the front bezel](#).
3. [Remove all drives](#).

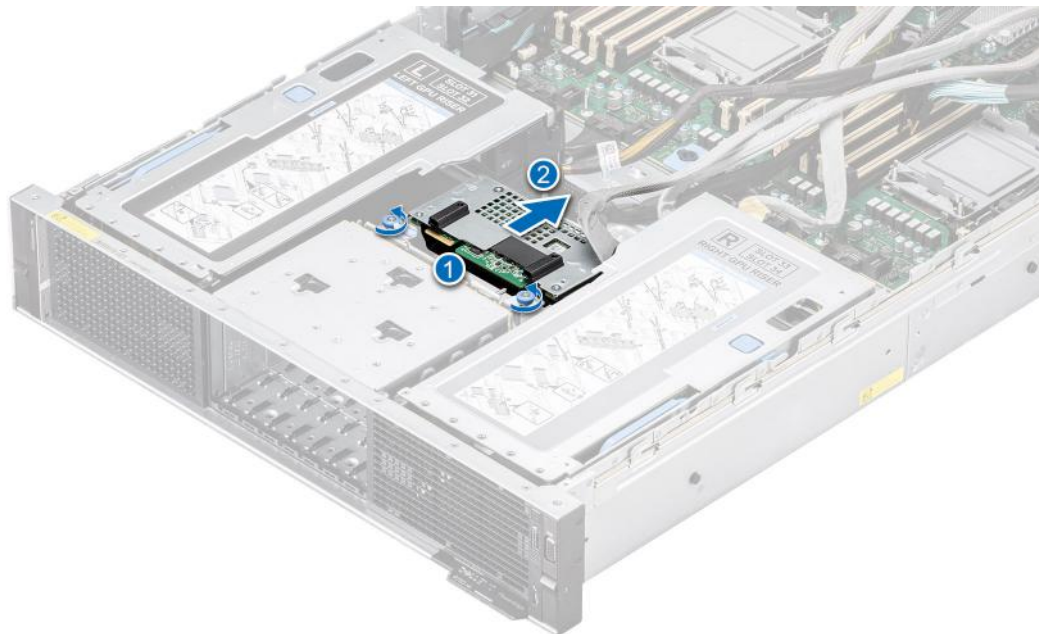
**CAUTION:** For proper system cooling, drive blanks must be installed in all empty drive slots.

**NOTE:** NVMe drive blank is applicable for the system with x6 NVMe drive configuration.

#### Steps

Slide the NVMe drive blank into the drive slot, until clicks into place.





**Figure 47. Removing the rear mounting front PERC module**

#### Next steps

1. [Replace the rear mounting front PERC module.](#)

## Installing the rear mounting front PERC module

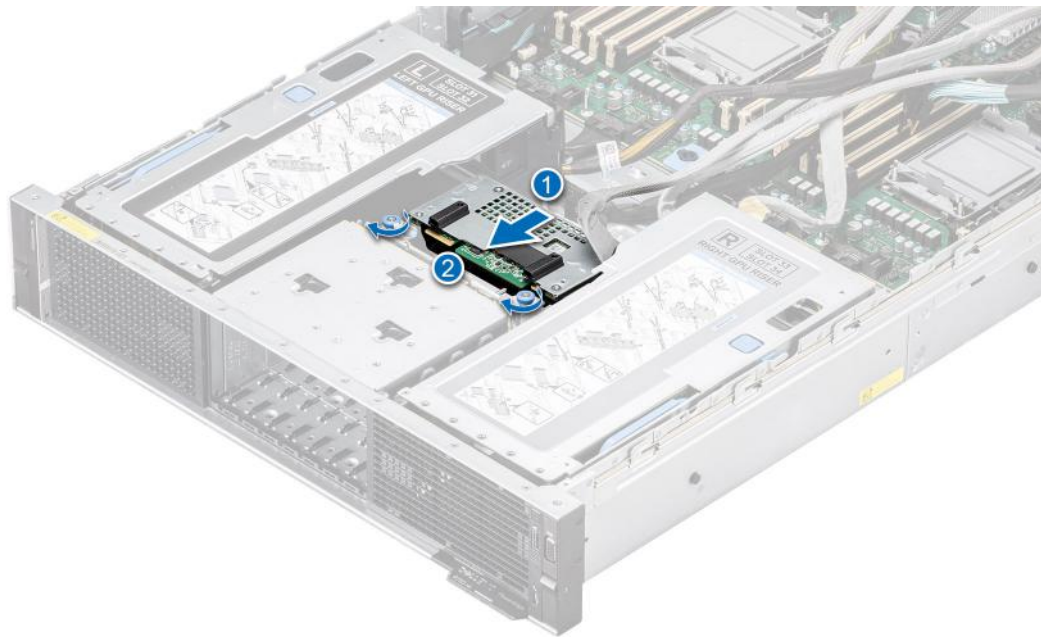
#### Prerequisites

1. Follow the safety guidelines listed in the [Safety instructions](#).
2. Follow the procedure listed in [Before working inside your system](#).
3. [Remove the drive backplane cover](#).
4. Disconnect all the cables from rear mounting front PERC module, observe the cable routing.

#### Steps

1. Align the connectors and guide slots on the rear mounting front PERC module with the connectors and guide pins on the drive backplane.
2. Slide in the rear mounting front PERC module, until the module is connected to the drive backplane.
3. Using a Phillips #2 screwdriver, tighten the captive screws on the rear mounting front PERC module.

**NOTE:** The numbers on the image do not depict the exact steps. The numbers are for representation of sequence.



**Figure 48. Installing the rear mounting front PERC module**

**Next steps**

1. Connect all the cables to rear mounting front PERC module.
  - NOTE:** Route the cable properly to prevent the cable from being pinched or crimped.
2. Install the drive backplane cover.
3. Follow the procedure listed in [After working inside your system](#).

## Drive backplane

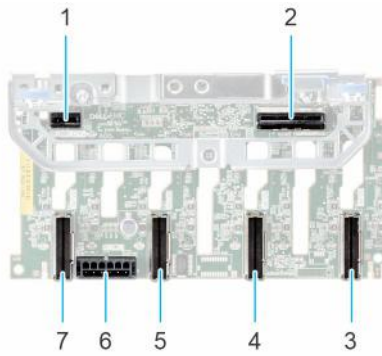
This is a service technician replaceable part only.

## Drive backplane

Depending on your system configuration, the drive backplane supported is listed here:

**Table 14. Supported backplane options**

System	Supported drives options
PowerEdge R750xa	2.5-inch (x 8) Universal backplane



**Figure 49. 8 x 2.5-inch universal drive backplane**

- |                                     |  |
|-------------------------------------|--|
| 1. BP_PWR_CTRL                      | 2. BP_DST_SA1 (PERC to backplane)                              |
| 3. BP_DST_PA1 (PCIe/NVMe connector) | 4. BP_DST_PB1 (PCIe/NVMe connector)                            |
| 5. BP_DST_PA2 (PCIe/NVMe connector) | 6. BP_PWR_1 (backplane power and signal cable to system board) |
| 7. BP_DST_PB2 (PCIe/NVMe connector) |  |

## Removing the drive backplane

### Prerequisites

**CAUTION:** To prevent damage to the drives and backplane, remove the drives from the system before removing the backplane.

**CAUTION:** Note the number of each drive and temporarily label them before you remove the drive so that you can reinstall them in the same location.

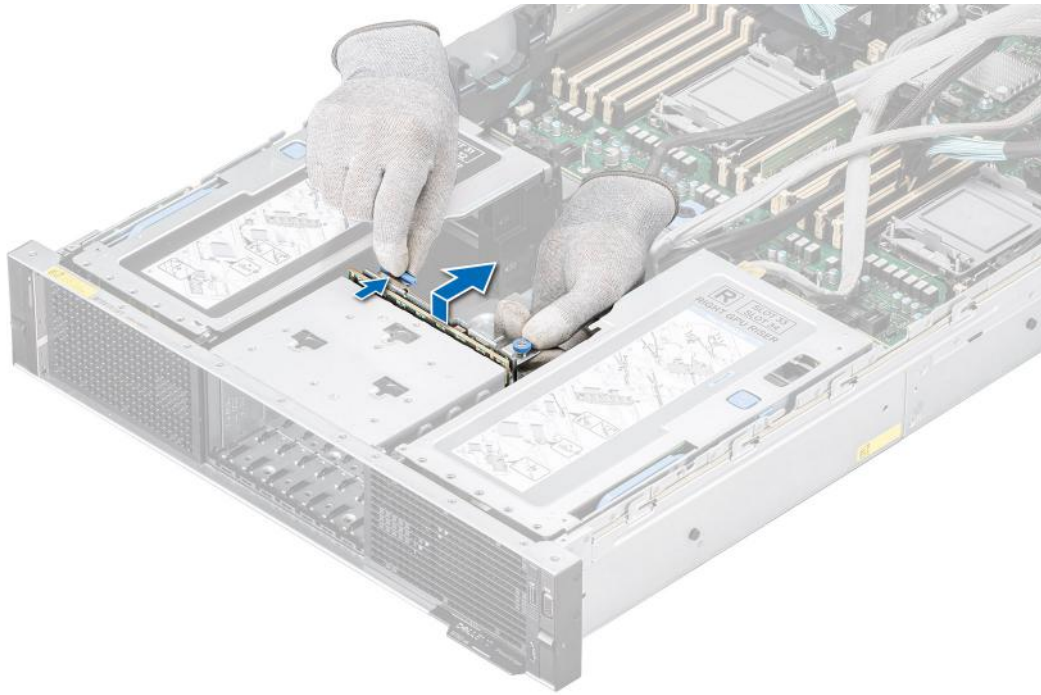
**NOTE:** The procedure to remove the backplane is similar for all backplane configurations.

1. Follow the safety guidelines listed in the [Safety instructions](#).
2. Follow the procedure listed in the [Before working inside your system](#).
3. [Remove the backplane cover](#).
4. [Remove all drives](#).
5. If required, [remove NVMe connector blank](#).
6. If installed, [remove rear mounting front PERC module](#).
7. Disconnect the drive backplane cables from the connector on the system board and backplane.

### Steps

1. Press the blue release tabs to disengage the drive backplane from the hooks on the system.
2. Lift and pull the drive backplane out of the system.





**Figure 50. Removing the drive backplane**

#### Next steps

1. [Replace the drive backplane.](#)

## Installing the drive backplane

#### Prerequisites

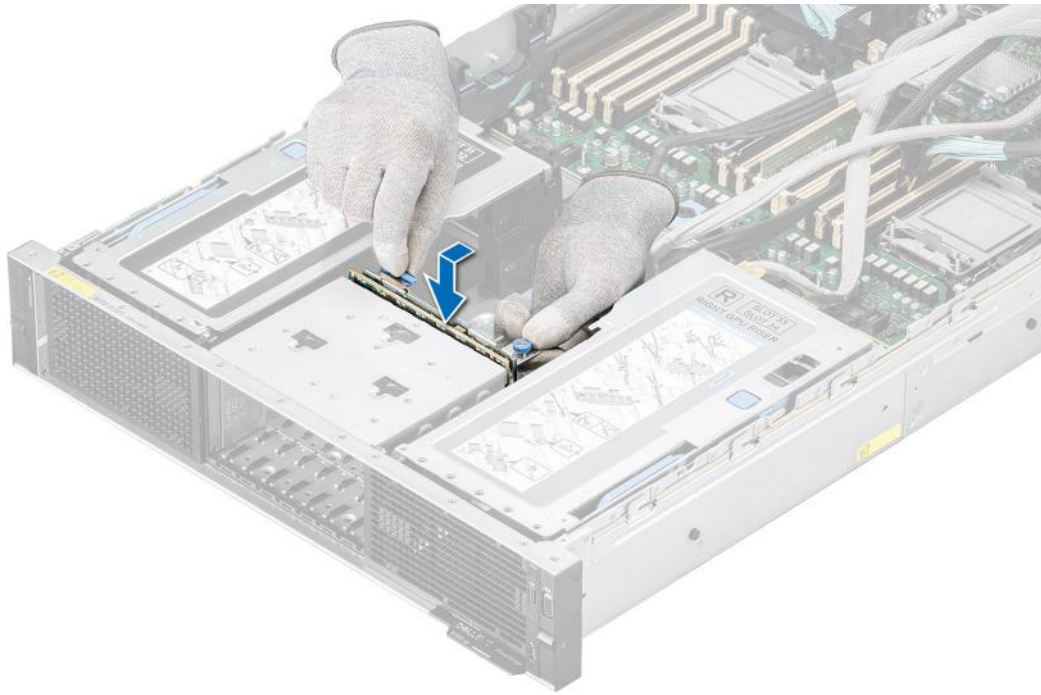
1. Follow the safety guidelines listed in the [Safety instructions](#).
2. Follow the procedure listed in the [Before working inside your system](#).
3. [Remove the backplane cover.](#)
4. [Remove all drives.](#)
5. If required, [remove NVMe connector blank.](#)
6. If installed, [remove rear mounting front PERC module.](#)
7. Disconnect the drive backplane cables from the connector on the system board and backplane.

**NOTE:** Route the cable properly when you replace it to prevent the cable from being pinched or crimped.

#### Steps

1. Align the slots on the drive backplane with the guides on the system.
2. Slide and lower the drive backplane into the guides and ensure that the bottom of the drive backplane is engaged with the system metal hooks.
3. Route the cables properly through the cable guide.





**Figure 51. Installing the drive backplane**

#### Next steps

1. Connect the drive backplane cables to the connector on the system board and backplane.
2. If removed, [install NVMe connector blank](#).
3. If removed, [install rear mounting front PERC module](#) and route the cables back to PERC module.
4. [Install all drives](#).
5. [Install the drive backplane cover](#).
6. Follow the procedure listed in [After working inside your system](#).

## Removing a NVMe connector blank

#### Prerequisites

1. Follow the safety guidelines listed in the [Safety instructions](#).
2. If installed, [remove the front bezel](#).
3. [Remove all drives](#).
4. [Remove the drive backplane cover](#).
5. [Remove the drive backplane](#)

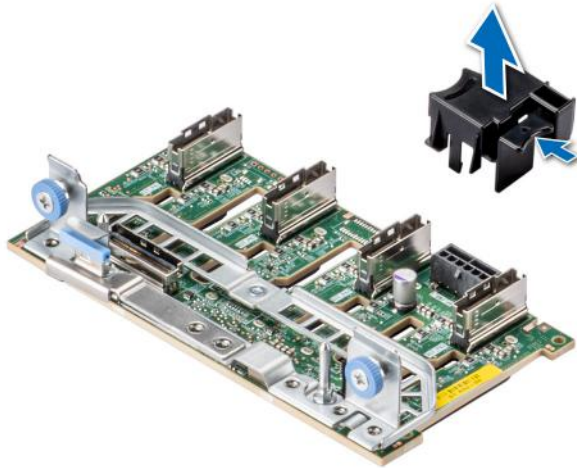
**CAUTION:** NVMe connector blank is applicable for the system with x6 NVMe drive configuration.

**NOTE:** NVMe connector blank must be removed from the drive backplane in order to change x6 NVMe drive configuration to other storage configuration.

#### Steps

Press the release tab, and remove the NVMe connector blank from the drive backplane.

**Figure 52. Removing a NVMe connector blank**



### Next steps

1. [Replace the NVMe connector blank.](#)

## Installing a NVMe connector blank

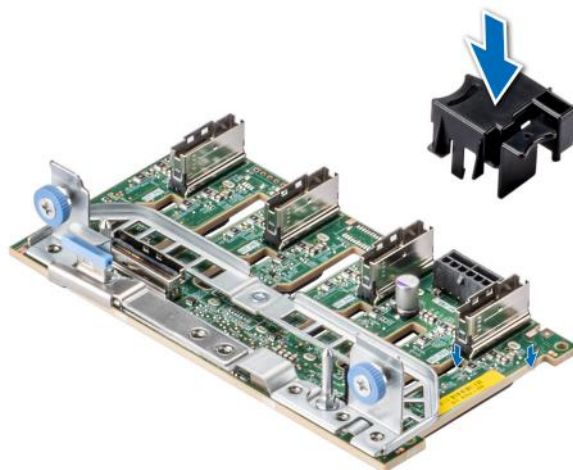
### Prerequisites

1. Follow the safety guidelines listed in the [Safety instructions](#).
2. [Remove all drives.](#)
3. [Remove the drive backplane cover.](#)
4. If required, [remove the drive backplane](#)

**CAUTION:** NVMe connector blank is applicable for the system with x6 NVMe drive configuration.

### Steps

1. Align the NVMe connector blank with the guiding hole on the drive backplane.
2. Press the NVMe connector blank until clicks into place.



**Figure 53. Installing a NVMe connector blank**

### Next steps

1. If removed, [install the front bezel.](#)
2. [Install drive backplane.](#)
3. [Install all drives.](#)

4. Install the drive backplane cover.

## Cable routing

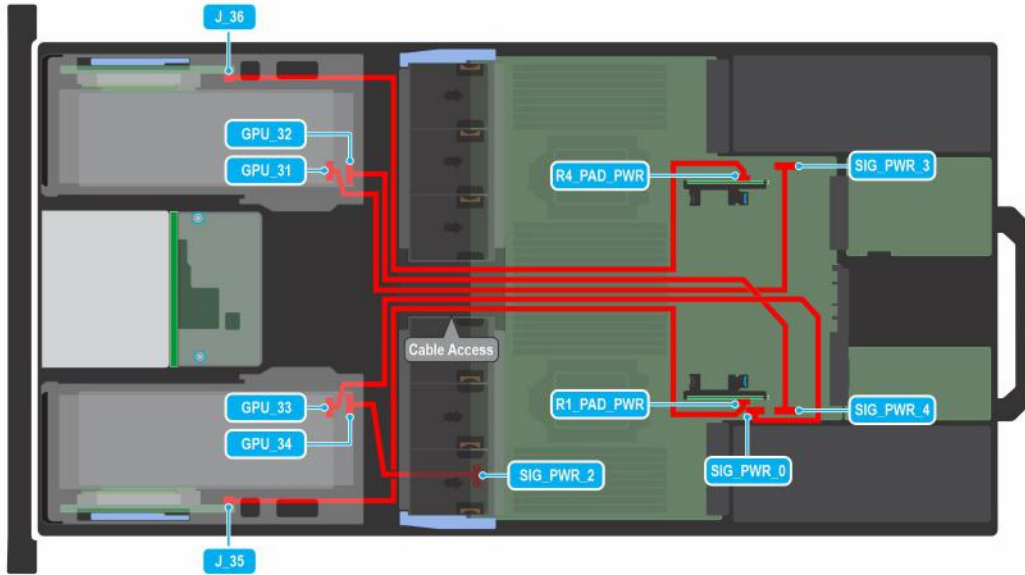


Figure 54. Front GPU power cables

Table 15. Front GPU power cables

From	To
R4_PAD_PWR ( R4 paddle card power connector)	J_36 (GPU riser module power connector)
SIG_PWR_4 (system board power connector)	GPU_32 (GPU card power connector)
SIG_PWR_3 (system board power connector)	GPU_31 (GPU card power connector)
SIG_PWR_0 (system board power connector)	GPU_33 (GPU card power connector)
SIG_PWR_2 (system board power connector)	GPU_34 (GPU card power connector)
R1_PAD_PWR ( R1 paddle card power connector)	J_35 (GPU riser module power connector)

**NOTE:** Front GPU power cables is common for all the PowerEdge R750xa system configurations.

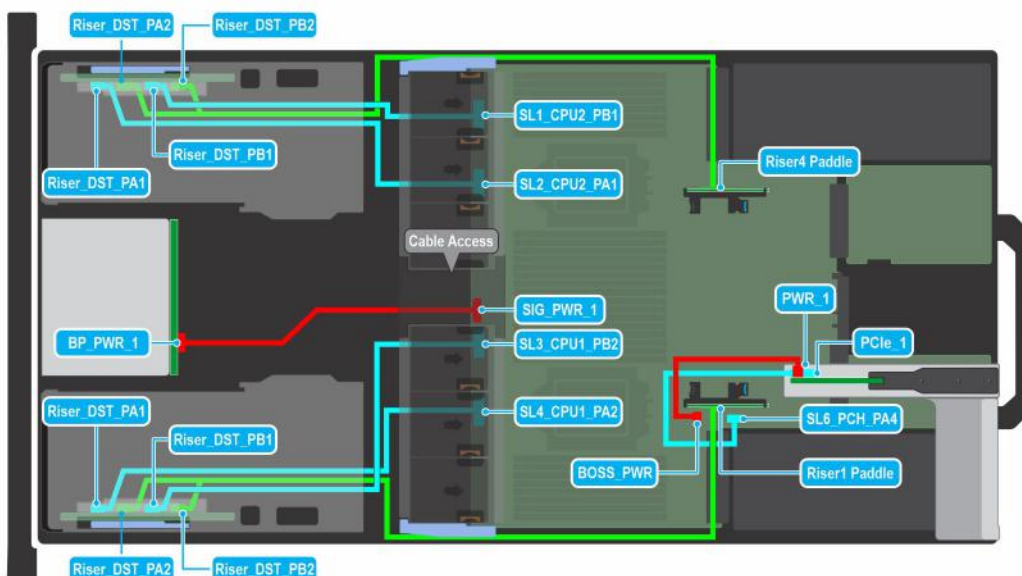


Figure 55. Front GPU riser module cables with BOSS S2 module

Table 16. Front GPU riser module cables with BOSS S2 module

From	To
BOSS_PWR (BOSS S2 module power connector on system board)	PWR_1 (BOSS S2 module power connector)
SL6_PCH_PA4 (signal connector on system board)	PCIe_1 (BOSS S2 module signal connector)
SIG_PWR_1 (system board power connector)	BP_PWR_1 (backplane power connector)
Riser 4 paddle (R4 paddle card on Riser 4 slot)	Riser_DST_PA2 (GPU riser module signal connector) and Riser_DST_PB2 (GPU riser module signal connector)
SL1_CPU2_PB1 (signal connector on system board)	Riser_DST_PB1 (GPU riser module signal connector)
SL2_CPU2_PA1 (signal connector on system board)	Riser_DST_PA1 (GPU riser module signal connector)
Riser 1 paddle (R1 paddle card on Riser 1 slot)	Riser_DST_PA2 (GPU riser module signal connector) and Riser_DST_PB2 (GPU riser module signal connector)
SL3_CPU1_PB2 (signal connector on system board)	Riser_DST_PB1 (GPU riser module signal connector)
SL4_CPU1_PA2 (signal connector on system board)	Riser_DST_PA1 (GPU riser module signal connector)

**NOTE:** Front GPU riser module cables with BOSS S2 module is common for all the PowerEdge R750xa system configurations.

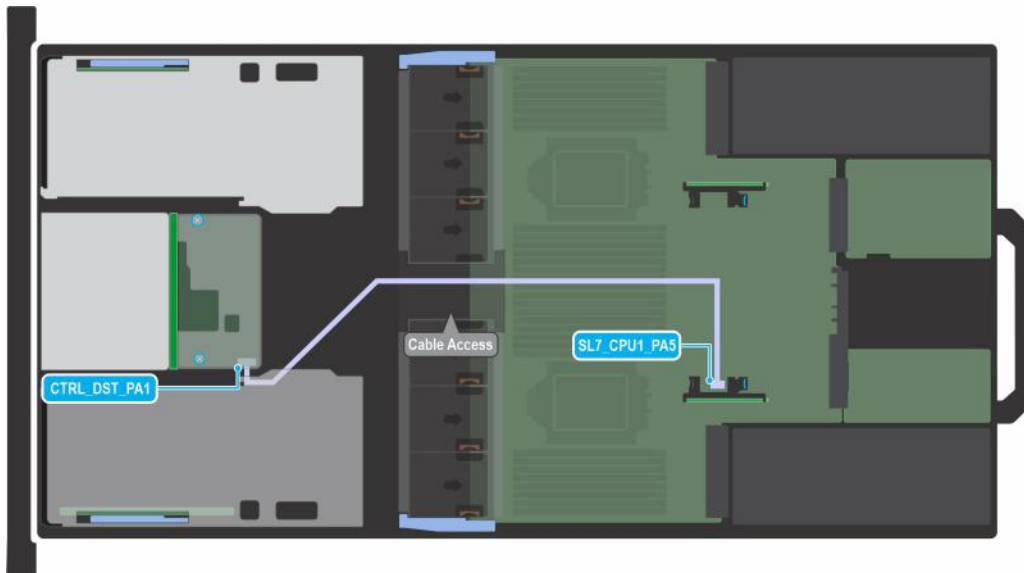


Figure 56. 8 x 2.5-inch SAS/SATA with fPERC

Table 17. 8 x 2.5-inch SAS/SATA with fPERC

From	To
SL7_CPU1_PA5 (signal connector on system board)	CTRL_DST_PA1 (fPERC input connector)

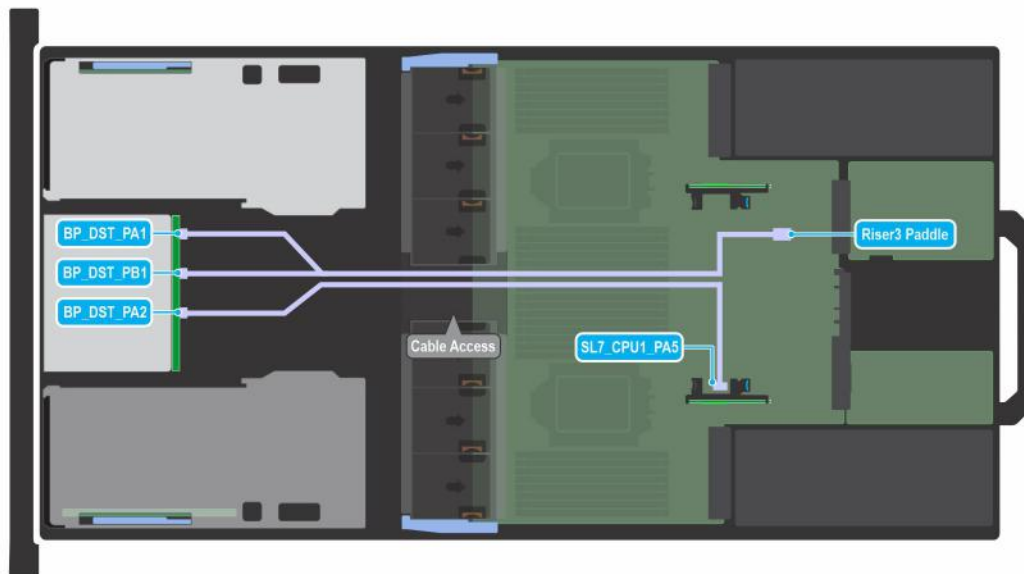


Figure 57. 6 x 2.5-inch NVMe direct

Table 18. 6 x 2.5-inch NVMe direct

From	To
Riser 3 paddle (R3 paddle card on Riser 3 slot)	BP_DST_PA1 (backplane signal connector) and BP_DST_PB1 (backplane signal connector)
SL7_CPU1_PA5 (signal connector on system board)	BP_DST_PA2 (backplane signal connector)

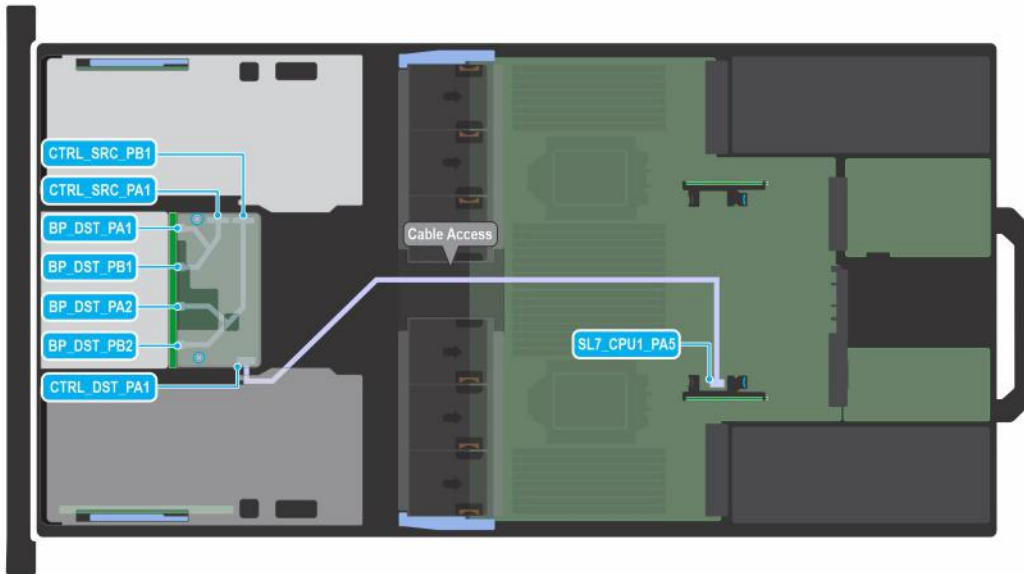


Figure 58. 8 x 2.5-inch NVMe RAID with fPERC

Table 19. 8 x 2.5-inch NVMe RAID with fPERC

From	To
SL7_CPU1_PA5 (signal connector on system board)	CTRL_DST_PA1 (fPERC input connector)
CTRL_SRC_PA1 (fPERC controller connector)	BP_DST_PA1 (backplane signal connector) and BP_DST_PB1 (backplane signal connector)
CTRL_SRC_PB1 (fPERC controller connector)	BP_DST_PA2 (backplane signal connector) and BP_DST_PB2 (backplane signal connector)

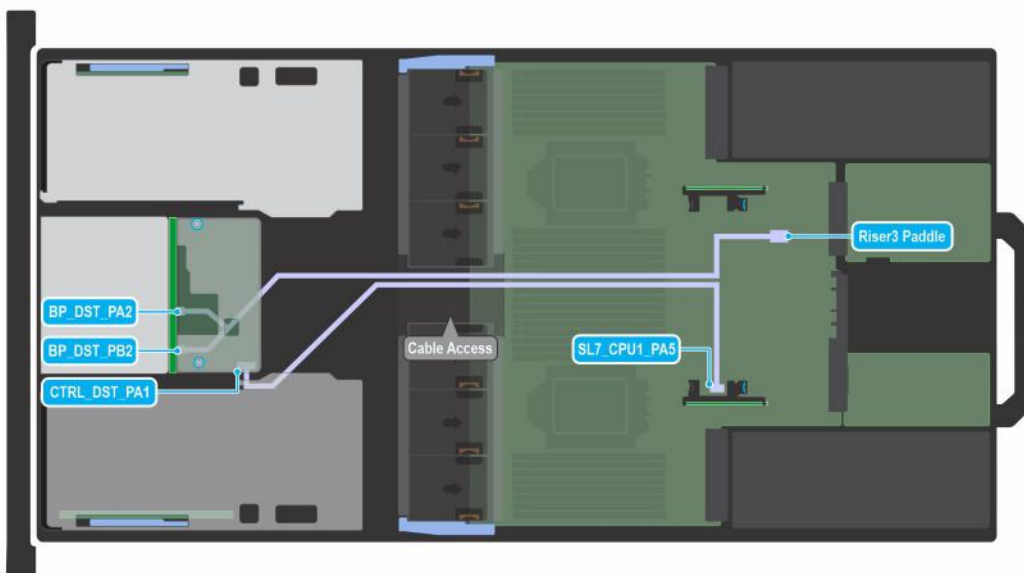


Figure 59. 8 x 2.5-inch SAS/SATA with 4 universal slots and fPERC



**Table 20. 8 x 2.5-inch SAS/SATA with 4 universal slots and fPERC**

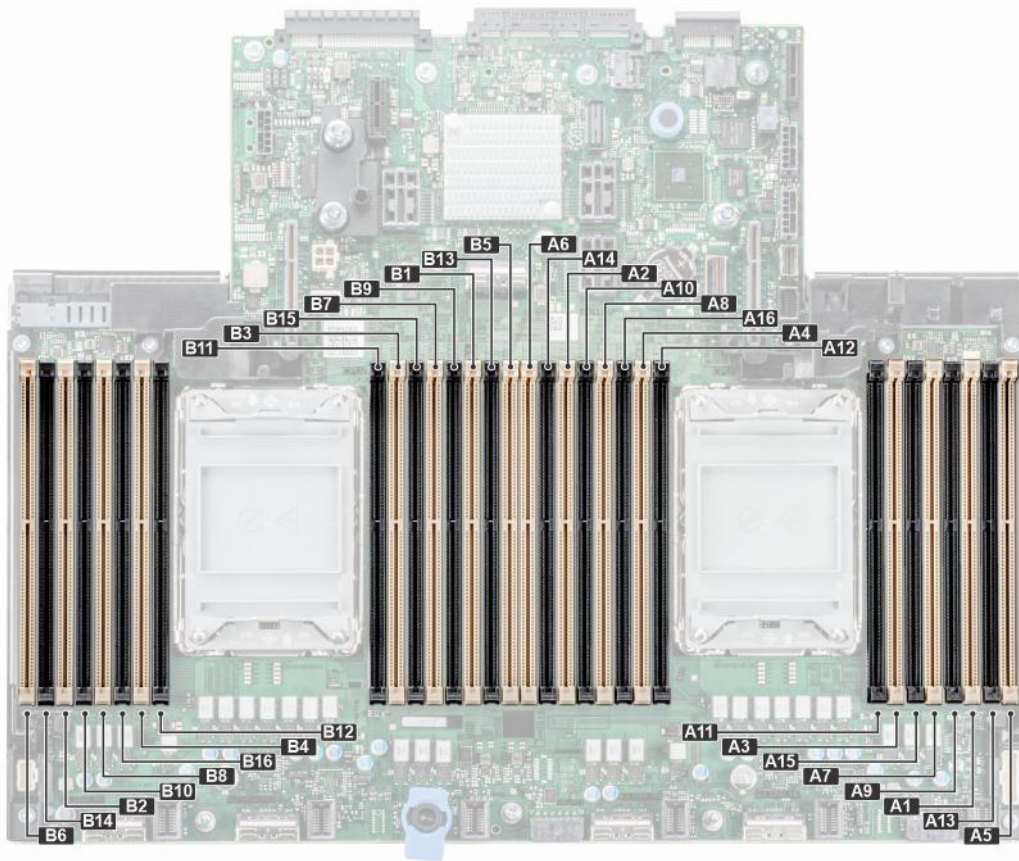
From	To
Riser 3 paddle (R3 paddle card on Riser 3 slot)	BP_DST_PA2 (backplane signal connector) and BP_DST_PB2 (backplane signal connector)
SL7_CPU1_PA5 (signal connector on system board)	CTRL_DST_PA1 (fPERC input connector)

## System memory

### System memory guidelines

The PowerEdge R750xa system supports DDR4 registered DIMMs (RDIMMs), Load Reduced DIMM (LRDIMMs), and Intel Persistent Memory 200 series (BPS). System memory holds the instructions that are started by the processor.

Your system memory is organized into eight channels per processor (two memory sockets per channel), 16 memory sockets per processor and 32 memory sockets per system.



**Figure 60. Memory channels**

Memory channels are organized as follows:

**Table 21. Memory channels**

Processor	Channel A	Channel B	Channel C	Channel D	Channel E	Channel F	Channel G	Channel H
Processor 1	Slots A1 and A9	Slots A5 and A13	Slots A3 and A11	Slots A7 and A15	Slots A2 and A10	Slots A6 and A14	Slots A4 and A12	Slots A8 and A16

**Table 21. Memory channels (continued)**

Processor	Channel A	Channel B	Channel C	Channel D	Channel E	Channel F	Channel G	Channel H
Processor 2	Slots B1 and B9	Slots B5 and B13	Slots B3 and B11	Slots B7 and B15	Slots B2 and B10	Slots B6 and B14	Slots B4 and B12	Slots B8 and B16

**Table 22. Supported memory matrix**

DIMM type	Rank	Capacity	DIMM rated voltage and speed	Operating Speed	
				1 DIMM per channel (DPC)	2 DIMMs per channel (DPC)
RDIMM	1 R	8 GB	DDR4 (1.2 V), 3200 MT/s	3200 MT/s	3200 MT/s
	2 R	16 GB, 32 GB, 64 GB	DDR4 (1.2 V), 3200 MT/s	3200 MT/s	3200 MT/s
LRDIMM	4 R	128 GB	DDR4 (1.2 V), 3200 MT/s	3200 MT/s	3200 MT/s
Intel persistent memory (BPS)	2R	128 GB, 256 GB, 512 GB	DDR4 (1.2 V), 3200 MT/s	3200 MT/s	3200 MT/s

## General memory module installation guidelines

To ensure optimal performance of your system, observe the following general guidelines when configuring your system memory. If your system's memory configurations fail to observe these guidelines, your system might not boot, stop responding during memory configuration, or operate with reduced memory.

The memory bus may operate at speeds of 3200 MT/s, 2933 MT/s depending on the following factors:

- System profile selected (for example, Performance Optimized, or Custom [can be run at high speed or lower])
- Maximum supported DIMM speed of the processors
- Maximum supported speed of the DIMMs

**i** **NOTE:** MT/s indicates DIMM speed in MegaTransfers per second.

**i** **NOTE:** Fault Resilient Memory-Non Uniform Memory Access is supported.

The system supports Flexible Memory Configuration, enabling the system to be configured and run in any valid chipset architectural configuration. The following are the recommended guidelines for installing memory modules:

- All DIMMs must be DDR4.
- x4 and x8 DRAM based memory modules can be mixed.
- If memory modules with different speeds are installed, they operate at the speed of the slowest installed memory module(s).
- Populate memory module sockets only if a processor is installed.
  - For single-processor systems, sockets A1 to A16 are available.
  - For dual-processor systems, sockets A1 to A16 and sockets B1 to B16 are available.
- In **Optimizer Mode**, the DRAM controllers operate independently in the 64-bit mode and provide optimized memory performance.

**Table 23. Memory population rules**

Processor	Configuration	Memory population	Memory population information
Single processor	Optimizer (Independent channel) population order	A{1}, A{2}, A{3}, A{4}, A{5}, A{6}, A{7}, A{8}, A{9}, A{10}, A{11}, A{12}, A{13}, A{14}, A{15}, A{16}	1, 2, 4, 6, 8, 12 or 16 DIMMs are allowed.
Dual processor (Start with processor1. Processor 1	Optimizer (Independent channel) population order	A{1}, B{1}, A{2}, B{2}, A{3}, B{3}, A{4}, B{4}, A{5}, B{5}, A{6}, B{6}, A{7}, B{7}, A{8}, B{8}	2, 4, 8, 12, 16, 24 and 32 DIMMs are supported per system.



**Table 23. Memory population rules (continued)**

Processor	Configuration	Memory population	Memory population information
and processor 2 population should match)		B{8}, A{9}, B{9}, A{10}, B{10}, A{11}, B{11}, A{12}, B{12}, A{13}, B{13}, A{14}, B{14}, A{15}, B{15}, A{16}, B{16}	<b>NOTE:</b> Optimizer population order is not traditional for 8 and 16 DIMMs installations for dual processor.

- Populate all the sockets with white release tabs first, followed by the black release tabs.
- Only RDIMM Memory modules of different capacities can be mixed provided other memory population rules are followed.
  - NOTE:** For example, 8 GB and 16 GB memory modules can be mixed.
- Mixing of more than two memory module capacities in a system is not supported.
- Unbalanced or odd memory configuration results in a performance loss and system may not identify the memory modules being installed, so always populate memory channels identically with equal DIMMs for best performance.
- Supported RDIMM / LRDIMM configurations are 1, 2, 4, 6, 8, 12, or 16 DIMMs per processor.

## Intel Persistent Memory 200 series (BPS) installation guidelines

The following are the recommended guidelines for installing Intel Persistent Memory 200 series (BPS) memory modules:

- Each system supports maximum of one Intel Persistent Memory 200 series (BPS) memory module per channel.
  - NOTE:** If two different Intel Persistent Memory 200 series (BPS) capacities are mixed, an F1/F2 warning is displayed as the configuration is not supported.
- Intel Persistent Memory 200 series (BPS) can be mixed with RDIMM, LRDIMM, and 3DS LRDIMM.
- Mixing of DDR4 DIMM types (RDIMM, LRDIMM, and 3DS LRDIMM), within channels, for Integrated Memory Controller (iMC), or across sockets are not supported.
- Mixing of Intel Persistent Memory 200 series (BPS) operating modes (App Direct Mode, Memory Mode) is not supported.
- If only one DIMM is populated on a channel, then the DIMM should always be populated in the first slot in that channel (white slot).
- If a Intel Persistent Memory 200 series (BPS) and a DDR4 DIMM are populated on the same channel, always plug Intel Persistent Memory 200 series (BPS) on second slot (black slot).
- If the Intel Persistent Memory 200 series (BPS) is configured in Memory Mode, the recommended DDR4 to Intel Persistent Memory 200 series (BPS) capacity ratio is 1:4 to 1:16 per iMC.
- Intel Persistent Memory 200 series (BPS) cannot be mixed with other capacities of Intel Persistent Memory 200 series (BPS) or with NVDIMMs.
- Mixing different capacities of RDIMMs and LRDIMMs are not allowed when Intel Persistent Memory 200 series (BPS) is installed.
- Intel Persistent Memory 200 series (BPS) of different capacities are not allowed.
- VMware ESXi boot takes longer time when higher capacity of Intel Persistent Memory 200 series (BPS) are configured in App Direct Mode. This is Address Range Scrub (ARS). This is expected as background Address Range Scrub (ARS) is going on the interleave sets and needs to be completed prior the pMem datastore is mounted on ESXi.
- In App Direct Mode (AP), sockets can be populated symmetrically or asymmetrically.
- In Memory Mode (MM), sockets can be populated symmetrically.
- Memory mode is not supported for the 6+1, 8+1 and 12+2 configurations irrespective of DDR to Intel Persistent Memory 200 series (BPS) capacity ratio.
- In VMware ESXi environment, if BPS goal is changed between App Direct Mode and Memory Mode, it is recommended to sanitize the Intel Persistent Memory 200 series (BPS) before creating a new goal.
- Populate Intel Persistent Memory 200 series (BPS) in DIMM slot 1, unless Intel Persistent Memory 200 series (BPS) is the only DIMM in that channel, and then populate in DIMM slot 0.

For more information about the supported Intel Persistent Memory 200 series (BPS) configurations, see the *Dell EMC Intel Persistent Memory 200 series (BPS) User's Guide* at [https://www.dell.com/support/home/products/server\\_int/server\\_int\\_poweredge](https://www.dell.com/support/home/products/server_int/server_int_poweredge).

**Table 24. Supported Intel Persistent Memory 200 series (BPS) for dual processor configurations**

Configuration	Description per processor	Memory population rules	
		RDIMMs or LRDIMMs	Intel Persistent Memory 200 series (BPS)
Configuration 1	4 x RDIMMs, 4 x Intel Persistent Memory 200 series (BPS)	Processor1 {A1, 2, 3, 4} Processor2 {B1, 2, 3, 4}	Processor1 {A5, 6, 7, 8} Processor2 {B5, 6, 7, 8}
Configuration 2	6 x RDIMMs, 1 x Intel Persistent Memory 200 series (BPS)	Processor1 {A1, 2, 3, 4, 5, 6} Processor2 {B1, 2, 3, 4, 5, 6}	Processor1 {A7} Processor2 {B7}
Configuration 3	8 x RDIMMs, 1 x Intel Persistent Memory 200 series (BPS)	Processor1 {A1, 2, 3, 4, 5, 6, 7, 8} Processor2 {B1, 2, 3, 4, 5, 6, 7, 8}	Processor1 {A9} Processor2 {B9}
Configuration 4	8 x RDIMMs, 4 x Intel Persistent Memory 200 series (BPS)	Processor1 {A1, 2, 3, 4, 5, 6, 7, 8} Processor2 {B1, 2, 3, 4, 5, 6, 7, 8}	Processor1 {A9, 10, 11, 12} Processor2 {B9, 10, 11, 12}
Configuration 5	8 x RDIMMs, 8 x Intel Persistent Memory 200 series (BPS)	Processor1 {A1, 2, 3, 4, 5, 6, 7, 8} Processor2 {B1, 2, 3, 4, 5, 6, 7, 8}	Processor1 {A9, 10, 11, 12, 13, 14, 15, 16} Processor2 {B9, 10, 11, 12, 13, 14, 15, 16}
Configuration 6	12 x RDIMMs, 2 x Intel Persistent Memory 200 series (BPS)	Processor1 {A1, 2, 3, 4, 5, 6, 7, 8, 9, 10, 11, 12, 15, 16} Processor2 {B1, 2, 3, 4, 5, 6, 7, 8, 9, 10, 11, 12, 15, 16}	Processor1 {A5, 6} Processor2 {B5, 6}

**i** **NOTE:** There are limited configurations available for dual socket servers with only one processor populated.

**Table 25. Intel Persistent Memory 200 series (BPS) Configuration 1 - 4 x RDIMMs/ LRDIMMs, 4 x Intel Persistent Memory 200 series (BPS) per processor**

Total No of RDIMMs/ LRDIMMs	Total No of Intel Persistent Memory 200 series (BPS) DIMMs	1 R/LRDIMM capacity (GB)	1 Intel Persistent Memory 200 series (BPS) capacity (GB)	Total Standard Memory Capacity (GB)	Total PM Capacity (GB)	Supported Modes
4	4	16	128	64	512	MM or AD
4	4	32	128	128	512	MM or AD
4	4	64	128	256	512	AD
4	4	128	128	512	512	AD
4	4	256	128	1024	512	AD
4	4	16	256	64	1024	MM or AD
4	4	32	256	128	1024	MM or AD
4	4	64	256	256	1024	MM or AD
4	4	128	256	512	1024	AD
4	4	256	256	1024	1024	AD
4	4	16	512	64	2048	AD
4	4	32	512	128	2048	MM or AD

**Table 25. Intel Persistent Memory 200 series (BPS) Configuration 1 - 4 x RDIMMs/ LRDIMMs, 4 x Intel Persistent Memory 200 series (BPS) per processor (continued)**

Total No of RDIMMs/ LRDIMMs	Total No of Intel Persistent Memory 200 series (BPS) DIMMs	1 R/LRDIMM capacity (GB)	1 Intel Persistent Memory 200 series (BPS) capacity (GB)	Total Standard Memory Capacity (GB)	Total PM Capacity (GB)	Supported Modes
4	4	64	512	256	2048	MM or AD
4	4	128	512	512	2048	MM or AD
4	4	256	512	1024	2048	AD

**Table 26. Intel Persistent Memory 200 series (BPS) Configuration 2 - 6 x RDIMMs/ LRDIMMs, 1 x Intel Persistent Memory 200 series (BPS) per processor**

Total No of RDIMMs/ LRDIMMs	Total No of Intel Persistent Memory 200 series (BPS) DIMMs	1 R/LRDIMM capacity (GB)	1 Intel Persistent Memory 200 series (BPS) capacity (GB)	Total Standard Memory Capacity (GB)	Total PM Capacity (GB)	Supported Modes
6	1	16	128	96	128	AD
6	1	32	128	192	128	AD
6	1	64	128	384	128	AD
6	1	128	128	768	128	AD
6	1	256	128	1536	128	AD
6	1	16	256	96	256	AD
6	1	32	256	192	256	AD
6	1	64	256	384	256	AD
6	1	128	256	768	256	AD
6	1	256	256	1536	256	AD
6	1	16	512	96	512	AD
6	1	32	512	192	512	AD
6	1	64	512	384	512	AD
6	1	128	512	768	512	AD
6	1	256	512	1536	512	AD

**Table 27. Intel Persistent Memory 200 series (BPS) Configuration 3 - 8 x RDIMMs/ LRDIMMs, 1 x Intel Persistent Memory 200 series (BPS) per processor**

Total No of RDIMMs / LRDIMMs	Total No of Intel Persistent Memory 200 series (BPS) DIMMs	1 R/LRDIMM capacity (GB)	1 Intel Persistent Memory 200 series (BPS) capacity (GB)	Total Standard Memory Capacity (GB)	Total PM Capacity (GB)	Supported Modes
8	1	16	128	128	128	AD
8	1	32	128	256	128	AD
8	1	64	128	512	128	AD
8	1	128	128	1024	128	AD
8	1	256	128	2048	128	AD

**Table 27. Intel Persistent Memory 200 series (BPS) Configuration 3 - 8 x RDIMMs/ LRDIMMs, 1 x Intel Persistent Memory 200 series (BPS) per processor (continued)**

Total No of RDIMMs / LRDIMMs	Total No of Intel Persistent Memory 200 series (BPS) DIMMs	1 R/LRDIMM capacity (GB)	1 Intel Persistent Memory 200 series (BPS) capacity (GB)	Total Standard Memory Capacity (GB)	Total PM Capacity (GB)	Supported Modes
8	1	16	256	128	256	AD
8	1	32	256	256	256	AD
8	1	64	256	512	256	AD
8	1	128	256	1024	256	AD
8	1	256	256	2048	256	AD
8	1	16	512	128	512	AD
8	1	32	512	256	512	AD
8	1	64	512	512	512	AD
8	1	128	512	1024	512	AD
8	1	256	512	2048	512	AD

**Table 28. Intel Persistent Memory 200 series (BPS) Configuration 4 - 8 x RDIMMs/ LRDIMMs, 4 x Intel Persistent Memory 200 series (BPS) per processor**

Total No of RDIMMs / LRDIMMs	Total No of Intel Persistent Memory 200 series (BPS) DIMMs	1 R/LRDIMM capacity (GB)	1 Intel Persistent Memory 200 series (BPS) capacity (GB)	Total Standard Memory Capacity (GB)	Total PM Capacity (GB)	Supported Modes
8	4	16	128	128	512	MM or AD
8	4	32	128	256	512	AD
8	4	64	128	512	512	AD
8	4	128	128	1024	512	AD
8	4	256	128	2048	512	AD
8	4	16	256	128	1024	MM or AD
8	4	32	256	256	1024	MM or AD
8	4	64	256	512	1024	AD
8	4	128	256	1024	1024	AD
8	4	256	256	2048	1024	AD
8	4	16	512	128	2048	MM or AD
8	4	32	512	256	2048	MM or AD
8	4	64	512	512	2048	MM or AD
8	4	128	512	1024	2048	AD
8	4	256	512	2048	2048	AD

**Table 29. Intel Persistent Memory 200 series (BPS) Configuration 5 - 8 x RDIMMs/ LRDIMMs, 8 x Intel Persistent Memory 200 series (BPS) per processor**

Total No of RDIMMs / LRDIMMs	Total No of Intel Persistent Memory 200 series (BPS) DIMMs	1 R/LRDIMM capacity (GB)	1 Intel Persistent Memory 200 series (BPS) capacity (GB)	Total Standard Memory Capacity (GB)	Total PM Capacity (GB)	Supported Modes
8	8	16	128	128	1024	MM or AD
8	8	32	128	256	1024	MM or AD
8	8	64	128	512	1024	AD
8	8	128	128	1024	1024	AD
8	8	256	128	2048	1024	AD
8	8	16	256	128	2048	MM or AD
8	8	32	256	256	2048	MM or AD
8	8	64	256	512	2048	MM or AD
8	8	128	256	1024	2048	AD
8	8	256	256	2048	2048	AD
8	8	16	512	128	4096	AD
8	8	32	512	256	4096	MM or AD
8	8	64	512	512	4096	MM or AD
8	8	128	512	1024	4096	MM or AD
8	8	256	512	2048	4096	AD

**Table 30. Intel Persistent Memory 200 series (BPS) Configuration 6 - 12 x RDIMMs/ LRDIMMs, 2 x Intel Persistent Memory 200 series (BPS) per processor**

Total No of RDIMMs / LRDIMMs	Total No of Intel Persistent Memory 200 series (BPS) DIMMs	1 R/LRDIMM capacity (GB)	1 Intel Persistent Memory 200 series (BPS) capacity (GB)	Total Standard Memory Capacity (GB)	Total PM Capacity (GB)	Supported Modes
12	2	16	128	192	256	AD
12	2	32	128	384	256	AD
12	2	64	128	768	256	AD
12	2	128	128	1536	256	AD
12	2	256	128	3072	256	AD
12	2	16	256	192	512	AD
12	2	32	256	384	512	AD
12	2	64	256	768	512	AD
12	2	128	256	1536	512	AD
12	2	256	256	3072	512	AD
12	2	16	512	192	1024	AD
12	2	32	512	384	1024	AD
12	2	64	512	768	1024	AD

**Table 30. Intel Persistent Memory 200 series (BPS) Configuration 6 - 12 x RDIMMs/ LRDIMMs, 2 x Intel Persistent Memory 200 series (BPS) per processor (continued)**

Total No of RDIMMs / LRDIMMs	Total No of Intel Persistent Memory 200 series (BPS) DIMMs	1 R/LRDIMM capacity (GB)	1 Intel Persistent Memory 200 series (BPS) capacity (GB)	Total Standard Memory Capacity (GB)	Total PM Capacity (GB)	Supported Modes
12	2	128	512	1536	1024	AD
12	2	256	512	3072	1024	AD

## Removing a memory module

### Prerequisites

1. Follow the safety guidelines listed in the [Safety instructions](#).
2. Follow the procedure listed in the [Before working inside your system](#).
3. [Remove the air shroud](#).

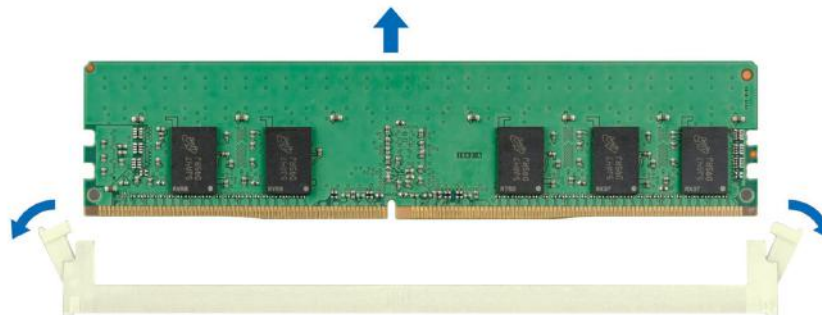
**⚠ WARNING:** The memory modules are hot to touch for some time after the system has been powered off. Allow the memory modules to cool before handling them.

### Steps

1. Locate the appropriate memory module socket.
2. To release the memory module from the socket, simultaneously press the ejectors on both ends of the memory module socket to fully open.

**⚠ CAUTION:** Handle each memory module only by the card edges, ensuring not to touch the middle of the memory module or metallic contacts.

3. Lift the memory module away from the system.



**Figure 61. Removing a memory module**

### Next steps

Replace the memory module.

# Installing a memory module

## Prerequisites

1. Follow the safety guidelines listed in the [Safety instructions](#).
2. Follow the procedure listed in the [Before working inside your system](#).
3. [Remove the air shroud](#).

## Steps

1. Locate the appropriate memory module socket.

**CAUTION:** Handle each memory module only by the card edges, ensuring not to touch the middle of the memory module or metallic contacts.

2. If a memory module is installed in the socket, remove it.
3. Align the edge connector of the memory module with the alignment key of the memory module socket, and insert the memory module in the socket.

**NOTE:** Ensure the socket ejector latches are fully open, before installing the memory module.

**CAUTION:** To prevent damage to the memory module or the memory module socket during installation, do not bend or flex the memory module; insert both ends of the memory module simultaneously.

**NOTE:** The memory module socket has an alignment key that enables you to install the memory module in the socket in only one orientation.

**CAUTION:** Do not apply pressure at the center of the memory module; apply pressure at both ends of the memory module evenly.

4. Press the memory module with your thumbs until the ejectors firmly click into place. When the memory module is properly seated in the socket, the levers on the memory module socket align with the levers on the other sockets that have memory modules installed.

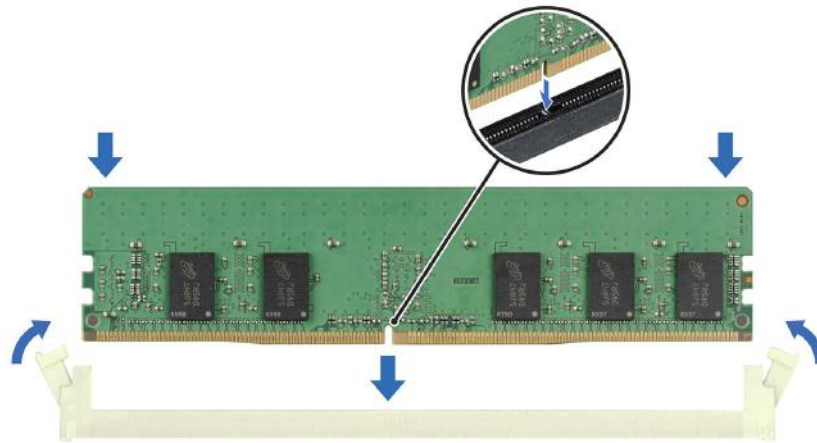


Figure 62. Installing a memory module

## Next steps

1. [Install the air shroud](#).
2. Follow the procedure listed in [After working inside your system](#).


3. To verify if the memory module has been installed properly, press F2 and navigate to **System Setup Main Menu > System BIOS > Memory Settings**. In the **Memory Settings** screen, the System Memory Size must reflect the updated capacity of the installed memory.
4. If the System Memory Size is incorrect, one or more of the memory modules may not be installed properly. Ensure that the memory modules are firmly seated in their sockets.
5. Run the system memory test in system diagnostics.

## Processor and heat sink module


This is a service technician replaceable part only.

## Removing the processor and heat sink module

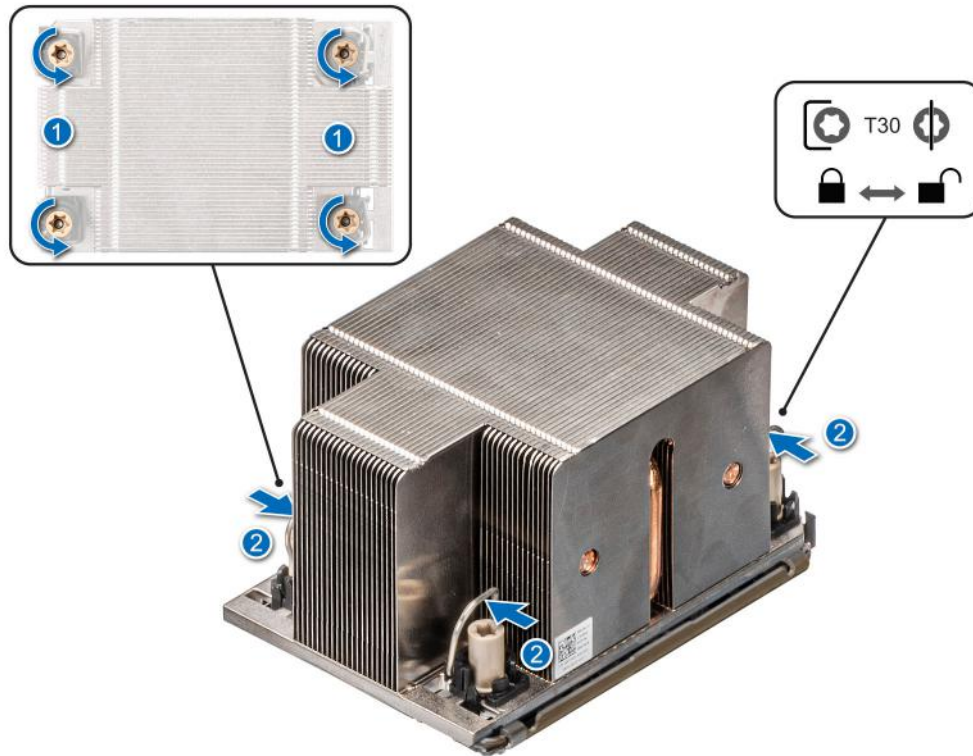
### Prerequisites

1. Follow the safety guidelines listed in the [Safety instructions](#).
2. Follow the procedure listed in the [Before working inside your system](#).
3. [Remove the air shroud](#).
  -  **NOTE:** The heat sink and processor are hot to touch for some time after the system has been powered down. Allow the heat sink and processor to cool down before handling them.

### Steps

1. Ensure all four anti-tilt wires are in the locked position (outward position), and then using a Torx T30 tool, loosen the captive nuts on the processor heat sink module (PHM) in the order that is mentioned below:
  - a. Loosen the first nut three turns.
  - b. Loosen the nut diagonally opposite to the nut you loosened first.
  - c. Repeat the procedure for the remaining two nuts.
  - d. Return to the first nut and loosen it completely.
  -  **NOTE:** Ensure that the anti-tilt wires on the PHM are in locked position when loosening the captive screws.
2. Set all the anti-tilt wires to unlocked position (inward position).





**Figure 63. Removing the processor heat sink module**

3. Lift the PHM from the system and set the PHM aside with the processor side facing up.

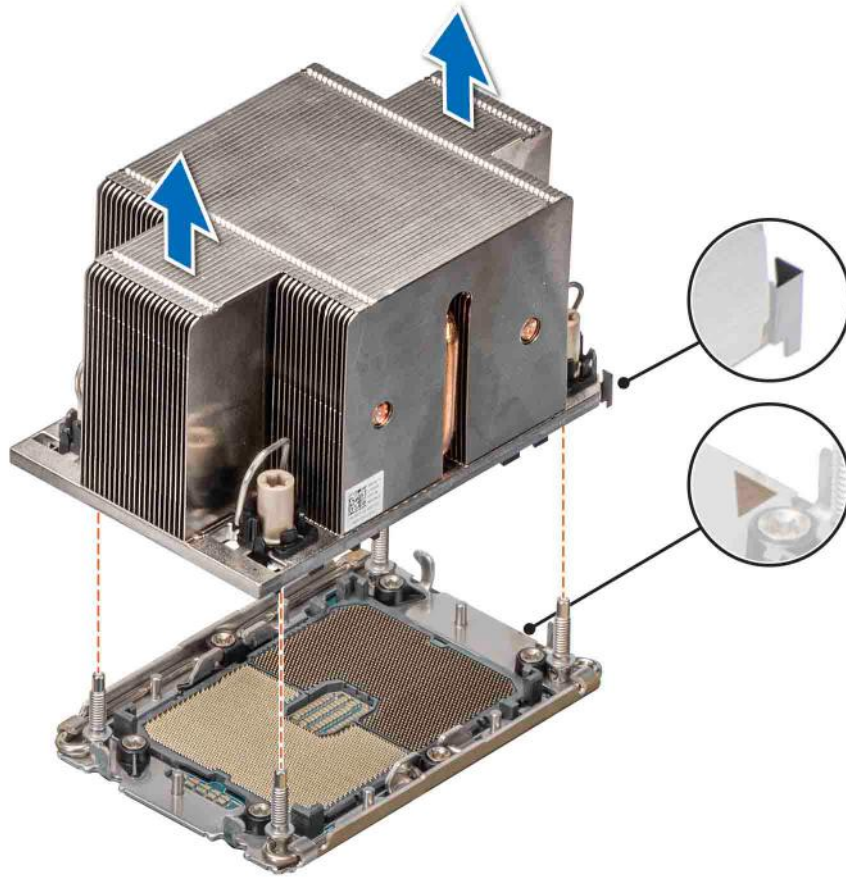


Figure 64. Removing a heat sink

### Next steps

If you are removing a faulty heat sink, [replace the heat sink](#), if not, [remove the processor](#).

## Removing the processor

### Prerequisites

**⚠ WARNING:** Remove the processor from processor and heat sink module (PHM) only if you are replacing the processor or heat sink.

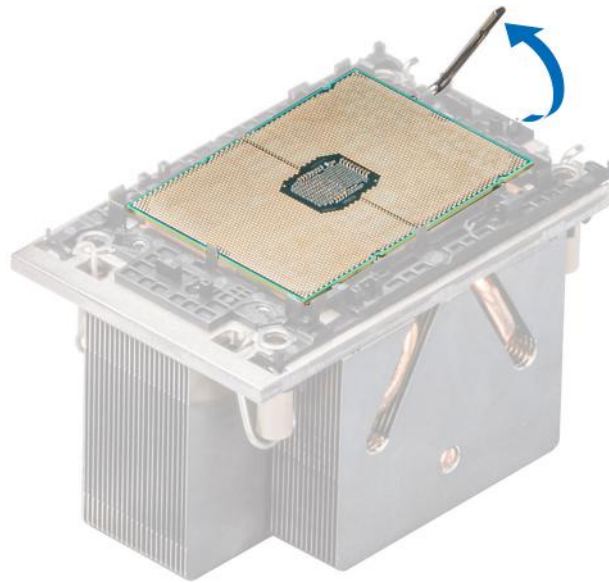
1. Follow the safety guidelines listed in the [Safety instructions](#).
2. Follow the procedure listed in the [Before working inside your system](#).
3. [Remove the air shroud](#).
4. [Remove the processor heat sink module](#) or [Remove the liquid cooling module](#).

**⚠ CAUTION:** You may find the CMOS battery loss or CMOS checksum error displayed during the first instance of powering on the system after the processor or system board replacement which is expected. To fix this, simply go to setup option to configure the system settings.

### Steps

1. Place the heat sink with the processor side facing up.
2. Using your thumb, lift up the Thermal Interface Material (TIM) break lever to release the processor from the TIM and retaining clip.
3. Holding the processor by the edges, lift the processor away from the retaining clip.

**NOTE:** Ensure to hold the retaining clip to the heat sink as you lift the TIM break lever.

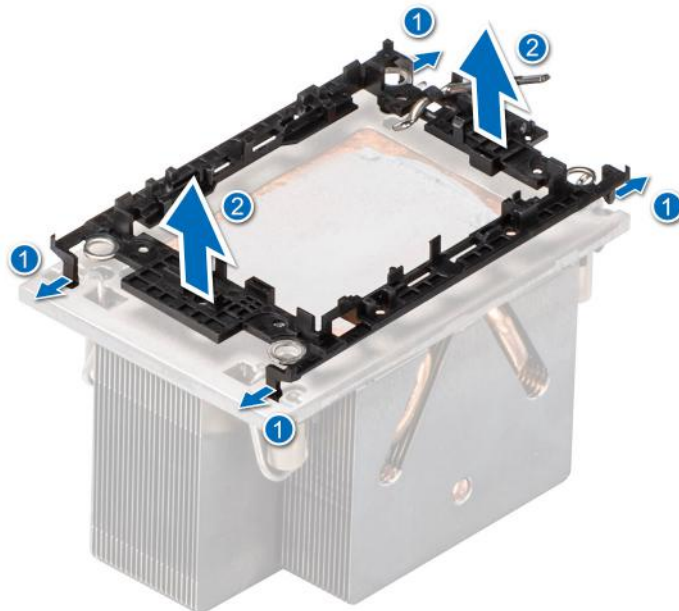


**Figure 65. Lift up the TIM break lever**

- Using your thumb and index finger, first hold the retaining clip release tab at the pin 1 connector, pull out the tip of the release tab, and then lift the retaining clip partially from the heat sink.

**NOTE:** Ensure to return the TIM break lever back to its original position.

- Repeat the above procedure at the remaining three corners of the retaining clip.
- After all the corners are released from the heat sink, lift the retaining clip from the pin 1 corner of the heat sink.



**Figure 66. Removing the retaining clip**

#### Next steps

Replace the processor.

# Installing the processor

## Prerequisites

1. Follow the safety guidelines listed in the [Safety instructions](#).
2. Follow the procedure listed in [Before working inside your system](#).
3. [Remove the air shroud](#).
4. [Remove the processor heat sink module](#) or [Remove the liquid cooling module](#).

## Steps

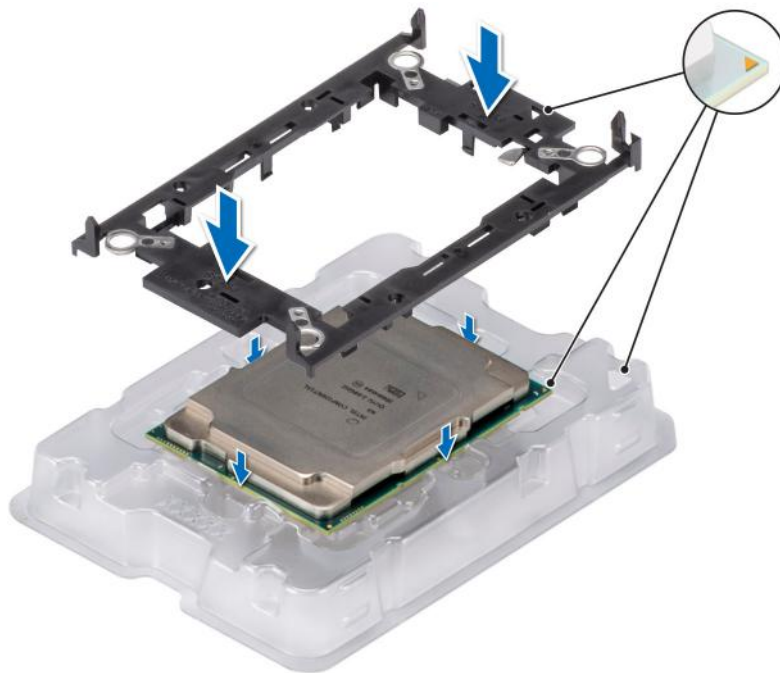
1. Place the processor in the processor tray.

**NOTE:** Ensure the pin 1 indicator on the processor tray is aligned with the pin 1 indicator on the processor.

2. Place the retaining clip on top of the processor in the processor tray aligning pin 1 indicator on the processor.

**NOTE:** Ensure the pin 1 indicator on the bracket is aligned with the pin 1 indicator on the processor before placing the retaining clip on the processor.

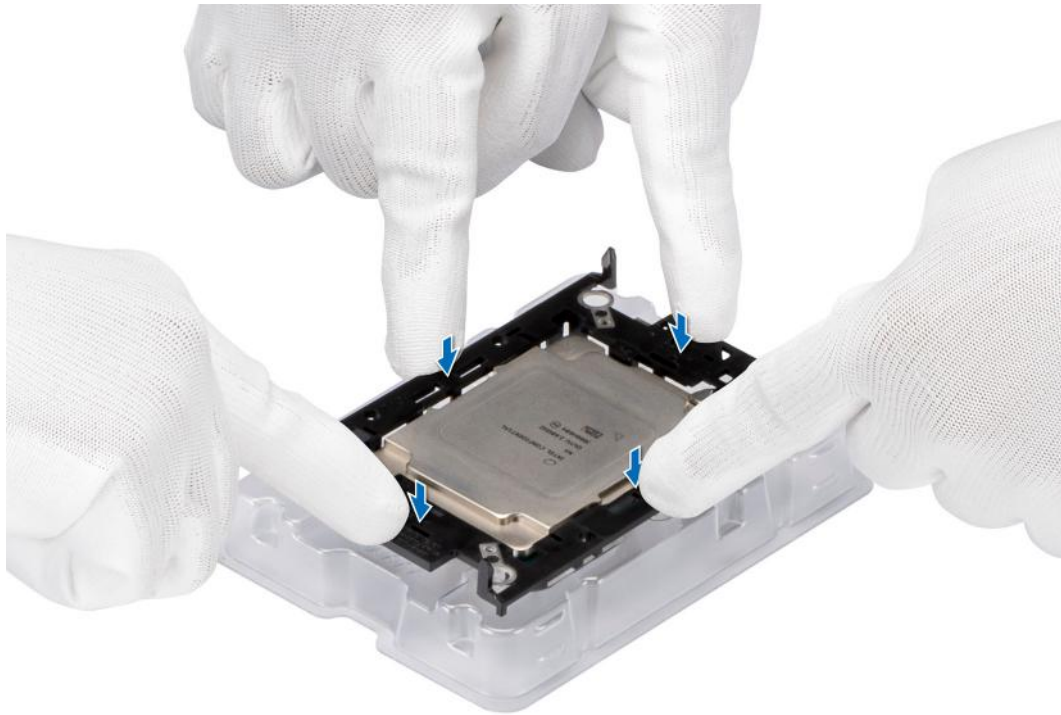
**NOTE:** Before you install the heat sink, ensure to place the processor and retaining clip in the tray.



**Figure 67. Installing the retaining clip**

3. Align the processor with retaining clip, by using the fingers press the retaining clip on all the four sides until it clicks into place.

**NOTE:** Ensure the processor is securely latched to the retaining clip.



**Figure 68. Press the retaining clip on the four sides**

4. If you are using an existing heat sink, remove the thermal grease from the heat sink by using a clean lint-free cloth.
5. Use the thermal grease syringe included with your processor kit to apply the grease in a thin spiral design on the bottom of the heat sink.

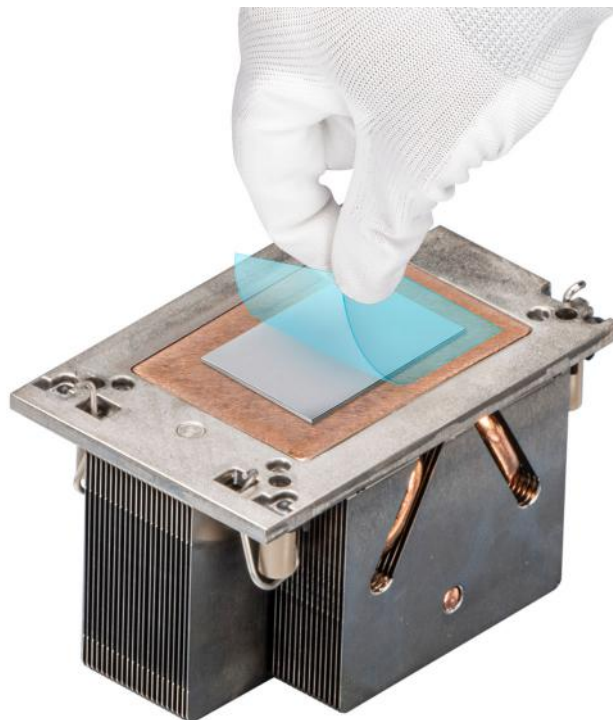
**CAUTION:** Applying too much thermal grease can result in excess grease coming in contact with and contaminating the processor socket.

**NOTE:** The thermal grease syringe is intended for single use only. Dispose the syringe after you use it.



**Figure 69. Applying thermal grease**

6. For new heat sink, remove the Thermal Interface Material (TIM) protective film from the base of heat sink.



**Figure 70. Removing the Thermal Interface Material (TIM) protective film**

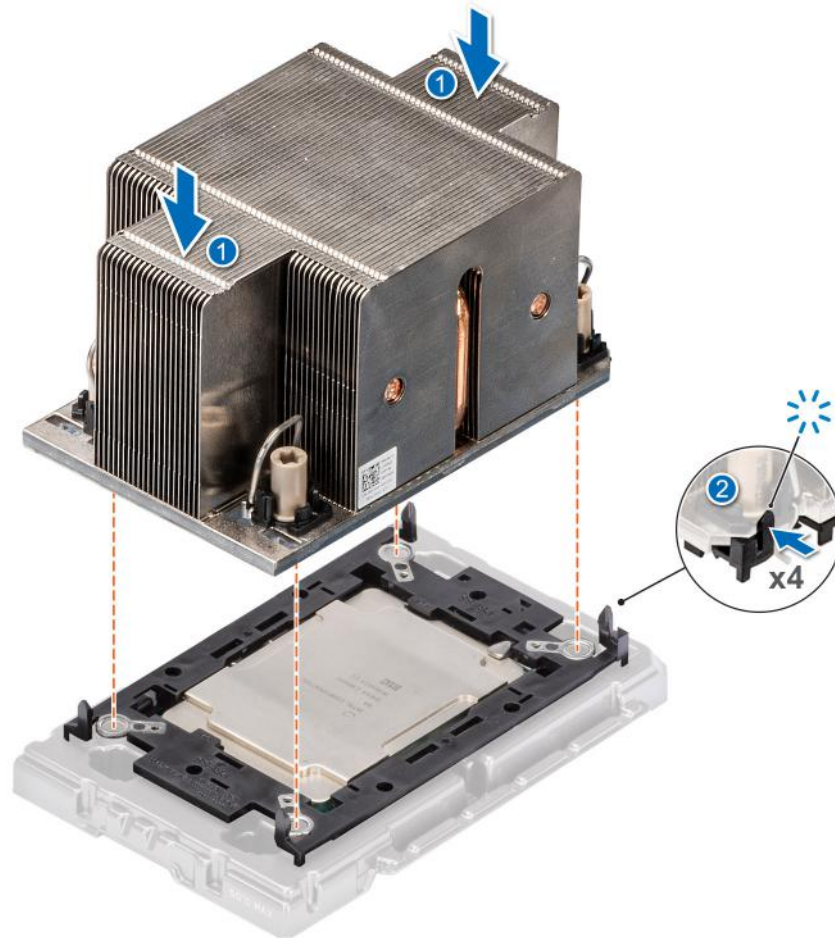
7. Place the heat sink on the processor and press the base of the heat sink until the retaining clip locks onto the heat sink at all the four corners.

**⚠ CAUTION: To avoid damaging the fins on the heat sink, do not press down on the heat sink fins.**



**NOTE:**

- Ensure latching features on retaining clip and heat sink are aligned during assembly.
- Ensure that the pin 1 indicator on the heat sink is aligned with the pin 1 indicator on the retaining clip before placing the heat sink onto the retaining clip.



**Figure 71. Installing the heat sink onto the processor**

**Next steps**

1. [Install the heat sink module](#) or [install the liquid cooling module](#) .
2. [Install the air shroud](#).
3. Follow the procedure listed in [After working inside your system](#).

## Installing the processor and heat sink module

**Prerequisites**

Never remove the heat sink from a processor unless you intend to replace the processor or system board. The heat sink is necessary to maintain proper thermal conditions.

1. Follow the safety guidelines listed in the [Safety instructions](#).
2. Follow the procedure listed in the [Before working inside your system](#).
3. [Remove the air shroud](#).
4. If installed, remove the processor dust cover.

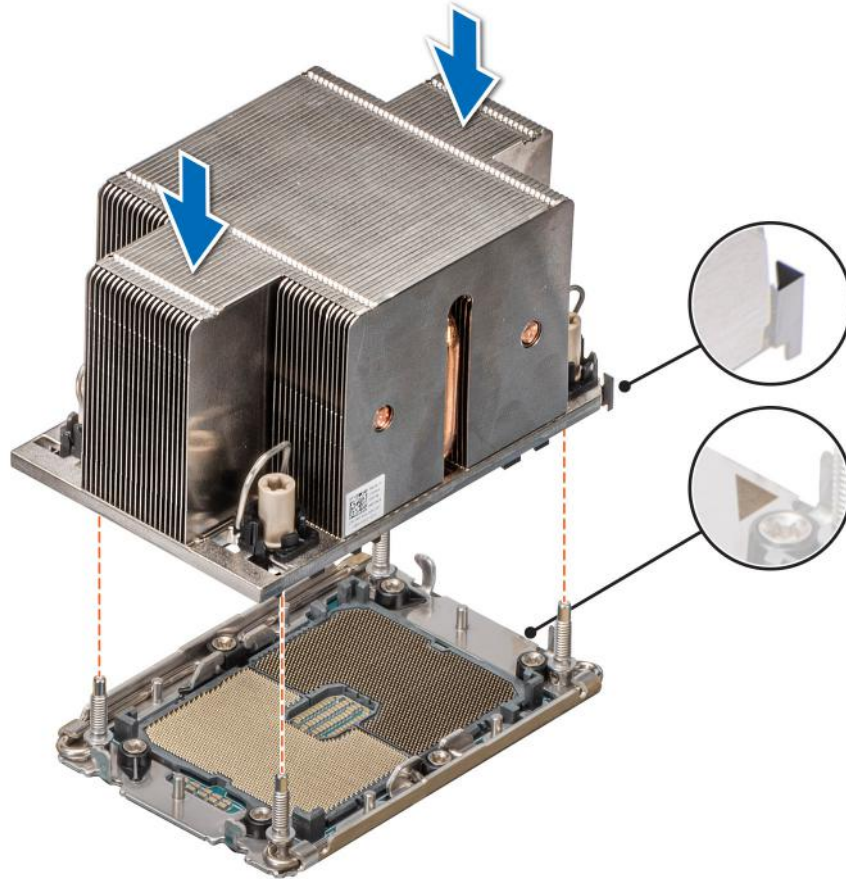
**Steps**

1. Set the anti-tilt wires to the unlocked position on the heat sink (inward position).

2. Align the pin 1 indicator of the heat sink to the system board, and then place the processor and heat sink on the processor socket.

**CAUTION:** To avoid damaging the fins on the heat sink, do not press down on the heat sink fins.

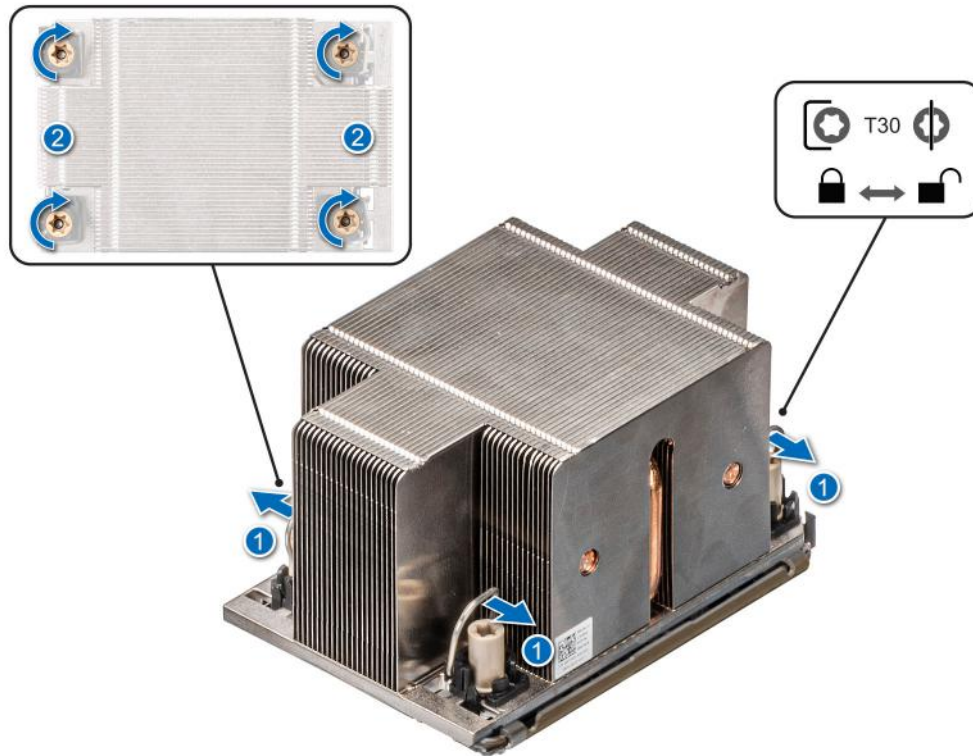
**NOTE:** Ensure that the PHM is held parallel to the system board to prevent damaging the components.



**Figure 72. Installing the processor heat sink**

3. Set the anti-tilt wires to the locked position (outward position), and then using the Torx T30 tool, tighten the captive butts on the PHM in the order below:
  - a. In a random order, tighten the first nut three turns.
  - b. Tighten the nut diagonally opposite to the nut you tighten first.
  - c. Repeat the procedure for the remaining two nuts.
  - d. Return to the nut screw to tighten it completely.
  - e. Check all the nuts to ensure they are firmly secured.





**Figure 73. Set the anti-tilt wires to the locked position and tightening the screws**

**Next steps**

1. [Install the air shroud.](#)
2. Follow the procedure listed in the [After working inside your system.](#)

## Removing the liquid cooling module

**Prerequisites**

1. Follow the safety guidelines listed in the [Safety instructions.](#)
2. Follow the procedure listed in the [Before working inside your system.](#)
3. [Remove the air shroud.](#)
4. [Remove the expansion card riser.](#)

**⚠ WARNING: The liquid cooling (LC) module and processor are too hot to touch for some time after the system has been powered off. Allow the liquid cooling module and processor to cool down before handling them.**

**ⓘ NOTE:** Rear I/O (RIO) board is different for the system with liquid cooling heat sink modules.

**ⓘ NOTE:** The procedure to remove the processor from the liquid cooling module is same as removing the processor from the PHM.

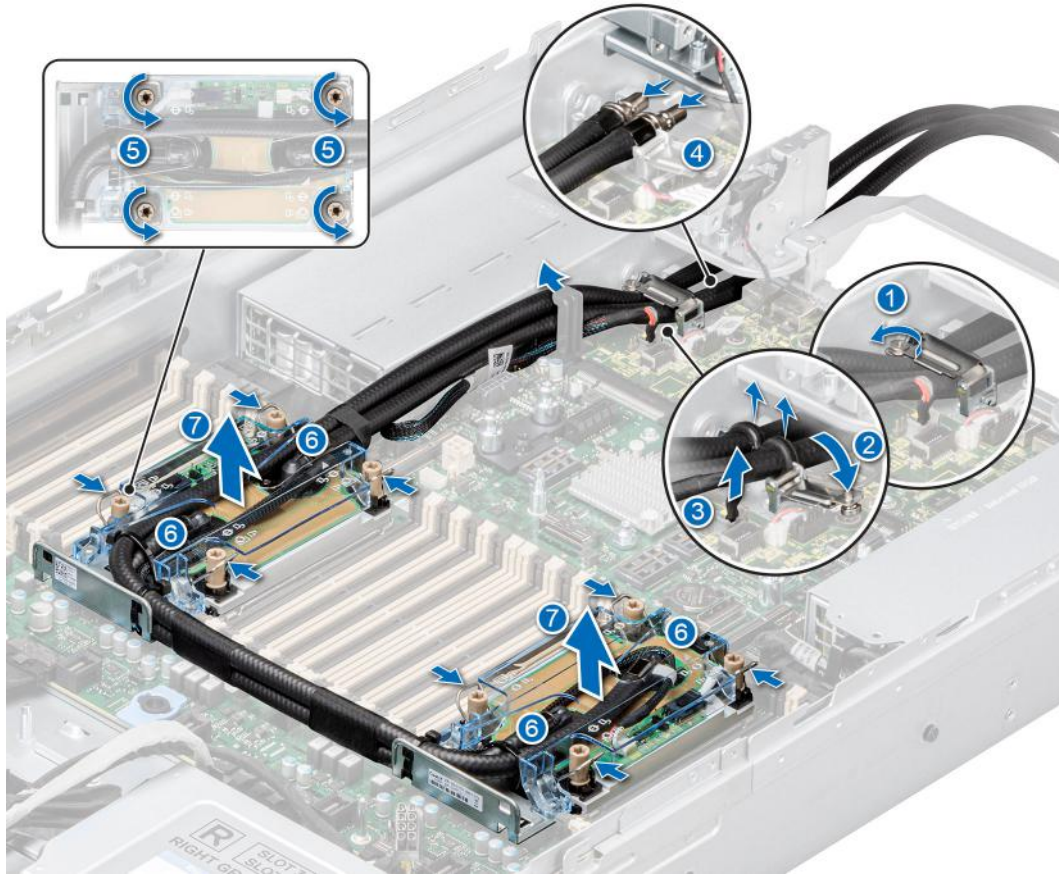
**Steps**

1. Using a Phillips #2 screw driver, loosen the captive screw on the liquid cooling ring holder.
2. Tilt the liquid cooling ring holder to loosen the liquid cooling tubes.
3. Disconnect the liquid cooling leak detection cable from the LC RIO board.
4. Remove the liquid cooling tubes from the clip and LC RIO board.
5. Slightly lift the liquid cooling tubes surrounding the DIMM slots.
6. Using a Torx #T30 screwdriver, loosen the captive screws on the liquid cooling module.

**NOTE:** Ensure the anti-tilt wires on the liquid cooling module are in locked position when loosening the captive screws.

- Set the anti-tilt wires on the liquid cooling module to the unlock position and lift the liquid module from the system.

**NOTE:** The numbers on the image do not depict the exact steps. The numbers are for representation of sequence.



**Figure 74. Removing the liquid cooling module**

### Next steps

- If you are removing a faulty liquid cooling module, [replace the liquid cooling modules](#), else [remove the processor](#).

## Installing the liquid cooling module

### Prerequisites

Never uninstall the heat sink from a processor unless you intend to replace the processor or system board. The heat sink is necessary to maintain proper thermal conditions.

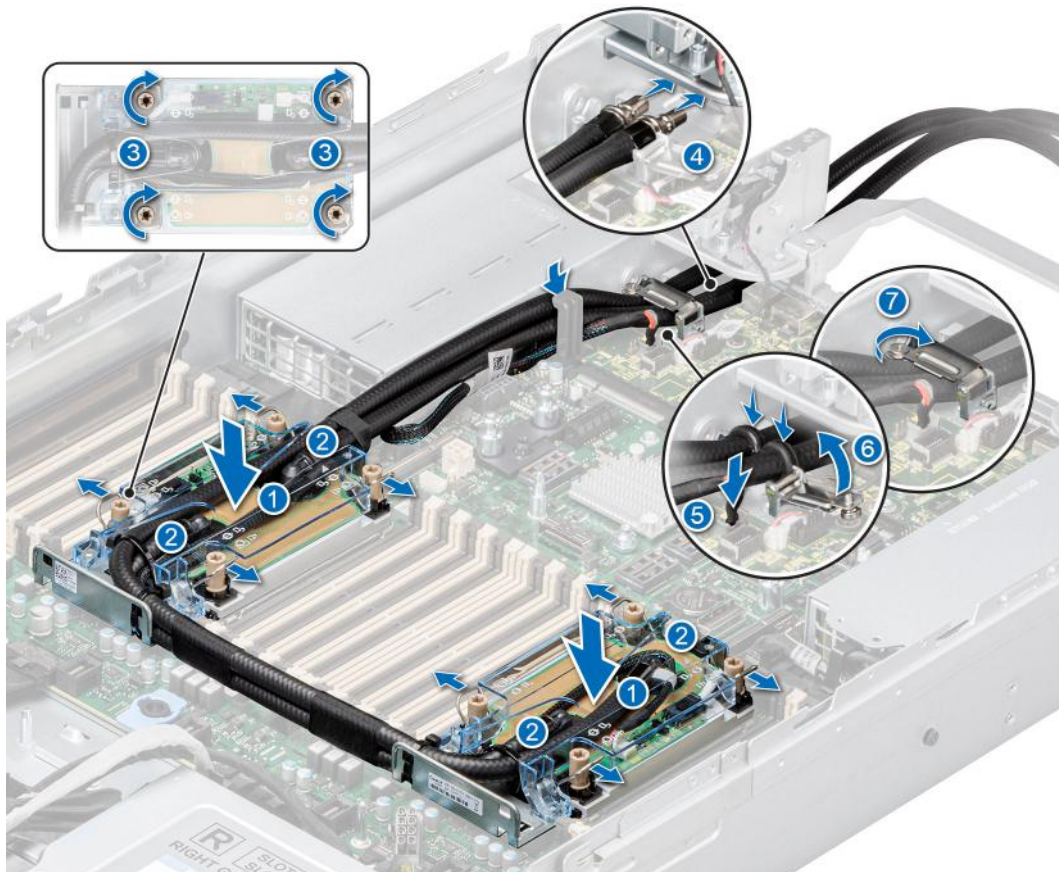
- Follow the safety guidelines listed in the [Safety instructions](#).
- Follow the procedure listed in the [Before working inside your system](#).
- [Remove the air shroud](#).
- [Remove the expansion card riser](#).
- If installed, remove the processor dust cover.

**NOTE:** The procedure to install the processor onto the liquid cooling module is same as installing the processor onto the PHM.

**NOTE:** Ensure anti-tilt wires on the liquid cooling module are in the unlocked position.

## Steps

1. Align the liquid cooling module with the standoff screws on the system board.
  - NOTE:** Ensure that the liquid cooling tubes and liquid cooling leak detection cable are placed towards the rear of the system.
2. Place the module on the processor slot and set all the anti-tilt wires to locked position (outward position).
3. Route the liquid cooling tubes on the front of the system between DIMM slots and J\_SL connector.
4. Using a Torx #T30 screwdriver, tighten the captive screws (12 in-lbs).
5. The tubes leading towards the rear of the chassis and the liquid cooling leak detection cable are placed in between the PSU 2 and the clip of rear I/O board (RIO).
  - NOTE:** Leak detection cable must be placed first into the clip (underneath the cooling tubes), then place tube 2 and tube 1 into the clip to ensure cable does not interfere with the PCIe risers.
6. Route the rear end of the liquid cooling tubes through the RIO board.
  - NOTE:** Follow the number labels on the liquid cooling tubes and ring holders (1,2).
7. Connect the liquid cooling leak detection cable to the connector on RIO.
8. Align the rubber ring on the tubes with the liquid cooling ring holder.
9. Tilt the liquid cooling ring holder and using a Phillips #2 screwdriver, tighten the captive screw on the liquid cooling ring holder to secure it in place.
  - NOTE:** The numbers on the image do not depict the exact steps. The numbers are for representation of sequence.



**Figure 75. Installing the liquid cooling module**

## Next steps

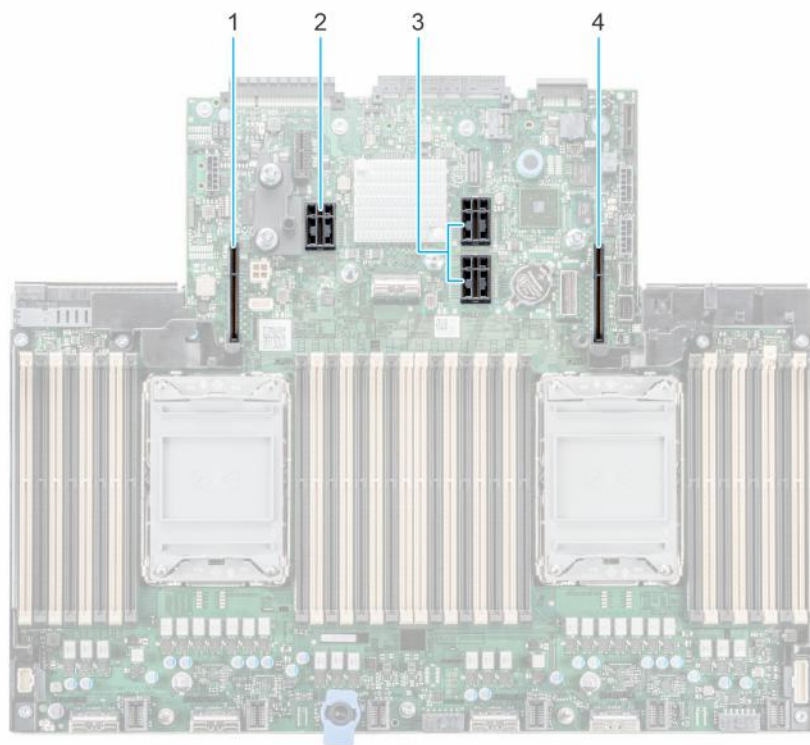
1. [Install the expansion card riser](#) .

2. Install the air shroud.
3. Follow the procedure listed in the [After working inside your system](#).

## Expansion cards and expansion card risers

**NOTE:** A system event entry is logged in the iDRAC Lifecycle Controller if an expansion card riser is not supported or missing. It does not prevent your system from turning on. However, if a F1/F2 pause occurs with an error message, see *Troubleshooting expansion cards* section in the *Dell EMC PowerEdge Servers Troubleshooting Guide* at [www.dell.com/poweredgemanuals](http://www.dell.com/poweredgemanuals).

### Expansion card installation guidelines



**Figure 76. Expansion card slot connectors**

1. GPU riser module left for R4 paddle card (slot 31 and slot 32)
2. Riser 3 (slot 4 and slot 5)
3. Riser 2 (slot 3 and slot 6)
4. GPU riser module right for R1 paddle card (slot 33 and slot 34)

The following table describes the expansion card riser configurations:

**Table 31. Riser configurations**

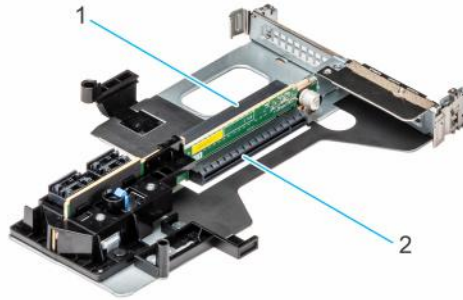
Configurations	Expansion card risers	PCIe Slots	Controlling processor	height	Length	Slot width
Config0-1. with 6x FH, 2x LP and without NVbridge	R2A	3 and 6	Processor 1 and 2	Full height	Half length	x16 + x16
	R3B	4 and 5	Processor 2	Full height	Half length	x8 + x8
	GPU riser module right	33 and 34	Processor 1	Full Height, double width	Full length <sup>1</sup>	x16 + x16



**Table 31. Riser configurations (continued)**

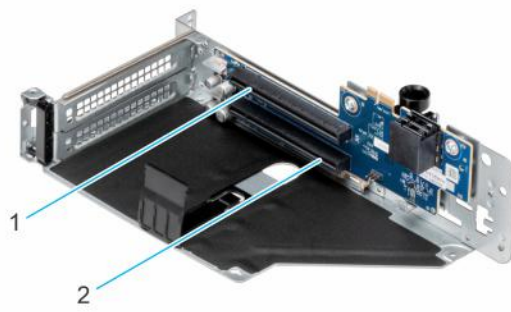
Configurations	Expansion card risers	PCIe Slots	Controlling processor	height	Length	Slot width
	with R1 paddle card					
	GPU riser module left with R4 paddle card	31 and 32	Processor 2	Full Height, double width	Full length <sup>1</sup>	x16 + x16
Config0-2. with 6x FH, 2x LP and with NVbridge	R2A	3 and 6	Processor 1 and 2	Full height	Half length	x16 + x16
	R3B	4 and 5	Processor 2	Full height	Half length	x8 + x8
	GPU riser module right with R1 paddle card	33 and 34	Processor 1	Full Height, double width	Full length <sup>1</sup>	x16 + x16
	GPU riser module left with R4 paddle card	31 and 32	Processor 2	Full Height, double width	Full length <sup>1</sup>	x16 + x16
Config1-1. with 4x FH, 2x LP and without NVbridge	R2A	3 and 6	Processor 1 and 2	Full height	Half length	x16 + x16
	R3 paddle card	NA	Processor 2	NA	NA	NA
	GPU riser module right with R1 paddle card	33 and 34	Processor 1	Full Height, double width	Full length <sup>1</sup>	x16 + x16
	GPU riser module left with R4 paddle card	31 and 32	Processor 2	Full Height, double width	Full length <sup>1</sup>	x16 + x16
Config1-2. with 4x FH, 2x LP and with NVbridge	R2A	3 and 6	Processor 1 and 2	Full height	Half length	x16 + x16
	R3 paddle card	NA	Processor 2	NA	NA	NA
	GPU riser module right with R1 paddle card	33 and 34	Processor 1	Full Height, double width	Full length <sup>1</sup>	x16 + x16
	GPU riser module left with R4 paddle card	31 and 32	Processor 2	Full Height, double width	Full length <sup>1</sup>	x16 + x16

**NOTE:** <sup>1</sup>Full length GPU cards must be installed with custom bracket, see [replacing the GPU bracket](#).



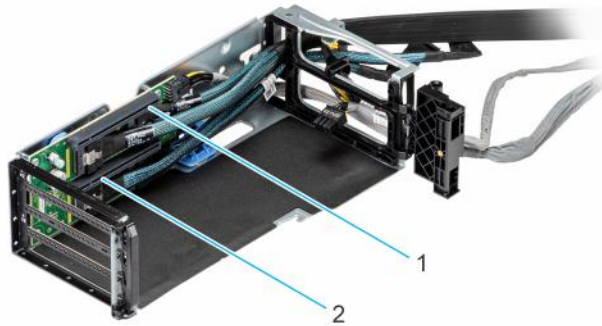
**Figure 77. Riser 2A**

- 1. Slot 3
- 2. Slot 6



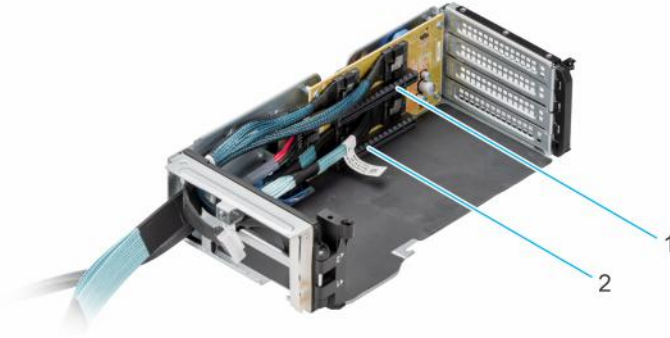
**Figure 78. Riser 3B**

- 1. Slot 5
- 2. Slot 4



**Figure 79. GPU riser module right**

- 1. Slot 34
- 2. Slot 33



**Figure 80. GPU riser module left**

1. Slot 32
2. Slot 31

**NOTE:** The expansion-card slots are not hot-swappable.

The following table provides guidelines for installing expansion cards to ensure proper cooling and mechanical fit. The expansion cards with the highest priority should be installed first using the slot priority indicated. All the other expansion cards should be installed in the card priority and slot priority order.

**Table 32. Config0-1. R2A + R3B + GPU riser module right with R1 paddle card + GPU riser module left with R4 paddle card (without NVbridge)**

Card type	Slot priority	Maximum number of cards
Inventec (VGA) - FH	4, 5	1
Inventec (VGA) - LP	6	1
Inventec (Serial) - FH	4, 5	1
Inventec (Serial) - LP	6	1
NVIDIA (GPU A100)	31, 33, 34, 32	4
AMD (GPU MI100)	31, 33, 34, 32	4
NVIDIA (GPU M10)	31, 33	2
NVIDIA (GPU RTX-A40)	31, 33, 34, 32	4
NVIDIA (GPU T4 FH)	31, 33, 34, 32	4
NVIDIA (GPU T4 LP)	3, 6	2
Inventec (FPERC 10.15)	Integrated slot	1
Foxconn (FPERC 10.15)	Integrated slot	1
Foxconn (FPERC 11)	Integrated slot	1
Foxconn (FPERC HBA 11)	Integrated slot	1
Mellanox (NIC: 100Gb)	3, 6	2
SolarFlare (NIC: 25Gb)	4, 5	2
Broadcom (NIC: 25Gb)	4, 5	2
Intel (NIC: 25Gb)	4, 5	2
Qlogic - Marvell (NIC: 25Gb)	4, 5	2
Mellanox (NIC: 25Gb, FH)	4, 5	2
Mellanox (NIC: 25Gb)	3, 6	2
SolarFlare (NIC: 25Gb)	3, 6	2

**Table 32. Config0-1. R2A + R3B + GPU riser module right with R1 paddle card + GPU riser module left with R4 paddle card (without NVbridge) (continued)**

<b>Card type</b>	<b>Slot priority</b>	<b>Maximum number of cards</b>
Broadcom (NIC: 25Gb)	3, 6	2
Intel (NIC: 25Gb)	3, 6	2
Qlogic - Marvell (NIC: 25Gb)	3, 6	2
Emulex (HBA: FC32)	4, 5	2
Qlogic (HBA: FC32)	4, 5	2
Emulex (HBA: FC32)	3, 6	2
Qlogic (HBA: FC32)	3, 6	2
Emulex (HBA: FC16)	4, 5	2
QLogic (HBA: FC16)	4, 5	2
Emulex (HBA: FC16)	3, 6	2
QLogic (HBA: FC16)	3, 6	2
Broadcom (NIC: 10Gb)	4, 5	2
Intel (NIC: 10Gb)	4, 5	2
Qlogic - Marvell (NIC: 10Gb)	4, 5	2
Qlogic - Marvell (NIC: 10Gb)	3, 6	2
Broadcom (NIC: 10Gb)	3, 6	2
Intel (NIC: 10Gb)	3, 6	2
Qlogic - Marvell (NIC: 10Gb)	3, 6	2
Intel (NIC: 1Gb)	4, 5	2
Broadcom (NIC: 1Gb)	4, 5	2
Intel (NIC: 1Gb)	3, 6	2
Broadcom (NIC: 1Gb)	3, 6	2
Mellanox (NIC: HDR100 VPI)	3, 6	2
Mellanox (NIC:HDR VPI)	3, 6	2
Mellanox (OCP: 25Gb)	Integrated slot	1
Mellanox (OCP 3.0: 25Gb)	Integrated slot	1
SolarFlare (OCP: 25Gb)	Integrated slot	1
Broadcom (OCP: 25Gb)	Integrated slot	1
QLogic (OCP: 25Gb)	Integrated slot	1
Intel (OCP: 25Gb)	Integrated slot	1
Broadcom (OCP: 10Gb)	Integrated slot	1
Intel (OCP: 10Gb)	Integrated slot	1
QLogic (OCP: 10Gb)	Integrated slot	1
Broadcom (OCP: 1Gb)	Integrated slot	1
Intel (OCP: 1Gb)	Integrated slot	1
Foxconn (External Adapter)	4, 5	2
Foxconn (External Adapter)	3, 6	2



**Table 32. Config0-1. R2A + R3B + GPU riser module right with R1 paddle card + GPU riser module left with R4 paddle card (without NVbridge) (continued)**

Card type	Slot priority	Maximum number of cards
Foxconn (External Adapter)	4, 5, 3, 6	4
Inventec (BOSS 1.5)	Integrated slot	1
Samsung (PCIe SSD)	4, 5	2

**Table 33. Config0-2. R2A + R3B + GPU riser module right with R1 paddle card + GPU riser module left with R4 paddle card (with NVbridge)**

Card type	Slot priority	Maximum number of cards
Inventec (VGA) - FH	4, 5	1
Inventec (VGA) - LP	6	1
Inventec (Serial) - FH	4, 5	1
Inventec (Serial) - LP	6	1
NVIDIA (GPU A100)	33, 34, 31, 32	4
AMD (GPU MI100)	31, 33, 34, 32	4
NVIDIA (GPU M10)	31, 33	2
NVIDIA (GPU RTX-A40)	33, 34, 31, 32	4
NVIDIA (GPU T4 FH)	31, 33, 34, 32	4
NVIDIA (GPU T4 LP)	3, 6	2
Inventec (FPERC 10.15)	Integrated slot	1
Foxconn (FPERC 10.15)	Integrated slot	1
Foxconn (FPERC 11)	Integrated slot	1
Foxconn (FPERC HBA 11)	Integrated slot	1
Mellanox (NIC: 100Gb)	3, 6	2
SolarFlare (NIC: 25Gb)	4, 5	2
Broadcom (NIC: 25Gb)	4, 5	2
Intel (NIC: 25Gb)	4, 5	2
Qlogic - Marvell (NIC: 25Gb)	4, 5	2
Mellanox (NIC: 25Gb)	3, 6	2
Mellanox (NIC: 25Gb, LP)	3, 6	2
Mellanox (NIC: 25Gb, FH)	4, 5	2
SolarFlare (NIC: 25Gb)	3, 6	2
Broadcom (NIC: 25Gb)	3, 6	2
Intel (NIC: 25Gb)	3, 6	2
Qlogic - Marvell (NIC: 25Gb)	3, 6	2
Emulex (HBA: FC32)	4, 5	2
Qlogic (HBA: FC32)	4, 5	2
Emulex (HBA: FC32)	3, 6	2
Qlogic (HBA: FC32)	3, 6	2
Emulex (HBA: FC16)	4, 5	2

**Table 33. Config0-2. R2A + R3B + GPU riser module right with R1 paddle card + GPU riser module left with R4 paddle card (with NVbridge) (continued)**

Card type	Slot priority	Maximum number of cards
QLogic (HBA: FC16)	4, 5	2
Emulex (HBA: FC16)	3, 6	2
QLogic (HBA: FC16)	3, 6	2
Broadcom (NIC: 10Gb)	4, 5	2
Intel (NIC: 10Gb)	4, 5	2
Qlogic - Marvell (NIC: 10Gb)	4, 5	2
Broadcom (NIC:10Gb)	4, 5	2
Qlogic - Marvell (NIC: 10Gb)	3, 6	2
Broadcom (NIC: 10Gb)	3, 6	2
Intel (NIC: 10Gb)	3, 6	2
Broadcom (NIC:10Gb)	3, 6	2
Intel (NIC: 1Gb)	4, 5	2
Broadcom (NIC: 1Gb)	4, 5	2
Intel (NIC: 1Gb)	3, 6	2
Broadcom (NIC: 1Gb)	3, 6	2
Mellanox (NIC: HDR100 VPI)	3, 6	2
Mellanox (NIC:HDR VPI)	3, 6	2
Mellanox (OCP: 25Gb)	Integrated slot	1
Mellanox (OCP3.0: 25Gb)	Integrated slot	1
SolarFlare (OCP: 25Gb)	Integrated slot	1
Broadcom (OCP: 25Gb)	Integrated slot	1
QLogic (OCP: 25Gb)	Integrated slot	1
Intel (OCP: 25Gb)	Integrated slot	1
Broadcom (OCP: 10Gb)	Integrated slot	1
Intel (OCP: 10Gb)	Integrated slot	1
QLogic (OCP: 10Gb)	Integrated slot	1
Broadcom (OCP: 1Gb)	Integrated slot	1
Intel (OCP: 1Gb)	Integrated slot	1
Foxconn (External Adapter)	4, 5	2
Foxconn (External Adapter)	3, 6	2
Foxconn (External Adapter)	4, 5, 3, 6	4
Inventec (BOSS 1.5)	Integrated slot	1
Samsung (PCIe SSD)	4, 5	2

**Table 34. Config1-1. R2A + R3 paddle card + GPU riser module right with R1 paddle card + GPU riser module left with R4 paddle card (without NVbridge)**

Card type	Slot priority	Maximum number of cards
Inventec (VGA) - LP	6	1

**Table 34. Config1-1. R2A + R3 paddle card + GPU riser module right with R1 paddle card + GPU riser module left with R4 paddle card (without NVbridge) (continued)**

<b>Card type</b>	<b>Slot priority</b>	<b>Maximum number of cards</b>
Inventec (Serial) - LP	6	1
NVIDIA (GPU A100)	31, 33, 34, 32	4
AMD (GPU MI100)	31, 33, 34, 32	4
NVIDIA (GPU M10)	31, 33	2
NVIDIA (GPU RTX-A40)	31, 33, 34, 32	4
NVIDIA (GPU T4 FH)	31, 33, 34, 32	4
NVIDIA (GPU T4 LP)	3, 6	2
Inventec (FPERC 10.15)	Integrated slot	1
Foxconn (FPERC 10.15)	Integrated slot	1
Foxconn (FPERC 11)	Integrated slot	1
Foxconn (FPERC HBA 11)	Integrated slot	1
Mellanox (NIC: 100Gb)	3, 6	2
Mellanox (NIC: 25Gb)	3, 6	2
Mellanox (NIC: 25Gb, LP)	3, 6	2
SolarFlare (NIC: 25Gb)	3, 6	2
Broadcom (NIC: 25Gb)	3, 6	2
Intel (NIC: 25Gb)	3, 6	2
Qlogic - Marvell (NIC: 25Gb)	3, 6	2
Emulex (HBA: FC32)	3, 6	2
Qlogic (HBA: FC32)	3, 6	2
Emulex (HBA: FC16)	3, 6	2
QLogic (HBA: FC16)	3, 6	2
Qlogic - Marvell (NIC: 10Gb)	3, 6	2
Broadcom (NIC: 10Gb)	3, 6	2
Intel (NIC: 10Gb)	3, 6	2
Qlogic - Marvell (NIC: 10Gb)	3, 6	2
Broadcom (NIC:10Gb)	3, 6	2
Intel (NIC: 1Gb)	3, 6	2
Broadcom (NIC: 1Gb)	3, 6	2
Mellanox (NIC: HDR100 VPI)	3, 6	2
Mellanox (NIC:HDR VPI)	3, 6	2
Mellanox (OCP: 25Gb)	Integrated slot	1
Mellanox (OCP3.0: 25Gb)	Integrated slot	1
SolarFlare (OCP: 25Gb)	Integrated slot	1
Broadcom (OCP: 25Gb)	Integrated slot	1
QLogic (OCP: 25Gb)	Integrated slot	1
Intel (OCP: 25Gb)	Integrated slot	1

**Table 34. Config1-1. R2A + R3 paddle card + GPU riser module right with R1 paddle card + GPU riser module left with R4 paddle card (without NVbridge) (continued)**

Card type	Slot priority	Maximum number of cards
Broadcom (OCP: 10Gb)	Integrated slot	1
Intel (OCP: 10Gb)	Integrated slot	1
QLogic (OCP: 10Gb)	Integrated slot	1
Broadcom (OCP: 1Gb)	Integrated slot	1
Intel (OCP: 1Gb)	Integrated slot	1
Foxconn (External Adapter)	3, 6	2
Foxconn (External Adapter)	3, 6	2
Inventec (BOSS 1.5)	Integrated slot	1

**Table 35. Config1-2. R2A + R3 paddle card + GPU riser module right with R1 paddle card + GPU riser module left with R4 paddle card (with NVbridge)**

Card type	Slot priority	Maximum number of cards
Inventec (VGA) - LP	6	1
Inventec (Serial) - LP	6	1
NVIDIA (GPU A100)	33, 34, 31, 32	4
AMD (GPU MI100)	31, 33, 34, 32	4
NVIDIA (GPU M10)	31, 33	2
NVIDIA (GPU RTX-A40)	33, 34, 31, 32	4
NVIDIA (GPU T4 FH)	31, 33, 34, 32	4
NVIDIA (GPU T4 LP)	3, 6	2
Inventec (FPERC 10.15)	Integrated slot	1
Foxconn (FPERC 10.15)	Integrated slot	1
Foxconn (FPERC 11)	Integrated slot	1
Foxconn (FPERC HBA 11)	Integrated slot	1
Mellanox (NIC: 100Gb)	3, 6	2
Mellanox (NIC: 25Gb)	3, 6	2
Mellanox (NIC: 25Gb, LP)	3, 6	2
SolarFlare (NIC: 25Gb)	3, 6	2
Broadcom (NIC: 25Gb)	3, 6	2
Intel (NIC: 25Gb)	3, 6	2
Qlogic - Marvell (NIC: 25Gb)	3, 6	2
Emulex (HBA: FC32)	3, 6	2
Qlogic (HBA: FC32)	3, 6	2
Emulex (HBA: FC16)	3, 6	2
QLogic (HBA: FC16)	3, 6	2
Qlogic - Marvell (NIC: 10Gb)	3, 6	2
Broadcom (NIC: 10Gb)	3, 6	2
Intel (NIC: 1Gb)	3, 6	2


**Table 35. Config1-2. R2A + R3 paddle card + GPU riser module right with R1 paddle card + GPU riser module left with R4 paddle card (with NVbridge) (continued)**

Card type	Slot priority	Maximum number of cards
Broadcom (NIC: 1Gb)	3, 6	2
Mellanox (NIC: HDR100 VPI)	3, 6	2
Mellanox (NIC:HDR VPI)	3, 6	2
Mellanox (OCP: 25Gb)	Integrated slot	1
Mellanox (OCP3.0: 25Gb)	Integrated slot	1
SolarFlare (OCP: 25Gb)	Integrated slot	1
Broadcom (OCP: 25Gb)	Integrated slot	1
QLogic (OCP: 25Gb)	Integrated slot	1
Intel (OCP: 25Gb)	Integrated slot	1
Broadcom (OCP: 10Gb)	Integrated slot	1
Intel (OCP: 10Gb)	Integrated slot	1
QLogic (OCP: 10Gb)	Integrated slot	1
Broadcom (OCP: 1Gb)	Integrated slot	1
Intel (OCP: 1Gb)	Integrated slot	1
Foxconn (External Adapter)	3, 6	2
Foxconn (External Adapter)	3, 6	2
Inventec (BOSS 1.5)	Integrated slot	1

## Removing the expansion card risers

### Prerequisites

1. Follow the safety guidelines listed in the [Safety instructions](#).
2. Follow the procedure listed in the [Before working inside your system](#).
3. [Remove the air shroud](#).
4. If applicable, disconnect the cables from the expansion card or system board.

 **NOTE:** Only Riser 3 and Riser 2 are supported.

 **WARNING:** If BOSS S2 module is installed, ensure to disconnect the BOSS S2 power cable before removing riser 1 blank, riser 2 or riser 3 cage.

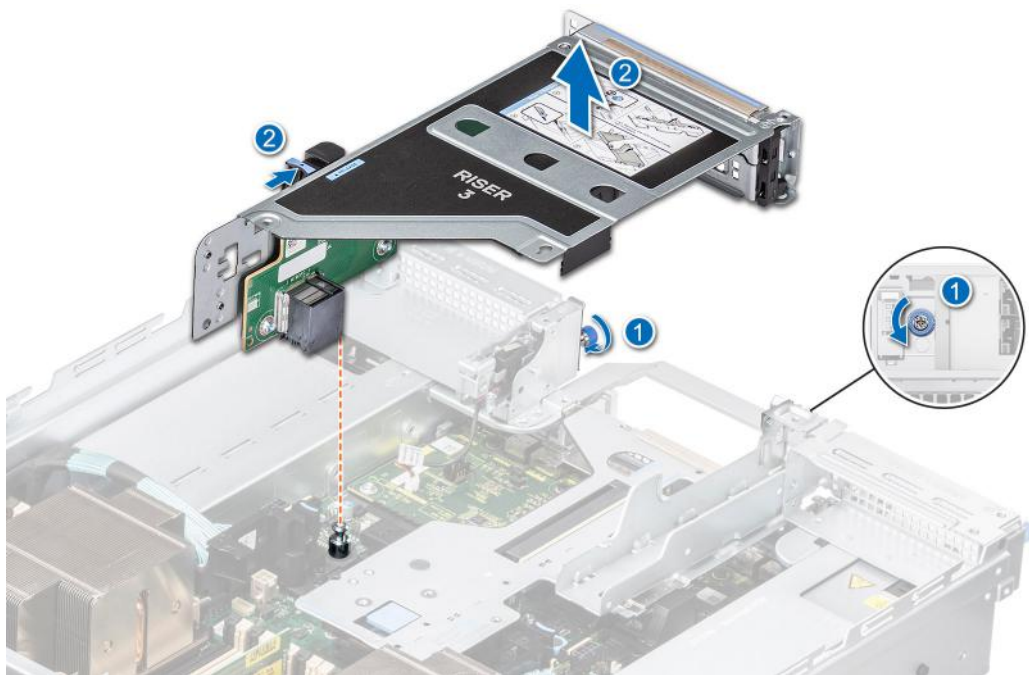


**Figure 81. Disconnecting the BOSS S2 power cable**

**Steps**

1. Loosen the captive screws on the riser.
2. Press the blue release tab or blue button on the riser and holding the edges lift the expansion card riser from the riser connector on the system board.

**NOTE:** The numbers on the image do not depict the exact steps. The numbers are for representation of sequence.



**Figure 82. Removing the expansion card riser (Riser 3)**

**NOTE:** To remove Riser 2, first Riser 1 blank and if installed, BOSS S2 cable and module must be removed.

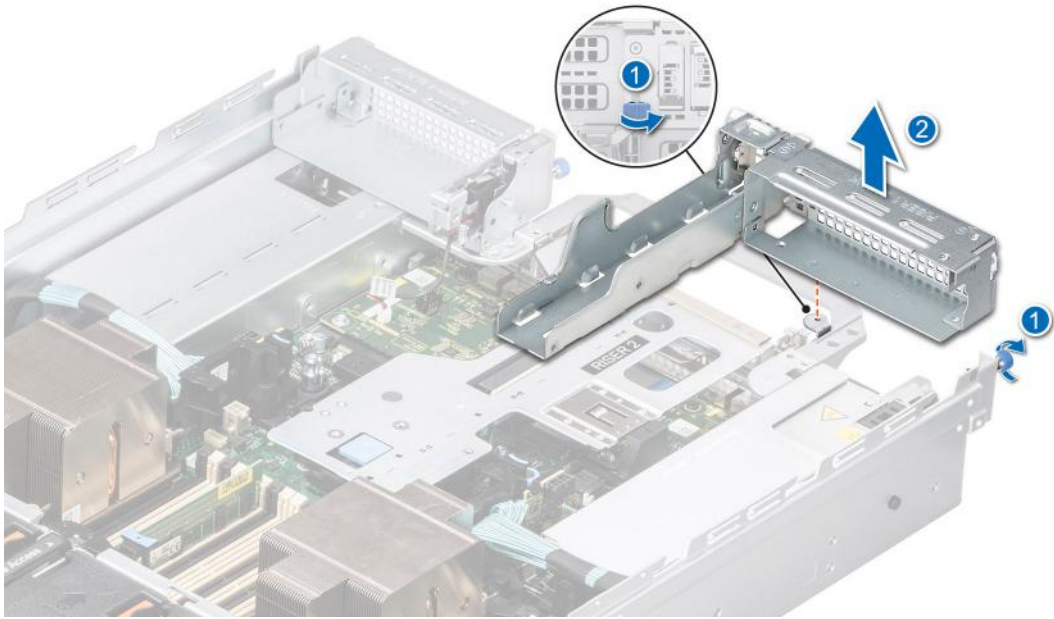


Figure 83. Removing the Riser 1 blank

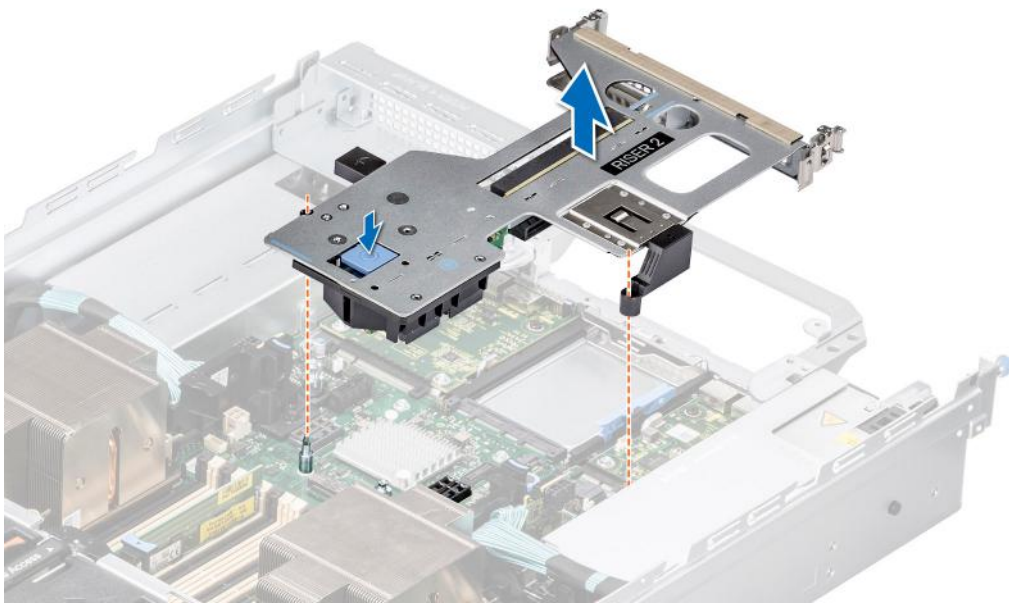
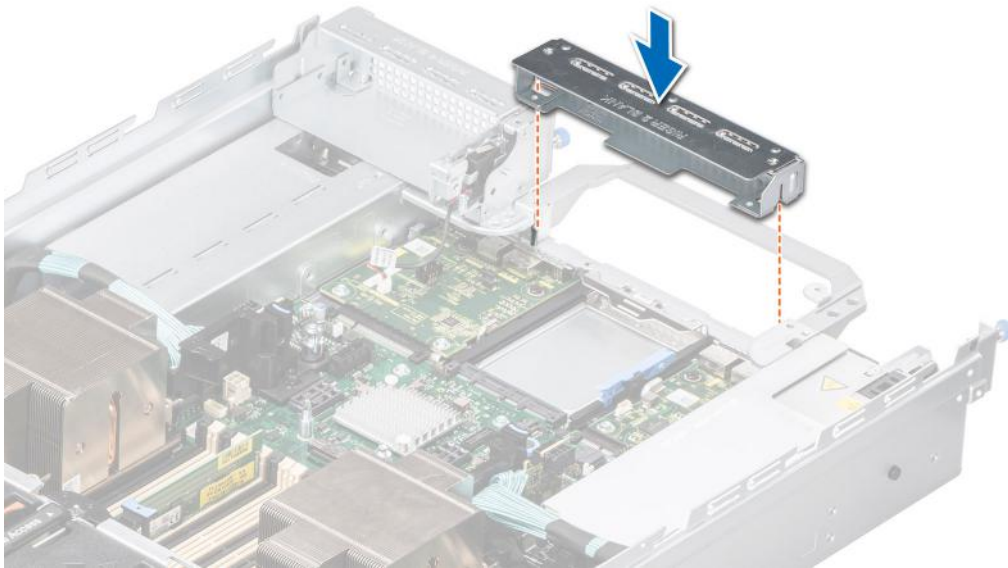


Figure 84. Removing the expansion card riser (Riser 2)

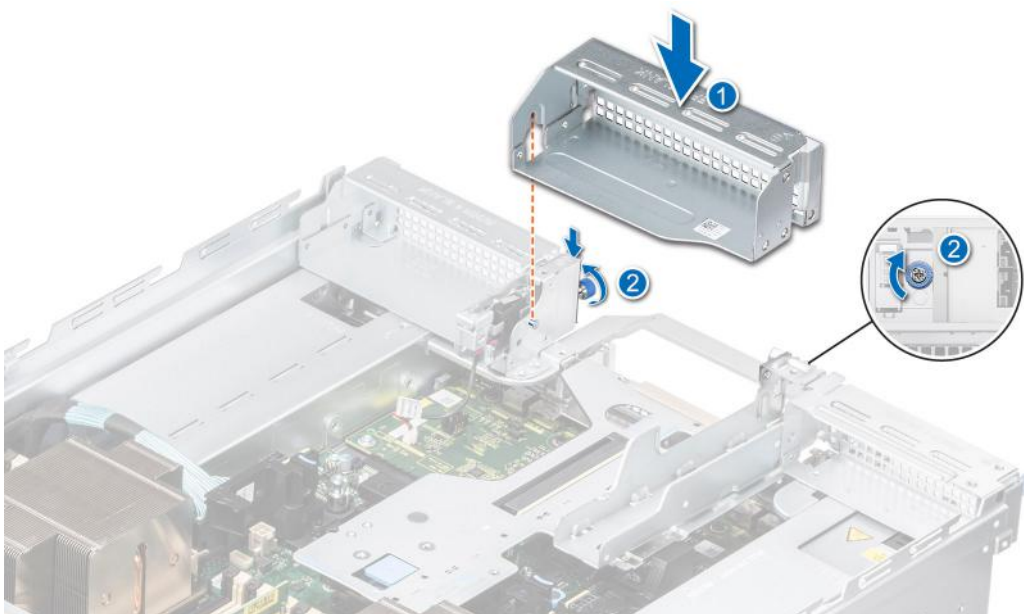
3. If the risers are not going to be replaced, install riser blanks and tighten the captive screws.

**NOTE:** You must install a filler bracket over an empty expansion card slot to maintain Federal Communications Commission (FCC) certification of the system. The brackets also keep dust and dirt out of the system and aid in proper cooling and airflow inside the system.





**Figure 85. Installing the Riser 2 blank**



**Figure 86. Installing the Riser 3 blank**

### Next steps

1. [Replace the expansion card riser.](#)

## Installing the expansion card risers

### Prerequisites

1. Follow the safety guidelines listed in the [Safety instructions](#).
2. Follow the procedure listed in [Before working inside your system](#).
3. [Remove the air shroud](#).
4. If removed, [install the expansion cards into the expansion card risers](#).

**i** **NOTE:** Install Riser 2 before installing Riser 1 blank and Riser 3.

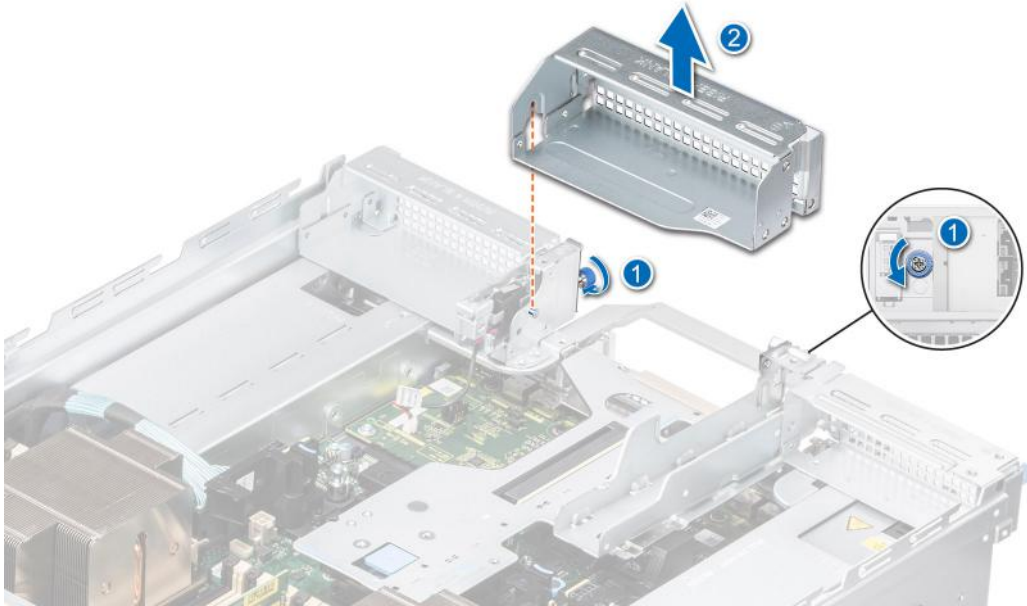


**CAUTION:** Do not install GPUs, network cards, or other PCIe devices on your system that are not validated and tested by Dell. Damage caused by unauthorized and invalidated hardware installation will null and void the system warranty.

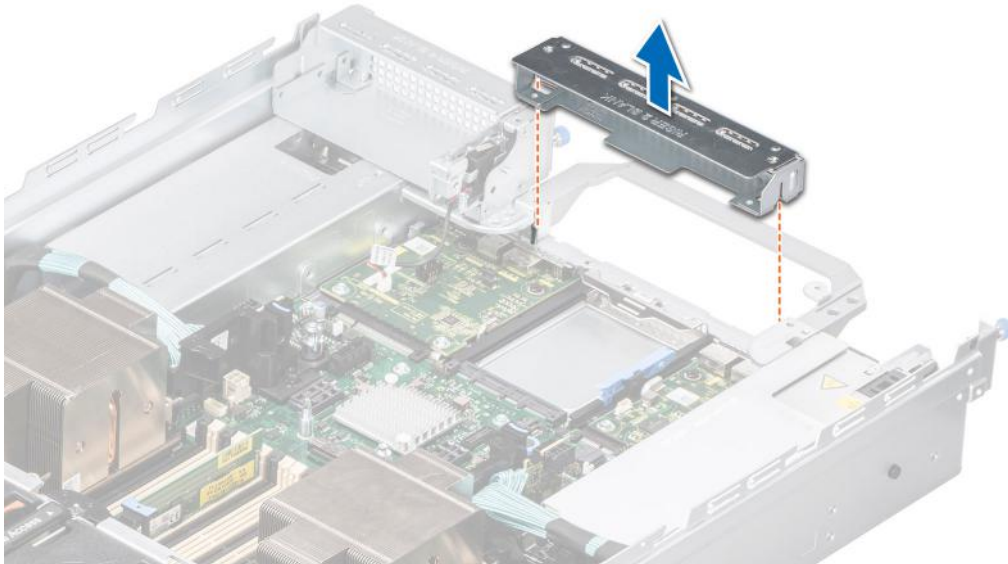
### Steps

1. If installed, remove the riser blanks by loosening the captive screws.

**NOTE:** Store the riser blanks for future use. Filler brackets must be installed in empty expansion card slots to maintain Federal Communications Commission (FCC) certification of the system. The brackets also keep dust and dirt out of the system and aid in proper cooling and airflow inside the system.



**Figure 87. Removing the Riser 3 blank**



**Figure 88. Removing the Riser 2 blank**

2. Holding the edges or the touch points, align the holes on the expansion card riser with the guides on the system board.
3. Lower the expansion card riser into place and press the touch points until the expansion card riser connector is fully seated on the system board connector.
4. Tighten the captive screws on the risers and system if any.

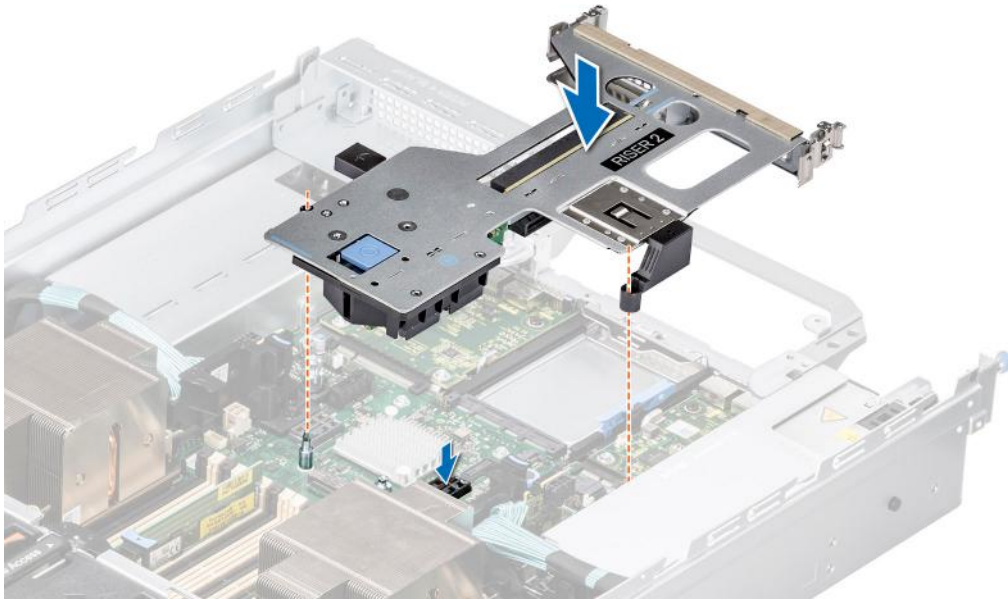


Figure 89. Installing the expansion card riser (Riser 2)

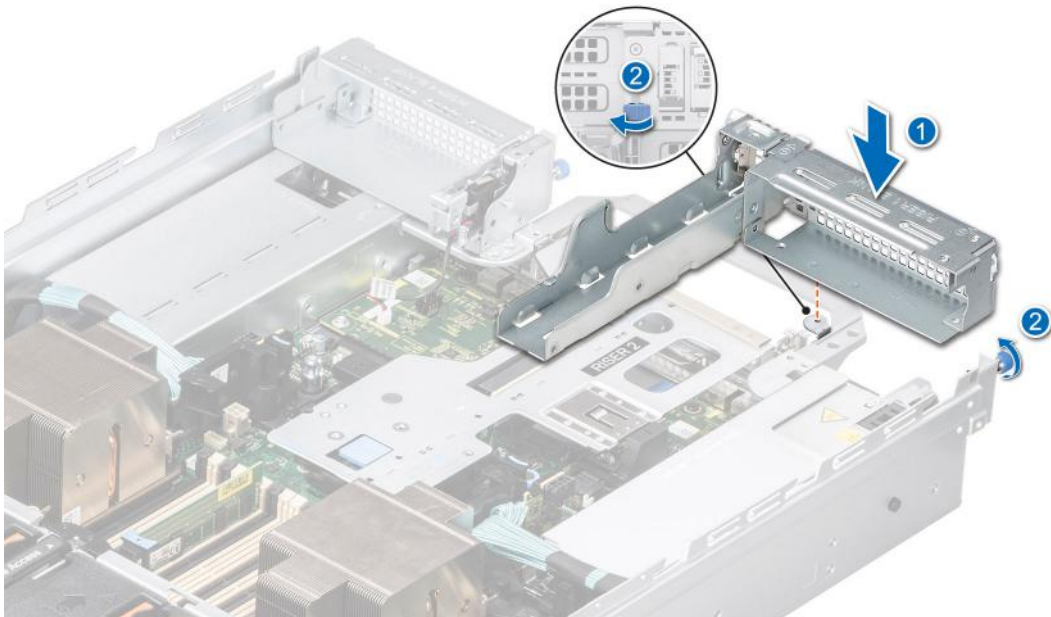
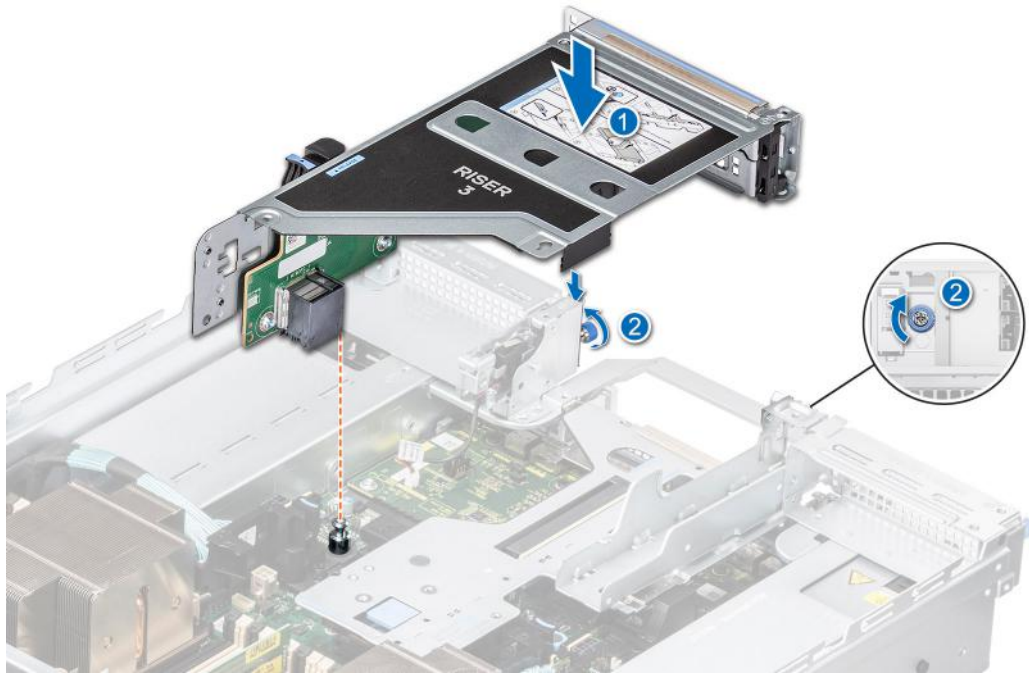


Figure 90. Installing the Riser 1 blank



**Figure 91. Installing the expansion card riser (Riser 3)**

#### Next steps

1. If required, re-connect the cables to the expansion card.
2. [Install the air shroud.](#)
3. Follow the procedure listed in [After working inside your system.](#)
4. Install any device drivers required for the card as described in the documentation for the card.

## Removing expansion card from the expansion card riser

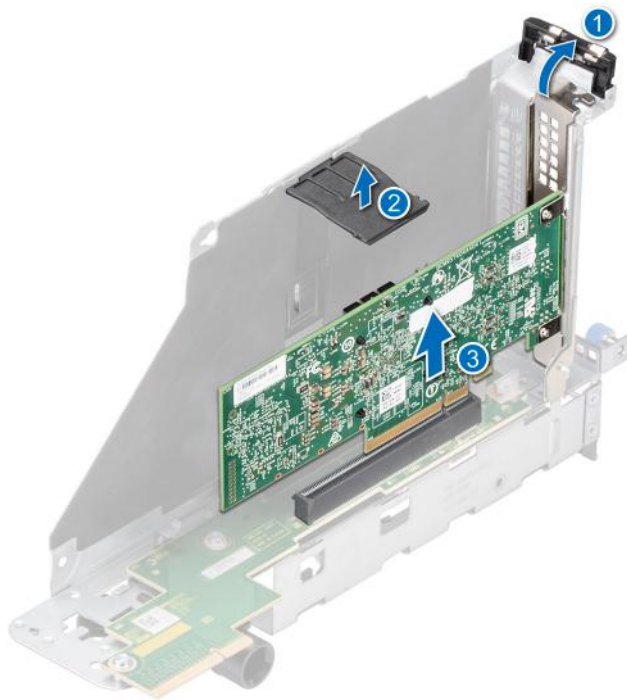
#### Prerequisites

1. Follow the safety guidelines listed in the [Safety instructions.](#)
2. Follow the procedure listed in the [Before working inside your system.](#)
3. If applicable, disconnect the cables from the expansion card.
4. [Remove the air shroud.](#)
5. [Remove the expansion card riser.](#)

#### Steps

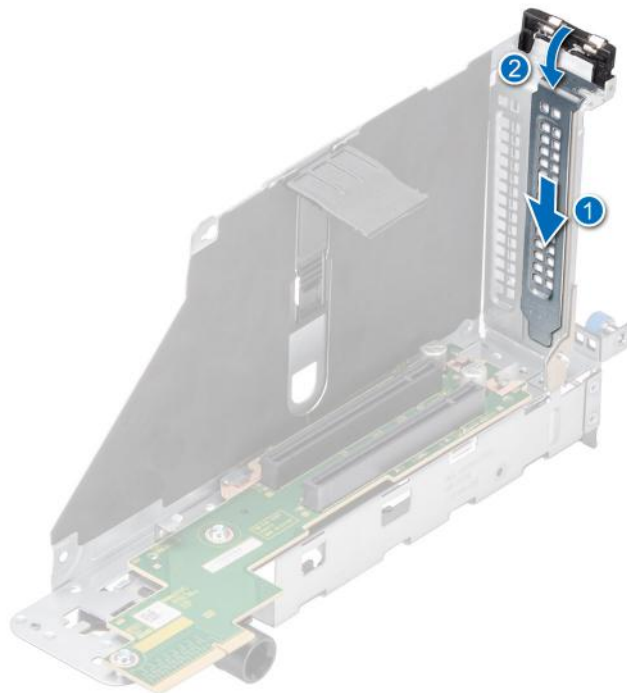
1. Pull and lift the expansion card retention latch lock to open.
2. Pull the card holder before removing the card from the riser.
3. Hold the expansion card by the edges, and pull the card from the riser.

**NOTE:** The numbers on the image do not depict the exact steps. The numbers are for representation of sequence.



**Figure 92. Removing expansion card from the expansion card riser**

4. If the expansion card is not going to be replaced, install a filler bracket and close the card retention latch.



**Figure 93. Installing the filler bracket**

#### **Next steps**

1. If applicable, install an expansion card into the expansion card riser.

# Installing an expansion card into the expansion card riser

## Prerequisites

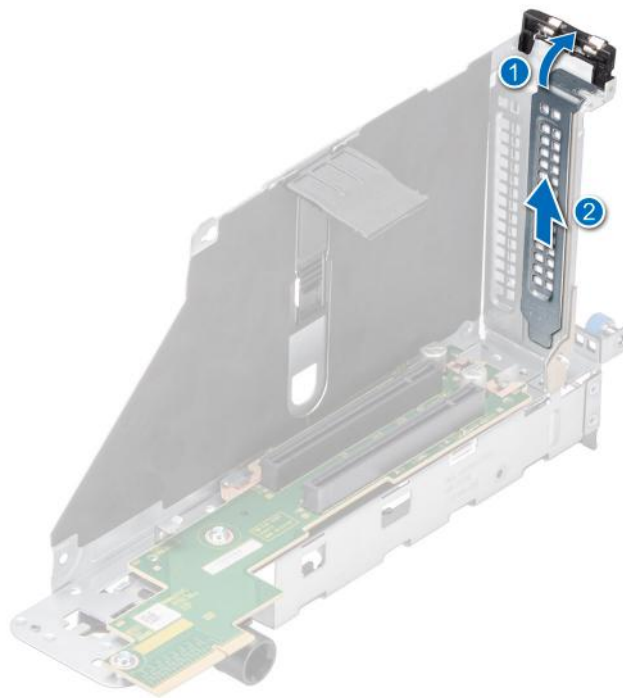
1. Follow the safety guidelines listed in the [Safety instructions](#).
2. Follow the procedure listed in [Before working inside your system](#).
3. [Remove the air shroud](#).
4. [Remove the expansion card riser](#).
5. If installing a new expansion card, unpack it and prepare the card for installation.

**i** **NOTE:** For instructions, see the documentation accompanying the card.

## Steps

1. Pull and lift up the expansion card retention latch lock to open.
2. If installed, remove the filler bracket.

**i** **NOTE:** Store the filler bracket for future use. Filler brackets must be installed in empty expansion card slots to maintain Federal Communications Commission (FCC) certification of the system. The brackets also keep dust and dirt out of the system and aid in proper cooling and airflow inside the system.

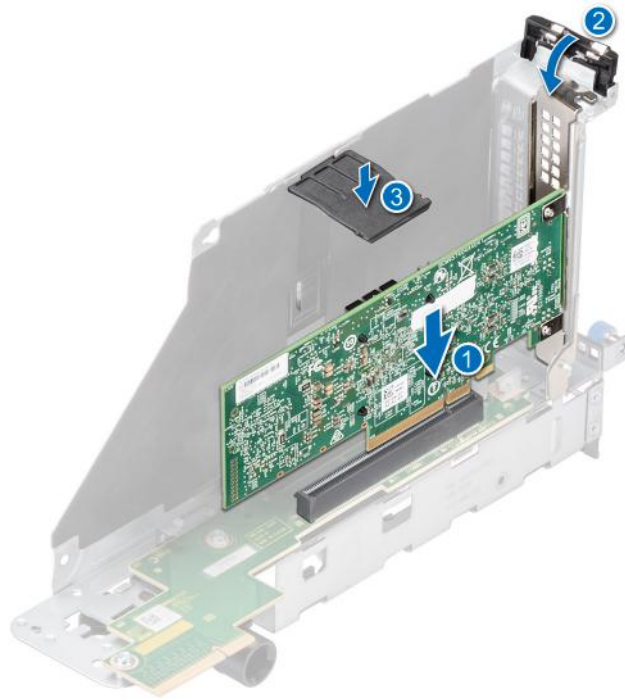


**Figure 94. Removing the filler bracket**

3. Hold the card by edges, and align the card with the connector on the riser.
4. Insert the card firmly into the expansion card connector until seated.
5. Close the expansion card retention latch.
6. Push the card holder to hold the card in the riser.

**i** **NOTE:** The numbers on the image do not depict the exact steps. The numbers are for representation of sequence.





**Figure 95. Installing an expansion card into the expansion card riser**

#### Next steps

1. If applicable, connect the cables to the expansion card.
2. [Install the expansion card riser](#) .
3. [Install the air shroud](#).
4. Follow the procedure listed in [After working inside your system](#).
5. Install any device drivers required for the card as described in the documentation for the card.

## Removing R1 and R4 paddle cards

#### Prerequisites

1. Follow the safety guidelines listed in the [Safety instructions](#).
2. Follow the procedure listed in the [Before working inside your system](#).
3. [Remove the air shroud](#).
4. [Remove cooling fan cage assembly](#).
5. Remove the paddle card cable from side wall bracket.
6. Disconnect the power cable connected on the paddle card.

**NOTE:** Observe the cable routing before disconnecting the cables.

**NOTE:** It is not recommended to disconnect paddle card slimline cables from the GPU riser modules, only disconnect from the system board.

#### Steps

Press the blue release tab on the paddle card and holding the edges lift the paddle card from the riser connector on the system board.

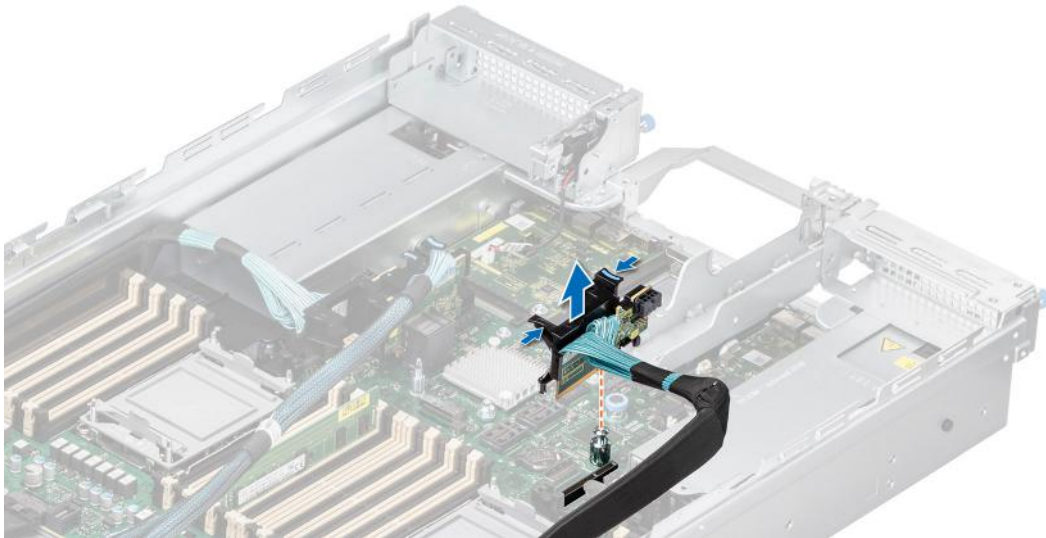


Figure 96. Removing the R1 paddle card

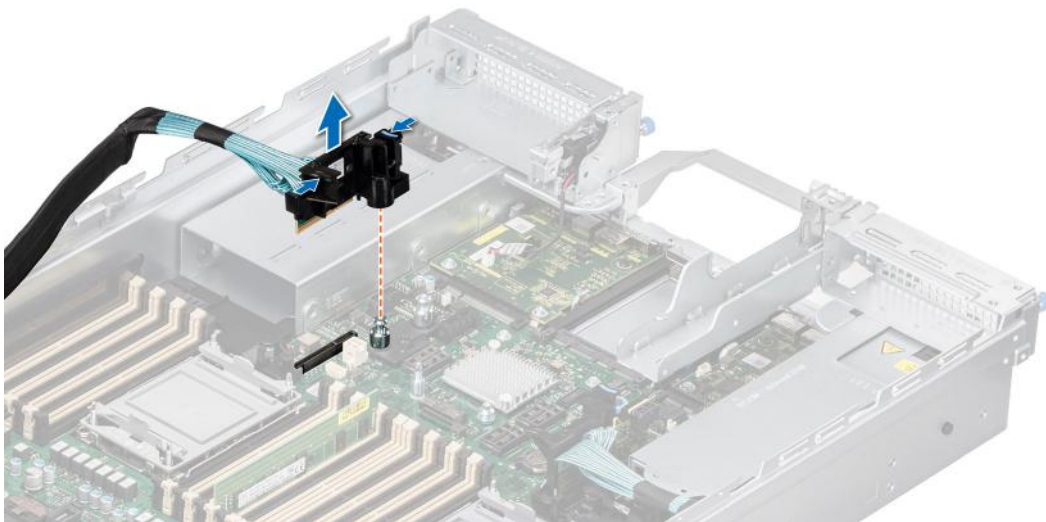



Figure 97. Removing the R4 paddle card

#### Next steps

1. Install the R1 and R4 paddle cards.

## Installing R1 and R4 paddle cards

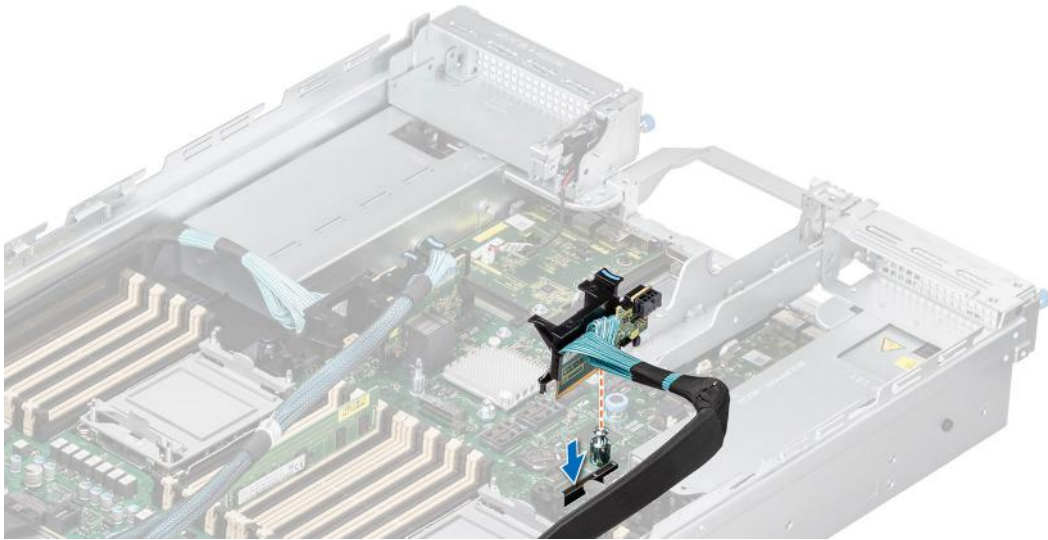
#### Prerequisites

1. Follow the safety guidelines listed in the [Safety instructions](#).
2. Follow the procedure listed in the [Before working inside your system](#).
3. [Remove the air shroud](#).
4. [Remove cooling fan cage assembly](#).
5.  **NOTE:** Observe the cable routing before disconnecting the cables.
5. Install the paddle card cable into side wall bracket.

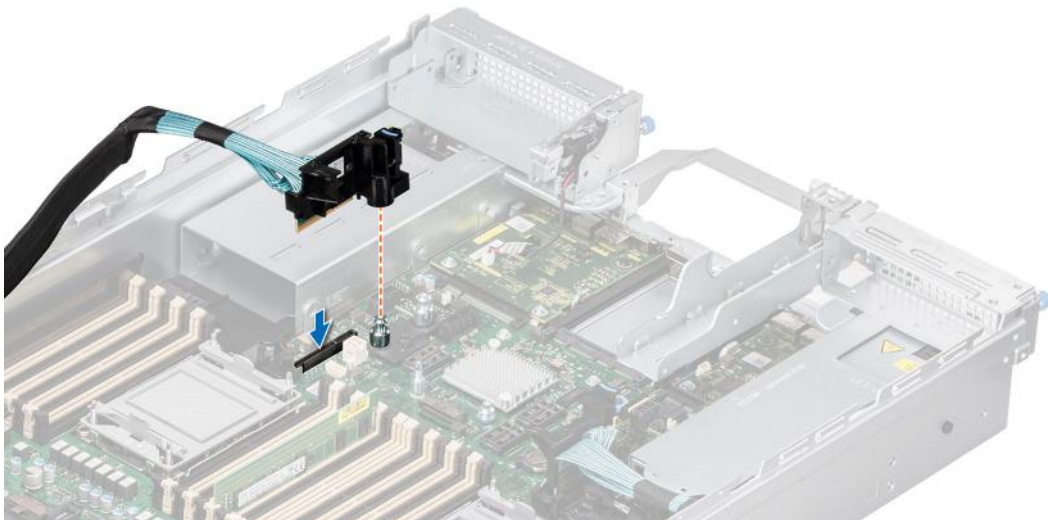
#### Steps

1. Holding the touch point edges, align the hole on the paddle card with the guides on the system board.

2. Lower the paddle card into place and press until the paddle card connector is fully seated with audible sound on the system board connector.



**Figure 98. Installing the R1 paddle card**



**Figure 99. Installing the R4 paddle card**

### Next steps

1. [Install cooling fan cage assembly](#)
2. [Install the air shroud.](#)
3. Follow the procedure listed in [After working inside your system.](#)

## Removing the R3 paddle card

### Prerequisites

1. Follow the safety guidelines listed in the [Safety instructions.](#)
2. Follow the procedure listed in the [Before working inside your system.](#)
3. If required, [remove the rear mounting front PERC module.](#)  
**i** **NOTE:** Observe the cable routing before disconnecting the cables.
4. Disconnect the paddle card slimline cable form the backplane.



5. Remove the paddle card slimline cable from cable access latch on cooling fan cage and also from the air shroud notch.

### Steps

Press the blue release tab on the paddle card and holding the edges lift the paddle card from the riser connector on the system board.

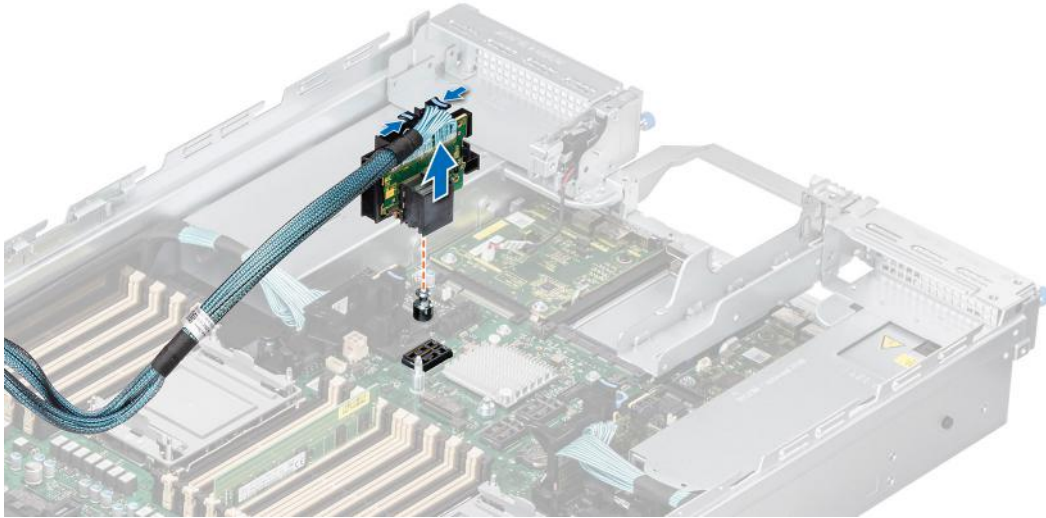



Figure 100. Removing the R3 paddle card

### Next steps

1. [Replace the R3 paddle card.](#)

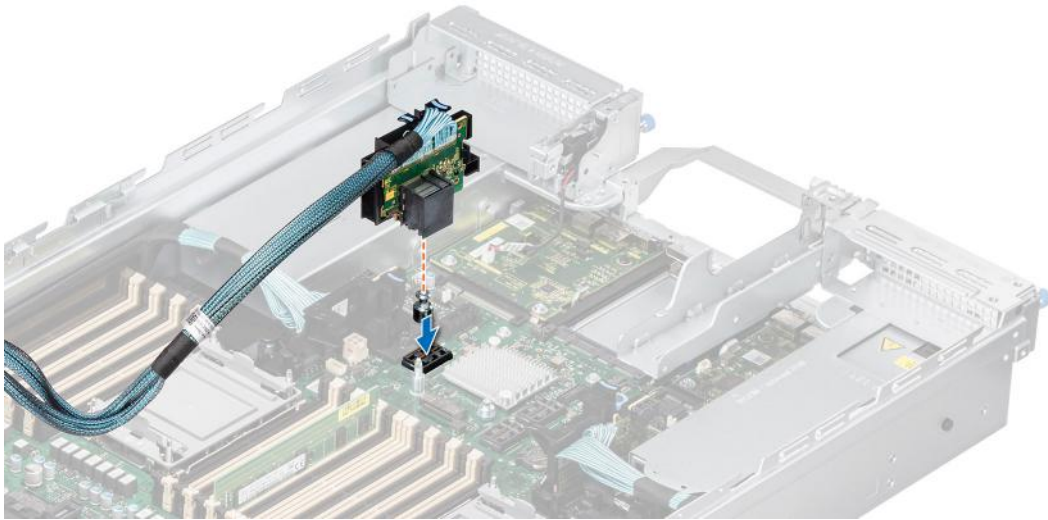
## Installing the R3 paddle cards

### Prerequisites

1. Follow the safety guidelines listed in the [Safety instructions](#).
2. Follow the procedure listed in the [Before working inside your system](#).
3. If required, [remove the rear mounting front PERC module](#).
4.  **NOTE:** Observe the cable routing before disconnecting the cables.
4. Connect the paddle card slimline cable to the backplane.

### Steps

1. Holding the touch point edges, align the hole on the paddle card with the guides on the system board.
2. Lower the paddle card into place and press until the paddle card connector is fully seated with audible sound on the system board connector.



**Figure 101. Installing the R3 paddle card**

### Next steps

1. Insert the paddle card slimline cable into the cable access latch on cooling fan cage and also through the air shroud notch.
2. If removed, [install the rear mounting front PERC module](#).
3. Follow the procedure listed in [After working inside your system](#).

## Replacing the GPU bracket

### Prerequisites

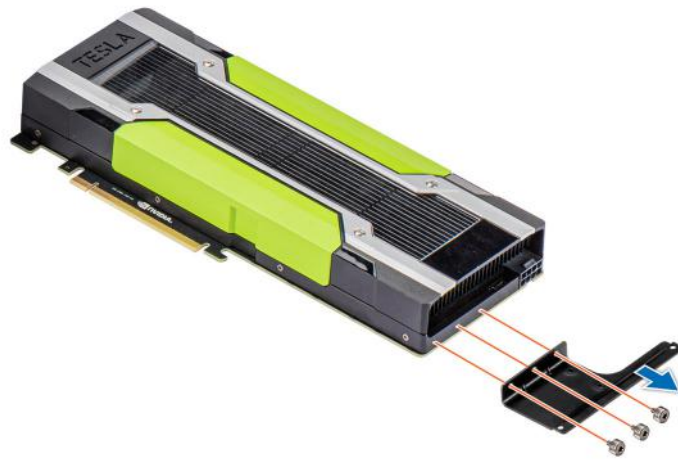
1. Follow the safety guidelines listed in the [Safety instructions](#).
2. Follow the procedure listed in [Before working inside your system](#).
3. If installing a new GPU card, unpack it and prepare the card for installation.  
**i** **NOTE:** For instructions, see the documentation accompanying the card.
4. New GPU cards are shipped with standard bracket, replace it with a custom bracket before installing.  
**i** **NOTE:** Based on the GPU card, use the appropriate custom bracket.

### Steps

1. Using Torx #T15 screwdriver loosen the torx screws and remove the standard bracket from the GPU card.

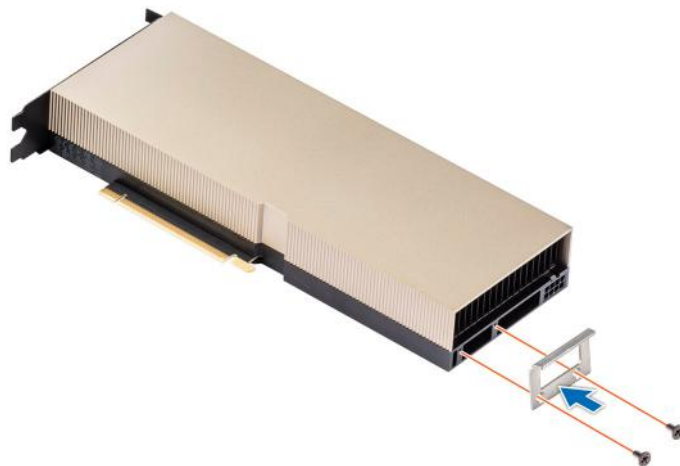


**Figure 102. Removing the standard bracket with two screws**

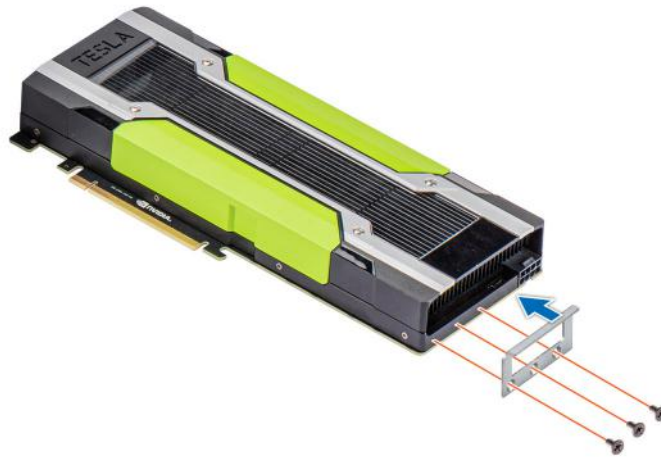


**Figure 103. Removing the standard bracket with three screws**

2. Align the custom bracket with the screw holes on the GPU card and using Philips #1 screwdriver tighten the screws ( $4 \pm 0.5$  in-lbs).



**Figure 104. Installing the custom bracket with two screws**



**Figure 105. Installing the custom bracket with three screws**

### Next steps

1. [Install the GPU card.](#)
2. Follow the procedure listed in [After working inside your system.](#)

## Removing the GPU riser module

The procedure to remove left and right GPU riser module are similar.

### Prerequisites

1. Follow the safety guidelines listed in the [Safety instructions.](#)
2. Follow the procedure listed in the [Before working inside your system.](#)
3. [Remove the air shroud.](#)
4. [Remove the cooling fan cage assembly.](#)
5. Disconnect the GPU power and signal cables from the system board.
6. Disconnect [R1 and R4 paddle cards](#) from the system board.
7. [Remove the rear mounting front PERC module.](#)
8. If installed, [remove the NVLink sponges.](#)

### Steps

1. Press the blue button on the GPU riser module, lift handle comes out of GPU riser module.
2. Use both hands, in one hand hold the lift handle, and in other hold the lifting edges to remove GPU riser module out of the system.


 **NOTE:** The numbers on the image do not depict the exact steps. The numbers are for representation of sequence.



Figure 106. Removing the right GPU riser module

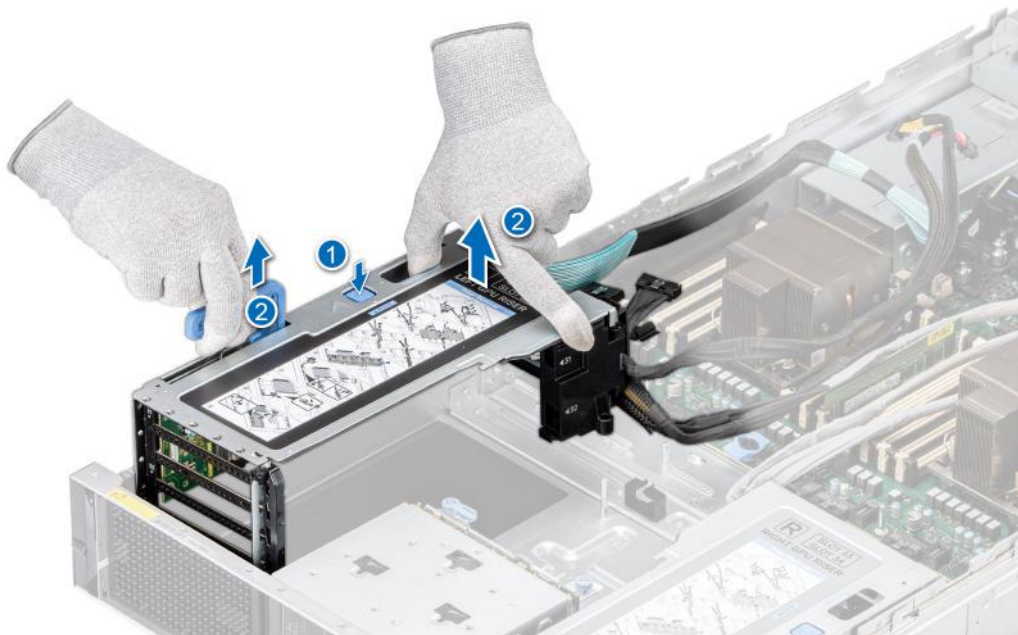


Figure 107. Removing the left GPU riser module

#### Next steps

1. Replace the GPU riser module.



# Installing the GPU riser module

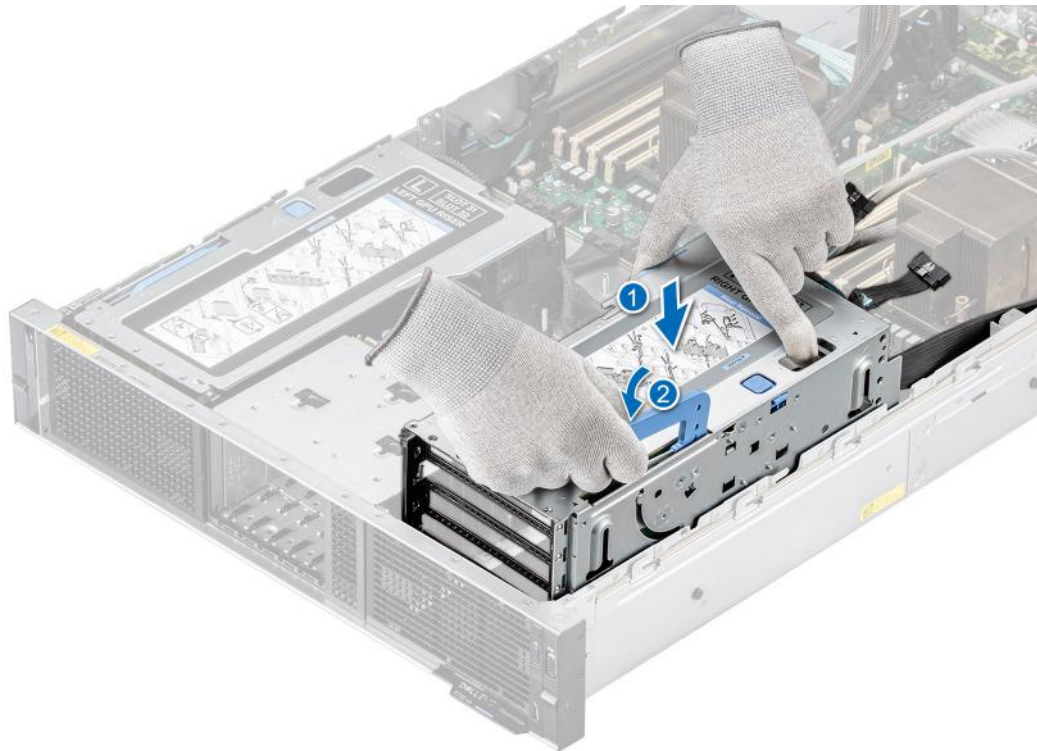
The procedure to install left and right GPU riser module are similar.

## Prerequisites

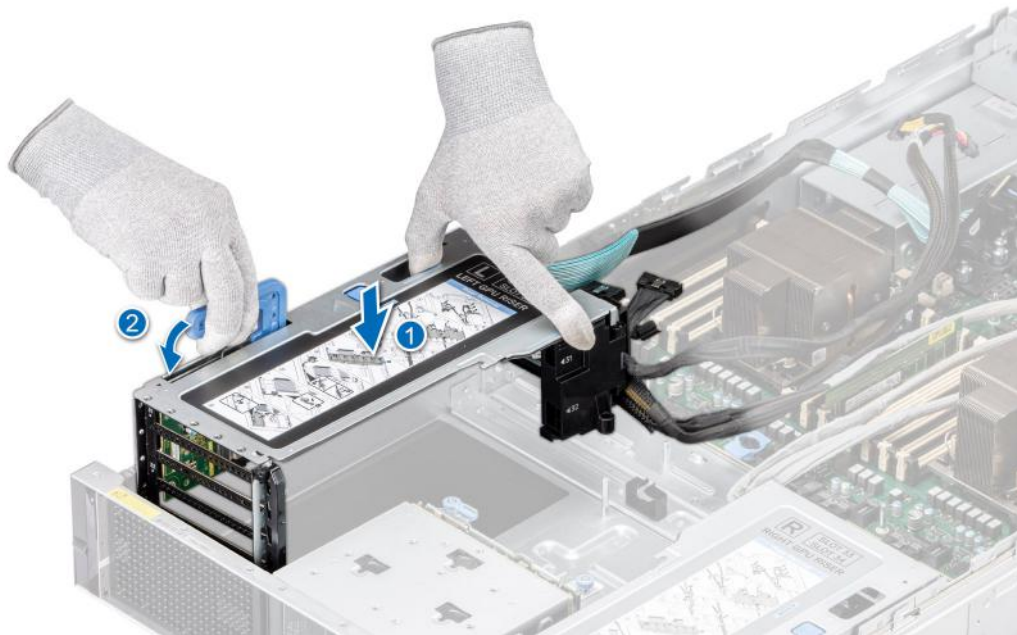
1. Follow the safety guidelines listed in the [Safety instructions](#).
2. Follow the procedure listed in [Before working inside your system](#).
3. [Remove the air shroud](#).
4. [Remove the cooling fan cage assembly](#).
5. Disconnect the GPU power and signal cables from the system board.
6. Disconnect [R1 and R4 paddle cards](#) from the system board.
7. [Remove the rear mounting front PERC module](#).
8. If installed, [remove the NVLink sponges](#).

## Steps

1. Use both hands to hold the GPU riser module, align the holes on the GPU riser module with the guides on the system side wall and base.
2. Lower the GPU riser module into system and press the touch points until the GPU riser module is firmly seated into the system.
3. Rotate to close the GPU lift handle into the GPU riser module.



**Figure 108. Installing the right GPU riser module**



**Figure 109. Installing the left GPU riser module**

### Next steps

1. If removed, [install the NVlink sponges](#).
2. [Install the rear mounting front PERC module](#).
3. Connect the GPU power and signal cables to the system board.
4. Connect the [R1 and R4 paddle cards](#) to the system board.
5. [Install the cooling fan cage assembly](#).
6. [Install the air shroud](#).
7. Follow the procedure listed in [After working inside your system](#).

## Removing the GPU

### Prerequisites

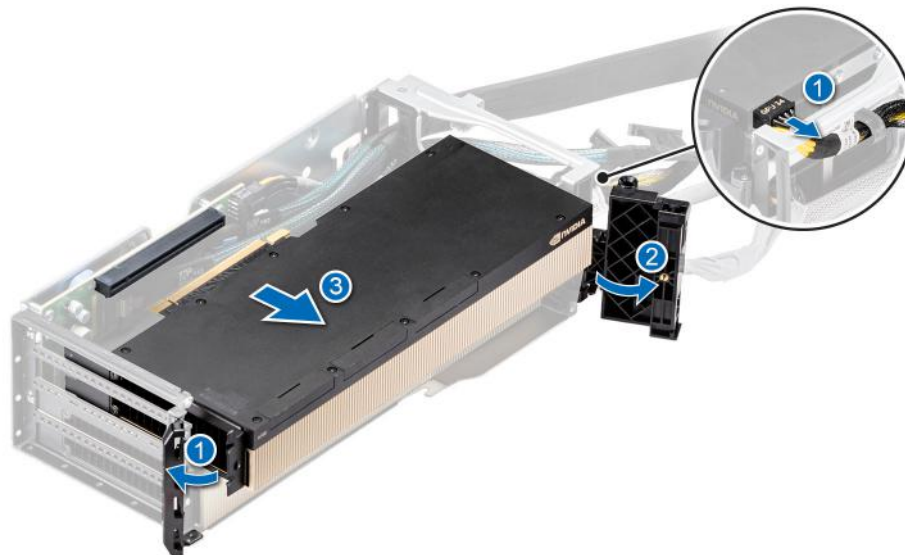
1. Follow the safety guidelines listed in the [Safety instructions](#).
2. Follow the procedure listed in the [Before working inside your system](#).
3. If installed, [remove the NVLink sponges](#).
4. [Remove the GPU riser module](#).
5. If installed, [remove the NVLink bridges](#).

### Steps

1. To remove the GPU from GPU riser module:
  - a. Disconnect the GPU power cable from the GPU card.
  - b. Open the GPU card holder latches on both ends of the riser.
  - c. Hold the GPU card by the edges and pull the card from the riser.

**NOTE:** The numbers on the image do not depict the exact steps. The numbers are for representation of sequence.





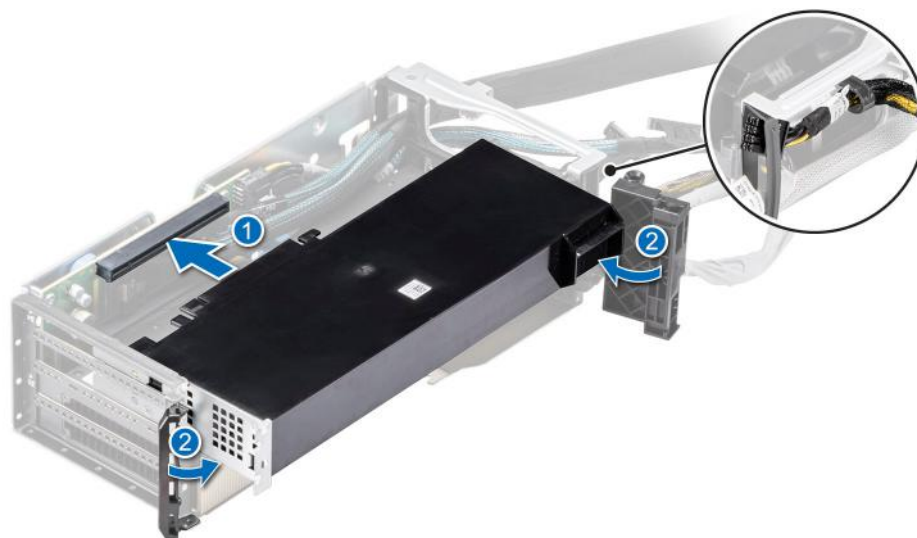
**Figure 110. Removing the GPU**

2. If you are not replacing the GPU card, install a GPU blank if the adjacent card is double-width card. Install filler blank, if the adjacent card is not double-width card.

**i** **NOTE:** You must install a GPU blank over an empty GPU card slot to maintain Federal Communications Commission (FCC) certification of the system. The blanks also keep dust and dirt out of the system and aid in proper cooling and airflow inside the system. The GPU blank is necessary to maintain proper thermal conditions.

3. To install the GPU blank:
  - a. Align the connector on the GPU blank with the connector on the riser.
  - b. Insert the GPU blank into the riser until firmly seated.
  - c. Close the GPU card holder latches on both ends of the riser.

**i** **NOTE:** Place the unused GPU power cable in the riser module bracket.



**Figure 111. Installing the GPU blank**

#### Next steps

1. [Replace the GPU.](#)

# Installing the GPU

## Prerequisites

1. Follow the safety guidelines listed in the [Safety instructions](#).
2. Follow the procedure listed in [Before working inside your system](#).
3. If installed, [remove the NVLink sponges](#).
4. [Remove the GPU riser module](#).
5. If installed, [remove the NVLink bridges](#).
6. If installing a new GPU card, unpack it and prepare the card for installation.

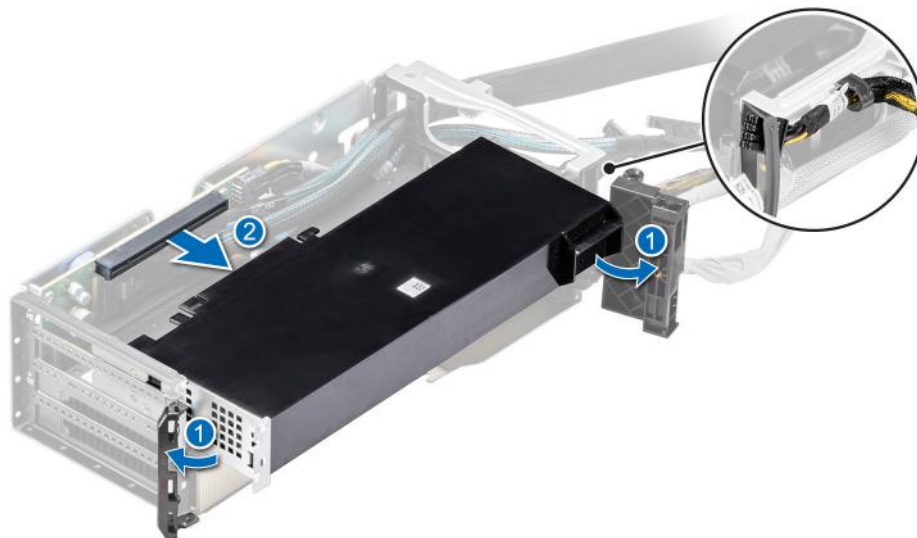
**i** **NOTE:** For instructions, see the documentation accompanying the card.

**△ CAUTION:** Do not install GPUs, network cards, or other PCIe devices on your system that are not validated and tested by Dell. Damage caused by unauthorized and invalidated hardware installation will null and void the system warranty.

## Steps

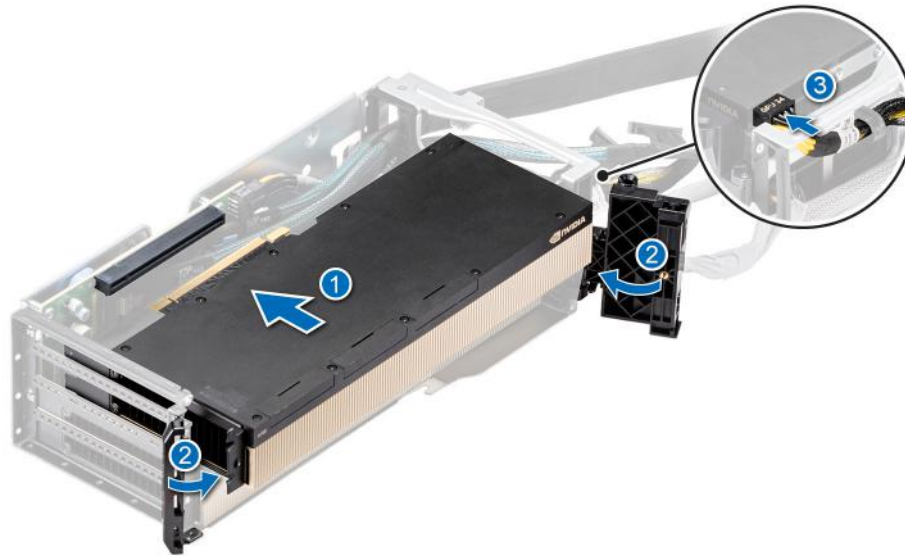
1. If installed, remove the GPU blank:
  - a. Open the GPU card holder latches on both ends of the riser.
  - b. Hold the GPU blank by the edges and pull the card from the riser.

**i** **NOTE:** Store the GPU blank for future use. GPU blank must be installed in empty expansion card slots to maintain Federal Communications Commission (FCC) certification of the system. The brackets also keep dust and dirt out of the system and aid in proper cooling and airflow inside the system.



**Figure 112. Removing the GPU blank**

2. To install the GPU on GPU riser module:
  - a. Align the connector on the GPU with the connector on the riser.
  - b. Insert the GPU into the riser until firmly seated.
  - c. Close the GPU card holder latches on both ends of the rise.
  - d. Connect the GPU power cable to the GPU card.



**Figure 113. Installing GPU on GPU riser module**

#### Next steps

1. If removed, [install the NVlink bridges](#).
2. [Install the GPU riser module](#).
3. If removed, [install the NVlink sponges](#).
4. Follow the procedure listed in [After working inside your system](#).

## Removing the NVLink sponges

#### Prerequisites

1. Follow the safety guidelines listed in the [Safety instructions](#).
2. Follow the procedure listed in the [Before working inside your system](#).
3. [Remove the rear mounting front PERC module](#).  
**i** **NOTE:** Observe the cable routing before disconnecting the cables.
4. NVLink sponges are required only for GPUs with NVLink bridges.

#### Steps

Using the hole on the NVLink sponge, lift the NVLink sponge out of the system.

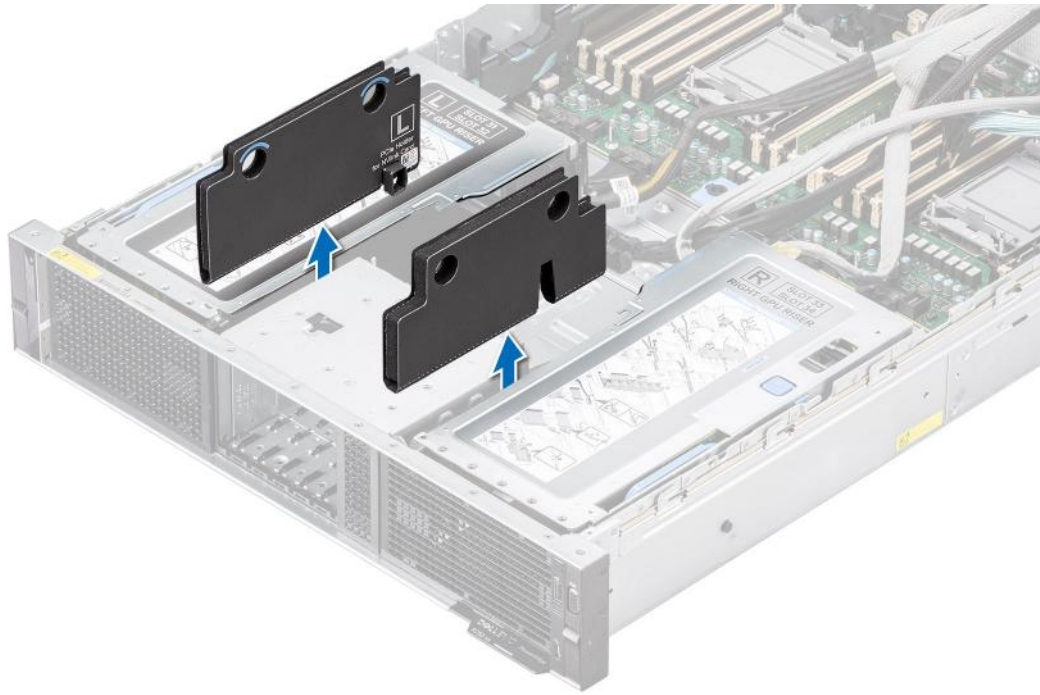


Figure 114. Removing the NVLink sponges

#### Next steps

1. [Replace the NVLink sponges.](#)

## Installing the NVLink sponges

#### Prerequisites

1. Follow the safety guidelines listed in the [Safety instructions](#).
2. Follow the procedure listed in [Before working inside your system](#).
3. [Remove the rear mounting front PERC module.](#)
  - i** **NOTE:** Observe the cable routing before disconnecting the cables.
4. NVLink sponges are required only for GPUs with NVLink bridges.

#### Steps

Holding the edges, align the NVLink sponge and insert between the drive cage and GPU riser module.

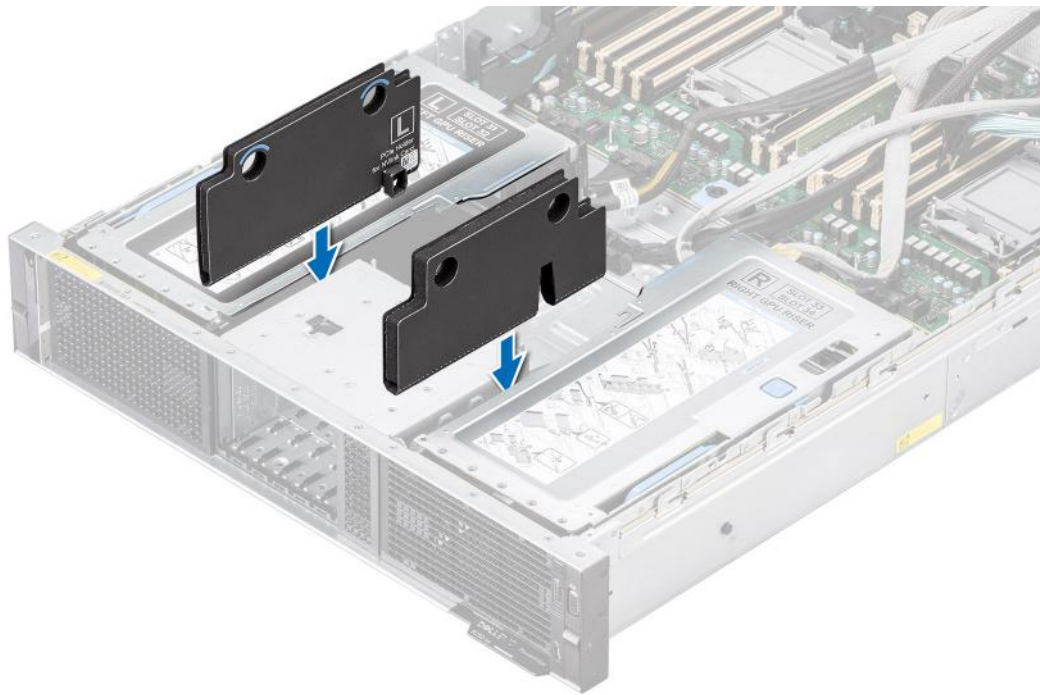


Figure 115. Installing the NVLink sponge

#### Next steps

1. [Install the rear mounting front PERC module.](#)
2. Follow the procedure listed in [After working inside your system.](#)

## Removing the NVLink bridges

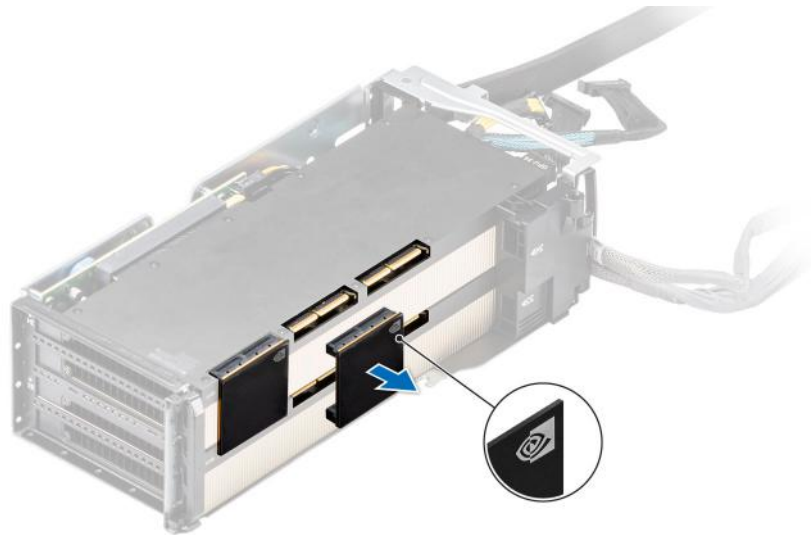
#### Prerequisites

1. Follow the safety guidelines listed in the [Safety instructions.](#)
  2. Follow the procedure listed in the [Before working inside your system.](#)
  3. [Remove the rear mounting front PERC module.](#)
- i** **NOTE:** Observe the cable routing before disconnecting the cables.
4. [Remove the NVLink sponges.](#)
  5. [Remove the GPU riser module.](#)
  6. Number of NVLink bridges vary as per the GPU.
  7. Slot priority for GPU card installation without NVLink bridges: slot 31, slot 33, slot 34, and slot 32.
  8. Slot priority for GPU card installation with NVLink bridges: slot 33, slot 34, slot 31, and slot 32.

**i** **NOTE:** For more information about supported GPU cards and their slot priority, see [expansion card installation guidelines.](#)

#### Steps

1. Holding the edges, pull the NVLink bridges out of the GPU cards.



**Figure 116. Removing the NVLink bridges**

2. If you are not replacing the NVLink bridge, Install the NVLink cover into the GPU card.



**Figure 117. Installing the NVLink cover**

### Next steps

1. [Replace the NVLink bridges.](#)

## Installing the NVLink bridges

### Prerequisites

1. Follow the safety guidelines listed in the [Safety instructions](#).
2. Follow the procedure listed in the [Before working inside your system](#).
3. [Remove the rear mounting front PERC module.](#)
  - NOTE:** Observe the cable routing before disconnecting the cables.
4. [Remove the NVLink sponges.](#)
5. [Remove the GPU riser module.](#)
6. If installed, take out the GPU card and remove the NVLink slot cover on the GPU card.
  - NOTE:** Store the NVLink slot cover for future use, install if not using NVLink bridges.
7. Number of NVLink bridges vary as per the GPU.
8. Slot priority for GPU card installation without NVLink bridges: slot 31, slot 33, slot 34, and slot 32.
9. Slot priority for GPU card installation with NVLink bridges: slot 33, slot 34, slot 31, and slot 32.



**NOTE:** For more information about supported GPU cards and their slot priority, see [expansion card installation guidelines](#).

### Steps

1. If installed, remove the NVLink cover from the GPU card.



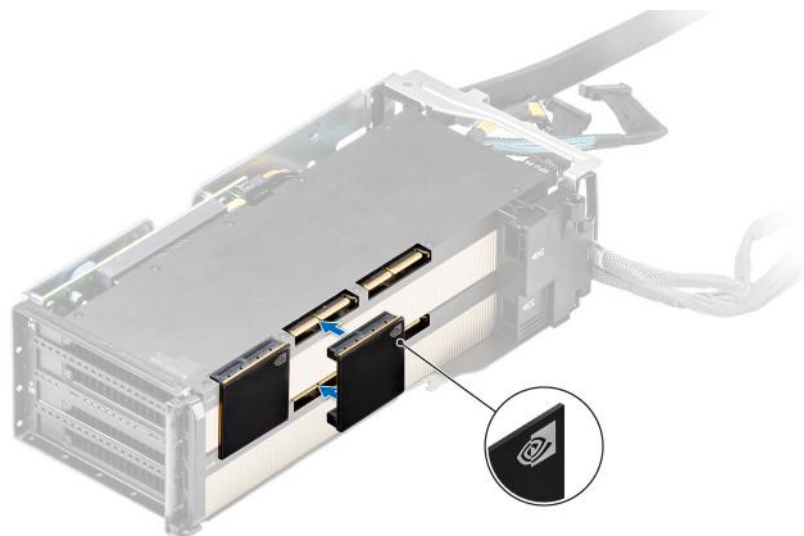
**Figure 118. Removing the NVLink cover**

**NOTE:** Store the NVLink cover for future use.

2. Align the NVLink bridges with the NVLink slot on the GPU cards.

**NOTE:** Ensure that the NVIDIA icon on the NVLink bridge is aligned with the NVIDIA icon on the slot 34 and slot 31 GPU card.

3. Press the NVLink bridges, until firmly seated on the GPU cards.



**Figure 119. Installing the NVLink bridges**

### Next steps

1. [Install the GPU riser module.](#)
2. [Install the NVlink sponges.](#)
3. [Install the rear mounting front PERC module.](#)
4. Follow the procedure listed in [After working inside your system.](#)



# Removing the GPU riser module card holders

## Prerequisites

1. Follow the safety guidelines listed in the [Safety instructions](#).
2. Follow the procedure listed in the [Before working inside your system](#).
3. [Remove the GPU riser module](#).

**NOTE:** Your system has either half height (HH) or full height (FH) or without GPU card holder, which is based on the type of GPU card used.

## Steps

Loosen the captive screw and pull out the HH or FH GPU card holder from the GPU riser module.

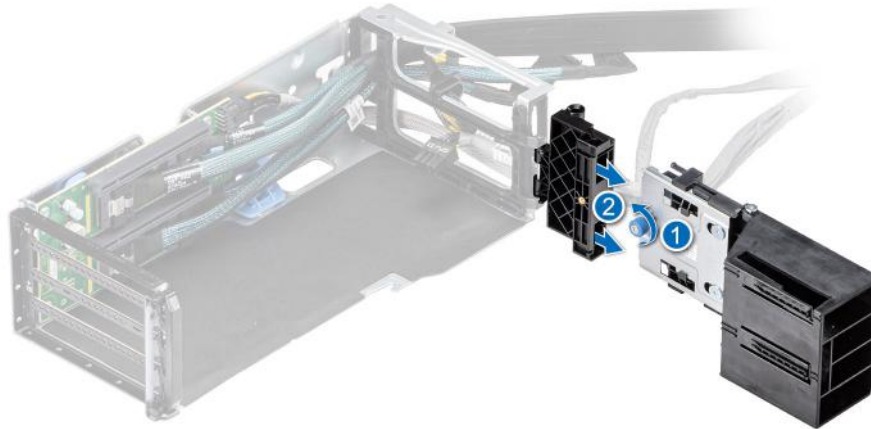


Figure 120. Removing the HH card holder

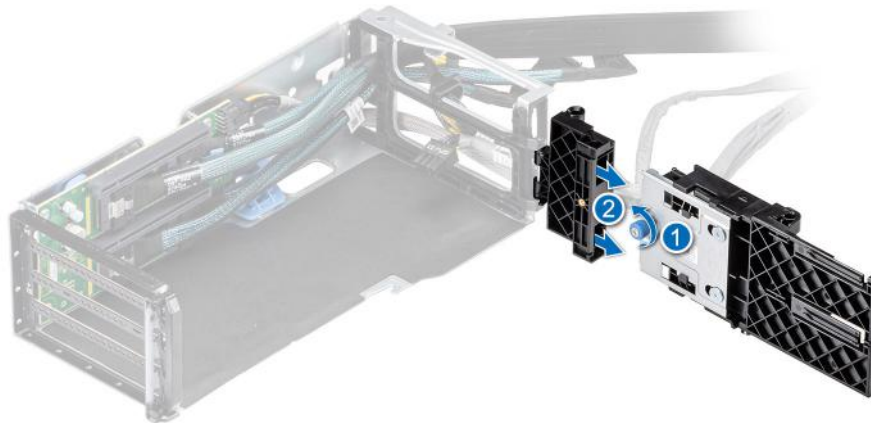


Figure 121. Removing the FH card holder

## Next steps

1. [Replace the GPU riser module holders](#).

# Installing the GPU riser module card holders

## Prerequisites

1. Follow the safety guidelines listed in the [Safety instructions](#).
2. Follow the procedure listed in the [Before working inside your system](#).

3. Remove the GPU riser module.

**NOTE:** Your system has either half height (HH) or full height (FH) or without GPU card holder, which is based on the type of GPU card used.

**Steps**

Insert the HH or FH GPU card holder into the GPU riser module and tighten the captive screw.

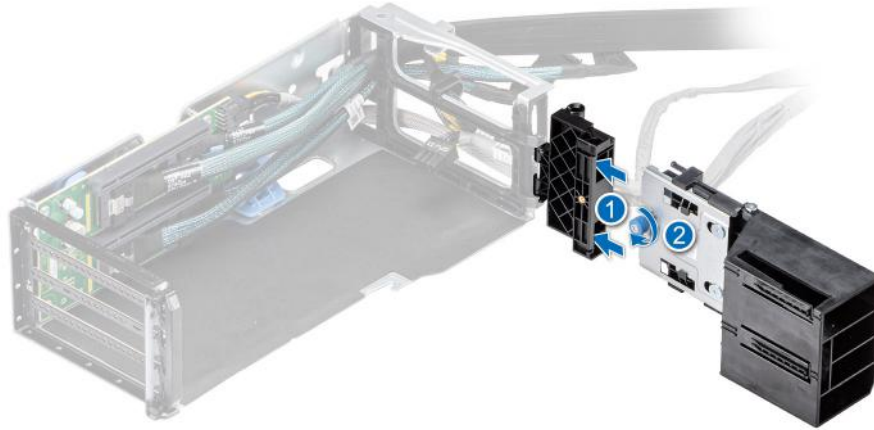


Figure 122. Installing the HH card holder

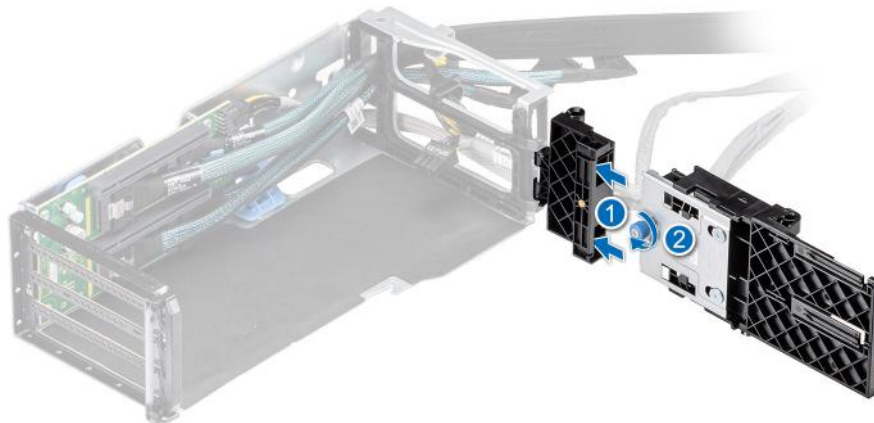


Figure 123. Installing the FH card holder

**Next steps**

1. Install the GPU riser module.
2. Follow the procedure listed in [After working inside your system.](#)

# Optional serial COM port

This is a service technician replaceable part only.

## Removing the serial COM port

The procedure to remove serial COM port from Riser 2 is same.

### Prerequisites

1. Follow the safety guidelines listed in the [Safety instructions](#).
2. Follow the procedure listed in the [Before working inside your system](#).
3. [Remove the air shroud](#).

### Steps

1. Loosen the captive screws on the system.
2. Press the blue release tab or blue button on the riser and holding the edges lift the expansion card riser from the riser connector on the system board.
3. Disconnect the serial COM port cable from the rear I/O board.

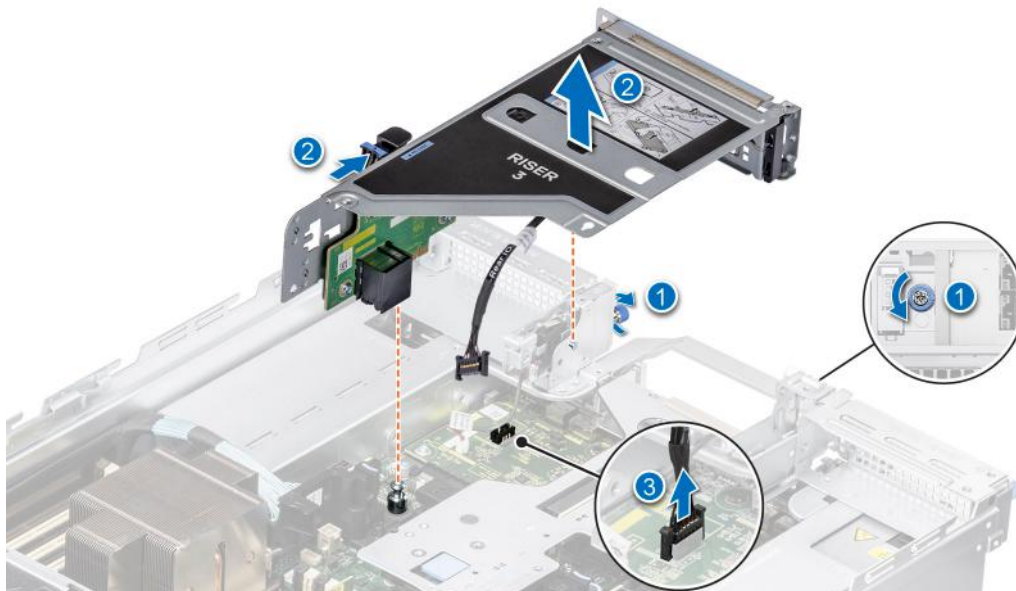
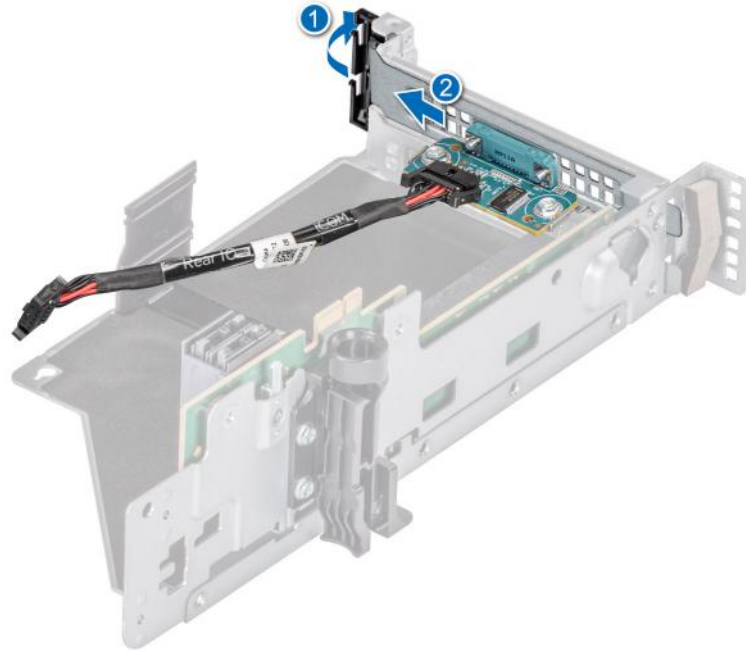


Figure 124. Disconnecting the serial COM port

4. Open the latch on the expansion card riser and slide the serial COM port out of the expansion card riser.



**Figure 125. Removing the Serial COM port**

5. Install the filler bracket if not replacing the serial COM port.

**Next steps**

1. [Replace the serial COM port.](#)

## Installing the serial COM port

The procedure to install serial COM port on Riser 2 is same.

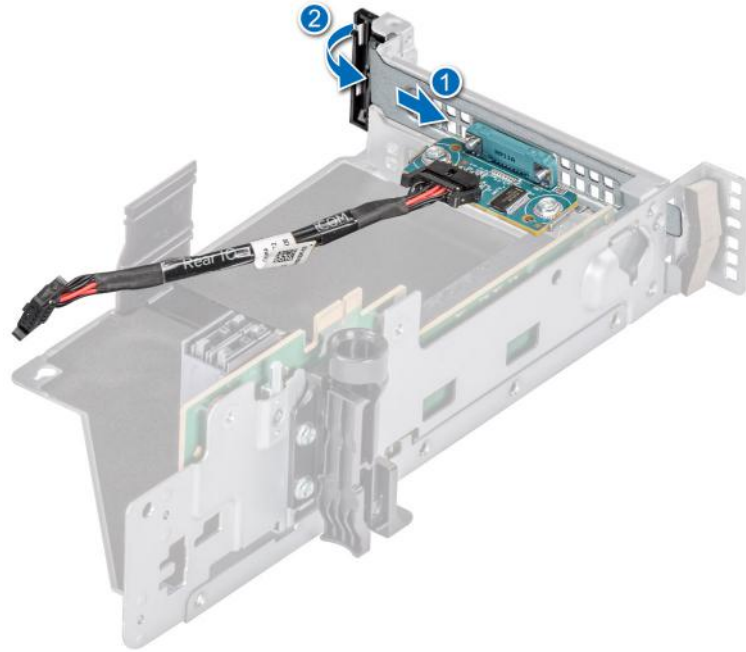
**Prerequisites**

1. Follow the safety guidelines listed in the [Safety instructions](#).
2. Follow the procedure listed in the [Before working inside your system](#).
3. [Remove the air shroud](#).

**NOTE:** The serial port is supported only in slot 4, slot 5 or slot 6 of the expansion card riser.

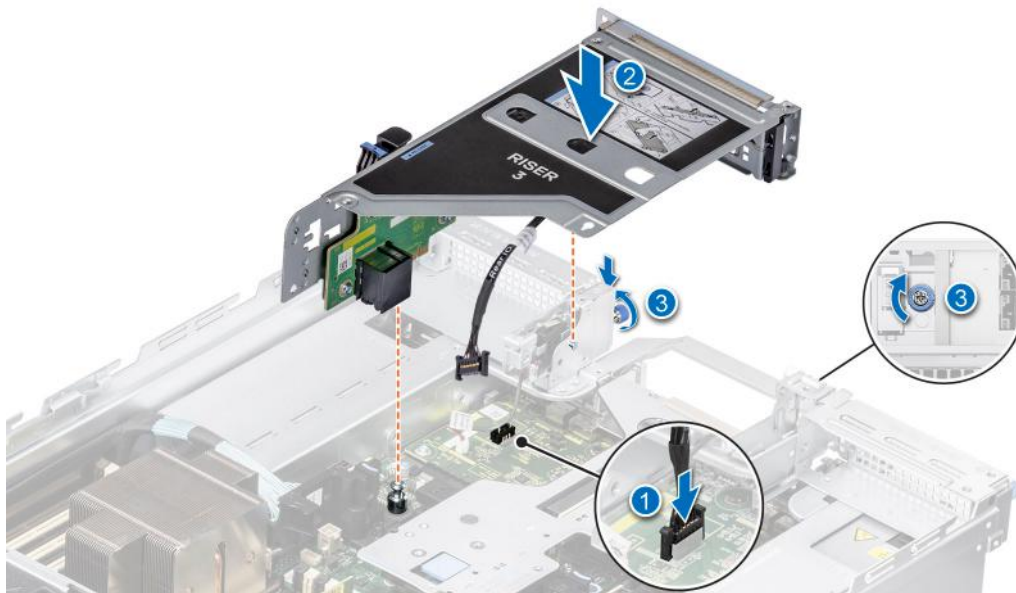
**Steps**

1. Open the latch on the expansion card riser and remove the filler bracket from the expansion card riser.
2. Slide the serial COM port into the expansion card riser and close the latch.



**Figure 126. Installing the Serial COM port**

3. Connect the serial COM port cable to the rear I/O board.
4. Holding the edges or the touch points, align the holes on the expansion card riser with the guides on the system board.
5. Lower the expansion card riser into place and press the touch points until the expansion card riser connector is fully seated on the system board connector.
6. Tighten the captive screws on the system.



**Figure 127. Connecting the serial COM port**

**Next steps**

1. [Install the air shroud.](#)
2. Follow the procedure listed in [After working inside your system.](#)

# Optional VGA port for liquid cooling module

## Removing the VGA port

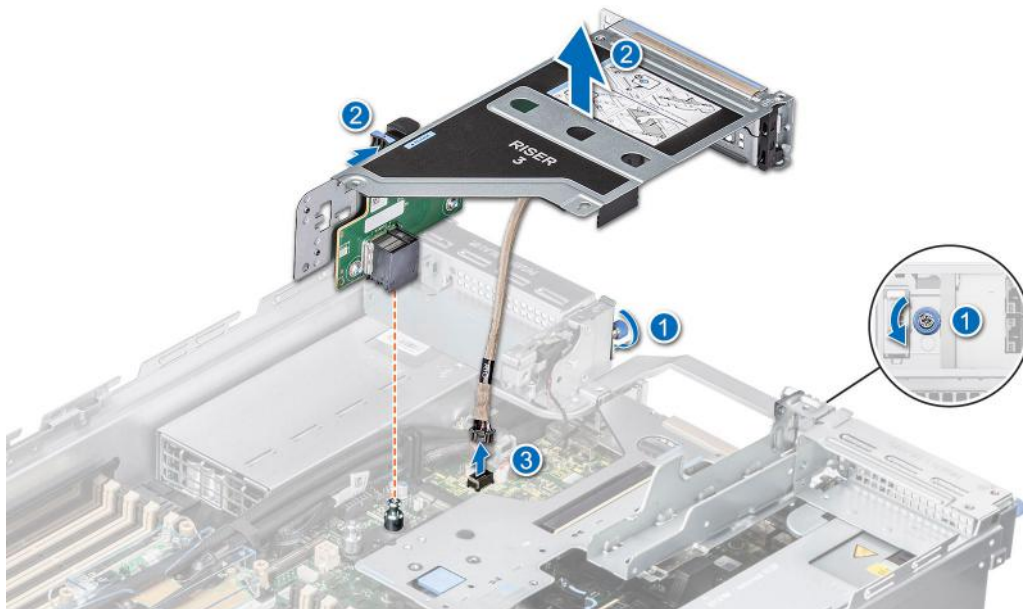
The procedure to remove VGA port from Riser 2 is same.

### Prerequisites

1. Follow the safety guidelines listed in the [Safety instructions](#).
2. Follow the procedure listed in the [Before working inside your system](#).
3. [Remove the air shroud](#).

### Steps

1. Loosen the captive screws on the system.
2. Press the blue release tab or blue button on the riser and holding the edges lift the expansion card riser from the riser connector on the system board.
3. Disconnect the VGA port cable from the liquid cooling (LC) rear I/O board.



**Figure 128. Disconnecting the VGA port cable**

4. Open the latch on the expansion card riser and slide the VGA port out of the expansion card riser.





**Figure 129. Removing the VGA port**

5. Install the filler bracket if not replacing the VGA port.

#### **Next steps**

1. [Replace the VGA port.](#)

## **Installing the VGA port**

The procedure to install VGA port on Riser 2 is same.

#### **Prerequisites**

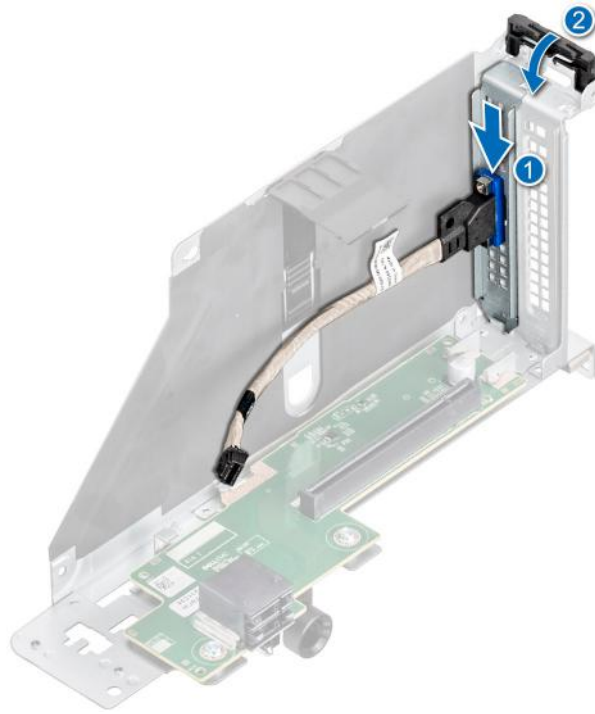
1. Follow the safety guidelines listed in the [Safety instructions](#).
2. Follow the procedure listed in [Before working inside your system](#).
3. [Remove the air shroud](#).

**i** **NOTE:** VGA port is supported only in slot 4, slot 5 or slot 6 of the expansion card riser.

#### **Steps**

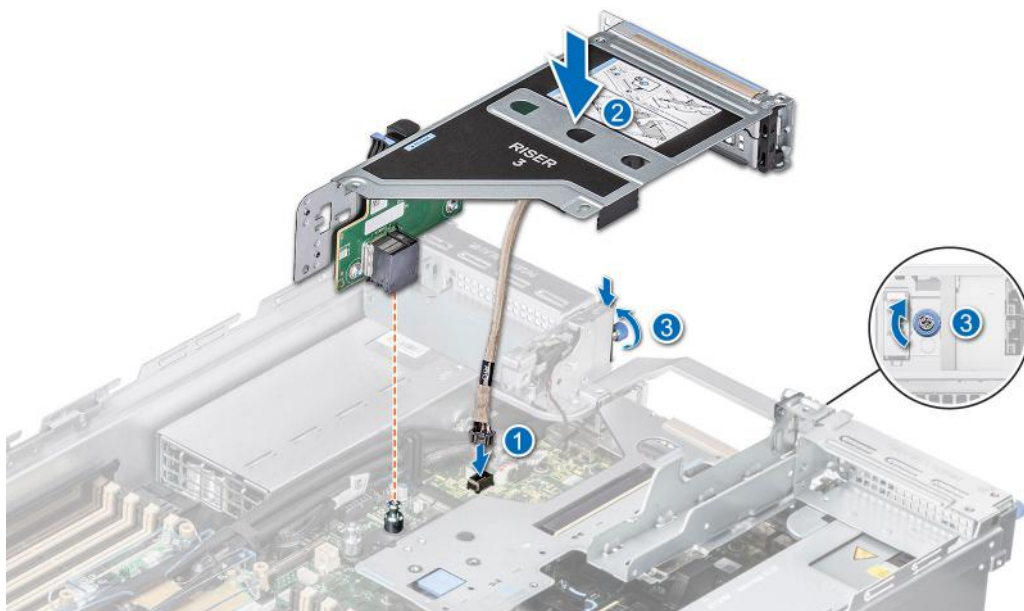
1. Open the latch on the expansion card riser and remove the filler bracket from the expansion card riser.
2. Slide the VGA port into the expansion card riser and close the latch.





**Figure 130. Installing the VGA port**

3. Connect the VGA port cable to the LC rear I/O board.
4. Holding the edges or the touch points, align the holes on the expansion card riser with the guides on the system board.
5. Lower the expansion card riser into place and press the touch points until the expansion card riser connector is fully seated on the system board connector.
6. Tighten the captive screws on the system.



**Figure 131. Connecting the VGA port cable**

**Next steps**

1. [Install the air shroud.](#)
2. Follow the procedure listed in [After working inside your system.](#)

# Optional IDSDM module

## Removing the IDSDM module

### Prerequisites

1. Follow the safety guidelines listed in the [Safety instructions](#).
  2. Follow the procedure listed in the [Before working inside your system](#).
  3. If you are replacing the IDSDM module, [remove the MicroSD cards](#).
- NOTE:** Temporarily label each SD card with its corresponding slot number before removal. Reinstall the SD cards into the corresponding slots.

### Steps

Holding the blue pull tab, lift the IDSDM module out of the system.

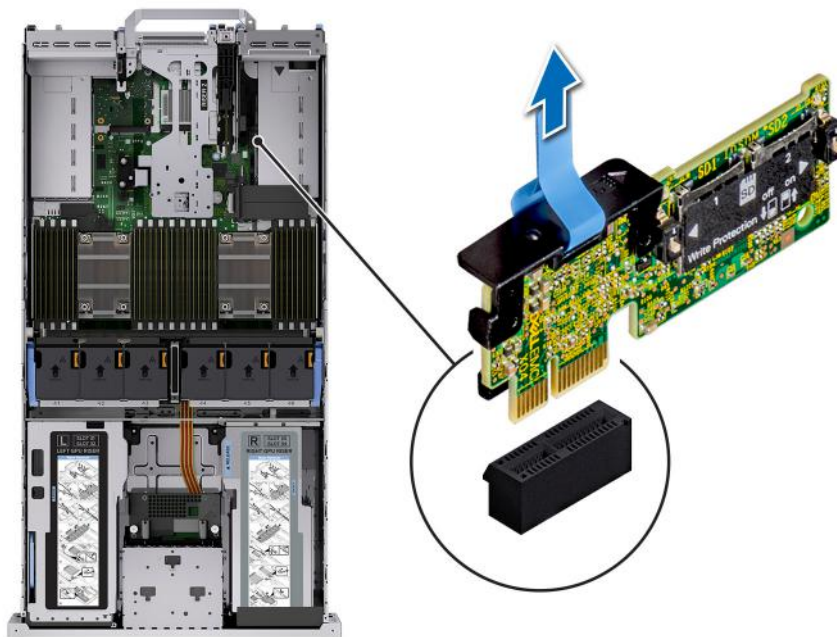


Figure 132. Removing the IDSDM module

### Next steps

1. [Replace the IDSDM module](#).

## Installing the IDSDM module

### Prerequisites

1. Follow the safety guidelines listed in the [Safety instructions](#).
2. Follow the procedure listed in [Before working inside your system](#).

### Steps

1. Locate the IDSDM connector on the system board.

**NOTE:** For information on the exact location of IDSDM on system board, see [System board jumpers and connector](#) section.

2. Align IDSDM module with the connector on the system board.

3. Press the IDSDM module until firmly seated on the system board.

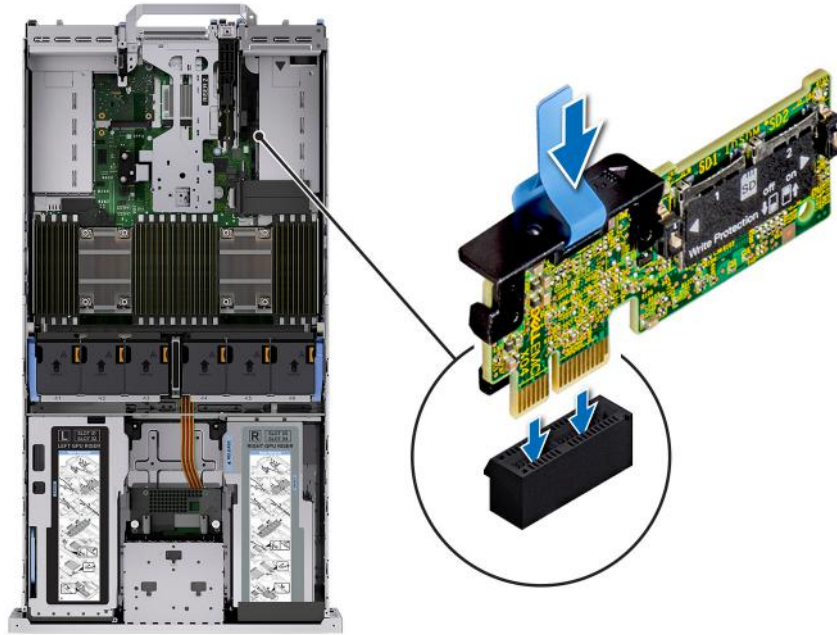


Figure 133. Installing the IDSDM module

#### Next steps

1. [Install the MicroSD cards.](#)  
**NOTE:** Reinstall the Micro-SD cards into the same slots based on the labels you had marked on the cards during removal.
2. Follow the procedure listed in [After working inside your system.](#)

## MicroSD card

### Removing the MicroSD card

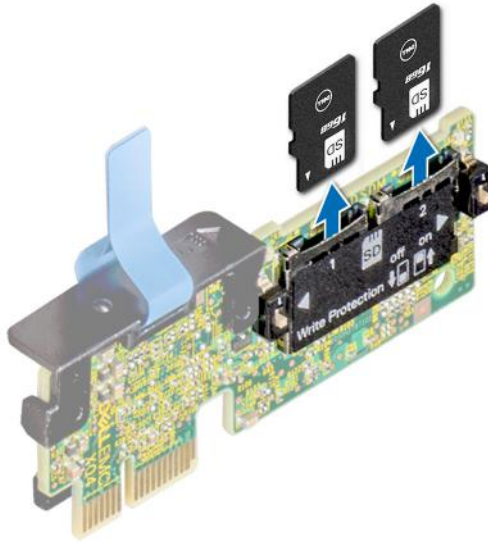
#### Prerequisites

1. Follow the safety guidelines listed in the [Safety instructions.](#)
2. Follow the procedure listed in the [Before working inside your system.](#)
3. [Remove the IDSDM module.](#)

#### Steps

1. Locate the MicroSD card slot on the IDSDM module, and press the card to partially release it from the slot. For more information on the IDSDM module location, see [System board jumpers and connectors](#) section.
2. Hold the MicroSD card, and remove it from the IDSDM module.

**NOTE:** Temporarily label each MicroSD card with the corresponding slot number after removal.



**Figure 134. Removing the MicroSD card**

### Next steps

1. [Replace the MicroSD cards.](#)

## Installing the MicroSD card

### Prerequisites

1. Follow the safety guidelines listed in the [Safety instructions](#).
2. Follow the procedure listed in [Before working inside your system](#).

**NOTE:** To use an MicroSD card with your system, ensure that the **Internal SD Card Port** is enabled in System Setup.

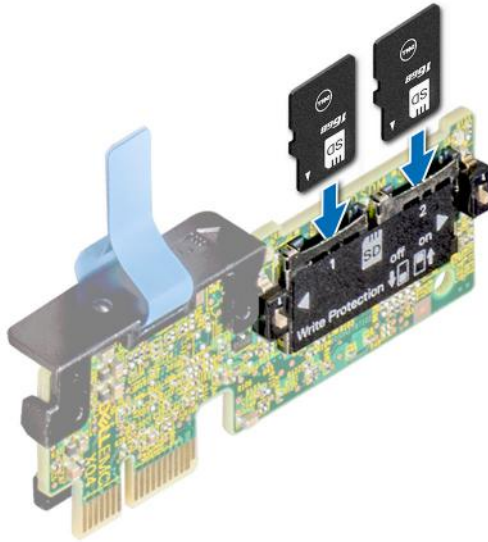
**NOTE:** Ensure that you install the MicroSD cards into the same slots based on the labels you had marked on the cards during removal.

### Steps

1. Locate the MicroSD card slot on the IDSDM module. Orient the MicroSD card appropriately and insert the contact-pin end of the card into the slot. To locate IDSDM, see the [System board jumpers and connectors](#) section.

**NOTE:** The slot is keyed to ensure correct insertion of the card.

2. Press the card into the slot to lock it into place.



**Figure 135. Installing the MicroSD card**

#### Next steps

1. [Install the IDSDM module.](#)
2. Follow the procedure listed in [After working inside your system.](#)

## M.2 SSD module

### Removing the M.2 SSD module

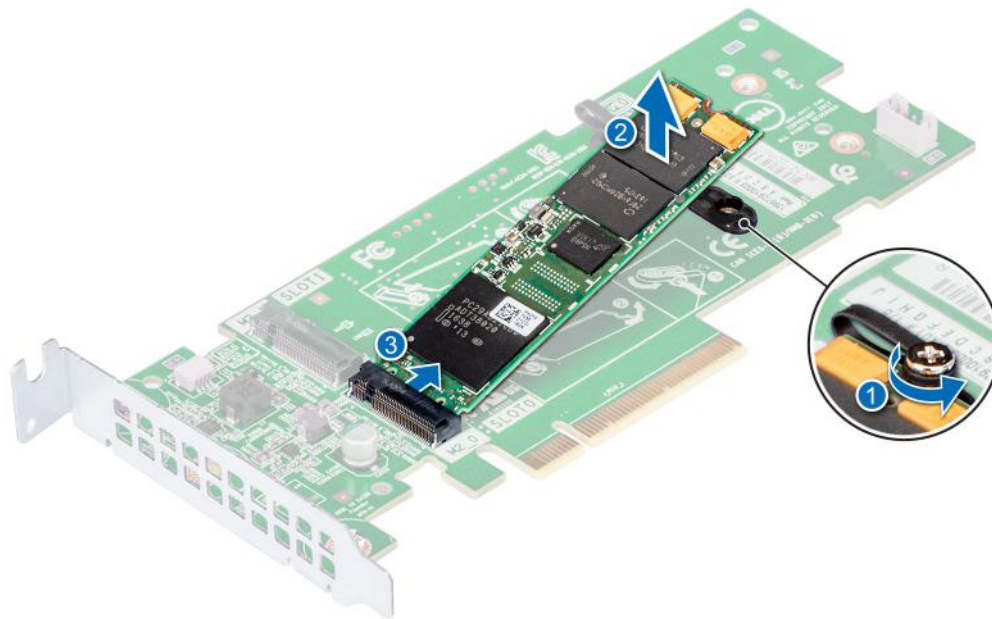
#### Prerequisites

1. Follow the safety guidelines listed in the [Safety instructions.](#)
2. Follow the procedure listed in the [Before working inside your system.](#)
3. [Remove the air shroud.](#)
4. Remove the BOSS card.

**NOTE:** Removing the BOSS card is similar to the procedure for [Removing an expansion card from expansion card riser](#)

#### Steps

1. Loosen the screws and lift the retention straps that secure the M.2 SSD module on the BOSS card.
2. Pull the M.2 SSD module away from the BOSS card.



**Figure 136. Removing the M.2 SSD module**

- a. module connector (2)
- b. screws (2)
- c. module (2)

#### **Next steps**

Installing the M.2 SSD module.

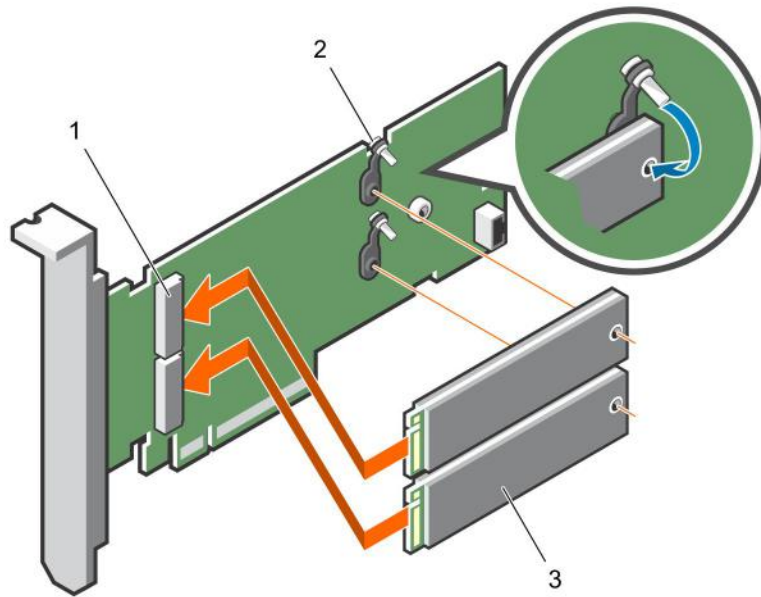
## **Installing the M.2 SSD module**

#### **Prerequisites**

1. Follow the safety guidelines listed in the [Safety instructions](#).

#### **Steps**

1. Align the M.2 SSD module connectors with the connectors on the BOSS card.
2. Push the M.2 SSD module until the module is seated firmly on the BOSS card.
3. Secure the M.2 SSD module on the BOSS card with the retention straps and screws.



**Figure 137. Installing the M.2 SSD module**

- a. module connector (2)
- b. screws (2)
- c. modules (2)

#### Next steps

1. Install the BOSS card.
  - i** **NOTE:** Installing the BOSS card is similar to installing the expansion card riser.
2. Install the air shroud.
3. Follow the procedure listed in [After working inside your system](#).

## Optional BOSS S2 module

### Removing the BOSS S2 module blank

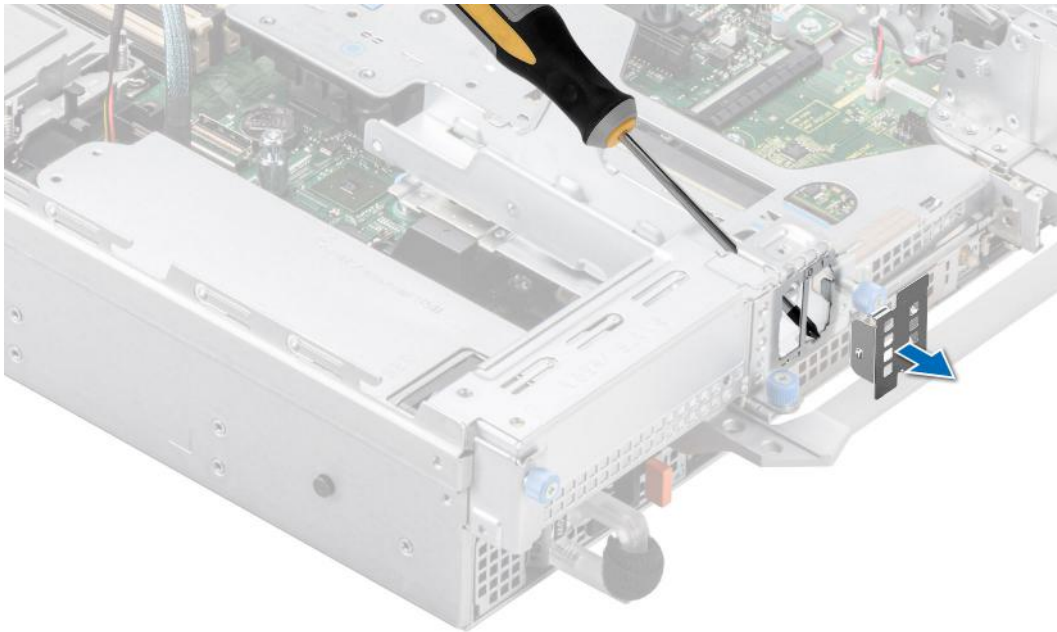
#### Prerequisites

Follow the safety guidelines listed in the [Safety instructions](#).

#### Steps

Use a screwdriver to push out the blank from the BOSS S2 module bay.





**Figure 138. Removing the BOSS S2 module blank**

**Next steps**

1. Replace the BOSS S2 module blank or install BOSS S2 module.

## Installing the BOSS S2 module blank

**Prerequisites**

1. Follow the safety guidelines listed in the [Safety instructions](#).

**Steps**

Align the blank with the BOSS S2 module bay and push it into the bay until it clicks into place.

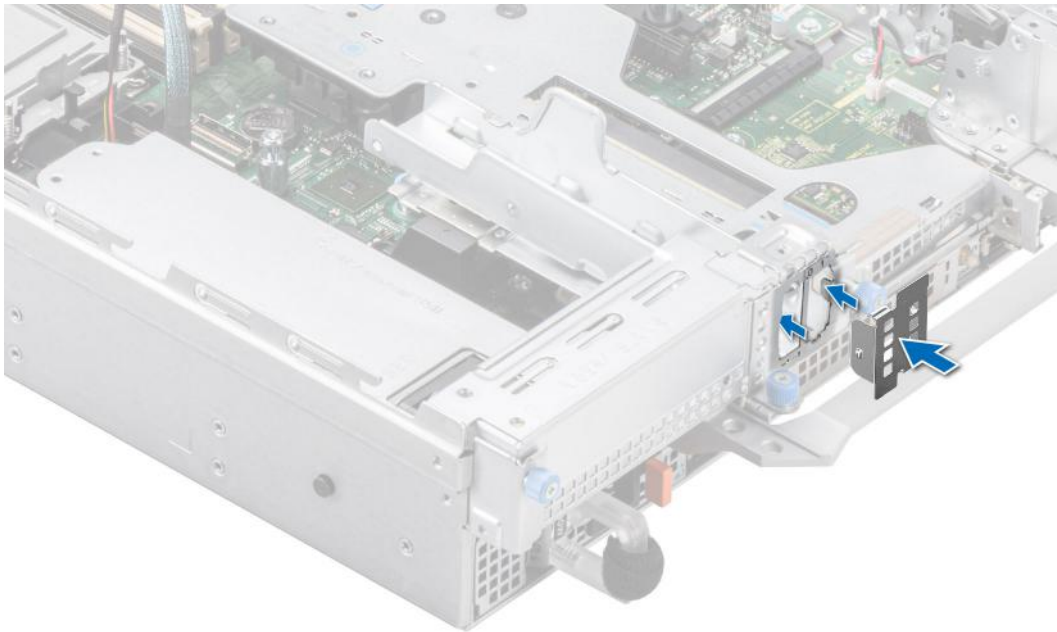


Figure 139. Installing the BOSS S2 module blank

## Removing the BOSS S2 card carrier blank

### Prerequisites

Follow the safety guidelines listed in the [Safety instructions](#).

### Steps

Press and pull the BOSS S2 card carrier blank out from the BOSS S2 module.

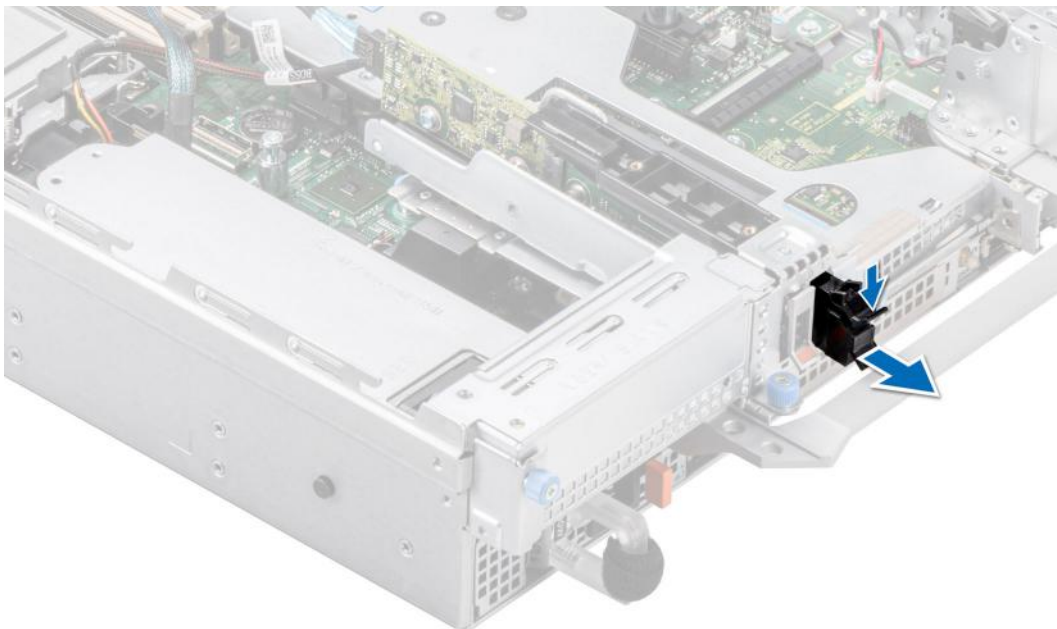


Figure 140. Removing the BOSS S2 card carrier blank

### Next steps

1. [Replace the BOSS S2 card carrier blank](#) or install BOSS S2 card carrier.

## Installing the BOSS S2 card carrier blank

### Prerequisites

1. Follow the safety guidelines listed in the [Safety instructions](#).

### Steps

Align the blank with the BOSS S2 module bay and push it into the bay until it clicks into place.

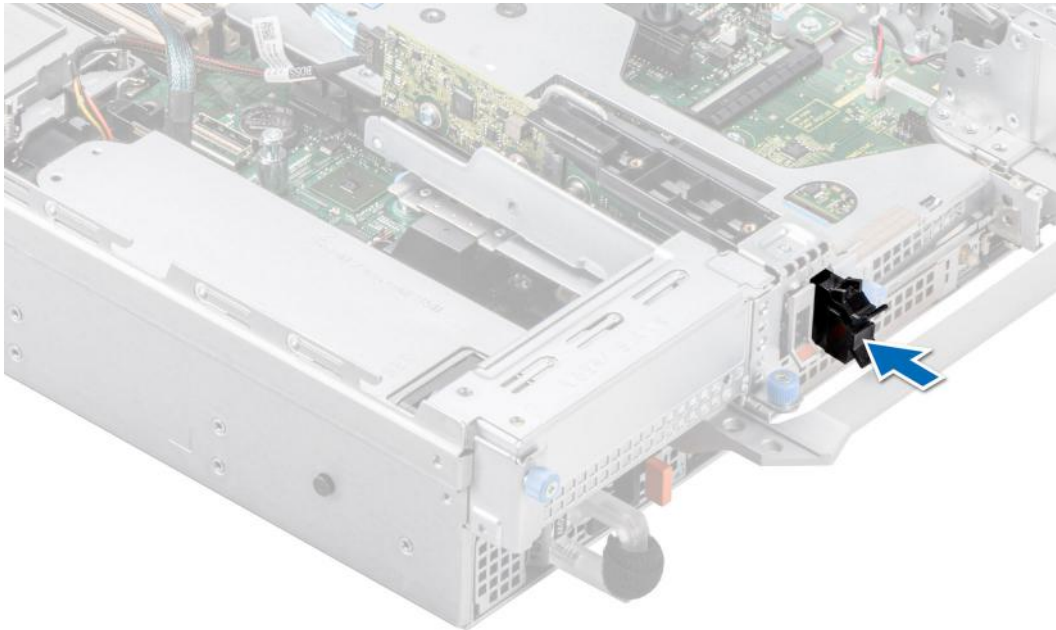


Figure 141. Installing the BOSS S2 card carrier blank

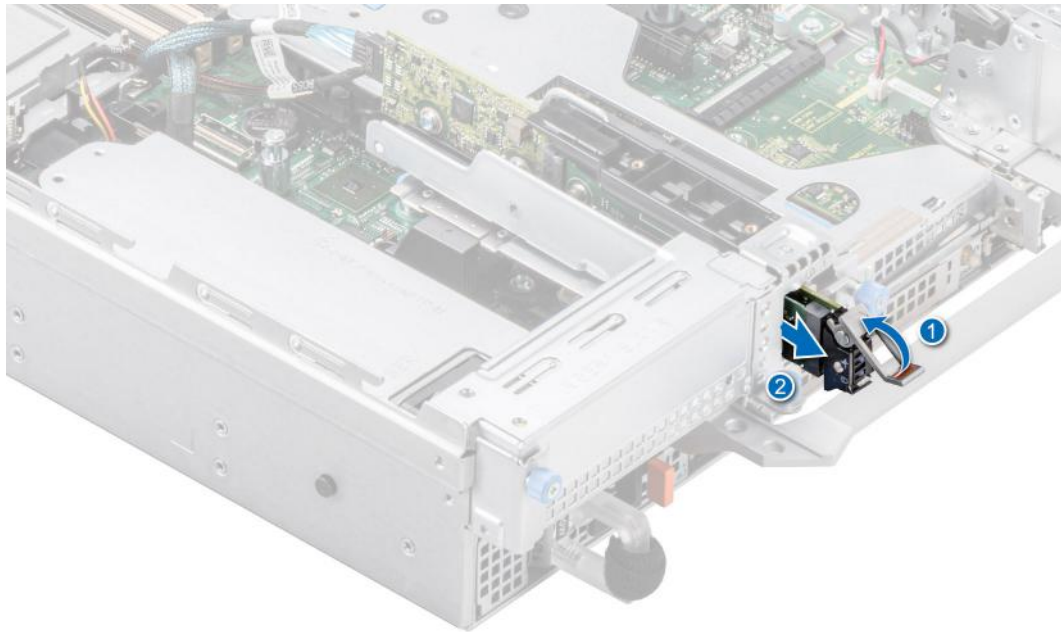
## Removing the BOSS S2 module

### Prerequisites

1. Follow the safety guidelines listed in the [Safety instructions](#).
2. Follow the procedure listed in the [Before working inside your system](#).

### Steps

1. Pull and lift the BOSS S2 card carrier retention latch lock to open.
2. Slide the BOSS S2 card carrier out.



**Figure 142. Removing the BOSS S2 card carrier**

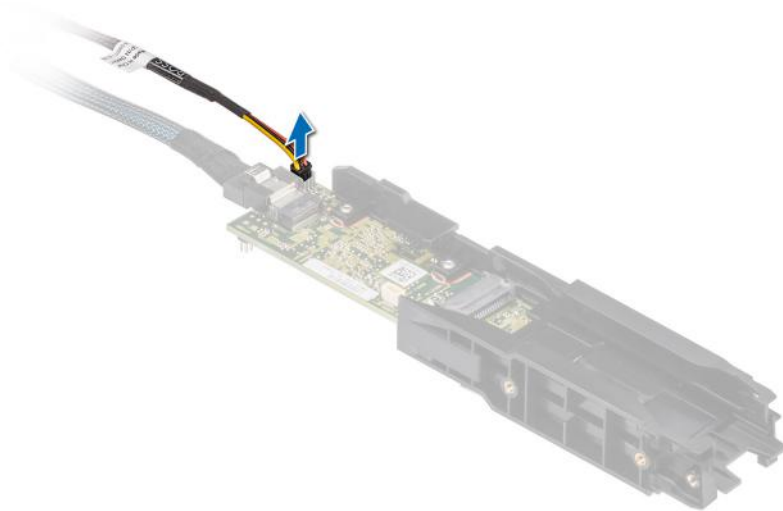
3. Using the Phillips #1 screwdriver remove the M3 x 0.5 x 4.5 mm screw that secures the M.2 SSD to the BOSS S2 card carrier.
4. Slide the M.2 SSD out from the BOSS S2 card carrier.



**Figure 143. Removing the M.2 SSD**

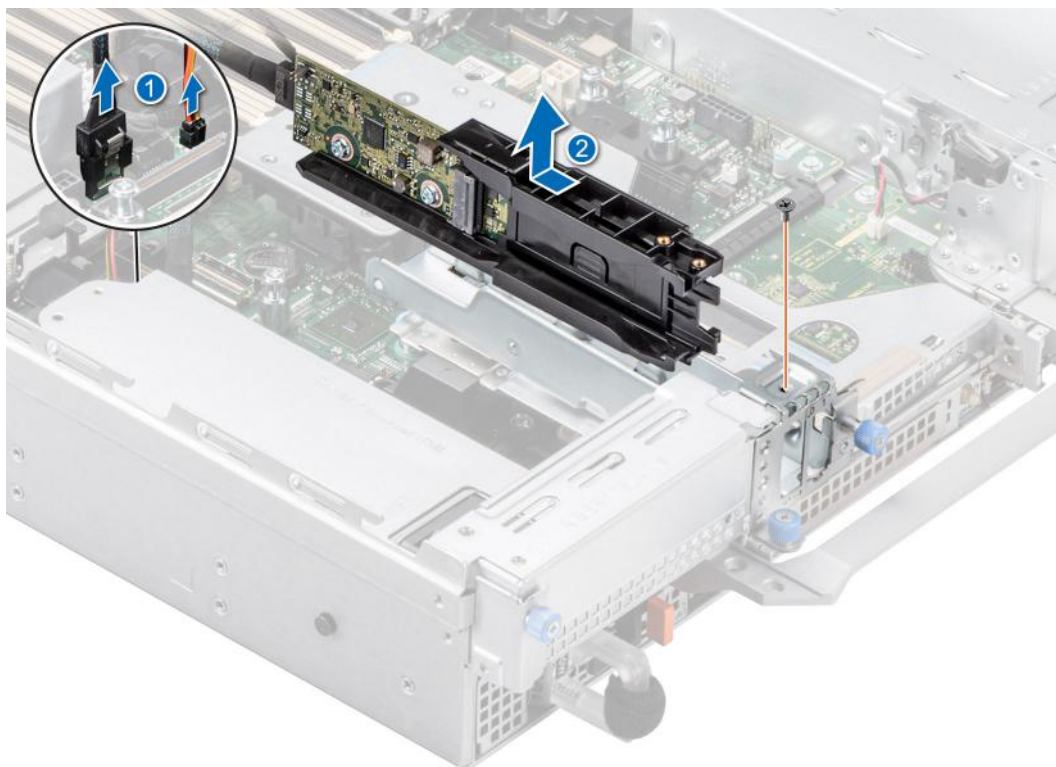
5. Disconnect the BOSS S2 power and signal cable from the system board.

**⚠ WARNING: Ensure to disconnect the BOSS S2 power cable before removing the Riser 1 cage.**



**Figure 144. Disconnecting the BOSS S2 power cable**

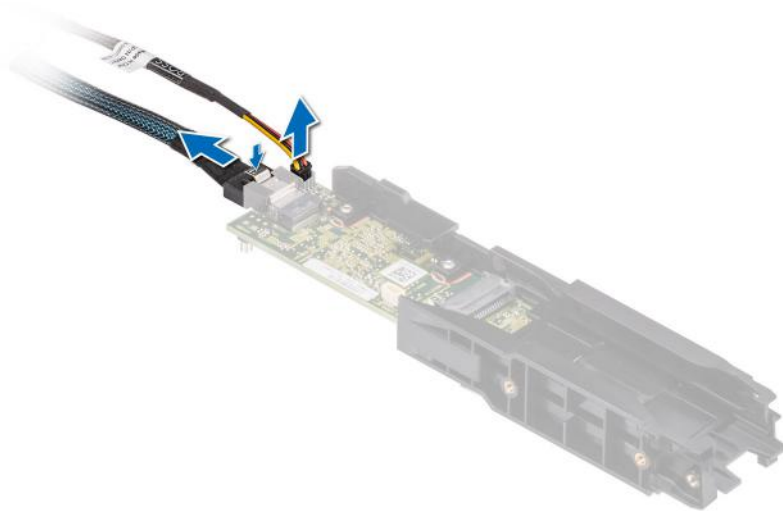
6. Using the Phillips #1 screwdriver remove the M3 x 0.5 x 4.5 mm screw that secures the BOSS S2 module on Riser 1.
7. Slide the BOSS S2 module towards the front of the chassis and lift the module.



**Figure 145. Removing the BOSS S2 module**

8. Remove the BOSS S2 power and signal cable from the BOSS S2 module.





**Figure 146. Removing the BOSS S2 power and signal cable from the BOSS S2 module**

#### Next steps

1. [Replace the BOSS S2 module](#) or [Install the BOSS card blank](#).

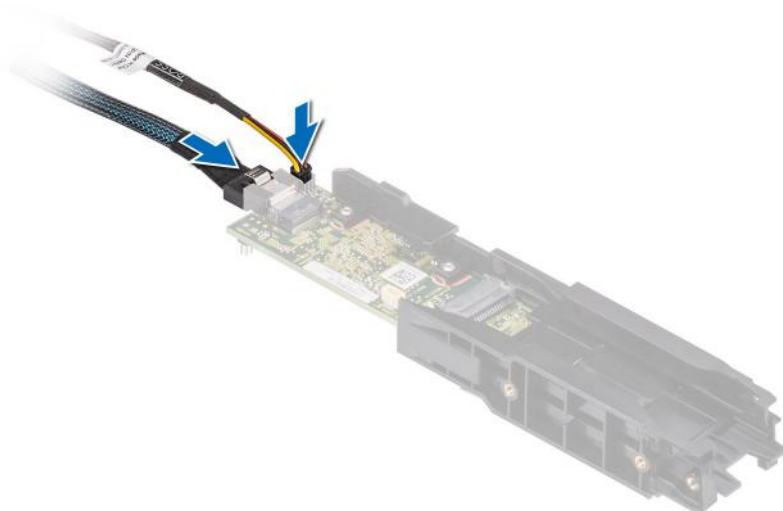
## Installing the BOSS S2 module

#### Prerequisites

1. Follow the safety guidelines listed in the [Safety instructions](#).
2. Follow the procedure listed in the [Before working inside your system](#).

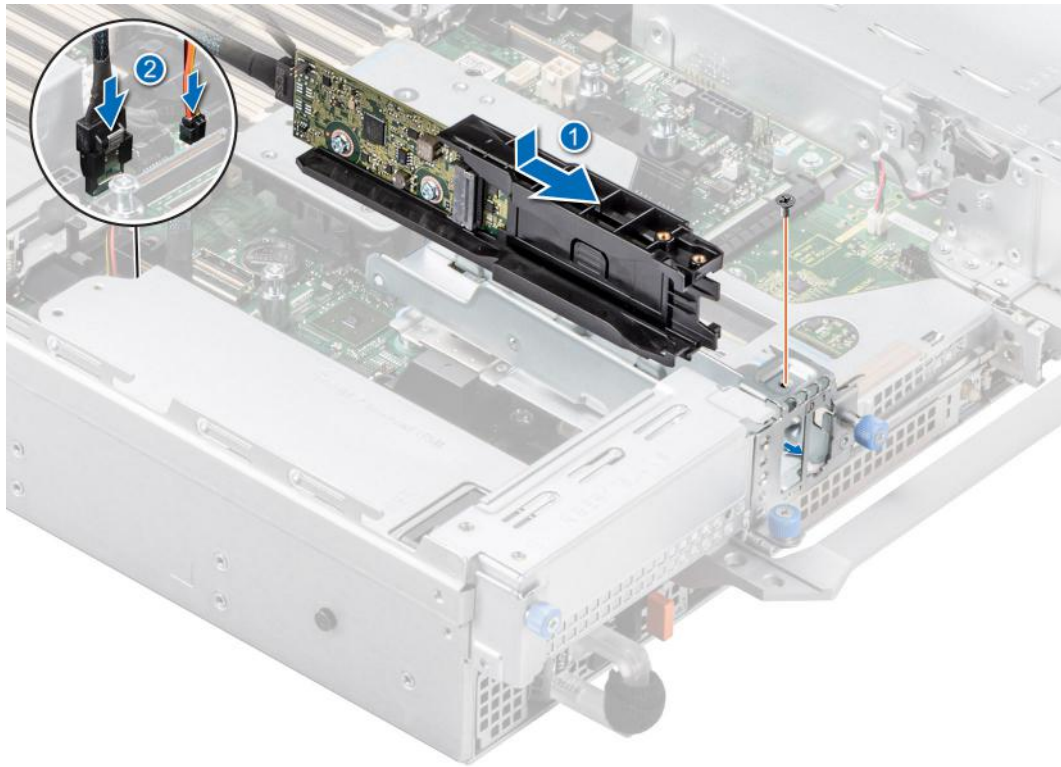
#### Steps

1. Connect the BOSS S2 power and signal cables to the connectors on the BOSS S2 module.



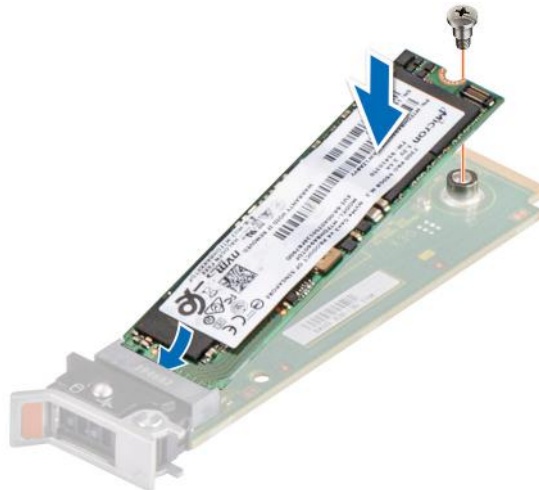
**Figure 147. Connecting the BOSS S2 power and signal cables to the BOSS S2 module**

2. Align the BOSS S2 module at an angle with the controller card module slot.
3. Insert the BOSS S2 module and push the module horizontally towards the rear of the system until firmly seated.
4. Using the Phillips #1 screwdriver, secure the BOSS S2 module with the M3 x 0.5 x 4.5 mm screw.
5. Connect the BOSS S2 power and signal cable to the connectors on the system board.



**Figure 148. Installing the BOSS S2 module**

6. Align the M.2 SSD at an angle with the BOSS S2 card carrier.
7. Insert the M.2 SSD until it is firmly seated in the BOSS S2 card carrier.
8. Using the Phillips #1 screwdriver, secure the M.2 SSD on the BOSS S2 card carrier with the M3 x 0.5 x 4.5 mm screw.



**Figure 149. Installing the M.2 SSD**

9. Slide the BOSS S2 card carrier into the BOSS S2 module slot.
10. Close the BOSS S2 card carrier release latch to lock the carrier in place.



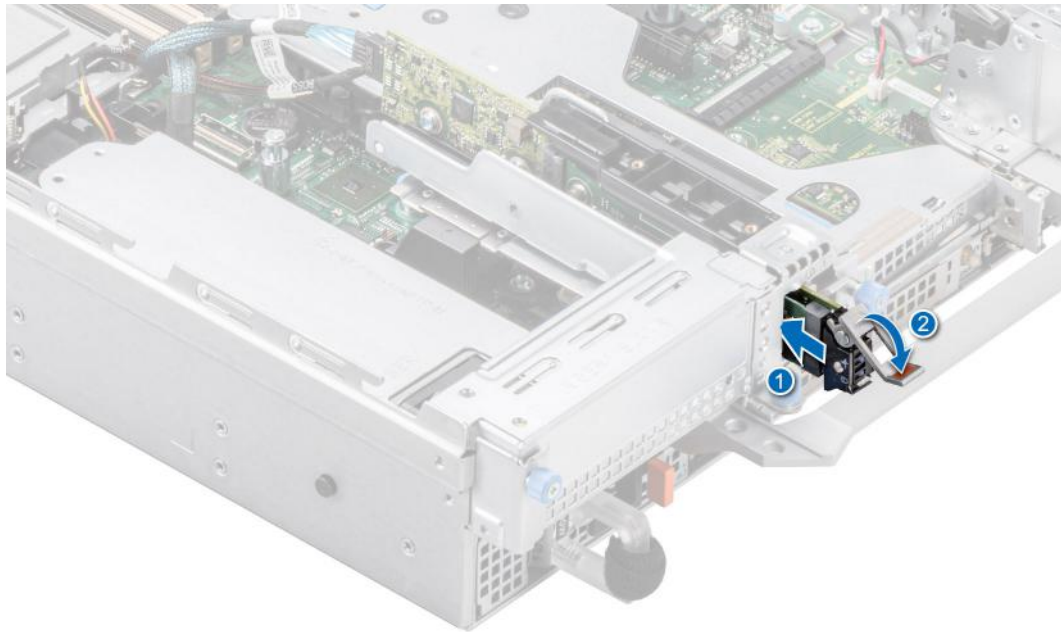


Figure 150. Installing the BOSS S2 card carrier

#### Next steps

1. Follow the procedure listed in the [After working inside your system](#).

## System battery

This is a service technician replaceable part only.

## Replacing the system battery

#### Prerequisites

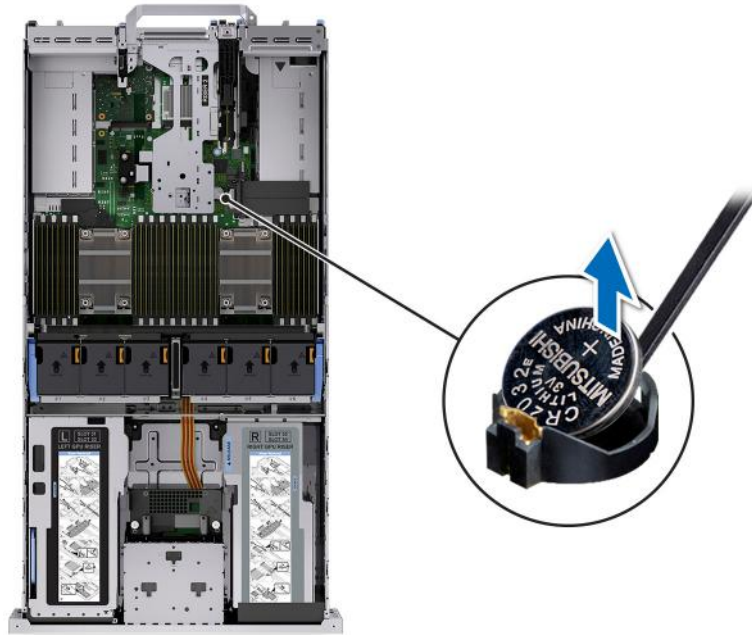
**⚠ WARNING:** There is a danger of a new battery exploding if it is incorrectly installed. Replace the battery only with the same or equivalent type That is recommended by the manufacturer. Discard used batteries according to the manufacturer's instructions. See the Safety instructions. that came with your system for more information.

1. Follow the safety guidelines listed in the [Safety instructions](#).
2. Follow the procedure listed in the [Before working inside your system](#).
3. If applicable, disconnect the power or data cables from the expansion cards.
4. [Remove the expansion card risers](#).

#### Steps

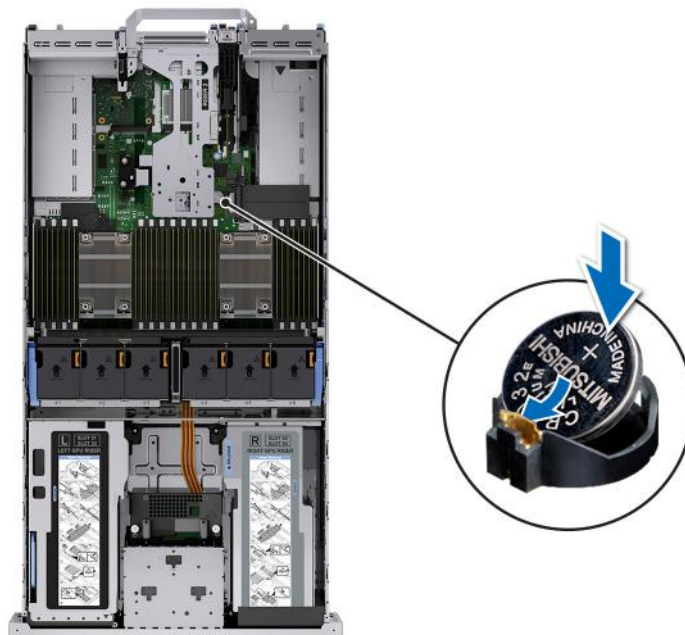
1. To remove the battery:
  - a. Use a plastic scribe to pry out the system battery.

**⚠ CAUTION:** To avoid damage to the battery connector, you must firmly support the connector while installing or removing a battery.



**Figure 151. Removing the system battery**

2. To install a new system battery:
  - a. Hold the battery with the positive side facing up and slide it under the securing tabs.
  - b. Press the battery into the connector until it snaps into place.



**Figure 152. Installing the system battery**

### Next steps

1. [Install the expansion card risers.](#)
2. If applicable, connect the cables to one or more expansion cards.
3. Follow the procedure listed in [After working inside your system.](#)
4. Confirm that the battery is operating properly, by performing the following steps:
  - a. Enter the System Setup, while booting, by pressing F2.

- b. Enter the correct time and date in the System Setup **Time** and **Date** fields.
- c. **Exit** the System Setup.
- d. To test the newly installed battery, remove the system from the enclosure for at least an hour.
- e. Reinstall the system into the enclosure after an hour.
- f. Enter the System Setup and if the time and date are still incorrect, see [Getting help](#) section.

## Optional internal USB card

### Removing the internal USB card

#### Prerequisites

**CAUTION:** To avoid interference with other components in the server, the maximum permissible dimensions of the USB memory key are 15.9 mm wide x 57.15 mm long x 7.9 mm high.

1. Follow the safety guidelines listed in the [Safety instructions](#).
2. Follow the procedure listed in the [Before working inside your system](#).
3. [Remove the expansion card risers](#).

#### Steps

1. Holding the blue tag, lift the internal USB card to disconnect from the connector on the system board.
2. Remove the USB memory key from the internal USB card.

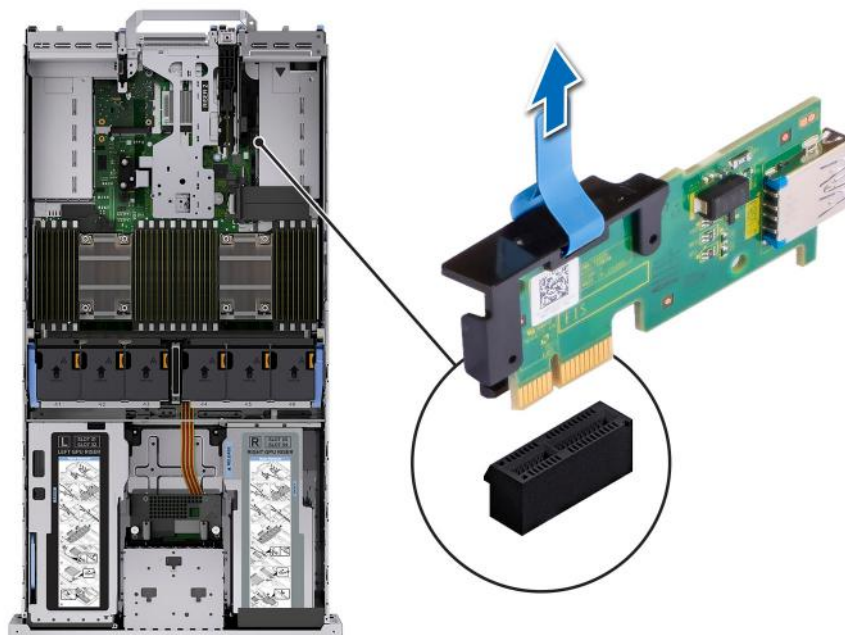


Figure 153. Removing the internal USB card

#### Next steps

1. [Replace the internal USB card](#).

### Installing the internal USB card

#### Prerequisites

1. Follow the safety guidelines listed in the [Safety instructions](#).

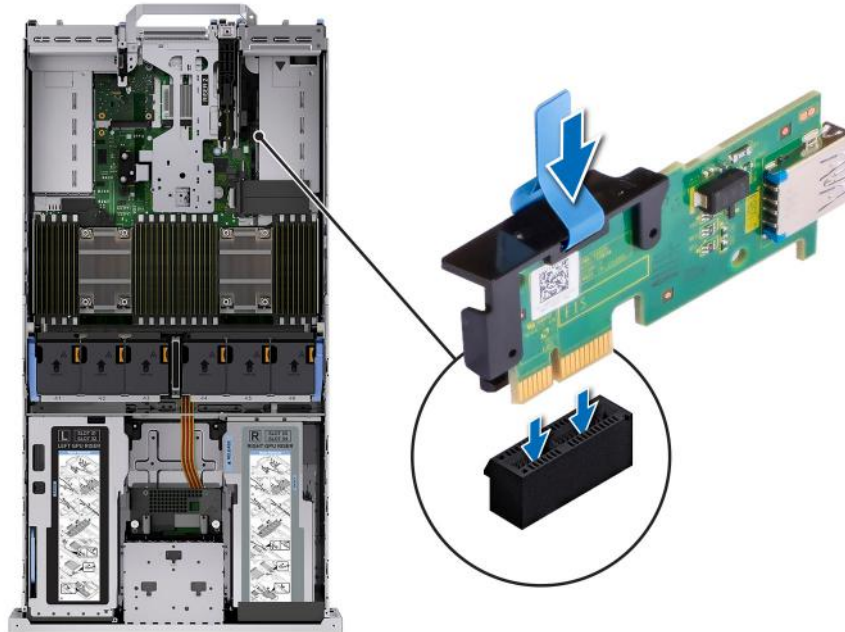
2. Follow the procedure listed in [Before working inside your system](#).
3. [Remove the expansion card risers](#).

### Steps

1. Connect the USB key to the internal USB card.

**NOTE:** For information on the exact location of internal USB card on system board, see [System board jumpers and connector](#) section.

2. Align the internal USB card with the connector on the system board and press firmly until the internal USB card is seated.



**Figure 154. Installing the internal USB card**

### Next steps

1. [Install the expansion card risers](#).
2. Follow the procedure listed in [After working inside your system](#).
3. While booting, press F2 to enter **System Setup** and verify that the system detects the USB memory key.

## Intrusion switch module

This is a service technician replaceable part only.

## Removing the intrusion switch module

### Prerequisites

1. Follow the safety guidelines listed in the [Safety instructions](#).
2. Follow the procedure listed in the [Before working inside your system](#).
3. [Remove the expansion card riser](#).

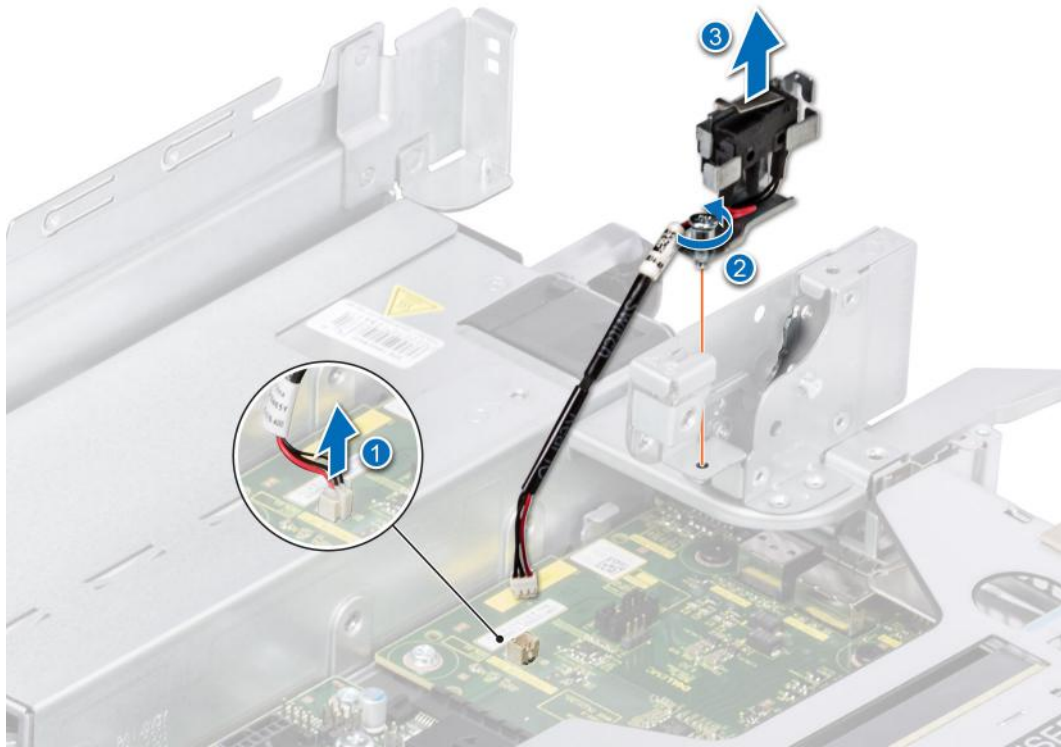
**NOTE:** Ensure that you note the routing of the cables as you remove them from the system board. Route the cable properly when you replace it to prevent the cable from being pinched or crimped

### Steps

1. Disconnect the intrusion switch cable from the connector on the rear I/O board.

2. Using a Phillips #1 screwdriver, loosen the screw on the intrusion switch module.
3. Slide the intrusion switch module out of the slot on the system.

**NOTE:** The numbers on the image do not depict the exact steps. The numbers are for representation of sequence.



**Figure 155. Removing the intrusion switch module**

#### Next steps

1. [Replace the intrusion switch module.](#)

## Installing the intrusion switch module

#### Prerequisites

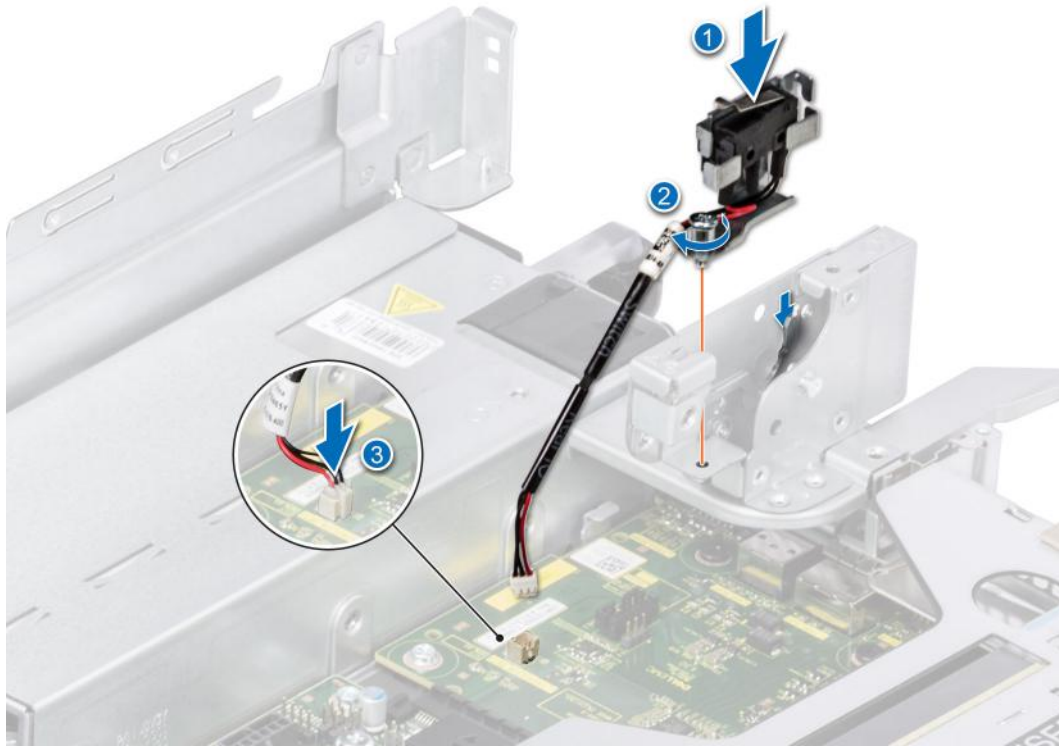
1. Follow the safety guidelines listed in the [Safety instructions](#).
2. Follow the procedure listed in [Before working inside your system](#).
3. [Remove the expansion card riser.](#)

**NOTE:** Ensure that you note the routing of the cables as you remove them from the system board. Route the cable properly when you replace it to prevent the cable from being pinched or crimped.

#### Steps

1. Align the guides on the intrusion switch module with the standoffs on the system.
2. Slide the intrusion switch module into the slot in the system until firmly seated.
3. Using a Phillips #1 screwdriver, tighten the screw on the intrusion switch module.
4. Connect the intrusion switch cable to the connector on the rear I/O board.





**Figure 156. Installing the intrusion switch module**

#### **Next steps**

1. [Install the expansion card riser.](#)
2. Follow the procedure listed in [After working inside your system.](#)

## **Optional OCP card**

### **Removing the OCP card**

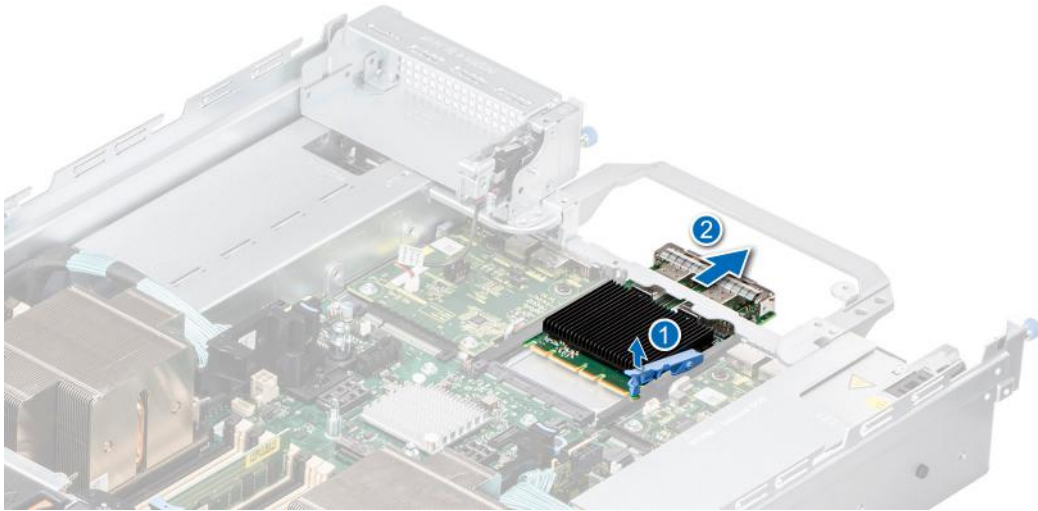
#### **Prerequisites**

1. Follow the safety guidelines listed in the [Safety instructions.](#)
2. Follow the procedure listed in the [Before working inside your system.](#)
3. [Remove the expansion card riser.](#)

#### **Steps**

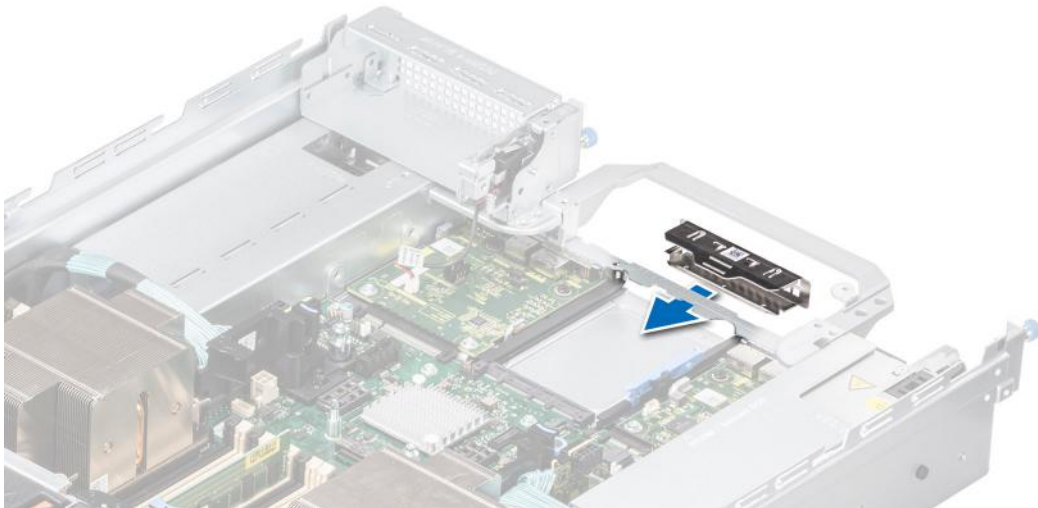
1. Open the blue latch to disengage the OCP card.
2. Push the OCP card towards the rear end of the system to disconnect from the connector on the system board.
3. Slide the OCP card out of the slot on the system.





**Figure 157. Removing the OCP card**

4. If the OCP card is not going to be replaced, install a filler bracket.



**Figure 158. Installation of filler bracket**

### **Next steps**

1. [Replace the OCP card.](#)

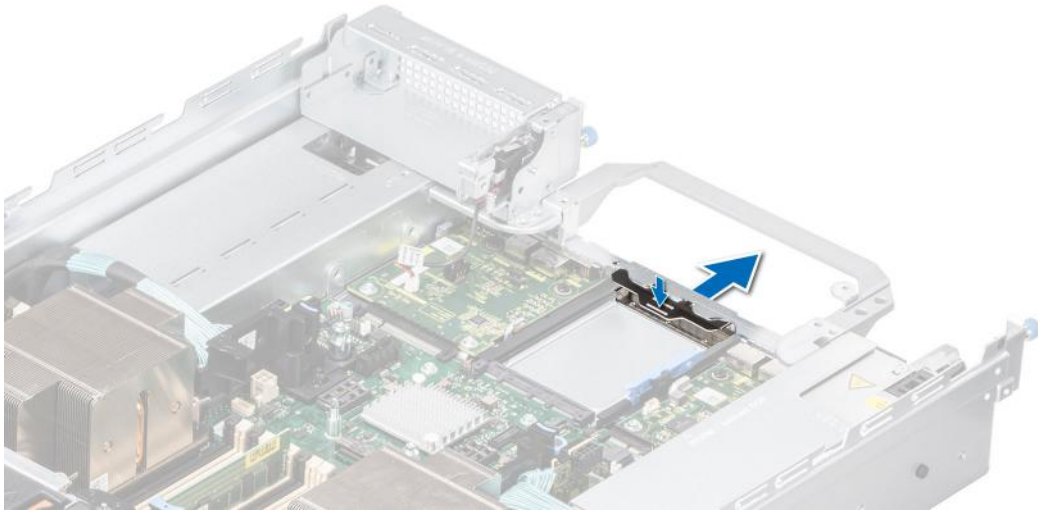
## **Installing the OCP card**

### **Prerequisites**

1. Follow the safety guidelines listed in the [Safety instructions](#).
2. Follow the procedure listed in the [Before working inside your system](#).
3. [Remove the expansion card riser.](#)

### **Steps**

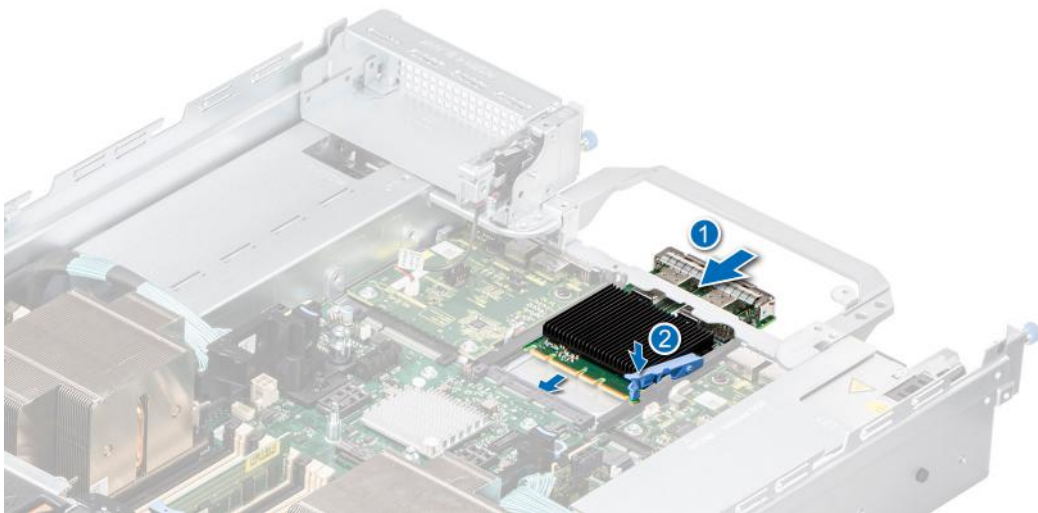
1. If installed, remove the filler bracket.



**Figure 159. Removal of filler bracket**

2. Open the blue latch on the system board.
3. Slide the OCP card into the slot in the system.
4. Push until the OCP card is connected to the connector on the system board.
5. Close the latch to lock the OCP card to the system.

**NOTE:** The numbers on the image do not depict the exact steps. The numbers are for representation of sequence.



**Figure 160. Installing the OCP card**

#### Next steps

1. [Install the expansion card riser.](#)
2. Follow the procedure listed in [After working inside your system.](#)

## Power supply unit

**NOTE:** While replacing the hot swappable PSU, after next server boot; the new PSU automatically updates to the same firmware and configuration of the replaced one. For more information about the Part replacement configuration, see the *Lifecycle Controller User's Guide* at <https://www.dell.com/idracmanuals>

## Hot spare feature

Your system supports the hot spare feature that significantly reduces the power overhead associated with the power supply unit (PSU) redundancy.

When the hot spare feature is enabled, one of the redundant PSUs is switched to the sleep state. The active PSU supports 100 percent of the system load, thus operating at higher efficiency. The PSU in the sleep state monitors output voltage of the active PSU. If the output voltage of the active PSU drops, the PSU in the sleep state returns to an active output state.

If having both PSUs active is more efficient than having one PSU in the sleep state, the active PSU can also activate the sleeping PSU.

The default PSU settings are as follows:

- If the load on the active PSU is more than 50 percent of PSU rated power wattage, then the redundant PSU is switched to the active state.
- If the load on the active PSU falls below 20 percent of PSU rated power wattage, then the redundant PSU is switched to the sleep state.

You can configure the hot spare feature by using the iDRAC settings. For more information, see the *iDRAC User's Guide* available at [www.dell.com/poweredgemanuals](http://www.dell.com/poweredgemanuals).

## Removing a power supply unit blank

### Prerequisites

Follow the safety guidelines listed in the [Safety instructions](#).

### Steps

Pull the blank out of the system.

**CAUTION:** To ensure proper system cooling, the PSU blank must be installed in the second PSU bay in a non-redundant configuration. Remove the PSU blank only if you are installing a second PSU.

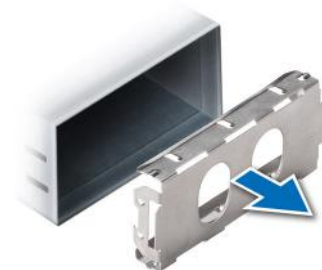


Figure 161. Removing a power supply unit blank

### Next steps

1. [Replace the PSU blank](#) or [install the PSU](#).

## Installing a power supply unit blank

### Prerequisites

1. Follow the safety guidelines listed in the [Safety instructions](#).

**NOTE:** Install the power supply unit (PSU) blank only in the second PSU bay.

2. If required, [Remove the PSU](#).

### Steps

Align the PSU blank with the PSU bay and push it into the PSU bay until it clicks into place.

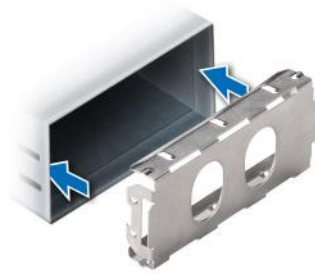


Figure 162. Installing a power supply unit blank

## Removing a power supply unit adapter

### Prerequisites

Follow the safety guidelines listed in the [Safety instructions](#).

**NOTE:** Remove the PSU adapter, when installing PSU with 86 mm wide form factor.

### Steps

Using a Phillips #1 screwdriver, loosen the screw and remove the power supply unit adapter.

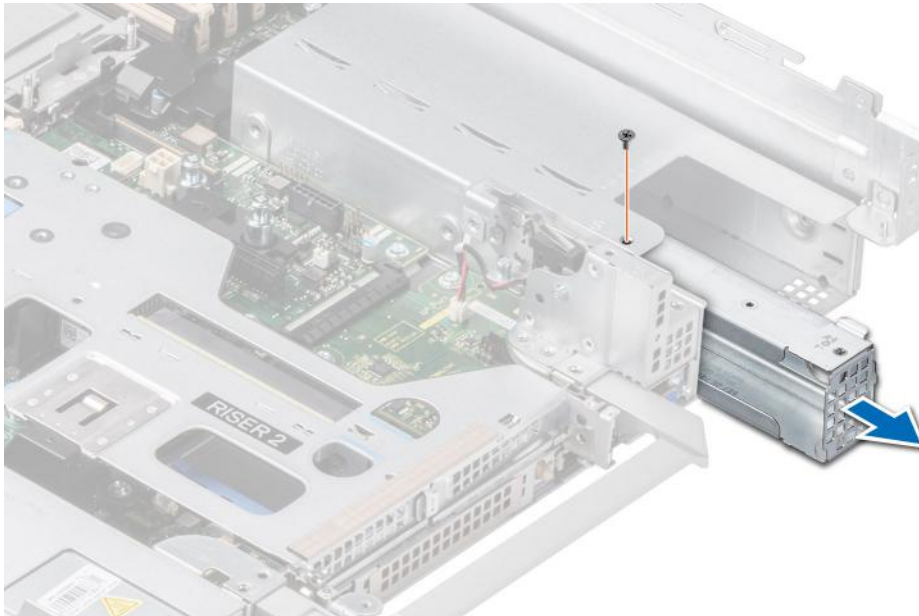


Figure 163. Removing a power supply unit adapter

### Next steps

1. [Replace the PSU adapter](#) or [Install the PSU](#).

# Installing a power supply unit adapter

## Prerequisites

1. Follow the safety guidelines listed in the [Safety instructions](#).
2. If required, [Remove the PSU](#).

**i** **NOTE:** Install the PSU adapter, when installing PSU with 60 mm wide form factor.

## Steps

1. Align and insert the power supply unit adapter.
2. Using a phillips #1 screwdriver, tighten the screw.

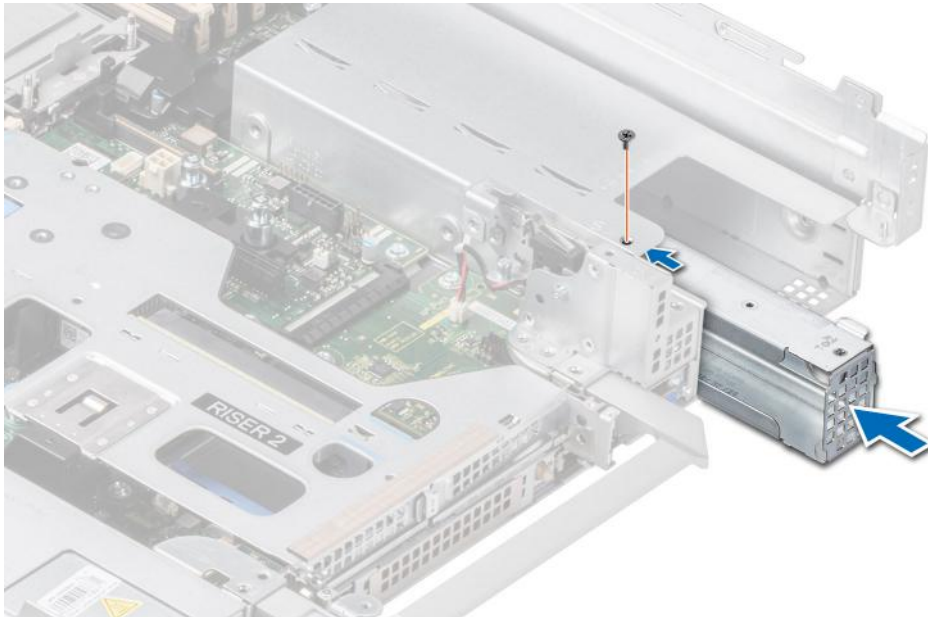


Figure 164. Installing a power supply unit adapter

# Removing a power supply unit

## Prerequisites

**⚠ CAUTION:** The system requires one power supply unit (PSU) for normal operation. On power-redundant systems, remove and replace only one PSU at a time in a system that is powered on.

1. Follow the safety guidelines listed in the [Safety instructions](#).
2. Disconnect the power cable from the power outlet and from the PSU you intend to remove.
3. Remove the cable from the strap on the PSU handle.
4. Unlatch and lift or remove the optional cable management accessory if it interferes with the PSU removal.

**i** **NOTE:** For information about the cable management when the PSU is removed or installed while the system is in a rack, see the system's cable management arm documentation at <https://www.dell.com/poweredgemanuals>.

## Steps

Press the release latch and holding the PSU handle, slide the PSU out of the bay.



**Figure 165. Removing a power supply unit**

#### Next steps

1. [Replace the PSU](#) or [install the PSU blank](#).

## Installing a power supply unit

#### Prerequisites

1. Follow the safety guidelines listed in the [Safety instructions](#).
2. For systems that support redundant PSU, ensure that both the PSUs are of the same type and have the same maximum output power.

**NOTE:** The maximum output power (shown in watts) is listed on the PSU label.

3. [Remove the PSU blank](#).

#### Steps

Slide the PSU into the PSU bay until the release latch snaps into place.





Figure 166. Installing a power supply unit

### Next steps

1. If you have unlatched or removed the cable management accessory, re-install or relatch it. For information about the cable management when the PSU is removed or installed while the system is in the rack, see the system's cable management accessory documentation at <https://www.dell.com/poweredgemanuals>.
2. Connect the power cable to the PSU, and plug the cable into a power outlet.

**CAUTION:** When connecting the power cable to the PSU, secure the cable to the PSU with the strap.

**NOTE:** When installing, hot swapping, or hot adding a new PSU, wait for 15 seconds for the system to recognize the PSU and determine its status. The PSU redundancy may not occur until discovery is complete. The PSU status indicator turns green to indicate that the PSU is functioning properly.

## Trusted Platform Module

This is a service technician replaceable part only.

## Upgrading the Trusted Platform Module

### Removing the TPM

#### Prerequisites

**NOTE:**

- Ensure that your operating system supports the version of the TPM module being installed.
- Ensure that you download and install the latest BIOS firmware on your system.
- Ensure that the BIOS is configured to enable UEFI boot mode.

**CAUTION:** After the TPM plug-in module is installed, it is cryptographically bound to that specific system board. When the system is powered on, any attempt to remove an installed TPM plug-in module breaks the cryptographic binding, and the removed TPM cannot be installed on another system board. Ensure any keys you have stored on the TPM have been securely transferred.

### Steps

1. Locate the TPM connector on the system board.
2. Press to hold the module down and remove the screw using the security Torx 8-bit shipped with the TPM module.
3. Slide the TPM module out from its connector.
4. Push the plastic rivet away from the TPM connector and rotate it 90° counterclockwise to release it from the system board.
5. Pull the plastic rivet out of its slot on the system board.

## Installing the TPM

### Steps

1. To install the TPM, align the edge connectors on the TPM with the slot on the TPM connector.
2. Insert the TPM into the TPM connector such that the plastic rivet aligns with the slot on the system board.
3. Press the plastic rivet until the rivet snaps into place.
4. Replace the screw that secures the TPM to the system board.



Figure 167. Installing the TPM

## Initializing TPM for users

### Steps

1. Initialize the TPM.  
For more information, see [Initializing the TPM for users](#).
2. The **TPM Status** changes to **Enabled, Activated**.

## Initializing the TPM 1.2 for users

### Steps

1. While booting your system, press F2 to enter System Setup.
2. On the **System Setup Main Menu** screen, click **System BIOS > System Security Settings**.
3. From the **TPM Security** option, select **On with Preboot Measurements**.
4. From the **TPM Command** option, select **Activate**.
5. Save the settings.
6. Restart your system.

# Initializing the TPM 2.0 for users

## Steps


1. While booting your system, press F2 to enter System Setup.
2. On the **System Setup Main Menu** screen, click **System BIOS > System Security Settings**.
3. From the **TPM Security** option, select **On**.
4. Save the settings.
5. Restart your system.

# System board

This is a service technician replaceable part only.

# Removing the system board

## Prerequisites

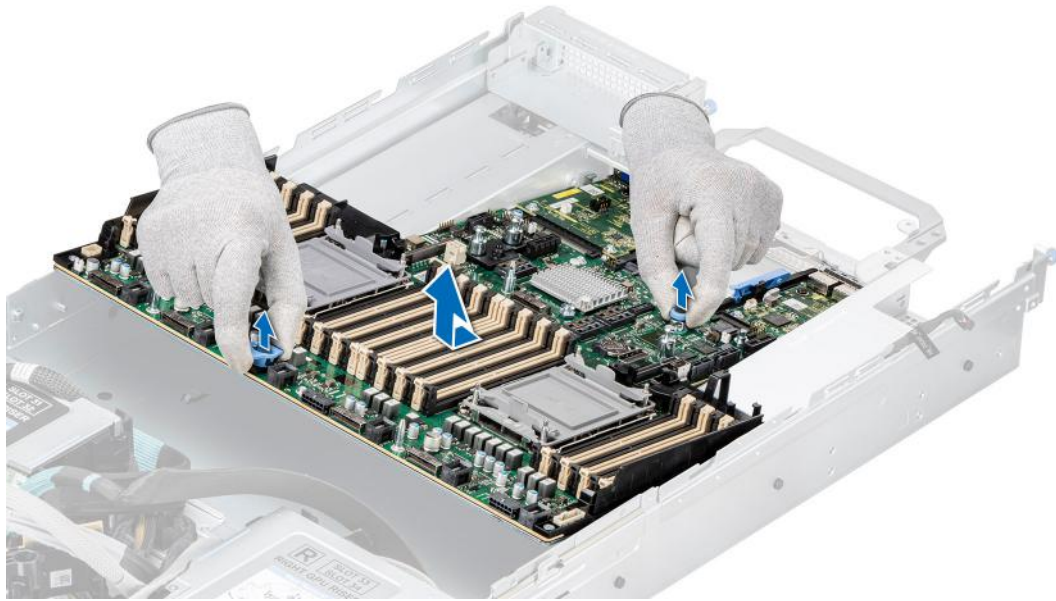
 **CAUTION:** If you are using the Trusted Platform Module (TPM) with an encryption key, you may be prompted to create a recovery key during program or System Setup. Be sure to create and safely store this recovery key. If you replace this system board, you must supply the recovery key when you restart your system or program before you can access the encrypted data on your drives.

1. Follow the safety guidelines listed in the [Safety instructions](#).
2. Follow the procedure listed in the [Before working inside your system](#).
3. Remove the following components:
  - a. [Air shroud](#)
  - b. [Cooling fan cage assembly](#)
  - c. [Side wall bracket](#)
  - d. [Memory modules](#)
  - e. [Processor and heat sink module](#) or [Liquid cooling module](#)
  - f. [BOSS S2 module](#) (if installed)
  - g. [Serial COM port](#) (if installed)
  - h. [VGA port](#) (if installed)
  - i. [R1 and R4 paddle card](#)
  - j. [R3 paddle card](#) (If installed)
  - k. [Expansion card risers](#)
  - l. [IDSDM module](#) (if installed)
  - m. [Internal USB card](#) (if installed)
  - n. [OCP card](#) (if installed)
  - o. [Intrusion switch module](#)
  - p. [Power supply units \(PSU\)](#)
  - q. Disconnect all cables from the system board.

 **CAUTION:** Take care not to damage the system identification button while removing the system board from the system.

## Steps

1. Using the system board holder and plunger, slide the system board towards the front of the system.
2. Lift the system board out of the chassis.



**Figure 168. Removing the system board**

### Next steps

1. [Install the system board.](#)

## Installing the system board

### Prerequisites

**NOTE:** Before replacing the system board, replace the old iDRAC MAC address label in the Information tag with the iDRAC MAC address label of the replacement system board

1. Follow the safety guidelines listed in the [Safety instructions](#).
2. Follow the procedure listed in [Before working inside your system](#).
3. If you are replacing the system board, remove all the components that are listed in the removing the system board section.

### Steps

1. Unpack the new system board assembly.

**CAUTION:** Do not lift the system board by holding a memory module, processor, or other components.

**CAUTION:** Take care not to damage the system identification button while placing the system board into the chassis.

2. Holding the system board holder and plunger, lower the system board into the system.
3. Slide the system board towards the rear of the chassis until the connectors are firmly seated in the slots.



**Figure 169. Installing the system board**

### Next steps

1. Replace the following components:
  - a. [Trusted Platform Module \(TPM\)](#)
    - i** **NOTE:** The TPM Module must be replaced only while installing new system board.
  - b. [IDSDM module \(if removed\)](#)
  - c. [Internal USB card \(if removed\)](#)
  - d. [OCP card \(if removed\)](#)
  - e. [Intrusion switch module](#)
  - f. [Processor and heat sink](#) or [Liquid cooling module](#)
  - g. [Memory modules](#)
  - h. [BOSS S2 module \(if, removed\)](#)
  - i. [Serial COM port \(if removed\)](#)
  - j. [VGA port \(if removed\)](#)
  - k. [R1 and R4 paddle card](#)
  - l. [R3 paddle card \(If removed\)](#)
  - m. [Expansion card riser](#)
  - n. [Side wall bracket](#)
  - o. [Cooling fan cage assembly](#)
  - p. [Air shroud](#)
  - q. [Power supply units \(PSU\)](#)
2. Reconnect all cables to the system board.
  - i** **NOTE:** Ensure that the cables inside the system are routed along the chassis wall and secured using the cable securing bracket.
3. Ensure that you perform the following steps:
  - a. Use the Easy Restore feature to restore the Service Tag. See the [Restoring the system by using the Easy Restore feature](#) section.
  - b. If the service tag is not backed up in the backup flash device, enter the system service tag manually. See the [Manually update the Service Tag by using System Setup](#) section.
  - c. Update the BIOS and iDRAC versions.
    - i** **NOTE:** Reenable the Trusted Platform Module (TPM). See the [Upgrading the Trusted Platform Module](#) section.
4. If you are not using Easy restore, import your new or existing iDRAC Enterprise license. For more information, see the [iDRAC User's Guide](#) available at <https://www.dell.com/idracmanuals>.
5. Follow the procedure listed in [After working inside your system](#).

## Restoring the system using Easy Restore

The Easy Restore feature enables you to restore your service tag, license, UEFI configuration, and the system configuration data after replacing the system board. All data is backed up in a backup flash device automatically. If BIOS detects a new system board, and the service tag in the backup flash device, BIOS prompts the user to restore the backup information.

### About this task

Below is a list of options/steps available:

- Restore the service tag, license, and diagnostics information, press **Y**
- Navigate to the Lifecycle Controller based restore options, press **N**
- Restore data from a previously created **Hardware Server Profile**, press **F10**  
**i** **NOTE:** When the restore process is complete, BIOS prompts to restore the system configuration data.
- Restore data from a previously created **Hardware Server Profile**, press **F10**
- To restore the system configuration data, press **Y**
- To use the default configuration settings, press **N**
- **i** **NOTE:** After the restore process is complete, system reboots.

## Manually update the Service Tag

After replacing a system board, if Easy Restore fails, follow this process to manually enter the Service Tag, using **System Setup**.

### About this task

If you know the system service tag, use the **System Setup** menu to enter the service tag.

### Steps

1. Power on the system.
2. To enter the **System Setup**, press **F2**.
3. Click **Service Tag Settings**.
4. Enter the service tag.

**i** **NOTE:** You can enter the service tag only when the **Service Tag** field is empty. Ensure that you enter the correct service tag. Once the service tag is entered, it cannot be updated or changed.

5. Click **OK**.

## LOM card and rear I/O board

### Removing the LOM card and rear I/O board

#### Prerequisites

1. Follow the safety guidelines listed in the [Safety instructions](#).
2. Follow the procedure listed in the [Before working inside your system](#).
3. [Remove the system board](#).

**i** **NOTE:** The procedure to remove the liquid cooling rear I/O board and rear I/O board is same.

#### Steps

1. Using a Phillips # 2 screwdriver, remove the screws that secure the LAN on Motherboard (LOM) card and rear I/O board to the system board.
2. Holding the edges, pull the LOM card or rear I/O board to disconnect from the connector on the system board.



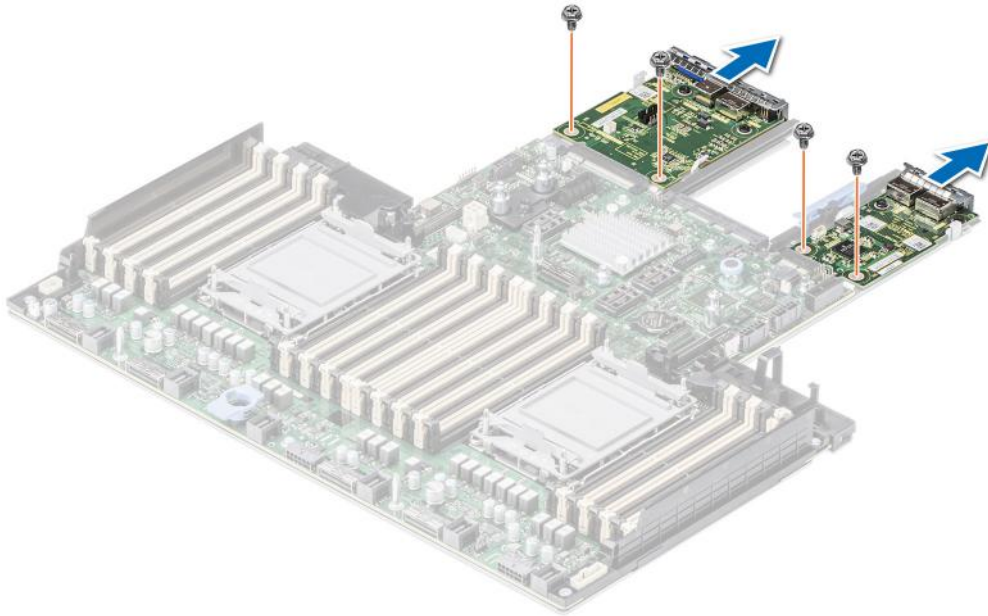


Figure 170. Removing the LOM card and rear I/O board

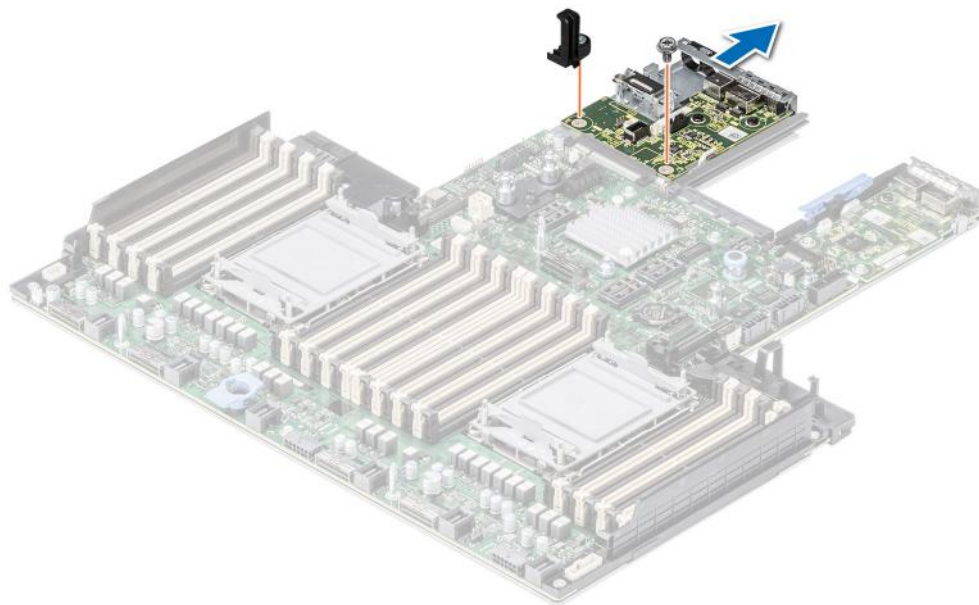


Figure 171. Removing liquid cooling rear I/O board

#### Next steps

1. [Replace the LOM card and rear I/O board.](#)

## Installing the LOM card and rear I/O board

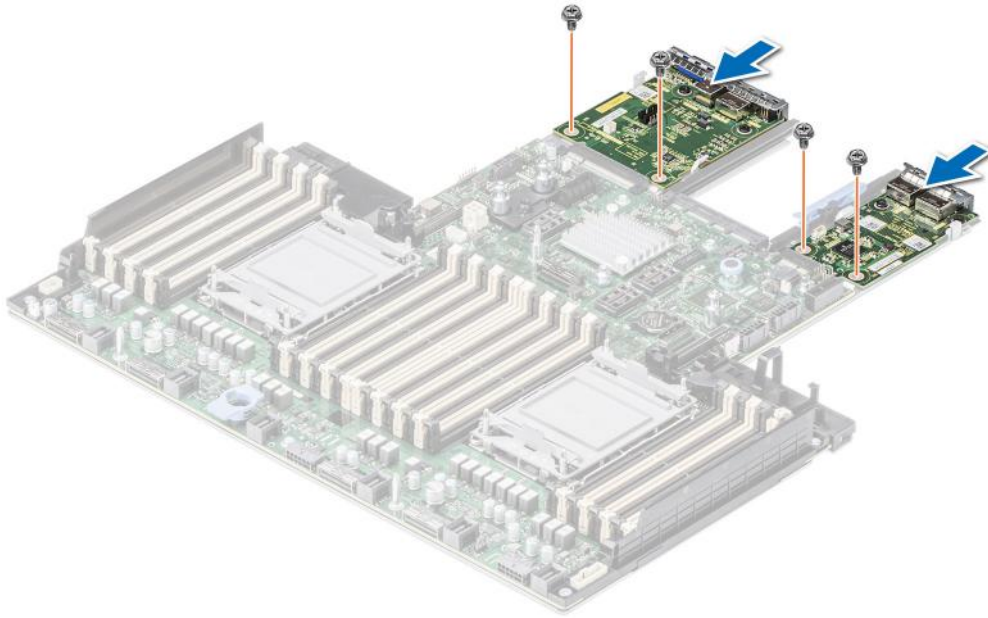
#### Prerequisites

1. Follow the safety guidelines listed in the [Safety instructions](#).
2. Follow the procedure listed in the [Before working inside your system](#).
3. [Remove the system board.](#)

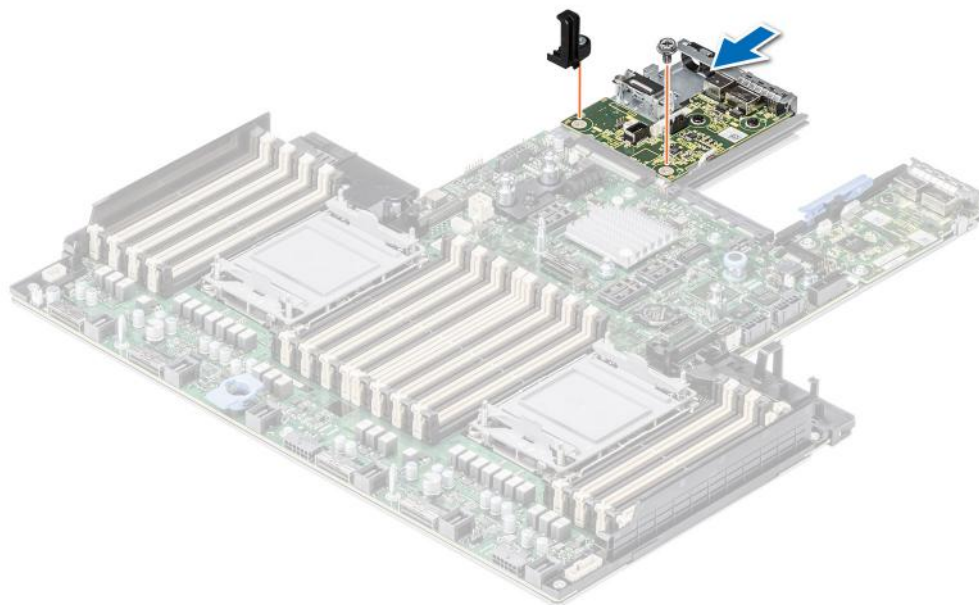
**NOTE:** The procedure to install the liquid cooling rear I/O board and rear I/O board is same.

### Steps

1. Align the connectors and slots on the LOM card or rear I/O board with the connector and standoffs on the system board.
2. Press the LOM card or rear I/O board until firmly seated on the system board connector.
3. Using a Phillips #2 screwdriver, secure the LOM card or rear I/O board to the system board with screws.



**Figure 172. Installing the LOM card and rear I/O board**



**Figure 173. Installing the liquid cooling rear I/O board**

### Next steps

1. [Install the system board.](#)
2. Follow the procedure listed in [After working inside your system.](#)

# Control panel

This is a service technician replaceable part only.

## Removing the right control panel

### Prerequisites

1. Follow the safety guidelines listed in the [Safety instructions](#).
2. Follow the procedure listed in the [Before working inside your system](#).
3. [Remove the drive backplane cover](#).
4. If installed, [remove the air shroud](#).
5. [Remove the cooling fan cage assembly](#).
6. [Remove the side wall bracket](#).

### Steps

1. Using the Phillips #1 screwdriver, remove the screws that secures the right control panel and cable cover to the system.
2. Remove the cable cover away the system.
3. Disconnect the right control panel cable and the VGA cable from the connectors on the system board.
4. Holding the cable, slide the right control panel out of the system.

**NOTE:** Observe the routing of the cable as you remove the right control panel from the system.

**NOTE:** The numbers on the image do not depict the exact steps. The numbers are for representation of sequence.

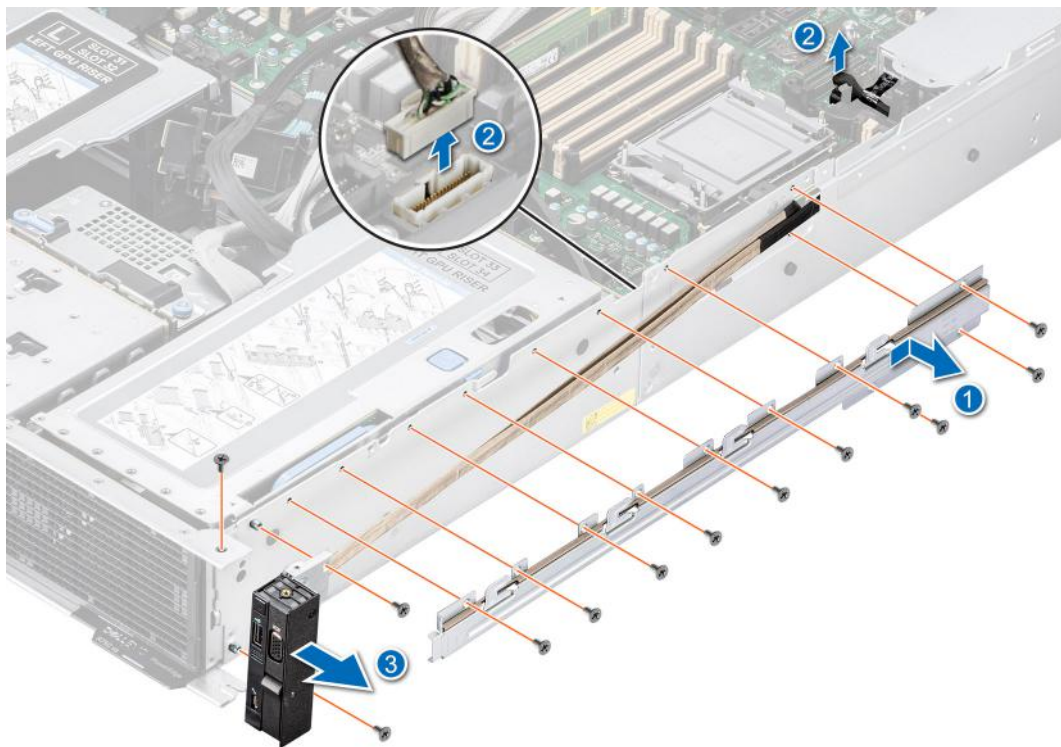


Figure 174. Removing the right control panel

### Next steps

1. [Replace the right control panel](#).

# Installing the right control panel

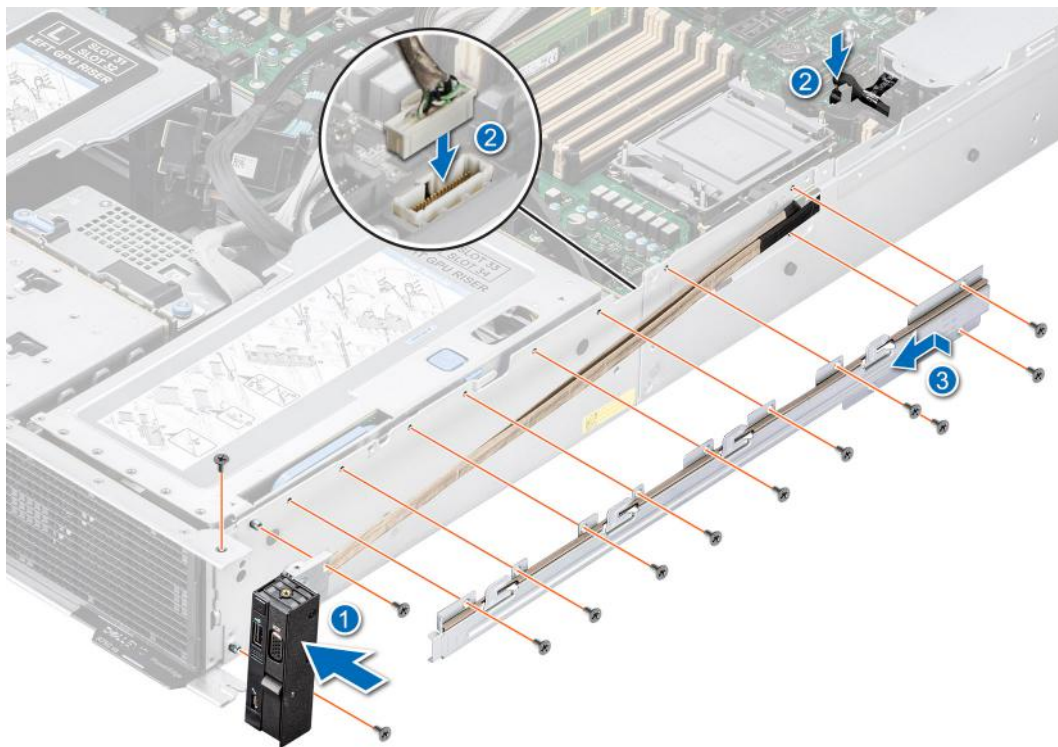
## Prerequisites

1. Follow the safety guidelines listed in the [Safety instructions](#).
2. Follow the procedure listed in the [Before working inside your system](#).
3. [Remove the drive backplane cover](#).
4. If installed, [remove the air shroud](#).
5. [Remove the cooling fan cage assembly](#).
6. [Remove the side wall bracket](#).

## Steps

1. Align and slide the right control panel into the slot on the system.
2. Route the right control panel cable through the side wall of the system.
3. Align and slide the right control panel cable cover in the slot on the system.  
**i** **NOTE:** Route the cable properly to prevent the cable from being pinched or crimped.
4. Connect the right control panel cable and VGA cable to the connectors on the system board.
5. Using the Phillips #1 screwdriver, tighten the screws that secures the right control panel and the cable cover to the system.

**i** **NOTE:** The numbers on the image do not depict the exact steps. The numbers are for representation of sequence.



**Figure 175. Installing the right control panel**

## Next steps

1. [Install the side wall bracket](#).
2. [Install the cooling fan cage assembly](#).
3. [Install the drive backplane cover](#).
4. [Install the air shroud](#).
5. Follow the procedure listed in [After working inside your system](#).



# Removing the left control panel

## Prerequisites

1. Follow the safety guidelines listed in the [Safety instructions](#).
2. Follow the procedure listed in the [Before working inside your system](#).
3. [Remove the drive backplane cover](#).
4. If installed, [remove the air shroud](#).
5. [Remove the cooling fan cage assembly](#).
6. [Remove the side wall bracket](#).

## Steps

1. Using the Phillips #1 screwdriver, remove the screws that secures the left control panel and the cable cover to the system.
2. Remove the cable cover away the system.
3. Disconnect the control panel cable from the connector on the system board.
4. Holding the cable, slide the left control panel out of the system.

**NOTE:** Observe the routing of the cable as you remove the right control panel from the system.

**NOTE:** The numbers on the image do not depict the exact steps. The numbers are for representation of sequence.

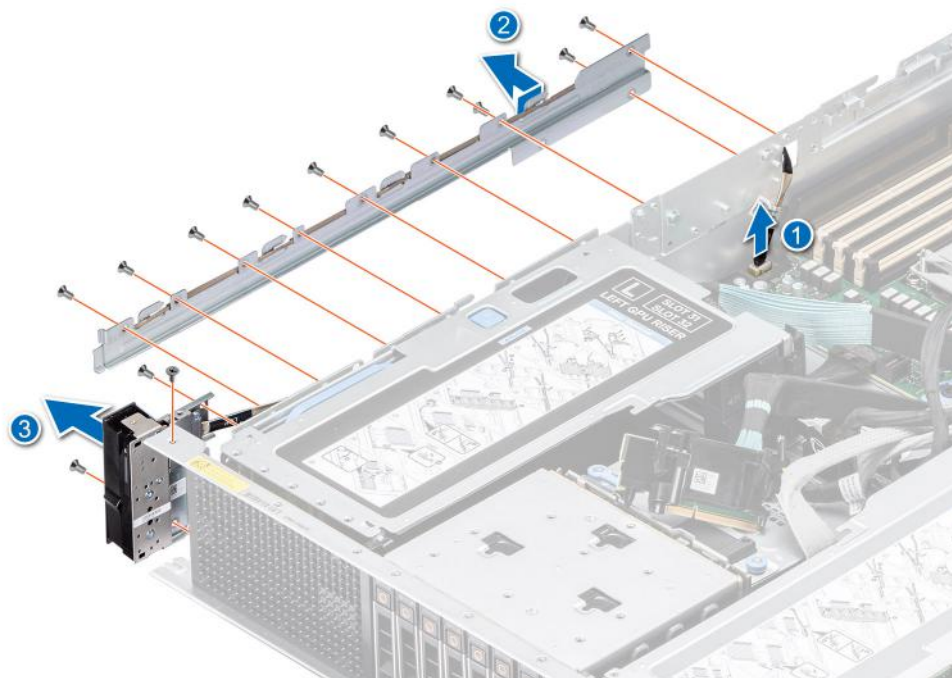


Figure 176. Removing the left control panel

## Next steps

1. [Replace the left control panel](#).

# Installing the left control panel

## Prerequisites

1. Follow the safety guidelines listed in the [Safety instructions](#).
2. Follow the procedure listed in the [Before working inside your system](#).
3. [Remove the drive backplane cover](#).
4. If installed, [remove the air shroud](#).
5. [Remove the cooling fan cage assembly](#).
6. [Remove the side wall bracket](#).

## Steps

1. Align and slide the left control panel in the slot on the system.
2. Route the left control panel cable through the side wall of the system.
3. Align and slide the left control panel cable cover in the slot on the system.  
**NOTE:** Route the cable properly to prevent the cable from being pinched or crimped.
4. Connect the left control panel cable to the connector on the system board.
5. Using the Phillips #1 screwdriver, tighten the screws to secure the left control panel and the cable cover to the system.  
**NOTE:** The numbers on the image do not depict the exact steps. The numbers are for representation of sequence.

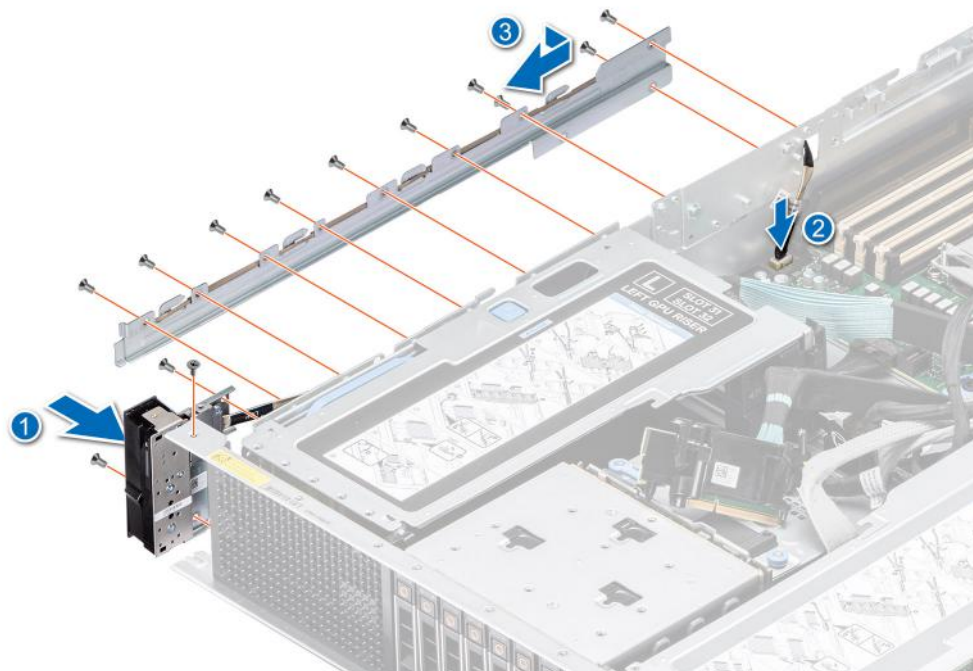


Figure 177. Installing the left control panel

## Next steps

1. [Install the side wall bracket](#).
2. [Install the cooling fan cage assembly](#).
3. [Install the drive backplane cover](#).
4. [Install the air shroud](#).
5. Follow the procedure listed in [After working inside your system](#).



# Upgrade Kits

The table lists the available After Point Of Sale [APOS] kits.

**Table 36. Upgrade kits**

Kits	Related links to service instructions
Bezel	See <a href="#">Installing the front bezel</a>
Boss	See <a href="#">Installing the M.2 SSD module</a>
BOSS S2	See <a href="#">Installing the BOSS S2 controller card module</a>
Embedded management (IDSDM)	See <a href="#">IDSDM kit</a>
GPU	See <a href="#">GPU kit</a>
Accelerator enablement kit	See <a href="#">GPU kit</a>
Hard drives	See <a href="#">Installing the drive</a>
Hard drives SSD	See <a href="#">Installing the drive into the carrier</a>
Memory	See <a href="#">Installing a memory module</a>
Network cards (Standard PCIe adapter LP/FH)	See <a href="#">Installing the LOM card and rear I/O board</a>
Network cards (OCP)	See <a href="#">Installing the OCP card</a>
PCIe SSD card	See <a href="#">Installing the drive</a>
Power cords	N/A
Power supplies	See <a href="#">Installing a power supply unit</a>
Quick sync	N/A
SD cards	See <a href="#">Installing the MicroSD card</a>
TPM	See <a href="#">Upgrading the Trusted Platform Module</a>
Processor enablement thermal kits	See <a href="#">Installing the processor</a>
Internal USB 3.0 card	See <a href="#">Internal USB card kit</a>
Serial COM port daughter card	See <a href="#">Installing the serial COM port</a>
VGA port for liquid cooling system	See <a href="#">Installing the VGA port</a>
Cables	N/A
Fans	See <a href="#">Installing a fan</a>
Heat sink	See <a href="#">Installing a processor heat sink module</a>
Risers	See <a href="#">Installing the expansion riser</a>
Rail	N/A
CMA	N/A

## Topics:

- [BOSS S2 module kit](#)
- [GPU kit](#)
- [IDSDM kit](#)

- [Internal USB card kit](#)
- [Serial COM port kit](#)
- [VGA port kit](#)

## BOSS S2 module kit

The BOSS S2 module supports up to two M.2 SSDs.

**i** **NOTE:** To enable the BOSS S2 module in the system, ensure that the BIOS firmware version is 1.5.5 and iDRAC firmware version is 4.30.30.30 or later.

Before you begin the installation or removal process, follow the [safety guidelines](#) and [before working inside the system](#) instructions.

**Table 37. BOSS S2 module kit components**

R750xa (quantity)	Components in kit
NA	BOSS cover
1	M3 x 0.05 x 4.5 mm screws
1	BOSS signal cable
1	BOSS power cable
1	BOSS-S2 module
1 or 2*	BOSS-S2 card carrier
1 or 2*	M.2 SSD
2	M.2 240 GB information label
2	M.2 480 GB information label
1	BOSS card filler
1	Tech sheet

To remove the BOSS blank :

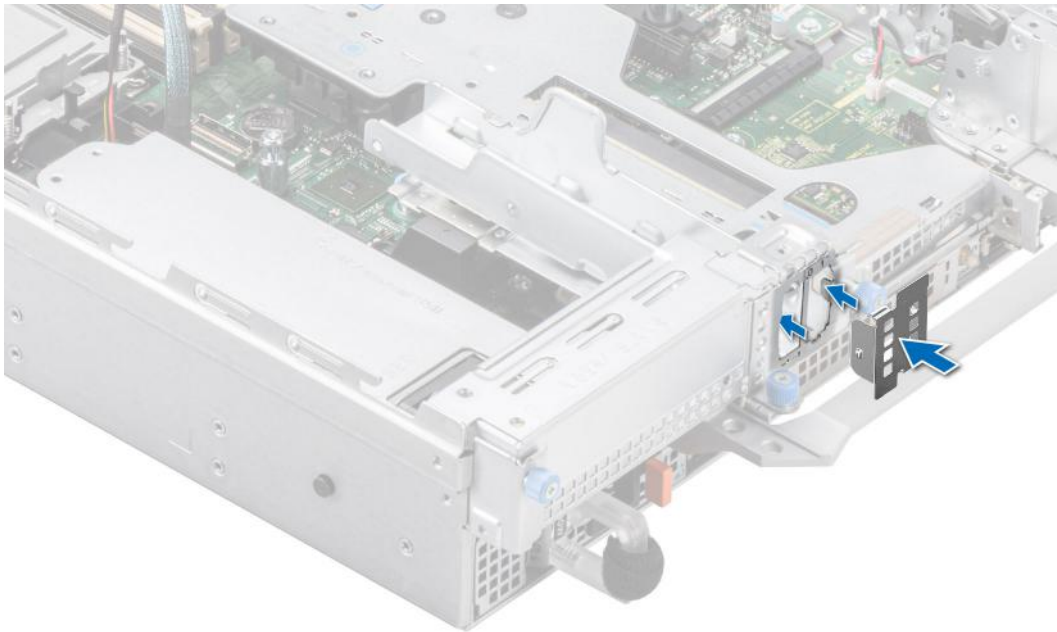
1. Power off the system and [remove the system cover](#).
2. Use a screwdriver to push out the blank from the BOSS S2 module bay.



**Figure 178. Removing the BOSS S2 module blank**

To install the BOSS S2 module blank:

1. Align the blank with the BOSS S2 module bay and push it into the bay until it clicks into place.



**Figure 179. Installing the BOSS S2 module blank**

To install the BOSS S2 module:

1. Install the BOSS S2 module . To install the BOSS S2 , see [installing the BOSS S2 module](#) steps 1 to 5.
2. Install the M.2 SSD. To install the M.2 SSD, see [installing the BOSS S2 module](#) steps 6 to 10.

**NOTE:** Installing the BOSS S2 card carrier does not require the system to be powered off. System shutdown is only required when installing the BOSS S2 module.

To remove the BOSS S2 module:

1. Power off the system and [remove the system cover](#).
2. Remove the M.2 SSD. To remove the M.2 SSD, see [removing the BOSS S2 module](#) steps 1 to 4.
3. Remove the BOSS S2 module. To remove the BOSS S2 module, see [removing the BOSS S2 module](#) steps 5 to 8.

4. Install the BOSS blank.

**i** **NOTE:** Removal of the BOSS S2 card carrier does not require the system to be powered off. System shutdown is only required when removing the BOSS S2 module.

**i** **NOTE:** Disconnect the BOSS signal cable and the BOSS power cable before lifting the controller card module from the system.

# GPU kit

The GPU kits of different types are available for the customer. Depending on the kit ordered, the respective components will be available.

**CAUTION:** Do not install GPUs, network cards, or other PCIe devices on your system that are not validated and tested by Dell. Damage caused by unauthorized and invalidated hardware installation will null and void the system warranty.

**WARNING:** Consumer-Grade GPU should not be installed or used in the Enterprise Server products.

**Table 38. Components in MI100 GPU card kit**

Component	Quantity
GPU34 PCIe type power cable assembly	1
GPU32 PCIe type power cable assembly	1
Tech sheet	1

**Table 39. Components in M10 GPU card kit**

Component	Quantity
GPU33 PCIe type power cable assembly	1
V100S extended GPU bracket assembly	2
GPU31 PCIe type power cable assembly	1
Screws	6
Tech sheet	1

**Table 40. Components in A100 and A40 GPU card kit**

Component	Quantity
A100 extended GPU bracket assembly	2
GPU34 CPU type power cable assembly	1
GPU32 CPU type power cable assembly	1
Screws	4
Tech sheet	1

**Table 41. Components in A100 and A40 GPU card kit with NVLink**

Component	Quantity
A100 extended GPU bracket assembly	2
GPU31 CPU type power cable assembly	1
NVLink sponge left support bumper	1
GPU32 CPU type power cable assembly	1
NVLink sponge right support bumper	1
Screws	4
Tech sheet	1

**Table 42. Components in T4 GPU card kit**

Component	Quantity
Riser right FHHL* GPU card holder bracket assembly	1
Riser left FHHL* GPU card holder bracket assembly	1
Tech sheet	1
*FHHL - Full height half length	

**Table 43. Components in NVLink board sponge kit**

Component	Quantity
NVLink sponge left support bumper	1
NVLink sponge right support bumper	1
Tech sheet	1

You may not need all the components in the kit for GPU installation. For information on riser configurations, see the [expansion card installation guidelines](#) section.

Before you begin, follow the [safefy guidelines](#) and [before working inside the system](#) instructions.

- Use the existing heat sink, cooling fans and air shroud.
  - NOTE:** For more information about supported cooling fans matrix, see the thermal restriction section in *Dell EMC PowerEdge R750xa Technical Specifications* on the product documentation page.
- If required, [install NVLink sponges](#) and [install NVLink bridges](#).
  - NOTE:**
    - Slot priority with NVLink bridges: slot 33, slot 34, slot 31, and slot 32.
    - Slot priority without NVLink bridges: slot 31, slot 33, slot 34, and slot 32.
  - NOTE:** GPUs that require NVLink sponges and bridges are NVIDIA A100 and NVIDIA RTX-A40.
- If installing GPU other than T4 into front GPU riser module then, [replace the GPU bracket](#).
- If installing T4 GPU into front GPU riser module then, [install the GPU riser module card holders](#).
- [Install the GPU](#) into front GPU riser module or [install the GPU](#) into expansion card riser.
  - NOTE:** Mixing of different GPUs are not allowed.
  - NOTE:** See [expansion card installation guidelines](#) to know about risers and slots that support GPU.
  - NOTE:** For information on riser slot location on the system board, see the [System board jumpers and connectors](#) topic.
- If applicable, connect the power cables to the GPU. To know the connectors for GPU on the system board, see the [System board jumpers and connectors](#) topic.
  - NOTE:** Refer to the GPU power cable matrix to know about the requirement of cable for the GPU.

**Table 44. GPU power cable matrix**

Category	Description	Type	Vendor	Cable	Cable quantity	Maximum per system
GPU	CRD,GRPHC,NVIDIA,T4,16GB,70W ,L	HH and HL (FH and LP brackets)	NVIDIA	Not required	Not required	6
GPU	NVIDIA Volta Next 300W DW GPU (A100)-Gen 4	FH and FL	NVIDIA	8 pin cable	1 piece per GPU riser	4
GPU	Nvidia RTX-A40	FH and FL	NVIDIA	8 pin cable	1 piece per GPU riser	4



**Table 44. GPU power cable matrix (continued)**

<b>Category</b>	<b>Description</b>	<b>Type</b>	<b>Vendor</b>	<b>Cable</b>	<b>Cable quantity</b>	<b>Maximum per system</b>
GPU	CRD,GRPHC,32GB,225W,M10,PAS SIV	FH and FL	NVIDIA	6 + 2 pin cable	1 piece per GPU riser	2
GPU	AMD MI100	FH and FL	AMD	6 + 2 pin cable	1 piece per GPU riser	4

HH - Half Height, HL - Half Length, FH - Full Height, FL - Full Length

7. [Install the GPU riser module](#) or [expansion card riser](#). See GPU kit components table for supported GPU risers.
8. [Install the air shroud](#).

After installing, follow the [after working inside the system](#) instructions.

## IDSDM kit

The IDSDM kit contains one IDSDM card. For installation procedure of IDSDM, see [installing the IDSDM module](#) section.

**NOTE:** Ensure to install the IDSDM module in the IDSDM/USB card port and not in the J\_R3\_PCIE\_PWR connector port.

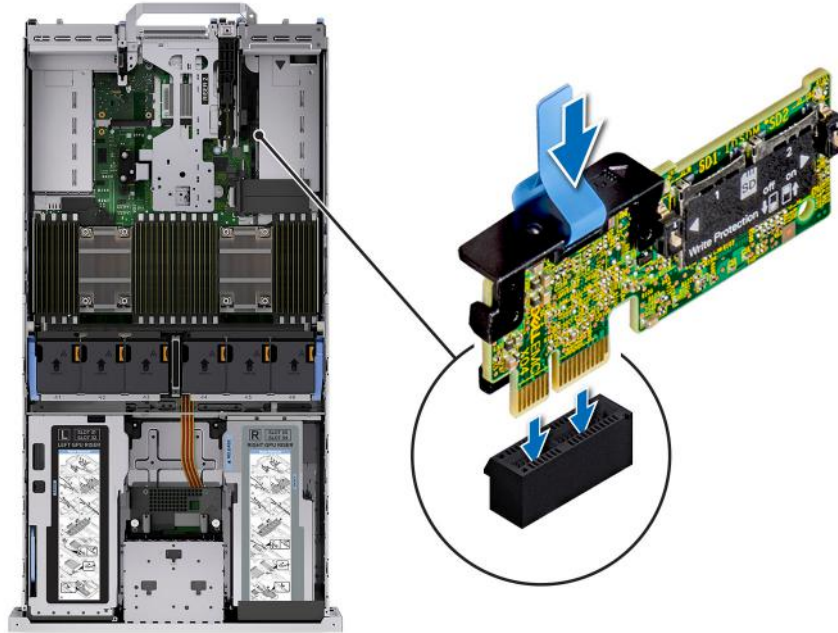


Figure 180. IDSDM port information

## Internal USB card kit

The internal USB card kit contains one internal USB card. For installation of internal USB card, see [installing the internal USB card](#) section.

**NOTE:** Ensure to install the internal USB card in the IDSDM/USB card port and not in the J\_R3\_PCIE\_PWR connector port.

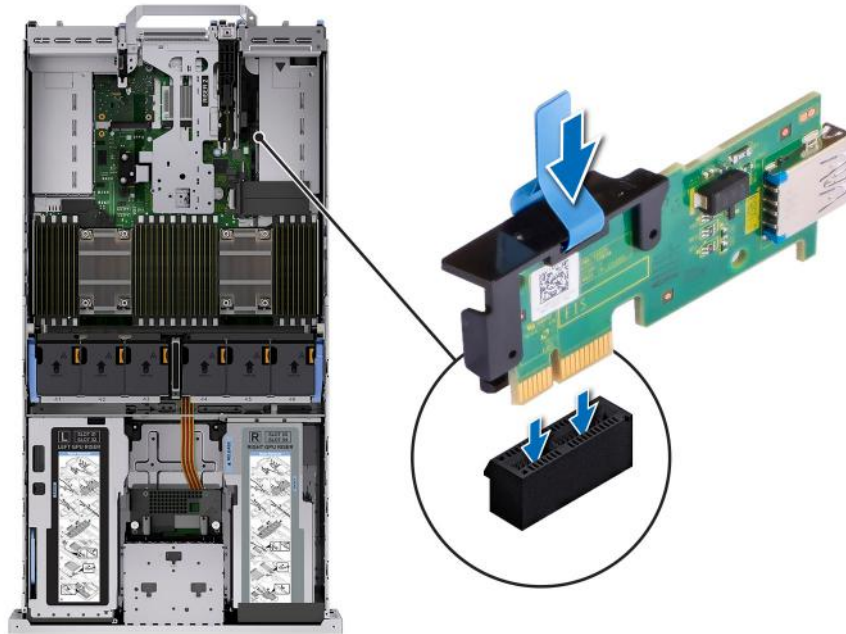


Figure 181. Internal USB card port information

## Serial COM port kit

The serial COM port kit contains the components listed in the table.

Table 45. Serial COM port kit

Components	Quantity
Serial COM port card	1
Cable	1

For installation procedure of the serial COM port, see [www.dell.com/poweredge/manuals](http://www.dell.com/poweredge/manuals) in the serial COM port section.

## VGA port kit

The VGA port kit contains the components listed in the table.

Table 46. VGA port kit

Components	Quantity
VGA port card	1
Cable	1

For installation procedure of the VGA port, see [www.dell.com/poweredge/manuals](http://www.dell.com/poweredge/manuals) in the VGA port section.

# Jumpers and connectors

This section provides essential and specific information about jumpers and switches. It also describes the connectors on the various boards in the system. Jumpers on the system board help to disable the system and reset the passwords. To install components and cables correctly, you must be able to identify the connectors on the system board.

## Topics:

- System board connectors
- System board jumper settings
- Disabling a forgotten password

## System board connectors

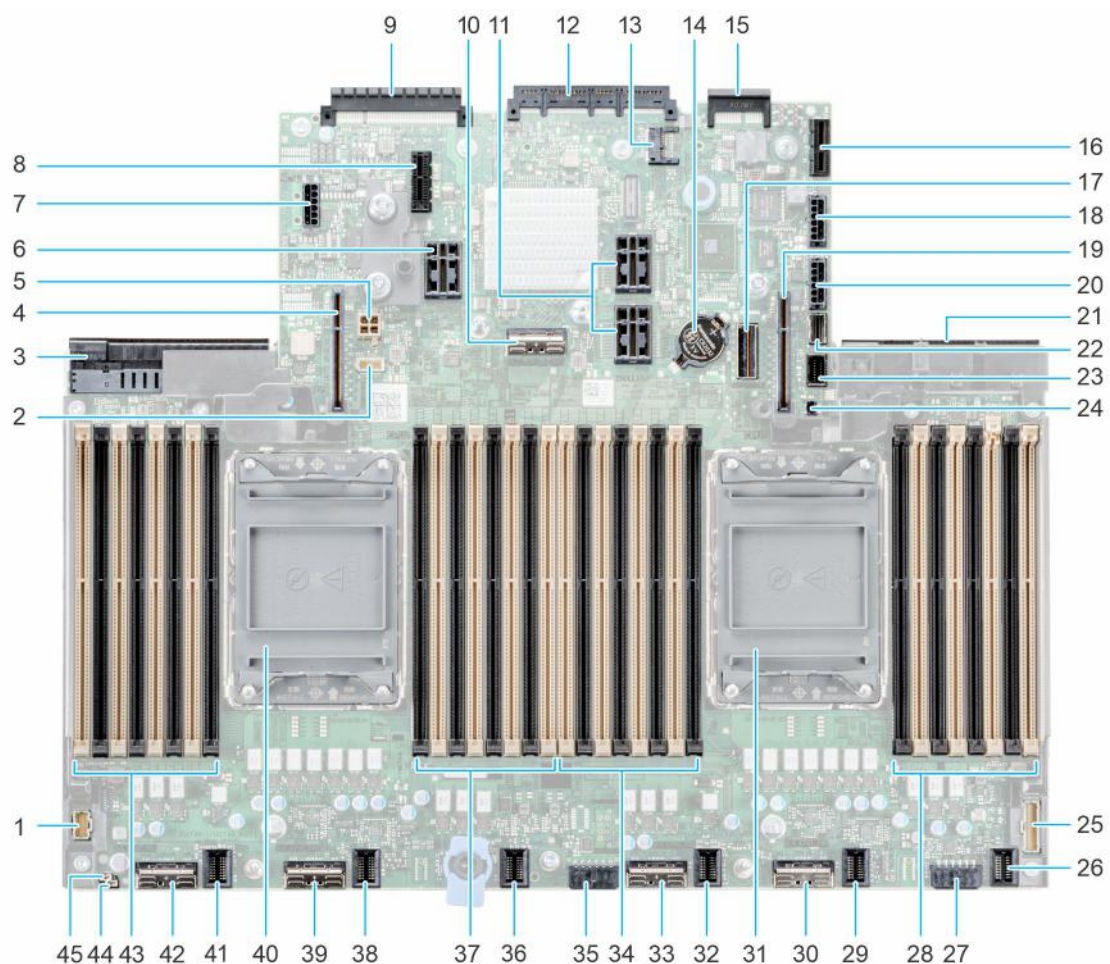


Figure 182. System board jumpers and connectors

Table 47. System board jumpers and connectors

Item	Connector	Description
1.	LFT_CP	Left control panel connector
2.	BAT_SIG	NVDIMM battery signal

**Table 47. System board jumpers and connectors (continued)**

<b>Item</b>	<b>Connector</b>	<b>Description</b>
3.	PSU 2	Power supply unit 2
4.	IO_RISER4 (CPU2)	Riser 4
5.	BAT_PWR_2U	NVDIMM battery power
6.	IO_RISER3 (CPU2)	Riser 3
7.	SIG_PWR_3	Power connector 3 - use for GPU only
8.	J_R3_PCIE_PWR	PCIe riser 3 power
9.	Rear I/O connector	Rear I/O connector
10.	SL5_PCH_SA3_PA3	SATA connector 5
11.	IO_RISER2_A (CPU1) and IO_RISER2_B (CPU2)	Riser 2
12.	OCP NIC 3.0 connector	OCP NIC 3.0 connector
13.	J_TPM	TPM connector
14.	Coin cell battery	Coin cell battery
15.	LOM	LOM connector
16.	IDSDM/Internal USB	IDSDM/Internal USB connector
17.	SL7_CPU1_PA5	PCIe connector 7
18.	SIG_PWR_4	Power connector 4 - use for GPU only
19.	IO_RISER1 (CPU1)	Riser 1
20.	SIG_PWR_0	Power connector 0 - use for GPU only/ Rear BP
21.	PSU 1	Power supply unit 1
22.	SL6_PCH_PA4	PCIe connector 6
23.	FRONT_VIDEO	Front VGA
24.	BOSS_PWR	BOSS card power
25.	RGT_CP	Right control panel connector
26.	2U[FAN6]	Fan 6
27.	SIG_PWR_2	Power connector 2 - use for BP only
28.	A11, A3, A15, A7, A9, A1, A13, A5	DIMM for CPU 1 channels A, B, C, D
29.	2U[FAN5]	Fan 5
30.	SL4_CPU1_PA2	PCIe connector 4
31.	CPU 1	Processor 1
32.	2U[FAN4]	Fan 4
33.	SL3_CPU1_PB2	PCIe connector 3
34.	A6, A14, A2, A10, A8, A16, A4, A12	DIMMs for CPU 1 channels E, F, G, H
35.	SIG_PWR_1	Power connector 1 - use for BP only
36.	2U[FAN3]	Fan 3
37.	B11, B3, B15, B7, B9, B1, B13, B5	DIMM for CPU 2 channels A, B, C, D
38.	2U[FAN2]	Fan 2
39.	SL2_CPU2_PA1	PCIe connector 2





**Table 47. System board jumpers and connectors (continued)**

Item	Connector	Description
40.	CPU 2	Processor 2
41.	2U[FAN1]	Fan 1
42 .	SL1_CPU2_PB1	PCIe connector 1
43.	B6, B14, B2, B10, B8, B16, B4, B12	DIMMs for CPU 2 channels E, F, G, H
44.	NVRAM_CLR	NVRAM_CLR (Jumpers)
45.	PWRD_EN	PWRD_EN (Jumpers)

## System board jumper settings

For information about resetting the password jumper to disable a password, see the [Disabling a forgotten password](#) section.

**Table 48. System board jumper settings**

Jumper	Setting	Description
PWRD_EN	 2 4 6 (default)	The BIOS password feature is enabled.
	 2 4 6	The BIOS password feature is disabled. The BIOS password is now disabled and you are not allowed to set a new password.
NVRAM_CLR	 1 3 5 (default)	The BIOS configuration settings are retained at system boot.
	 1 3 5	The BIOS configuration settings are cleared at system boot.

**CAUTION:** Be careful when changing the BIOS settings. The BIOS interface is designed for advanced users. Any change in the setting could prevent your system from starting correctly and you might have potential loss of data.

## Disabling a forgotten password

The software security features of the system include a system password and a setup password. The password jumper enables or disables password features and clears any password(s) currently in use.

### Prerequisites


**CAUTION:** Many repairs may only be done by a certified service technician. You should only perform troubleshooting and simple repairs as authorized in your product documentation, or as directed by the online or telephone service and support team. Damage due to servicing that is not authorized by Dell is not covered by your warranty. Read and follow the safety instructions that are shipped with your product.

### Steps

1. Power off the system and all attached peripherals. Disconnect the system from the electrical outlet, and disconnect the peripherals.
2. Remove the system cover.
3. Move the jumper on the system board from pins 2 and 4 to pins 4 and 6.
4. Replace the system cover.

**NOTE:** The existing passwords are not disabled (erased) until the system boots with the jumper on pins 4 and 6. However, before you assign a new system and/or setup password, you must move the jumper back to pins 2 and 4.



 **NOTE:** If you assign a new system and/or setup password with the jumper on pins 4 and 6, the system disables the new password(s) the next time it boots.

5. Reconnect the peripherals and connect the system to the electrical outlet, and then power on the system.
6. Power off the system.
7. Remove the system cover.
8. Move the jumper on the system board from pins 4 and 6 to pins 2 and 4.
9. Replace the system cover.
10. Reconnect the peripherals and connect the system to the electrical outlet, and then power on the system.
11. Assign a new system and/or setup password.

# System diagnostics and indicator codes

This section describes the diagnostic indicators on the system front panel that displays the system status during system startup.

## Topics:

- Status LED indicators
- System health and system ID indicator codes
- iDRAC Quick Sync 2 indicator codes
- iDRAC Direct LED indicator codes
- LCD panel
- NIC indicator codes
- Power supply unit indicator codes
- Drive indicator codes
- Using system diagnostics

## Status LED indicators




 **NOTE:** The indicators display solid amber if any error occurs.






Figure 183. Status LED indicators

Table 49. Status LED indicators and descriptions

Icon	Description	Condition	Corrective action
	Drive indicator	The indicator turns solid amber if there is a drive error.	<ul style="list-style-type: none"> <li>• Check the System Event Log to determine if the drive has an error.</li> <li>• Run the appropriate Online Diagnostics test. Restart the system and run embedded diagnostics (ePSA).</li> <li>• If the drives are configured in a RAID array, restart the system, and enter the host adapter configuration utility program.</li> </ul>
	Temperature indicator	The indicator turns solid amber if the system experiences a thermal error (for example, the ambient temperature is out of range or there is a fan failure).	<p>Ensure that none of the following conditions exist:</p> <ul style="list-style-type: none"> <li>• A cooling fan has been removed or has failed.</li> <li>• System cover, air shrouds, or back filler bracket has been removed.</li> <li>• Ambient temperature is too high.</li> <li>• External airflow is obstructed.</li> </ul> <p>If the problem persists, see the <a href="#">Getting help</a> section.</p>

**Table 49. Status LED indicators and descriptions (continued)**

Icon	Description	Condition	Corrective action
	Electrical indicator	The indicator turns solid amber if the system experiences an electrical error (for example, voltage out of range, or a failed power supply unit (PSU) or voltage regulator).	Check the System Event Log or system messages for the specific issue. If it is due to a problem with the PSU, check the LED on the PSU. Reseat the PSU.  If the problem persists, see the <a href="#">Getting help</a> section.
	Memory indicator	The indicator turns solid amber if a memory error occurs.	Check the System Event Log or system messages for the location of the failed memory. Reseat the memory module.  If the problem persists, see the <a href="#">Getting help</a> section.
	PCIe indicator	The indicator turns solid amber if a PCIe card experiences an error.	Restart the system. Update any required drivers for the PCIe card. Reinstall the card.  If the problem persists, see the <a href="#">Getting help</a> section.
<p><b>NOTE:</b> For more information about the supported PCIe cards, see the <a href="#">Expansion card installation guidelines</a> section.</p>			

## System health and system ID indicator codes

The system health and system ID indicator is located on the left control panel of the system.



**Figure 184. System health and system ID indicator**

**Table 50. System health and system ID indicator codes**

System health and system ID indicator code	Condition
Solid blue	Indicates that the system is powered on, is healthy, and system ID mode is not active. Press the system health and system ID button to switch to system ID mode.
Blinking blue	Indicates that the system ID mode is active. Press the system health and system ID button to switch to system health mode.
Solid amber	Indicates that the system is in fail-safe mode. If the problem persists, see the <a href="#">Getting help</a> section.
Blinking amber	Indicates that the system is experiencing a fault. Check the System Event Log for specific error messages. For information about the event and error messages generated by the system firmware and agents that monitor system components, go to <a href="http://qrl.dell.com">qrl.dell.com</a> > <b>Look Up</b> > <b>Error Code</b> , type the error code, and then click <b>Look it up</b> .

# iDRAC Quick Sync 2 indicator codes

iDRAC Quick Sync 2 module (optional) is located on the left control panel of the system.



**Table 51. iDRAC Quick Sync 2 indicators and descriptions**

iDRAC Quick Sync 2 indicator code	Condition	Corrective action
Off (default state)	Indicates that the iDRAC Quick Sync 2 feature is powered off. Press the iDRAC Quick Sync 2 button to power on the iDRAC Quick Sync 2 feature.	If the LED fails to power on, reseal the left control panel flex cable and check. If the problem persists, see the <a href="#">Getting help</a> section.
Solid white	Indicates that iDRAC Quick Sync 2 is ready to communicate. Press the iDRAC Quick Sync 2 button to power off.	If the LED fails to power off, restart the system. If the problem persists, see the <a href="#">Getting help</a> section.
Blinks white rapidly	Indicates data transfer activity.	If the indicator continues to blink indefinitely, see the <a href="#">Getting help</a> section.
Blinks white slowly	Indicates that firmware update is in progress.	If the indicator continues to blink indefinitely, see the <a href="#">Getting help</a> section.
Blinks white five times rapidly and then powers off	Indicates that the iDRAC Quick Sync 2 feature is disabled.	Check if iDRAC Quick Sync 2 feature is configured to be disabled by iDRAC. If the problem persists, see the <a href="#">Getting help</a> section. <a href="http://www.dell.com/poweredge manuals">www.dell.com/poweredge manuals</a> or <i>Dell OpenManage Server Administrator User's Guide</i> at <a href="https://www.dell.com/openmanagemanuals">https://www.dell.com/openmanagemanuals</a> .
Solid amber	Indicates that the system is in fail-safe mode.	Restart the system. If the problem persists, see the <a href="#">Getting help</a> section.
Blinking amber	Indicates that the iDRAC Quick Sync 2 hardware is not responding properly.	Restart the system. If the problem persists, see the <a href="#">Getting help</a> section.

# iDRAC Direct LED indicator codes

The iDRAC Direct LED indicator lights up to indicate that the port is connected and is being used as a part of the iDRAC subsystem.

You can configure iDRAC Direct by using a USB to micro USB (type AB) cable, which you can connect to your laptop or tablet. Cable length should not exceed 3 feet (0.91 meters). Performance could be affected by cable quality. The following table describes iDRAC Direct activity when the iDRAC Direct port is active:

**Table 52. iDRAC Direct LED indicator codes**

iDRAC Direct LED indicator code	Condition
Solid green for two seconds	Indicates that the laptop or tablet is connected.
Blinking green (on for two seconds and off for two seconds)	Indicates that the laptop or tablet connected is recognized.

**Table 52. iDRAC Direct LED indicator codes (continued)**

iDRAC Direct LED indicator code	Condition
LED Indicator off	Indicates that the laptop or tablet is unplugged.

## LCD panel

The LCD panel provides system information, status, and error messages to indicate if the system is functioning correctly or requires attention. The LCD panel is used to configure or view the iDRAC IP address of the system. For information about the event and error messages generated by the system firmware and agents that monitor system components, go to [qrl.dell.com](http://qrl.dell.com) > **Look Up > Error Code**, type the error code, and then click **Look it up..**

The LCD panel is available only on the optional front bezel. The optional front bezel is hot pluggable.

The status and conditions of the LCD panel are outlined here:

- The LCD backlight is white during normal operating conditions.
- If there is an issue, the LCD backlight turns amber and displays an error code followed by descriptive text.
  - ⓘ **NOTE:** If the system is connected to a power source and an error is detected, the LCD turns amber regardless of whether the system is powered on or off.
- When the system powers off and there are no errors, the LCD enters the standby mode after five minutes of inactivity. Press any button on the LCD to power it on.
- If the LCD panel stops responding, remove the bezel and reinstall it.
  - If the problem persists, see [Getting help](#).
- The LCD backlight remains off if LCD messaging is powered off using the iDRAC utility, the LCD panel, or other tools.



**Figure 185. LCD panel features**




**Table 53. LCD panel features**

Item	Button or display	Description
1	Left	Moves the cursor back in one-step increments.
2	Select	Selects the menu item highlighted by the cursor.
3	Right	Moves the cursor forward in one-step increments. During message scrolling: <ul style="list-style-type: none"> <li>• Press and hold the right button to increase scrolling speed.</li> <li>• Release the button to stop.</li> </ul> ⓘ <b>NOTE:</b> The display stops scrolling when the button is released. After 45 seconds of inactivity, the display starts scrolling.
4	LCD display	Displays the system information, status, and error messages or iDRAC IP address.


## Viewing Home screen

The **Home** screen displays user-configurable information about the system. This screen is displayed during normal system operation when there are no status messages or errors. When the system turns off and there are no errors, LCD enters the standby mode after five minutes of inactivity. Press any button on the LCD to turn it on.

### Steps

1. To view the **Home** screen, press one of the three navigation buttons (Select, Left, or Right).
2. To navigate to the **Home** screen from another menu, complete the following steps:
  - a. Press and hold the navigation button till the up arrow  is displayed.
  - b. Navigate to the **Home** icon  using the up arrow .
  - c. Select the **Home** icon.
  - d. On the **Home** screen, press the **Select** button to enter the main menu.


## Setup menu

 **NOTE:** When you select an option in the Setup menu, you must confirm the option before proceeding to the next action.

**Table 54. Setup menu**

Option	Description
iDRAC	Select <b>DHCP</b> or <b>Static IP</b> to configure the network mode. If <b>Static IP</b> is selected, the available fields are <b>IP</b> , <b>Subnet (Sub)</b> , and <b>Gateway (Gtw)</b> . Select <b>Setup DNS</b> to enable DNS and to view domain addresses. Two separate DNS entries are available.
Set error	Select <b>SEL</b> to view LCD error messages in a format that matches the IPMI description in the SEL. This enables you to match an LCD message with an SEL entry. Select <b>Simple</b> to view LCD error messages in a simplified user-friendly description. For information about the event and error messages generated by the system firmware and agents that monitor system components, go to <a href="http://qrl.dell.com">qrl.dell.com</a> > <b>Look Up</b> > <b>Error Code</b> , type the error code, and then click <b>Look it up</b> ..
Set home	Select the default information to be displayed on the <b>Home</b> screen. See <a href="#">View menu</a> section for the options and option items that can be set as the default on the <b>Home</b> screen.

## View menu

 **NOTE:** When you select an option in the View menu, you must confirm the option before proceeding to the next action.

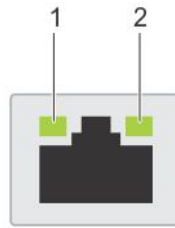
**Table 55. View menu**

Option	Description
iDRAC IP	Displays the <b>IPv4</b> or <b>IPv6</b> addresses for iDRAC9. Addresses include <b>DNS (Primary and Secondary)</b> , <b>Gateway, IP</b> , and <b>Subnet</b> (IPv6 does not have Subnet).
MAC	Displays the MAC addresses for <b>iDRAC</b> , <b>iSCSI</b> , or <b>Network</b> devices.
Name	Displays the name of the <b>Host</b> , <b>Model</b> , or <b>User String</b> for the system.
Number	Displays the <b>Asset tag</b> or the <b>Service tag</b> for the system.
Power	Displays the power output of the system in BTU/hr or Watts. The display format can be configured in the <b>Set home</b> submenu of the <b>Setup</b> menu.
Temperature	Displays the temperature of the system in Celsius or Fahrenheit. The display format can be configured in the <b>Set home</b> submenu of the <b>Setup</b> menu.



## NIC indicator codes

Each NIC on the back of the system has indicators that provide information about the activity and link status. The activity LED indicator indicates if data is flowing through the NIC, and the link LED indicator indicates the speed of the connected network.



**Figure 186. NIC indicator codes**

1. Link LED indicator
2. Activity LED indicator

**Table 56. NIC indicator codes**

NIC indicator codes	Condition
Link and activity indicators are off.	Indicates that the NIC is not connected to the network.
Link indicator is green, and activity indicator is blinking green.	Indicates that the NIC is connected to a valid network at its maximum port speed, and data is being sent or received.
Link indicator is amber, and activity indicator is blinking green.	Indicates that the NIC is connected to a valid network at less than its maximum port speed, and data is being sent or received.
Link indicator is green, and activity indicator is off.	Indicates that the NIC is connected to a valid network at its maximum port speed, and data is not being sent or received.
Link indicator is amber, and activity indicator is off.	Indicates that the NIC is connected to a valid network at less than its maximum port speed, and data is not being sent or received.
Link indicator is blinking green, and activity is off.	Indicates that the NIC identity is enabled through the NIC configuration utility.

## Power supply unit indicator codes

AC and DC power supply units (PSUs) have an illuminated translucent handle that serves as an indicator. The indicator shows if power is present or if a power fault has occurred.



**Figure 187. AC PSU status indicator**

1. AC PSU handle
2. Socket
3. Release latch

**Table 57. AC PSU status indicator codes**

Power indicator codes	Condition
Green	Indicates that a valid power source is connected to the PSU and the PSU is operational.
Blinking amber	Indicates an issue with the PSU.
Not powered on	Indicates that the power is not connected to the PSU.
Blinking green	Indicates that the firmware of the PSU is being updated. <b>⚠ CAUTION: Do not disconnect the power cord or unplug the PSU when updating firmware. If firmware update is interrupted, the PSUs will not function.</b>
Blinking green and powers off	When hot-plugging a PSU, it blinks green five times at a rate of 4 Hz and powers off. This indicates a PSU mismatch due to efficiency, feature set, health status, or supported voltage. <b>⚠ CAUTION: If two PSUs are installed, both the PSUs must have the same type of label; for example, Extended Power Performance (EPP) label. Mixing PSUs from previous generations of PowerEdge servers is not supported, even if the PSUs have the same power rating. This results in a PSU mismatch condition or failure to power on the system.</b> <b>⚠ CAUTION: If two PSUs are used, they must be of the same type and have the same maximum output power.</b> <b>⚠ CAUTION: When correcting a PSU mismatch, replace the PSU with the blinking indicator. Swapping the PSU to make a matched pair can result in an error condition and an unexpected system shutdown. To change from a high output configuration to a low output configuration or vice versa, you must power off the system.</b> <b>⚠ CAUTION: AC PSUs support both 240 V and 120 V input voltages with the exception of Titanium PSUs, which support only 240 V. When two identical PSUs receive different input voltages, they can output different wattages, and trigger a mismatch.</b>

**Table 58. DC PSU status indicator codes**

Power indicator codes	Condition
Green	Indicates that a valid power source is connected to the PSU, and the PSU is operational.
Blinking amber	Indicates an issue with the PSU.
Not powered on	Indicates that the power is not connected to the PSU.
Blinking green	When hot-plugging a PSU, it blinks green five times at a rate of 4 Hz and powers off. This indicates a PSU mismatch due to efficiency, feature set, health status, or supported voltage. <b>⚠ CAUTION: If two PSUs are installed, both the PSUs must have the same type of label; for example, Extended Power Performance (EPP) label. Mixing PSUs from previous generations of PowerEdge servers is not supported, even if the PSUs have the</b>

**Table 58. DC PSU status indicator codes (continued)**

Power indicator codes	Condition
	<p>same power rating. This results in a PSU mismatch condition, or failure to power on the system.</p> <p>⚠ <b>CAUTION:</b> If two PSUs are used, they must be of the same type and have the same maximum output power.</p> <p>⚠ <b>CAUTION:</b> When correcting a PSU mismatch, replace the PSU with the blinking indicator. Swapping the PSU to make a matched pair can result in an error condition and an unexpected system shutdown. To change from a High Output configuration to a Low Output configuration or conversely, you must power off the system.</p> <p>⚠ <b>CAUTION:</b> Combining AC and DC PSUs is not supported.</p>

## Drive indicator codes

The LEDs on the drive carrier indicate the state of each drive. Each drive carrier has two LEDs: an activity LED (green) and a status LED (bicolor, green/amber). The activity LED blinks whenever the drive is accessed.



**Figure 188. Drive indicators on the drive and the mid drive tray backplane**

1. Drive activity LED indicator
2. Drive status LED indicator
3. Drive capacity label


**NOTE:** If the drive is in the Advanced Host Controller Interface (AHCI) mode, the status LED indicator does not power on.

**NOTE:** Drive status indicator behavior is managed by Storage Spaces Direct. Not all drive status indicators may be used.

**Table 59. Drive indicator codes**

Drive status indicator code	Condition
Blinks green twice per second	Indicates that the drive is being identified or preparing for removal.
Off	Indicates that the drive is ready for removal.


**Table 59. Drive indicator codes (continued)**

Drive status indicator code	Condition
	 <b>NOTE:</b> The drive status indicator remains off until all drives are initialized after the system is powered on. Drives are not ready for removal during this time.
Blinks green, amber, and then powers off	Indicates that there is an unexpected drive failure.
Blinks amber four times per second	Indicates that the drive has failed.
Blinks green slowly	Indicates that the drive is rebuilding.
Solid green	Indicates that the drive is online.
Blinks green for three seconds, amber for three seconds, and then powers off after six seconds	Indicates that the rebuild has stopped.

## Using system diagnostics

If you experience an issue with the system, run the system diagnostics before contacting Dell for technical assistance. The purpose of running system diagnostics is to test the system hardware without using additional equipment or risking data loss. If you are unable to fix the issue yourself, service and support personnel can use the diagnostics results to help you solve the issue.

## Dell Embedded System Diagnostics

 **NOTE:** The Dell Embedded System Diagnostics is also known as Enhanced Pre-boot System Assessment (ePSA) diagnostics.

The Embedded System Diagnostics provide a set of options for particular device groups or devices allowing you to:

- Run tests automatically or in an interactive mode
- Repeat tests
- Display or save test results
- Run thorough tests to introduce additional test options to provide extra information about the failed device(s)
- View status messages that inform you if tests are completed successfully
- View error messages that inform you of issues encountered during testing

## Running the Embedded System Diagnostics from the Dell Lifecycle Controller

### Steps

1. When the system is booting, press F10.
2. Select **Hardware Diagnostics** → **Run Hardware Diagnostics**.  
The **ePSA Pre-boot System Assessment** window is displayed, listing all devices detected in the system. The diagnostics start executing the tests on all the detected devices.

## Running the Embedded System Diagnostics from Boot Manager

Run the Embedded System Diagnostics (ePSA) if your system does not boot.

### Steps

1. When the system is booting, press F11.
2. Use the up arrow and down arrow keys to select **System Utilities** > **Launch Diagnostics**.
3. Alternatively, when the system is booting, press F10, select **Hardware Diagnostics** > **Run Hardware Diagnostics**.

The **ePSA Pre-boot System Assessment** window is displayed, listing all devices detected in the system. The diagnostics starts executing the tests on all the detected devices.

## System diagnostic controls

**Table 60. System diagnostic controls**

<b>Menu</b>	<b>Description</b>
<b>Configuration</b>	Displays the configuration and status information of all detected devices.
<b>Results</b>	Displays the results of all tests that are run.
<b>System health</b>	Provides the current overview of the system performance.
<b>Event log</b>	Displays a time-stamped log of the results of all tests run on the system. This is displayed if at least one event description is recorded.

# Getting help

## Topics:

- [Recycling or End-of-Life service information](#)
- [Contacting Dell Technologies](#)
- [Accessing system information by using QRL](#)
- [Receiving automated support with SupportAssist](#)

## Recycling or End-of-Life service information

Take back and recycling services are offered for this product in certain countries. If you want to dispose of system components, visit [www.dell.com/recyclingworldwide](http://www.dell.com/recyclingworldwide) and select the relevant country.

## Contacting Dell Technologies

Dell provides online and telephone based support and service options. If you do not have an active internet connection, you can find Dell contact information on your purchase invoice, packing slip, bill or Dell product catalog. The availability of services varies depending on the country and product, and some services may not be available in your area. To contact Dell for sales, technical assistance, or customer service issues follow these steps:

### Steps

1. Go to [www.dell.com/support/home](http://www.dell.com/support/home).
2. Select your country from the drop-down menu on the lower right corner of the page.
3. For customized support:
  - a. Enter the system Service Tag in the **Enter a Service Tag, Serial Number, Service Request, Model, or Keyword** field.
  - b. Click **Search**.  
The support page that lists the various support categories is displayed.
4. For general support:
  - a. Select your product category.
  - b. Select your product segment.
  - c. Select your product.  
The support page that lists the various support categories is displayed.
5. For contact details of Dell Global Technical Support:
  - a. Click [Contact Technical Support](#).
  - b. The **Contact Technical Support** page is displayed with details to call, chat, or e-mail the Dell Global Technical Support team.

## Accessing system information by using QRL

You can use the Quick Resource Locator (QRL) located on the information tag in the front of the R750xa system, to access information about Dell EMC PowerEdge R750xa. There is also another QRL for accessing product information located on the back of the system cover.

### Prerequisites

Ensure that your smartphone or tablet has a QR code scanner installed.

The QRL includes the following information about your system:

- How-to videos
- Reference materials, including the Installation and Service Manual, LCD diagnostics, and mechanical overview
- The system service tag to quickly access the specific hardware configuration and warranty information
- A direct link to Dell to contact technical assistance and sales teams

### Steps

1. Go to [www.dell.com/qrl](http://www.dell.com/qrl), and navigate to your specific product or
2. Use your smart phone or tablet to scan the model-specific Quick Resource (QR) code on your system or in the Quick Resource Locator section.

## Quick Resource Locator for PowerEdge R750xa system



Figure 189. Quick Resource Locator for PowerEdge R750xa system

## Receiving automated support with SupportAssist

Dell EMC SupportAssist is an optional Dell EMC Services offering that automates technical support for your Dell EMC server, storage, and networking devices. By installing and setting up a SupportAssist application in your IT environment, you can receive the following benefits:

- Automated issue detection — SupportAssist monitors your Dell EMC devices and automatically detects hardware issues, both proactively and predictively.
- Automated case creation — When an issue is detected, SupportAssist automatically opens a support case with Dell EMC Technical Support.
- Automated diagnostic collection — SupportAssist automatically collects system state information from your devices and uploads it securely to Dell EMC. This information is used by Dell EMC Technical Support to troubleshoot the issue.
- Proactive contact — A Dell EMC Technical Support agent contacts you about the support case and helps you resolve the issue.


The available benefits vary depending on the Dell EMC Service entitlement purchased for your device. For more information about SupportAssist, go to [www.dell.com/supportassist](http://www.dell.com/supportassist).



## Documentation resources

This section provides information about the documentation resources for your system.

To view the document that is listed in the documentation resources table:

- From the Dell EMC support site:
  1. Click the documentation link that is provided in the Location column in the table.
  2. Click the required product or product version.
-  **NOTE:** To locate the model number, see the front of your system.
- 3. On the Product Support page, click **Documentation**.
- Using search engines:
  - Type the name and version of the document in the search box.

**Table 61. Additional documentation resources for your system**

Task	Document	Location
Setting up your system	<p>For more information about installing and securing the system into a rack, see the Rail Installation Guide included with your rail solution.</p> <p>For information about setting up your system, see the <i>Getting Started Guide</i> document that is shipped with your system.</p>	<a href="http://www.dell.com/poweredgemanuals">www.dell.com/poweredgemanuals</a>
Configuring your system	<p>For information about the iDRAC features, configuring and logging in to iDRAC, and managing your system remotely, see the Integrated Dell Remote Access Controller User's Guide.</p> <p>For information about understanding Remote Access Controller Admin (RACADM) subcommands and supported RACADM interfaces, see the RACADM CLI Guide for iDRAC.</p> <p>For information about Redfish and its protocol, supported schema, and Redfish Eventing implemented in iDRAC, see the Redfish API Guide.</p> <p>For information about iDRAC property database group and object descriptions, see the Attribute Registry Guide.</p> <p>For information about Intel QuickAssist Technology, see the Integrated Dell Remote Access Controller User's Guide.</p>	<a href="http://www.dell.com/poweredgemanuals">www.dell.com/poweredgemanuals</a>
	<p>For information about earlier versions of the iDRAC documents.</p> <p>To identify the version of iDRAC available on your system, on the iDRAC web interface, click <b>? &gt; About</b>.</p>	<a href="http://www.dell.com/idracmanuals">www.dell.com/idracmanuals</a>

**Table 61. Additional documentation resources for your system (continued)**

Task	Document	Location
	For information about installing the operating system, see the operating system documentation.	<a href="http://www.dell.com/operatingsystemmanuals">www.dell.com/operatingsystemmanuals</a>
	For information about updating drivers and firmware, see the Methods to download firmware and drivers section in this document.	<a href="http://www.dell.com/support/drivers">www.dell.com/support/drivers</a>
Managing your system	For information about systems management software offered by Dell, see the Dell OpenManage Systems Management Overview Guide.	<a href="http://www.dell.com/poweredgemanuals">www.dell.com/poweredgemanuals</a>
	For information about setting up, using, and troubleshooting OpenManage, see the Dell OpenManage Server Administrator User's Guide.	<a href="http://www.dell.com/openmanagemanuals">www.dell.com/openmanagemanuals</a> > OpenManage Server Administrator
	For information about installing and using Dell SupportAssist, see the Dell EMC SupportAssist Enterprise User's Guide.	<a href="https://www.dell.com/serviceabilitytools">https://www.dell.com/serviceabilitytools</a>
	For information about partner programs enterprise systems management, see the OpenManage Connections Enterprise Systems Management documents.	<a href="http://www.dell.com/openmanagemanuals">www.dell.com/openmanagemanuals</a>
Working with the Dell PowerEdge RAID controllers	For information about understanding the features of the Dell PowerEdge RAID controllers (PERC), Software RAID controllers, or BOSS card and deploying the cards, see the Storage controller documentation.	<a href="http://www.dell.com/storagecontrollermanuals">www.dell.com/storagecontrollermanuals</a>
Understanding event and error messages	For information about the event and error messages generated by the system firmware and agents that monitor system components, go to <a href="http://qrl.dell.com">qrl.dell.com</a> > <b>Look Up</b> > <b>Error Code</b> , type the error code, and then click <b>Look it up</b> .	<a href="http://www.dell.com/qrl">www.dell.com/qrl</a>
Troubleshooting your system	For information about identifying and troubleshooting the PowerEdge server issues, see the Server Troubleshooting Guide.	<a href="http://www.dell.com/poweredgemanuals">www.dell.com/poweredgemanuals</a>