

Dell™ PowerEdge™ R210 Systems Hardware Owner's Manual

[About Your System](#)

[Using the System Setup Program and UEFI Boot Manager](#)

[Installing System Components](#)

[Troubleshooting Your System](#)



[Running the System Diagnostics](#)

[Jumpers and Connectors](#)

[Getting Help](#)

[Glossary](#)

Notes, Cautions, and Warnings

-  **NOTE:** A NOTE indicates important information that helps you make better use of your computer.
 -  **CAUTION:** A CAUTION indicates potential damage to hardware or loss of data if instructions are not followed.
 -  **WARNING:** A WARNING indicates a potential for property damage, personal injury, or death.
-

Information in this document is subject to change without notice.
© 2009 Dell Inc. All rights reserved.

Reproduction of these materials in any manner whatsoever without the written permission of Dell Inc. is strictly forbidden.

Trademarks used in this text: *Dell*, the *DELL* logo, and *PowerEdge* are trademarks of Dell Inc.; *Microsoft*, *Windows*, *Windows Server*, and *MS-DOS* are either trademarks or registered trademarks of Microsoft Corporation in the United States and/or other countries.

Other trademarks and trade names may be used in this document to refer to either the entities claiming the marks and names or their products. Dell Inc. disclaims any proprietary interest in trademarks and trade names other than its own.

August 2009 Rev. A00

About Your System

Dell™ PowerEdge™ R210 Systems Hardware Owner's Manual

- [Accessing System Features During Startup](#)
- [Front-Panel Features and Indicators](#)
- [Back-Panel Features and Indicators](#)
- [Guidelines for Connecting External Devices](#)
- [NIC Indicator Codes](#)
- [Diagnostic Lights](#)
- [System Messages](#)
- [Warning Messages](#)
- [Diagnostics Messages](#)
- [Alert Messages](#)
- [Other Information You May Need](#)

Accessing System Features During Startup

The following keystrokes provide access to system features during startup.



Keystroke	Description
<F2>	Enters the System Setup program. See Using the System Setup Program and UEFI Boot Manager .
<F10>	Enters System Services, which opens the Unified Server Configurator (USC). The USC allows you to access utilities such as embedded system diagnostics. For more information, see the Unified Server Configurator documentation.
<F11>	Enters the BIOS Boot Manager or the UEFI Boot Manager, depending on the system's boot configuration. See Using the System Setup Program and UEFI Boot Manager .
<F12>	Starts PXE boot.
<Ctrl><E>	Enters the Baseboard Management Controller (BMC) or iDRAC Configuration Utility, which allows access to the System Event Log (SEL) and configuration of remote access to the system. For more information, see the BMC or iDRAC user documentation.
<Ctrl><C>	Enters the SAS Configuration Utility. For more information, see your SAS adapter documentation.
<Ctrl><R>	Enters the RAID configuration utility. For more information, see the documentation for your SAS RAID card.
<Ctrl><S>	Enters the utility to configure NIC settings for PXE boot. For more information, see the documentation for your integrated NIC.

Front-Panel Features and Indicators

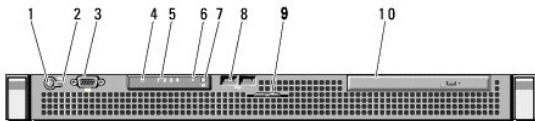
Figure 1-1. Front-Panel Features and Indicators



Item	Indicator, Button, or Connector	Icon	Description
1	Power-on indicator/ power button		<p>The power-on indicator lights when the system power is on.</p> <p>The power button controls the DC power supply output to the system. When the system bezel is installed, the power button is not accessible.</p> <p>NOTE: When powering on the system, the video monitor can take from several seconds to over 2 minutes to display an image, depending on the amount of memory installed in the system.</p> <p>NOTE: On ACPI-compliant operating systems, turning off the system using the power button causes the system to perform a graceful shutdown before power to the system is turned off.</p>
2	NMI button		<p>Used to troubleshoot software and device driver errors when using certain operating systems. This button can be pressed using the end of a paper clip.</p> <p>Use this button only if directed to do so by qualified support personnel or by the operating system's documentation.</p>
3	Video connector		Connects a monitor to the system.







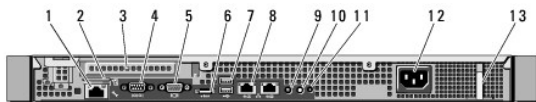

4	Hard drive activity indicator		Lights up when the hard drive is in use.
5	Diagnostic indicator lights (4)		The four diagnostic indicator lights display error codes during system startup. See Diagnostic Lights .
6	System status indicator		Lights blue during normal system operation. Lights amber when the system needs attention due to a problem.
7	System identification button		The system identification buttons on the front and back panels can be used to locate a particular system within a rack. When one of the buttons is pushed, the system status indicators on the front and back panels light blue until one of the buttons is pushed again.
8	USB connectors (2)		Connects USB devices to the system. The ports are USB 2.0-compliant.
9	System identification panel		A slide-out panel for system information including the Express Service Tag, embedded NIC MAC address, and iDRAC6 Enterprise card MAC address. Space is provided for an additional label.
10	Optical drive (optional)		One optional slim-line SATA DVD-ROM drive or DVD+/-RW drive, or combination CD-RW/DVD drive (when available). NOTE: DVD devices are data only.

Back-Panel Features and Indicators

[Figure 1-2](#) shows the controls, indicators, and connectors located on the system's back panel.

Figure 1-2. Back-Panel Features and Indicators



Item	Indicator, Button, or Connector	Icon	Description
1	iDRAC6 Enterprise port (optional)		Dedicated management port for the optional iDRAC6 Enterprise card.
2	VFlash media slot (optional)		Connects an external SD memory card for the optional iDRAC6 Enterprise card.
3	PCIe expansion card slot		Connects a PCI Express expansion card.
4	Serial connector		Connects a serial device to the system.
5	Video connector		Connects a VGA display to the system.
6	eSATA		Connects additional storage devices.
7	USB connectors (2)		Connects USB devices to the system. The ports are USB 2.0-compliant.
8	Ethernet connectors (2)		Embedded 10/100/1000 NIC connectors.
9	System status indicator		Lights blue during normal system operation. Lights amber when the system needs attention due to a problem.
10	System identification button		The system identification buttons on the front and back panels can be used to locate a particular system within a rack. When one of the buttons is pushed, the system status indicators on the front and back panels light blue until one of the buttons is pushed again.
11	System identification connector		Connects the optional system status indicator assembly through the optional cable management arm.
12	Power supply		250 W power supply.
13	Retention clip		Secures the power cable.

Guidelines for Connecting External Devices

- 1 Turn off power to the system and external devices before attaching a new external device. Turn on any external devices before turning on the system (unless the documentation for the device specifies otherwise).
- 1 Ensure that the appropriate driver for the attached device has been installed on the system.
- 1 If necessary to enable ports on your system, use the System Setup program. See [Entering the System Setup Program](#).

NIC Indicator Codes

Figure 1-3. NIC Indicator Codes

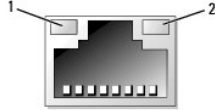

1	link indicator	2	activity indicator
---	----------------	---	--------------------

Indicator	Indicator Code
Link and activity indicators are off	The NIC is not connected to the network.
Link indicator is green	The NIC is connected to a valid network link at 1000 Mbps.
Link indicator is amber	The NIC is connected to a valid network link at 10/100 Mbps.
Activity indicator is green blinking	Network data is being sent or received.

Diagnostic Lights

The four diagnostic indicator lights on the system front panel display error codes during system startup. [Table 1-1](#) lists the causes and possible corrective actions associated with these codes. A highlighted circle indicates the light is on; a non-highlighted circle indicates the light is off.

Table 1-1. Diagnostic Indicator Code

Code	Causes	Corrective Action
①②③④	The system is in a normal off condition or a possible pre-BIOS failure has occurred. The diagnostic lights are not lit after the system successfully boots to the operating system. The system is in a normal operating condition after POST.	Plug the system into a working electrical outlet and press the power button. Information only.
①②③④	BIOS checksum failure detected; system is in recovery mode.	See Getting Help .
①②③④	Possible processor failure.	See Troubleshooting the Processor .
①②③④	Memory failure.	See Troubleshooting System Memory .
①②③④	Possible expansion card failure.	See Troubleshooting an Expansion Card .
①②③④	Possible video failure.	See Getting Help .
①②③④	Hard drive failure.	Ensure that the diskette drive and hard drive are properly connected. See Hard Drives for information on the drives installed in your system.
①②③④	Possible USB failure.	See Troubleshooting a USB Device .

①②③④	No memory modules detected.	See Troubleshooting System Memory .
①②③④	System board failure.	See Getting Help .
①②③④	Memory configuration error.	See Troubleshooting System Memory .
①②③④	Possible system board resource and/or system board hardware failure.	See Getting Help .
①②③④	Possible system resource configuration error.	See Getting Help .
①②③④	Other failure.	Ensure that the optical drive and hard drives are properly connected. See Troubleshooting Your System for the appropriate drive installed in your system. If the problem persists, see Getting Help .

System Messages

System messages appear on the screen to notify you of a possible problem with the system.

NOTE: If you receive a system message not listed in the table, check the documentation for the application that is running when the message appears or the operating system's documentation for an explanation of the message and recommended action.

Message	Causes	Corrective Actions
Alert! iDRAC6 not responding. Rebooting.	The optional iDRAC6 is not responding to BIOS communication either because it is not functioning properly or has not completed initialization. The system will reboot.	Wait for the system to reboot.
Alert! iDRAC6 not responding. Power required may exceed PSU wattage. Alert! Continuing system boot accepts the risk that system may power down without warning.	The optional iDRAC6 is hung. The optional iDRAC6 was remotely reset while system was booting. After AC recovery, the iDRAC6 takes longer than normal to boot.	Remove AC power to the system for 10 seconds and restart the system.
Alert! Continuing system boot accepts the risk that system may power down without warning.	The system configuration of processor, memory modules, and expansion card may not be supported by the power supply.	If any system components were just upgraded, return the system to the previous configuration. If the system boots without this warning, then the replaced component(s) are not supported with this power supply. See Power Supply .
Alert! System fatal error during previous boot.	An error caused the system to reboot.	Check other system messages for additional information for possible causes.
BIOS MANUFACTURING MODE detected. MANUFACTURING MODE will be cleared before the next boot. System reboot required for normal operation.	System is in manufacturing mode.	Reboot to take the system out of manufacturing mode.
BIOS Update Attempt Failed!	Remote BIOS update attempt failed.	Retry the BIOS update. If problem persists, see Getting Help .
Caution! NVRAM_CLR jumper is installed on system board. Please run SETUP.	NVRAM_CLR jumper is installed in the clear setting. CMOS has been cleared.	Move the NVRAM_CLR jumper to the default position (pins 3 and 5). See Figure 6-1 for Jumper location. Restart the system and re-enter the BIOS settings. See Using the System Setup Program and UEFI Boot Manager .
CPU set to minimum frequency.	The processor speed may be intentionally set lower for power conservation.	If not an intentional setting, check any other system messages for possible causes.
Current boot mode is set to UEFI. Please ensure compatible bootable media is available. Use the system setup program to change the boot mode as needed.	The system failed to boot because UEFI boot mode is enabled in BIOS and the boot operating system is non-UEFI.	Ensure that the boot mode is set correctly and that the proper bootable media is available. See Using the System Setup Program and UEFI Boot Manager .
Decreasing available memory.	Faulty or improperly installed memory modules.	Reseat the memory modules. See Troubleshooting System Memory .
Embedded NICx and NICy: OS NIC=<ENABLED /DISABLED>, Management Shared NIC=<ENABLED /DISABLED>	The operating system NIC interface is set in BIOS. The Management Shared NIC interface is set in management tools.	Check the system management software or the System Setup program for NIC settings. If a problem is indicated, see Troubleshooting a NIC .
Error 8602 - Auxiliary Device Failure. Verify that mouse and keyboard are securely attached to correct connectors.	Mouse or keyboard cable is loose or improperly connected. Defective mouse or keyboard.	Reseat the mouse or keyboard cable. Ensure that the mouse or keyboard is operational. See Troubleshooting a USB Device .
Gate A20 failure.	Faulty keyboard controller; faulty system board.	See Getting Help .
General failure.	The operating system is unable to carry out	This message is usually followed by specific information. Note

	the command.	the information, and take the appropriate action to resolve the problem.
Invalid configuration information - please run SETUP program.	An invalid system configuration caused a system halt.	Run the System Setup program and review the current settings. See Using the System Setup Program and UEFI Boot Manager .
Keyboard controller failure.	Faulty keyboard controller; faulty system board.	See Getting Help .
Keyboard data line failure.	Keyboard cable connector is improperly connected or the keyboard is defective.	Reseat the keyboard cable. If the problem persists, see Troubleshooting a USB Device .
Keyboard stuck key failure.		
Keyboard fuse has failed.	Overcurrent detected at the keyboard connector.	See Getting Help .
Local keyboard may not work because all user accessible USB ports are disabled. If operating locally, power cycle the system and enter system setup program to change settings.	The USB ports are disabled in the system BIOS.	Power down and restart the system from the power button, and then enter the System Setup program to enable the USB port(s). See Entering the System Setup Program .
Manufacturing mode detected.	System is in manufacturing mode.	Reboot to take the system out of manufacturing mode.
Maximum rank count exceeded. The following DIMM has been disabled: x	Invalid memory configuration. The system will run but with the specified memory module disabled.	Ensure that the memory modules are installed in a valid configuration. See General Memory Module Installation Guidelines .
Memory address line failure at address, read value expecting value.	Faulty or improperly installed memory modules.	See Troubleshooting System Memory .
Memory double word logic failure at address, read value expecting value.	Faulty or improperly installed memory modules.	See Troubleshooting System Memory .
Memory Initialization Warning: Memory size may be reduced.	Invalid memory configuration. The system will run but with less memory than is physically available.	Ensure that the memory modules are installed in a valid configuration. See General Memory Module Installation Guidelines .
Memory odd/even logic failure at address, read value expecting value.	Faulty or improperly installed memory modules.	See Troubleshooting System Memory .
Memory write/read failure at address, read value expecting value.	Faulty or improperly installed memory modules.	See Troubleshooting System Memory .
Memory set to minimum frequency.	The memory frequency may be intentionally set lower for power conservation. The current memory configuration may support only the minimum frequency.	If not an intentional setting, check any other system messages for possible causes. Ensure that your memory configuration supports the higher frequency. See General Memory Module Installation Guidelines .
Memory tests terminated by keystroke.	POST memory test was terminated by pressing the spacebar.	Information only.
MEMTEST lane failure detected on x.	Invalid memory configuration. A mismatched memory module is installed.	Ensure that the memory modules are installed in a valid configuration. See General Memory Module Installation Guidelines .
No boot device available.	Faulty or missing optical drive subsystem, hard drive, or hard-drive subsystem, or no bootable USB key installed.	Use a bootable USB key, CD, or hard drive. If the problem persists, see Troubleshooting a USB Device , Troubleshooting an Optical Drive , and Troubleshooting a Hard Drive . See Using the System Setup Program and UEFI Boot Manager for information on setting the order of boot devices.
No boot sector on hard drive.	Incorrect configuration settings in System Setup program, or no operating system on hard drive.	Check the hard-drive configuration settings in the System Setup program. See Using the System Setup Program and UEFI Boot Manager . If necessary, install the operating system on your hard drive. See your operating system documentation.
No timer tick interrupt.	Faulty system board.	See Getting Help .
PCI BIOS failed to install.	PCIe device BIOS (Option ROM) checksum failure detected during shadowing. Cables to expansion card loose; faulty or improperly installed expansion card.	Reseat the expansion card. Ensure that all appropriate cables are securely connected to the expansion card. If the problem persists, see Troubleshooting an Expansion Card .
PCIe Training Error: Expected Link Width is x, Actual Link Width is y.	Faulty or improperly installed PCIe card in the specified slot.	Reseat the PCIe card in the specified slot. See Troubleshooting an Expansion Card . If the problem persists, see Getting Help .
Plug & Play Configuration Error.	Error encountered in initializing PCIe device; faulty system board.	Install the NVRAM_CLR jumper in the clear position (pins 1 and 3) and reboot the system. See Figure 6-1 for jumper location. If the problem persists, see Troubleshooting an Expansion Card .
Quad rank DIMM detected after single rank or dual rank DIMM in socket.	Invalid memory configuration.	Ensure that the memory modules are installed in a valid configuration. See General Memory Module Installation Guidelines .
Read fault.	The operating system cannot read from the USB medium or device, hard drive, or optical drive or the system could not find a particular sector on the disk, or the requested sector is defective.	Replace the optical medium, USB medium or device. Ensure that the USB or SATA cables are properly connected. See Troubleshooting a USB Device , Troubleshooting an Optical Drive , or Troubleshooting a Hard Drive for the appropriate drive(s) installed in your system.
Requested sector not found.		
SATA Portx device not found.	There is no device connected to the specified SATA port.	Information only.
SATA port x device auto-sensing error.	The drive connected to the specified SATA port is faulty.	Replace the faulty drive.
SATA port x device configuration error.		

SATA port x device error.		
Sector not found. Seek error. Seek operation failed.	Faulty hard drive or USB medium or device.	Replace the USB medium or device. Ensure that the USB is properly connected. See Troubleshooting a USB Device or Troubleshooting a Hard Drive for the appropriate drive(s) installed in your system.
Shutdown failure.	General system error.	See Getting Help .
The amount of system memory has changed.	Memory has been added or removed or a memory module may be faulty.	If memory has been added or removed, this message is informative and can be ignored. If memory has not been added or removed, check the SEL to determine if single-bit or multi-bit errors were detected and replace the faulty memory module. See Troubleshooting System Memory .
The following DIMMs should match in geometry: x,x,...	Invalid memory configuration. The specified memory modules do not match in size, number of ranks, or number of data lanes.	Ensure that the memory modules are installed in a valid configuration. See General Memory Module Installation Guidelines .
The following DIMMs should match in rank count: x,x,...		
The following DIMMs should match in size: x,x,...		
The following DIMMs should match in size and geometry: x,x,...		
The following DIMMs should match in size and rank count: x,x,...		
Thermal sensor not detected on x.	A memory module without a thermal sensor is installed in the specified memory slot.	Replace the memory module. System Memory .
Time-of-day clock stopped.	Faulty battery or faulty chip.	See Troubleshooting the System Battery .
Time-of-day not set - please run SETUP program.	Incorrect Time or Date settings: faulty system battery.	Check the Time and Date settings. See Using the System Setup Program and UEFI Boot Manager . If the problem persists, replace the system battery. See System Battery .
Timer chip counter 2 failed.	Faulty system board.	See Getting Help .
TPM configuration operation honored. System will now reset.	A Trusted Platform Module (TPM) configuration command has been entered. The system will reboot and execute the command.	Information only.
TPM configuration operation is pending. Press (I) to Ignore OR (M) to Modify to allow this change and reset the system. WARNING: Modifying could prevent security.	This message displays during system restart after a TPM configuration command has been entered. User interaction is required to proceed.	Enter I or M to proceed.
TPM failure.	A TPM function has failed.	See Getting Help .
Unable to launch System Services image. System halted!	System halted after F10 keystroke because System Services image is either corrupted in the system firmware or has been lost due to system board replacement. The iDRAC6 Enterprise card flash memory may be corrupted.	Restart the system and update the USC repository to the latest software to restore full functionality. See the USC user documentation for more information. Restore the flash memory using the latest version on support.dell.com . See the iDRAC6 user's guide for instructions on performing a field replacement of the flash memory.
Unexpected interrupt in protected mode.	Improperly seated memory modules or faulty keyboard/mouse controller chip.	Reseat the memory modules. See Troubleshooting System Memory . If the problem persists, see Getting Help .
Unsupported CPU combination. Unsupported CPU stepping detected.	Processor is not supported by the system.	Install a supported processor. See Processor .
Unsupported DIMM detected. The following DIMM has been disabled: x	Invalid memory configuration. The system will run but with the specified memory module disabled.	Ensure that the memory modules are installed in a valid configuration. See General Memory Module Installation Guidelines .
Unsupported memory configuration. DIMM mismatch across slots detected: x,x,...	Invalid memory configuration. Memory modules are mismatched in the specified slots.	Ensure that the memory modules are installed in a valid configuration. See General Memory Module Installation Guidelines .
Warning: A fatal error has caused system reset! Please check the system event log!	A fatal system error occurred and caused the system to reboot.	Check the SEL for information that was logged during the error. See the applicable troubleshooting section in Troubleshooting Your System for any faulty components specified in the SEL.
Warning: Control Panel is not installed.	The control panel is not installed or has a faulty cable connection.	Install the control panel, or check the cable connections between the display module, the control panel board, and the system board. See Control Panel Assembly .
Warning! No micro code update loaded for processor n.	Micro code update failed.	Update the BIOS firmware. See Getting Help .
Warning! Performance degraded. CPU and memory set to minimum frequencies to meet PSU wattage. System will reboot.	The system configuration of processor, memory modules, and expansion card may not be supported by the power supplies.	If any system components were just upgraded, return the system to the previous configuration. If the system boots without this warning, then the replaced component(s) are not supported with this power supply. See Power Supply .
Warning! Unsupported memory configuration detected. The memory configuration is not optimal. The recommended memory configuration is: <message>	Invalid memory configuration. The system will run but with reduced functionality.	Ensure that the memory modules are installed in a valid configuration. See General Memory Module Installation Guidelines . If the problem persists, see Troubleshooting System Memory .

Write fault Write fault on selected drive.	Faulty USB device or medium, optical drive assembly, hard drive, or hard-drive subsystem.	Replace the USB medium or device. Ensure that the USB or SATA cables are properly connected. See Troubleshooting a USB Device , Troubleshooting an Optical Drive , and Troubleshooting a Hard Drive .
---	---	---

NOTE: For the full name of an abbreviation or acronym used in this table, see the [Glossary](#).

Warning Messages

A warning message alerts you to a possible problem and prompts you to respond before the system continues a task. For example, before you format a hard drive, a message will warn you that you may lose all data on the hard drive. Warning messages usually interrupt the task and require you to respond by typing y (yes) or n (no).

 **NOTE:** Warning messages are generated by either the application or the operating system. For more information, see the documentation that accompanied the operating system or application.

Diagnostics Messages

The system diagnostic utilities may issue messages if you run diagnostic tests on your system. See [Running the System Diagnostics](#) for more information about system diagnostics.

Alert Messages

Systems management software generates alert messages for your system. Alert messages include information, status, warning, and failure messages for drive, temperature, fan, and power conditions. For more information, see the systems management software documentation.

Other Information You May Need

 **WARNING:** See the safety and regulatory information that shipped with your system. Warranty information may be included within this document or as a separate document.

- 1 The rack documentation included with your rack solution describes how to install your system into a rack.
- 1 The *Getting Started Guide* provides an overview of system features, setting up your system, and technical specifications.
- 1 Any media that ships with your system that provides documentation and tools for configuring and managing your system, including those pertaining to the operating system, system management software, system updates, and system components that you purchased with your system.

 **NOTE:** Always check for updates on support.dell.com/manuals and read the updates first because they often supersede information in other documents.

[Back to Contents Page](#)

[Back to Contents Page](#)

Running the System Diagnostics

Dell™ PowerEdge™ R210 Systems Hardware Owner's Manual

- [Using Online Diagnostics](#)
- [Embedded System Diagnostics Features](#)
- [When to Use the Embedded System Diagnostics](#)
- [Running the Embedded System Diagnostics](#)
- [System Diagnostics Testing Options](#)
- [Using the Custom Test Options](#)

If you experience a problem with your system, run the diagnostics before calling for technical assistance. The purpose of the diagnostics is to test your system's hardware without requiring additional equipment or risking data loss. If you are unable to fix the problem yourself, service and support personnel can use diagnostics test results to help you solve the problem.

Using Online Diagnostics

To assess a system problem, first use the online diagnostics. Online Diagnostics is a suite of diagnostic programs, or test modules, that include diagnostic tests on chassis and storage components such as hard drives, physical memory, communications and printer ports, NICs, CMOS, and more. If you are unable to identify the problem using the online diagnostics, then use the embedded system diagnostics.

The files required to run the online diagnostics for systems running supported Microsoft® Windows® and Linux operating systems are available at support.dell.com and on the CDs that came with your system. For information about using diagnostics, see the *Dell Online Diagnostics User's Guide*.

Embedded System Diagnostics Features

The system diagnostics provides a series of menus and options for particular device groups or devices. The system diagnostics menus and options allow you to:

- 1 Run tests individually or collectively
- 1 Control the sequence of tests
- 1 Repeat tests
- 1 Display, print, or save test results
- 1 Temporarily suspend testing if an error is detected or terminate testing when a user-defined error limit is reached
- 1 View help messages that briefly describe each test and its parameters
- 1 View status messages that inform you if tests are completed successfully
- 1 View error messages that inform you of problems encountered during testing

When to Use the Embedded System Diagnostics

If a major component or device in the system does not operate properly, component failure may be indicated. As long as the processor and the system's input/output devices are functioning, you can use the embedded system diagnostics to help identify the problem.

Running the Embedded System Diagnostics

The embedded system diagnostics program is run from the Unified Server Configurator (USC) screen.

 **CAUTION:** Use the embedded system diagnostics to test only your system. Using this program with other systems may cause invalid results or error messages.

1. As the system boots, press <F10>.
2. Click **Diagnostics** in the left pane and click **Launch Diagnostics** in the right pane.

The **Diagnostics** menu allows you to run all or specific diagnostics tests or to exit.

System Diagnostics Testing Options

Click the testing option in the **Main Menu** window.

Testing Option	Function
Express Test	Performs a quick check of the system. This option runs device tests that do not require user interaction.
Extended Test	Performs a more thorough check of the system. This test can take an hour or longer.
Custom Test	Tests a particular device.
Information	Displays test results.

Using the Custom Test Options

When you select **Custom Test** in the **Main Menu** window, the **Customize** window allows you to select the device(s) to be tested, select specific options for testing, and view the test results.

Selecting Devices for Testing

The left side of the **Customize** window lists devices that can be tested. Click the **(+)** next to a device or module to view its components. Click **(+)** on any component to view the tests that are available. Clicking a device, rather than its components, selects all of the components of the device for testing.

 **NOTE:** After you select all the devices and components that you want to test, highlight **All Devices** and then click **Run Tests**.

Selecting Diagnostics Options

From the **Diagnostics Options** area, select the test(s) you want to run on a device.

- 1 **Non-Interactive Tests Only** — Runs only tests that require no user intervention.
- 1 **Quick Tests Only** — Runs only the quick tests on the device.
- 1 **Show Ending Timestamp** — Time stamps the test log.
- 1 **Test Iterations** — Selects the number of times the test is run.
- 1 **Log output file pathname** — Enables you to specify the diskette drive or USB memory key where the test log file is saved. You cannot save the file to a hard drive.

Viewing Information and Results

The following tabs in the **Customize** window provide information about the test and the test results:

- 1 **Results** — Displays the test that ran and the result.
- 1 **Errors** — Displays any errors that occurred during the test.
- 1 **Help** — Displays information about the currently selected device, component, or test.
- 1 **Configuration** — Displays basic configuration information about the currently selected device.
- 1 **Parameters** — Displays parameters that you can set for the test.

[Back to Contents Page](#)

[Back to Contents Page](#)

Getting Help

Dell™ PowerEdge™ R210 Systems Hardware Owner's Manual

Contacting Dell

For customers in the United States, call 800-WWW-DELL (800-999-3355).

 **NOTE:** If you do not have an active Internet connection, you can find contact information on your purchase invoice, packing slip, bill, or Dell product catalog.

Dell provides several online and telephone-based support and service options. Availability varies by country and product, and some services may not be available in your area. To contact Dell for sales, technical support, or customer service issues:

1. Visit support.dell.com.
 2. Verify your country or region in the **Choose A Country/Region** drop-down menu at the bottom of the page.
 3. Click **Contact Us** on the left side of the page.
 4. Select the appropriate service or support link based on your need.
 5. Choose the method of contacting Dell that is convenient for you.
-

[Back to Contents Page](#)

[Back to Contents Page](#)

Glossary

Dell™ PowerEdge™ R210 Systems Hardware Owner's Manual

A — Ampere(s).

AC — Alternating current.

ACPI — Advanced Configuration and Power Interface. A standard interface for enabling the operating system to direct configuration and power management.

ambient temperature — The temperature of the area or room where the system is located.

ANSI — American National Standards Institute. The primary organization for developing technology standards in the U.S.

asset tag — An individual code assigned to a system, usually by an administrator, for security or tracking purposes.

backup — A copy of a program or data file. As a precaution, back up your system's hard drive(s) on a regular basis.

blade — A module that contains a processor, memory, and a hard drive. The modules are mounted into a chassis that includes power supplies and fans.

BMC — Baseboard management controller.

bootable media — A CD, diskette, or USB memory key that is used to start your system if the system will not boot from the hard drive.

BTU — British thermal unit.

bus — An information pathway between the components of a system. Your system contains an expansion bus that allows the processor to communicate with controllers for the peripheral devices connected to the system. Your system also contains an address bus and a data bus for communications between the processor and RAM.

C — Celsius.

cache — A fast storage area that keeps a copy of data or instructions for quick data retrieval.

cm — Centimeter(s).

COMn — The device names for the serial ports on your system.

control panel — The part of the system that contains indicators and controls, such as the power button and power indicator.

controller — A chip or expansion card that controls the transfer of data between the processor and memory or between the processor and a peripheral device.

coprocessor — A chip that relieves the system's processor of specific processing tasks. A math coprocessor, for example, handles numeric processing.

CPU — Central processing unit. See *processor*.

DC — Direct current.

DDR — Double-data rate. A technology in memory modules that potentially doubles the data rate by transferring data on both the rising and falling pulses of a clock cycle.

device driver — A program that allows the operating system or some other program to interface correctly with a peripheral.

DHCP — Dynamic Host Configuration Protocol. A method of automatically assigning an IP address to a client system.

diagnostics — A comprehensive set of tests for your system.

DIMM — Dual in-line memory module. See also *memory module*.

DNS — Domain Name System. A method of translating Internet domain names, such as **www.example.com**, into IP addresses, such as 208.77.188.166.

DRAM — Dynamic random-access memory. A system's RAM is usually made up entirely of DRAM chips.

driver — See *device driver*.

DVD — Digital versatile disc or digital video disc.

ECC — Error checking and correction.

EMI — Electromagnetic interference.

ERA — Embedded remote access. ERA allows you to perform remote, or "out-of-band," server management on your network server using a remote access controller.

ESD — Electrostatic discharge.

ESM — Embedded server management.

expansion bus — Your system contains an expansion bus that allows the processor to communicate with controllers for peripherals, such as NICs.

expansion card — An add-in card, such as a NIC or SCSI adapter, that plugs into an expansion-card connector on the system board. An expansion card adds some specialized function to the system by providing an interface between the expansion bus and a peripheral.

expansion-card connector — A connector on the system board or riser board for plugging in an expansion card.

F — Fahrenheit.

FAT — File allocation table. The file system structure used by MS-DOS to organize and keep track of file storage. The Microsoft® Windows® operating systems can optionally use a FAT file system structure.

Fibre Channel — A high-speed network interface used primarily with networked storage devices.

flash memory — A type of electronic chip that can be programmed and reprogrammed using a software utility.

FSB — Front-side bus. The FSB is the data path and physical interface between the processor and the main memory (RAM).

FTP — File transfer protocol.

g — Gram(s).

G — Gravities.

Gb — Gigabit(s); 1024 megabits or 1,073,741,824 bits.

GB — Gigabyte(s); 1024 megabytes or 1,073,741,824 bytes. However, when referring to hard-drive capacity, the term is usually rounded to 1,000,000,000 bytes.

graphics mode — A video mode that can be defined as x horizontal by y vertical pixels by z colors.

host adapter — A controller that implements communication between the system's bus and the peripheral device, typically a storage device.

hot-swap — The ability to insert or install a device, typically a hard drive or an internal cooling fan, into the host system while the system is powered on and running.

Hz — Hertz.

I/O — Input/output. A keyboard is an input device, and a monitor is an output device. In general, I/O activity can be differentiated from computational activity.

IDE — Integrated drive electronics. A standard interface between the system board and storage devices.

iDRAC — Internet Dell Remote Access Controller. A remote access controller that uses the Internet SCSI protocol.

IP — Internet Protocol.

IPv6 — Internet Protocol version 6.

IPX — Internet package exchange.

IRQ — Interrupt request. A signal that data is about to be sent to or received by a peripheral device travels by an IRQ line to the processor. Each peripheral connection must be assigned an IRQ number. Two devices can share the same IRQ assignment, but you cannot operate both devices simultaneously.

iSCSI — Internet SCSI (see *SCSI*). A protocol that enables SCSI device communication across a network or the Internet.

jumper — Small blocks on a circuit board with two or more pins emerging from them. Plastic plugs containing a wire fit down over the pins. The wire connects the pins and creates a circuit, providing a simple and reversible method of changing the circuitry in a board.

K — Kilo-; 1000.

Kb — Kilobit(s); 1024 bits.

KB — Kilobyte(s); 1024 bytes.

Kbps — Kilobit(s) per second.

KBps — Kilobyte(s) per second.

kg — Kilogram(s); 1000 grams.

kHz — Kilohertz.

KVM — Keyboard/video/mouse. KVM refers to a switch that allows selection of the system from which the video is displayed and for which the keyboard and mouse are used.

LAN — Local area network. A LAN is usually confined to the same building or a few nearby buildings, with all equipment linked by wiring dedicated specifically to the LAN.

LED — Light-emitting diode. An electronic device that lights up when a current is passed through it.

LGA — Land grid array.

local bus — On a system with local-bus expansion capability, certain peripheral devices (such as the video adapter circuitry) can be designed to run much faster than they would with a traditional expansion bus. See also *bus*.

LOM — LAN on motherboard.

LVD — Low voltage differential.

m — Meter(s).

mA — Milliampere(s).

MAC address — Media Access Control address. Your system's unique hardware number on a network.

mAh — Milliampere-hour(s).

Mb — Megabit(s); 1,048,576 bits.

MB — Megabyte(s); 1,048,576 bytes. However, when referring to hard-drive capacity, the term is often rounded to mean 1,000,000 bytes.

Mbps — Megabits per second.

MBps — Megabytes per second.

MBR — Master boot record.

memory address — A specific location, usually expressed as a hexadecimal number, in the system's RAM.

memory module — A small circuit board containing DRAM chips that connects to the system board.

memory — An area in your system that stores basic system data. A system can contain several different forms of memory, such as integrated memory (ROM and RAM) and add-in memory modules (DIMMs).

memory key — A portable flash memory storage device integrated with a USB connector.

MHz — Megahertz.

mirroring — A type of data redundancy in which a set of physical drives stores data and one or more sets of additional drives stores duplicate copies of the data. Mirroring functionality is provided by software. See also *striping* and *RAID*.

mm — Millimeter(s).

ms — Millisecond(s).

NAS — Network Attached Storage. NAS is one of the concepts used for implementing shared storage on a network. NAS systems have their own operating systems, integrated hardware, and software that are optimized to serve specific storage needs.

NIC — Network interface controller. A device that is installed or integrated in a system to allow connection to a network.

NMI — Nonmaskable interrupt. A device sends an NMI to signal the processor about hardware errors.

ns — Nanosecond(s).

NVRAM — Nonvolatile random-access memory. Memory that does not lose its contents when you turn off your system. NVRAM is used for maintaining the date, time, and system configuration information.

parity — Redundant information that is associated with a block of data.

parity stripe — In RAID arrays, a striped hard drive containing parity data.

partition — You can divide a hard drive into multiple physical sections called *partitions* with the **fdisk** command. Each partition can contain multiple logical drives. You must format each logical drive with the **format** command.

PCI — Peripheral Component Interconnect. A standard for local-bus implementation.

PDU — Power distribution unit. A power source with multiple power outlets that provides electrical power to servers and storage systems in a rack.

peripheral — An internal or external device, such as a diskette drive or keyboard, connected to a system.

pixel — A single point on a video display. Pixels are arranged in rows and columns to create an image. A video resolution, such as 640 x 480, is expressed as the number of pixels across by the number of pixels up and down.

POST — Power-on self-test. Before the operating system loads when you turn on your system, the POST tests various system components such as RAM and hard drives.

processor — The primary computational chip inside the system that controls the interpretation and execution of arithmetic and logic functions. Software written for one processor must usually be revised to run on another processor. *CPU* is a synonym for processor.

PXE — Preboot eXecution Environment. A way of booting a system via a LAN (without a hard drive or bootable diskette).

RAC — Remote access controller.

RAID — Redundant array of independent disks. A method of providing data redundancy. Some common implementations of RAID include RAID 0, RAID 1, RAID 5, RAID 10, and RAID 50. See also *mirroring and striping*.

RAM — Random-access memory. The system's primary temporary storage area for program instructions and data. Any information stored in RAM is lost when you turn off your system.

R-DIMM — A registered DDR3 memory module.

readme file — A text file, usually shipped with software or hardware, that contains information supplementing or updating the product's documentation.

read-only file — A read-only file is one that you are prohibited from editing or deleting.

ROM — Read-only memory. Your system contains some programs essential to its operation in ROM code. A ROM chip retains its contents even after you turn off your system. Examples of code in ROM include the program that initiates your system's boot routine and the POST.

ROMB — RAID on motherboard.

SAN — Storage Area Network. A network architecture that enables remote network-attached storage devices to appear to a server to be locally attached.

SAS — Serial-attached SCSI.

SATA — Serial Advanced Technology Attachment. A standard interface between the system board and storage devices.

SCSI — Small computer system interface. An I/O bus interface with faster data transmission rates than standard ports.

SD card — Secure digital flash memory card.

SDRAM — Synchronous dynamic random-access memory.

sec — Second(s).

serial port — A legacy I/O port with a 9-pin connector that transfers data one bit at a time and is most often used to connect a modem to the system.

service tag — A bar code label on the system used to identify it when you call Dell for technical support.

SMART — Self-Monitoring Analysis and Reporting Technology. Allows hard drives to report errors and failures to the system BIOS and then display an error message on the screen.

SMP — Symmetric multiprocessing. Used to describe a system that has two or more processors connected via a high-bandwidth link and managed by an operating system, where each processor has equal access to I/O devices.

SNMP — Simple Network Management Protocol. A standard interface that allows a network manager to remotely monitor and manage workstations.

striping — Disk striping writes data across three or more disks in an array, but only uses a portion of the space on each disk. The amount of space used by a "stripe" is the same on each disk used. A virtual disk may use several stripes on the same set of disks in an array. See also *guarding*, *mirroring*, and *RAID*.

SVGA — Super video graphics array. VGA and SVGA are video standards for video adapters with greater resolution and color display capabilities than previous standards.

system board — As the main circuit board, the system board usually contains most of your system's integral components, such as the processor(s), RAM, controllers for peripherals, and various ROM chips.

system configuration information — Data stored in memory that tells a system what hardware is installed and how the system should be configured for operation.

system memory — See *RAM*.

System Setup program — A BIOS-based program that allows you to configure your system's hardware and customize the system's operation by setting features such as password protection. Because the System Setup program is stored in NVRAM, any settings remain in effect until you change them again.

TCP/IP — Transmission Control Protocol/Internet Protocol.

termination — Some devices (such as the last device at each end of a SCSI cable) must be terminated to prevent reflections and spurious signals in the cable. When such devices are connected in a series, you may need to enable or disable the termination on these devices by changing jumper or switch settings on the devices or by changing settings in the configuration software for the devices.

TOE — TCP/IP offload engine.

U-DIMM — An unregistered (unbuffered) DDR3 memory module.

uplink port — A port on a network hub or switch used to connect to other hubs or switches without requiring a crossover cable.

UPS — Uninterruptible power supply. A battery-powered unit that automatically supplies power to your system in the event of an electrical failure.

USB — Universal Serial Bus. A USB connector provides a single connection point for multiple USB-compliant devices, such as mice and keyboards. USB devices can be connected and disconnected while the system is running.

USB memory key — See *memory key*.

utility — A program used to manage system resources—memory, disk drives, or printers, for example.

V — Volt(s).

VAC — Volt(s) alternating current.

VDC — Volt(s) direct current.

VGA — Video graphics array. VGA and SVGA are video standards for video adapters with greater resolution and color display capabilities than previous standards.

video adapter — The logical circuitry that provides (in combination with the monitor) your system's video capabilities. A video adapter may be integrated into the system board or may be an expansion card that plugs into an expansion slot.

video memory — Most VGA and SVGA video adapters include memory chips in addition to your system's RAM. The amount of video memory installed primarily influences the number of colors that a program can display (with the appropriate video drivers and monitor capabilities).

video resolution — Video resolution (800 x 600, for example) is expressed as the number of pixels across by the number of pixels up and down. To display a program at a specific graphics resolution, you must install the appropriate video drivers and your monitor must support the resolution.

virtualization — The ability via software to share the resources of a single computer across multiple environments. A single physical system may appear to the user as multiple virtual systems able to host multiple operating systems.

W — Watt(s).

WH — Watt-hour(s).

XML — Extensible Markup Language. XML is a way to create common information formats and to share both the format and the data on the World Wide Web, intranets, and elsewhere.

ZIF — Zero insertion force.

[Back to Contents Page](#)

Installing System Components

Dell™ PowerEdge™ R210 Systems Hardware Owner's Manual

- [Recommended Tools](#)
- [Inside the System](#)
- [Front Bezel \(Optional\)](#)
- [Opening and Closing the System](#)
- [Optical Drive \(Optional\)](#)
- [Hard Drives](#)
- [Expansion Card](#)
- [Expansion-Card Riser](#)
- [Internal USB Memory Key](#)
- [Cooling Shroud](#)
- [System Memory](#)
- [Cooling Fans](#)
- [iDRAC6 Express Card \(Optional\)](#)
- [iDRAC6 Enterprise Card \(Optional\)](#)
- [VFlash Media \(Optional\)](#)
- [Processor](#)
- [Power Supply](#)
- [System Battery](#)
- [Control Panel Assembly](#)
- [System Board](#)

Recommended Tools

- 1 Key to the system keylock
- 1 #1 and #2 Phillips screwdrivers
- 1 Wrist grounding strap

Inside the System

CAUTION: Many repairs may only be done by a certified service technician. You should only perform troubleshooting and simple repairs as authorized in your product documentation, or as directed by the online or telephone service and support team. Damage due to servicing that is not authorized by Dell is not covered by your warranty. Read and follow the safety instructions that came with the product.

Figure 3-1. Inside the System

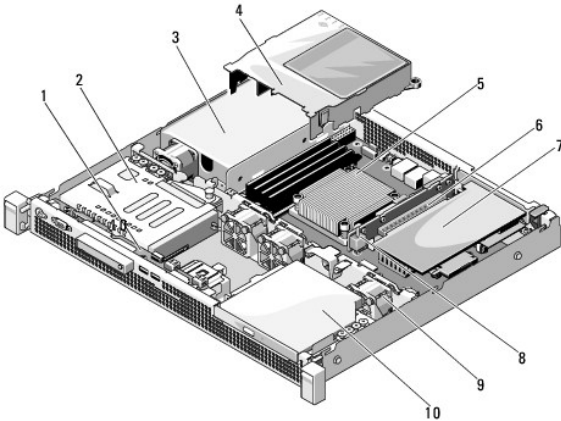

1	control panel board	2	hard drive
3	power supply	4	cooling shroud
5	heat sink/processor	6	expansion-card riser
7	expansion card	8	chassis intrusion switch
9	system cooling fans (3)	10	optical drive

Front Bezel (Optional)

Removing the Front Bezel

1. Using the system key, unlock the front bezel (if locked).
2. Lift up the release latch next to the keylock.
3. Rotate the left end of the bezel away from the front panel.
4. Unhook the right end of the bezel and pull the bezel away from the system.

Figure 3-2. Removing and Installing the Front Bezel

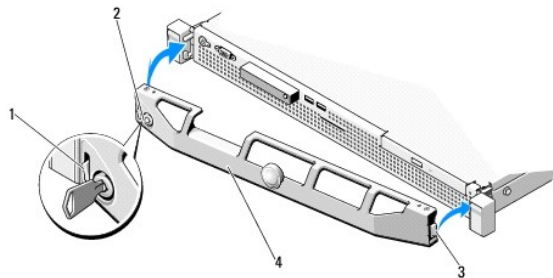

1	release latch	2	keylock
3	hinge tab	4	bezel

Installing the Front Bezel

1. Hook the right end of the bezel onto the chassis.
2. Fit the free end of the bezel onto the system.
3. Secure the bezel with the keylock. See [Figure 3-2](#).

Opening and Closing the System

⚠ WARNING: Whenever you need to lift the system, get others to assist you. To avoid injury, do not attempt to lift the system by yourself.

⚠ CAUTION: Many repairs may only be done by a certified service technician. You should only perform troubleshooting and simple repairs as authorized in your product documentation, or as directed by the online or telephone service and support team. Damage due to servicing that is not authorized by Dell is not covered by your warranty. Read and follow the safety instructions that came with the product.

Opening the System

1. Turn off the system and attached peripherals, and disconnect the system from the electrical outlet and peripherals.
2. Rotate the latch release lock counter clockwise to the unlocked position. See [Figure 3-3](#).
3. Grasp the cover on both sides while pressing your thumbs on the latch release lock and the indent, carefully slide the cover toward the back of the system, and lift it away from the system. See [Figure 3-3](#).

Figure 3-3. Opening and Closing the System Cover

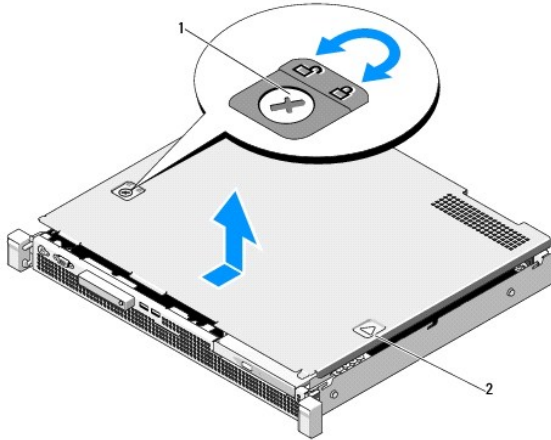

1	latch release lock	2	indent
---	--------------------	---	--------

Closing the System

1. Place the cover onto the chassis and offset it slightly toward the back of the system, so that the two hooks on the back edge of the cover fit over the corresponding slots on the back edge of the chassis. See [Figure 3-3](#).
2. Slide the cover toward the front of the chassis till it snaps in position.
3. Rotate the latch release lock in a clockwise direction to secure the cover.

Optical Drive (Optional)

An optional slimline DVD or DVD+/-RW optical drive slides into the front panel and connects to the SATA controller on the system board.

NOTE: DVD devices are data only.

Removing an Optical Drive

CAUTION: Many repairs may only be done by a certified service technician. You should only perform troubleshooting and simple repairs as authorized in your product documentation, or as directed by the online or telephone service and support team. Damage due to servicing that is not authorized by Dell is not covered by your warranty. Read and follow the safety instructions that came with the product.

1. If installed, remove the front bezel. See [Removing the Front Bezel](#).
2. Turn off the system, including any attached peripherals, and disconnect the system from its electrical outlet.
3. Open the system. See [Opening the System](#).
4. Pull the blue pull tab on the data cable to disconnect it from the back of the drive and the system board.
5. Disconnect the power cable from the back of the drive.

Note the routing of the power and data cables underneath the tabs on the system chassis as you remove them from the system board and drive. You must route these cables properly when you replace them to prevent them from being pinched or crimped.

6. Press down the release latch. Lift and angle the drive to release it from the notch on the metal standoffs.
7. Lift the drive out of the chassis. See [Figure 3-4](#).
8. Close the system. See [Closing the System](#).
9. If applicable, replace the front bezel. See [Installing the Front Bezel](#).

Figure 3-4. Removing the Optical Drive

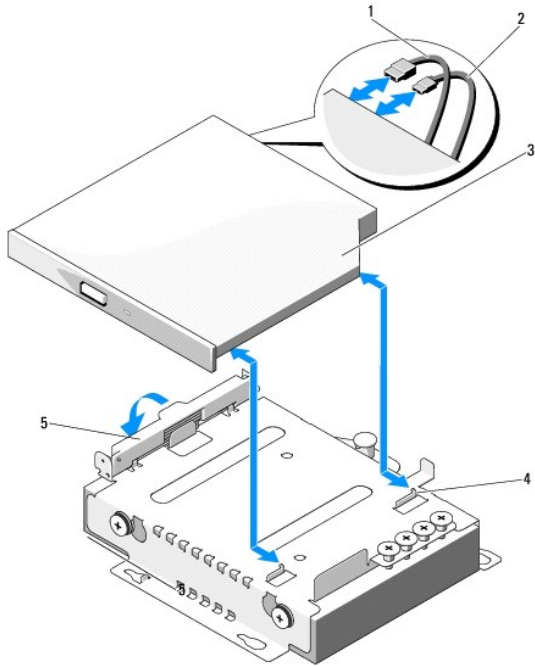

1	data cable	2	power cable
3	optical drive	4	metal standoff with notches (2)
5	release latch		

Installing an Optical Drive

CAUTION: Many repairs may only be done by a certified service technician. You should only perform troubleshooting and simple repairs as authorized in your product documentation, or as directed by the online or telephone service and support team. Damage due to servicing that is not authorized by Dell is not covered by your warranty. Read and follow the safety instructions that came with the product.

1. If installed, remove the front bezel. See [Removing the Front Bezel](#).
2. Turn off the system, including any attached peripherals, and disconnect the system from its electrical outlet.
3. Open the system. See [Opening the System](#).
4. Press down the release latch and place the optical drive in position.
5. Align the two notches on the metal standoffs with the holes on the drive. See [Figure 3-4](#).
6. Slide the drive into the notches and seat it firmly.
7. Push the release latch back to position.
8. Connect the power cable.
9. Connect the data cable to the back of the drive and to the connector on the system board.
You must route these cables properly underneath the tab on the system chassis to prevent them from being pinched or crimped.
10. Connect the data cable to the SATA_C connector on the system board. See [Figure 6-1](#).
11. Close the system. See [Closing the System](#).
12. If applicable, replace the front bezel. See [Installing the Front Bezel](#).

13. Reconnect the system and peripherals to their electrical outlets.

Hard Drives

Your system supports up to two 3.5-inch (SAS or SATA) or 2.5-inch (SAS, SATA, or SSD) hard drives. The hard drives are installed internally in the system (see [Figure 3-1](#)) and connected to the system board.

Removing a Hard Drive

CAUTION: Many repairs may only be done by a certified service technician. You should only perform troubleshooting and simple repairs as authorized in your product documentation, or as directed by the online or telephone service and support team. Damage due to servicing that is not authorized by Dell is not covered by your warranty. Read and follow the safety instructions that came with the product.

1. Turn off the system and attached peripherals, and disconnect the system from the electrical outlet and from the peripherals.
2. Open the system. See [Opening the System](#).
3. Disconnect the data and power cable from the hard drive.
4. If present, remove the optical drive mounted above the hard drive 1 (HDD1) bracket. See [Removing an Optical Drive](#).
5. While pulling the release pin up, grip the hard-drive bracket and slide it away from the chassis wall. See [Figure 3-5](#).
6. Lift the hard-drive bracket away from the system.

Figure 3-5. Removing and Installing a Hard Drive

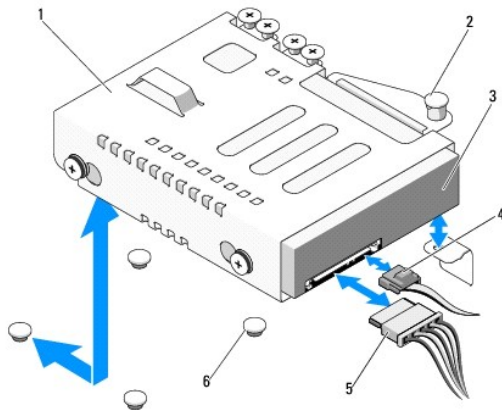

1	drive bracket	2	release pin
3	hard drive	4	data cable
5	power cable	6	chassis tabs (4)

NOTE: If you are not replacing the hard drive, remove the drive from the drive bracket (see [Removing a Hard Drive From a Hard-Drive Bracket](#)) and replace the empty bracket back into the drive bay.

7. Close the system. See [Closing the System](#).

Installing a Hard Drive

CAUTION: Many repairs may only be done by a certified service technician. You should only perform troubleshooting and simple repairs as authorized in your product documentation, or as directed by the online or telephone service and support team. Damage due to servicing that is not authorized by Dell is not covered by your warranty. Read and follow the safety instructions that came with the product.

1. Turn off the system and attached peripherals, and disconnect the system from the electrical outlet and from the peripherals.

2. Open the system. See [Opening the System](#).
3. If present, remove the optical drive mounted above the hard drive 1 (HDD1) bracket. See [Removing an Optical Drive](#).
4. Install the hard drive into the bracket. See [Installing a Hard Drive Into a Hard-Drive Bracket](#).
5. Align the four slots under the hard drive bracket with the four tabs on the chassis and slide the hard drive bracket toward the chassis wall till it snaps into place. See [Figure 3-6](#).

If you replaced HDD1, reinstall the optional optical drive above the HDD1 bracket. See [Installing an Optical Drive](#).

6. Connect the power and data cables to the hard drive:
 1. If connecting to the integrated SATA controller (SATA hard drives only), connect the SATA data cable to the SATA connector on the system board. See [Figure 6-1](#).
 1. If connecting to a SAS RAID controller card (SAS or SATA hard drives), connect the data cable to the connector on the card edge. For information on installing a SAS controller card, see [Installing an Expansion Card](#).
7. Close the system. See [Closing the System](#).
8. Reconnect the system to the electrical outlet and turn on the system and attached peripherals.
9. Enter the System Setup program and ensure that the hard drive's controller is enabled. See [Entering the System Setup Program](#).
10. Exit the System Setup program and reboot the system.

See the documentation that came with the hard drive for instructions on installing any software required for drive operation.

Removing a Hard Drive From a Hard-Drive Bracket

NOTE: A 2.5-inch hard drive is encased in a 2.5-inch hard-drive bracket which is further encased in a 3.5-inch hard-drive bracket.

1. Remove the four screws from the slide rails on the hard-drive bracket.

If you are removing a 2.5-inch hard drive, separate the 2.5-inch hard-drive bracket from the 3.5-inch hard-drive bracket.
2. Separate the hard drive from the bracket. See [Figure 3-6](#).

Figure 3-6. Removing a Hard Drive From a Hard-Drive Bracket

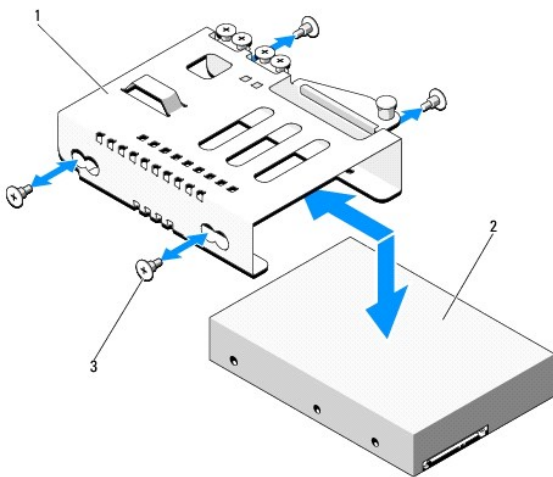

1	hard-drive bracket	2	hard drive
3	screws (4)*		

*Screws are supplied along with the hard drives ordered from Dell.

Installing a Hard Drive Into a Hard-Drive Bracket

NOTE: A 2.5-inch hard drive is encased in a 2.5-inch hard-drive bracket which is further encased in a 3.5-inch hard-drive bracket.

1. Insert the hard drive into the hard-drive bracket. See [Figure 3-6](#).

If you are installing a 2.5-inch hard drive, position the 2.5-inch hard-drive bracket into the 3.5-inch hard drive bracket.

2. Align the holes on the hard drive with the back set of holes on the hard-drive bracket.
3. Attach the four screws to secure the hard drive to the hard-drive bracket.

Expansion Card

Expansion Card Installation Guidelines

Your system supports one PCIe Generation 2 expansion card installed on an expansion-card riser.

- 1 The expansion-card slot supports full-height and half-length cards.
- 1 The expansion-card slot is not hot-swappable.

Installing an Expansion Card

CAUTION: Many repairs may only be done by a certified service technician. You should only perform troubleshooting and simple repairs as authorized in your product documentation, or as directed by the online or telephone service and support team. Damage due to servicing that is not authorized by Dell is not covered by your warranty. Read and follow the safety instructions that came with the product.

1. Unpack the expansion card and prepare it for installation.

For instructions, see the documentation accompanying the card.

2. Turn off the system, including any attached peripherals, and disconnect the system from the electrical outlet.
3. Open the system. See [Opening the System](#).
4. Open the expansion-card latch and remove the filler bracket. See [Figure 3-7](#).
5. Holding the expansion card by its edges, position the card so that the card-edge connector aligns with the expansion-card connector on the expansion-card riser.
6. Insert the card-edge connector firmly into the expansion-card connector until the card is fully seated.
7. Close the expansion-card latch. See [Figure 3-7](#).

Figure 3-7. Installing or Removing an Expansion Card

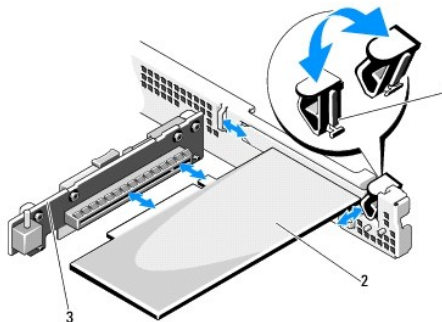

1	expansion-card latch	2	expansion card
---	----------------------	---	----------------

3	expansion-card riser		
---	----------------------	--	--

8. Connect any cables to the expansion card.
9. Close the system. See [Closing the System](#).
10. Reconnect the system to its electrical outlet and turn the system on, including any attached peripherals

Removing an Expansion Card

⚠ CAUTION: Many repairs may only be done by a certified service technician. You should only perform troubleshooting and simple repairs as authorized in your product documentation, or as directed by the online or telephone service and support team. Damage due to servicing that is not authorized by Dell is not covered by your warranty. Read and follow the safety instructions that came with the product.

1. Turn off the system, including any attached peripherals, and disconnect the system from the electrical outlet.
2. Open the system. See [Opening the System](#).
3. Disconnect all cables from the card.
4. Open the expansion-card latch. See [Figure 3-7](#).
5. Grasp the expansion card by its edges and carefully remove it from the connector on the expansion-card riser.
6. If you are removing the card permanently, install a metal filler bracket over the empty expansion slot opening and close the expansion-card latch.

🔧 NOTE: You must install a filler bracket over an empty expansion slot to maintain Federal Communications Commission (FCC) certification of the system. The brackets also keep dust and dirt out of the system and aid in proper cooling and airflow inside the system.

7. Close the system. See [Closing the System](#).
8. Reconnect the system to its electrical outlet and turn the system on, including any attached peripherals.

Expansion-Card Riser

The system's expansion-card riser supports an x16 link Generation 2 PCIe expansion card.

Removing an Expansion-Card Riser

⚠ CAUTION: Many repairs may only be done by a certified service technician. You should only perform troubleshooting and simple repairs as authorized in your product documentation, or as directed by the online or telephone service and support team. Damage due to servicing that is not authorized by Dell is not covered by your warranty. Read and follow the safety instructions that came with the product.

1. Turn off the system, including any attached peripherals, and disconnect the system from the electrical outlet.
2. Open the system. See [Opening the System](#).
3. If installed, remove the expansion card from the expansion slot. See [Removing an Expansion Card](#).
4. To remove the expansion-card riser, press the release tab and lift the expansion-card riser from the chassis. See [Figure 3-8](#).

Figure 3-8. Installing or Removing an Expansion-Card Riser

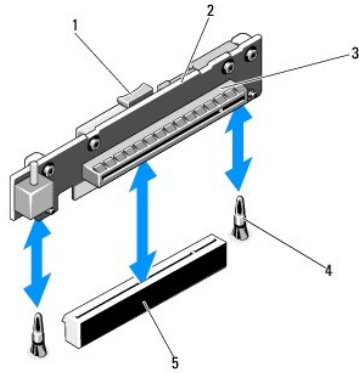

1	release tab	2	expansion-card riser
3	expansion-card slot	4	riser guide posts (2)
5	expansion-card riser connector		

Installing an Expansion-Card Riser

1. Align the expansion-card riser with the riser guide posts on the system board. See [Figure 3-8](#).
2. Lower the expansion-card riser into place until the expansion-card riser connector is fully seated.
3. If applicable, reinstall the expansion card. See [Installing an Expansion Card](#).
4. Close the system. See [Closing the System](#).
5. Reconnect the system to its electrical outlet and turn the system on, including any attached peripherals.

Internal USB Memory Key

The USB memory key can be used as a boot device, security key, or mass storage device. To use the internal USB connector, the **Internal USB Port** option must be enabled in the **Integrated Devices** screen of the System Setup program.

To boot from the USB memory key, you must configure the USB memory key with a boot image and then specify the USB memory key in the boot sequence in the System Setup program. See [Boot Settings Screen](#). For information on creating a bootable file on the USB memory key, see the user documentation that accompanied the USB memory key.

CAUTION: Many repairs may only be done by a certified service technician. You should only perform troubleshooting and simple repairs as authorized in your product documentation, or as directed by the online or telephone service and support team. Damage due to servicing that is not authorized by Dell is not covered by your warranty. Read and follow the safety instructions that came with the product.

NOTE: To avoid interference with other components, the maximum allowable dimensions of the USB key are 24 mm (.94 in) wide x 79 mm (3.11 in) long x 8.6 mm (.33 in) high.

1. Turn off the system, including any attached peripherals, and disconnect the system from the electrical outlet.
2. Open the system. See [Opening the System](#).
3. Locate the USB connector on the control panel board. See [Figure 3-19](#).
4. Insert the USB memory key into the USB connector.
5. Close the system. See [Closing the System](#).
6. Reconnect the system to its electrical outlet and turn the system on, including any attached peripherals.

Figure 3-9. Removing or Installing a USB Memory Key

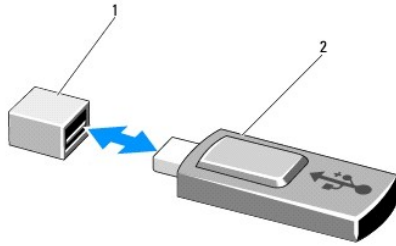

1	USB memory key connector	2	USB memory key
---	--------------------------	---	----------------

Cooling Shroud

The system board shroud covers the processor, heat sink, and memory modules, and provides air flow to these components. Airflow is facilitated by the cooling fan modules, which are positioned directly behind the cooling shroud.

Removing the Cooling Shroud

- ⚠ WARNING:** The memory modules and heat sink can get very hot during normal operation. Ensure that the memory modules and heat sink have had sufficient time to cool before you touch it.
- ⚠ CAUTION:** Many repairs may only be done by a certified service technician. You should only perform troubleshooting and simple repairs as authorized in your product documentation, or as directed by the online or telephone service and support team. Damage due to servicing that is not authorized by Dell is not covered by your warranty. Read and follow the safety instructions that came with the product.
- ⚠ CAUTION:** Never operate your system with the cooling shroud removed. The system may get overheated quickly, resulting in shutdown of the system and loss of data.

1. Turn off the system, including any attached peripherals, and disconnect the system from the electrical outlet.
2. Open the system. See [Opening and Closing the System](#).
3. Hold the touch points and gently lift the shroud straight up and away from the system board. See [Figure 3-10](#).

Figure 3-10. Installing and Removing the Cooling Shroud

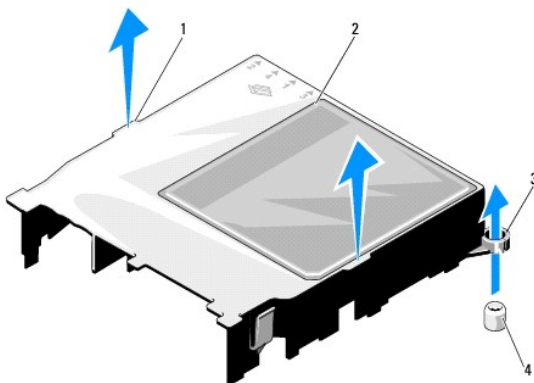

1	touch points (2)	2	cooling shroud
3	guide slots (2)	4	guide screws (2)

Installing the Cooling Shroud

1. Position the cooling shroud by aligning the guide slots with the guide screws on the system board. See [Figure 3-10](#).
2. Push the cooling shroud down until all edges are secured to the system board.
3. Close the system. See [Opening and Closing the System](#).

System Memory

Your system supports single and dual-rank DDR3 unbuffered ECC DIMMs (UDIMMs). DIMMs can be 1066 or 1333 MHz.

The system contains four memory sockets. Each two-socket set is organized into two channels. The first socket of each channel is marked with white release levers.

General Memory Module Installation Guidelines

To ensure optimal performance of your system, observe the following general guidelines when configuring your system memory.

 **NOTE:** Memory configurations that fail to observe these guidelines can prevent your system from starting and producing any video output.

- 1 Except for memory channels that are unused, all populated memory channels must have identical configurations.
- 1 Memory modules of different sizes can be mixed in sockets 1 to 4 (for example, 2 GB and 4 GB), but all populated channels must have identical configurations.
- 1 Memory modules are installed in the numeric order of the sockets beginning with 1 to 4.
- 1 One or two DIMMs per channel can support up to 1333 Mhz.
- 1 If memory modules with different speeds are installed, they will operate at the speed of the slowest installed memory module(s).

Mode-Specific Guidelines

Your system supports both single channel and dual channel modes. A minimal single-channel configuration of one 1 GB memory module per processor is also supported in this mode.

[Table 3-1](#) shows sample memory configurations that follow the appropriate memory guidelines stated in this section. The samples show identical memory-module configurations and their the physical and available memory totals. The table does not show mixed or quad-rank memory-module configurations, nor does it address the memory speed considerations of any configuration.

Table 3-1. Sample UDIMM Memory Configuration

Memory Module Size	Memory Sockets				Physical Memory (GB)
	1	2	3	4	
1 GB	X X X	X X	X X	X X	1 2 4
2 GB	X X X	X X	X X	X X	2 4 8
4 GB	X X X	X X	X X	X X	4 8 16

Installing Memory Modules

 **WARNING:** The memory modules are hot to the touch for some time after the system has been powered down. Allow time for the memory modules to cool before handling them. Handle the memory modules by the card edges and avoid touching the components on the memory module.

 **CAUTION:** Many repairs may only be done by a certified service technician. You should only perform troubleshooting and simple repairs as authorized in your product documentation, or as directed by the online or telephone service and support team. Damage due to servicing that is not authorized by Dell is not covered by your warranty. Read and follow the safety instructions that came with the product.

CAUTION: To ensure proper system cooling, memory-module blanks must be installed in any memory socket that is not occupied. Remove memory-module blanks only if you intend to install memory in those sockets.

1. Turn off the system, including any attached peripherals, and disconnect the system from the electrical outlet.
2. Open the system. See [Opening the System](#).
3. Remove the cooling shroud. See [Removing the Cooling Shroud](#).
4. Locate the memory module sockets. See [Figure 6-1](#).
5. Press the ejectors on the memory module socket down and out, as shown in [Figure 3-11](#), to allow the memory module to be inserted into the socket.
6. Handle each memory module only on either card edge, making sure not to touch the middle of the memory module.

Figure 3-11. Installing and Removing a Memory Module

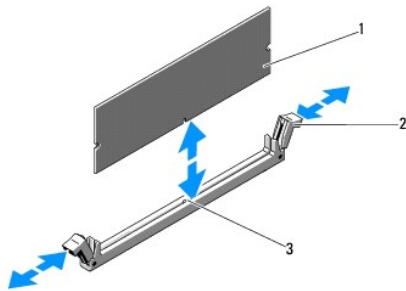

1	memory module	2	memory module socket ejectors (2)
3	alignment key		

7. Align the memory module's edge connector with the alignment key of the memory module socket, and insert the memory module in the socket.

NOTE: The memory module socket has an alignment key that allows you to install the memory module in the socket in only one way.

8. Press down on the memory module with your thumbs to lock the memory module into the socket.

When the memory module is properly seated in the socket, the ejectors on the memory module socket align with the ejectors on the other sockets that have memory modules installed.

9. Repeat [step 5](#) through [step 8](#) of this procedure to install the remaining memory modules. See [Table 3-1](#).
10. Replace the cooling shroud. See [Installing the Cooling Shroud](#).
11. Close the system. See [Closing the System](#).
12. Start up the system, press <F2> to enter the System Setup program, and check the **System Memory** setting on the main **System Setup** screen.
The system should have already changed the value to reflect the newly installed memory.
13. If the value is incorrect, one or more of the memory modules may not be installed properly. Repeat [step 2](#) through step 12 of this procedure, checking to ensure that the memory modules are firmly seated in their sockets.
14. Run the system memory test in the system diagnostics. See [Running the Embedded System Diagnostics](#).

Removing Memory Modules

WARNING: The memory modules are hot to touch for some time after the system has been powered down. Allow time for the memory modules to cool before handling them. Handle the memory modules by the card edges and avoid touching the components on the memory module.

CAUTION: Many repairs may only be done by a certified service technician. You should only perform troubleshooting and simple repairs as authorized in your product documentation, or as directed by the online or telephone service and support team. Damage due to servicing that is not authorized by Dell is not covered by your warranty. Read and follow the safety instructions that came with the product.

CAUTION: To ensure proper system cooling, memory-module blanks must be installed in any memory socket that is not occupied. Remove memory-module blanks only if you intend to install memory in those sockets.

1. Turn off the system, including any attached peripherals, and disconnect the system from the electrical outlet.
2. Open the system. See [Opening the System](#).
3. Remove the cooling shroud. See [Removing the Cooling Shroud](#).
4. Locate the memory module sockets. See [Figure 6-1](#).
5. Press down and out on the ejectors on each end of the socket until the memory module pops out of the socket. See [Figure 3-11](#).
Handle each memory module only on either card edge, making sure not to touch the middle of the memory module.
6. Replace the cooling shroud. See [Installing the Cooling Shroud](#).
7. Close the system. See [Closing the System](#).
8. Reconnect the system and peripherals to their power sources, and turn them on.

Cooling Fans

Your system contains three single-motor fans and provides cooling for the processor, expansion card, and memory modules.

NOTE: Hot-swap removal or installation of the fans is not supported.

NOTE: In the event of a problem with a particular fan, the fan number is referenced by the system's management software, allowing you to easily identify and replace the proper fan by noting the fan numbers on the fan assembly.

Removing a Cooling Fan

WARNING: The cooling fan can continue to spin for some time after the system has been powered down. Allow time for the fan to stop spinning before removing it from the system.

WARNING: Do not attempt to operate the system without the cooling fan.

CAUTION: Many repairs may only be done by a certified service technician. You should only perform troubleshooting and simple repairs as authorized in your product documentation, or as directed by the online or telephone service and support team. Damage due to servicing that is not authorized by Dell is not covered by your warranty. Read and follow the safety instructions that came with the product.

NOTE: The procedure for removing each individual fan module is the same.

1. Turn off the system, including any attached peripherals, and disconnect the system from its electrical outlet.
2. Open the system. See [Opening the System](#).
3. If applicable, remove the cooling shroud. See [Removing the Cooling Shroud](#).
4. Disconnect the fan's power cable from the system board. See [Figure 3-12](#).
5. Grasp the fan and slide it away from the fan assembly. See [Figure 3-12](#).

Figure 3-12. Removing and Installing a Fan

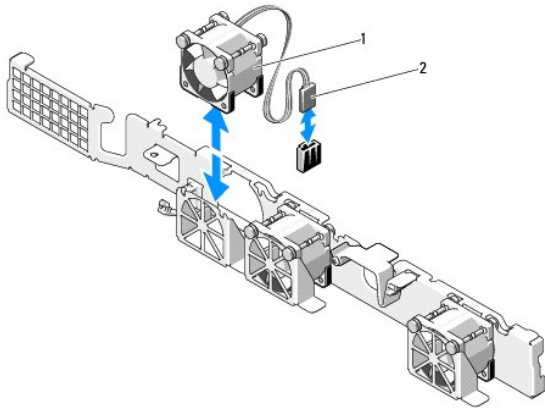

1	fan	2	power cable
---	-----	---	-------------

Installing a Cooling Fan

1. Ensure that the fan is oriented correctly.
Orient the fan module so that the side with the power cable faces toward the back of the system.
2. Lower the fan into the fan assembly until the fan is fully seated. See [Figure 3-12](#).
3. Connect the fan's power cable to the power connector on the system board.
4. If applicable, replace the cooling shroud. See [Installing the Cooling Shroud](#).
5. Close the system. See [Closing the System](#).
6. Reconnect the system to its electrical outlet and turn the system on, including any attached peripherals.

iDRAC6 Express Card (Optional)

Installing an iDRAC6 Express Card

CAUTION: Many repairs may only be done by a certified service technician. You should only perform troubleshooting and simple repairs as authorized in your product documentation, or as directed by the online or telephone service and support team. Damage due to servicing that is not authorized by Dell is not covered by your warranty. Read and follow the safety instructions that came with the product.

1. Turn off the system, including any attached peripherals, and disconnect the system from the electrical outlet.
2. Open the system. See [Opening the System](#).
3. If installed, remove the expansion card from the expansion slot. See [Removing an Expansion Card](#).
4. Insert the notch on the Integrated Dell Remote Access Controller 6 (iDRAC6) Express card into the clip on the system board.
5. Align the front edge of the card with the connector on the system board. See [Figure 6-1](#) for the location of the connector.
6. Press the card down until it is fully seated. See [Figure 3-13](#).

When the front of the card is fully seated, the plastic standoff tab snaps over the edge of the holder.

Figure 3-13. Installing or Removing an iDRAC6 Express Card

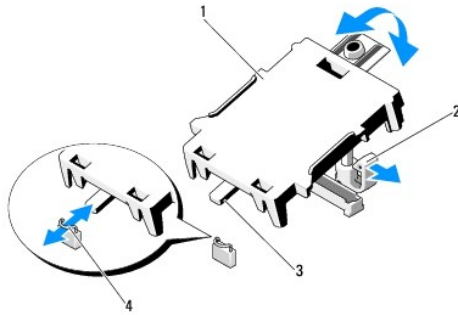

1	iDRAC6 Express card	2	plastic standoff tab
3	notch	4	clip

7. If applicable, reinstall the expansion card. See [Installing an Expansion Card](#).
8. Close the system. See [Closing the System](#).
9. Reconnect the system to its electrical outlet and turn the system on, including any attached peripherals.

Removing an iDRAC6 Express Card

CAUTION: Many repairs may only be done by a certified service technician. You should only perform troubleshooting and simple repairs as authorized in your product documentation, or as directed by the online or telephone service and support team. Damage due to servicing that is not authorized by Dell is not covered by your warranty. Read and follow the safety instructions that came with the product.

1. Turn off the system, including any attached peripherals, and disconnect the system from the electrical outlet.
2. Open the system. See [Opening the System](#).
3. If installed, remove the expansion card from the expansion slot. See [Removing an Expansion Card](#).
4. Pull back slightly on the retention standoff tab at the front edge of the card and gently lift the card off the retention standoff. See [Figure 3-14](#).
As the holder releases from the standoff, the connector under the card disengages from the system board connector.
5. Angle the card so that the notch on the card slips through the clip on the system board.
6. If applicable, reinstall the expansion card. See [Installing an Expansion Card](#).
7. Close the system. See [Closing the System](#).
8. Reconnect the system to its electrical outlet and turn the system on, including any attached peripherals.

iDRAC6 Enterprise Card (Optional)

Installing an iDRAC6 Enterprise Card

CAUTION: Many repairs may only be done by a certified service technician. You should only perform troubleshooting and simple repairs as authorized in your product documentation, or as directed by the online or telephone service and support team. Damage due to servicing that is not authorized by Dell is not covered by your warranty. Read and follow the safety instructions that came with the product.

1. Turn off the system, including any attached peripherals, and disconnect the system from the electrical outlet.
2. Open the system. See [Opening the System](#).
3. If installed, remove the expansion card from the expansion slot. See [Removing an Expansion Card](#).

4. Remove the plastic filler plug for the iDRAC6 Enterprise port from the system back panel.
5. Angle the card so that the RJ-45 connector fits through the back-panel opening. See [Figure 3-14](#).
6. Align the front edge of the card with the two front plastic retention standoffs next to the iDRAC6 connector on the system board, and lower the card into place. See [Figure 3-14](#).

When the front of the card is fully seated, the plastic standoffs snap over the edge of the card.

Figure 3-14. Installing or Removing an iDRAC6 Enterprise Card

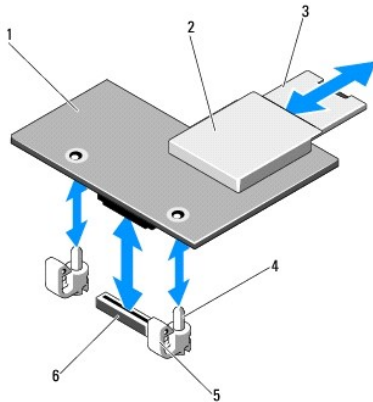

1	iDRAC6 Enterprise card	2	VFlash media slot
3	VFlash SD card	4	retention standoff posts (2)
5	retention standoff tabs (2)	6	iDRAC6 Enterprise card connector

7. If applicable, reinstall the expansion card. See [Installing an Expansion Card](#).
8. Close the system. See [Closing the System](#).
9. Reconnect the system to its electrical outlet and turn the system on, including any attached peripherals.

Removing an iDRAC6 Enterprise Card

⚠ CAUTION: Many repairs may only be done by a certified service technician. You should only perform troubleshooting and simple repairs as authorized in your product documentation, or as directed by the online or telephone service and support team. Damage due to servicing that is not authorized by Dell is not covered by your warranty. Read and follow the safety instructions that came with the product.

1. Turn off the system, including any attached peripherals, and disconnect the system from the electrical outlet.
2. If present, disconnect the Ethernet cable from the iDRAC6 enterprise card connector on the system back panel. See [Figure 1-2](#).
3. Open the system. See [Opening the System](#).
4. If installed, remove the expansion card from the expansion slot. See [Removing an Expansion Card](#).
5. Remove the VFlash media (if installed) from the iDRAC6 enterprise card. See [Removing a VFlash Media Card](#).
6. Pull back slightly on the two tabs at the front edge of the card and gently lift the front edge of the card off of the retention standoffs.
As the card releases from the standoffs, the connector under the card disengages from the system board connector.
7. Slide the card away from the back of the system until the RJ-45 connector is clear of the back panel, then lift the card out of the system.
8. If applicable, reinstall the expansion card. See [Installing an Expansion Card](#).
9. Replace the plastic filler plug over the port at the system back panel. See [Back-Panel Features and Indicators](#) for the port location.
10. Close the system. See [Closing the System](#).

11. Reconnect the system to its electrical outlet and turn the system on, including any attached peripherals.
-

VFlash Media (Optional)

The VFlash media card is a Secure Digital (SD) card that plugs into the optional iDRAC6 Enterprise card at the back corner of the system.

Installing a VFlash Media Card

1. Locate the VFlash media slot at the back corner of the system.
2. With the label side facing up, insert the contact-pin end of the SD card into the card slot on the module.

 **NOTE:** The slot is keyed to ensure correct insertion of the card.

3. Press inward on the card to lock it into the slot.

Removing a VFlash Media Card

To remove the VFlash media, push inward on the card to release it, and pull the card from the card slot.

Processor

Removing a Processor

 **CAUTION:** Many repairs may only be done by a certified service technician. You should only perform troubleshooting and simple repairs as authorized in your product documentation, or as directed by the online or telephone service and support team. Damage due to servicing that is not authorized by Dell is not covered by your warranty. Read and follow the safety instructions that came with the product.

1. Prior to upgrading your system, download the latest system BIOS version on support.dell.com.
2. Turn off the system, including any attached peripherals, and disconnect the system from the electrical outlet.
3. Open the system. See [Opening the System](#).
4. Remove the cooling shroud. See [Removing the Cooling Shroud](#).

 **WARNING:** The heat sink and processor are hot to the touch for some time after the system has been powered down. Allow the heat sink and processor to cool before handling them.

 **CAUTION:** Never remove the heat sink from a processor unless you intend to remove the processor. The heat sink is necessary to maintain proper thermal conditions.

5. Using a #2 Phillips screwdriver, loosen one of the heat-sink retention screws. See [Figure 3-15](#).
6. Wait 30 seconds for the heat sink to loosen from the processor.
7. Loosen the other heat-sink retention screws.
8. Gently lift the heat sink off of the processor and set the heat sink aside with thermal grease side facing up.

 **CAUTION:** The processor is held in its socket under strong pressure. Be aware that the release lever can spring up suddenly if not firmly grasped.

9. Position your thumb firmly over the processor socket-release lever and release the lever from the locked position.
10. Rotate the lever 90 degrees upward until the processor is released from the socket. See [Figure 3-16](#).

Figure 3-15. Installing and Removing the Heat Sink

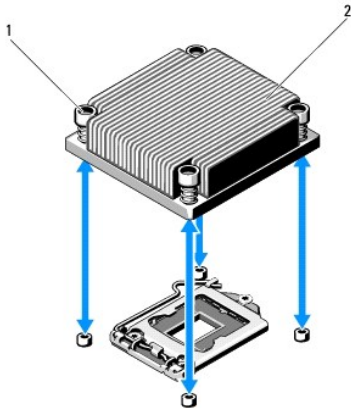

1	heat-sink retention screws (4)	2	heat sink
---	--------------------------------	---	-----------

11. Rotate the processor shield upward and out of the way. See [Figure 3-16](#).
12. Lift the processor out of the socket and leave the release lever up so that the socket is ready for the new processor.

CAUTION: Be careful not to bend any of the pins on the ZIF socket when removing the processor. Bending the pins can permanently damage the system board.

Figure 3-16. Installing and Removing a Processor

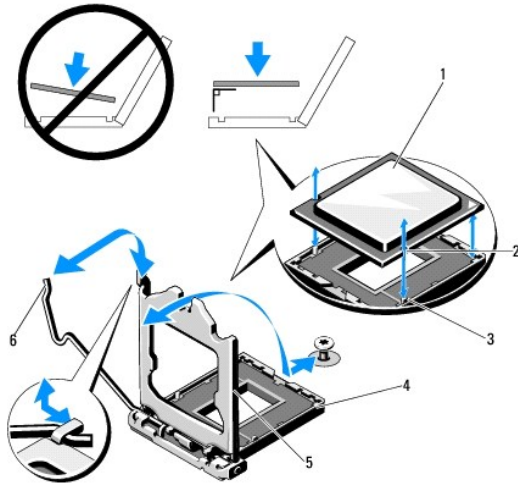

1	processor	2	notch in processor
3	socket key	4	ZIF socket
5	processor shield	6	socket-release lever

Installing a Processor

CAUTION: Many repairs may only be done by a certified service technician. You should only perform troubleshooting and simple repairs as authorized in your product documentation, or as directed by the online or telephone service and support team. Damage due to servicing that is not authorized by Dell is not covered by your warranty. Read and follow the safety instructions that came with the product.

1. If you are upgrading your processor, prior to upgrading your system, download and install the latest system BIOS version from support.dell.com. Follow the instructions included in the file download to install the update on your system.

2. Unpack the processor if it has not been used previously.

If the processor has already been used, remove any thermal grease from the top of the processor using a lint-free cloth.

3. Align the processor with the socket keys on the ZIF socket. See [Figure 3-16](#).

CAUTION: Positioning the processor incorrectly can permanently damage the system board or the processor. Be careful not to bend the pins in the socket.

4. With the release lever on the processor socket in the open position, align the processor with the socket keys and set the processor lightly in the socket.

CAUTION: Do not use force to seat the processor. When the processor is positioned correctly, it engages easily into the socket.

5. Close the processor shield.

6. Rotate the socket release lever down until it snaps into place.

7. Using a clean lint-free cloth, remove the thermal grease from the heat sink.

8. Open the grease packet included with your processor kit and apply thermal grease evenly to the center of the top of the new processor.

CAUTION: Using excess thermal grease can cause grease to contact the processor shield, which can cause contamination of the processor socket.

9. Place the heat sink on the processor. See [Figure 3-15](#).

10. Using a #2 Phillips screwdriver, tighten the heat-sink retention screws. See [Figure 3-15](#).

11. Replace the cooling shroud. See [Installing the Cooling Shroud](#).

12. Close the system. See [Closing the System](#).

13. Reconnect the system to its electrical outlet and turn the system on, including any attached peripherals.

14. Press <F2> to enter the System Setup program, and check that the processor information matches the new system configuration. See [Entering the System Setup Program](#).

15. Run the system diagnostics to verify that the new processor operates correctly.

See [Running the Embedded System Diagnostics](#) for information about running the diagnostics.

Power Supply

Your system supports a 250 W power supply module.

Removing the Power Supply

1. Turn off the system and all attached peripherals.

2. Disconnect the power cable from the power source.

NOTE: You may have to unlatch and lift the optional cable management arm if it interferes with power-supply removal. For information about the cable management arm, see the system's rack documentation.

3. Open the system. See [Opening the System](#).

4. Disconnect all the power cables from the power supply to the system board, hard drive(s), and optical drive. See [Figure 3-17](#).

5. Remove the screw securing the power supply to the chassis and lift the power supply to remove it from the chassis. See [Figure 3-17](#).

Figure 3-17. Removing and Installing the Power Supply

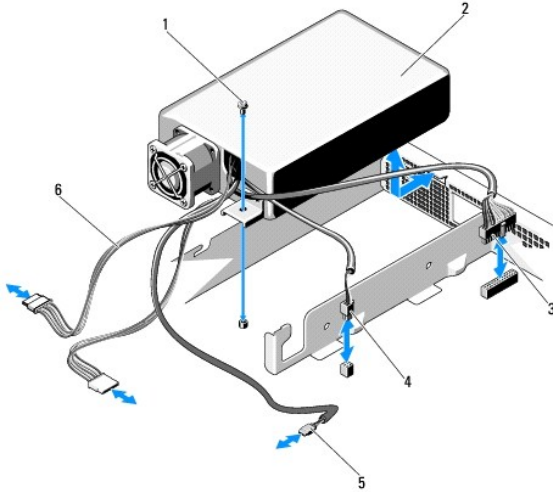

1	screw	2	power supply
3	power cable 24 pins	4	power cable 4 pins
5	optical drive cable	6	SATA power cables (2)

Installing the Power Supply

1. Open the system. See [Opening the System](#).
2. Place the power supply on the chassis and align the hole on the power supply with the hole on the chassis. See [Figure 3-17](#).
3. Tighten the screw to secure the power supply to the chassis.
4. Connect all the power cables to the system board, hard drive(s), and optical drive.
5. Close the system. See [Closing the System](#).
6. Reconnect the system to its electrical outlet and turn the system on, including any attached peripherals.

System Battery

Replacing the System Battery

- ⚠ WARNING:** There is a danger of a new battery exploding if it is incorrectly installed. Replace the battery only with the same or equivalent type recommended by the manufacturer. See your safety information for additional info.
- ⚠ CAUTION:** Many repairs may only be done by a certified service technician. You should only perform troubleshooting and simple repairs as authorized in your product documentation, or as directed by the online or telephone service and support team. Damage due to servicing that is not authorized by Dell is not covered by your warranty. Read and follow the safety instructions that came with the product.

1. Turn off the system, including any attached peripherals, and disconnect the system from the electrical outlet.
2. Open the system. See [Opening the System](#).

Figure 3-18. Replacing the System Battery

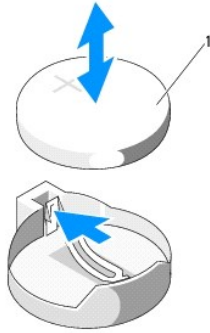

1	system battery
---	----------------

3. Locate the battery socket. See [Figure 6-1](#).

CAUTION: To avoid damage to the battery connector, you must firmly support the connector while installing or removing a battery.

4. To remove the battery, push the metal tab away from the battery until the battery pops out. See [Figure 3-18](#).
5. To install the new system battery, hold the battery with the "+" facing up, and aligned to the metal tab on the socket.
6. Press the battery straight down into the socket until it snaps into place.
7. Close the system. See [Closing the System](#).
8. Reconnect the system to its electrical outlet and turn the system on, including any attached peripherals.
9. Enter the System Setup program to confirm that the battery is operating properly. See [Entering the System Setup Program](#).
10. Enter the correct time and date in the System Setup program's **Time** and **Date** fields.
11. Exit the System Setup program.

Control Panel Assembly

Removing the Control Panel Assembly

CAUTION: Many repairs may only be done by a certified service technician. You should only perform troubleshooting and simple repairs as authorized in your product documentation, or as directed by the online or telephone service and support team. Damage due to servicing that is not authorized by Dell is not covered by your warranty. Read and follow the safety instructions that came with the product.

1. If installed, remove the front bezel. See [Removing the Front Bezel](#).
2. Turn off the system and attached peripherals, and disconnect the system from the electrical outlet and peripherals.
3. Open the system. See [Opening the System](#).
4. Remove hard drive 0. See [Removing a Hard Drive](#).
5. Disconnect the control panel cable at back of the control panel board:

CAUTION: Do not pull on the cable to unseat the connector. Doing so can damage the cable.

- a. Press the metal tabs on the ends of the cable connector.
- b. Gently work the connector out of the socket.
- c. Remove the USB connector cable from the control panel.

- Remove the four screws that secure the control panel board to the chassis.

Figure 3-19. Control Panel Removal

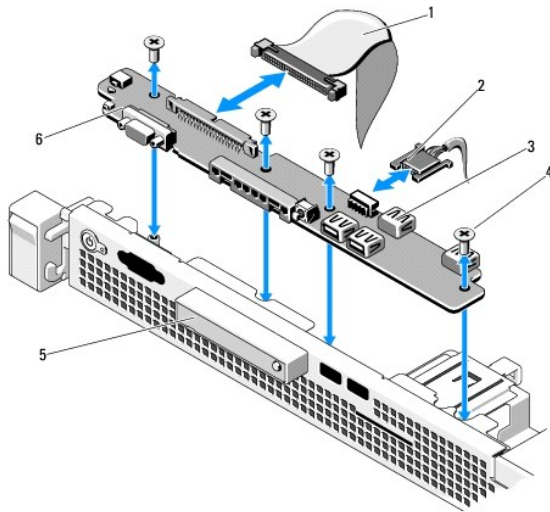

1	control panel cable	2	USB connector cable
3	USB connectors (4)	4	screws (4)
5	LED display module	6	control panel board

Installing the Control Panel Assembly

- Align the screw holes on the control panel board with the holes on the chassis.
- Replace the screws on the control panel assembly. See [Figure 3-19](#).
- Connect the control panel cable to the control panel board.
- Connect the USB connector cable.
- Replace the hard drive. See [Installing a Hard Drive](#).
- Close the system. See [Closing the System](#).
- If applicable, replace the front bezel. See [Installing the Front Bezel](#).
- Reconnect the system to the power source and turn on the system and attached peripherals.

System Board

Removing the System Board

- ⚠ **CAUTION:** Many repairs may only be done by a certified service technician. You should only perform troubleshooting and simple repairs as authorized in your product documentation, or as directed by the online or telephone service and support team. Damage due to servicing that is not authorized by Dell is not covered by your warranty. Read and follow the safety instructions that came with the product.
- ⚠ **CAUTION:** If you are using the Trusted Program Module (TPM) with an encryption key, you may be prompted to create a recovery key during program or system setup. Be sure to create and safely store this recovery key. If you replace this system board, you must supply the recovery key when you restart your system or program before you can access the encrypted data on your hard drives.

1. Turn off the system and attached peripherals, and disconnect the system from the electrical outlet.
2. Open the system. See [Opening the System](#).
3. Remove the cooling shroud. See [Removing the Cooling Shroud](#).
4. Remove any expansion card. See [Removing an Expansion Card](#).
5. Remove the processor heat sink. See [Removing a Processor](#).
6. If installed, remove the iDRAC6 Enterprise card. See [Removing an iDRAC6 Enterprise Card](#).
7. If installed, remove the iDRAC6 Express card. See [Removing an iDRAC6 Express Card](#).
8. Disconnect all cables from the system board.
9. Remove all the memory modules and memory blanks. See [Removing Memory Modules](#).

 **NOTE:** To ensure proper reinstallation of memory modules, record the memory module socket locations.

10. Remove the ten screws securing the system board to the chassis and then slide the system board assembly toward the front end of the chassis.

 **CAUTION:** Do not lift the system board assembly by grasping a memory module, processor, or other components.

11. Grasp the system board assembly by its edges and lift the assembly away from the chassis. See [Figure 3-20](#).

Figure 3-20. Removing and Installing the System Board

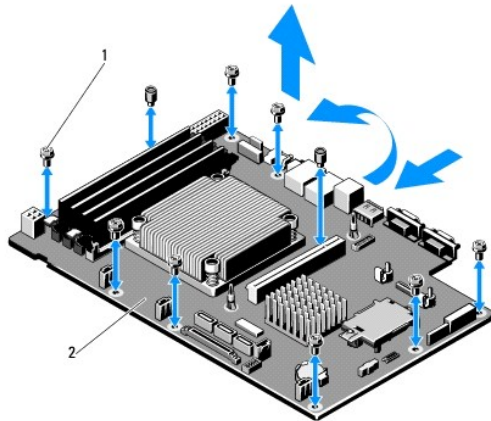

1	screws (10)	2	system board assembly
---	-------------	---	-----------------------

Installing the System Board

1. Unpack the new system board.
2. Remove the labels from the processor shield and affix them to the system identification panel on the front of the system. See [Figure 1-1](#).
3. Holding the system board by its edges, lower it into the chassis.

 **CAUTION:** Do not lift the system board assembly by grasping a memory module, processor, or other components.

4. Slightly lift up the front of the system board and maneuver the system board to the bottom of the chassis until it lays completely flat.
5. Push the system board toward the back of the chassis until the board is in place.

6. Tighten the ten screws that secure the system board to the chassis. See [Figure 3-20](#).
 7. Transfer the processor and the heat sink to the new system board. See [Removing a Processor](#) and [Installing a Processor](#).
 8. Replace all the memory modules and memory blanks. See [Installing Memory Modules](#).
 9. Connect the cables in the order listed below (see [Figure 6-1](#) for the locations of the connectors on the system board):
 1. SATA interface cable, if applicable
 1. Control panel interface cable
 1. Optical drive power cable
 1. Control panel USB interface cable
 1. System board power cables
 10. Install the expansion card, if any. See [Installing an Expansion Card](#).
 11. If applicable, reinstall the iDRAC6 Enterprise card. See [Installing an iDRAC6 Enterprise Card](#).
 12. If applicable, reinstall the iDRAC6 Express card. See [Installing an iDRAC6 Express Card](#).
 13. Replace the cooling shroud. See [Installing the Cooling Shroud](#).
 14. Close the system. See [Closing the System](#).
 15. Reconnect the system to its electrical outlet and turn the system on, including any attached peripherals.
-

[Back to Contents Page](#)

Jumpers and Connectors

Dell™ PowerEdge™ R210 Systems Hardware Owner's Manual





- [System Board Jumpers](#)
- [System Board Connectors](#)
- [Disabling a Forgotten Password](#)

This section provides specific information about the system jumpers. It also provides some basic information on jumpers and switches and describes the connectors on the system board.

System Board Jumpers

[Figure 6-1](#) shows the location of the configuration jumpers on the system board. [Table 6-1](#) lists the jumper settings.

Table 6-1. System Board Jumper Settings

Jumper	Setting	Description
PWRD_EN	 (default)	The password feature is enabled (pins 2-4)
		The password feature is disabled (pins 4-6)
NVRAM_CLR	 (default)	The configuration settings are retained at system boot (pins 3-5)
		The configuration settings are cleared at the next system boot (pins 1-3)

System Board Connectors

Figure 6-1. System Board Connectors

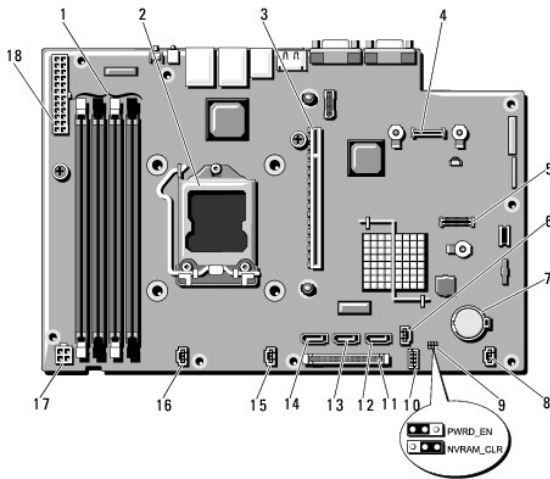



Table 6-2. System Board Jumpers and Connectors

Item	Connector	Description
1	3	Memory module slot 3
	1	Memory module slot 1 (white release lever)
	4	Memory module slot 4
	2	Memory module slot 2 (white release lever)
2	CPU	Processor

3	IO_RISER1	Expansion-card riser connector
4	iDRAC6 Enterprise	iDRAC6 Enterprise card connector
5	iDRAC6 Express	iDRAC6 Express card connector
6	HD_ACT_CARD	Expansion-card cable connector
7	Battery	Battery socket
8	FAN3	System fan 3 connector
9	PWRD_EN	Password enable jumper
	NVRAM_CLR	NVRAM clear jumper
10	USB_CONN	Internal USB connector
11	CTRL_PNL	Control panel connector
12	SATA_C	SATA connector C
13	SATA_B	SATA connector B
14	SATA_A	SATA connector A
15	FAN2	System fan 2 connector
16	FAN1	System fan 1 connector
17	12V	4-pin power connector
18	PWR_CONN	24-pin power connector

Disabling a Forgotten Password

The system's software security features include a system password and a setup password, which are discussed in detail in [Using the System Setup Program and UEFI Boot Manager](#). The password jumper enables these password features or disables them and clears any password(s) currently in use.

 **CAUTION:** See "Protecting Against Electrostatic Discharge" in the safety instructions that came with the system.

1. Turn off the system, including any attached peripherals, and disconnect the system from the electrical outlet.
2. Open the system. See [Opening the System](#).
3. Remove the jumper plug from the password jumper.

See [Figure 6-1](#) to locate the password jumper (labeled "PWRD_EN") on the system board.

4. Close the system.
5. Reconnect your system and peripherals to their electrical outlets, and turn on the system.

The existing passwords are not disabled (erased) until the system boots with the password jumper plug removed. However, before you assign a new system and/or setup password, you must install the jumper plug.

 **NOTE:** If you assign a new system and/or setup password with the jumper plug still removed, the system disables the new password(s) the next time it boots.

6. Turn off the system, including any attached peripherals, and disconnect the system from the electrical outlet.
7. Open the system. See [Opening the System](#).
8. Install the jumper plug on the password jumper.
9. Close the system. See [Closing the System](#).
10. Reconnect your system and peripherals to their electrical outlets, and turn on the system.
11. Assign a new system and/or setup password.

To assign a new password using the System Setup program, see [Assigning a Setup Password](#).

Using the System Setup Program and UEFI Boot Manager

Dell™ PowerEdge™ R210 Systems Hardware Owner's Manual

- [Choosing the System Boot Mode](#)
- [Entering the System Setup Program](#)
- [System Setup Options](#)
- [Entering the UEFI Boot Manager](#)
- [System and Setup Password Features](#)
- [Embedded System Management](#)
- [Baseboard Management Controller Configuration](#)
- [iDRAC Configuration Utility](#)

The System Setup program is the BIOS program that enables you to manage your system hardware and specify BIOS-level options. From the System Setup program, you can:

- 1 Change the NVRAM settings after you add or remove hardware
- 1 View the system hardware configuration
- 1 Enable or disable integrated devices
- 1 Set performance and power management thresholds
- 1 Manage system security

Choosing the System Boot Mode

The System Setup program also enables you to specify the boot mode for installing your operating system:

- 1 BIOS boot mode (the default) is the standard BIOS-level boot interface.
- 1 UEFI boot mode is an enhanced 64-bit boot interface based on Unified Extensible Firmware Interface (UEFI) specifications that overlays the system BIOS. See [Entering the UEFI Boot Manager](#) for more information on this interface.

You must select the boot mode in the **Boot Mode** field of the [Boot Settings Screen](#) of the System Setup program. Once you specify the boot mode, the system boots in the specified boot mode and you proceed then to install your operating system from that mode. Thereafter, you must boot the system to the same boot mode (BIOS or UEFI) to access the installed operating system. Trying to boot the operating system from the other boot mode will cause the system to halt immediately at startup.

 **NOTE:** Operating systems must be UEFI-compatible (for example, Microsoft® Windows Server® 2008 x64 version) to be installed from the UEFI boot mode. DOS and 32-bit operating systems do not support UEFI and can only be installed from the BIOS boot mode.

Entering the System Setup Program

1. Turn on or restart your system.
2. Press <F2> immediately after you see the following message:

<F2> = System Setup

If your operating system begins to load before you press <F2>, allow the system to finish booting, and then restart your system and try again.

Responding to Error Messages

If an error message appears while the system is booting, make a note of the message. See [System Messages](#) for an explanation of the message and suggestions for correcting errors.

 **NOTE:** After installing a memory upgrade, it is normal for your system to display a message the first time you start your system.

Using the System Setup Program Navigation Keys

Keys	Action
Up arrow or <Shift><Tab>	Moves to the previous field.
Down arrow or <Tab>	Moves to the next field.
<Enter>, Spacebar, <+>, <->, left and right arrows	Cycles through the settings in a field. In many fields, you can also type the appropriate value.
<Esc>	Exits the System Setup program and restarts the system if any changes were made.

<F1> | Displays the System Setup program's help file.

 **NOTE:** For most of the options, any changes that you make are recorded but do not take effect until you restart the system.

System Setup Options

Main Screen

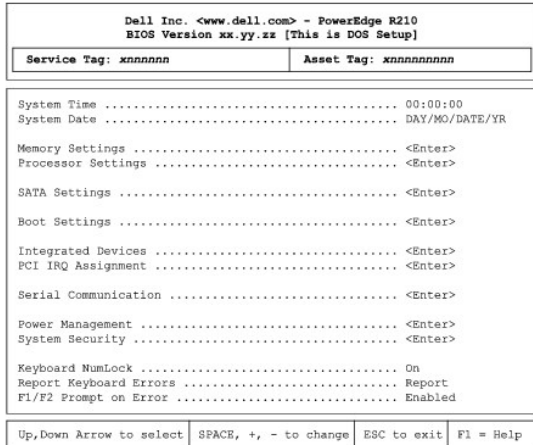

 **NOTE:** The options for the System Setup program change based on the system configuration.

 **NOTE:** The System Setup program defaults are listed under their respective options in the following sections, where applicable.

Option	Description
System Time	Sets the time on the system's internal clock.
System Date	Sets the date on the system's internal calendar.
Memory Settings	Displays information related to installed memory. See Memory Settings Screen .
Processor Settings	Displays information related to the processor (speed, cache size, and so on). See Processor Settings Screen .
SATA Settings	Displays a screen to enable or disable the integrated SATA controller and ports. See SATA Settings Screen .
Boot Settings	Displays a screen to specify the boot mode (BIOS or UEFI). For BIOS boot mode, you can also specify the boot devices. See Boot Settings Screen .
Integrated Devices	Displays a screen to enable or disable integrated device controllers and ports, and to specify related features and options. See Integrated Devices Screen .
PCI IRQ Assignment	Displays a screen to change the IRQ assigned to each of the integrated devices on the PCI bus, and any installed expansion card that requires an IRQ. See PCI IRQ Assignments Screen .
Serial Communication	Displays a screen to enable or disable the serial ports and specify related features and options. See Serial Communication Screen .
Power Management	Enables you to manage power usage of the processor, fans, and memory modules with preconfigured or customized settings. See Power Management Screen .
System Security	Displays a screen to configure the system password and setup password features. See System Security Screen , Using the System Password , and Using the Setup Password for more information.
Keyboard NumLock (On default)	Determines whether your system starts up with the NumLock mode activated on 101- or 102-key keyboards (does not apply to 84-key keyboards).
Report Keyboard Errors (Report default)	Enables or disables reporting of keyboard errors during the POST. Select Report for host systems that have keyboards attached. Select Do Not Report to suppress all error messages relating to the keyboard or keyboard controller during POST. This setting does not affect the operation of the keyboard itself if a keyboard is attached to the system.
F1/F2 Prompt on Error (Enabled default)	Enables the system to halt on errors during POST, which allows the user to observe events that may scroll by unnoticed during normal POST. The user can press <F1> to continue or <F2> to enter the System Setup program.  CAUTION: When setting this option to Disabled, the system does not halt if an error occurs during POST. Any critical errors are displayed and logged in the system event log.

Memory Settings Screen

Option	Description
System Memory Size	Displays the amount of system memory.
System Memory Type	Displays the type of system memory.
System Memory Speed	Displays the system memory speed.
Video Memory	Displays the amount of video memory.
System Memory Testing (Enabled default)	Specifies whether system memory tests are run at system boot. Options are Enabled and Disabled .

Processor Settings Screen

Option	Description
64-bit	Specifies if the processor supports 64-bit extensions.
Core Speed	Displays the processor clock speed.
Bus Speed	Displays the processor bus speed.
Logical Processor (Enabled default)	On processors that support Simultaneous Multi-Threading (SMT) technology, each processor core supports up to two logical processors. If this field is set to Enabled , the BIOS reports both logical processors. If set to Disabled , only one logical processor is monitored by the BIOS.
Virtualization Technology (Disabled default)	Enabled permits virtualization software to use the virtualization technology incorporated in the processor. NOTE: Disable this feature if your system will not be running virtualization software.
Execute Disable (Enabled default)	Enables or disables Execute Disable Memory Protection Technology.
Number of Cores per Processor (All default)	If set to All , the maximum number of cores in each processor is enabled.
Turbo Mode (Enabled default)	If Turbo Boost technology is supported by the processor, enables or disables Turbo Mode .
C States (Enabled default)	When set to Enabled , the processor can operate in all available power states.
Processor X ID	Displays the family, model, level 2 cache size, level 3 cache size, and number of cores of the processor.

SATA Settings Screen

Option	Description
SATA Controller (AHCI default)	Allows the embedded SATA to be set to Off , ATA , AHCI , or RAID modes. NOTE: The UEFI support is disabled if SATA is set to the RAID mode.
Port A (Off default)	Auto enables BIOS support for the device attached to SATA port A. Off disables BIOS support for the device.
Port B (Off default)	Auto enables BIOS support for the device attached to SATA port B. Off disables BIOS support for the device.
Port C (Off default)	Auto enables BIOS support for the device attached to SATA port C. Off disables BIOS support for the device.
eSATA port (Off default)	Auto enables BIOS support for the device attached to the eSATA port. Off disables BIOS support for the device.

Boot Settings Screen

Option	Description
Boot Mode (BIOS default)	 CAUTION: Switching the boot mode could prevent the system from booting if the operating system was not installed in the same boot mode.

	<p>If the operating system supports Unified Extensible Firmware Interface, you can set this option to UEFI. Setting this field to BIOS allows compatibility with non-UEFI operating systems.</p> <p>NOTE: Setting this field to UEFI disables the Boot Sequence, Hard-Disk Drive Sequence, and USB Flash Drive Emulation Type fields.</p>
Boot Sequence	If Boot Mode is set to BIOS , this field tells the system where the operating system files needed for startup are located. If Boot Mode is set to UEFI , you can access the UEFI boot manager utility by rebooting the system and pressing <F11> when prompted to do so.
Hard-Disk Drive Sequence	Determines the order in which the BIOS will attempt to boot from hard drives in the system during system startup.
USB Flash Drive Emulation Type (Auto default)	<p>Determines the emulation type for a USB flash drive. Hard disk allows the USB flash drive to act as a hard drive. Floppy allows the USB flash drive to act as a removable diskette drive.</p> <p>Auto automatically chooses the appropriate emulation type for the device. If you install a device in this slot that is configured as a removable diskette drive, you must manually set the emulation type to Floppy.</p>
Boot Sequence Retry (Disabled default)	If this field is enabled and the system has failed to boot, the system will reattempt to boot after 30 seconds.

Integrated Devices Screen

Option	Description
User Accessible USB Ports (All Ports On default)	Enables or disables the user-accessible USB ports. Options are All Ports On , Only Back Ports On , and All Ports Off .
Internal USB Port (On default)	Enables or disables the internal USB port.
Embedded NIC1 and NIC2 (Enabled default)	Enables or disables the operating system interface of the NIC1 and NIC2 controllers. (The NICs may also be accessed through the system's management controller).
Embedded Gb NIC1 (Enabled with PXE default)	Enables or disables the embedded NICs. PXE support allows the system to boot from the network. Enabled with iSCSI Boot option is available if the NIC on board supports iSCSI.
Embedded Gb NIC2 (Enabled default)	Enables or disables the embedded NICs.
MAC Address	Displays the MAC address for the NIC.
OS Watchdog Timer (Disabled default)	<p>Sets a timer to monitor the operating system for activity, and aids in recovery if the system stops responding. When Enabled, the operating system is allowed to initialize the timer. When Disabled, the timer is not initialized.</p> <p>NOTE: This feature is usable only with operating systems that support WDAT implementations of the Advanced Configuration and Power Interface (ACPI) 3.0b specification.</p>
Embedded Video Controller (Enabled default)	<p>Enables or disables BIOS support for the integrated video controller.</p> <p>NOTE: This field can be disabled only if an add-in video card is present. If this field is disabled, remote access features such as virtual KVM are not available.</p>

PCI IRQ Assignments Screen

Option	Description
<PCIe device>	Use the <+> and <-> keys to manually select an IRQ for a given device, or select Default to allow the BIOS to select an IRQ value at system startup.

Serial Communication Screen

Option	Description
Serial Communication (On without Console Redirection default)	<p>Selects whether the serial communication devices (Serial Device 1 and Serial Device 2) are enabled in BIOS. BIOS console redirection can also be enabled and the port address used can be specified.</p> <p>Options are On without Console Redirection, On with Console Redirection via COM1, On with Console Redirection via COM2, and Off.</p>



Serial Port Address (Serial Device 1=COM1, Serial Device2=COM2 default)	Sets the serial port addresses for the two serial devices. NOTE: Only Serial Device 2 can be used for Serial Over LAN (SOL). To use console redirection by SOL, configure the same port address for console redirection and the serial device.
External Serial Connector (On without Console Redirection default)	Specifies whether Serial Device 1 , Serial Device 2 , or Remote Access Device has access to the external serial connector. NOTE: Only Serial Device 2 can be used for Serial Over LAN (SOL). To use console redirection by SOL, configure the same port address for console redirection and the serial device.
Failsafe Baud Rate (115200 default)	Displays the failsafe baud rate used for console redirection. BIOS attempts to determine the baud rate automatically. This failsafe baud rate is used only if the attempt fails. This rate should not be adjusted.
Remote Terminal Type (VT 100/VT220 default)	Sets the remote console terminal type, either VT100/VT220 or ANSI .
Redirection After Boot (Enabled default)	Enables or disables BIOS console redirection when the operating system is loaded.

Power Management Screen

Option	Description
Power Management (Active Power Controller default)	Options are OS Control , Active Power Controller , Custom , or Maximum Performance . For all but the Custom setting, the BIOS pre-configures the power settings on this screen as follows: <ul style="list-style-type: none"> 1 OS Control sets the CPU power to OS DBPM, the fan power to Minimum Power, and the memory power to Maximum Performance. In this setting, all processor performance information is passed from the system BIOS to the operating system for control. The operating system sets the processor performance based on processor utilization. 1 Active Power Controller sets the CPU power to System DBPM, the fan power to Minimum Power, and the memory power to Maximum Performance. The BIOS sets the processor performance based on processor utilization. 1 Maximum Performance sets all fields to Maximum Performance. <p>If you select Custom, you can configure each option independently.</p>
CPU Power and Performance Management	Options are OS DBPM , System DBPM , Maximum Performance , or Minimum Power .
Fan Power and Performance Management	Options are Maximum Performance or Minimum Power .
Memory Power and Performance Management	Options are Maximum Performance , a specified frequency, or Minimum Power .

System Security Screen

Option	Description
System Password	Displays the current status of the password security feature and allows a new system password assignment and verification. NOTE: See Using the System Password for more information.
Setup Password	Restricts access to the System Setup program by using a setup password. NOTE: See Using the Setup Password for more information.
Password Status (Unlocked default)	When Setup Password is assigned and this field is Locked , the system password cannot be changed or disabled at system start-up. See Using the System Password for more information.
TPM Security (Off default)	Sets the reporting of the Trusted Platform Module (TPM) in the system. If Off , the presence of the TPM is not reported to the operating system. If On with Pre-boot Measurements , the system reports the TPM to the operating system and stores the pre-boot measurements to the TPM during POST. If On without Pre-boot Measurements , the system reports the TPM to the operating system and bypasses pre-boot measurements.
TPM Activation (No Change default)	When set to Activate , the TPM is enabled to default settings. When set to Deactivate , the TPM is disabled. The No Change state initiates no action. The operational state of the TPM remains unchanged (all user settings for the TPM are preserved).

	NOTE: This field is read-only when TPM Security is set to Off .
TPM Clear (No default)	<p> CAUTION: Clearing the TPM will lose all encryption keys in the TPM. This option prevents booting to the operating system and results in data loss if the encryption keys cannot be restored. Back up the TPM keys prior to enabling this option.</p> <p>When set to Yes, all TPM contents are cleared.</p> <p>NOTE: This field is read-only when TPM Security is set to Off.</p>
Power Button (Enabled default)	<p>If Enabled, the power button can turn the system's power off and on. On an ACPI-compliant operating system, the system performs an orderly shutdown before power is turned off.</p> <p>When Disabled, the button can only turn on system power.</p>
NMI Button (Disabled default)	<p> CAUTION: Use the NMI button only if directed to do so by qualified support personnel or by the operating system's documentation. Pressing this button halts the operating system and displays a diagnostic screen.</p> <p>Enables or disables the NMI feature.</p>
AC Power Recovery (Last default)	Determines how the system reacts when power is restored. If set to Last , the system returns to the last power state. On turns on the system after power is restored. Off allows the system to remain off after power is restored.
AC Power Recovery Delay	Determines when the system restarts after power is restored. Options are Immediate , Random (a random value of 45 to 240 seconds), or a user-defined value of 45 to 240 seconds.
User Defined Delay	Allows the user to view the current AC Recovery Delay. This field also allows the user to define a new AC Recovery Delay.

Exit Screen

Press <Esc> to exit the System Setup program; the **Exit** screen displays:

- 1 Save Changes and Exit
- 1 Discard Changes and Exit
- 1 Return to Setup

Entering the UEFI Boot Manager

 **NOTE:** Operating systems must be 64-bit UEFI-compatible (for example, Microsoft® Windows Server® 2008 x64 version) to be installed from the UEFI boot mode. DOS and 32-bit operating systems can only be installed from the BIOS boot mode.

 **NOTE:** The Boot Mode must be set to **UEFI** in the System Setup program to access the UEFI Boot Manager.

The UEFI Boot Manager enables you to:

- 1 Add, delete, and arrange boot options
- 1 Access the System Setup program and BIOS-level boot options without rebooting

To enter the UEFI Boot Manager:

1. Turn on or restart your system.
2. Press <F11> after you see the following message:

<F11> = UEFI Boot Manager

 **NOTE:** The system will not respond until the USB keyboard is active.

If your operating system begins to load before you press <F11>, allow the system to finish booting, and then restart your system and try again.

Using the UEFI Boot Manager Navigation Keys

Keys	Action
Up arrow	Moves to and highlights the previous field.

Down arrow	Moves to and highlights the next field.
Spacebar, <Enter>, <+>, <->	Cycles through the settings in a field.
<Esc>	Refreshes the UEFI Boot Manager screen, or returns to the UEFI Boot Manager screen from the other program screens.
<F1>	Displays the UEFI Boot Manager help file.

UEFI Boot Manager Screen

Option	Description
Continue	The system attempts to boot to devices starting with the first item in the boot order. If the boot attempt fails, the system will continue with the next item in the boot order until the boot is successful or no more boot options are found.
<Boot options>	Displays the list of available boot options (marked with asterisks). Select the boot option you wish to use and press Enter . NOTE: If you hot-add a boot device, press <ESC> to refresh the list of boot options.
UEFI Boot Settings	Enables you to add, delete, enable, or disable boot options; change boot order; or execute a one-time boot option.
System Utilities	Enables you to access the System Setup program, System Services (Unified Server Configurator [USC]), Diagnostics, and BIOS-level boot options.

UEFI Boot Settings Screen

Option	Description
Add Boot Option	Adds a new boot option.
Delete Boot Option	Deletes an existing boot option.
Enable/Disable Boot Option	Disables and enables a boot option in the boot option list.
Change Boot Order	Changes the order of the boot option list.
One-Time Boot From File	Sets a one-time boot option not included in the boot option list.

System Utilities Screen

Option	Description
System Setup	Accesses the System Setup program without rebooting.
System Services	Restarts the system and accesses the Unified Server Configurator (USC), which allows you to run utilities such as system diagnostics.
BIOS Boot Manager	Accesses the BIOS-level boot options list without rebooting. This option enables you to conveniently switch to BIOS boot mode if you need to boot to a device with a non-UEFI operating system, such as a bootable DOS media with diagnostics software.
Reboot System	Restarts the system.

System and Setup Password Features

 **NOTE:** For a forgotten password, see [Disabling a Forgotten Password](#).

Your system is shipped without the system password feature enabled. Operate the system only with system password protection.

 **CAUTION:** The password features provide a basic level of security for the data on your system.

 **CAUTION:** Anyone can access the data stored on your system if the system is running and unattended.

Using the System Password

When a system password is assigned, the system prompts for the system password after the system starts and only those with the password have full use of the system.

Assigning a System Password

Before assigning a system password, enter the System Setup program and check the **System Password** option.

When a system password is assigned, **System Password** is **Enabled**. If **Password Status** is **Unlocked**, you can change the system password. If **Locked**, you cannot change the system password. Disabling the password jumper on the system board sets **System Password** to **Disabled**, and you cannot change or enter a new system password.

When a system password is not assigned and the password jumper on the system board is in the enabled position, **System Password** is **Not Enabled** and **Password Status** is **Unlocked**.
To assign a system password:

1. Verify that **Password Status** is **Unlocked**.
2. Highlight the **System Password** option and press <Enter>.
3. Type your new system password.

You can use up to 32 characters in your password.

As you type, placeholders appear in the field.

The password assignment is not case-sensitive. Certain key combinations are invalid and if you enter one, the system beeps. To erase a character, press <Backspace> or the left-arrow key.

 **NOTE:** To escape from the field without assigning a system password, press <Enter> to move to another field, or press <Esc> prior to completing [step 5](#).

4. Press <Enter>.
5. To confirm your password, type it a second time and press <Enter>.

System Password changes to **Enabled**. Exit the System Setup program and begin using your system.

6. Either reboot the system now for the password protection to take effect or continue working.

 **NOTE:** Password protection does not take effect until the system reboots.

Using Your System Password to Secure Your System

 **NOTE:** If you have assigned a setup password (see [Using the Setup Password](#)), the system accepts your setup password as an alternate system password.

When **Password Status** is **Unlocked**, you have the option to leave the password security enabled or to disable password security.

To leave the password security enabled:

1. Turn on or reboot your system by pressing <Ctrl><Alt>.
2. Type your password and press <Enter>.

To disable the password security:

1. Turn on or reboot your system by pressing <Ctrl><Alt>.
2. Type your password and press <Ctrl><Enter>.

When **Password Status** is **Locked**, you must type the password and press <Enter> when prompted at reboot.

If an incorrect system password is entered, the system displays a message and prompts you to re-enter your password. You have three attempts to enter the correct password. After the third unsuccessful attempt, the system displays an error message that the system has halted and will shut down.

Even after you shut down and restart the system, the error message continues to be displayed until the correct password is entered.

 **NOTE:** You can use the **Password Status** option in conjunction with the **System Password** and **Setup Password** options to protect your system from unauthorized changes.

Deleting or Changing an Existing System Password

1. Enter the System Setup program and select the **System Security**.

2. Highlight **Setup Password**, press <Enter> to access the setup password window. Press <Enter> twice to clear the existing setup password.
3. The setting changes to **Not Enabled**.
4. If you want to assign a new setup password, perform the steps in [Assigning a Setup Password](#).

Using the Setup Password

Assigning a Setup Password

You can assign a setup password only when the **Setup Password** is **Not Enabled**. To assign a setup password, highlight the **Setup Password** option and press the <+> or <-> key. The system prompts you to enter and verify the password.

 **NOTE:** The setup password can be the same as the system password. If the two passwords are different, the setup password can be used as an alternate system password. The system password cannot be used in place of the setup password.

You can use up to 32 characters in your password.

As you type, placeholders appear in the field.

The password assignment is not case-sensitive. Certain key combinations are invalid and if you enter one, the system beeps. To erase a character, press <Backspace> or the left-arrow key.

When you verify the password, the **Setup Password** changes to **Enabled**. The next time you enter the System Setup program, the system prompts you for the setup password.

A change to the **Setup Password** option becomes effective immediately (restarting the system is not required).

Operating With a Setup Password Enabled

If **Setup Password** is **Enabled**, you must enter the correct setup password before modifying most of the System Setup options.

If you do not enter the correct password in three attempts, the system lets you view, but not modify, the System Setup screens. The following options are exceptions: If **System Password** is not **Enabled** and is not locked through the **Password Status** option, you can assign a system password. You cannot disable or change an existing system password.

 **NOTE:** You can use the **Password Status** option in conjunction with the **Setup Password** option to protect the system password from unauthorized changes.

Deleting or Changing an Existing Setup Password

1. Enter the System Setup program and select the **System Security**.
2. Highlight **Setup Password**, press <Enter> to access the setup password window. Press <Enter> twice to clear the existing setup password.
The setting changes to **Not Enabled**.
3. If you want to assign a new setup password, perform the steps in [Assigning a Setup Password](#).

Embedded System Management

The USC is an embedded utility that enables systems and storage management tasks from an embedded environment throughout the server's lifecycle.

The USC can be started during the boot sequence and can function independently of the operating system.

 **NOTE:** Certain platform configurations may not support the full set of features provided by USC.

The following features of USC are supported on systems with Baseboard Management Controller (BMC):

- 1 Installing an operating system
- 1 Running diagnostics to validate the memory, I/O devices, processor, physical disks, and other peripherals

When an optional iDRAC6 Express card is installed, USC provides the following additional features:

- 1 Downloading and applying firmware updates
- 1 Configuring hardware and firmware

For more information about setting up USC, configuring hardware and firmware, and deploying the operating system, see the Unified Server Configurator

Baseboard Management Controller Configuration

The BMC enables configuring, monitoring, and recovery of systems remotely. The BMC provides the following features:

- 1 Enables fault logging and SNMP alerting
- 1 Provides access to system event log and sensor status
- 1 Allows control of system functions including power on and off
- 1 Functions independently of the system's power state or the system's operating system
- 1 Provides text console redirection for system setup, text-based utilities, and operating system consoles

 **NOTE:** To remotely access the BMC through the integrated NIC, you must connect the network connection to integrated NIC1.

For additional information on using BMC, see the documentation for the BMC and systems management applications.

Entering the BMC Setup Module

1. Turn on or restart your system.
2. Press <Ctrl><E> when prompted after POST.

If your operating system begins to load before you press <Ctrl><E>, allow the system to finish booting, and then restart your system and try again.

iDRAC Configuration Utility

The iDRAC Configuration Utility is a pre-boot configuration environment that allows you to view and set parameters for the iDRAC6 and for the managed server.

The iDRAC Configuration Utility provides the following features:

- 1 Enables fault logging and SNMP alerting
- 1 Provides access to system event log and sensor status
- 1 Allows control of system functions including power on and off
- 1 Functions independently of the system's power state or the system's operating system
- 1 Provides text console redirection for system setup, text-based utilities, and operating system consoles.

In addition the iDRAC Configuration Utility enables you to:

- 1 Configure, enable, or disable the iDRAC6 local area network through the dedicated iDRAC6 Enterprise card port or the embedded NIC1.
- 1 Enable or disable IPMI over LAN
- 1 Enable a LAN Platform Event Trap (PET) destination
- 1 Attach or detach the Virtual Media devices
- 1 Change the administrative user name and password and manage user privileges
- 1 View System Event Log (SEL) messages or clear messages from the log

For additional information on using iDRAC6, see the documentation for iDRAC6 and systems management applications.

Entering the iDRAC Configuration Utility

1. Turn on or restart your system.
2. Press <Ctrl><E> when prompted during POST.

If your operating system begins to load before you press <Ctrl><E>, allow the system to finish booting, and then restart your system and try again.

[Back to Contents Page](#)

Troubleshooting Your System

Dell™ PowerEdge™ R210 Systems Hardware Owner's Manual

- [Safety First—For You and Your System](#)
- [Troubleshooting System Startup Failure](#)
- [Troubleshooting External Connections](#)
- [Troubleshooting the Video Subsystem](#)
- [Troubleshooting a USB Device](#)
- [Troubleshooting a Serial I/O Device](#)
- [Troubleshooting a NIC](#)
- [Troubleshooting a Wet System](#)
- [Troubleshooting a Damaged System](#)
- [Troubleshooting the System Battery](#)
- [Troubleshooting Power Supply](#)
- [Troubleshooting System Cooling Problems](#)
- [Troubleshooting a Fan](#)
- [Troubleshooting System Memory](#)
- [Troubleshooting an Internal USB Key](#)
- [Troubleshooting an Optical Drive](#)
- [Troubleshooting a Tape Backup Unit](#)
- [Troubleshooting a Hard Drive](#)
- [Troubleshooting an Expansion Card](#)
- [Troubleshooting the Processor](#)

Safety First—For You and Your System

 **CAUTION:** Many repairs may only be done by a certified service technician. You should only perform troubleshooting and simple repairs as authorized in your product documentation, or as directed by the online or telephone service and support team. Damage due to servicing that is not authorized by Dell is not covered by your warranty. Read and follow the safety instructions that came with the product.

Troubleshooting System Startup Failure

If your system halts during startup prior to video output, especially after installing an operating system or reconfiguring your system's hardware, check for the following conditions:

1. If you boot the system to the BIOS boot mode after installing an operating system from the UEFI Boot Manager, the system will hang. The reverse is also true. You must boot to the same boot mode in which you installed the operating system. See [Using the System Setup Program and UEFI Boot Manager](#).
1. Invalid memory configurations could cause the system to halt at startup without any video output. See [System Memory](#).

For all other startup issues, note the system messages that appear onscreen. See [System Messages](#) for more information.

Troubleshooting External Connections

Ensure that all external cables are securely attached to the external connectors on your system before troubleshooting any external devices. See [Figure 1-1](#) and [Figure 1-2](#) for the front-panel and back-panel connectors on your system.

Troubleshooting the Video Subsystem

1. Check the system and power connections to the monitor.
2. Check the video interface cabling from the system to the monitor.
3. Run the appropriate online diagnostic test. See [Running the System Diagnostics](#).

If the tests run successfully, the problem is not related to video hardware.

If the tests fail, see [Getting Help](#).

Troubleshooting a USB Device

Use the following steps to troubleshoot a USB keyboard /mouse. For other USB devices, go to [step 4](#).

1. Disconnect the keyboard and mouse cables from the system briefly and reconnect them.
2. Connect the keyboard/mouse to the USB port(s) on the opposite side of the system.
3. If the problem is resolved, restart the system, enter the System Setup program, and check if the non functioning USB ports are enabled.

4. Replace the keyboard/mouse with another working keyboard/mouse.
 5. If the problem is resolved, replace the faulty keyboard/mouse.
 6. If the problem is not resolved, proceed to the next step to begin troubleshooting the other USB devices attached to the system.
 7. Power down all attached USB devices and disconnect them from the system.
 8. Restart the system and, if your keyboard is functioning, enter the system setup program. Verify that all USB ports are enabled. See [Integrated Devices Screen](#).

If your keyboard is not functioning, you can also use remote access. If the system is not accessible, see [Disabling a Forgotten Password](#) for instructions on setting the NVRAM_CLR jumper inside your system and restoring the BIOS to the default settings.
 9. Reconnect and power on each USB device one at a time.
 10. If a device causes the same problem, power down the device, replace the USB cable, and power up the device.

If the problem persists, replace the device.

If all troubleshooting fails, see [Getting Help](#).
-

Troubleshooting a Serial I/O Device

1. Turn off the system and any peripheral devices connected to the serial port.
 2. Swap the serial interface cable with another working cable, and turn on the system and the serial device.

If the problem is resolved, replace the interface cable.
 3. Turn off the system and the serial device, and swap the device with a comparable device.
 4. Turn on the system and the serial device.

If the problem is resolved, replace the serial device.

If the problem persists, see [Getting Help](#).
-

Troubleshooting a NIC

1. Run the appropriate online diagnostic test. See [Running the System Diagnostics](#).
 2. Restart the system and check for any system messages pertaining to the NIC controller.
 3. Check the appropriate indicator on the NIC connector. See [NIC Indicator Codes](#).
 1. If the link indicator does not light, check all cable connections.
 1. If the activity indicator does not light, the network driver files might be damaged or missing.

Remove and reinstall the drivers if applicable. See the NIC's documentation.
 1. Change the autonegotiation setting, if possible.
 1. Use another connector on the switch or hub.
If you are using a NIC card instead of an integrated NIC, see the documentation for the NIC card.
 4. Ensure that the appropriate drivers are installed and the protocols are bound. See the NIC's documentation.
 5. Enter the System Setup program and confirm that the NIC ports are enabled. See [Integrated Devices Screen](#).
 6. Ensure that the NICs, hubs, and switches on the network are all set to the same data transmission speed. See the documentation for each network device.
 7. Ensure that all network cables are of the proper type and do not exceed the maximum length.

If all troubleshooting fails, see [Getting Help](#).
-

Troubleshooting a Wet System

CAUTION: Many repairs may only be done by a certified service technician. You should only perform troubleshooting and simple repairs as authorized in your product documentation, or as directed by the online or telephone service and support team. Damage due to servicing that is not authorized by Dell is not covered by your warranty. Read and follow the safety instructions that came with the product.

1. Turn off the system and attached peripherals, and disconnect the system from the electrical outlet.
 2. Open the system. See [Opening the System](#).
 3. Remove the following components from the system. See [Installing System Components](#).
 1. Hard drives
 1. USB memory key
 1. NIC hardware key
 1. VFlash media
 1. Expansion card and expansion-card riser
 1. iDRAC6 Enterprise card
 1. iDRAC6 Express card
 1. Power supply
 1. Fans
 1. Processor and heat sink
 1. Memory modules
 4. Let the system dry thoroughly for at least 24 hours.
 5. Reinstall the components you removed in [step 3](#).
 6. Close the system. See [Closing the System](#).

If the system does not start properly, see [Getting Help](#).
 7. If the system starts properly, shut down the system and reinstall the expansion card that you removed. See [Installing an Expansion Card](#).
 8. Run the appropriate online diagnostic test. See [Running the System Diagnostics](#).

If the tests fail, see [Getting Help](#).
-

Troubleshooting a Damaged System

CAUTION: Many repairs may only be done by a certified service technician. You should only perform troubleshooting and simple repairs as authorized in your product documentation, or as directed by the online or telephone service and support team. Damage due to servicing that is not authorized by Dell is not covered by your warranty. Read and follow the safety instructions that came with the product.

1. Open the system. See [Opening the System](#).
2. Ensure that the following components are properly installed:
 1. Expansion card and expansion-card riser
 1. Power supply
 1. Fans
 1. Processor and heat sink
 1. Memory modules
 1. Hard-drive brackets
 1. Cooling shroud
3. Ensure that all cables are properly connected.
4. Close the system. See [Closing the System](#).

5. Run the system board tests in the system diagnostics. See [Running the System Diagnostics](#).

If the tests fail, see [Getting Help](#).

Troubleshooting the System Battery

 **NOTE:** If the system is turned off for long periods of time (for weeks or months), the NVRAM may lose its system configuration information. This situation is caused by a defective battery.

1. Re-enter the time and date through the System Setup program. See [Using the System Setup Program and UEFI Boot Manager](#).
2. Turn off the system and disconnect it from the electrical outlet for at least one hour.
3. Reconnect the system to the electrical outlet and turn on the system.
4. Enter the System Setup program.

If the date and time are not correct in the System Setup program, replace the battery. See [Replacing the System Battery](#).

If the problem is not resolved by replacing the battery, see [Getting Help](#).

 **NOTE:** Some software may cause the system time to speed up or slow down. If the system seems to operate normally except for the time kept in the System Setup program, the problem may be caused by software rather than by a defective battery.

Troubleshooting Power Supply

1. Reseat the power supply by removing and reinstalling it. See [Removing the Power Supply](#) and [Installing the Power Supply](#).

 **NOTE:** After installing a power supply, allow several seconds for the system to recognize the power supply and to determine if it is working properly. The power indicator turns green to signify that the power supply is functioning properly.

2. If the problem persists, replace the faulty power supply.
If the problem is not resolved by replacing the power supply, see [Getting Help](#).
-

Troubleshooting System Cooling Problems

 **CAUTION:** Many repairs may only be done by a certified service technician. You should only perform troubleshooting and simple repairs as authorized in your product documentation, or as directed by the online or telephone service and support team. Damage due to servicing that is not authorized by Dell is not covered by your warranty. Read and follow the safety instructions that came with the product.

Ensure that none of the following conditions exist:

1. System cover, cooling shroud, drive blank, memory-module blank, power-supply blank, or back filler bracket is removed.
 1. Ambient temperature is too high.
 1. External airflow is obstructed.
 1. An individual cooling fan is removed or has failed. See [Troubleshooting a Fan](#).
-

Troubleshooting a Fan

 **CAUTION:** Many repairs may only be done by a certified service technician. You should only perform troubleshooting and simple repairs as authorized in your product documentation, or as directed by the online or telephone service and support team. Damage due to servicing that is not authorized by Dell is not covered by your warranty. Read and follow the safety instructions that came with the product.

1. Locate the faulty fan indicated by the diagnostic software.
2. Turn off the system and all attached peripherals.
3. Open the system. See [Opening the System](#).
4. Reseat the fan's power cable.

5. Restart the system.

If the fan functions properly, close the system. See [Closing the System](#).

6. If the fan does not function, turn off the system and install a new fan. See [Cooling Fans](#).

7. Restart the system.

If the problem is resolved, close the system. See [Closing the System](#).

If the replacement fan does not operate, see [Getting Help](#).

Troubleshooting System Memory

 **CAUTION:** Many repairs may only be done by a certified service technician. You should only perform troubleshooting and simple repairs as authorized in your product documentation, or as directed by the online or telephone service and support team. Damage due to servicing that is not authorized by Dell is not covered by your warranty. Read and follow the safety instructions that came with the product.

 **NOTE:** Invalid memory configurations can cause your system to halt at startup without video output. See [General Memory Module Installation Guidelines](#) and verify that your memory configuration complies with all applicable guidelines.

1. If the system is operational, run the appropriate online diagnostic test. See [Running the System Diagnostics](#).

If diagnostics indicates a fault, follow the corrective actions provided by the diagnostic program.

2. If the system is not operational, turn off the system and attached peripherals, and unplug the system from the power source. Wait at least 10 seconds and then reconnect the system to power.

3. Turn on the system and attached peripherals and note the messages on the screen.

Go to [step 12](#) if an error message appears indicating a fault with a specific memory module.

4. Enter the System Setup program and check the system memory setting. See [Memory Settings Screen](#). Make any changes to the memory settings, if needed.

If the memory settings match the installed memory but a problem is still indicated, go to [step 12](#).

5. Turn off the system and attached peripherals, and disconnect the system from the electrical outlet.

6. Open the system. See [Opening the System](#).

7. Check the memory banks and ensure that they are populated correctly. See [General Memory Module Installation Guidelines](#).

8. Reseat the memory modules in their sockets. See [Installing Memory Modules](#).

9. Close the system. See [Closing the System](#).

10. Reconnect the system to its electrical outlet, and turn on the system and attached peripherals.

11. Enter the System Setup program and check the system memory setting. See [Memory Settings Screen](#).

If the problem is not resolved, proceed with the next step.

12. Turn off the system and attached peripherals, and disconnect the system from the power source.

13. Open the system. See [Opening the System](#).

14. If a diagnostic test or error message indicates a specific memory module as faulty, swap or replace the module.

15. To troubleshoot an unspecified faulty memory module, replace the memory module in the first DIMM socket with a module of the same type and capacity. See [Installing Memory Modules](#).

16. Close the system. See [Closing the System](#).

17. As the system boots, observe any error message that appears and the diagnostic indicators on the front of the system.

18. If the memory problem is still indicated, repeat [step 12](#) through [step 17](#) for each memory module installed.

If the problem persists after all memory modules have been checked, see [Getting Help](#).

Troubleshooting an Internal USB Key

CAUTION: Many repairs may only be done by a certified service technician. You should only perform troubleshooting and simple repairs as authorized in your product documentation, or as directed by the online or telephone service and support team. Damage due to servicing that is not authorized by Dell is not covered by your warranty. Read and follow the safety instructions that came with the product.

1. Enter the System Setup program and ensure that the USB key port is enabled. See [Integrated Devices Screen](#).
2. Turn off the system and attached peripherals.
3. Open the system. See [Opening the System](#).
4. Locate the USB key and reseal it. See [Internal USB Memory Key](#).
5. Close the system. See [Closing the System](#).
6. Turn on the system and attached peripherals and check if the USB key is functioning.
7. If the problem is not resolved, repeat [step 2](#) and [step 3](#).
8. Insert a different USB key that you know works properly.
9. Close the system. See [Closing the System](#).
10. Turn on the system and attached peripherals and check if the USB key is functioning.

If the problem is not resolved, see [Getting Help](#).

Troubleshooting an Optical Drive

CAUTION: Many repairs may only be done by a certified service technician. You should only perform troubleshooting and simple repairs as authorized in your product documentation, or as directed by the online or telephone service and support team. Damage due to servicing that is not authorized by Dell is not covered by your warranty. Read and follow the safety instructions that came with the product.

1. Try using a different CD or DVD.
2. Enter the System Setup program and ensure that the drive's controller is enabled. See [Entering the System Setup Program](#).
3. Run the appropriate online diagnostic test. See [Running the System Diagnostics](#).
4. Turn off the system and attached peripherals, and disconnect the system from the electrical outlet.
5. Open the system. See [Opening the System](#).
6. Ensure that the interface cable is securely connected to the optical drive and to the controller.
7. Ensure that a power cable is properly connected to the drive.
8. Close the system. See [Closing the System](#).

If the problem is not resolved, see [Getting Help](#).

Troubleshooting a Tape Backup Unit

1. Try using a different tape cartridge.
2. Ensure that the device drivers for the tape drive are installed and are configured correctly. See your tape drive documentation for more information about device drivers.
3. Reinstall the tape-backup software as instructed in the tape-backup software documentation.

4. Ensure that the tape drive's interface cable is fully connected to the external port on the controller card.
 5. Turn off the system and attached peripherals, and disconnect the system from the electrical outlet.
 6. Open the system. See [Opening the System](#).
 7. Reseat the controller card in the expansion card slot.
 8. Ensure that the tape drive's interface cable is fully connected to the tape drive and to the connector on the controller card (SAS or SCSI).
 9. Ensure that the power cable is properly connected to the drive and system board.
 10. Close the system. See [Closing the System](#).
 11. For SCSI tape drives, verify that the tape drive is configured for a unique SCSI ID number and that the tape drive is terminated or not terminated, based on the interface cable used to connect the drive.

See the documentation for the tape drive for instructions on selecting the SCSI ID number and enabling or disabling termination.
 12. Run the appropriate online diagnostics tests. See [Running the System Diagnostics](#).

If you cannot resolve the problem, see [Getting Help](#).
-

Troubleshooting a Hard Drive

 **CAUTION:** Many repairs may only be done by a certified service technician. You should only perform troubleshooting and simple repairs as authorized in your product documentation, or as directed by the online or telephone service and support team. Damage due to servicing that is not authorized by Dell is not covered by your warranty. Read and follow the safety instructions that came with the product.

 **CAUTION:** This troubleshooting procedure can destroy data stored on the hard drive. Before you proceed, back up all files on the hard drive.

1. Run the appropriate online diagnostics test. See [Running the System Diagnostics](#).

Depending on the results of the diagnostics test, proceed as needed through the following steps.
 2. If your system has a RAID controller card and your hard drives are configured in a RAID array, perform the following steps:
 - a. Restart the system and enter the host adapter configuration utility program by pressing <Ctrl><R> for a PERC controller or <Ctrl><C> for a SAS controller.

See the documentation supplied with the host adapter for information about the configuration utility.
 - b. Ensure that the hard drive(s) have been configured correctly for the RAID array.
 - c. Take the hard drive offline and reseat the drive. See [Removing a Hard Drive](#).
 - d. Exit the configuration utility and allow the system to boot to the operating system.
 3. Ensure that the required device drivers for your controller card are installed and are configured correctly. See the operating system documentation for more information.
 4. Restart the system, enter the System Setup program, and verify that the drives appear in the System Setup program. See [Entering the System Setup Program](#).
-

Troubleshooting an Expansion Card

 **CAUTION:** Many repairs may only be done by a certified service technician. You should only perform troubleshooting and simple repairs as authorized in your product documentation, or as directed by the online or telephone service and support team. Damage due to servicing that is not authorized by Dell is not covered by your warranty. Read and follow the safety instructions that came with the product.

 **NOTE:** When troubleshooting an expansion card, see the documentation for your operating system and the expansion card.

1. Run the appropriate online diagnostic test. See [Running the System Diagnostics](#).
2. Turn off the system and attached peripherals, and disconnect the system from the electrical outlet.
3. Open the system. See [Opening the System](#).

4. Ensure that the expansion-card riser is firmly seated in its connector. See [Installing an Expansion Card](#).
 5. Ensure that the expansion card is firmly seated in its connector. See [Installing an Expansion Card](#).
 6. Close the system. See [Closing the System](#).
 7. If the problem is not resolved, turn off the system and attached peripherals, and disconnect the system from the electrical outlet.
 8. Open the system. See [Opening the System](#).
 9. Remove the expansion card. See [Removing an Expansion Card](#).
 10. Close the system. See [Closing the System](#).
 11. Run the appropriate online diagnostic test.
If the tests fail, see [Getting Help](#).
-

Troubleshooting the Processor

 **WARNING:** Only trained service technicians are authorized to remove the system cover and access any of the components inside the system. Before you begin this procedure, review the safety instructions that came with the system.

1. Run the appropriate online diagnostics test. See [Using Online Diagnostics](#).
 2. Turn off the system and attached peripherals, and disconnect the system from the electrical outlet.
 3. Open the system. See [Opening the System](#).
 4. Ensure that the processor and heat sink are properly installed. See [Processor](#).
 5. Close the system. See [Closing the System](#).
 6. Run the appropriate online diagnostic test.
If a problem is still indicated, see [Getting Help](#).
-

[Back to Contents Page](#)