

# Dell PowerEdge R860

## Technical Guide

## Notes, cautions, and warnings

 **NOTE:** A NOTE indicates important information that helps you make better use of your product.

 **CAUTION:** A CAUTION indicates either potential damage to hardware or loss of data and tells you how to avoid the problem.

 **WARNING:** A WARNING indicates a potential for property damage, personal injury, or death.

|  |           |
|--|-----------|
| <b>Chapter 1: Dell PowerEdge R860 system overview.....</b>         | <b>5</b>  |
| Key workloads.....   | 5         |
| New technologies.....  | 5         |
| <b>Chapter 2: System features and generational comparison.....</b> | <b>7</b>  |
| <b>Chapter 3: Chassis views and features.....</b>                  | <b>10</b> |
| Front view of the system.....                                      | 10        |
| Rear view of the system.....                                       | 11        |
| Inside the system.....   | 12        |
| Quick Resource Locator.....  | 15        |
| <b>Chapter 4: Processor.....</b>                                   | <b>17</b> |
| Processor features .....   | 17        |
| Supported processors.....  | 17        |
| <b>Chapter 5: Memory subsystem.....</b>                            | <b>18</b> |
| Supported memory.....  | 18        |
| <b>Chapter 6: Storage.....</b>                                     | <b>19</b> |
| Storage controllers.....   | 19        |
| Supported Drives.....  | 19        |
| Internal storage configuration.....                                | 20        |
| External Storage.....  | 20        |
| <b>Chapter 7: Networking.....</b>                                  | <b>21</b> |
| Overview.....  | 21        |
| OCP 3.0 support.....   | 21        |
| Supported OCP cards.....   | 21        |
| OCP NIC 3.0 vs. rack Network Daughter Card comparisons.....        | 22        |
| <b>Chapter 8: PCIe subsystem.....</b>                              | <b>23</b> |
| PCIe risers.....   | 23        |
| <b>Chapter 9: Power, thermal, and acoustics.....</b>               | <b>29</b> |
| Power.....   | 29        |
| Power Supply Units.....  | 30        |
| Thermal.....   | 31        |
| Thermal design.....  | 31        |
| Acoustics.....   | 32        |
| Acoustical performance.....  | 32        |
| PowerEdge acoustical specifications.....                           | 33        |

|   |           |
|---|-----------|
| <b>Chapter 10: Rack, rails, and cable management.....</b>     | <b>41</b> |
| Rails and cable management information.....                   | 41        |
| <b>Chapter 11: Operating Systems and Virtualization.....</b>  | <b>50</b> |
| Supported operating systems.....                              | 50        |
| <b>Chapter 12: Dell OpenManage Systems Management.....</b>    | <b>51</b> |
| Integrated Dell Remote Access Controller (iDRAC).....         | 51        |
| Systems Management software support matrix.....               | 52        |
| <b>Chapter 13: Appendix D: Service and support.....</b>       | <b>54</b> |
| Default support levels.....                                   | 54        |
| Default deployment levels.....                                | 54        |
| Other services and support information.....                   | 54        |
| Dell deployment services.....                                 | 54        |
| Dell custom deployment Services.....                          | 58        |
| Dell Residency Services.....                                  | 58        |
| Dell Data Migration Services.....                             | 58        |
| Dell Enterprise Support Services.....                         | 59        |
| Enterprise connectivity.....                                  | 61        |
| Dell TechDirect.....  | 62        |
| Dell Technologies Consulting Services.....                    | 62        |
| <b>Chapter 14: Appendix A: Additional specifications.....</b> | <b>64</b> |
| Chassis dimensions .....                                      | 64        |
| Chassis weight.....   | 65        |
| NIC port specifications.....                                  | 65        |
| Video specifications.....                                     | 65        |
| USB Ports.....  | 66        |
| PSU rating.....   | 67        |
| Environmental specifications.....                             | 68        |
| Thermal restriction matrix.....                               | 70        |
| Thermal air restrictions.....                                 | 71        |
| <b>Chapter 15: Appendix B. Standards compliance.....</b>      | <b>73</b> |
| <b>Chapter 16: Appendix C Additional resources.....</b>       | <b>74</b> |



# Dell PowerEdge R860 system overview

The PowerEdge R860 system is a 2U server that supports:

- Up to 4 x 4<sup>th</sup> Gen Intel® Xeon® Scalable Processors with up to 60 cores
- 64 DDR5 DIMM slots, supports maximum 16 TB
- Two AC or DC power supply units with 1+1 redundancy
- Up to 8 x 2.5-inch SAS/SATA (HDD/SSD) drives
- Up to 8 x EDSFF E3.S NVMe Gen5 (SSD) drives
- Up to 16 x 2.5-inch SAS/SATA/NVMe (HDD/SSD) drives
- Up to 24 x 2.5-inch SAS/SATA/NVMe (HDD/SSD) drives
- Up to 16 x 2.5-inch SAS/SATA (HDD/SSD) + 8 x 2.5-inch NVMe (SSD) drives
- Up to 24 x 2.5-inch SAS/SATA (HDD/SSD) + 2 x 2.5-inch (rear) SAS/SATA/NVMe (HDD/SSD) drives
- PCI Express® (PCIe) 5.0 enabled expansion slots
- Network interface technologies to cover Network Interface Card (NIC)

**NOTE:** For more information about how to hot swap NVMe PCIe SSD U.2 device, see the *Dell Express Flash NVMe PCIe SSD User's Guide* at <https://www.dell.com/support> > **Browse all products** > **Infrastructure** > **Data Center Infrastructure** > **Storage Adapters & Controllers** > **Dell PowerEdge Express Flash NVMe PCIe SSD** > **Select This Product** > **Documentation** > **Manuals and Documents**.

**NOTE:** All instances of SAS, SATA, NVMe drives are referred to as drives in this document, unless specified otherwise.

**CAUTION:** Do not install GPUs, network cards, or other PCIe devices on your system that are not validated and tested by Dell. Damage caused by unauthorized and invalidated hardware installation will null and void the system warranty.

## Topics:

- [Key workloads](#)
- [New technologies](#)

## Key workloads

Customers looking for accelerated compute to maximize performance in a dense, scalable server architecture to address the following applications:

- SAP/HANA, Oracle, SQL
- Database, ERP, CRM, batch
- Data warehouse, business intelligence
- Virtualization/VM and VDI
- AI, HPC and ML/DL

## New technologies

**Table 1. New technologies**

| Technology  | Detailed Description   |
|---|--|
| 4 <sup>th</sup> Generation Intel® Xeon® Scalable Processors | Core count: Up to 60 core processor                                    |
|   | UPI speed: Up to 4 links per CPU, speed: 12.8 GT/s, 14.4 GT/s, 16 GT/s |

**Table 1. New technologies (continued)**

| Technology            | Detailed Description  |
|-----------------------|---|
|                       | Maximum number of PCIe lanes per CPU: Integrated 80 PCIe 5.0 lanes @ 32GT/s PCIe Gen5<br>Maximum TDP: 350 W   |
| 4800 MT/s DDR5 Memory | Max 16 DIMM per processor and 64 DIMMs per system<br>Supports DDR5 ECC RDIMM  |
| PCIe Gen              | Gen5 @32 GT/s   |
| PCIe Slot             | Up to eight Gen5 (x16) slots  |
| Flex I/O              | LOM board, 2 x1Gb with BCM5720 LAN controller (optional)<br>Rear I/O with: <ul style="list-style-type: none"> <li>● 1 x Dedicated iDRAC Ethernet port</li> <li>● 1 x USB 3.0</li> <li>● 1 x USB 2.0</li> <li>● 1 x VGA port</li> </ul> Serial Port (option) with STD RIO board<br>OCP Mezz 3.0 (supported by x168 PCIe lanes) (optional)<br>Front I/O with: <ul style="list-style-type: none"> <li>● 1 x USB 2.0</li> <li>● 1 x iDRAC Direct (Micro-AB USB) port</li> <li>● 1 x VGA port</li> </ul> |
| CPLD 1-wire           | Support payload data of Front PERC, Riser, BP and Rear IO to BOSS N1 and iDRAC  |
| Dedicated PERC        | PERC 11 <ul style="list-style-type: none"> <li>● H355, H755</li> </ul> PERC 12 <ul style="list-style-type: none"> <li>● H965i, H965e</li> </ul>   |
| Software RAID         | OS RAID / S160  |
| Power Supplies        | 60 mm dimension is the new PSU form factor on 15G design<br>Titanium 1100 W AC/HVDC<br>Platinum 1400 W AC/HVDC<br>Titanium 1800 W AC/HVDC<br>86 mm dimension PSU<br>Platinum 2400 W AC/HVDC<br>Titanium 2800 W AC/HVDC  |


## System features and generational comparison

The following table shows the comparison between the PowerEdge R860 with the PowerEdge R840.

**Table 2. Features comparison**


| Features               | PowerEdge R860   | PowerEdge R840  |
|------------------------|--|---|
| Processors             | 4 x 4 <sup>th</sup> Gen Intel® Xeon® Scalable Processors   | 4 x 2 <sup>nd</sup> Generation Intel® Xeon® Scalable Processor  |
| Processor interconnect | Intel Ultra Path Interconnect (UPI)  | Intel Ultra Path Interconnect (UPI)   |
| Memory                 | <ul style="list-style-type: none"> <li>64 x DDR5 RDIMM</li> <li>Up to 4800 MT/s (1 DPC) / 4400 MT/s (2 DPC)</li> </ul>   | <ul style="list-style-type: none"> <li>48 x DDR4 DIMM RDIMM /LRDIMM</li> <li>24 x PMem ( Intel Optane Persistent Memory)</li> <li>12 x NVDIMM</li> </ul>  |
| Storage Controllers    | <ul style="list-style-type: none"> <li>PERC 11G: H755, H355</li> <li>PERC 12G: H965i, H965e</li> <li>HBA 11: HBA355i, HBA355e</li> <li>BOSS-N1</li> <li>Software RAID: S160</li> </ul>   | <ul style="list-style-type: none"> <li>PERC 9G: H330, H730p</li> <li>PERC 10G: H740p, H840</li> <li>HBA 9: HBA330, 12 Gbps SAS HBA</li> <li>BOSS adapter</li> <li>Software RAID: S140</li> <li>Internal Dual SD Module</li> </ul>         |
| Drive Bays             | <p>Front bays:</p> <ul style="list-style-type: none"> <li>2.5 inches - 24Gb SAS, 6Gb SATA</li> <li>2.5 inches - Gen3/4 NVMe</li> <li>EDSFF E3.S - NVMe Gen5</li> </ul> <p>Rear bay:</p> <ul style="list-style-type: none"> <li>2.5 inches - 24Gb SAS, 6Gb SATA, Gen3/4 NVMe</li> </ul> | <p>Front bays:</p> <ul style="list-style-type: none"> <li>2.5 inches - 24Gb SAS, 6Gb SATA</li> <li>2.5 inches - Gen3/4 NVMe</li> </ul> <p>Rear bay:</p> <ul style="list-style-type: none"> <li>2.5 inches - 12Gb SAS, 6Gb SATA</li> </ul> |
| Power Supplies         | <ul style="list-style-type: none"> <li>AC (Platinum): 1400 W, 2400 W</li> <li>AC (Titanium): 1100 W, 1800 W, 2800 W</li> </ul>   | <ul style="list-style-type: none"> <li>AC (Platinum): 750 W, 1100 W, 1600 W, 2000 W, 2400 W</li> <li>AC (Titanium): 1600 W, 2600 W</li> <li>LVDC @-48VDC Input: 1100 W</li> </ul>   |
| Cooling Options        | <ul style="list-style-type: none"> <li>Air Cooling</li> </ul>  | <ul style="list-style-type: none"> <li>Air Cooling</li> </ul>   |
| Fans                   | <p>Standard (STD) fans</p> <p>Up to 6 sets (dual fan module) hot plug fans</p>   | <p>Standard (STD) fans</p> <p>Up to six hot plug fans</p>   |
| Dimension              | <p>Height: 86.8 mm (3.41 inches)</p> <p>Width: 482 mm (18.97 inches)</p> <p>Depth: 883.2 mm (34.77 inches) with bezel</p> <p>Depth: 869.2 mm (34.22 inches) without bezel</p>  | <p>Height: 86.8mm (3.4 inches)</p> <p>Width: 434.0mm (17.08 inches)</p> <p>Depth: 879.8 mm (34.63 inches) with bezel</p> <p>Depth: 865.9 mm (34.09 inches) without bezel</p>  |
| Form Factor            | 2U rack server   | 2U rack server  |
| Embedded Management    | <ul style="list-style-type: none"> <li>iDRAC9</li> <li>iDRAC Direct</li> </ul>   | <ul style="list-style-type: none"> <li>iDRAC9</li> <li>iDRAC Direct</li> </ul>  |

**Table 2. Features comparison (continued)**

| Features  | PowerEdge R860   | PowerEdge R840  |   |   |   |  |
|---|--|---|---|---|---|--|
|   | <ul style="list-style-type: none"> <li>• iDRAC RESTful API with Redfish</li> <li>• iDRAC Service Manual</li> <li>• Quick Sync 2 wireless module</li> </ul>   | <ul style="list-style-type: none"> <li>• Quick Sync 2 BLE/wireless module</li> </ul>  |   |   |   |  |
| Bezel   | Optional LCD bezel or security bezel   | Optional LCD bezel or security bezel  |   |   |   |  |
| OpenManage Software   | <ul style="list-style-type: none"> <li>• CloudIQ for PowerEdge plug in</li> <li>• OpenManage Enterprise</li> <li>• OpenManage Enterprise Integration for VMware vCenter</li> <li>• OpenManage Integration for Microsoft System Center</li> <li>• OpenManage Integration with Windows Admin Center</li> <li>• OpenManage Power Manager plug-in</li> <li>• OpenManage Services plug-in</li> <li>• OpenManage Update Manager plug-in</li> </ul>   | <ul style="list-style-type: none"> <li>• OpenManage Enterprise</li> <li>• OpenManage Power Center</li> </ul>  |   |   |   |  |
| Mobility  | OpenManage Mobile  | OpenManage Mobile   |   |   |   |  |
| Integrations and Connections  | OpenManage Integrations <ul style="list-style-type: none"> <li>• BMC Truesight</li> <li>• Microsoft System Center</li> <li>• OpenManage Integration with ServiceNow</li> <li>• Red Hat Ansible Modules</li> <li>• Terraform Providers</li> <li>• VMware vCenter and vRealize Operations Manager</li> </ul>   | <table border="1"> <tr> <td>                             OpenManage Integrations                             <ul style="list-style-type: none"> <li>• BMC Truesight @</li> <li>• Microsoft System Center</li> <li>• Red Hat Ansible Modules</li> <li>• VMware vCenter</li> </ul> </td> <td>                             OpenManage Connections                             <ul style="list-style-type: none"> <li>• IBM Tivoli Netcool/OMNibus</li> <li>• Micro Focus Operations Manager</li> <li>• Nagios® Core &amp; Nagios® XI</li> </ul> </td> </tr> </table> | OpenManage Integrations <ul style="list-style-type: none"> <li>• BMC Truesight @</li> <li>• Microsoft System Center</li> <li>• Red Hat Ansible Modules</li> <li>• VMware vCenter</li> </ul>           | OpenManage Connections <ul style="list-style-type: none"> <li>• IBM Tivoli Netcool/OMNibus</li> <li>• Micro Focus Operations Manager</li> <li>• Nagios® Core &amp; Nagios® XI</li> </ul>  |   |  |
| OpenManage Integrations <ul style="list-style-type: none"> <li>• BMC Truesight @</li> <li>• Microsoft System Center</li> <li>• Red Hat Ansible Modules</li> <li>• VMware vCenter</li> </ul> | OpenManage Connections <ul style="list-style-type: none"> <li>• IBM Tivoli Netcool/OMNibus</li> <li>• Micro Focus Operations Manager</li> <li>• Nagios® Core &amp; Nagios® XI</li> </ul>   |   |   |   |   |  |
| Security  | <ul style="list-style-type: none"> <li>• Cryptographically signed firmware</li> <li>• Data at Rest Encryption (SEDs with local or external key mgmt)</li> <li>• Secure Boot</li> <li>• Secured Component Verification (Hardware integrity check)</li> <li>• Secure Erase</li> <li>• Silicon Root of Trust</li> <li>• System Lockdown (requires iDRAC9 Enterprise or Datacenter)</li> <li>• TPM 2.0 FIPS, CC-TCG certified, TPM 2.0 China NationZ</li> </ul>  | <ul style="list-style-type: none"> <li>• Cryptographically signed firmware</li> <li>• Secure Boot</li> <li>• Secure Erase</li> <li>• Silicon Root of Trust</li> <li>• System Lockdown (requires iDRAC9 Enterprise or Datacenter)</li> <li>• TPM 1.2/2.0, TCM 2.0 optional</li> </ul>  |   |   |   |  |
| Embedded NIC  | 2 x 1GbE LOM card (optional)   | 4 x 1GbE Network Daughter Card (optional)   |   |   |   |  |
| Networking Options  | OCP x16 (optional) Mezz 3.0<br> <b>NOTE:</b> The system allows either LOM card or OCP card or both to be installed in the system.   | NA  |   |   |   |  |
| GPU Options   | NA   | Up to 2 doublewidth GPUs or up to 2 full height FPGAs   |   |   |   |  |
| Ports   | <table border="1"> <tr> <td>                             Front Ports                             <ul style="list-style-type: none"> <li>• 1 x USB 2.0</li> <li>• 1 x VGA</li> <li>• 1 x Dedicated iDRAC micro-USB</li> </ul> </td> <td>                             Rear Ports                             <ul style="list-style-type: none"> <li>• 1 x USB 2.0</li> <li>• 1 x iDRAC Direct/ ethernet port</li> <li>• 1 x USB 3.0</li> <li>• 1 x Serial port (optional)</li> <li>• 1 x VGA</li> </ul> </td> </tr> </table> | Front Ports <ul style="list-style-type: none"> <li>• 1 x USB 2.0</li> <li>• 1 x VGA</li> <li>• 1 x Dedicated iDRAC micro-USB</li> </ul>   | Rear Ports <ul style="list-style-type: none"> <li>• 1 x USB 2.0</li> <li>• 1 x iDRAC Direct/ ethernet port</li> <li>• 1 x USB 3.0</li> <li>• 1 x Serial port (optional)</li> <li>• 1 x VGA</li> </ul> | <table border="1"> <tr> <td>                             Front Ports                             <ul style="list-style-type: none"> <li>• 2 x USB 2.0</li> <li>• 1 x USB 3.0 (optional)</li> <li>• 1 x VGA</li> <li>• 1 x Dedicated iDRAC micro-USB</li> </ul> </td> <td>                             Rear Ports                             <ul style="list-style-type: none"> <li>• 2 x USB 3.0</li> <li>• 1 x iDRAC Direct/ ethernet port</li> <li>• 1 x Serial port (optional)</li> <li>• 1 x VGA</li> </ul> </td> </tr> </table> | Front Ports <ul style="list-style-type: none"> <li>• 2 x USB 2.0</li> <li>• 1 x USB 3.0 (optional)</li> <li>• 1 x VGA</li> <li>• 1 x Dedicated iDRAC micro-USB</li> </ul> | Rear Ports <ul style="list-style-type: none"> <li>• 2 x USB 3.0</li> <li>• 1 x iDRAC Direct/ ethernet port</li> <li>• 1 x Serial port (optional)</li> <li>• 1 x VGA</li> </ul> |
| Front Ports <ul style="list-style-type: none"> <li>• 1 x USB 2.0</li> <li>• 1 x VGA</li> <li>• 1 x Dedicated iDRAC micro-USB</li> </ul>   | Rear Ports <ul style="list-style-type: none"> <li>• 1 x USB 2.0</li> <li>• 1 x iDRAC Direct/ ethernet port</li> <li>• 1 x USB 3.0</li> <li>• 1 x Serial port (optional)</li> <li>• 1 x VGA</li> </ul>  |   |   |   |   |  |
| Front Ports <ul style="list-style-type: none"> <li>• 2 x USB 2.0</li> <li>• 1 x USB 3.0 (optional)</li> <li>• 1 x VGA</li> <li>• 1 x Dedicated iDRAC micro-USB</li> </ul>                   | Rear Ports <ul style="list-style-type: none"> <li>• 2 x USB 3.0</li> <li>• 1 x iDRAC Direct/ ethernet port</li> <li>• 1 x Serial port (optional)</li> <li>• 1 x VGA</li> </ul>   |   |   |   |   |  |

**Table 2. Features comparison (continued)**

| Features                         | PowerEdge R860  | PowerEdge R840  |
|----------------------------------|---|---|
|                                  | Internal Port: 1 x USB 3.0  | Internal Port: 1 x USB 3.0  |
| PCIe                             | Up to 8 x PCIe slots <ul style="list-style-type: none"> <li>• 8 x PCIe Gen5 slots</li> <li>• 4 x PCIe Gen4 slots</li> </ul>   | Up to 6 x PCIe Gen3 slots   |
| Operating System and Hypervisors | <ul style="list-style-type: none"> <li>• Canonical Ubuntu Server LTS</li> <li>• Microsoft Windows Server with Hyper-V</li> <li>• Red Hat Enterprise Linux</li> <li>• SUSE Linux Enterprise Server</li> <li>• VMware ESXi</li> </ul> For specifications and interoperability details, see <a href="https://www.dell.com/OSsupport">Dell Enterprise Operating Systems on Servers, Storage, and Networking</a> page at <a href="https://www.dell.com/OSsupport">Dell.com/OSsupport</a> . | <ul style="list-style-type: none"> <li>• Canonical Ubuntu Server LTS</li> <li>• Citrix Hypervisor</li> <li>• Microsoft Windows Server LTSC with Hyper-V</li> <li>• Red Hat Enterprise Linux</li> <li>• VMware ESXi</li> </ul> For specifications and interoperability details, see <a href="https://www.dell.com/OSsupport">Dell Enterprise Operating Systems on Servers, Storage, and Networking</a> page at <a href="https://www.dell.com/OSsupport">Dell.com/OSsupport</a> . |

 **NOTE:** From September 2023, OpenManage will be offered for R860.

# Chassis views and features

## Topics:

- Front view of the system
- Rear view of the system
- Inside the system
- Quick Resource Locator

## Front view of the system



Figure 1. Front view of 24 x 2.5-inch drive system

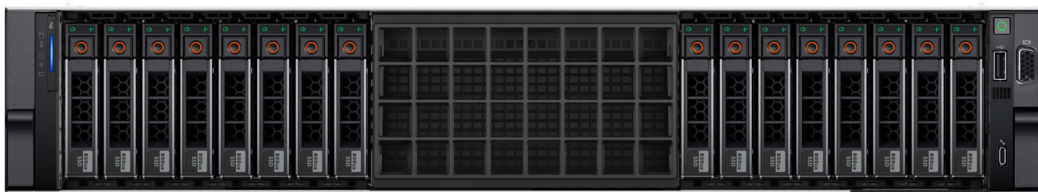


Figure 2. Front view of 16 x 2.5-inch drive system

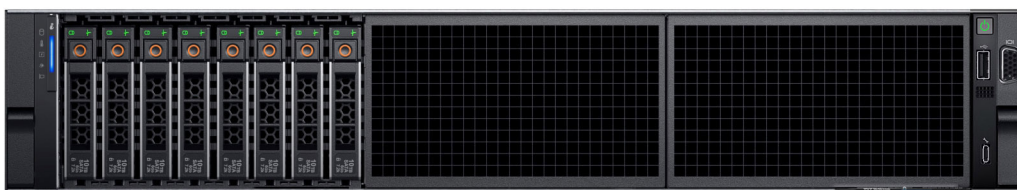


Figure 3. Front view of 8 x 2.5-inch drive system

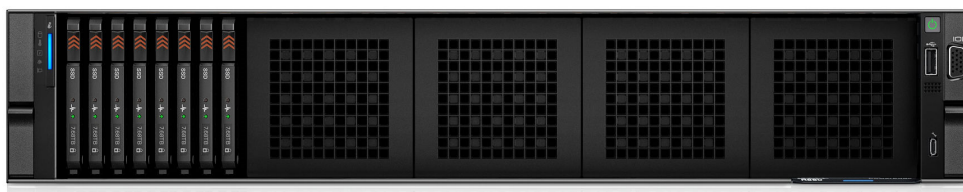


Figure 4. Front view of 8 x EDSFF E3.S drive system

## Rear view of the system



Figure 5. Rear view of the system

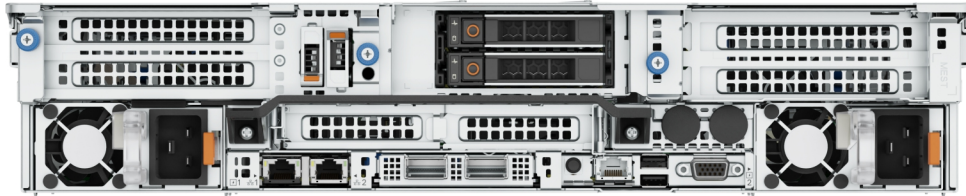


Figure 6. Rear view of the system with 2 x 2.5-inch drive system

## Inside the system

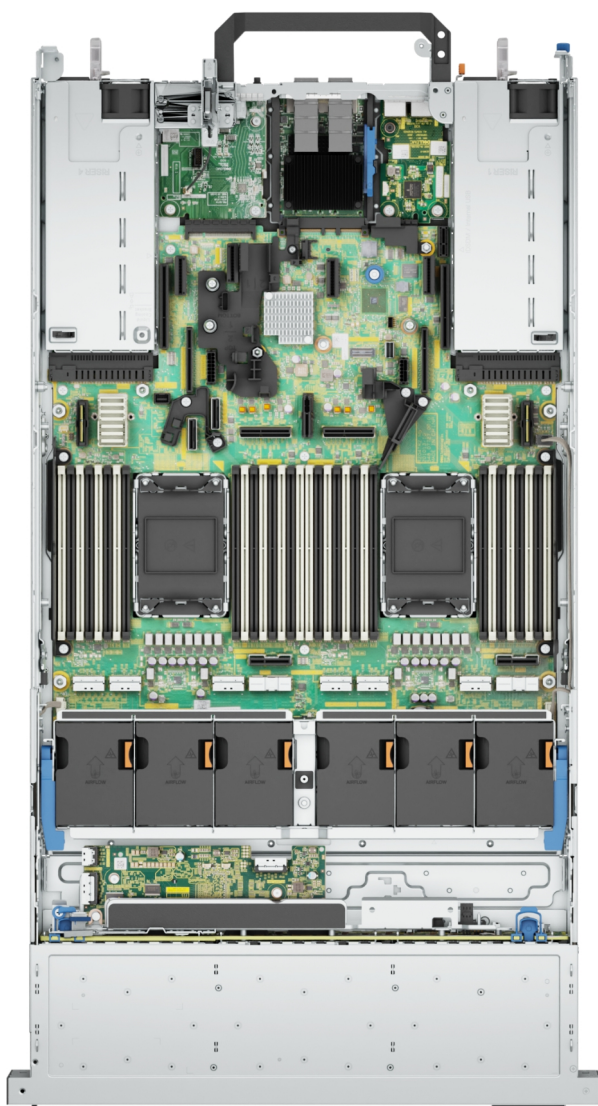


Figure 7. Inside the system without risers



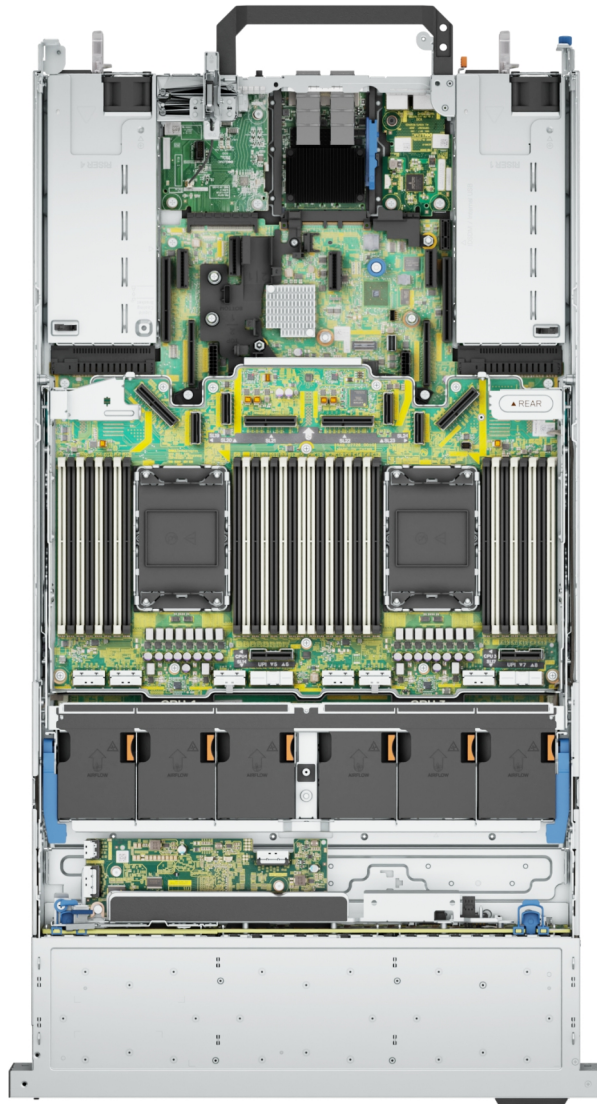


Figure 8. Inside the system without risers (PEM board installed)

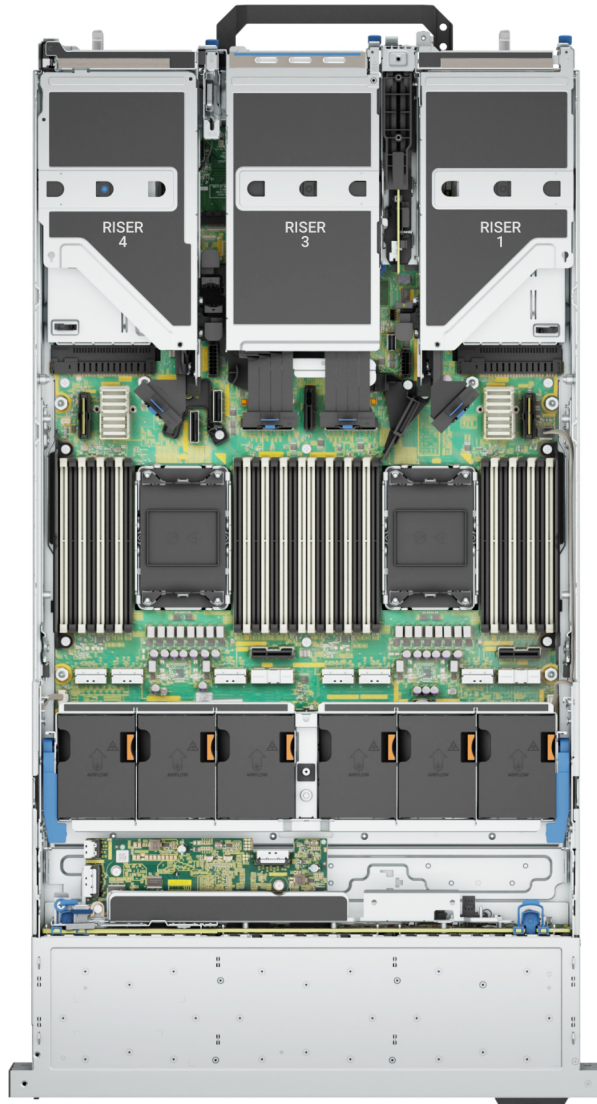


Figure 9. Inside the system with risers

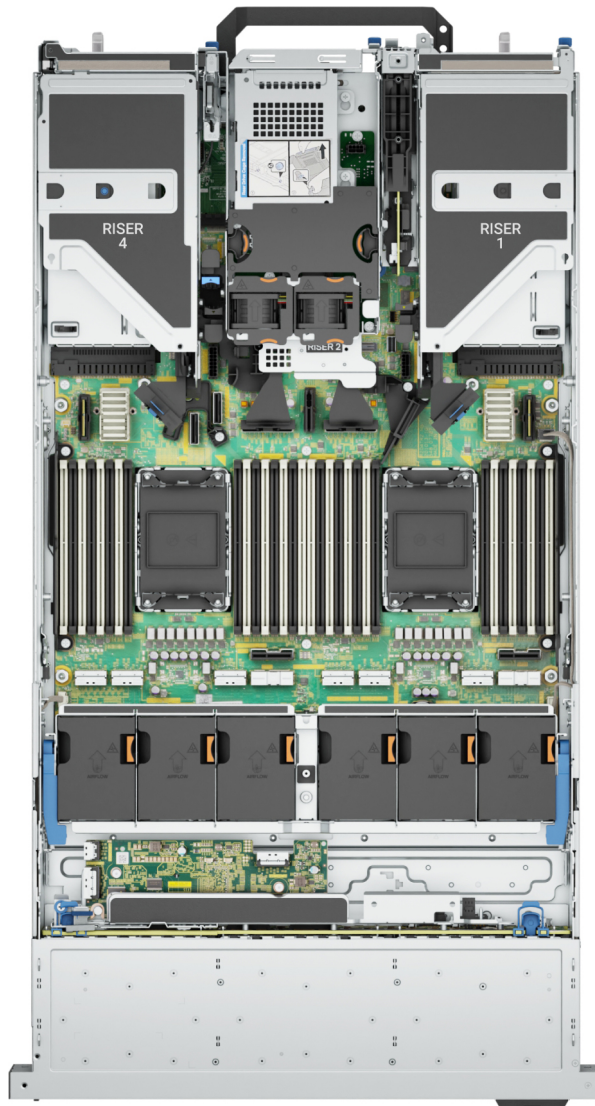


Figure 10. Inside the system with risers + rear 2 x 2.5-inch module

## Quick Resource Locator

The QRL on everything (SILs, GSG, Installation and Service Manual except on the EST) is a generic QRL for R860 that leads to a webpage for that product. That webpage has links for things like setup and service videos, iDRAC manual, and other things that apply to the platform. The QRL on the EST is unique and specific to that service tag and will contain the Service Tag number and the iDRAC password. The label and the QRL code within it are printed on demand at the L10 factories. This QRL links to a webpage that shows the exact configuration as built for that customer, and the specific warranty purchased. It is one click away from the same content of generic information that applies to R860 that is available in the other QRLs.



## **Quick Resource Locator**

[Dell.com/QRL/Server/PER860](http://Dell.com/QRL/Server/PER860)

**Figure 11. R860 Quick Resource Locator**

# Processor

## Topics:

- [Processor features](#)

## Processor features

The 4<sup>th</sup> Generation Intel® Xeon® Processors stack is the next generation data center processor offering with significant performance increases, integrated acceleration, and next generation memory and I/O. Sapphire Rapids accelerate customer usages with unique workload optimizations.

The following lists the features and functions that are in the upcoming 4<sup>th</sup> Generation Intel® Xeon® Scalable Processor offering:


- Faster UPI with up to four Intel Ultra Path Interconnect (Intel UPI) at up to 16 GT/s, increasing multisocket bandwidth
- More, faster I/O with PCI Express 5 and up to 80 lanes (per socket)
- Enhanced Memory Performance with DDR5 support and memory speed up to 4800 MT/s in one DIMM per channel (1DPC) and 4400 MT/s in two DIMM per channel (2DPC)
- New built-in accelerators for data analytics, networking, storage, crypto, and data compression

## Supported processors

The following table shows the Intel Sapphire Rapids SKUs that are supported on the R8960.

**Table 3. Supported Processors for R860**

| Processor | Clock Speed (GHz) | Cache (M) | UPI (GT/s) | Cores | Threads | Turbo | Memory Speed (MT/s) | Memory Capacity | TDP   |
|-----------|-------------------|-----------|------------|-------|---------|-------|---------------------|-----------------|-------|
| 8490H     | 1.9               | 113       | 16         | 60    | 120     | Turbo | 4800                | 6 TB            | 350 W |
| 8468H     | 2.1               | 105       | 16         | 48    | 96      | Turbo | 4800                | 6 TB            | 330 W |
| 8460H     | 2.2               | 105       | 16         | 40    | 80      | Turbo | 4800                | 6 TB            | 330 W |
| 8454H     | 2.1               | 83        | 16         | 32    | 64      | Turbo | 4800                | 6 TB            | 270 W |
| 8450H     | 2                 | 75        | 16         | 28    | 56      | Turbo | 4800                | 6 TB            | 250 W |
| 8444H     | 2.9               | 45        | 16         | 16    | 32      | Turbo | 4800                | 6 TB            | 270 W |
| 6448H     | 2.4               | 60        | 16         | 32    | 64      | Turbo | 4800                | 6 TB            | 250 W |
| 6434H     | 3.7               | 23        | 16         | 8     | 16      | Turbo | 4800                | 6 TB            | 195 W |
| 6418H     | 2.1               | 60        | 16         | 24    | 48      | Turbo | 4800                | 6 TB            | 185 W |
| 6416H     | 2.2               | 45        | 16         | 18    | 36      | Turbo | 4800                | 6 TB            | 165 W |

 **NOTE:** Mixing of the processors in a 4S configurations is not recommended.

# Memory subsystem

## Topics:

- Supported memory


## Supported memory

**Table 4. Memory technology comparison**

| Feature        | PowerEdge R860 (DDR5)               |
|----------------|-------------------------------------|
| DIMM type      | RDIMM                               |
| Transfer speed | 4800 MT/s (1DPC), 4400 MT/s ( 2DPC) |
| Voltage        | 1.1 V                               |

**Table 5. Supported memory matrix**

| DIMM type | Rank | Capacity     | DIMM rated voltage and speed | Operating Speed          |                           |
|-----------|------|--------------|------------------------------|--------------------------|---------------------------|
|           |      |              |                              | 1 DIMM per channel (DPC) | 2 DIMMs per channel (DPC) |
| RDIMM     | 1 R  | 16 GB        | DDR5 (1.1 V), 4800 MT/s      | 4800 MT/s                | 4400 MT/s                 |
|           | 2 R  | 32 GB, 64 GB | DDR5 (1.1 V), 4800 MT/s      | 4800 MT/s                | 4400 MT/s                 |
|           | 4 R  | 128 GB       | DDR5 (1.1 V), 4800 MT/s      | 4800 MT/s                | 4400 MT/s                 |
|           | 8 R  | 256 GB       | DDR5 (1.1 V), 4800 MT/s      | 4800 MT/s                | 4400 MT/s                 |

 **NOTE:** The processor may reduce the performance of the rated DIMM speed.

# Storage

## Topics:

- Storage controllers
- Supported Drives
- Internal storage configuration
- External Storage

## Storage controllers

Dell's RAID controller options offer performance improvements, including the fPERC solution. fPERC provides a base RAID HW controller without consuming a PCIe slot by using a small form factor and high-density connector to the base planar. 16G PERC Controller offerings will be a heavy leverage of 15G PERC family. The Value and Value Performance levels will carry over to 16G from 15G. New to 16G, is the Harpoon-based Premium Performance tier offering. This high-end offering will drive IOPs performance and enhanced SSD performance.

**Table 6. PERC Series controller offerings**

| Performance Level   | Controller and Description       |
|---------------------|----------------------------------|
| Entry               | S160                             |
| Value               | H355, HBA355 (internal/external) |
| Value Performance   | H755                             |
| Premium Performance | H965 (internal/external)         |

**NOTE:** For more information on the features of the Dell PowerEdge RAID controllers (PERC), Software RAID controllers, or BOSS card, and on deploying the cards, see the storage controller documentation at [www.dell.com/storagecontrollermanuals](http://www.dell.com/storagecontrollermanuals).

**NOTE:** From December 2021, H355 replaces H345 as the entry raid controller. H345 is deprecated in January 2022.

## Supported Drives

The table shown below lists the internal drives supported by the R860.

**Table 7. Supported Drives**

| Form Factor | Type    | Speed | Rotational Speed | Capacities  |
|-------------|---------|-------|------------------|---|
| 2.5 inches  | vSAS    | 12 Gb | SSD              | 1.92 TB, 3.84 TB, 960 GB, 7.62 TB   |
| 2.5 inches  | SAS     | 24 Gb | SSD              | 1.92 TB, 1.6 TB, 800 GB, 3.84 TB, 960 GB, 7.68 TB                           |
| 2.5 inches  | SATA    | 6 Gb  | SSD              | 1.92 TB, 480 GB, 960 GB, 3.84 TB  |
| 2.5 inches  | NVMe    | Gen4  | SSD              | 1.6 TB, 3.2 TB, 6.4 TB, 1.92 TB, 3.84 TB, 15.63 TB, 7.68 TB, 800 GB, 400 GB |
| 2.5 inches  | DC NVMe | Gen4  | SSD              | 3.84 TB, 960 GB   |
| 2.5 inches  | SAS     | 12 Gb | 10 K             | 600 GB, 1.2 TB, 2.4 TB  |

**Table 7. Supported Drives (continued)**

| Form Factor | Type | Speed | Rotational Speed | Capacities       |
|-------------|------|-------|------------------|------------------|
| EDSFF E3.S  | NVMe | Gen5  | SSD              | 3.84 TB, 7.68 TB |

## Internal storage configuration

R860 available internal storage configurations:

- 8 x 2.5-inch (SAS/SATA)
- 16 x 2.5-inch (SAS4/SATA)
- 16 x 2.5-inch (SAS4/SATA) + 8 x 2.5-inch NVMe
- 24 x 2.5-inch (SAS4/SATA)
- 24 x 2.5-inch (SAS4/SATA) + 2 x 2.5-inch (NVMe)
- 24 x 2.5-inch (SAS4/SATA) + 2 x 2.5-inch (SAS/SATA)
- 24 x 2.5-inch (SAS4/SATA) - Dual Controller
- 24 x 2.5-inch + 2 x 2.5-inch (SAS4/SATA) - Dual Controller
- 24 x 2.5-inch + 2 x 2.5-inch (SAS/SATA) - Dual Controller
- 24 x 2.5-inch (NVMe) passive
- 16 x 2.5-inch (NVMe RAID)
- 8 x EDSFF E3.S (NVMe) Gen5

## External Storage

The R860 support the external storage device types listed in the table below.

**Table 8. Support External Storage Devices**

| Device Type                | Description                                       |
|----------------------------|---|
| External Tape              | Supports connection to external USB tape products |
| NAS/IDM appliance software | Supports NAS software stack                       |
| JBOD                       | Supports connection to 12 Gb MD-series JBODs      |



# Networking

## Topics:

- [Overview](#)
- [OCP 3.0 support](#)

## Overview

PowerEdge offers a wide variety of options to get information moving to and from our servers. Industry best technologies are chosen, and systems management features are added by our partners to firmware to tie in with iDRAC. These adapters are rigorously validated for worry-free, fully supported use in Dell servers.

## OCP 3.0 support

**Table 9. OCP 3.0 feature list**

| Feature           | OCP 3.0                 |
|-------------------|-------------------------|
| Form factor       | SFF                     |
| PCIe Gen          | Gen4                    |
| Max PCIe width    | x16                     |
| Max no.of ports   | 4                       |
| Port type         | BT/SPF/SFP+/SFP28/SFP56 |
| Max port speed    | 25 GbE                  |
| NC-SI             | Yes                     |
| SNAPI             | Yes                     |
| WoL               | Yes                     |
| Power consumption | 15 W ~ 150 W            |

## Supported OCP cards

**Table 10. Supported OCP cards**

| Form factor | Vendor   | Port type | Port speed | Port count |
|-------------|----------|-----------|------------|------------|
| OCP 3.0     | Broadcom | SFP28     | 25 GbE     | 4          |
|             | Broadcom | SFP28     | 25 GbE     | 2          |
|             | Intel    | SFP28     | 25 GbE     | 4          |
|             | Intel    | SFP28     | 25 GbE     | 2          |
|             | Broadcom | BT        | 10 GbE     | 4          |
|             | Broadcom | SFP+      | 10 GbE     | 2          |

**Table 10. Supported OCP cards (continued)**

| Form factor | Vendor   | Port type | Port speed | Port count |
|-------------|----------|-----------|------------|------------|
|             | Broadcom | BT        | 1 GbE      | 4          |
|             | Intel    | SFP       | 1 GbE      | 4          |

## OCP NIC 3.0 vs. rack Network Daughter Card comparisons

**Table 11. OCP 3.0, 2.0, and rNDC NIC comparison**

| Form Factor    | Dell rNDC | OCP 2.0 (LOM Mezz) | OCP 3.0  | Notes                                      |
|----------------|-----------|--------------------|----------|--|
| PCIe Gen       | Gen 3     | Gen 3              | Gen 4    | Supported OCP3 are SFF (small form factor) |
| Max PCIe Lanes | x8        | Up to x16          | Up to x8 | See server slot priority matrix            |
| Shared LOM     | Yes       | Yes                | Yes      | This is iDRAC port redirect                |
| Aux Power      | Yes       | Yes                | Yes      | Used for Shared LOM                        |

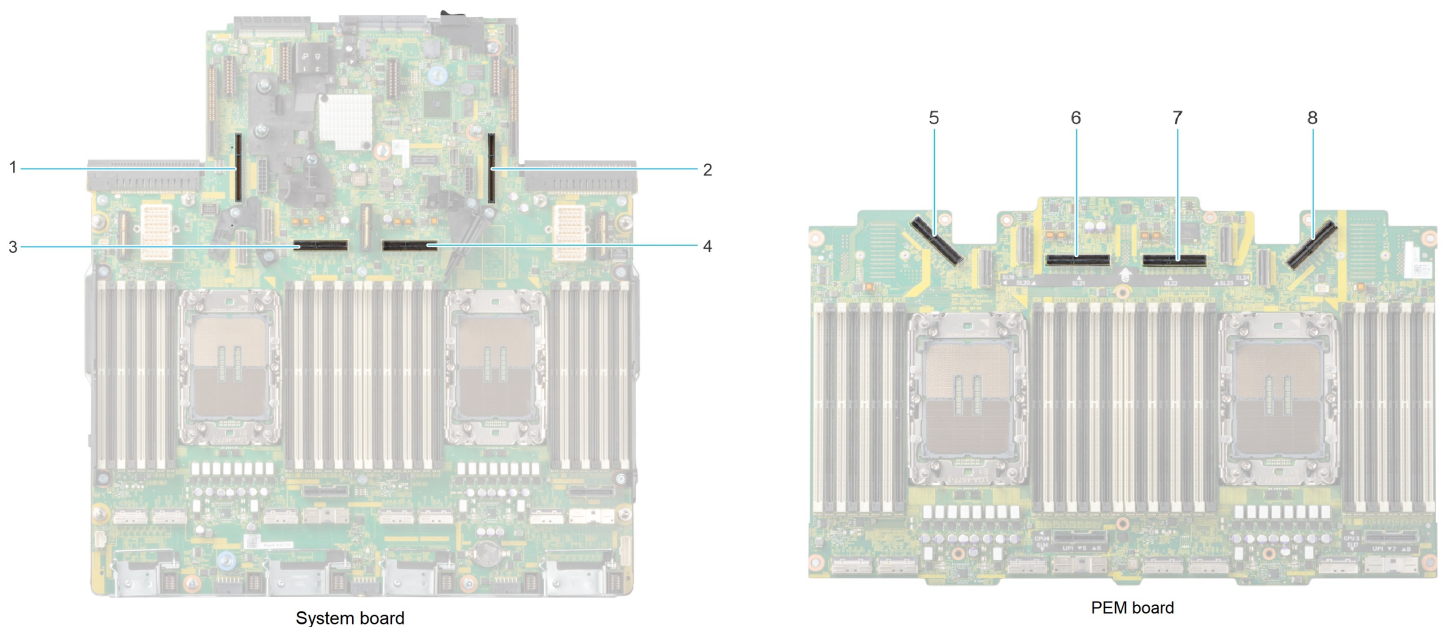
# PCIe subsystem

## Topics:

- PCIe risers

## PCIe risers

Shown below are the riser offerings for the platform.



**Figure 12. Riser connector location on system board and PEM board**

- |                       |                       |
|-----------------------|-----------------------|
| 1. Riser 4 slot       | 2. Riser 1 slot       |
| 3. Riser 2 cable slot | 4. Riser 2 cable slot |
| 5. Riser 4 cable slot | 6. Riser 3 cable slot |
| 7. Riser 3 cable slot | 8. Riser 1 cable slot |

**NOTE:** A riser can be connected to the riser slot or riser cable slot or both depending on the type of riser used.

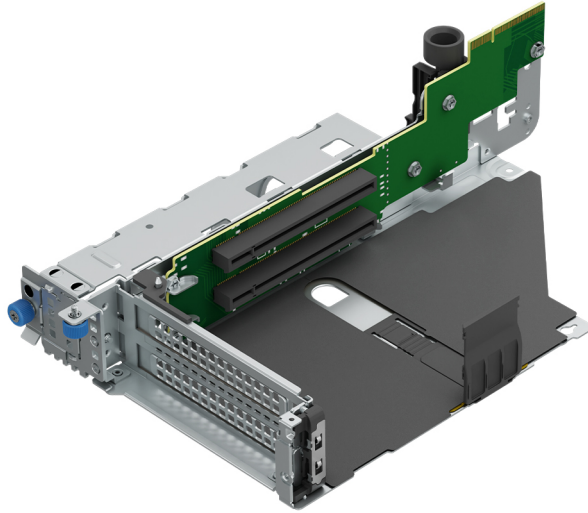


Figure 13. Riser 1B

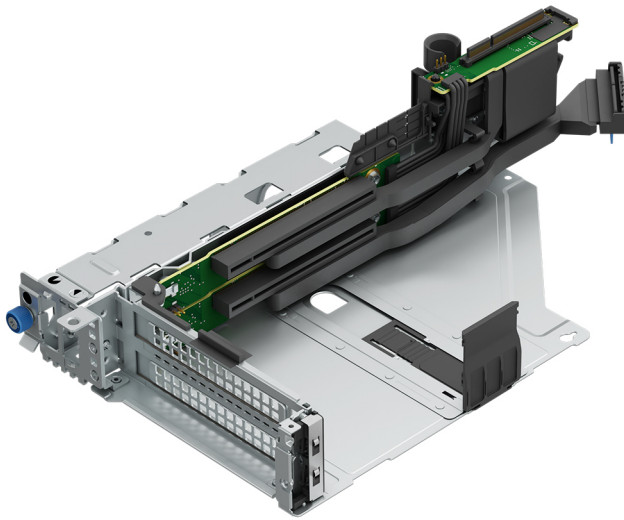


Figure 14. Riser 1C

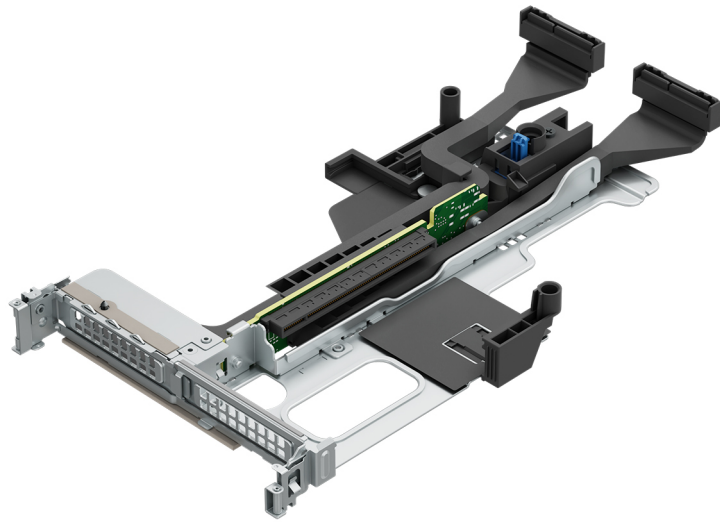


Figure 15. Riser 2

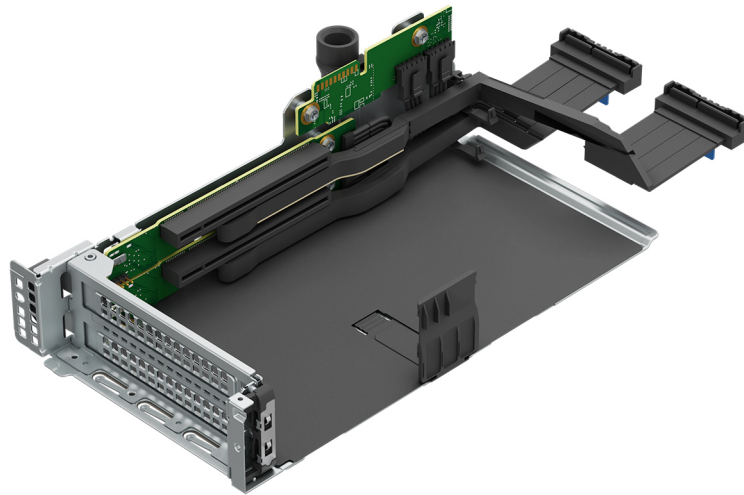


Figure 16. Riser 3

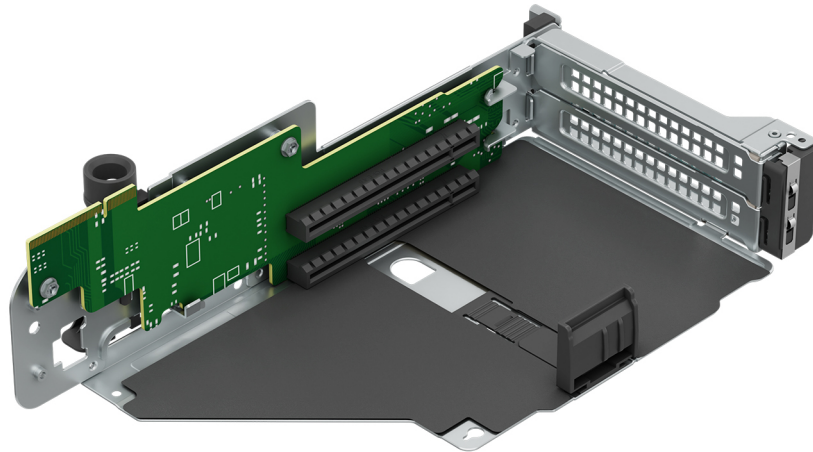


Figure 17. Riser 4B

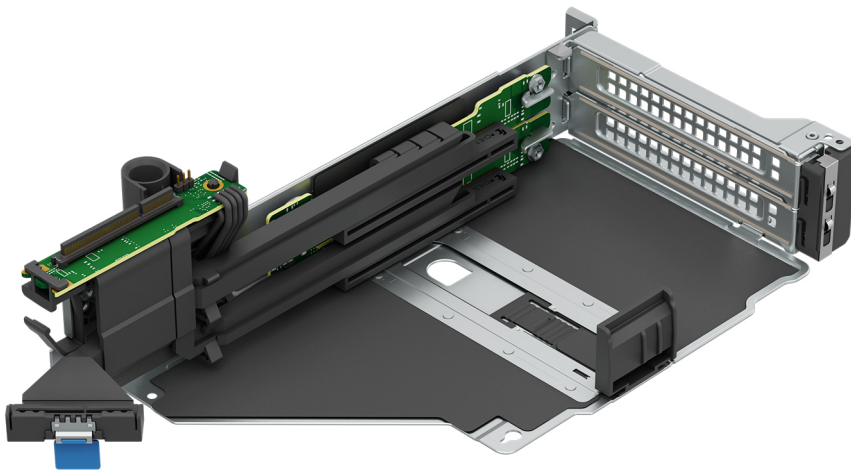


Figure 18. Riser 4C

Table 12. PCIe Riser Configs

| Config No. | RSR Configuration | # of CPUs | PERC type supported       | Rear Storage Possible |
|------------|-------------------|-----------|---------------------------|-----------------------|
| 0          | R1B+R4B           | 2 or 4    | Front PERC / PERC Adaptor | No                    |
| 1          | R1C+R4C           | 4         | Front PERC / PERC Adaptor | No                    |
| 2          | R1C+R2+R3+R4C     | 4         | Front PERC / PERC Adaptor | No                    |
| 3          | R1C+R2+R4C        | 4         | Front PERC / PERC Adaptor | Yes                   |

**Table 13. Riser Config 0: R1B+R4B**

| Processor     |                    |       |        |        | CPU1    | CPU2    |
|---------------|--------------------|-------|--------|--------|---------|---------|
| Configuration | PCIe slot location | Width | Length | Height | R1B     | R4B     |
| 0: R1B+R4B    | PCIe Slot-1        | SW    | HL     | FH     | Gen4 x8 | -       |
|               | PCIe Slot-2        | SW    | HL     | FH     | Gen4 x8 | -       |
|               | PCIe Slot-7        | SW    | HL     | FH     | -       | Gen4 x8 |
|               | PCIe Slot-8        | SW    | HL     | FH     | -       | Gen4 x8 |

**Table 14. Riser Config 1: R1C+R4C**

| Processor     |                    |       |        |        | CPU1     | CPU3     | CPU2     | CPU4     |
|---------------|--------------------|-------|--------|--------|----------|----------|----------|----------|
| Configuration | PCIe slot location | Width | Length | Height | R1C      |          | R4C      |          |
| 1: R1C+R4C    | PCIe Slot-1        | SW    | HL     | FH     | -        | Gen5 x16 | -        | -        |
|               | PCIe Slot-2        | SW    | HL     | FH     | Gen5 x16 | -        | -        | -        |
|               | PCIe Slot-7        | SW    | HL     | FH     | -        | -        | Gen5 x16 | -        |
|               | PCIe Slot-8        | SW    | HL     | FH     | -        | -        | -        | Gen5 x16 |

**Table 15. Riser Config 2: R1C+R2+R3+R4C**

| Processor        |                    |       |        |        | CPU1     | CPU3     | CPU1     | CPU2     | CPU3     | CPU4     | CPU2     | CPU4     |
|------------------|--------------------|-------|--------|--------|----------|----------|----------|----------|----------|----------|----------|----------|
| Configuration    | PCIe slot location | Width | Length | Height | R1C      |          | R2       |          | R3       |          | R4c      |          |
| 2: R1C+R2+R3+R4C | PCIe Slot-1        | SW    | HL     | FH     | -        | Gen5 x16 | -        | -        | -        | -        | -        | -        |
|                  | PCIe Slot-2        | SW    | HL     | FH     | Gen5 x16 | -        | -        | -        | -        | -        | -        | -        |
|                  | PCIe Slot-3        | SW    | HL     | LP     | -        | -        | -        | Gen5 x16 | -        | -        | -        | -        |
|                  | PCIe Slot-4        | SW    | HL     | FH     | -        | -        | -        | -        | -        | Gen5 x16 | -        | -        |
|                  | PCIe Slot-5        | SW    | HL     | FH     | -        | -        | -        | -        | Gen5 x16 | -        | -        | -        |
|                  | PCIe Slot-6        | SW    | HL     | LP     | -        | -        | Gen5 x16 | -        | -        | -        | -        | -        |
|                  | PCIe Slot-7        | SW    | HL     | FH     | -        | -        | -        | -        | -        | -        | Gen5 x16 | -        |
|                  | PCIe Slot-8        | SW    | HL     | FH     | -        | -        | -        | -        | -        | -        | -        | Gen5 x16 |

**Table 16. Riser Config 3: R1C+R2+R4C**

| Processor     |                    |       |        |        | CPU1 | CPU3     | CPU1 | CPU2 | CPU2 | CPU4 |
|---------------|--------------------|-------|--------|--------|------|----------|------|------|------|------|
| Configuration | PCIe slot location | Width | Length | Height | R1C  |          | R2   |      | R4C  |      |
| 3: R1C+R2+R4C | PCIe Slot-1        | SW    | HL     | FH     | -    | Gen5 x16 | -    | -    | -    | -    |

**Table 16. Riser Config 3: R1C+R2+R4C (continued)**

| Processor          |                          |       |        |        | CPU1     | CPU3 | CPU1     | CPU2     | CPU2     | CPU4     |
|--------------------|--------------------------|-------|--------|--------|----------|------|----------|----------|----------|----------|
| Configu-<br>ration | PCIe<br>slot<br>location | Width | Length | Height | R1C      |      | R2       |          | R4C      |          |
|                    | PCIe<br>Slot-2           | SW    | HL     | FH     | Gen5 x16 | -    | -        | -        | -        | -        |
|                    | PCIe<br>Slot-3           | SW    | HL     | LP     | -        | -    | Gen5 x16 | -        | -        | -        |
|                    | PCIe<br>Slot-6           | SW    | HL     | LP     | -        | -    | -        | Gen5 x16 | -        | -        |
|                    | PCIe<br>Slot-7           | SW    | HL     | FH     | -        | -    | -        | -        | Gen5 x16 | -        |
|                    | PCIe<br>Slot-8           | SW    | HL     | FH     | -        | -    | -        | -        | -        | Gen5 x16 |



## Power, thermal, and acoustics

PowerEdge servers have an extensive collection of sensors that automatically track thermal activity, which helps regulate temperature thereby reducing server noise and power consumption. The table below lists the tools and technologies Dell offers to lower power consumption and increase energy efficiency.

### Topics:

- [Power](#)
- [Thermal](#)
- [Acoustics](#)

## Power

**Table 17. Power tools and technologies**

| Feature                           | Description   |
|-----------------------------------|---|
| Power Supply Units(PSU) portfolio | Dell's PSU portfolio includes intelligent features such as dynamically optimizing efficiency while maintaining availability and redundancy. Find additional information in the Power supply units section.  |
| Tools for right sizing            | Enterprise Infrastructure Planning Tool (EIPT) is a tool that can help you determine the most efficient configuration possible. With Dell's EIPT, you can calculate the power consumption of your hardware, power infrastructure, and storage at a given workload. Learn more at <a href="http://www.dell.com/calc">www.dell.com/calc</a> .   |
| Industry Compliance               | Dell's servers are compliant with all relevant industry certifications and guide lines, including 80 PLUS, Climate Savers and ENERGY STAR.  |
| Power monitoring accuracy         | PSU power monitoring improvements include: <ul style="list-style-type: none"> <li>• Dell's power monitoring accuracy is currently 1%, whereas the industry standard is 5%</li> <li>• More accurate reporting of power</li> <li>• Better performance under a power cap</li> </ul>  |
| Power capping                     | Use Dell's systems management to set the power cap limit for your systems to limit the output of a PSU and reduce system power consumption. Dell is the first hardware vendor to leverage Intel Node Manager for circuit-breaker fast capping.  |
| Systems Management                | iDRAC Enterprise and Datacenter provides server-level management that monitors, reports and controls power consumption at the processor, memory and system level.<br><br>Dell OpenManage Power Center delivers group power management at the rack, row, and data center level for servers, power distribution units, and uninterruptible power supplies.  |
| Active power management           | Intel Node Manager is an embedded technology that provides individual server-level power reporting and power limiting functionality. Dell offers a complete power management solution comprised of Intel Node Manager accessed through Dell iDRAC9 Datacenter and OpenManage Power Center that allows policy-based management of power and thermal at the individual server, rack, and data center level. Hot spare reduces power consumption of redundant power supplies. Thermal control off a speed optimizes the thermal settings for your environment to reduce fan consumption and lower system power consumption.<br><br>Idle power enables Dell servers to run as efficiently when idle as when at full workload. |
| Fresh Air cooling                 | Refer to ASHRAE A3/A4 Thermal Restriction.  |

**Table 17. Power tools and technologies (continued)**

| Feature             | Description  |
|---------------------|--|
| Rack infrastructure | <p>Dell offers some of the industry's highest-efficiency power infrastructure solutions, including:</p> <ul style="list-style-type: none"> <li>• <a href="#">Power distribution units (PDUs)</a></li> <li>• <a href="#">Uninterruptible power supplies (UPSs)</a></li> <li>• <a href="#">Energy Smart containment rack enclosures</a></li> </ul> <p>Find additional information at: <a href="https://www.delltechnologies.com/en-us/servers/power-and-cooling.htm">https://www.delltechnologies.com/en-us/servers/power-and-cooling.htm</a>.</p> |

## Power Supply Units

Energy Smart power supplies have intelligent features, such as the ability to dynamically optimize efficiency while maintaining availability and redundancy. Also featured are enhanced power-consumption reduction technologies, such as high-efficiency power conversion and advanced thermal-management techniques, and embedded power-management features, including high-accuracy power monitoring. The table below shows the power supply unit options that are available for the R860.

**Table 18. Power Supply Unit Options**

| Wattage           | Frequency | Voltage/Current        | Class    | Heat dissipation |
|-------------------|-----------|------------------------|----------|------------------|
| 1100 W mixed mode | 50/60 Hz  | 100–240 Vac/12—3.6 A   | Titanium | 4100 BTU/hr      |
|                   | N/A       | 240 Vdc/5.2 A          | N/A      | 4100 BTU/hr      |
| 1400 W mixed mode | 50/60 Hz  | 100–240 Vac/12—8 A     | Platinum | 5250 BTU/hr      |
|                   | N/A       | 240 Vdc/6.6 A          | N/A      | 5250 BTU/hr      |
| 1800 W mixed mode | 50/60 Hz  | 200–240 Vac/10 A       | Titanium | 6750 BTU/hr      |
|                   | N/A       | 240 Vdc/8.2 A          | N/A      | 6750 BTU/hr      |
| 2400 W mixed mode | 50/60 Hz  | 100–240 Vac/ 16—13.5 A | Platinum | 9000 BTU/hr      |
|                   | N/A       | 240 Vdc/11.2 A         | N/A      | 9000 BTU/hr      |
| 2800 W mixed mode | 50/60 Hz  | 200–240 Vac/15.6 A     | Titanium | 10,500 BTU/hr    |
|                   | N/A       | 240 Vdc/13.6 A         | N/A      | 10,500 BTU/hr    |

**NOTE:** If a system with AC 2400 W PSUs operates at low line 100-120 Vac, and then the power rating per PSU is degraded to 1400 W.

**NOTE:** If a system with AC 1400 W or 1100 W PSUs operates at low line 100-120 Vac, and then the power rating per PSU is degraded to 1050 W.



**Figure 19. PSU power cords**

**Table 19. PSU power cords**

| Form factor     | Output    | Power cord |
|-----------------|-----------|------------|
| Redundant 60 mm | 1100 W AC | C13        |
|                 | 1400 W AC | C13        |
|                 | 1800 W AC | C15        |

**Table 19. PSU power cords (continued)**

| Form factor     | Output    | Power cord |
|-----------------|-----------|------------|
| Redundant 86 mm | 2400 W AC | C19        |
|                 | 2800 W AC | C21        |

**NOTE:** C19 power cord combined with C20 to C21 jumper power cord can be used to adapt 2800 W PSU.

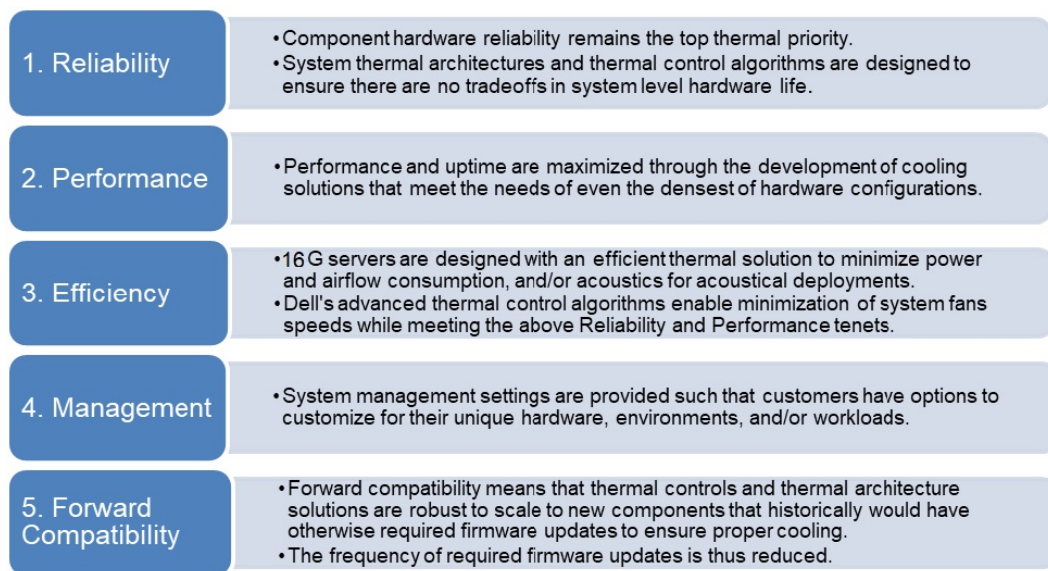
**NOTE:** C13 power cord combined with C14 to C15 jumper power cord can be used to adapt 1800 W PSU.

## Thermal

PowerEdge servers have an extensive collection of sensors that automatically track thermal activity, which helps regulate temperature thereby reducing server noise and power consumption.

### Thermal design

Thermal management of the platform helps deliver high performance with the right amount of cooling to components, while maintaining the lowest fan speeds possible. This is done across a wide range of ambient temperatures from 10°C to 35°C (50°F to 95°F) and to extended ambient temperature ranges.



**Figure 20. Thermal design characteristics**

The thermal design of the PowerEdge R860 reflects the following:

- Optimized thermal design: The system layout is architected for optimum thermal design.
- System component placement and layout are designed to provide maximum airflow coverage to critical components with minimum expense of fan power.
- Comprehensive thermal management: The thermal control system regulates the fan speed based on several different responses from all system-component temperature sensors, as well as inventory for system configurations. Temperature monitoring includes components such as processors, DIMMs, chipset, the inlet air ambient, hard disk drives, and OCP.
- Open and closed loop thermal fan speed control: Open loop thermal control uses system configuration to determine fan speed based on inlet air ambient temperature. Closed loop thermal control method uses feedback temperatures to dynamically determine proper fan speeds.
- User-configurable settings: With the understanding and realization that every customer has unique set of circumstances or expectations from the system, in this generation of servers, we have introduced limited user-configurable settings residing in the iDRAC BIOS setup screen. For more information, see the Dell PowerEdge R860 Installation and Service Manual at

[www.dell.com/poweredgemanuals](http://www.dell.com/poweredgemanuals) and “Advanced Thermal Control: Optimizing across Environments and Power Goals” on Dell.com.

- Cooling redundancy: The R860 allows N+1 fan redundancy, allowing continuous operation with one fan failure in the system.
- Environmental Specifications: The optimized thermal management makes the R860 reliable under a wide range of operating environments.

## Acoustics

### Acoustical performance

Dell PowerEdge R860 is a rack-mount server appropriate for an office to that of data center environment. Although the R860 is designed for use in data centers, some users may prefer to use it in a quieter setting. However in most cases, the idle air mover speed of the system cannot be lowered without changing the configuration of the system, and in some cases, even a configuration change may not reduce idle air mover speeds.

**Table 20. Acoustical Configurations of R860**

| Configuration   | Quietest             | HCI                  | Data Management      | Machine Learning     |
|-----------------|----------------------|----------------------|----------------------|----------------------|
| CPU TDP         | 195 W                | 250 W                | 250 W                | 350 W                |
| CPU Quantity    | 4                    | 4                    | 4                    | 4                    |
| RDIMM Memory    | 16 GB DDR5           | 64 GB DDR5           | 64 GB DDR5           | 64 GB DDR5           |
| Memory Quantity | 4                    | 24                   | 48                   | 64                   |
| Backplane Type  | 2.5-inch x 24 BP     | 2.5-inch x 24 BP     | 2.5-inch x 8 BP      | 2.5-inch x 24 BP     |
| HDD Type        | SATA 2.5-inch 600 GB | SATA 2.5-inch 600 GB | SATA 2.5-inch 1.2 TB | SATA 2.5-inch 1.8 TB |
| HDD Quantity    | 24                   | 24                   | 24                   | 24                   |
| M.2 Drives      | NVMe 480 GB          | NVMe 480 GB          | NVMe 480 GB          | NVMe 480 GB          |
| M.2 Quantity    | 1                    | 1                    | 1                    | 1                    |
| PSU Type        | 2400 W               | 2800 W               | 2400 W               | 2800 W               |
| PSU Quantity    | 2                    | 2                    | 2                    | 2                    |
| OCP             | X                    | OCP3 10 GB 2-port    | OCP3 10 GB 2-port    | OCP3 10 GB 2-port    |
| PCI 1           | X                    | X                    | X                    | X                    |
| PCI 2           | X                    | X                    | X                    | X                    |
| PCI 3           | X                    | X                    | X                    | X                    |
| PCI 4           | X                    | X                    | X                    | X                    |
| PCI 5           | X                    | X                    | X                    | X                    |
| PCI 6           | X                    | X                    | X                    | X                    |
| PCI 7           | X                    | X                    | X                    | X                    |
| PCI 8           | X                    | X                    | X                    | X                    |
| PCI 9           | X                    | X                    | X                    | X                    |
| PERC            | Front HBA355i        | Front HBA355i        | Front HBA355i        | Front HBA355i        |

**Table 21. Acoustical experience of R860 configurations**

| Configuration  |  | Quietest                 | HCI | Data Management | Machine Learning           |
|--|--|--------------------------|-----|-----------------|----------------------------|
| Acoustical Performance: Idle/ Operating @ 25°C Ambient |  |                          |     |                 |                            |
| L <sub>wA,m</sub> (B)                                  | Idle <sup>(4)</sup>                                  | 5.4                      | 5.7 | 5.6             | 5.8                        |
|  | Operating/Customer usage operating <sup>(5)(6)</sup> | 5.8                      | 7.0 | 6.6             | 7.1                        |
| K <sub>v</sub> (B)                                     | Idle <sup>(4)</sup>                                  | 0.4                      | 0.4 | 0.4             | 0.4                        |
|  | Operating/Customer usage operating <sup>(5)(6)</sup> | 0.4                      | 0.4 | 0.4             | 0.4                        |
| L <sub>pA,m</sub> (dB)                                 | Idle <sup>(4)</sup>                                  | 38                       | 42  | 40              | 43                         |
|  | Operating/Customer usage operating <sup>(5)(6)</sup> | 45                       | 55  | 50              | 54                         |
| Prominent discrete tones <sup>(3)</sup>                |  | Prominence ratio < 15 dB |     |                 |                            |
| Acoustical Performance: Idle @ 28°C Ambient            |  |                          |     |                 |                            |
| L <sub>wA,m</sub> <sup>(1)</sup> (B)                   |  | 5.7                      | 6.2 | 6.3             | 6.2                        |
| K <sub>v</sub> (B)                                     |  | 0.4                      | 0.4 | 0.4             | 0.4                        |
| L <sub>pA,m</sub> <sup>(2)</sup> (dB)                  |  | 41                       | 46  | 46              | 45                         |
| Acoustical Performance: Max. loading @ 35°C Ambient    |  |                          |     |                 | Mx. Loading @ 30°C Ambient |
| L <sub>wA,m</sub> <sup>(1)</sup> (B)                   |  | 7.6                      | 8.7 | 8.6             | 8.7                        |
| K <sub>v</sub> (B)                                     |  | 0.4                      | 0.4 | 0.4             | 0.4                        |
| L <sub>pA,m</sub> <sup>(2)</sup> (dB)                  |  | 61                       | 71  | 69              | 71                         |

<sup>(1)</sup>L<sub>wA,m</sub>: The declared mean A-weighted sound power level (L<sub>wA</sub>) is calculated per section 5.2 of ISO 9296 (2017) with data collected using the methods that are described in ISO 7779 (2010). Engineering data presented here may not be fully compliant with ISO 7779 declaration requirement.

<sup>(2)</sup>L<sub>pA,m</sub>: The declared mean A-weighted emission sound pressure level is at the bystander position per section 5.3 of ISO 9296 (2017) and measured using methods that are described in ISO 7779 (2010). The system is placed in a 24U rack enclosure, 75 cm above a reflective floor. Engineering data presented here may not be fully compliant with ISO 7779 declaration requirement.

<sup>(3)</sup>Prominent tones: Criteria of Annex D of ECMA-74 and Prominence Ratio method of ECMA-418 are followed to determine if discrete tones are prominent and to report them, if so.

<sup>(4)</sup>Idle mode: The steady-state condition in which the server is energized but not operating any intended function.

<sup>(5)</sup>Operating mode: The maximum of the steady state acoustical output at 50% of CPU TDP or active storage drives for the respective sections of Annex C of ECMA-74.

<sup>(6)</sup> Customer Usage Operating mode: The operating mode is represented by the maximum of the steady state acoustical output at 10 - 50% of CPU TDP, 40% of Memory, and 10% IOPs load as the components showed in the above configurations.

## PowerEdge acoustical specifications

Dell typically categorizes servers in five categories of acoustically acceptable usage:

- Category 1: Table-top in Office Environment
- Category 2: Floor-standing in Office Environment
- Category 3: General Use Space
- Category 4: Attended Data Center
- Category 5: Unattended Data Center

## Category 1: Table-top in Office Environment

When Dell determines that a specific Enterprise product is to be used primarily on top of the table, then the acoustical specification in the table below applies. Noise from the product should not annoy or otherwise interfere with the user's thoughts or speech, for example, on the telephone.

**Table 22. Dell Enterprise Category 1, "Table-top in Office Environment" acoustical specification category**

| Measurement Position re AC0158   | Metric, re AC0159                        | Test Modes, re AC0159 (note must be in steady state, see AC0159, except where noted below)  |                         |   | Simulate (that is, set fan speeds representative) for Idle at 28° C & 35° C Ambient, and for 100% loading and maximum configuration, at 35° C Ambient |
|--|--|---|-------------------------|---|---|
|  |  | Standby in 23±2° C Ambient  | Idle in 23±2° C Ambient | Operating in 23±2° C Ambient – if not otherwise specified in the program's configuration document, then processor and hard drive operating modes are required |   |
| Sound Power  | LWA,m, B                                 | ≤ 4.2   | ≤ 4.7                   | ≤ 5.0   | Report  |
| Sound Quality (both positions must meet limits): Front Binaural HEAD and Rear Microphone | Tones, Hz, dB                            | No prominent tones per criteria D.10.6 and D.10.8 of ECMA-74  |                         |   | Report tones  |
|  | Tonality, tu                             | ≤ 0.35  | ≤ 0.35                  | ≤ 0.35  | Report  |
|  | Dell Modulation, %                       | ≤ 35  | ≤ 35                    | ≤ 35  | Report  |
|  | Loudness, sones                          | Report  | Report                  | Report  | Report  |
|  | LpA-single point, dBA                    | Report  | Report                  | Report  | Report  |
| Front Binaural HEAD  | Transients                               | <ul style="list-style-type: none"> <li>Oscillation (see AC0159), if observed, during 20-minute steady-state observation, must adhere to the following two criteria: <ul style="list-style-type: none"> <li>Max. {ΔLpA} &lt; 3.0 dB</li> <li>Event count &lt; 3 for "1.5 dB &lt; ΔLpA &lt; 3.0 dB"</li> <li>Acoustical Jump (see AC0159), during air mover speed transition from Idle to Operating Mode must be ≤ 15dB.</li> </ul> </li> <li>Startup behavior <ul style="list-style-type: none"> <li>Report Startup behavior re. AC0159</li> <li>Startup must proceed smoothly, i.e., no sudden or large jumps, and fan speed during startup must not exceed 50% of its maximum</li> </ul> </li> <li>Transient inputs: Report time-history sound pressure levels re AC0159 "Train of Step Functions on Processor"</li> </ul> |                         |   | N/A   |
| Any  | Other                                    | <ul style="list-style-type: none"> <li>No rattles, squeaks, or unexpected noises.</li> <li>Sound should be "even" around the EUT (one side should not be dramatically louder than another).</li> <li>Unless otherwise specified, the "default" thermal-related settings shall be selected for BIOS and iDRAC.</li> <li>Specific operating conditions are defined in "Configurations and Configuration Dependencies" for each platform.</li> </ul>   |                         |   |   |
| Sound Pressure   | LpA-reported, dBA, re AC0158 and program | Report for all mics   | Report for all mics     | Report for all mics   | Report for all mics   |

**Table 22. Dell Enterprise Category 1, "Table-top in Office Environment" acoustical specification category (continued)**

| Measurement Position re AC0158 | Metric, re AC0159      | Test Modes, re AC0159 (note must be in steady state, see AC0159, except where noted below) |                         |   | Simulate (that is, set fan speeds representative) for Idle at 28° C & 35° C Ambient, and for 100% loading and maximum configuration, at 35° C Ambient |
|--------------------------------|------------------------|--|-------------------------|---|---|
|                                |                        | Standby in 23±2° C Ambient   | Idle in 23±2° C Ambient | Operating in 23±2° C Ambient – if not otherwise specified in the program’s configuration document, then processor and hard drive operating modes are required |   |
|                                | configuration document |  |                         |   |   |

**Category 2: Floor-standing in Office Environment**

When Dell determines that a specific Enterprise product is to be used primarily when it is sitting on the floor, that is, next to a user’s feet, then the acoustical specification in the table below applies. Noise from the product should not annoy or otherwise interfere with the user’s thoughts or speech, for example, on the telephone.

**Table 23. Dell Enterprise Category 2, “Floor-standing in Office Environment” acoustical specification category**

| Measurement Position re AC0158   | Metric, re AC0159     | Test Modes, re AC0159 (note must be in steady state, see AC0159, except where noted below)   |                         |   |   |
|--|-----------------------|--|-------------------------|---|---|
|  |                       | Standby in 23±2° C Ambient   | Idle in 23±2° C Ambient | Operating in 23±2° C Ambient – if not otherwise specified in the program’s configuration document, then processor and hard drive operating modes are required | Simulate (that is, set fan speeds representative) for Idle at 28° C & 35° C Ambient, and for 100% loading and maximum configuration, at 35° C Ambient |
| Sound Power  | LWA,m, B              | ≤ 4.9  | ≤ 5.1                   | ≤ 5.4   | Report  |
| Sound Quality (both positions must meet limits): Front Binaural HEAD and Rear Microphone | Tones, Hz, dB         | No prominent tones per criteria D.10.6 and D.10.8 of ECMA-74   |                         |   | Report tones  |
|  | Tonality, tu          | ≤ 0.35   | ≤ 0.35                  | ≤ 0.35  | Report  |
|  | Dell Modulation, %    | ≤ 35   | ≤ 35                    | ≤ 35  | Report  |
|  | Loudness, sones       | Report   | Report                  | Report  | Report  |
|  | LpA-single point, dBA | Report   | Report                  | Report  | Report  |
| Front Binaural HEAD  | Transients            | <ul style="list-style-type: none"> <li>● Oscillation (see AC0159), if observed, during 20-minute steady-state observation, must adhere to the following two criteria:                             <ul style="list-style-type: none"> <li>○ Max. {ΔLpA} &lt; 3.0 dB</li> <li>○ Event count &lt; 3 for “1.5 dB &lt; ΔLpA &lt; 3.0 dB”</li> </ul> </li> </ul> |                         |   | N/A   |

**Table 23. Dell Enterprise Category 2, “Floor-standing in Office Environment” acoustical specification category (continued)**

| Measurement Position re AC0158 | Metric, re AC0159   | Test Modes, re AC0159 (note must be in steady state, see AC0159, except where noted below)  |                         |   |   |
|--------------------------------|---|---|-------------------------|---|---|
|                                |   | Standby in 23±2° C Ambient  | Idle in 23±2° C Ambient | Operating in 23±2° C Ambient – if not otherwise specified in the program’s configuration document, then processor and hard drive operating modes are required | Simulate (that is, set fan speeds representative) for Idle at 28° C & 35° C Ambient, and for 100% loading and maximum configuration, at 35° C Ambient |
|                                |   | <ul style="list-style-type: none"> <li>Acoustical Jump (see AC0159), during air mover speed transition from Idle to Operating Mode must be ≤ 15 dB.</li> <li>Startup behavior                             <ul style="list-style-type: none"> <li>Report Startup behavior re. AC0159</li> <li>Startup must proceed smoothly, that is, no sudden or large jumps, and fan speed during startup must not exceed 50% of its maximum</li> </ul> </li> <li>Transient inputs: Report time-history sound pressure levels re AC0159 “Train of Step Functions on Processor”</li> </ul> |                         |   |   |
| Any                            | Other   | <ul style="list-style-type: none"> <li>No rattles, squeaks, or unexpected noises.</li> <li>Sound should be “even” around the EUT (one side should not be dramatically louder than another).</li> <li>Unless otherwise specified, the “default” thermal-related settings shall be selected for BIOS and iDRAC.</li> <li>Specific operating conditions are defined in “Configurations and Configuration Dependencies” for each platform.</li> </ul>   |                         |   |   |
| Sound Pressure                 | LpA-reported, dBA, re AC0158 and program configuration document | Report for all mics   | Report for all mics     | Report for all mics   | Report for all mics   |

### Category 3: General Use Space

When Dell determines that a specific Enterprise product is to be predominantly used in a general use space, then the acoustical specification in the table below applies. These products could be found in laboratories, schools, restaurants, open office space layouts, small ventilated closets, etc., though not in close proximity to any particular person nor in quantities greater than a few in any location. People within proximity of a few of these products should not experience any impact to speech intelligibility or annoyance from the noise of the product. A rack product sitting on a table in a common area is an example.



**Table 24. Dell Enterprise Category 3, “General Use Space” acoustical specification category**

| Measurement Position re AC0158   | Metric, re AC0159   | Test Modes, re AC0159 (note must be in steady state, see AC0159, except where noted below)  |                         |   | Simulate (i.e., set fan speeds representative) for Idle at 28 & 35° C Ambient, and for 100% loading and maximum configuration, at 35° C Ambient |
|--|---|---|-------------------------|---|---|
|  |   | Standby in 23±2° C Ambient  | Idle in 23±2° C Ambient | Operating in 23±2° C Ambient – if not otherwise specified in the program’s configuration document, then processor and hard drive operating modes are required |   |
| Sound Power  | LWA,m, B  | ≤ 5.2   | ≤ 5.5                   | ≤ 5.8   | Report  |
| Sound Quality (both positions must meet limits): Front Binaural HEAD and Rear Microphone | Tones, Hz, dB   | No prominent tones per criteria D.10.6 and D.10.8 of ECMA-74  |                         |   | Report tones  |
|  | Tonality, tu  | ≤ 0.35  | ≤ 0.35                  | ≤ 0.35  | Report  |
|  | Dell Modulation, %  | ≤ 35  | ≤ 35                    | ≤ 35  | Report  |
|  | Loudness, sones   | Report  | Report                  | Report  | Report  |
|  | LpA-single point, dBA   | Report  | Report                  | Report  | Report  |
| Front Binaural HEAD  | Transients  | <ul style="list-style-type: none"> <li>● Oscillation (see AC0159), if observed, during 20-minute steady-state observation, must adhere to the following two criteria: <ul style="list-style-type: none"> <li>○ Max. {ΔLpA} &lt; 3.0 dB</li> <li>○ Event count &lt; 3 for “1.5 dB &lt; ΔLpA &lt; 3.0 dB”</li> <li>○ Acoustical Jump (see AC0159), during air mover speed transition from Idle to Operating Mode must be ≤ 15dB.</li> </ul> </li> <li>● Startup behavior <ul style="list-style-type: none"> <li>○ Report Startup behavior re. AC0159</li> <li>○ Startup must proceed smoothly, i.e., no sudden or large jumps, and fan speed during startup must not exceed 50% of its maximum</li> </ul> </li> <li>● ∞ Transient inputs: Report time-history sound pressure levels re AC0159 “Train of Step Functions on Processor”</li> </ul> |                         |   | N/A   |
| Any  | Other   | <ul style="list-style-type: none"> <li>● No rattles, squeaks, or unexpected noises.</li> <li>● Sound should be “even” around the EUT (one side should not be dramatically louder than another).</li> <li>● Unless otherwise specified, the “default” thermal-related settings shall be selected for BIOS and iDRAC.</li> <li>● Specific operating conditions are defined in “Configurations and Configuration Dependencies” for each platform.</li> </ul>   |                         |   |   |
| Sound Pressure   | LpA-reported, dBA, re AC0158 and program configuration document | Report for all mics   | Report for all mics     | Report for all mics   | Report for all mics   |

## Category 4: Attended Data Center

When Dell determines that a specific Enterprise product is to be predominantly used in an attended data center, then the acoustical specification of the table applies. The phrase “attended data center” is used to mean a space in which many (from tens to 1000s) of Enterprise products are deployed in proximity (that is, in the same room) to personnel whose speech (perhaps with raised voices) is expected to be intelligible over the data center noise. Hearing protection or hearing monitoring programs are not expected in these areas. Examples in this category include monolithic rack products. When Dell determines that a specific Enterprise product is to be predominantly used in a general use space, then the acoustical specification of the above table applies. These products could be found in laboratories, schools, restaurants, open office space layouts, small ventilated closets, etc., though not in close proximity to any particular person nor in quantities greater than a few in any location. People within proximity of a few of these products should not experience any impact to speech intelligibility or annoyance from the noise of the product. A rack product sitting on a table in a common area is an example.

**Table 25. Dell Enterprise Category 4, “Attended Data Center” acoustical specification category**

| Measurement Position re AC0158 | Metric, re AC0159     | Test Modes, re AC0159 (note must be in steady state, see AC0159, except where noted below)  |                         |   |   | Simulate (that is, set fan speeds representative) for 100% loading and maximum configuration, at 35° C Ambient |
|--------------------------------|-----------------------|---|-------------------------|---|---|--|
|                                |                       | Standby in 23±2° C Ambient  | Idle in 23±2° C Ambient | Operating in 23±2° C Ambient – if not otherwise specified in the program’s configuration document, then processor and hard drive operating modes are required | Simulate (that is, set fan speeds representative) for Idle at 28° C & 35° C Ambient |  |
| Sound Power                    | LWA,m, B              | Report  | ≤ 6.9                   | ≤ 7.1   | Report  | ≤ 8.5  |
| Front Binaural HEAD            | Tones, Hz, dB         | Report  | < 15 dB                 | < 15 dB   | Report  | < 20 dB  |
|                                | Tonality, tu          | Report  | Report                  | Report  | Report  | Report   |
|                                | Dell Modulation, %    | Report  | Report                  | Report  | Report  | Report   |
|                                | Loudness, sones       | Report  | Report                  | Report  | Report  | Report   |
|                                | LpA-single point, dBA | Report  | Report                  | Report  | Report  | Report   |
|                                | Transients            | <ul style="list-style-type: none"> <li>● Oscillation (see AC0159), if observed, during 20-minute steady-state observation, must adhere to the following two criteria: <ul style="list-style-type: none"> <li>○ Max. {ΔLpA} &lt; 3.0 dB</li> <li>○ Event count &lt; 3 for “1.5 dB &lt; ΔLpA &lt; 3.0 dB”</li> <li>○ Acoustical Jump (see AC0159), during air mover speed transition from Idle to Operating Mode must be ≤ 15 dB.</li> <li>○ Startup behavior <ul style="list-style-type: none"> <li>■ Report Startup behavior re. AC0159</li> <li>■ Startup must proceed smoothly, that is, no sudden or large jumps, and fan speed during startup must not exceed 50% of its maximum</li> </ul> </li> </ul> </li> <li>● ∞ Transient inputs: Report time-history sound pressure levels re AC0159 “Train of Step Functions on Processor”</li> </ul> | N/A                     |   |   |  |
| Any                            | Other                 | <ul style="list-style-type: none"> <li>● No rattles, squeaks, or unexpected noises.</li> <li>● Sound should be “even” around the EUT (one side should not be dramatically louder than another).</li> </ul>  |                         |   |   |  |

**Table 25. Dell Enterprise Category 4, “Attended Data Center” acoustical specification category (continued)**

| Measurement Position re AC0158 | Metric, re AC0159 | Test Modes, re AC0159 (note must be in steady state, see AC0159, except where noted below)  |                         |   |   | Simulate (that is, set fan speeds representative) for 100% loading and maximum configuration, at 35° C Ambient |
|--------------------------------|-------------------|---|-------------------------|---|---|--|
|                                |                   | Standby in 23±2° C Ambient  | Idle in 23±2° C Ambient | Operating in 23±2° C Ambient – if not otherwise specified in the program’s configuration document, then processor and hard drive operating modes are required | Simulate (that is, set fan speeds representative) for Idle at 28° C & 35° C Ambient |  |
|                                |                   | <ul style="list-style-type: none"> <li>Unless otherwise specified, the “default” thermal-related settings shall be selected for BIOS and iDRAC.</li> <li>Specific operating conditions are defined in “Configurations and Configuration Dependencies” for each platform.</li> </ul> |                         |   |   |  |
| Sound Pressure                 | LpA-reported, dBA | Report for all mics   | Report for all mics     | Report for all mics   | Report for all mics   | Report for all mics  |

### Category 5: Unattended Data Center

When Dell determines that a specific Enterprise product is to be predominantly used in an unattended data center (and not blades or blade enclosures; these have their own category), then the acoustical specification in the table below applies. The phrase “unattended data center” is used to mean a space in which many (from tens to 1000s) of Enterprise products are deployed together, its own heating and cooling systems condition the space, and operators or servicers of equipment enter generally only to deploy, service, or decommission equipment. Hearing protection or hearing monitoring programs may be expected (per government or company guidelines) in these areas. Examples in this category include monolithic rack products.

**Table 26. Dell Enterprise Category 5, “Unattended Data Center” acoustical specification category**

| Measurement Position re AC0158 | Metric, re AC0159  | Test Modes, re AC0159 (note must be in steady state, see AC0159, except where noted below) |                         |   |   | Simulate (that is, set air mover speeds representative) for 100% loading and maximum configuration, at 35° C Ambient |
|--------------------------------|--------------------|--|-------------------------|---|---|--|
|                                |                    | Standby in 23±2° C Ambient   | Idle in 23±2° C Ambient | Operating in 23±2° C Ambient – if not otherwise specified in the program’s configuration document, then processor and hard drive operating modes are required | Simulate (that is, set air mover speeds representative) for Idle at 28° C & 35° C Ambient |  |
| Sound Power                    | LWA,m, B           | Report   | ≤ 7.5                   | ≤ 7.7   | Report  | ≤ 8.7  |
| Front Binaural HEAD            | Tones, Hz, dB      | Report   | < 15 dB                 | < 15 dB   | Report  | < 20 dB  |
|                                | Tonality, tu       | Report   | Report                  | Report  | Report  | Report   |
|                                | Dell Modulation, % | Report   | Report                  | Report  | Report  | Report   |
|                                | Loudness, sones    | Report   | Report                  | Report  | Report  | Report   |

**Table 26. Dell Enterprise Category 5, “Unattended Data Center” acoustical specification category (continued)**

| Measurement Position re AC0158 | Metric, re AC0159   | Test Modes, re AC0159 (note must be in steady state, see AC0159, except where noted below)  |                         |   |   | Simulate (that is, set air mover speeds representative) for 100% loading and maximum configuration, at 35° C Ambient |
|--------------------------------|---|---|-------------------------|---|---|--|
|                                |   | Standby in 23±2° C Ambient  | Idle in 23±2° C Ambient | Operating in 23±2° C Ambient – if not otherwise specified in the program’s configuration document, then processor and hard drive operating modes are required | Simulate (that is, set air mover speeds representative) for Idle at 28° C & 35° C Ambient |  |
|                                | LpA-single point, dBA   | Report  | Report                  | Report  | Report  | Report   |
| Front Binaural HEAD            | Transients  | <ul style="list-style-type: none"> <li>• Oscillation (see AC0159), if observed, during 20-minute steady-state observation, must adhere to the following two criteria: <ul style="list-style-type: none"> <li>◦ Max. {ΔLpA} &lt; 3.0 dB</li> <li>◦ Event count &lt; 3 for “1.5 dB &lt; ΔLpA &lt; 3.0 dB”</li> </ul> </li> <li>• Report Acoustical Jump (see AC0159) during air mover speed transition from Idle to Operating Mode.</li> <li>• Startup behavior <ul style="list-style-type: none"> <li>◦ Report Startup behavior re. AC0159</li> <li>◦ Startup must proceed smoothly, that is, no sudden or large jumps, and air mover speed during startup must not exceed 50% of its maximum</li> </ul> </li> <li>• Transient inputs: Report time-history sound pressure levels re AC0159 “Train of Step Functions on Processor”</li> </ul> |                         |   | N/A   |  |
| Any                            | Other   | <ul style="list-style-type: none"> <li>• No rattles, squeaks, or unexpected noises.</li> <li>• Sound should be “even” around the EUT (one side should not be dramatically louder than another).</li> <li>• Unless otherwise specified, the “default” thermal-related settings shall be selected for BIOS and iDRAC.</li> <li>• Specific operating conditions are defined in “Configurations and Configuration Dependencies” for each platform.</li> </ul>   |                         |   |   |  |
| Sound Pressure                 | LpA-reported, dBA, re AC0158 and program configuration document | Report for all mics   | Report for all mics     | Report for all mics   | Report for all mics   | Report for all mics  |

# Rack, rails, and cable management

## Topics:

- [Rails and cable management information](#)

## Rails and cable management information

The rail offerings for the PowerEdge R860 consist of two general types: sliding and static. The cable management offerings consist of an optional cable management arm (CMA) and an optional strain relief bar (SRB).

See the *Dell Enterprise Systems Rail Sizing and Rack Compatibility Matrix* available at [https://i.dell.com/sites/csdocuments/Business\\_solutions\\_engineering-Docs\\_Documents/en/rail-rack-matrix.pdf](https://i.dell.com/sites/csdocuments/Business_solutions_engineering-Docs_Documents/en/rail-rack-matrix.pdf) for information regarding:

- Specific details about rail types.
- Rail adjustability ranges for various rack mounting flange types
- Rail depth with and without cable management accessories
- Rack types that are supported for various rack mounting flange types

Key factors governing proper rail selection include the following:

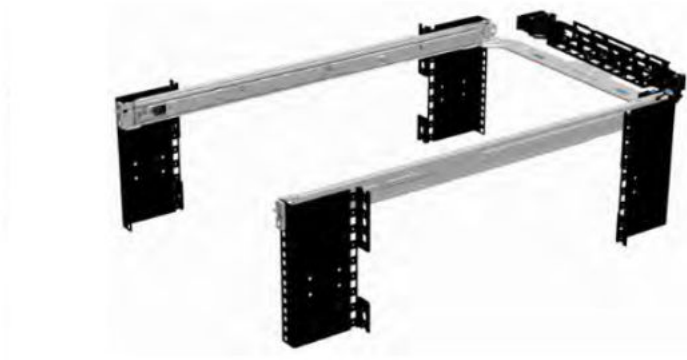
- Spacing between the front and rear mounting flanges of the rack
- Type and location of any equipment that is mounted in the back of the rack such as power distribution units (PDUs)
- Overall depth of the rack

## Sliding rails features summary

The sliding rails allow the system to be fully extended out of the rack for service. There is one type of sliding rail available: Stab-in/Drop-in sliding rails. The sliding rails are available with or without the optional cable management arm (CMA) or strain relief bar (SRB).

### **B24 Stab-in/Drop-in sliding rails for 4-post racks**

- Supports drop-in or stab-in installation of the chassis to the rails.
- Support for tool-less installation in 19" EIA-310-E compliant square, un-threaded round hole racks including all generations of the Dell racks. Also supports tool-less installation in threaded round hole 4-post racks.
- Support for tool-less installation in Dell Titan or Titan-D racks
- Support full extension of the system out of the rack to allow serviceability of key internal components.
- Support for optional cable management arm (CMA).
- Support for optional strain relief bar (SRB).



**Figure 21. Sliding rails with optional CMA**



**Figure 22. Sliding rails with optional SRB**

Scan the QRL code for the documentation and trouble-shooting information regarding the installation procedures for Drop-in/Stab-in rail types.



Figure 23. Quick resource locator for combo rails

## B19 static rails summary

The static rails offer a greater adjustability range and a smaller overall mounting footprint than the sliding rails because of their reduced complexity and lack of need for CMA support. The static rails support a wider variety of racks than the sliding rails. However, they do not support serviceability in the rack and are thus not compatible with the CMA. The static rails are also not compatible with SRB.



Figure 24. Static rails

### Static rails features summary

Static rails for 4-post & 2-post racks:

- Supports stab-in installation of the chassis to the rails.
- Support tool-less installation in 19" EIA-310-E compliant square or un-threaded round hole 4-post racks including all generations of Dell racks.
- Support tool-less installation in 19" EIA-310-E compliant threaded hole 4-post and 2-post racks.
- Support for tool-less installation in Dell Titan or Titan-D rack.

#### **i** NOTE:

- Screws are not included with the static rail kit since racks are offered with various thread types. The screws are provided for mounting static rails in racks with threaded mounting flanges.
- Screw head diameter should be 10 mm or less.

### 2-Post racks installation

If installing to 2-Post (Telco) racks, the ReadyRails static rails (B19) must be used. Sliding rails support mounting in 4-post racks only.



**Figure 25. Static rails in 2-post center mount configuration**

#### **Installation in the Dell Titan or Titan-D racks**

For tool-less installation in Titan or Titan-D racks, the Stab-in/Drop-in Sliding rails (B24) must be used. This rail collapses down sufficiently to fit in the rack with mounting flanges that are spaced about 24 inches apart from front to back. The Stab-in/Drop-in Sliding rail allows bezels of the servers and storage systems to be aligned when installed in these racks. For tool installation, Stab-in Static rails (B19) must be used for bezel alignment with Storage systems.

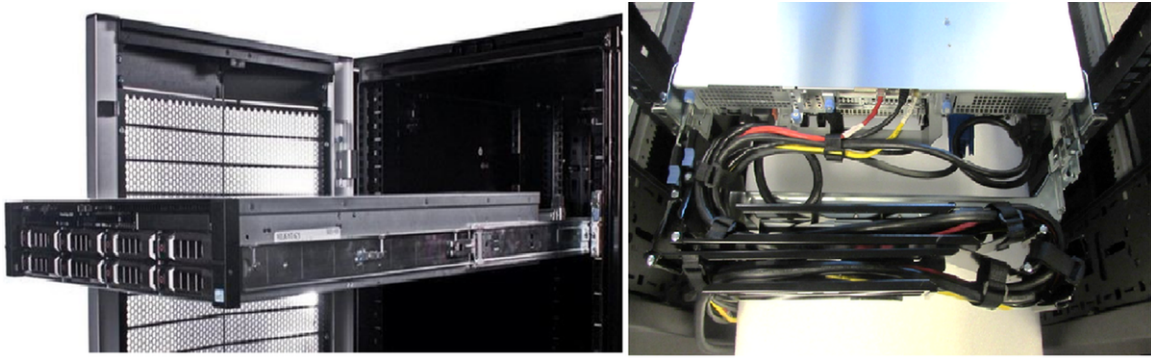
## Cable management arm (CMA)

The optional cable management arm (CMA) organizes and secures the cords and cables exiting the back of the systems. It unfolds to allow the systems to extend out of the rack without having to detach the cables. Some key features of the CMA include:

- Large U-shaped baskets to support dense cable loads.
- Open vent pattern for optimal airflow.
- Ability to mount on either side by swinging the spring-loaded brackets from one side to the other.
- Utilizes hook-and-loop straps rather than plastic tie wraps to eliminate the risk of cable damage during cycling.
- Includes a low-profile fixed tray to both support and retain the CMA in its fully closed position.
- Both the CMA and the tray mount without the use of tools by simple and intuitive snap-in designs.

The CMA can be mounted to either side of the sliding rails without the use of tools or the need for conversion. For systems with one power supply unit (PSU), it is recommended to mount on the side opposite to that of the power supply to allow easier access to it and the rear drives (if applicable) for service or replacement.

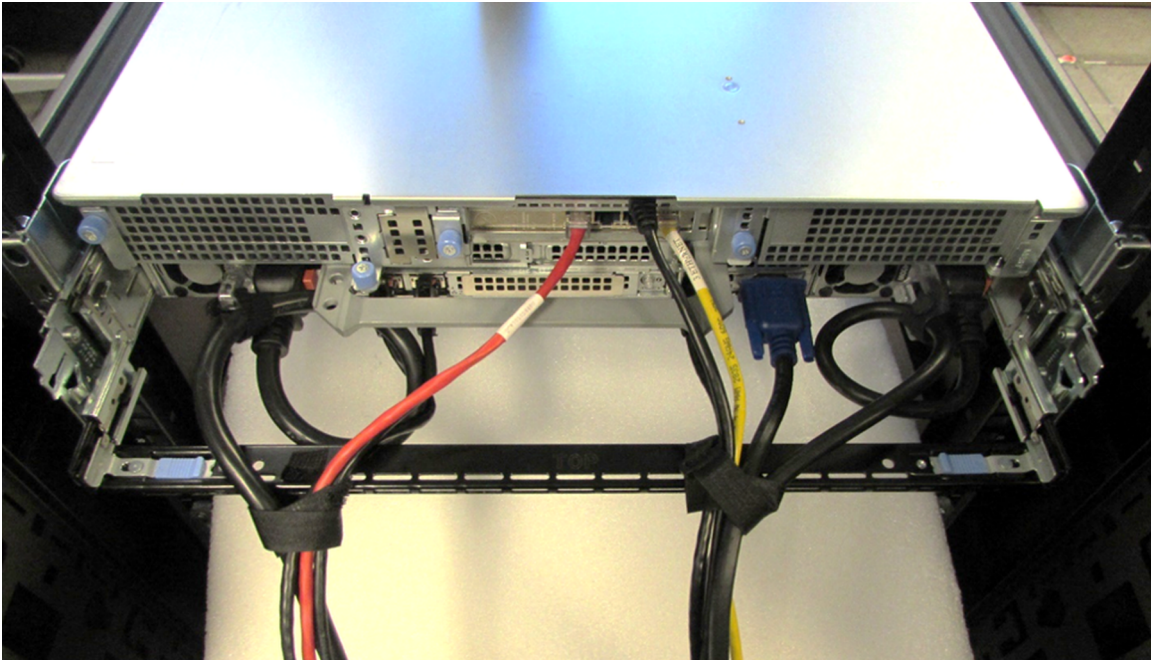




**Figure 26. Sliding rails with CMA cabling**

## Strain Relief Bar (SRB)

The optional strain relief bar (SRB) for the PowerEdge R860 organizes and supports cable connections at the rear end of the server to avoid damage from bending.



**Figure 27. Cabled strain relief bar**

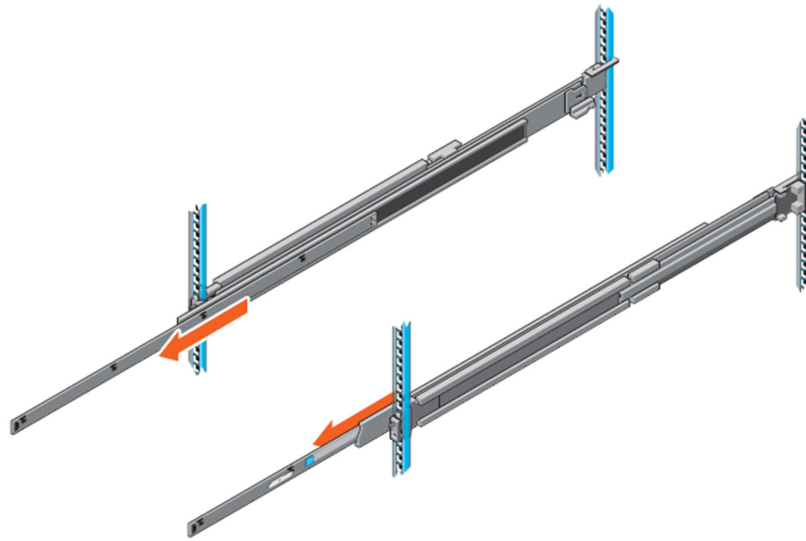
- Tool-less attachment to the rails
- Two depth positions to accommodate various cable loads and rack depths
- Supports cable loads and controls stresses on server connectors
- Cables can be separated into discrete purpose-specific bundles

## Rack Installation

Drop-in design means that the system is installed vertically into the rails by inserting the standoffs on the sides of the system into the J-slots in the inner rail members with the rails in the fully extended position. The recommended method of installation is to first insert the rear standoffs on the system into the rear J-slots on the rails to free up a hand and then rotate the system down into the remaining J-slots while using the free hand to hold the rail against the side of the system.

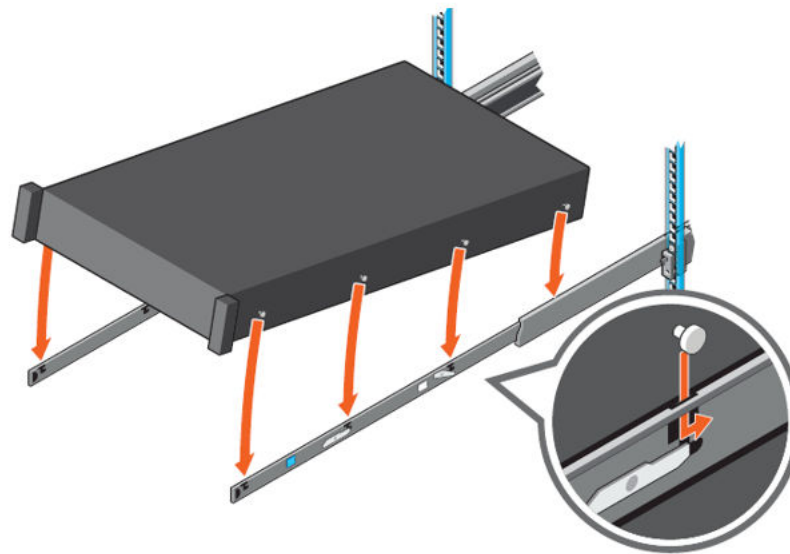
## Installing system into the rack (option A: Drop-In)

1. Pull the inner rails out of the rack until they lock into place.



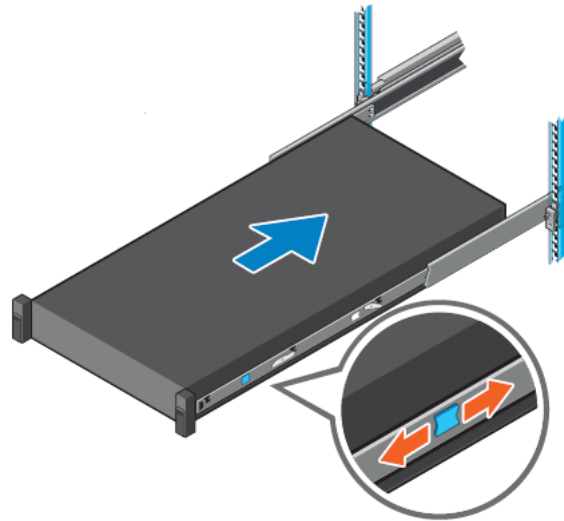
**Figure 28. Pull out inner rail**

2. Locate the rear rail standoff on each side of the system and lower them into the rear J-slots on the slide assemblies.
3. Rotate the system downward until all the rail standoffs are seated in the J-slots.



**Figure 29. Rail standoffs seated in J-slots**

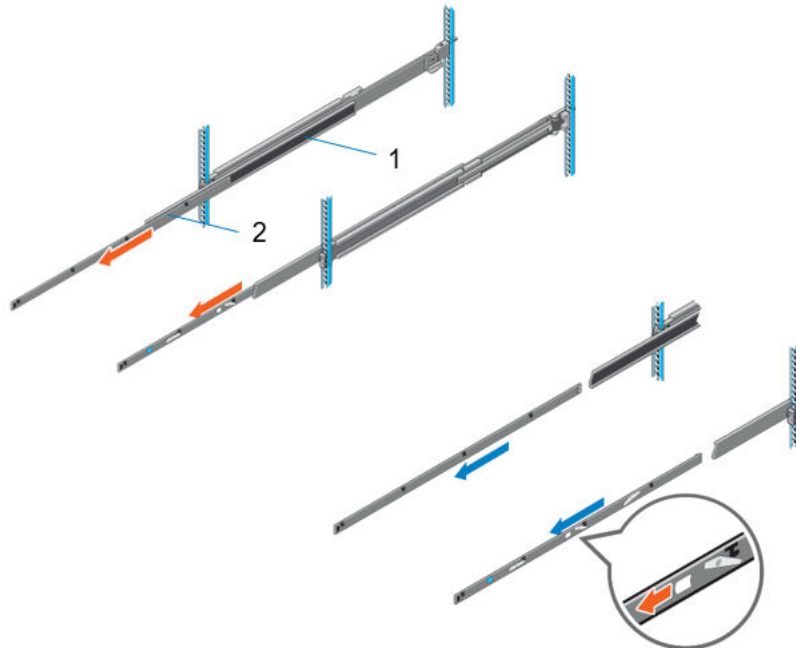
4. Push the system inward until the lock levers click into place.
5. Pull the blue side release lock tabs forward or backward on both rails and slide the system into the rack until the system is in the rack.



**Figure 30. Slide system into the rack**

## Installing the system into the rack (option B: Stab-In)

1. Pull the intermediate rails out of the rack until they lock into place.
2. Release the inner rail lock by pulling forward on the white tabs and sliding the inner rail out of the intermediate rails.

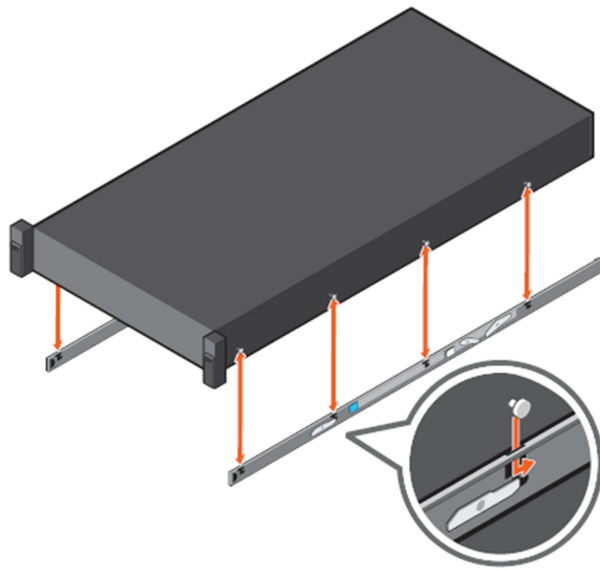


**Figure 31. Pull out the intermediate rail**

**Table 27. Rail component label**

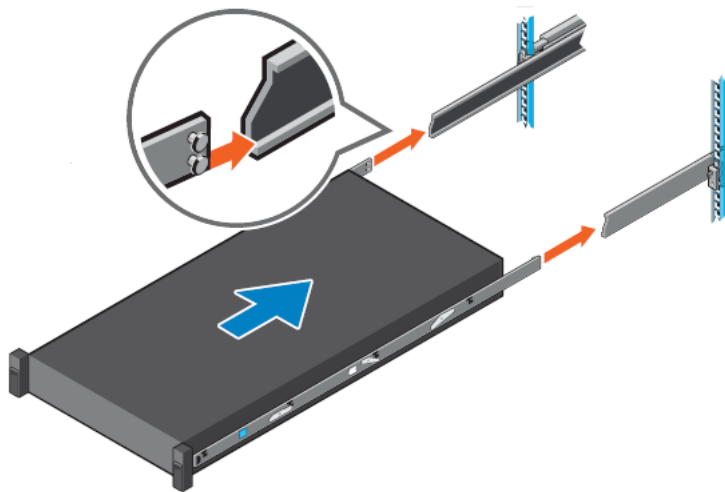
| Number | Component         |
|--------|-------------------|
| 1      | Intermediate rail |
| 2      | Inner rail        |

3. Attach the inner rails to the sides of the system by aligning the J-slots on the rail with the standoffs on the system and sliding forward on the system until they lock into place.



**Figure 32. Attach the inner rails to the system**

4. With the intermediate rails extended, install the system into the extended rails.



**Figure 33. Install system into the extended rails**

5. Pull blue slide release lock tabs forward or backward on both rails, and slide the system into the rack.

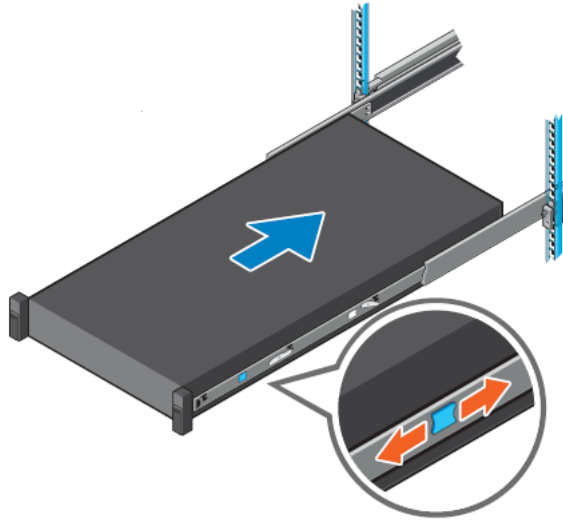


Figure 34. Slide system into the rack

# Operating Systems and Virtualization

## Topics:

- [Supported operating systems](#)

## Supported operating systems

The PowerEdge R860 system supports the following operating systems:

- Canonical Ubuntu Server LTS
- Microsoft Windows Server with Hyper-V
- Red Hat Enterprise Linux
- SUSE Linux Enterprise Server
- VMware ESXi

For more information, go to [www.dell.com/ossupport](http://www.dell.com/ossupport).

# Dell OpenManage Systems Management

Dell delivers management solutions that help IT administrators effectively deploy, update, monitor, and manage IT assets. OpenManage solutions and tools enable you to quickly respond to problems by helping them to manage Dell servers efficiently; in physical, virtual, local, and remote environments; all without the need to install an agent in the operating system.


The OpenManage portfolio includes:

- Innovative embedded management tools - integrated Dell Remote Access Controller (iDRAC)
- Consoles - OpenManage Enterprise
- Extensible with plug-ins - OpenManage Power Manager
- Update tools - Repository Manager

Dell has developed comprehensive systems management solutions that are based on open standards and has integrated with management consoles from partners such as Microsoft and VMware, allowing advanced management of Dell servers. Dell management capabilities extend to offerings from the industry's top systems management vendors and frameworks such as Ansible, Splunk, and ServiceNow. OpenManage tools automate the full span of server life cycle management activities along with powerful RESTful APIs to script or integrate with your choice of frameworks.

For more information about the entire OpenManage portfolio, see:

- The latest [Dell Systems Management Overview Guide](#).

 **NOTE:** OpenManage Software and OpenManage Integration will be available from September 2023.

## Topics:

- [Integrated Dell Remote Access Controller \(iDRAC\)](#)
- [Systems Management software support matrix](#)

## Integrated Dell Remote Access Controller (iDRAC)

iDRAC9 delivers advanced, agent-free, local and remote server administration. Embedded in every PowerEdge server, iDRAC9 provides a secure means to automate a multitude of common management tasks. Because iDRAC is embedded within every PowerEdge server, there is no additional software to install; just plug in power and network cables, and iDRAC is ready to go. Even before installing an operating system (operating system) or hypervisor, IT administrators have a complete set of server management features at their fingertips.

With iDRAC9 in-place across the Dell PowerEdge portfolio, the same IT administration techniques and tools can be applied throughout. This consistent management platform allows easy scaling of PowerEdge servers as an organization's infrastructure grows. Customers can use the iDRAC RESTful API for the latest in scalable administration methods of PowerEdge servers. With this API, iDRAC enables support for the Redfish standard and enhances it with Dell extensions to optimize at-scale management of PowerEdge servers. By having iDRAC at the core, the entire OpenManage portfolio of Systems Management tools allows every customer to tailor an effective, affordable solution for any size environment.

Zero Touch Provisioning (ZTP) is embedded in iDRAC. ZTP - Zero Touch Provisioning is Intelligent Automation Dell's agent-free management puts IT administrators in control. Once a PowerEdge server is connected to power and networking, that system can be monitored and fully managed, whether you're standing in front of the server or remotely over a network. In fact, with no need for software agents, an IT administrator can: • Monitor • Manage • Update • Troubleshoot and remediate Dell servers With features like zero-touch deployment and provisioning, iDRAC Group Manager, and System Lockdown, iDRAC9 is purpose-built to make server administration quick and easy. For those customers whose existing management platform utilizes in-band management, Dell does provide iDRAC Service Module, a lightweight service that can interact with both iDRAC9 and the host operating system to support legacy management platforms.

When ordered with DHCP enabled from the factory, PowerEdge servers can be automatically configured when they are initially powered up and connected to your network. This process uses profile-based configurations that ensure each server is configured per your specifications. This feature requires an iDRAC Enterprise license.

iDRAC9 offers following license tiers:

**Table 28. iDRAC9 license tiers**

| License           | Description  |
|-------------------|--|
| iDRAC9 Basic      | <ul style="list-style-type: none"> <li>Available only on 100-500 series rack/tower</li> <li>Basic instrumentation with iDRAC web UI</li> <li>For cost conscious customers that see limited value in management</li> </ul>  |
| iDRAC9 Express    | <ul style="list-style-type: none"> <li>Default on 600+ series rack/tower, modular, and XR series</li> <li>Includes all features of Basic</li> <li>Expanded remote management and server life-cycle features</li> </ul>   |
| iDRAC9 Enterprise | <ul style="list-style-type: none"> <li>Available as an upsell on all servers</li> <li>Includes all features of Basic and Express. Includes key features such as virtual console, AD/LDAP support, and more</li> <li>Remote presence features with advanced, Enterprise-class, management capabilities</li> </ul>   |
| iDRAC9 Datacenter | <ul style="list-style-type: none"> <li>Available as an upsell on all servers</li> <li>Includes all features of Basic, Express, and Enterprise. Includes key features such as telemetry streaming, Thermal Manage, automated certificate management, and more</li> <li>Extended remote insight into server details, focused on high end server options, granular power, and thermal management</li> </ul> |

For a full list of iDRAC features by license tier, see [Integrated Dell Remote Access Controller 9 User's Guide](#) at [Dell.com](#).

For more details on iDRAC9 including white papers and videos, see:

- [Support for Integrated Dell Remote Access Controller 9 \(iDRAC9\)](#) on the [Knowledge Base](#) page at [Dell.com](#)

## Systems Management software support matrix


**Table 29. Systems Management software support matrix**

| Categories                               | Features   | PE mainstream |
|--|--|---------------|
| Embedded Management and In-band Services | iDRAC9 (Express, Enterprise, and Datacenter licenses)                    | Supported     |
|  | OpenManage Mobile  | Supported     |
|  | OM Server Administrator (OMSA)   | Supported     |
|  | iDRAC Service Module (iSM)   | Supported     |
|  | Driver Pack  | Supported     |
| Change Management                        | Update Tools (Repository Manager, DSU, Catalogs)                         | Supported     |
|  | Server Update Utility  | Supported     |
|  | Lifecycle Controller Driver Pack   | Supported     |
|  | Bootable ISO   | Supported     |
| Console and Plug-ins                     | OpenManage Enterprise  | Supported     |
|  | Power Manager Plug-in  | Supported     |
|  | Update Manager Plug-in   | Supported     |
|  | SupportAssist Plug-in  | Supported     |
|  | CloudIQ  | Supported     |
| Integrations and connections             | OM Integration with VMware Vcenter/vROps                                 | Supported     |
|  | OM Integration with Microsoft System Center (OMIMSC)                     | Supported     |
|  | Integrations with Microsoft System Center and Windows Admin Center (WAC) | Supported     |



**Table 29. Systems Management software support matrix (continued)**

| Categories                | Features  | PE mainstream      |
|---------------------------|---|--------------------|
|                           | ServiceNow  | Supported          |
|                           | Ansible   | Supported          |
|                           | Third-party Connectors (Nagios, Tivoli, Microfocus)                   | Supported          |
| Security                  | Secure Enterprise Key Management                                      | Supported          |
|                           | Secure Component Verification   | Supported          |
| Standard operating system | Red Hat Enterprise Linux, SUSE, Windows Server 2021<br>Ubuntu, CentOS | Supported (Tier-1) |

 **NOTE:** OpenManage Software and OpenManage Integration will be available from September 2023.

# Appendix D: Service and support

## Topics:

- [Default support levels](#)
- [Other services and support information](#)

## Default support levels

This system offers 3 years Dell ProSupport Next Business Day (NBD), including 24x7 phone support and NBD parts and labor support.

## Default deployment levels

This system is defaulted to the ProDeploy Dell Server R860 which includes onsite hardware installation and software configuration. C-series sleds require a deploy service on each sled purchased. Installation of the enclosure is included at no additional charges. Optionally, the customer may choose any of the factory or field deployment offers listed below.

## Other services and support information

Dell Technologies Services include a wide, customizable range of service options to simplify the assessment, design, implementation, management and maintenance of IT environments and to help transition from platform to platform.

Depending on the current business requirements and correct level of service for customers, we provide factory, onsite, remote, modular, and specialized services that fit the customer requirements and budget. We will help with a little or a lot, based on the customer's choice, and provide access to our global resources.

## Dell deployment services

### Dell ProDeploy Infrastructure Suite

ProDeploy Infrastructure Suite provides a variety of deployment offerings that satisfy a customer's unique needs. It is made up of 5 offers: ProDeploy Configuration Services, ProDeploy Rack Integration Services, Basic Deployment, ProDeploy, and ProDeploy Plus.

# ProDeploy Infrastructure Suite for servers

## Versatile choices for accelerated deployments

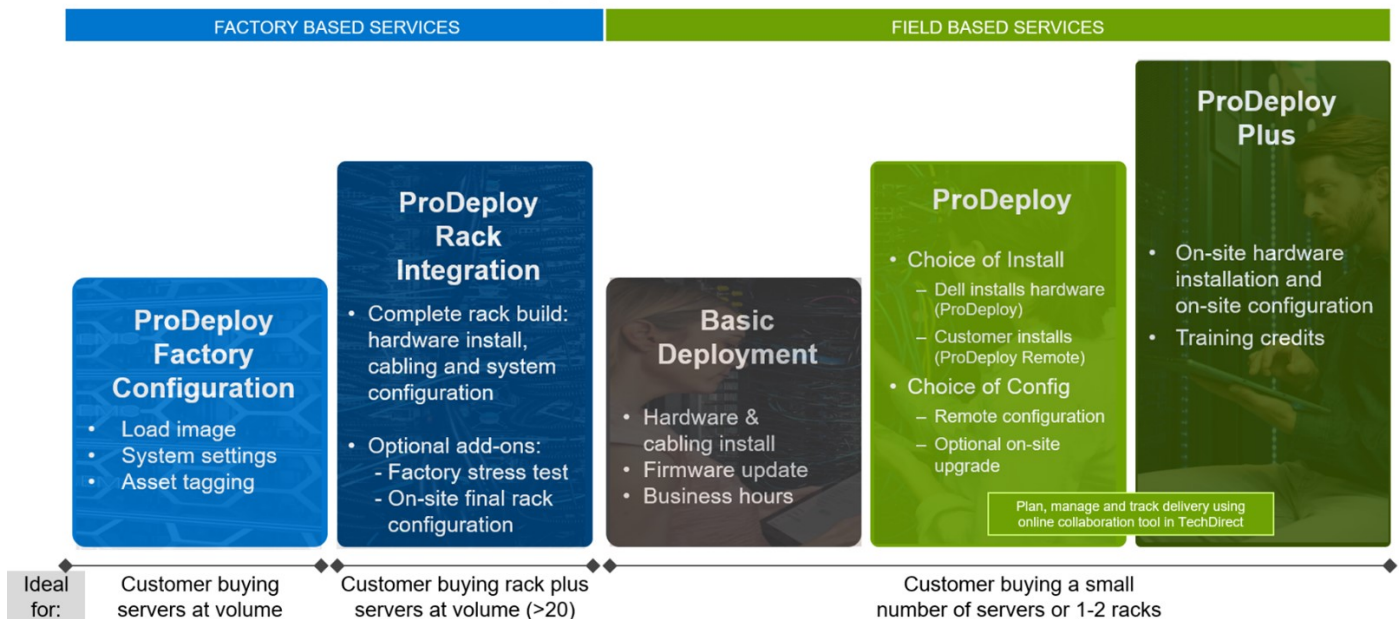


Figure 35. ProDeploy Infrastructure Suite for servers

The new Factory Services consist of two tiers of deployment that happen prior to shipping to the customer's site.

### Factory Based Services:

- ProDeploy Factory Configuration - Ideal for customers buying servers in volume and seeking pre-configuration prior to shipping such as: custom image, system settings, and asset tagging so it arrives ready to use out of the box. Furthermore, servers can be packaged and bundled to meet specific shipping and distribution requirements for each customer location to facilitate the rollout process. Upsell one of the field based services (below) if a customer needs assistance with the final server installation.
- ProDeploy Rack Integration - Ideal for customers seeking to build out fully integrated racks prior to shipping. These rack builds include hardware install, cabling, and full system configuration. You can also add-on a factory stress test and optional on-site final rack configuration to complete the rack installation.
  - STANDARD SKUs for Rack Integration is available in US only and requires:
    - 20 or more devices (R and C series servers and all Dell or non-Dell switches). Use Informational SKUs for Dell switches or 3rd party products
    - Shipping to contiguous US
  - USE CUSTOM QUOTE for Rack Integration for:
    - All countries except USA
    - Racks containing less than 20 servers
    - Any rack that includes VxRail or Storage
    - Shipping outside contiguous US
    - Shipping to multiple locations

### Field Based Services:

- Basic Deployment consists of the hardware installation, cabling and firmware update during normal standard business hours. Basic Deployment is traditionally sold to Competency Enabled Partners. Competency enabled partners often have Dell do the hardware installation while they complete the software configuration.
- ProDeploy consists of your hardware installation and configuration of the software using offshore resources. ProDeploy is great for customers who are price sensitive or who are remote from their data centers and don't require an onsite presence.
- ProDeploy Plus will give you in-region or onsite resources to complete the engagement for the customer. It also comes with additional features such as Post Deployment Configuration Assistance and Training Credits.

# ProDeploy Infrastructure Suite | Factory services

## FACTORY BASED SERVICES

|                        |   | ProDeploy Factory Configuration | ProDeploy Rack Integration |
|------------------------|---|---------------------------------|----------------------------|
| Asset configuration    | Single point of contact for project management                                | ●                               | ●                          |
|                        | RAID, BIOS and iDRAC configuration  | ●                               | ●                          |
|                        | Firmware freeze   | ●                               | ●                          |
|                        | Asset Tagging and Reporting   | ●                               | ●                          |
|                        | Customer system image   | ●                               | ●                          |
| Factory implementation | Site readiness review and implementation planning                             | -                               | ●                          |
|                        | Hardware racking and cabling  | -                               | ●                          |
|                        | SAM engagement for ProSupport Plus entitled accounts/devices                  | -                               | ●                          |
|                        | Deployment verification, documentation, and knowledge transfer                | ●                               | ●                          |
| Delivery               | White glove logistics   | -                               | ●                          |
|                        | Onsite final configuration  | -                               | Onsite add-on              |
|                        | Install support software and connect with Dell Technologies                   | -                               | Onsite add-on              |
|                        | Basic Deployment  | Optional onsite installation    | -                          |
| Online oversight       | Online collaborative environment for planning, managing and tracking delivery | -                               | ●                          |

<sup>1</sup> ProDeploy Rack Integration Services are currently only available within the United States. Custom rack integration services are still available globally.\*

Dell Technologies

Figure 36. ProDeploy Infrastructure Suite - Factory services

# ProDeploy Infrastructure Suite | Field services

|                  |  | Basic Deployment | ProDeploy                 | ProDeploy Plus |
|------------------|--|------------------|---------------------------|----------------|
| Pre-deployment   | Single point of contact for project management   | ●                | ●                         | In-region      |
|                  | Site readiness review  | -                | ●                         | ●              |
|                  | Implementation planning <sup>1</sup>   | -                | ●                         | ●              |
|                  | SAM engagement for ProSupport Plus entitled devices  | -                | -                         | ●              |
| Deployment       | Deployment service hours   | Business hours   | 24x7                      | 24x7           |
|                  | Onsite hardware installation and packaging material removal <sup>2</sup> or remote guidance for hardware installation <sup>1</sup> | ●                | Remote guidance or onsite | Onsite         |
|                  | Install and configure system software  | -                | Remote                    | Onsite         |
|                  | Install support software and connect with Dell Technologies  | -                | ●                         | ●              |
|                  | Project documentation with knowledge transfer  | -                | ●                         | ●              |
| Post-deployment  | Deployment verification  | -                | ●                         | ●              |
|                  | Configuration data transfer to Dell Technologies technical support   | -                | ●                         | ●              |
|                  | 30-days of post-deployment configuration assistance  | -                | -                         | ●              |
|                  | Training credits for Dell Technologies Education Services  | -                | -                         | ●              |
| Online oversight | Online collaborative environment in <a href="#">TechDirect</a> for planning, managing and tracking delivery <sup>3</sup>           | -                | ●                         | ●              |

<sup>1</sup> Remote option includes project specific instructions, documentation and live expert guidance for hardware installation. Option available for select hardware. [List is available in the backup portion of this customer presentation](#)

<sup>2</sup> Packaging removal included with onsite hardware installation

<sup>3</sup> Included with ProDeploy or ProDeploy Plus, Not included with Basic Deployment

Figure 37. ProDeploy Infrastructure Suite - Field services

## Dell ProDeploy Plus for Infrastructure

From beginning to end, ProDeploy Plus provides the skill and scale that is must successfully perform demanding deployments in today's complex IT environments. Certified Dell experts start with extensive environmental assessments and detailed migration

planning and recommendations. Software installation includes set up of our enterprise connectivity solution (secure connect gateway) and OpenManage system management utilities.

Postdeployment configuration assistance, testing, and product orientation services are also available.

## Dell ProDeploy for Infrastructure

ProDeploy provides full-service installation and configuration of both server hardware and system software by certified deployment engineers including set up of leading operating systems and hypervisors as well our enterprise connectivity solution (secure connect gateway) and OpenManage system management utilities. To prepare for the deployment, we conduct a site readiness review and implementation planning exercise. System testing, validation, and full project documentation with knowledge transfer complete the process.

## Dell Basic Deployment

Basic Deployment delivers worry-free professional installation by experienced technicians who know Dell servers inside and out.

## Additional Deployment Services

You can tailor the ProDeploy Infrastructure Suite offer to meet your customer's unique needs by leveraging "Additional Deployment Time." ADT will cover additional tasks above the normal scope of the standard offers. ADT can be sold for Project Management or Technical Resources and is sold as blocks of four hours remote or eight hours on-site.

## Dell ProDeploy for HPC (available in US/Canada only. All other regions use custom)

HPC deployments require specialists that understand that cutting edge is yesterday's news. Dell deploys the world 's fastest systems and understands the nuances that make them perform. ProDeploy for HPC provides:

- Global team of dedicated HPC specialists
- Proven track record, thousands of successful HPC deployments
- Design validation, benchmarking, and product orientation

Learn more at [Dell.com/HPC-Services](https://Dell.com/HPC-Services).

# ProDeploy Expansion for HPC

\*Available as standard SKUs in US & Canada and as custom quote in APJC, EMEA, LATAM

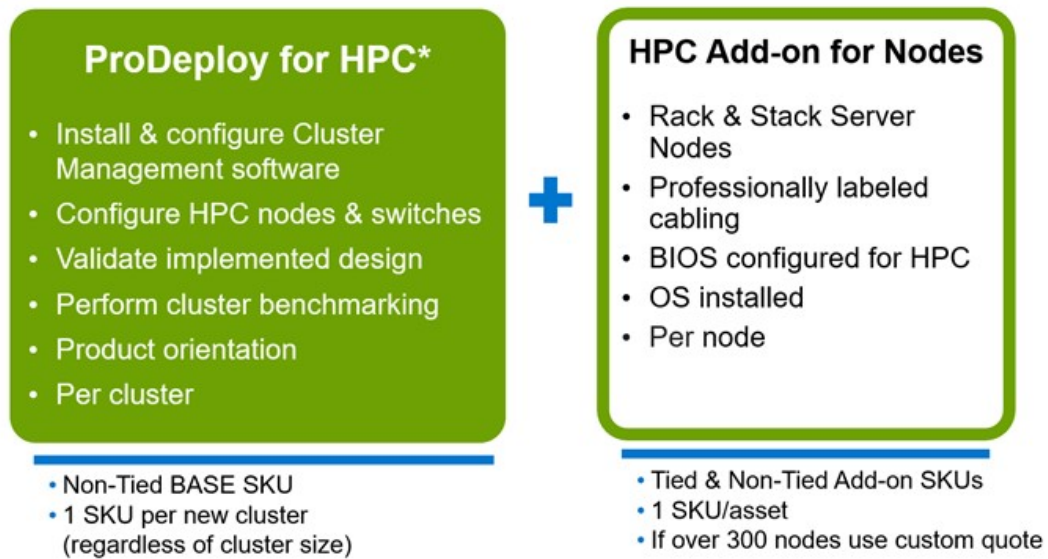


Figure 38. ProDeploy Expansion for HPC

## Dell custom deployment Services

Dell custom rack integration and other Dell configuration services help customers save time by providing systems that are racked, cabled, tested, and ready to be integrated into the data center. Dell support preconfigure RAID, BIOS and iDRAC settings, install system images, and even install third-party hardware and software.

For more information, see [Server Configuration Services](#).

## Dell Residency Services

Residency Services help customers transition to new capabilities quickly with the assistance of onsite or remote Dell experts whose priorities and time they control.

Residency experts can provide post implementation management and knowledge transfer that is related to a new technology acquisition or day-to-day operational management of the IT infrastructure.

## Dell Data Migration Services

Protect business and data of the customer with our single point of contact to manage data migration projects.

A customer project manager works with our experienced team of experts to create a plan using industry-leading tools and proven processes that are based on global best practices to migrate existing files and data, so business systems are up and running quickly and smoothly.



# Dell Enterprise Support Services

## Dell ProSupport Enterprise Suite

With the ProSupport Enterprise Suite, we help keep IT systems running smoothly, so customers can focus on running their business. We help maintain peak performance and availability of the most essential workloads. ProSupport Enterprise Suite is a suite of support services that enable customers to build the solution that is right for their organization. They choose support models that are based on how they use technology and where they want to allocate resources. From the desktop to the data center, address everyday IT challenges, such as unplanned downtime, mission-critical needs, data and asset protection, support planning, resource allocation, software application management and more. Optimize customer IT resources by choosing the right support model.

**Table 30. ProSupport Enterprise Suite**

| Service                     | Support model                  | Description   |
|-----------------------------|--------------------------------|---|
| ProSupport Enterprise Suite | ProSupport Plus for Enterprise | Proactive, predictive, and reactive support for systems that look after your business-critical applications and workloads |
|                             | ProSupport for Enterprise      | Comprehensive 24 x 7 predictive and reactive support for hardware and software  |
|                             | Basic hardware support         | Reactive hardware support during normal business hours  |

## Dell ProSupport Plus for Enterprise


When customers purchase PowerEdge server, we recommend ProSupport Plus, our proactive and preventative support service for business-critical systems. ProSupport Plus provides all the benefits of ProSupport, plus the following:

- An assigned Services Account Manager who knows their business and environment
- Immediate advanced troubleshooting from an engineer
- Personalized, preventive recommendations that are based on analysis of support trends and best practices from across the Dell Technologies infrastructure solutions customer base to reduce support issues and improve performance
- Predictive analysis for issue prevention and optimization that is enabled by secure connect gateway technology
- Proactive monitoring, issue detection, notification, and automated case creation for accelerated issue resolution enabled by secure connect gateway
- On-demand reporting and analytics-based recommendations that are enabled by secure connect gateway and TechDirect

## Dell ProSupport for Enterprise

ProSupport service offers highly trained experts around the clock and around the globe to address IT needs. We help minimize disruptions and maximize availability of PowerEdge server workloads with:

- 24x7 support through phone, chat and online
- Predictive, automated tools and innovative technology
- A central point of accountability for all hardware and software issues
- Collaborative third-party support
- Hypervisor, operating system and application support
- Consistent experience regardless of where customers are located or what language they speak

 **NOTE:** Subject to service offer country or region availability.

- Optional onsite parts and labor response options including next business day or four-hour mission critical

| ProSupport Enterprise Suite<br>Feature Comparison   |                   |  |   |
|---|-------------------|--|---|
|   | Basic             | ProSupport                                   | ProSupport Plus                               |
| Remote technical support  | 9x5               | 24x7   | 24x7  |
| Covered products  | Hardware          | Hardware<br>Software                         | Hardware<br>Software                          |
| Onsite hardware support   | Next business day | Next business day or<br>4hr mission critical | Next business day or<br>4 hr mission critical |
| 3 <sup>rd</sup> party collaborative assistance  |                   | ●  | ●   |
| Self-service case initiation and management   |                   | ●  | ●   |
| Access to software updates  |                   | ●  | ●   |
| Proactive storage health monitoring, predictive analytics and anomaly detection with CloudIQ and the CloudIQ mobile app |                   | ●  | ●   |
| Priority access to specialized support experts  |                   |  | ●   |
| Predictive detection of hardware failures   |                   |  | ●   |
| 3 <sup>rd</sup> party software support  |                   |  | ●   |
| An assigned Service Account Manager   |                   |  | ●   |
| Proactive, personalized assessments and recommendations   |                   |  | ●   |
| Proactive systems maintenance   |                   |  | ●   |

Availability and terms of Dell Technologies Services vary by region and by product. For more information, please view our [service descriptions](#).

Internal Use - Confidential 23 of 117 © Copyright 2022 Dell Inc. **DELL** Technologies

**Figure 39. ProSupport Enterprise Suite**

## Dell ProSupport One for Data Center

ProSupport One for Data Center offers flexible site-wide support for large and distributed data centers with more than 1,000 assets. This offering is built on standard ProSupport components that leverage our global scale but are tailored to a customer's needs. While not for everyone, this service option offers a truly unique solution for Dell Technologies largest customers with the most complex environments.

- Team of assigned Services Account Managers with remote, on-site options
- Assigned ProSupport One technical and field engineers who are trained on the customer's environment and configurations
- On-demand reporting and analytics-based recommendations that are enabled by secure connect gateway and TechDirect
- Flexible on-site support and parts options that fit their operational model
- A tailored support plan and training for their operations staff

## Dell ProSupport Add-on for HPC

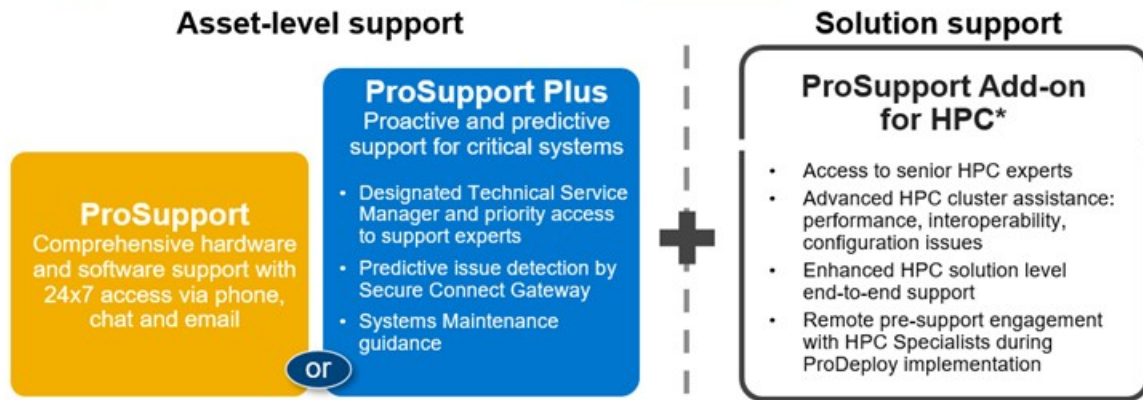
The ProSupport Add-on for HPC provides solution-aware support including:

- Access to senior HPC experts
- Advanced HPC cluster assistance: performance, interoperability, and configuration
- Enhanced HPC solution level end-to-end support
- Remote presupport engagement with HPC Specialists during ProDeploy implementation

Learn more at [Dell.com/HPC-Services](https://Dell.com/HPC-Services).



# ProSupport Add-on for HPC is an add-on to PS or PSP



### Eligibility

- All server, storage, and networking nodes in cluster must have PS or PSP **AND** PS Add-on for HPC attached
- All HW expansions to clusters must attach PS or PSP **AND** PS Add-on for HPC
- To retrofit an entire existing cluster with PS Add-on for HPC:
  1. HPC Specialists must review and validate the existing cluster
  2. PS or PSP **AND** the PS Add-on for HPC (APOS) must be attached to all server, storage and networking nodes

\*Available in standard SKUs in NA and EMEA and as custom quote in APJC & LATAM

DELLTechnologies

Figure 40. ProSupport Add-on for HPC is an add-on to PS or PSP

## Support Technologies

Powering the support experience with predictive, data-driven technologies.

**NOTE:** SupportAssist Enterprise capabilities are now part of the secure connect gateway technology.

## Enterprise connectivity

The best time to solve a problem is before it happens. The automated proactive and predictive support features enabled by the secure connect gateway technology helps reduce steps and time to resolution, often detecting issues before they become a crisis. The gateway technology is available in virtual and application editions. It is also implemented as a direct connect version for select Dell hardware and a Services plugin within OpenManage Enterprise for PowerEdge servers. The legacy SupportAssist Enterprise solution has been retired and is now replaced by the secure connect gateway solutions.

Benefits include:

- Value: Our connectivity solutions are available to all customers at no additional charge
- Improve productivity: Replace manual, high-effort routines with automated support
- Accelerate time to resolution: Receive issue alerts, automatic case creation, and proactive contact from Dell experts
- Gain insight and control: Optimize enterprise devices with insights in portals reporting like TechDirect, and get predictive issue detection before the problem starts

**NOTE:** Connect devices can access these features. Features vary depending on the service level agreement for the connected device. ProSupport Plus customers experience the full set of automated support capabilities.

Table 31. Features enabled by connectivity

|   | Basic hardware warranty | ProSupport | ProSupport Plus |
|---|-------------------------|------------|-----------------|
| Automated issue detection and system state information collection | Supported               | Supported  | Supported       |
| Proactive, automated case creation and notification               | Not supported           | Supported  | Supported       |

**Table 31. Features enabled by connectivity (continued)**

|   | <b>Basic hardware warranty</b> | <b>ProSupport</b> | <b>ProSupport Plus</b> |
|---|--------------------------------|-------------------|------------------------|
| Predictive issue detection for failure prevention | Not supported                  | Not supported     | Supported              |

Get started at [DellTechnologies.com/secureconnectgateway](https://DellTechnologies.com/secureconnectgateway).

## Dell TechDirect

TechDirect helps boost IT team productivity when supporting Dell systems.

Boost your productivity with online service for Dell products from TechDirect. From deployment to technical support, TechDirect lets you do more with less effort and faster resolution. You can:

- Open and manage support requests or in-warranty systems
- Execute online self-service for parts dispatch
- Collaborate on ProDeploy infrastructure deployment projects online
- Manage proactive and predictive alerts from secure connect gateway technology that help maximize uptime
- Integrate services functionality into your help desk with TechDirect APIs
- Join over 10,000 companies that choose TechDirect


Register at [TechDirect.Dell.com](https://TechDirect.Dell.com).

## Dell Technologies Consulting Services

Our expert consultants help customers transform faster, and quickly achieve business outcomes for the high value workloads Dell PowerEdge systems can handle. From strategy to full-scale implementation, Dell Technologies Consulting can help determine how to perform IT, workforce, or application transformation. We use prescriptive approaches and proven methodologies that are combined with portfolio and partner ecosystem of Dell Technologies to help achieve real business outcomes. From multi cloud, applications, DevOps, and infrastructure transformations, to business resiliency, data center modernization, analytics, workforce collaboration, and user experiences-we are here to help.

## Dell Managed Services

Some customers prefer Dell to manage the complexity and risk of daily IT operations, Dell Managed Services utilizes proactive, AI enabled delivery operations and modern automation to help customers realize desired business outcomes from their infrastructure investments. With these technologies, our experts run, update and fine-tune customer environments aligned with service levels, while providing environment-wide and down-to-the-device visibility. There are two types of managed service offers. First the outsourcing model or CAPEX model where Dell manages the customer owned assets using our people and tools. The second is the as-a-Service model or OPEX model called APEX. In this service, Dell owns all technology and all the management of it. Many customers will have a blend of the two management types depending on the goals of the organization.

| <b>Managed</b>  | Outsourcing or CAPEX model  | <b>APEX</b>  | as-a-Service or OPEX model |
|---|---|--|----------------------------|
| <p>We manage your technology using our people and tools.<sup>1</sup></p> <ul style="list-style-type: none"> <li>• Managed detection and response*</li> <li>• Technology Infrastructure</li> <li>• End-user (PC/desktop)</li> <li>• Service desk operations</li> <li>• Cloud Managed (Pub/Private)</li> <li>• Office365 or Microsoft Endpoint</li> </ul> |  | <p>We own all technology so you can off-load all IT decisions.</p> <ul style="list-style-type: none"> <li>• APEX Cloud Services</li> <li>• APEX Flex on Demand elastic capacity</li> <li>• APEX Data Center Utility pay-per-use model</li> </ul> |                            |

1 – Some minimum device counts may apply. Order via: [ClientManagedServices.sales@dell.com](mailto:ClientManagedServices.sales@dell.com)

\* Managed detection and response covers the security monitoring of laptops, servers, & virtual servers. Min. 50 devices combined. No Networking or Storage-only systems [SAN/NAS]. Available in 32 countries. [Details here](#)

**Figure 41. Dell Managed Services**

## Dell Technologies Education Services

Build the IT skills required to influence the transformational outcomes of the business. Enable talent and empower teams with the right skills to lead and perform transformational strategy that drives competitive advantage. Leverage the training and certification required for real transformation.

Dell Technologies Education Services offers PowerEdge server training and certifications that are designed to help customers achieve more from their hardware investment. The curriculum delivers the information and the practical, firsthand skills that their team must confidently install, configure, manage, and troubleshoot Dell servers.

To learn more or register for a class today, see [Education.Dell.com](http://Education.Dell.com).

## Appendix A: Additional specifications

### Topics:

- Chassis dimensions
- Chassis weight
- NIC port specifications
- Video specifications
- USB Ports
- PSU rating
- Environmental specifications

### Chassis dimensions

The R860 has the following dimensions:

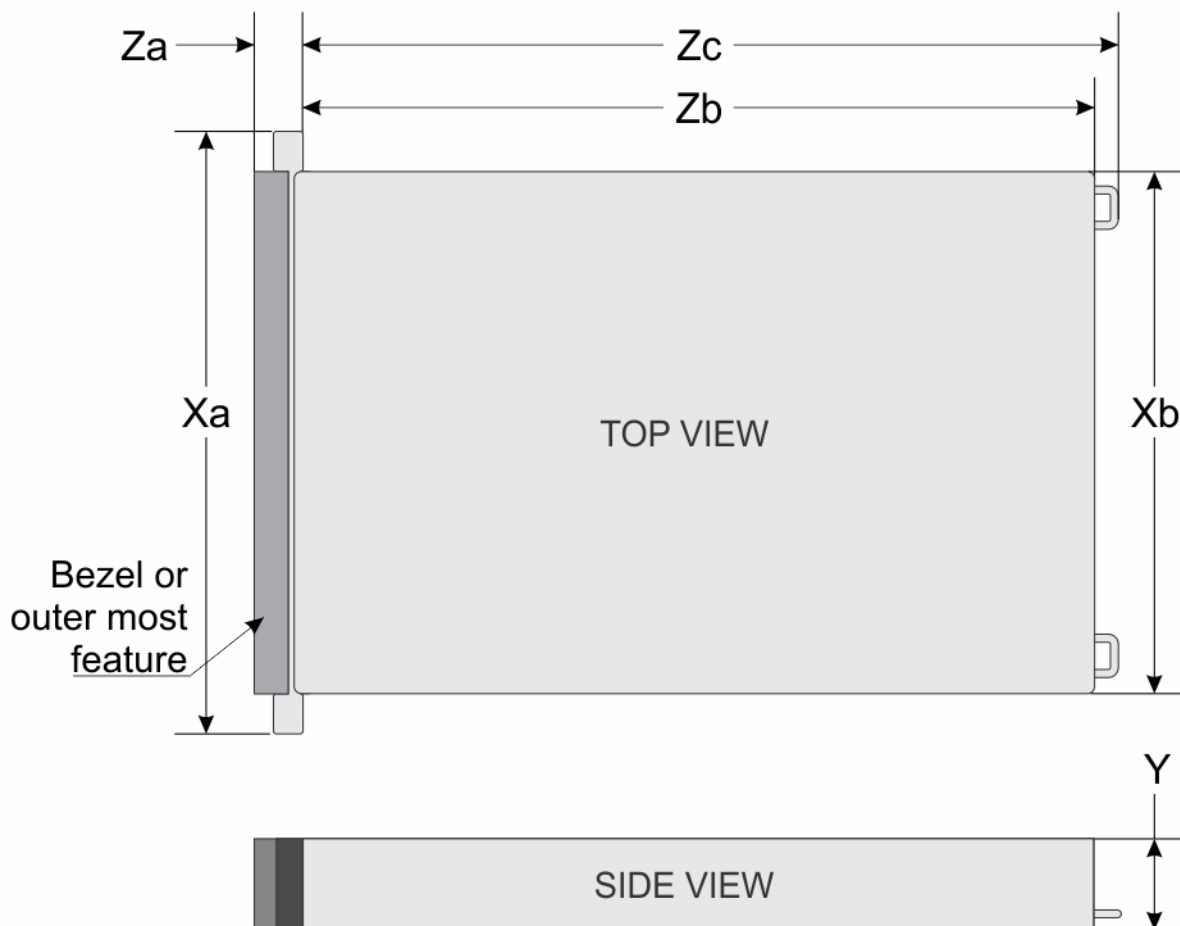


Figure 42. Chassis dimensions

**Table 32. Chassis dimensions**

| Model number | Xa                         | Xb                         | Y                        | Za with bezel            | Za without bezel         | Zb   | Zc   | Mx system Wgt.       | Chassis |
|--------------|----------------------------|----------------------------|--------------------------|--------------------------|--------------------------|--|--|----------------------|---------|
| R860         | 482.0 mm<br>(18.97 inches) | 444.0 mm<br>(17.48 inches) | 86.8 mm<br>(3.41 inches) | 36.0 mm<br>(1.41 inches) | 22.0 mm<br>(0.86 inches) | 817.23 mm (32.17 inches)<br>Ear to rear wall | 848.3 mm (33.39 inches)<br>Ear to PSU handle | 42.97 kg (94.73 lbs) | 2U      |

**NOTE:** Zb is the nominal rear wall external surface where the system board I/O connectors reside.

## Chassis weight

**Table 33. Chassis weight**

| System configuration                      | Maximum weight (with all drives/SSDs) |
|---|---------------------------------------|
| A server with fully populated drives      | 42.97 kg (94.73 lbs)                  |
| A server without drives and PSU installed | 13.09 kg (28.85 lbs)                  |

## NIC port specifications

The PowerEdge R860 system supports up to two 10/100/1000 Mbps Network Interface Controller (NIC) ports embedded on the LAN on Motherboard (LOM) and integrated on the optional Open Compute Project (OCP) cards.

**Table 34. NIC port specification for the system**

| Feature                       | Specifications   |
|-------------------------------|--|
| LOM card (optional)           | 1 GbE x 2  |
| OCP card (OCP 3.0) (optional) | 1GbE x 4, 10 GbE x 2, 10 GbE x 4, 25 GbE x 2, 25 GbE x 4 |

**NOTE:** The system allows either LOM card or an OCP card or both to be installed in the system.

## Video specifications

The PowerEdge R860 system supports integrated Matrox G200 graphics controller with 16 MB of video frame buffer.

**Table 35. Supported video resolution options**

| Resolution  | Refresh rate (Hz) | Color depth (bits) |
|-------------|-------------------|--------------------|
| 1024 x 768  | 60                | 8, 16, 32          |
| 1280 x 800  | 60                | 8, 16, 32          |
| 1280 x 1024 | 60                | 8, 16, 32          |
| 1360 x 768  | 60                | 8, 16, 32          |
| 1440 x 900  | 60                | 8, 16, 32          |
| 1600 x 900  | 60                | 8, 16, 32          |
| 1600 x 1200 | 60                | 8, 16, 32          |
| 1680 x 1050 | 60                | 8, 16, 32          |

**Table 35. Supported video resolution options (continued)**

| Resolution  | Refresh rate (Hz) | Color depth (bits) |
|-------------|-------------------|--------------------|
| 1920 x 1080 | 60                | 8, 16, 32          |
| 1920 x 1200 | 60                | 8, 16, 32          |

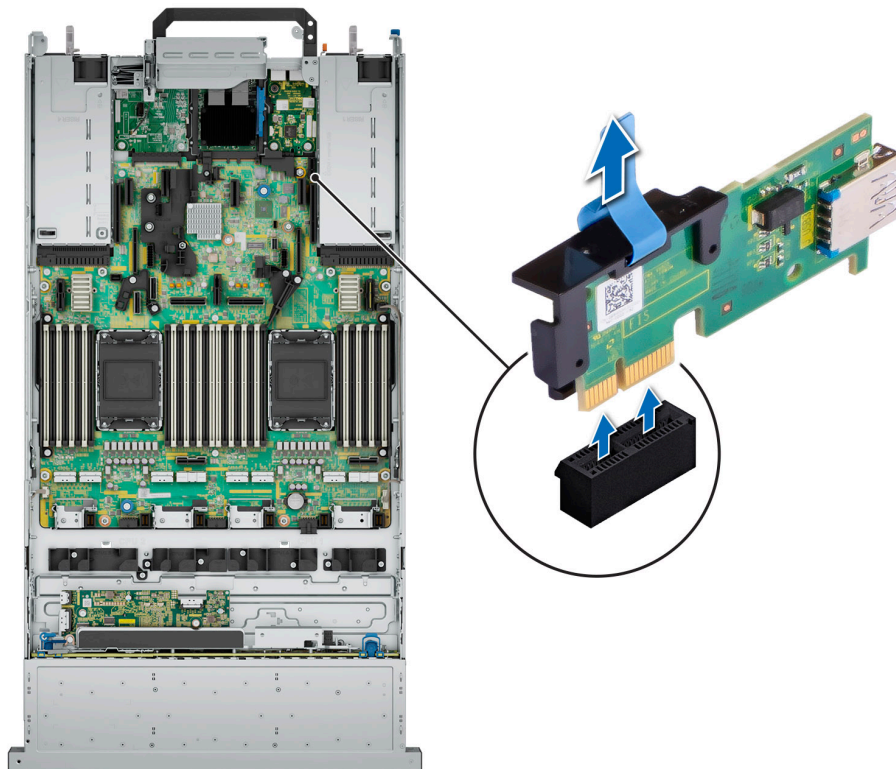
## USB Ports



**Figure 43. Front USB Port**



**Figure 44. Rear USB Port**



**Figure 45. Internal USB Port**

**Table 36. Systems USB Specifications**

| Front                      |              | Rear                       |              | Internal                   |              |
|----------------------------|--------------|----------------------------|--------------|----------------------------|--------------|
| USB port type              | No. of ports | USB port type              | No. of ports | USB port type              | No. of ports |
| USB x.2.0 – compliant port | 1            | USB x.2.0 – compliant port | 1            | USB x.3.0 – compliant port | 1            |
|                            |              | USB x.3.0 – compliant port | 1            |                            |              |

## PSU rating

Below table lists the power capacity the PSUs in high/low line operation mode.

**Table 37. PSUs highline and lowline ratings**

| Features                      | 1100 W Titanium | 1400 W Platinum | 1800 W Titanium | 2400 W Platinum | 2800 W Titanium |
|-------------------------------|-----------------|-----------------|-----------------|-----------------|-----------------|
| Peak Power (Highline/-72 VDC) | 1870 W          | 2380 W          | 3060 W          | 4080 W          | 4760 W          |
| Highline/-72 VDC              | 1100 W          | 1400 W          | 1800 W          | 2400 W          | 2800 W          |
| Peak Power (Lowline/-40 VDC)  | 1785 W          | 1785 W          | N/A             | 2380 W          | N/A             |
| Lowline/-40 VDC               | 1050 W          | 1050 W          | N/A             | 1400 W          | N/A             |
| Highline 240 VDC              | 1100 W          | 1400 W          | 1800 W          | 2400 W          | 2800 W          |

The PowerEdge R860 supports up to two AC power supplies with 1+1 redundancy, autosensing, and auto switching capability.

If two PSUs are present during POST, a comparison is made between the wattage capacities of the PSUs. In case the PSU wattages do not match, the larger of the two PSUs is enabled. Also, there is a PSU mismatch warning that is displayed in BIOS, iDRAC, or on the system LCD.

If a second PSU is added at run-time, in order for that particular PSU to be enabled, the wattage capacity of the first PSU must equal the second PSU. Otherwise, the PSU is flagged as unmatched in iDRAC and the second PSU is not enabled.

Dell PSUs have achieved Platinum efficiency levels as shown in the table below.

**Table 38. PSU efficiency level**

| Efficiency Targets by Load |           |          |        |        |        |        |
|----------------------------|-----------|----------|--------|--------|--------|--------|
| Form factor                | Output    | Class    | 10%    | 20%    | 50%    | 100%   |
| Redundant 60 mm            | 1100 W AC | Titanium | 90.00% | 94.00% | 96.00% | 91.50% |
|                            | 1400 W AC | Platinum | 89.00% | 93.00% | 94.00% | 91.50% |
|                            | 1800 W AC | Titanium | 90.00% | 94.00% | 96.00% | 94.00% |
| Redundant 86 mm            | 2400 W AC | Platinum | 89.00% | 93.00% | 94.00% | 91.50% |
|                            | 2800 W AC | Titanium | 90.00% | 94.00% | 96.00% | 94%    |



# Environmental specifications

**NOTE:** For additional information about environmental certifications, refer to the *Product Environmental Datasheet* located with the *Documentation* on [www.dell.com/support/home](http://www.dell.com/support/home).

**Table 39. Continuous Operation Specifications for ASHRAE A2**

| Temperature   | Specifications   |
|---|--|
| Allowable continuous operations                       |  |
| Temperature range for altitudes <= 900 m (<= 2953 ft) | 10–35°C (50–95°F) with no direct sunlight on the equipment                                 |
| Humidity percent range (non-condensing at all times)  | 8% RH with -12°C (10.4°F) minimum dew point to 80% RH with 21°C (69.8°F) maximum dew point |
| Operational altitude de-rating                        | Maximum temperature is reduced by 1°C/300 m (1.8°F/984 Ft) above 900 m (2953 Ft)           |

**Table 40. Continuous Operation Specifications for ASHRAE A3**

| Temperature   | Specifications   |
|---|--|
| Allowable continuous operations                       |  |
| Temperature range for altitudes <= 900 m (<= 2953 ft) | 5–40°C (41–104°F) with no direct sunlight on the equipment                                 |
| Humidity percent range (non-condensing at all times)  | 8% RH with -12°C (10.4°F) minimum dew point to 85% RH with 24°C (75.2°F) maximum dew point |
| Operational altitude de-rating                        | Maximum temperature is reduced by 1°C/175 m (1.8°F/574 Ft) above 900 m (2953 Ft)           |

**Table 41. Continuous Operation Specifications for ASHRAE A4**

| Temperature   | Specifications   |
|---|--|
| Allowable continuous operations                       |  |
| Temperature range for altitudes <= 900 m (<= 2953 ft) | 5–45°C (41–113°F) with no direct sunlight on the equipment                                 |
| Humidity percent range (non-condensing at all times)  | 8% RH with -12°C (10.4°F) minimum dew point to 90% RH with 24°C (75.2°F) maximum dew point |
| Operational altitude de-rating                        | Maximum temperature is reduced by 1°C/125 m (1.8°F/410 Ft) above 900 m (2953 Ft)           |

**Table 42. Common Environmental Specifications for ASHRAE A2, A3 and A4**

| Temperature  | Specifications  |
|--|---|
| Allowable continuous operations  |   |
| Maximum temperature gradient (applies to both operation and non-operation) | 20°C in an hour* (36°F in an hour) and 5°C in 15 minutes (9°F in 15 minutes), 5°C in an hour* (9°F in an hour) for tape hardware<br><b>NOTE:</b> *Per ASHRAE thermal guidelines for tape hardware, these are not instantaneous rates of temperature change. |
| Non-operational temperature limits   | -40 to 65°C (-40 to 149°F)  |



**Table 42. Common Environmental Specifications for ASHRAE A2, A3 and A4 (continued)**

| Temperature                      | Specifications                                    |
|----------------------------------|---|
| Non-operational humidity limits  | 5% to 95% RH with 27°C (80.6°F) maximum dew point |
| Maximum non-operational altitude | 12,000 meters (39,370 feet)                       |
| Maximum operational altitude     | 3,050 meters (10,006 feet)                        |

**Table 43. Maximum vibration specifications**

| Maximum vibration | Specifications  |
|-------------------|---|
| Operating         | 0.21 G <sub>rms</sub> at 5 Hz to 500 Hz for 10 minutes (all operation orientations) |
| Storage           | 1.88 G <sub>rms</sub> at 10 Hz to 500 Hz for 15 minutes (all six sides tested)      |

**Table 44. Maximum shock pulse specifications**

| Maximum shock pulse | Specifications  |
|---------------------|---|
| Operating           | Six consecutively executed shock pulses in the positive and negative x, y, and z axis of 6 G for up to 11 ms  |
| Storage             | Six consecutively executed shock pulses in the positive and negative x, y, and z axis (one pulse on each side of the system) of 71 G for up to 2 ms |

## Particulate and gaseous contamination specifications

The following table defines the limitations that help avoid any equipment damage or failure from particulates and gaseous contamination. If the levels of particulates or gaseous pollution exceed the specified limitations and result in equipment damage or failure, you may need to rectify the environmental conditions. Remediation of environmental conditions is the responsibility of the customer.

**Table 45. Particulate contamination specifications**

| Particulate contamination   | Specifications  |
|---|---|
| Air filtration  | Data center air filtration as defined by ISO Class 8 per ISO 14644-1 with a 95% upper confidence limit<br><i>i</i> <b>NOTE:</b> This condition applies to data center environments only. Air filtration requirements do not apply to IT equipment designed to be used outside a data center, in environments such as an office or factory floor.<br><i>i</i> <b>NOTE:</b> Air entering the data center must have MERV11 or MERV13 filtration. |
| Conductive dust   | Air must be free of conductive dust, zinc whiskers, or other conductive particles<br><i>i</i> <b>NOTE:</b> This condition applies to data center and non-data center environments.  |
| Corrosive dust  | <ul style="list-style-type: none"> <li>Air must be free of corrosive dust</li> <li>Residual dust present in the air must have a deliquescent point less than 60% relative humidity</li> </ul> <i>i</i> <b>NOTE:</b> This condition applies to data center and non-data center environments.   |
| Walk-Up Edge Data Center or Cabinet (sealed, closed loop environment) | Filtration is not required for cabinets that are anticipated to be opened 6 times or less per year. Class 8 per ISO 1466-1 filtration as defined above is required otherwise<br><i>i</i> <b>NOTE:</b> In environments commonly above ISA-71 Class G1 or that may have known challenges, special filters may be required.  |

**Table 46. Gaseous contamination specifications**

| Gaseous contamination        | Specifications   |
|------------------------------|--|
| Copper coupon corrosion rate | <300 Å/month per Class G1 as defined by ANSI/ISA71.04-2013 |
| Silver coupon corrosion rate | <200 Å/month as defined by ANSI/ISA71.04-2013              |

## Thermal restriction matrix

**Table 47. Processor and heat sink matrix**

| Heat sink       | Processor TDP  |
|-----------------|----------------|
| STD HSK         | ≤ 185 W        |
| L-type HPR HSK  | 195 W to 250 W |
| L-type VHPR HSK | ≥ 270 W        |

**Table 48. Label reference**

| Label | Description           |
|-------|-----------------------|
| HPR   | High performance      |
| VHPR  | Very High Performance |
| HSK   | Heat sink             |
| LP    | Low Profile           |
| FH    | Full Height           |

**NOTE:** The ambient temperature of the configuration is determined by the critical component in that configuration. For example, if the processor's supported ambient temperature is 35°C (95°F), the DIMM is 35°C (95°F), and the GPU is 30°C (86°F), the combined configuration can only support 30°C (86°F).

**Table 49. Thermal restriction matrix for air cooled configurations**

| Configuration |       |                        | 24 x 2.5-inch NVMe  | 16 x 2.5-inch SAS + 8 x 2.5-inch NVMe | 24 x 2.5-inch SAS |                       | 16 x 2.5-inch NVMe | 16 x 2.5-inch SAS | 8 x 2.5-inch SAS | 8 x EDSFF E3.S |
|---------------|-------|------------------------|---------------------|---------------------------------------|-------------------|-----------------------|--------------------|-------------------|------------------|----------------|
| Rear storage  |       |                        | No Rear Drives      | No Rear Drives                        | No Rear Drives    | 2 x 2.5-inch SAS/NVMe | No Rear Drives     | No Rear Drives    | No Rear Drives   | No Rear Drives |
| CPU SKUs      | TDP   | T-Case max center (°C) | Ambient temperature |                                       |                   |                       |                    |                   |                  |                |
| 6416H         | 165 W | 82                     | 35°C (95°F)         | 35°C (95°F)                           | 45°C (113°F)      | 35°C (95°F)           | 35°C (95°F)        | 45°C (113°F)      | 45°C (113°F)     | 35°C (95°F)    |
| 6418H         | 185 W | 81                     | 35°C (95°F)         | 35°C (95°F)                           | 40°C (104°F)      | 35°C (95°F)           | 35°C (95°F)        | 40°C (104°F)      | 40°C (104°F)     | 35°C (95°F)    |
| 6434H         | 195 W | 64                     | 35°C (95°F)         | 35°C (95°F)                           | 40°C (104°F)      | 35°C (95°F)           | 35°C (95°F)        | 40°C (104°F)      | 40°C (104°F)     | 35°C (95°F)    |
| 6448H         | 250 W | 83                     | 35°C (95°F)         | 35°C (95°F)                           | 35°C (95°F)       | 35°C (95°F)           | 35°C (95°F)        | 35°C (95°F)       | 35°C (95°F)      | 35°C (95°F)    |
| 8450H         | 250 W | 76                     | 35°C (95°F)         | 35°C (95°F)                           | 35°C (95°F)       | 35°C (95°F)           | 35°C (95°F)        | 35°C (95°F)       | 35°C (95°F)      | 35°C (95°F)    |

**Table 49. Thermal restriction matrix for air cooled configurations (continued)**

| Configuration |       |    | 24 x 2.5-inch NVMe  | 16 x 2.5-inch SAS + 8 x 2.5-inch NVMe | 24 x 2.5-inch SAS |                       | 16 x 2.5-inch NVMe | 16 x 2.5-inch SAS | 8 x 2.5-inch SAS | 8 x EDSFF E3.S |
|---------------|-------|----|---------------------|---------------------------------------|-------------------|-----------------------|--------------------|-------------------|------------------|----------------|
| Rear storage  |       |    | No Rear Drives      | No Rear Drives                        | No Rear Drives    | 2 x 2.5-inch SAS/NVMe | No Rear Drives     | No Rear Drives    | No Rear Drives   | No Rear Drives |
| 8444H         | 270 W | 72 | 35°C (95°F)         | 35°C (95°F)                           | 35°C (95°F)       | 35°C (95°F)           | 35°C (95°F)        | 35°C (95°F)       | 35°C (95°F)      | 35°C (95°F)    |
| 8454H         | 270 W | 71 | 35°C (95°F)         | 35°C (95°F)                           | 35°C (95°F)       | 35°C (95°F)           | 35°C (95°F)        | 35°C (95°F)       | 35°C (95°F)      | 35°C (95°F)    |
| 8460H         | 330 W | 76 | 30°C (86°F)         | 30°C (86°F)                           | 30°C (86°F)       | 30°C (86°F)           | 35°C (95°F)        | 35°C (95°F)       | 35°C (95°F)      | 35°C (95°F)    |
| 8468H         | 330 W | 77 | 30°C (86°F)         | 30°C (86°F)                           | 30°C (86°F)       | 30°C (86°F)           | 35°C (95°F)        | 35°C (95°F)       | 35°C (95°F)      | 35°C (95°F)    |
| 8490H         | 350 W | 79 | 30°C (86°F)         | 30°C (86°F)                           | 30°C (86°F)       | 30°C (86°F)           | 35°C (95°F)        | 35°C (95°F)       | 35°C (95°F)      | 35°C (95°F)    |
| Memory        |       |    | Ambient temperature |                                       |                   |                       |                    |                   |                  |                |
| 256 GB RDIMM  |       |    | 35°C (95°F)         | 35°C (95°F)                           | 35°C (95°F)       | 35°C (95°F)           | 35°C (95°F)        | 35°C (95°F)       | 35°C (95°F)      | 35°C (95°F)    |
| 128 GB RDIMM  |       |    | 35°C (95°F)         | 35°C (95°F)                           | 35°C (95°F)       | 35°C (95°F)           | 35°C (95°F)        | 35°C (95°F)       | 35°C (95°F)      | 35°C (95°F)    |
| 64 GB RDIMM   |       |    | N/A*                |                                       |                   |                       |                    |                   |                  |                |
| 32 GB RDIMM   |       |    | N/A*                |                                       |                   |                       |                    |                   |                  |                |
| 16 GB RDIMM   |       |    | N/A*                |                                       |                   |                       |                    |                   |                  |                |

**NOTE:** DIMM blanks must be installed in empty DIMM slots.

**NOTE:** \*Memory will have the same thermal restrictions of the processor used.

## Thermal air restrictions

**Table 50. Air cooling thermal restriction for 24 x 2.5-inch NVMe/16 x 2.5-inch + 8 x NVMe/16 x NVMe Storage Configurations**

| ASHRAE    | A2/35°C (95°F)   | A3/40°C (104°F)                                      | A4/45°C (113°F)         |
|-----------|--|--|-------------------------|
| Processor | CPUs ≥ 330 W are not supported.<br>Maximum 30°C for CPU ≥ 330 W  | CPUs ≤ 195 W are supported.                          | Only 165 W is supported |
| PSU       | Two PSUs are required in redundant mode. If there is a PSU failure, system performance may be reduced. |  |                         |
| PCIe card | Non-Dell qualified peripheral cards and peripheral cards greater than 25 W are not supported.          |  |                         |
| GPU/FPGA  | Not supported  |  |                         |
| DIMM      | 256 GB RDIMMs only support 1DPC<br>Maximum 35°C for 128 GB RDIMM or greater capacity RDIMMs            | 128 GB, or greater capacity DIMMs are not supported. |                         |

**Table 50. Air cooling thermal restriction for 24 x 2.5-inch NVMe/16 x 2.5-inch + 8 x NVMe/16 x NVMe Storage Configurations (continued)**

| ASHRAE       | A2/35°C (95°F)                      | A3/40°C (104°F)  | A4/45°C (113°F) |
|--------------|-------------------------------------|--|-----------------|
| NVMe storage | 2.5-inch NVMe storage is supported. | 2.5-inch NVMe storage is not supported.                                      |                 |
| OCP          | OCP cooling tier >5 is supported    | OCP cooling tier >5 is not supported<br>85°C active optics cable is required |                 |
| BOSS         | BOSS-N1 is supported.               | BOSS-N1 is not supported.  |                 |

**Table 51. Air cooling configurations thermal restriction for 8 x 2.5-inch/16 x 2.5-inch Storage Configuration**

| ASHRAE       | A2/35°C (95°F)   | A3/40°C (104°F)  | A4/45°C (113°F)         |
|--------------|--|--|-------------------------|
| Processor    | CPUs ≥ 330 W are not supported.<br>Maximum 30°C for CPU ≥ 330 W  | CPUs ≤ 195 W are supported.  | Only 165 W is supported |
| PSU          | Two PSUs are required in redundant mode. If there is a PSU failure, system performance may be reduced. |  |                         |
| PCIe card    | Non-Dell qualified peripheral cards and peripheral cards greater than 25 W are not supported.          |  |                         |
| GPU/FPGA     | Not supported  |  |                         |
| DIMM         | 256 GB RDIMMs only support 1DPC<br>Maximum 35°C for 128 GB RDIMM or greater capacity RDIMMs            | 128 GB, or greater capacity DIMMs are not supported.                         |                         |
| NVMe storage | 2.5-inch NVMe storage is not supported.  |  |                         |
| OCP          | OCP cooling tier >5 is supported   | OCP cooling tier >5 is not supported<br>85°C active optics cable is required |                         |
| BOSS         | BOSS-N1 is supported.  | BOSS-N1 is not supported.  |                         |

## Appendix B. Standards compliance

The system conforms to the following industry standards.

**Table 52. Industry standard documents**

| Standard   | URL for information and specifications  |
|--|---|
| <b>ACPI</b> Advance Configuration and Power Interface Specification, v2.0c | <a href="https://uefi.org/specsandtesttools">https://uefi.org/specsandtesttools</a>   |
| <b>Ethernet</b> IEEE 802.3-2005  | <a href="https://standards.ieee.org/">https://standards.ieee.org/</a>   |
| <b>HDG</b> Hardware Design Guide Version 3.0 for Microsoft Windows Server  | <a href="https://microsoft.com/whdc/system/platform/pcdesign/desguide/serverdg.mspx">microsoft.com/whdc/system/platform/pcdesign/desguide/serverdg.mspx</a>                           |
| <b>IPMI</b> Intelligent Platform Management Interface, v2.0                | <a href="https://intel.com/design/servers/ipmi">intel.com/design/servers/ipmi</a>   |
| <b>DDR5 Memory</b> DDR5 SDRAM Specification                                | <a href="https://jedec.org/standards-documents/docs/jesd79-4.pdf">jedec.org/standards-documents/docs/jesd79-4.pdf</a>   |
| <b>PCI Express</b> PCI Express Base Specification Rev. 2.0 and 3.0         | <a href="https://pcisig.com/specifications/pciexpress">pcisig.com/specifications/pciexpress</a>   |
| <b>PMBus</b> Power System Management Protocol Specification, v1.2          | <a href="http://pmbus.org/Assets/PDFS/Public/PMBus_Specification_Part_1_Rev_1-1_20070205.pdf">http://pmbus.org/Assets/PDFS/Public/PMBus_Specification_Part_1_Rev_1-1_20070205.pdf</a> |
| <b>SAS</b> Serial Attached SCSI, v1.1                                      | <a href="http://www.t10.org/">http://www.t10.org/</a>   |
| <b>SATA</b> Serial ATA Rev. 2.6; SATA II, SATA 1.0a Extensions, Rev. 1.2   | <a href="https://sata-io.org">sata-io.org</a>   |
| <b>SMBIOS</b> System Management BIOS Reference Specification, v2.7         | <a href="https://dmtf.org/standards/smbios">dmtf.org/standards/smbios</a>   |
| <b>TPM</b> Trusted Platform Module Specification, v1.2 and v2.0            | <a href="https://trustedcomputinggroup.org">trustedcomputinggroup.org</a>   |
| <b>UEFI</b> Unified Extensible Firmware Interface Specification, v2.1      | <a href="https://uefi.org/specifications">uefi.org/specifications</a>   |
| <b>USB</b> Universal Serial Bus Specification, Rev. 2.7                    | <a href="https://usb.org/developers/docs">usb.org/developers/docs</a>   |

## Appendix C Additional resources

**Table 53. Additional resources**

| Resource                                       | Description of contents  | Location   |
|--|--|--|
| Installation and Service Manual                | <p>This manual, available in PDF format, provides the following information:</p> <ul style="list-style-type: none"> <li>• Chassis features</li> <li>• System Setup program</li> <li>• System indicator codes</li> <li>• System BIOS</li> <li>• Remove and replace procedures</li> <li>• Diagnostics</li> <li>• Jumpers and connectors</li> </ul> | <a href="http://Dell.com/Support/Manuals">Dell.com/Support/Manuals</a> |
| Getting Started Guide                          | <p>This guide ships with the system, and is also available in PDF format. This guide provides the following information:</p> <ul style="list-style-type: none"> <li>• Initial setup steps</li> </ul>   | <a href="http://Dell.com/Support/Manuals">Dell.com/Support/Manuals</a> |
| Rack Installation Guide                        | <p>This document ships with the rack kits, and provides instructions for installing a server in a rack.</p>  | <a href="http://Dell.com/Support/Manuals">Dell.com/Support/Manuals</a> |
| System Information Label                       | <p>The system information label documents the system board layout and system jumper settings. Text is minimized due to space limitations and translation considerations. The label size is standardized across platforms.</p>  | Inside the system chassis cover  |
| Quick Resource Locator (QRL)                   | <p>This code on the chassis can be scanned by a phone application to access additional information and resources for the server, including videos, reference materials, service tag information, and Dell contact information.</p>   | Inside the system chassis cover  |
| Enterprise Infrastructure Planning Tool (EIPT) | <p>The Dell online EIPT enables easier and more meaningful estimates to help you determine the most efficient configuration possible. Use EIPT to calculate the power consumption of your hardware, power infrastructure, and storage.</p>   | <a href="http://Dell.com/calc">Dell.com/calc</a>                       |