

# Dell PowerEdge R7625

## Technical Guide

## Notes, cautions, and warnings

 **NOTE:** A NOTE indicates important information that helps you make better use of your product.

 **CAUTION:** A CAUTION indicates either potential damage to hardware or loss of data and tells you how to avoid the problem.

 **WARNING:** A WARNING indicates a potential for property damage, personal injury, or death.

<b>Chapter 1: System overview</b>	<b>5</b>
Key workloads	5
New technologies	5
<b>Chapter 2: System features and generational comparison</b>	<b>7</b>
<b>Chapter 3: Chassis views and features</b>	<b>10</b>
Chassis views	10
Front view of the system	10
Rear view of the system	11
Inside the system	12
Quick Resource Locator	14
<b>Chapter 4: Processor</b>	<b>16</b>
Processor features	16
Supported processors	16
<b>Chapter 5: Memory subsystem</b>	<b>18</b>
Supported memory	18
<b>Chapter 6: Storage</b>	<b>19</b>
Storage controllers	19
Supported Drives	19
Internal storage configuration	20
External Storage	21
<b>Chapter 7: Networking</b>	<b>23</b>
Overview	23
OCP 3.0 support	23
Supported OCP cards	23
OCP NIC 3.0 vs. rack Network Daughter Card comparisons	24
<b>Chapter 8: PCIe subsystem</b>	<b>25</b>
PCIe risers	25
<b>Chapter 9: Power, thermal, and acoustics</b>	<b>34</b>
Power	34
Power Supply Units	35
Thermal	36
Thermal design	37
Acoustics	37
Acoustical configurations of R7625	37
PowerEdge acoustical specifications	39

<b>Chapter 10: Rack, rails, and cable management.....</b>	<b>48</b>
Rails and cable management information.....	48
<b>Chapter 11: Supported Operating Systems.....</b>	<b>57</b>
<b>Chapter 12: Dell OpenManage Systems Management.....</b>	<b>58</b>
Integrated Dell Remote Access Controller (iDRAC).....	58
Systems Management software support matrix.....	59
<b>Chapter 13: Appendix D: Service and support.....</b>	<b>61</b>
Default support levels.....	61
Default deployment levels.....	61
Other services and support information.....	61
Dell deployment services.....	61
Dell custom deployment Services.....	65
Dell Residency Services.....	65
Dell Data Migration Services.....	65
Dell Enterprise Support Services.....	66
Enterprise connectivity.....	68
Dell TechDirect.....	69
Dell Technologies Consulting Services.....	69
<b>Chapter 14: Appendix A. Additional specifications.....</b>	<b>71</b>
Chassis dimensions .....	71
System weight.....	72
NIC port specifications.....	72
Video specifications.....	72
USB ports specifications.....	73
PSU rating.....	73
Environmental specifications.....	74
Thermal air restrictions.....	76
Thermal restriction matrix.....	77
<b>Chapter 15: Appendix B. Standards compliance.....</b>	<b>84</b>
<b>Chapter 16: Appendix C Additional resources.....</b>	<b>85</b>

# System overview

The PowerEdge R7625 system is a 2U server that supports:

- Two AMD EPYC 4<sup>th</sup> Generation 9004 series processor with up to 128 cores
- Optional Direct Liquid Cooling(DLC) for required CPU SKU and/or configurations
- Up to 24 RDIMMs, with up to 6 TB of memory and speeds up to 4800 MT/s
- Two redundant AC or DC power supply units
- Up to 8 x 3.5-inch SATA/SAS drives or 8 x 2.5 SATA/SAS/NVMe or 12 x 3.5-inch SATA/SAS or 16 x 2.5-inch SATA/SAS/NVMe 24 x 2.5-inch SATA/SAS/NVMe (HDD/SSD) drives
- PCI Express® (PCIe) 5.0 enabled expansion slots
- Network interface technologies to cover Network Interface Card (NIC)

## Topics:

- [Key workloads](#)
- [New technologies](#)

## Key workloads

Customers looking for accelerated compute to maximize performance in a dense, scalable server architecture to address the following applications:

- High Performance Computing
- Virtual Desktop Infrastructure (VDI)
- Virtualization

## New technologies

**Table 1. New technologies**

Technology	Detailed Description
AMD Genoa Processor (SP5)	Core count: Up to 128 core processor
	5nm process technology
	AMD Inter-chip global memory interconnect (xGMI) up to 64 lanes
	Speeds up to 4.1 GHz
	Maximum TDP: 400 W
4800 MT/s DDR5 Memory	Up to 12 channels with 1 DPC per CPU and 24 DIMMs in total
	Supports RDIMM, 3DS DIMM DDR5 with ECC up to 4800 MT/s
PCIe Gen	Gen5 @32 GT/s
PCIe Slot	Up to eight PCIe Slots with x8 or x16 lanes
Flex I/O	LOM board, 2 x1Gb with BCM5720 LAN controller
	Rear I/O with: <ul style="list-style-type: none"> <li>• 1 GB Dedicated Management Network Port</li> <li>• 1 x USB 3.0</li> <li>• 1 x USB 2.0</li> </ul>

**Table 1. New technologies (continued)**

Technology	Detailed Description
	<ul style="list-style-type: none"> <li>● VGA port (optional for Direct Liquid Cooling configuration)</li> </ul> Serial Port Option with STD RIO board OCP Mezz 3.0 (supported by x8 PCIe lanes) (optional) Front I/O with: <ul style="list-style-type: none"> <li>● 1 x iDRAC Direct (Micro-AB USB) port</li> <li>● 1 x USB 2.0</li> <li>● 1 x VGA</li> </ul>
CPLD 1-wire	Support payload data of Front PERC, Riser, BOSS N1, BP and Rear IO to BIOS and iDRAC
Dedicated PERC	PERC 11 <ul style="list-style-type: none"> <li>● HBA355i, H355, H755, H755N</li> </ul> PERC 12 <ul style="list-style-type: none"> <li>● H965i</li> </ul>
Software RAID	S160
Power Supplies	60 mm / 86 mm dimension is the new PSU form factor on 16G design Platinum 800 W AC/HVDC Platinum 1100 W AC/HVDC Platinum 1400 W AC/HVDC Titanium 1800 W AC/HVDC Platinum 2400 W AC/HVDC Titanium 2800 W AC/HVDC

## System features and generational comparison

The following table shows the comparison between the PowerEdge 7625 with the PowerEdge R7525.

**Table 2. Features comparison**

Features	PowerEdge R7625	PowerEdge R7525
Processors	Two AMD® EPYC™ 4th Generation 9004 series processors	Two AMD® EPYC™ Generation 2 or Generation 3 processors
CPU interconnect	Inter-chip global memory interconnect (xGMI) 32GT/sec	Inter-chip global memory interconnect (xGMI) 16GT/sec
Memory	24 x DDR5 RDIMM (6 TB), bandwidth up to 4800 MT/S	32 x DDR4 RDIMM (2TB), LRDIMM (4TB), bandwidth up to 3200 MT/S
Storage Controllers	<ul style="list-style-type: none"> <li>PERC 11: HBA355i, H355, H755, H755N</li> <li>PERC 12: H965i</li> <li>Software RAID: S160</li> <li>BOSS-N1</li> </ul>	<ul style="list-style-type: none"> <li>Adapters: HBA355E, H840</li> <li>PERC: H345, H745, H755, H755N</li> <li>Software RAID: S150</li> </ul>
Drive Bays	<p>Front bays:</p> <ul style="list-style-type: none"> <li>Up to 8 x 3.5-inch SAS4/SATA (HDD/SSD) max 160 TB</li> <li>Up to 12 x 3.5-inch SAS/SATA (HDD/SSD) max 240 TB</li> <li>Up to 8 x 2.5-inch SAS/SATA/NVMe (HDD/SSD) max 122.88 TB</li> <li>Up to 16 x 2.5-inch SAS/SATA/NVMe (HDD/SSD) max 245.76 TB</li> <li>Up to 24 x 2.5-inch SAS/SATA/NVMe (HDD/SSD) max 368.64 TB</li> </ul> <p>Rear bay:</p> <ul style="list-style-type: none"> <li>Up to 2 x 2.5-inch SAS4/SATA/NVMe (HDD/SSD) max 30.72 TB</li> <li>Up to 4 x 2.5-inch SAS4/SATA/NVMe (HDD/SSD) max 61.44 TB</li> </ul>	<p>Front bays:</p> <ul style="list-style-type: none"> <li>3.5 inches, 2.5 inches - 12 Gb SAS, 6 Gb SATA, NVMe HDD</li> </ul>
Power Supplies	<ul style="list-style-type: none"> <li>Mixed Mode (MM) AC/HVDC (Platinum) 800 W, 1400 W, 2400 W</li> <li>Mixed Mode (MM) AC/HVDC (Titanium) 1100 W, 1800 W, 2800 W</li> <li>(-48 V) 1100 W DC PSU</li> </ul>	<ul style="list-style-type: none"> <li>Mixed Mode (MM) AC/HVDC (Platinum) 800 W, 1400 W, 2400 W</li> <li>Titanium 1100 W Mixed Mode AC/HVDC, (-48 V) 1100 W DC PSU</li> </ul>
Cooling Options	<ul style="list-style-type: none"> <li>Air Cooling</li> <li>Optional Direct Liquid Cooling (DLC)</li> </ul>	<ul style="list-style-type: none"> <li>Air Cooling</li> </ul>
Fans	Up to six High performance Silver / High Performance Gold hot plug fans	Up to six Standard (STD) / High performance (HPR) / Very High Performance (VHP) hot plug fans
Dimension	Height: 86.8 mm (3.41 inches)	Height: 86.8 mm (3.41 inches)
	Width: 482 mm (18.97 inches)	Width: 482 mm (18.97 inches)
	Depth: 772.13 mm (30.39 inches) with bezel	Depth: 772.13 mm (30.39 inches) with bezel

**Table 2. Features comparison (continued)**

Features	PowerEdge R7625	PowerEdge R7525
	Depth: 758.29 mm (29.85 inches) without bezel	Depth: 758.29 mm (29.85 inches) without bezel
Form Factor	2U rack server	2U rack server
Embedded Management	<ul style="list-style-type: none"> <li>• iDRAC9</li> <li>• iDRAC Direct</li> <li>• iDRAC RESTful with Redfish</li> <li>• iDRAC Service Manual</li> <li>• Quick Sync 2 wireless module</li> </ul>	<ul style="list-style-type: none"> <li>• iDRAC9</li> <li>• iDRAC Direct</li> <li>• iDRAC Service Module</li> <li>• Quick Sync 2 wireless module</li> </ul>
Bezel	Optional LCD bezel or security bezel	Optional LCD bezel or security bezel
OpenManage Software	<ul style="list-style-type: none"> <li>• OpenManage Enterprise</li> <li>• OpenManage Power Manager plugin</li> <li>• OpenManage SupportAssist plugin</li> <li>• OpenManage Update Manager plugin</li> <li>• CloudIQ for PowerEdge plug in</li> <li>• OpenManage Enterprise Integration for VMware vCenter</li> <li>• OpenManage Integration for Microsoft System Center</li> <li>• OpenManage Integration with Windows Admin Center</li> </ul>	<ul style="list-style-type: none"> <li>• OpenManage Enterprise</li> <li>• OpenManage Power Center</li> </ul>
Mobility	OpenManage Mobile	OpenManage Mobile
OpenManage Integrations	<ul style="list-style-type: none"> <li>• BMC TrueSight</li> <li>• Microsoft System Center</li> <li>• OpenManage Integration with ServiceNow</li> <li>• Red Hat Ansible Modules</li> <li>• Terraform Providers</li> <li>• VMware vCenter and vRealize Operations Manager</li> </ul>	<ul style="list-style-type: none"> <li>• BMC TrueSight</li> <li>• Microsoft System Center</li> <li>• Red Hat Ansible Modules</li> <li>• VMware vCenter</li> </ul>
Security	<ul style="list-style-type: none"> <li>• Cryptographically signed firmware</li> <li>• Data at Rest Encryption (SEDs with local or external key mgmt)</li> <li>• Secure Boot</li> <li>• Secure Erase</li> <li>• Secured Component Verification (Hardware integrity check)</li> <li>• Silicon Root of Trust</li> <li>• System Lockdown (requires iDRAC9 Enterprise or Datacenter)</li> <li>• TPM 2.0 FIPS, CC-TCG certified, TPM 2.0 China NationZ</li> <li>• AMD Secure Memory Encryption (SME)</li> <li>• AMD Secure Encrypted Virtualization (SEV)</li> </ul>	<ul style="list-style-type: none"> <li>• Cryptographically signed firmware</li> <li>• Secure Boot</li> <li>• Secure Erase</li> <li>• Silicon Root of Trust</li> <li>• System Lockdown (requires iDRAC9 Enterprise or Datacenter)</li> <li>• TPM 1.2/2.0 (optional), TCM 2.0 optional</li> <li>• AMD Secure Memory Encryption (SME)</li> <li>• AMD Secure Encrypted Virtualization (SEV)</li> </ul>
Embedded NIC	2 x 1GbE LOM card (optional)	2 x 1GE LOM
Networking Options	1 x OCP card 3.0 (optional)  <b>NOTE:</b> The system allows either LOM card or an OCP card or both to be installed in the system.	OCP x16 Mezz 3.0
GPU Options	Up to two double wide 300W, or six single wide 75W accelerators	Up to three double wide 300W or six single wide 75W accelerators



**Table 2. Features comparison (continued)**

Features	PowerEdge R7625		PowerEdge R7525	
Ports	<b>Front Ports</b> <ul style="list-style-type: none"> <li>● 1 x Dedicated iDRAC (micro-USB USB) port</li> <li>● 1 x USB 2.0</li> <li>● 1 x VGA</li> </ul>	<b>Rear Ports</b> <ul style="list-style-type: none"> <li>● 1 x USB 2.0</li> <li>● 1 x iDRAC ethernet port</li> <li>● 1 x USB 3.0</li> <li>● 1 x Serial port (optional)</li> <li>● 1 x VGA (optional for Direct Liquid Cooling configuration)</li> </ul>	<b>Front Ports</b> <ul style="list-style-type: none"> <li>● 1 x Dedicated iDRAC micro-USB</li> <li>● 1 x USB 2.0</li> </ul>	<b>Rear Ports</b> <ul style="list-style-type: none"> <li>● 1 x USB 2.0</li> <li>● 1 x iDRAC Direct/ ethernet port</li> <li>● 1 x USB 3.0</li> <li>● 1 x Serial port (optional)</li> <li>● 1 x VGA</li> </ul>
	Internal Port: 1 x USB 3.0		Internal Port: 1 x USB 3.0	
PCIe	Up to eight PCIe slots <ul style="list-style-type: none"> <li>● 4 x PCIe Gen5 slots</li> <li>● 8 x PCIe Gen4 slots</li> </ul>		8 x PCIe Gen4 slots	
Operating System and Hypervisors	<ul style="list-style-type: none"> <li>● Canonical Ubuntu Server LTS</li> <li>● Microsoft Windows Server with Hyper-V</li> <li>● Red Hat Enterprise Linux</li> <li>● SUSE Linux Enterprise Server</li> <li>● VMware ESXi</li> </ul> For specifications and interoperability details, see <a href="#">Dell Enterprise Operating Systems on Servers, Storage, and Networking</a> page at <a href="#">Dell.com/OSsupport</a> .		<ul style="list-style-type: none"> <li>● Canonical Ubuntu Server LTS</li> <li>● Citrix Hypervisor</li> <li>● Windows Server LTSC with Hyper-V</li> <li>● Red Hat Enterprise Linux</li> <li>● SUSE Linux Enterprise Server</li> <li>● VMware ESXi</li> </ul> For specifications and interoperability details, see <a href="#">Dell Enterprise Operating Systems on Servers, Storage, and Networking</a> page at <a href="#">Dell.com/OSsupport</a> .	

# Chassis views and features

## Topics:

- Chassis views

## Chassis views

### Front view of the system



Figure 1. Front view of 24 x 2.5-inch drive system

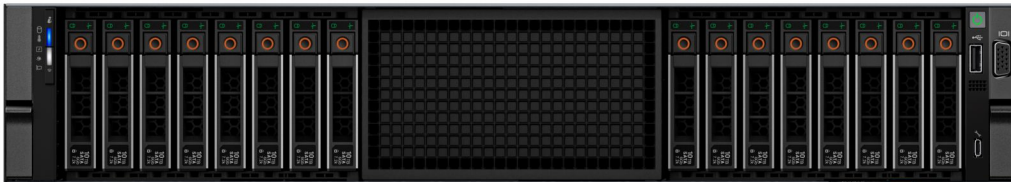

Figure 2. Front view of 16 x 2.5-inch drive system

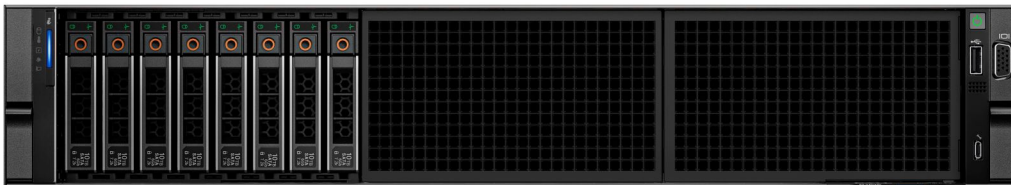

Figure 3. Front view of 8 x 2.5-inch drive system



Figure 4. Front view of 12 x 3.5-inch drive system



Figure 5. Front view of 8 x 3.5-inch drive system

## Rear view of the system



Figure 6. Rear view of the system



Figure 7. Rear view of the system with 2 x 2.5-inch rear drive module



Figure 8. Rear view of the system with 4 x 2.5-inch rear drive module

## Inside the system

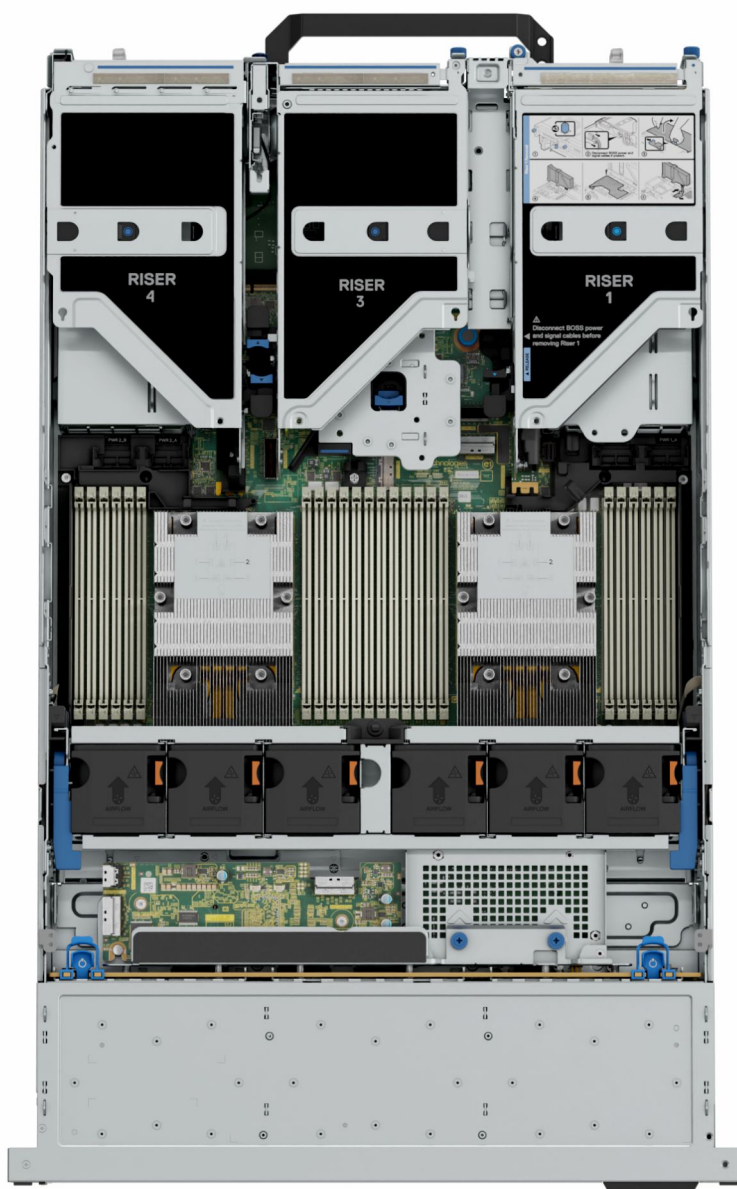

Figure 9. Inside the system

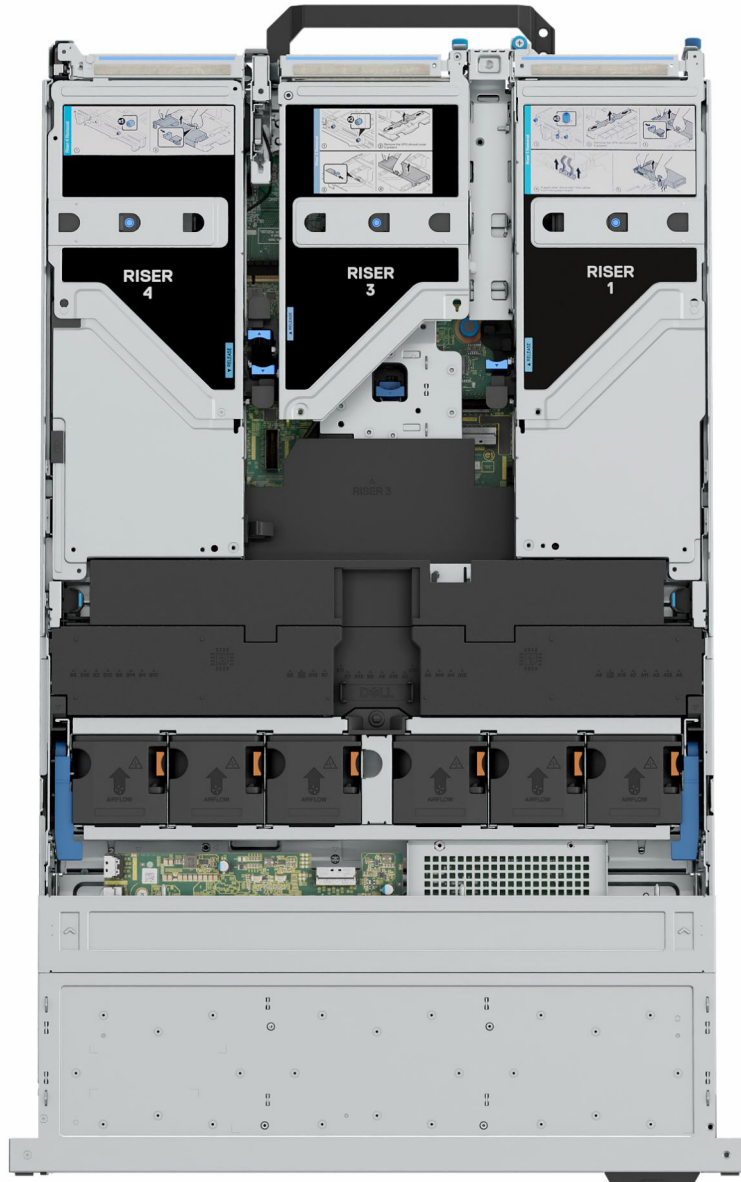

Figure 10. Inside the system with full length risers and GPU shroud

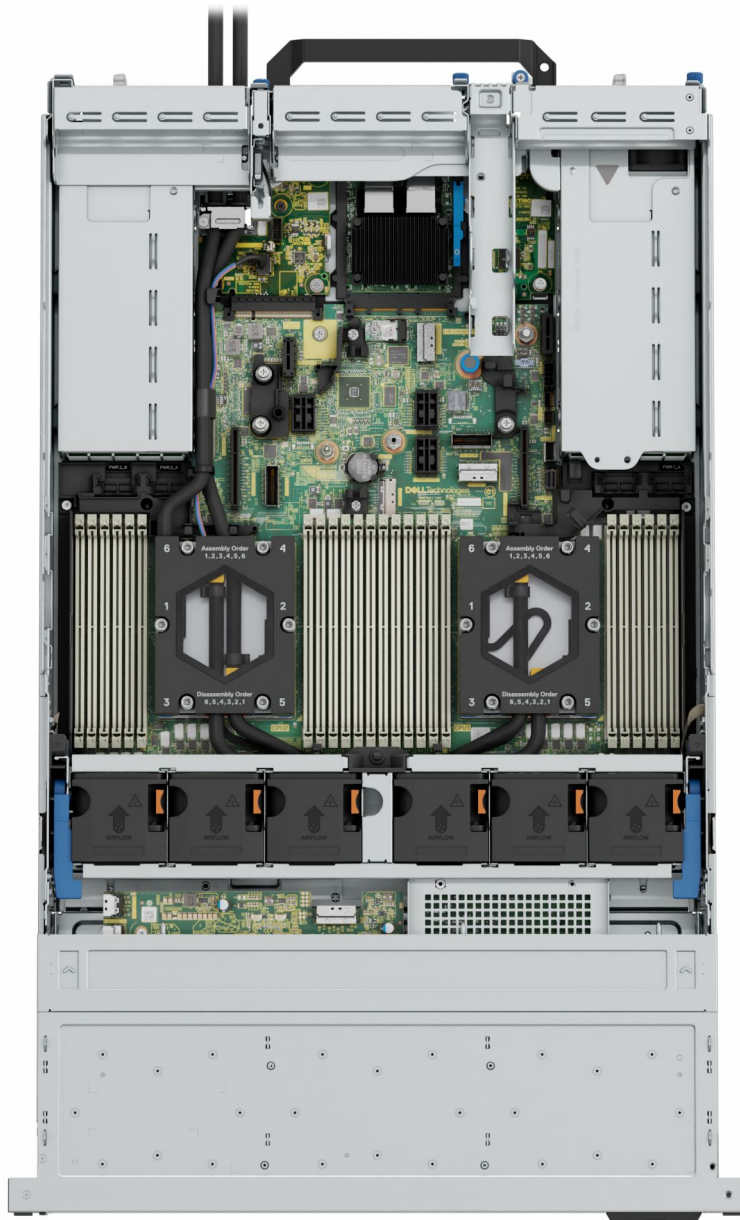

Figure 11. Inside the system with processor liquid cooling module

## Quick Resource Locator

The QRL on everything (SILs, GSG, Installation and Service Manual except on the EST) is a generic QRL for R7625 that leads to a webpage for that product. That webpage has links for things like setup and service videos, iDRAC manual, and other things that apply to the platform. The QRL on the EST is unique and specific to that service tag and will contain the Service Tag number and the iDRAC password. The label and the QRL code within it are printed on demand at the L10 factories. This QRL links to a webpage that shows the exact configuration as built for that customer, and the specific warranty purchased. It is one click away from the same content of generic information that applies to R7625 that is available in the other QRLs.



Figure 12. R7625 Quick Resource Locator

# Processor

## Topics:

- Processor features

## Processor features



The AMD EPYC™9004 Series Processor ("Genoa") is the 4th Generation AMD EPYC™ System on a chip (SOC) supporting the modern data center. The AMD EPYC™ 9004 Series Processor is based on AMD's SP5 compatible socket infrastructure with a new BIOS. AMD EPYC™9004 Series Processor is not drop-in compatible to AMD's SP3 socket infrastructure for EPYC™ Series 7002 ("Rome") and 7003 ("Milan") Processors. Based on AMD's "Zen4" and "Zen4c" cores, integrated I/O controllers, up to 32 MB of L3 cache per core, advanced security, and synchronized fabric and memory clock speeds, "Genoa" is designed for improved performance, lower TCO, and faster time to results with next gen technologies.

The following lists the features and functions included in the AMD Genoa offering:

- Supports up to 128 AMD Zen4c cores, 96 AMD Zen4 x86 cores with enhance performance with 32 MB L3 cache/core. Integrated I/O support for up to 128 lanes with PCI Express 5 on Dell platforms (AMD support up to 160 I/O lanes with 2P).
- Enhanced Memory Performance with support up to 4800 MT/s DIMMs (1 DPC), 3DS RDIMM support. Enhanced Memory Performance with: Infinity Fabric™ and Memory Clock Synchronized. Largest Available x86 L3 Cache –Up to 32 MB / core.
- Memory Capacity up to 12 channels DDR5 and up to 256 GB/channel support with 2, 4, 6, 8, 10 and 12 channel performance optimization options.
- Enhanced physical and virtual security with AMD Infinity Guard that includes silicon embedded security and virtual features (Secure Memory Encryption and Secure Encrypted Virtualization-Secure Nested Paging (SEV-SNP) to further improve platform and data security capabilities.

## Supported processors

**Table 3. Supported processor for the PowerEdge R7625**

Processor model number	Base frequency in GHz	Cores/Threads	Default TDP in W	cTDP in W	L3 Cache in MB	Max DDR frequency (1 DPC) MT/s
9754	2.25	128/256	360	360 - 400	256	4800
9734	2.20	112/224	340	340 - 400	256	4800
9654	2.40	96/192	360	320 - 400	384	4800
9634	2.25	84/168	290	240 - 300	384	4800
9554	3.10	64/128	360	320 - 400	256	4800



**Table 3. Supported processor for the PowerEdge R7625 (continued)**

Processor model number	Base frequency in GHz	Cores/Threads	Default TDP in W	cTDP in W	L3 Cache in MB	Max DDR frequency (1 DPC) MT/s
9534	2.45	64/128	280	240 - 300	256	4800
9454	2.75	48/96	290	240 - 300	256	4800
9354	3.25	32/64	280	240 - 300	256	4800
9334	2.70	32/64	210	200 - 240	128	4800
9254	2.90	24/48	200	200 - 240	128	4800
9224	2.50	24/48	200	200 - 240	64	4800
9124	3.00	16/32	200	200 - 240	64	4800
9474F	3.60	48/96	360	360 - 320	256	4800
9374F	3.85	32/64	320	320 - 320	256	4800
9274F	4.05	24/48	320	320 - 320	256	4800
9174F	4.10	16/32	320	320 - 320	256	4800

 **NOTE:** The processors are 12 channel and has a maximum frequency of 4800 MT/s (1DPC).

# Memory subsystem

## Topics:

- Supported memory

## Supported memory

The R7625 supports up to 24 DIMMs (12 per socket), with up to 6 TB of memory and speeds of up to 4800 MT/s.

The R7625 support registered (RDIMMs) which use a buffer to reduce memory loading and provide greater density, allowing for the maximum platform memory capacity. Unbuffered DIMMs (UDIMMs) are not supported.

**Table 4. Memory technology comparison**

Feature	PowerEdge R7625 (DDR5)
DIMM type	RDIMM
Transfer speed	4800 MT/s (1DPC)
Voltage	1.1 V

**Table 5. Supported DIMMs**

DIMM PN	DIMM Speed (MT/s)	DIMM Type	DIMM Capacity (GB)	Ranks per DIMM	Data Width	DIMM Volts (V)
1V1N1	4800	DDR5 RDIMM	16	1	x8	1.1
W08W9	4800	DDR5 RDIMM	32	2	x8	1.1
J52K5	4800	DDR5 RDIMM	64	2	x4	1.1
MMWR9	4800	DDR5 RDIMM	128	4	x4	1.1
PCFCR	4800	DDR5 RDIMM	256	8	x4	1.1

# Storage

## Topics:

- Storage controllers
- Supported Drives
- Internal storage configuration
- External Storage

## Storage controllers

Dell's RAID controller options offer performance improvements, including the fPERC solution. fPERC provides a base RAID HW controller without consuming a PCIe slot by using a small form factor and high-density connector to the base planar. 16G PERC Controller offerings will be a heavy leverage of 15G PERC family. The Value and Value Performance levels will carry over to 16G from 15G. New to 16G, is the Harpoon-based Premium Performance tier offering. This high-end offering will drive IOPs performance and enhanced SSD performance.

**Table 6. PERC Series controller offerings**

Performance Level	Controller and Description
Entry	S160
Value	H355, HBA355i
Premium Performance	H755, H755N, H965i
External Controllers	HBA355E

**NOTE:** For more information on the features of the Dell PowerEdge RAID controllers (PERC), Software RAID controllers, or BOSS card, and on deploying the cards, see the storage controller documentation at [www.dell.com/storagecontrollermanuals](http://www.dell.com/storagecontrollermanuals).

## Supported Drives

The table shown below lists the internal drives supported by the R7625. Refer to Agile for the latest SDL.

**Table 7. Supported Drives**

Form Factor	Type	Speed	Rotational Speed	Capacities
2.5 inches	SAS	12Gb	7.2K	2 TB, 4 TB, 8 TB, 12 TB, 16 TB, 20 TB
2.5 inches	SAS	12Gb	10K	600 GB, 1.2 TB, 2.4 TB
3.5 inches	SATA	6Gb	7.2K	2 TB, 4 TB, 8 TB, 12 TB, 16 TB, 20 TB
2.5 inches	vSAS SSD	12Gb	N/A	960 GB, 1.92 TB, 3.84 TB, 7.68 TB
2.5 inches	SAS SSD	24Gb	N/A	800 GB, 960 GB, 1.6 TB, 1.92 TB, 3.84 TB, 7.68 TB
2.5 inches	SATA SSD	6Gb	N/A	480 GB, 960 GB, 1.92 TB, 3.84 TB
2.5 inches	NVMe SSD	Gen4	N/A	400 GB, 800 GB, 1.6 TB, 1.92 TB, 3.2 TB, 3.84 TB, 6.4 TB, 7.68 TB, 15.36 TB

**Table 7. Supported Drives (continued)**

Form Factor	Type	Speed	Rotational Speed	Capacities
2.5 inches	DC NCM SSD	Gen4	N/A	960 GB, 3.84 TB

## Internal storage configuration

**Table 8. Internal Storage Configuration Matrix**

Total HDD/ SSD (not BOSS)	NVMe Enabled / Universal Slots	16G Storage Front	Rear Storage	PERC Qty	Storage Controller(s)	Controller Form Factor
0*	0 / 0	N/A	N/A	0	N/A	N/A
8	0 / 0	8x 3.5" SAS3/SATA	N/A	1	HBA355iF/H355F	Front PERC
12	0 / 0	12x 3.5" SAS3/SATA	N/A	1	HBA355i / H355 / H755	PERC Adapter
14	0 / 0	12x 3.5" SAS3/SATA	Rear 2x2.5" univ SAS4	1	HBA355i / H355 / H755	PERC Adapter
14	0 / 0	12x 3.5" SAS3/SATA	Rear 2x2.5" univ SAS4	1	H965i	PERC Adapter
16	0 / 0	12x 3.5" SAS3/SATA	Rear 4x2.5" univ SAS4	1	HBA355i / H355 / H755	PERC Adapter
16	0 / 0	12x 3.5" SAS3/SATA	Rear 4x2.5" univ SAS4	1	H965i	PERC Adapter
12	0 / 0	12x 3.5" SAS3/SATA	N/A	1	HBA355	PERC Adapter
16	0 / 0	12x 3.5" SAS3/SATA	4x Rear E3 G5x4	1	HBA355i/HBA355/H755/S160	PERC Adapter
8	8 / 0	8x U.2 G4	N/A	0	S160 _NVMe	N/A
8	8 / 0	8x U.2 G4	N/A	1	H755N F	Front PERC
8	8 / 0	8x U.2 G4	N/A	1	H965i F	Front PERC
8	0 / 8	8x 2.5" Universal	N/A	1	HBA355i F/H355 F/H755 F/S160	Front PERC
16	0 / 0	16x 2.5" SAS4/SATA	N/A	1	HBA355i F/H355 F/H755 F	Front PERC
16	0 / 0	16x 2.5" SAS4/SATA	N/A	1	H965i F	Front PERC
16	16 / 0	16x U.2 G4	N/A	0	S160	N/A
16	16 / 0	16x U.2 G4	N/A	2	H755N F	Front PERC
16	16 / 0	16x U.2 G4	N/A	2	H965i F	Front PERC
24	8 / 0	16x 2.5" SAS4/SATA + 8x U.2 G4	N/A	1	HBA355i F/H355 F/H755 F/S160	Front PERC
24	8 / 0	16x 2.5" SAS4/SATA + 8x U.2 G4	N/A	1	H965i Adpt/S160	PERC Adapter
24	0 / 0	24x 2.5" SAS4/SATA	N/A	1	HBA355i F/H355 F/H755 F	Front PERC
24	0 / 0	24x 2.5" SAS4/SATA	N/A	1	H965i F	Front PERC

**Table 8. Internal Storage Configuration Matrix (continued)**

Total HDD/SSD (not BOSS)	NVMe Enabled / Universal Slots	16G Storage Front	Rear Storage	PERC Qty	Storage Controller(s)	Controller Form Factor
24	0 / 8	24x 2.5" SAS4/SATA	N/A	1	HBA355i F/H355 F/H755 F	Front PERC
24	0 / 6	24x 2.5" SAS4/SATA	N/A	1	H965i F	Front PERC
26	0 / 0	24x 2.5" SAS4/SATA	Rear 2x2.5" univ SAS4	1	HBA355i F/H355 F/H755 F	Front PERC
26	0 / 0	24x 2.5" SAS4/SATA	Rear 2x2.5" univ SAS4	1	H965i F	Front PERC
26	2 / 0	24x 2.5" SAS4/SATA	Rear 2x2.5" univ SAS4	1	HBA355i F/H355 F/H755 F	Front PERC
26	2 / 0	24x 2.5" SAS4/SATA	Rear 2x2.5" univ SAS4	1	H965i F	Front PERC
28	0 / 0	24x 2.5" SAS4/SATA	Rear 4x2.5" univ SAS4	1	HBA355i F/H355 F/H755 F	Front PERC
28	0 / 0	24x 2.5" SAS4/SATA	Rear 4x2.5" univ SAS4	1	H965i F	Front PERC
28	4 / 0	24x 2.5" SAS4/SATA	Rear 4x2.5" univ SAS4	1	HBA355i F/H355 F/H755 F/S160	Front PERC
28	4 / 0	24x 2.5" SAS4/SATA	Rear 4x2.5" univ SAS4	1	H965i F/S160	Front PERC
24	24 / 0	24x U.2 G5 Switched	N/A	0	S160	N/A
24	24 / 0	24x U.2 G5 Switched	N/A	2	H965i F	Front PERC
16	16 / 0	16x E3.S G4 Ortho	N/A	2	H755N F	Front PERC
16	16 / 0	16x E3.S G4 Ortho	N/A	2	H965i F	Front PERC
32	32 / 0	32x E3.S G5 Ortho	N/A	0	S160	N/A
36	36 / 0	32x E3.S G5 Ortho	4x E3 G5 Rear Ortho	0	S160	N/A
8	8 / 0	8x E3.S G5 Ortho	N/A	0	S160	N/A
16	16 / 0	16x E3.S G5 Ortho	N/A	0	S160	N/A
20	20 / 0	16xE3.S (NVMe G5) +4x SCM E3.S 2T	N/A	0	S160	N/A

**i** | **NOTE:** \*BOSS/IDSMD Mandatory: All other configurations support optional BOSS/IDSMD.

## External Storage

The R7625 support the external storage device types listed in the table below.

**Table 9. Support for External Storage Devices**

Device Type	Description
External Tape	Supports connection to external USB tape products
NAS/IDM appliance software	Supports NAS software stack

**Table 9. Support for External Storage Devices (continued)**

<b>Device Type</b>	<b>Description</b>
JBOD	Supports connection to 12Gb MD-series JBODs

# Networking

## Topics:

- [Overview](#)
- [OCP 3.0 support](#)

## Overview

PowerEdge offers a wide variety of options to get information moving to and from our servers. Industry best technologies are chosen, and systems management features are added by our partners to firmware to tie in with iDRAC and Lifecycle Controller. These adapters are rigorously validated for worry-free, fully supported use in our servers.

## OCP 3.0 support

**Table 10. OCP 3.0 feature list**

Feature	OCP 3.0
Form factor	SFF
PCIe Gen	Gen4
Max PCIe width	x8
Max no.of ports	4
Port type	BT/SFP+/SFP28
Max port speed	25 GbE
NC-SI	Yes
SNAPI	Yes
WoL	Yes
Power consumption	35 W

## Supported OCP cards

**Table 11. R7625 OCP 3.0 support list 2**

Form Factor	DPN	Vendor	# of ports	Max Port speed	Port type	SNAPI	WOL	Max PCIe width	PCIe Gen
OCP 3.0	9M6PR	Broadcom	2	100GbE	QSFP56	No	Yes	X16	Gen4
OCP 3.0	V23H0	Broadcom	4	25GbE	SFP28	No	Yes	X16	Gen4
OCP 3.0	VMFKR	Intel	2	10GbE	BT	No	Yes	X8	Gen3
OCP 3.0	50RV4	Intel	4	10GbE	BT	No	Yes	X8	Gen3
OCP 3.0	YJYK1	Intel	2	10GbE	SFP+	No	Yes	X8	Gen3
OCP 3.0	VF81P	Intel	4	10GbE	SFP+	No	Yes	X8	Gen3

**Table 11. R7625 OCP 3.0 support list 2 (continued)**

Form Factor	DPN	Vendor	# of ports	Max Port speed	Port type	SNAPI	WOL	Max PCIe width	PCIe Gen
OCP 3.0	G9XC9	Broadcom	4	1GbE	BT	No	Yes	X4	Gen2
OCP 3.0	T6HR8	Broadcom	2	10GbE	BT	No	Yes	X8	Gen3
OCP 3.0	6JKXY	Broadcom	2	10GbE	SFP+	No	Yes	X8	Gen3
OCP 3.0	NHN45	Broadcom	2	25GbE	SFP28	No	Yes	X8	Gen3
OCP 3.0	JTK7F	Broadcom	4	25GbE	SFP28	Yes	Yes	X8	Gen3
OCP 3.0	42T22	QLogic	2	10GbE	BT	No	Yes	X8	Gen3
OCP 3.0	RHVFN	QLogic	2	10GbE	SFP+	No	Yes	X8	Gen3
OCP 3.0	NP0K8	QLogic	2	25GbE	SFP28	No	Yes	X8	Gen3
OCP 3.0	GJJG2	QLogic	4	10GbE	BT	No	Yes	X8	Gen3
OCP 3.0	47W4V	QLogic	4	10GbE	SFP+	No	Yes	X8	Gen3
OCP 3.0	4TRD3	Mellanox	2	25GbE	SFP28	Yes	Yes	X16	Gen3
OCP 3.0	TTKWY	SolarFlare	2	25GbE	SFP28	No	Yes	X16	Gen3
OCP 3.0	8HRW3	SolarFlare	2	25GbE	SFP28	No	Yes	X16	Gen3
OCP 3.0	WW2NX	Intel	4	1GbE	BT	No	Yes	X4	Gen2

## OCP NIC 3.0 vs. rack Network Daughter Card comparisons

**Table 12. OCP 3.0, 2.0, and rNDC NIC comparison**

Form Factor	Dell rNDC	OCP 2.0 (LOM Mezz)	OCP 3.0	Notes
PCIe Gen	Gen 3	Gen 3	Gen 4	Supported OCP3 are SFF (small form factor)
Max PCIe Lanes	x8	Up to x16	Up to x8	See server slot priority matrix
Shared LOM	Yes	Yes	Yes	This is iDRAC port redirect
Aux Power	Yes	Yes	Yes	Used for Shared LOM



# PCIe subsystem

## Topics:

- PCIe risers

## PCIe risers

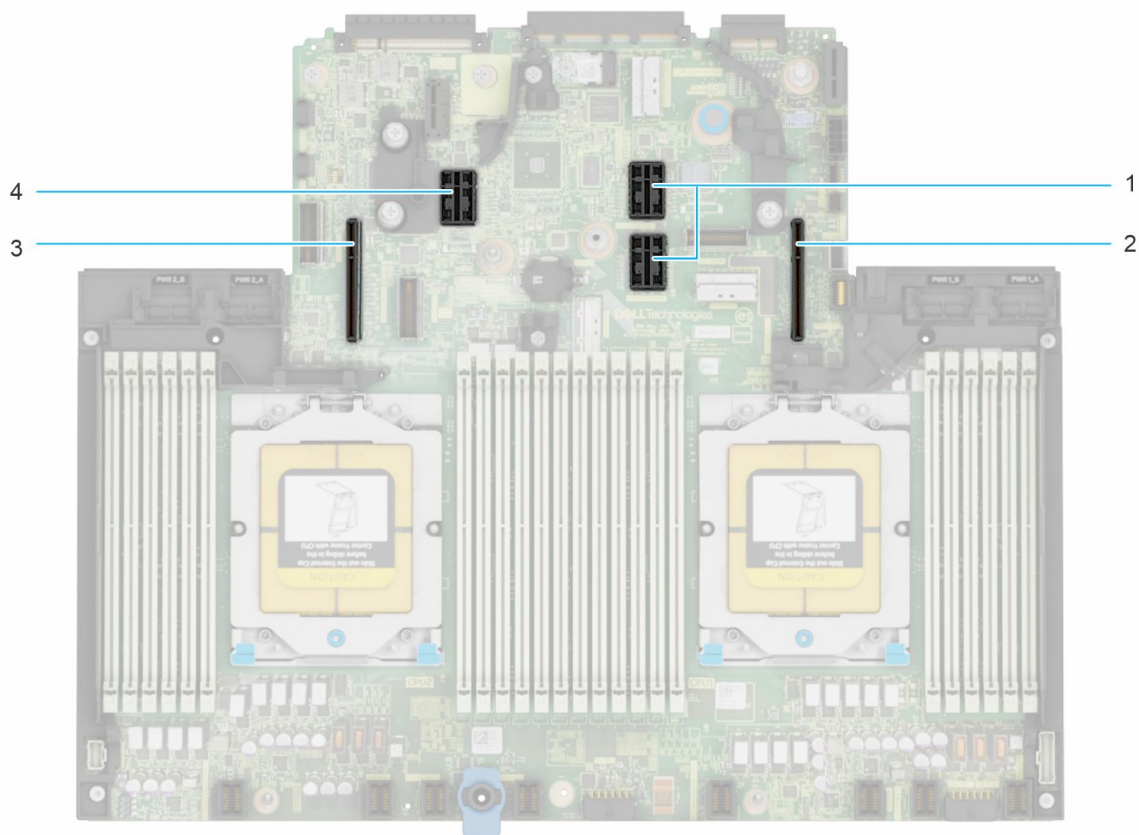
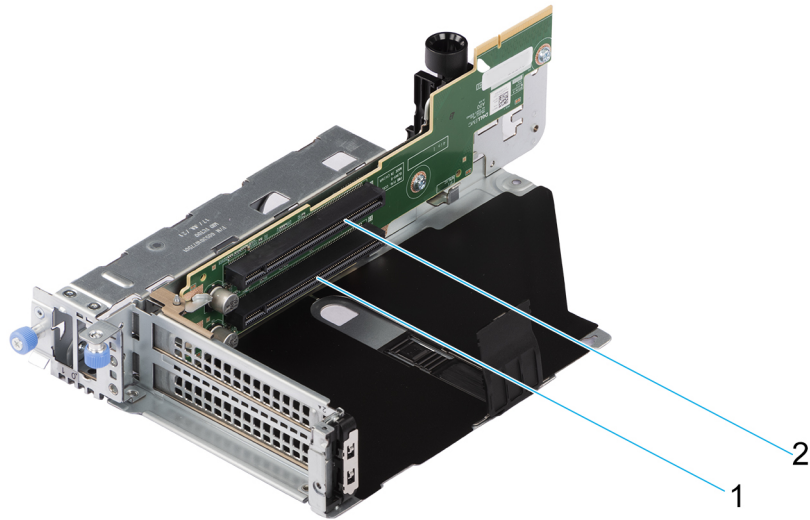

Figure 13. Expansion card riser slot connectors

1. Riser 2
2. Riser 1
3. Riser 4
4. Riser 3



**Figure 14. Riser 1B**

1. Slot 1
2. Slot 2

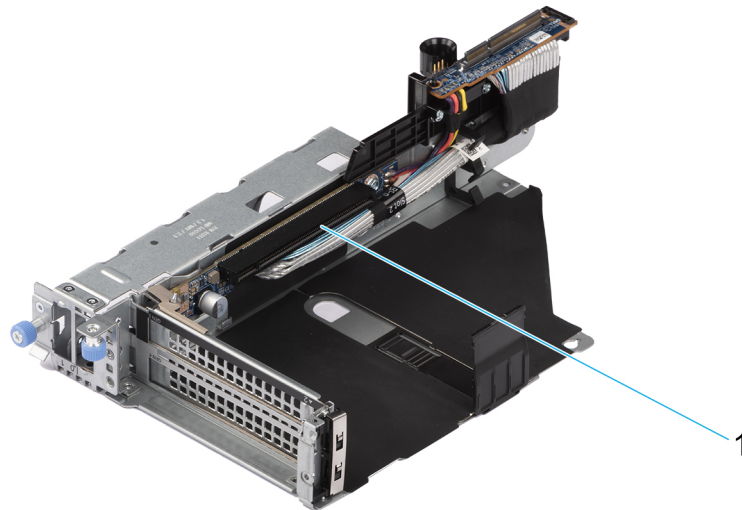

**Figure 15. Riser 1P HL**

1. Slot 2

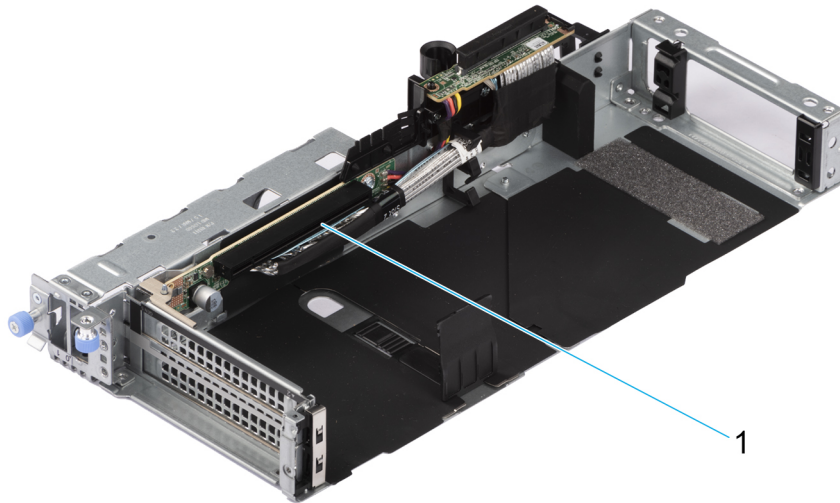

**Figure 16. Riser 1P FL**

- 1. Slot 2

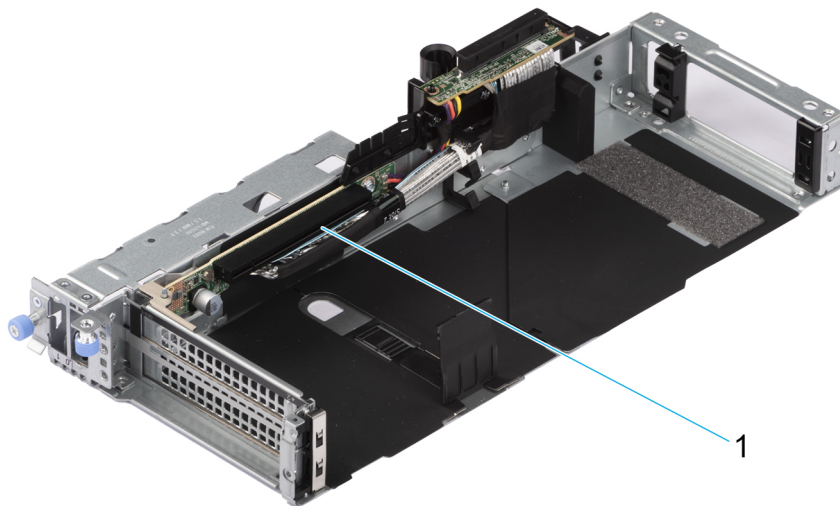

**Figure 17. Riser 1Q**

- 1. Slot 2

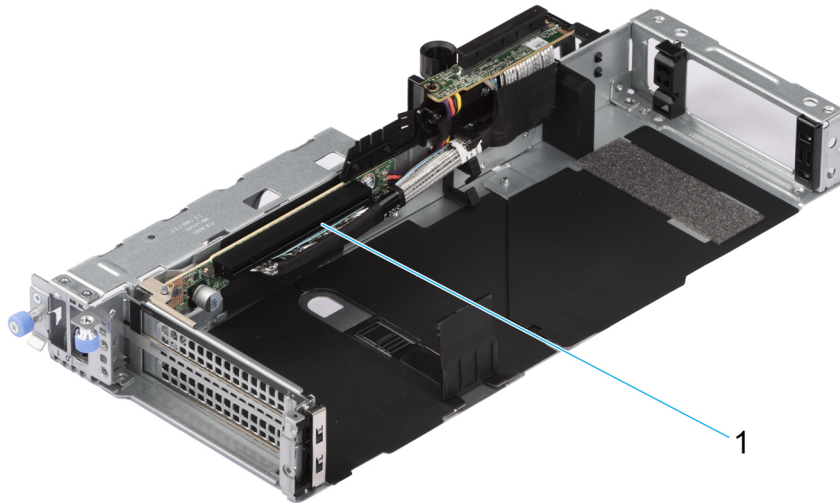

**Figure 18. Riser 1S FL**

- 1. Slot 2

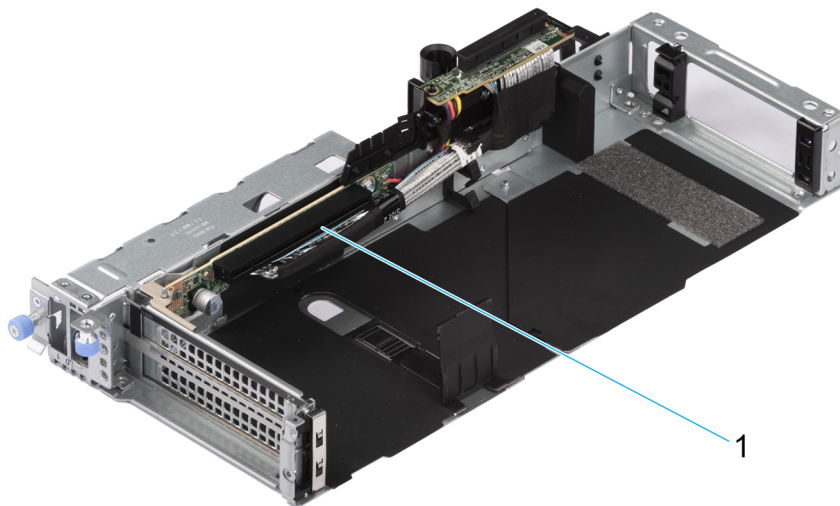

**Figure 19. Riser 1S HL**

- 1. Slot 2

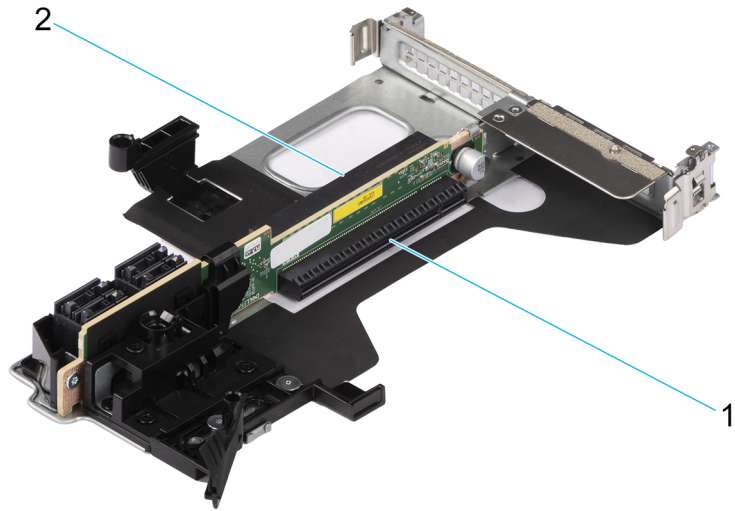

**Figure 20. Riser 2A**

- 1. Slot 6
- 2. Slot 3

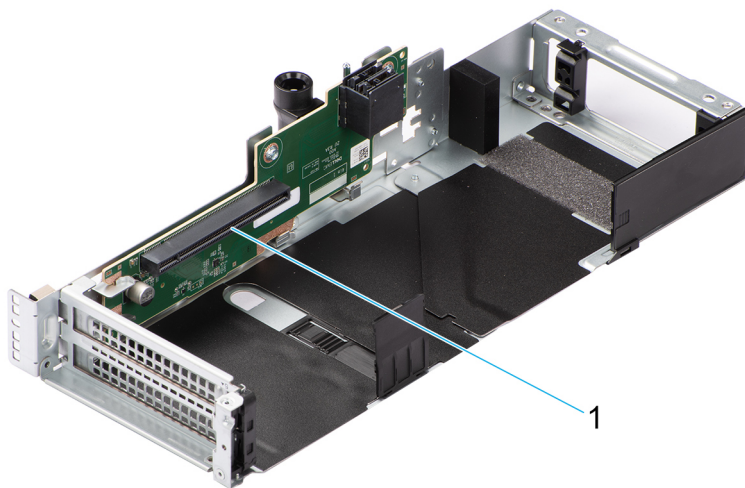

**Figure 21. Riser 3A FL**

- 1. Slot 5

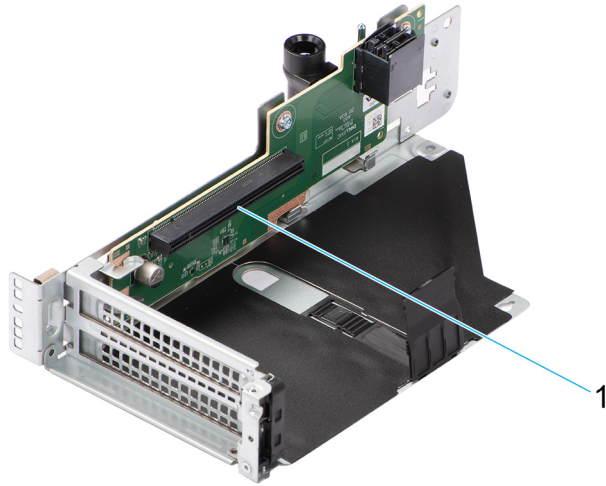

**Figure 22. Riser 3A HL**

1. Slot 5

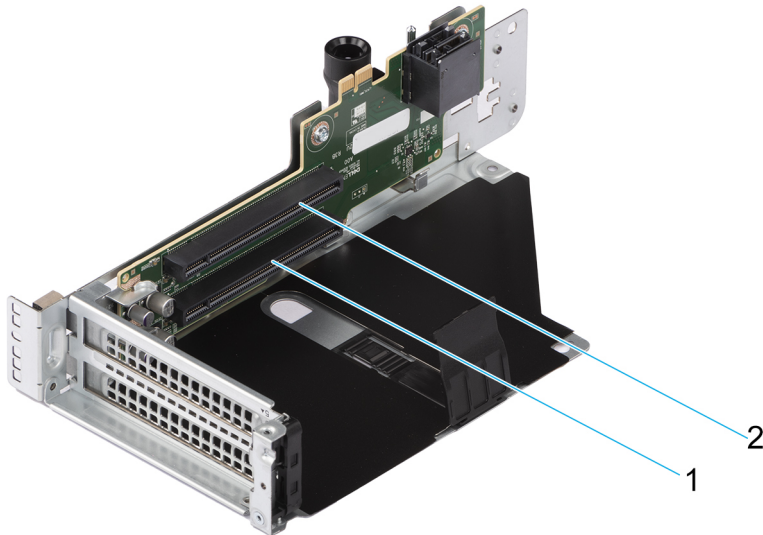

**Figure 23. Riser 3B**

1. Slot 4
2. Slot 5

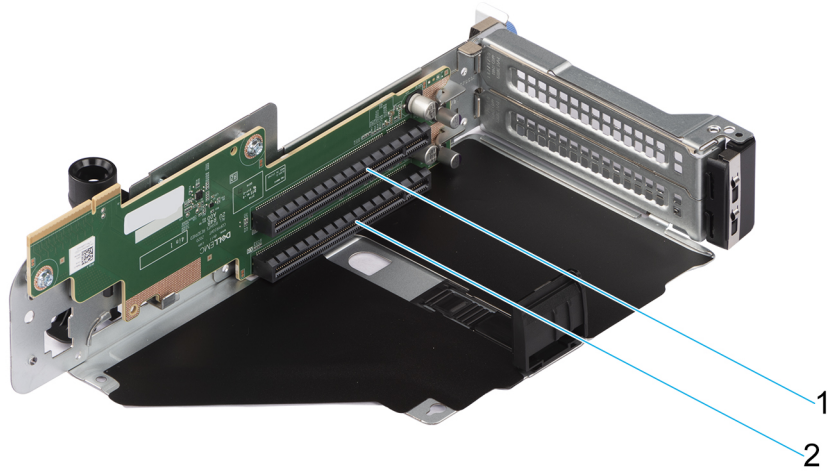

**Figure 24. Riser 4B**

- 1. Slot 8
- 2. Slot 7

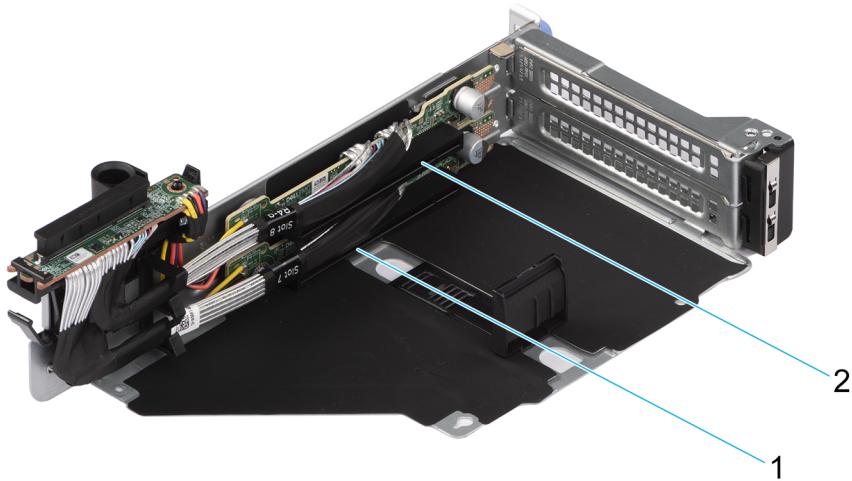

**Figure 25. Riser 4Q**

- 1. Slot 7
- 2. Slot 8

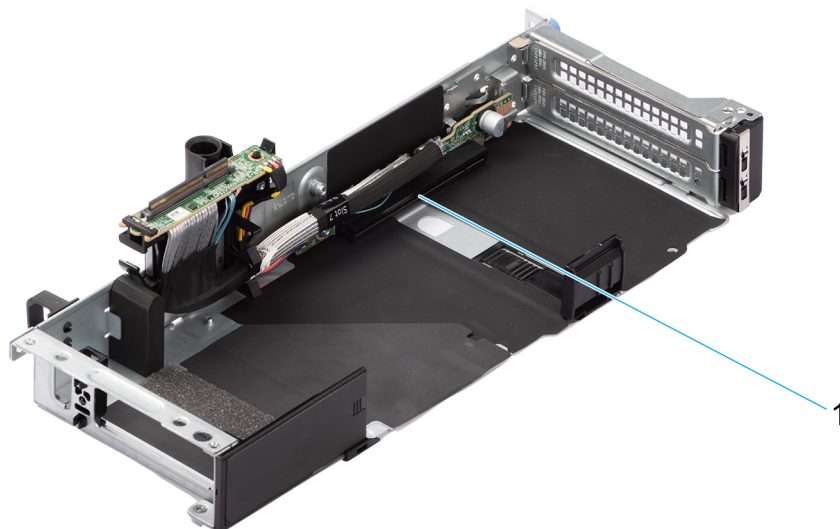

**Figure 26. Riser 4P FL**

1. Slot 7

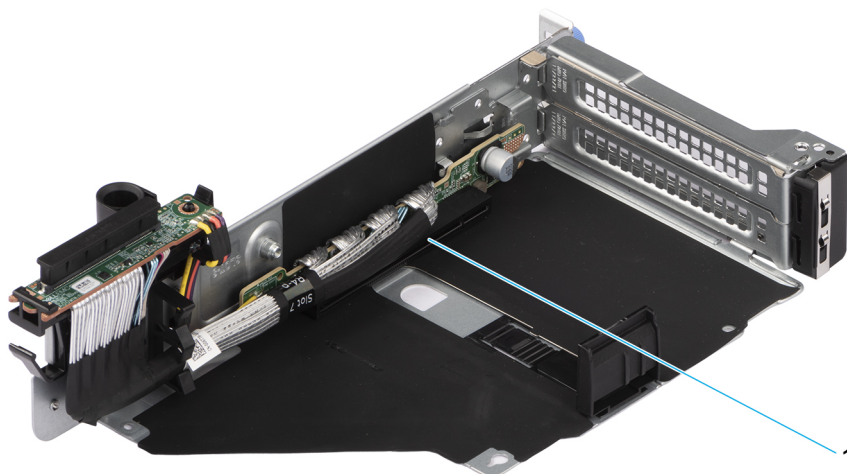

**Figure 27. Riser 4P HL**

1. Slot 7

**Table 13. PCIe Riser Configs**

Config #	RSR Configuration	# of CPUs	PERC type supported	Rear Storage Possible	x8 CPU 1	x16 CPU 1	x8 CPU 2	x16 CPU 2
0	0	2	Front PERC	No	0	0	0	0
1	R1B + R4B	2	Front PERC	No	2	0	2	0
2	R1B + R2A + R3B + R4B	2	Front PERC / Adaptor PERC	No	2	1	4	1
3	R1Q + R2A + R3B + R4Q	2	Front PERC / Adaptor PERC	No	2	1	4	1
4	R1P + R2A + R3B + R4P	2	Front PERC / Adaptor PERC	No	0	2	2	2
5	R1S + R2A + R3A + R4P	2	Front PERC	No	0	3	0	3



**Table 13. PCIe Riser Configs (continued)**

Config #	RSR Configuration	# of CPUs	PERC type supported	Rear Storage Possible	x8 CPU 1	x16 CPU 1	x8 CPU 2	x16 CPU 2
6	R2A + R4Q	2	Front PERC / Adaptor PERC	Yes	0	1	2	1
7	R1Q + R2A + R4Q	2	Front PERC / Adaptor PERC	Yes	2	1	2	1
8	U.2 R1 Paddle card + R2A + R3B + R4D Paddle card	2	No	No	0	2	2	2
9	R1B + R2A	1	Adaptor PERC	No	2	1	0	0
10	R2A + R3B	2	Front PERC / Adaptor PERC	Yes	0	1	2	1
11	R1-E3 Paddle card + R2A + R3B + 2U R4-E3 Paddle card	2	No	Yes	0	2	2	2
12	R1-E3X4 Paddle card+R2A+R3B +R4-E3 Paddle card	2	No	Yes	0	2	2	2
13	R1-E3 Paddle card+R2A+R3B +R4-SCMX4 Paddle card	2	No	Yes	0	2	2	2

# Power, thermal, and acoustics

PowerEdge servers have an extensive collection of sensors that automatically track thermal activity, which helps regulate temperature thereby reducing server noise and power consumption. The table below lists the tools and technologies Dell offers to lower power consumption and increase energy efficiency.

## Topics:

- [Power](#)
- [Thermal](#)
- [Acoustics](#)

## Power

**Table 14. Power tools and technologies**

Feature	Description
Power Supply Units(PSU) portfolio	Dell's PSU portfolio includes intelligent features such as dynamically optimizing efficiency while maintaining availability and redundancy. Find additional information in the Power supply units section.
Tools for right sizing	Enterprise Infrastructure Planning Tool (EIPT) is a tool that can help you determine the most efficient configuration possible. With Dell's EIPT, you can calculate the power consumption of your hardware, power infrastructure, and storage at a given workload. Learn more at <a href="http://www.dell.com/calc">www.dell.com/calc</a> .
Industry Compliance	Dell's servers are compliant with all relevant industry certifications and guide lines, including 80 PLUS, Climate Savers and ENERGY STAR.
Power monitoring accuracy	PSU power monitoring improvements include: <ul style="list-style-type: none"> <li>• Dell's power monitoring accuracy is currently 1%, whereas the industry standard is 5%</li> <li>• More accurate reporting of power</li> <li>• Better performance under a power cap</li> </ul>
Power capping	Use Dell's systems management to set the power cap limit for your systems to limit the output of a PSU and reduce system power consumption. Dell is the first hardware vendor to leverage Intel Node Manager for circuit-breaker fast capping.
Systems Management	iDRAC Enterprise and Datacenter provides server-level management that monitors, reports and controls power consumption at the processor, memory and system level.  Dell OpenManage Power Center delivers group power management at the rack, row, and data center level for servers, power distribution units, and uninterruptible power supplies.
Active power management	Intel Node Manager is an embedded technology that provides individual server-level power reporting and power limiting functionality. Dell offers a complete power management solution comprised of Intel Node Manager accessed through Dell iDRAC9 Datacenter and OpenManage Power Center that allows policy-based management of power and thermal at the individual server, rack, and data center level. Hot spare reduces power consumption of redundant power supplies. Thermal control off a speed optimizes the thermal settings for your environment to reduce fan consumption and lower system power consumption.  Idle power enables Dell servers to run as efficiently when idle as when at full workload.
Fresh Air cooling	Refer to ASHRAE A3/A4 Thermal Restriction.

**Table 14. Power tools and technologies (continued)**

Feature	Description
Rack infrastructure	<p>Dell offers some of the industry's highest-efficiency power infrastructure solutions, including:</p> <ul style="list-style-type: none"> <li>• <a href="#">Power distribution units (PDUs)</a></li> <li>• <a href="#">Uninterruptible power supplies (UPSs)</a></li> <li>• <a href="#">Energy Smart containment rack enclosures</a></li> </ul> <p>Find additional information at: <a href="https://www.delltechnologies.com/en-us/servers/power-and-cooling.htm">https://www.delltechnologies.com/en-us/servers/power-and-cooling.htm</a>.</p>

## Power Supply Units

Energy Smart power supplies have intelligent features, such as the ability to dynamically optimize efficiency while maintaining availability and redundancy. Also featured are enhanced power-consumption reduction technologies, such as high efficiency power conversion and advanced thermal-management techniques, and embedded power-management features, including high-accuracy power monitoring. The table below shows the power supply unit options that are available for the R7625.

**Table 15. Power supply Unit Options**

Wattage	Frequency	Voltage	Class	Heat dissipation
800 W Mixed Mode	50/60Hz	100~240 V AC 9.2-4.7 A	Platinum	3000 BTU/hr
	N/A	240 V DC 3.8 A	N/A	3000 BTU/hr
1100 W Mixed Mode	50/60Hz	100~240 Vac 12-6.3 A	Titanium	4125 BTU/hr
	N/A	240 V DC 5.2 A	N/A	4125 BTU/hr
1400 W Mixed Mode	50/60Hz	100~240 Vac 12-8 A	Platinum	5250 BTU/hr
	N/A	240 V DC 6.6 A	N/A	5250 BTU/hr
1800 W Mixed Mode	50/60Hz	200~240 Vac 10 A	Titanium	6610 BTU/hr
	N/A	240 V DC 8.2 A	N/A	6610 BTU/hr
2400 W Mixed Mode	50/60Hz	100~240 V AC 16-13.5 A	Platinum	9000 BTU/hr
	N/A	240 V DC 11.2 A	N/A	9000 BTU/hr

**Table 15. Power supply Unit Options (continued)**

Wattage	Frequency	Voltage	Class	Heat dissipation
2800 W Mixed Mode	50/60Hz	200~240 Vac 15.6 A	Titanium	10500 BTU/hr
	N/A	240 V DC 13.6 A	N/A	10500 BTU/hr
1100 W DC	N/A	240 V DC 27 A	N/A	4265 BTU/hr

**NOTE:** If a system with AC 2400W PSUs operates at low line 100-120 V AC, then the power rating per PSU is derated to 1400W.

**NOTE:** If a system with AC 1400W/1100W PSUs operates at low line 100-120 V AC, then the power rating per PSU is derated to 1050W.



**Figure 28. PSU power cords**

**Table 16. PSU power cords**

Form factor	Output	Power cord
Redundant 60 mm	800 W AC	C13
	1100 W AC	C13
	1100 W -48 LVDC	C13
	1400 W AC	C13
	1800 W AC	C15
Redundant 86 mm	2400 W AC	C19
	2800 W AC	C21

**NOTE:** C19 power cord combined with C20 to C21 jumper power cord can be used to adapt 2800 W PSU.

**NOTE:** C13 power cord combined with C14 to C15 jumper power cord can be used to adapt 1800 W PSU.

## Thermal

PowerEdge servers have an extensive collection of sensors that automatically track thermal activity, which helps regulate temperature thereby reducing server noise and power consumption.

## Thermal design

Thermal management of the platform helps deliver high performance with the right amount of cooling to components, while maintaining the lowest fan speeds possible. This is done across a wide range of ambient temperatures from 10°C to 35°C (50°F to 95°F) and to extended ambient temperature ranges.

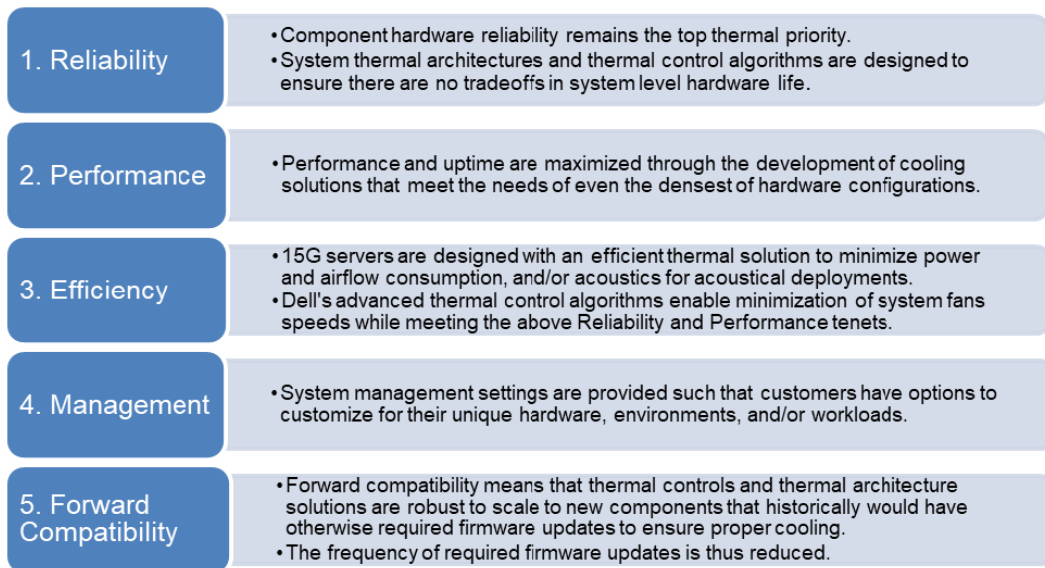

Figure 29. Thermal design characteristics

The thermal design of the PowerEdge R7625 reflects the following:

- Optimized thermal design: The system layout is architected for optimum thermal design.
- System component placement and layout are designed to provide maximum airflow coverage to critical components with minimum expense of fan power.
- Comprehensive thermal management: The thermal control system regulates the fan speed based on several different responses from all system-component temperature sensors, as well as inventory for system configurations. Temperature monitoring includes components such as processors, DIMMs, chipset, the inlet air ambient, hard disk drives, and OCP.
- Open and closed loop thermal fan speed control: Open loop thermal control uses system configuration to determine fan speed based on inlet air ambient temperature. Closed loop thermal control method uses feedback temperatures to dynamically determine proper fan speeds.
- User-configurable settings: With the understanding and realization that every customer has unique set of circumstances or expectations from the system, in this generation of servers, we have introduced limited user-configurable settings residing in the iDRAC "BIOS setup" screen. For more information, see the Dell PowerEdge R7625 Installation and Service Manual at [www.dell.com/poweredgemanuals](http://www.dell.com/poweredgemanuals) and "Advanced Thermal Control: Optimizing across Environments and Power Goals" on Dell.com.
- Cooling redundancy: The R7625 allows N+1 fan redundancy, allowing continuous operation with one fan failure in the system.
- Cooling redundancy: The R7625 with >4 fans allows N+1 fan redundancy, allowing continuous operation with one fan failure in the system.
- Environmental Specifications: The optimized thermal management makes the R7625 reliable under a wide range of operating environments.

## Acoustics

### Acoustical configurations of R7625

Dell PowerEdge R7625 is a rack-mount server for which acoustical output ranges from that appropriate for an office to that of data centers. Acoustical performance is provided in terms of five configuration: Minimum, Typical-1, Typical-2, GPU and Feature Rich.

Although the R7625 is designed for use in data centers, some users may prefer to use it in a quieter setting.

**Table 17. Configurations tested for acoustical experience**

Configuration	Minimum	Typical-1, 2.5-inch	Typical-2, 3.5-inch	GPU configuration	Feature Rich
CPU Type	AMD	AMD	AMD	AMD	AMD
CPU TDP / Cores	200 W / 24C	200 W / 24C	200 W / 24C	260 W / 32C	320 W / 32C
CPU Quantity	2	2	2	2	2
RDIMM Memory	16 GB, RDIMM	16 GB, RDIMM	32 GB, RDIMM	32 GB, RDIMM	32 GB, RDIMM
Memory Quantity	6	12	12	24	24
Backplane Type	12 x 3.5-inch BP	8 x 2.5-inch BP	12 x 3.5-inch BP + 4 x E3 rear BP	24 x 2.5-inch exp BP	24 x 2.5-inch exp BP
HDD Type	3.5-inch SATA	2.5-inch SSD	3.5-inch HDD + E3	2.5-inch SSD	2.5-inch SSD
HDD Quantity	1	8	12 x 3.5-inch + 4 x E3	16	24
PSU Type	800 W	800 W	1400 W	2400 W	2400 W
PSU Quantity	2	2	2	2	2
OCP	Dual Port 10 GbE	Dual Port 25 GbE	Dual Port 25 GbE	Dual Port 25 GbE	Dual Port 25 GbE
PCI 1	X	25 Gb PCI	10 Gb PCI	GPU: Double-Wide	100 Gb PCI
PCI 2	X	25 Gb PCI	10 Gb PCI	100 Gb PCI	100 Gb PCI
PCI 3	X	X	X	100 Gb PCI	X
PCI 4	X	X	X	GPU: Double-Wide	X

**Table 18. Acoustical experience of R7625 configurations**

Configuration	Minimum	Typical-1, 2.5-inch	Typical-2, 3.5-inch	GPU configuration	Feature Rich	
Acoustical Performance: Idle/ Operating @ 25°C Ambient						
L <sub>WA,m</sub> (B)	Idle <sup>(4)</sup>	5.0	4.6	6.8	6.7	7.3
	Operating <sup>(5)(6)</sup>	5.4	5.1	6.8	6.7	7.3
K <sub>v</sub> (B)	Idle <sup>(4)</sup>	0.4	0.4	0.4	0.4	0.4
	Operating <sup>(5)(6)</sup>	0.4	0.4	0.4	0.4	0.4
L <sub>pA,m</sub> (dB)	Idle <sup>(4)</sup>	35	32	51	52	57
	Operating <sup>(5)(6)</sup>	39	33	51	52	57
Prominent tones <sup>(3)</sup>	Prominence ratio < 15 dB					
Acoustical Performance: Idle @ 28°C Ambient						
L <sub>WA,m</sub> <sup>(1)</sup> (B)	5.2	4.6	6.9	6.9	7.4	
K <sub>v</sub> (B)	0.4	0.4	0.4	0.4	0.4	
L <sub>pA,m</sub> <sup>(2)</sup> (dB)	37	32	51	55	58	
Acoustical Performance: Max. loading @ 35°C Ambient						
L <sub>WA,m</sub> <sup>(1)</sup> (B)	7.2	6.7	7.9	8.3	8.8	
K <sub>v</sub> (B)	0.4	0.4	0.4	0.4	0.4	
L <sub>pA,m</sub> <sup>(2)</sup> (dB)	57	52	61	69	73	

(1)LwA,m: The declared mean A-weighted sound power level (LwA) is calculated per section 5.2 of ISO 9296 with data collected using the methods described in ISO 7779 (2010). Engineering data presented here may not be fully compliant with ISO 7779 declaration requirements.

(2)LpA,m: The declared mean A-weighted emission sound pressure level is at the bystander position per section 5.3 of ISO 9296 and measured using methods described in ISO 7779. The system is placed in a 24U rack enclosure, 25cm above a reflective floor. Engineering data presented here may not be fully compliant with ISO 7779 declaration requirements.

(3)Prominent discrete tones: Criteria of Annex D of ECMA-74 & Prominence Ratio method of ECMA-418 are followed to determine if discrete tones are prominent and to report them, if so.

(4)Idle mode: Idle mode is the steady-state condition in which the server is energized but not operating any intended function.

(5)Operating mode: Operating mode is represented by the maximum of the steady state acoustical output at 50% of CPU TDP or active storage drives for the respective sections of Annex C of ECMA-74.

## PowerEdge acoustical specifications

Dell typically categorizes servers in categories of acoustically acceptable usage:

- Category 1: Table-top in Office Environment
- Category 2: Floor-standing in Office Environment
- Category 3: General Use Space
- Category 4: Attended Data Center
- Category 5: Unattended Data Center
- Category 6: Data Center Modular/Modular Enclosure

### Category 1: Table-top in Office Environment

When Dell determines that a specific ISG product is to be used on a Table-top in Office Environment, e.g., on a desk around a seated user's head height, then the acoustical specification in the table below applies. Small, light-weight towers are examples of these types of products.

**Table 19. Dell Enterprise Category 1, "Table-top in Office Environment" acoustical specification category**

Measurement Position re AC0158	Metric, re AC0159	Test Modes, re AC0159 (note must be in steady state, see AC0159, except where noted below)			Simulate (that is, set fan speeds representative) for Idle at 28° C & 35° C Ambient, and for 100% loading and maximum configuration, at 35° C Ambient
		Standby in 23±2° C Ambient	Idle in 23±2° C Ambient	Operating in 23±2° C Ambient – if not otherwise specified in the program's configuration document, then processor and hard drive operating modes are required	
Sound Power	LWA,m, B	≤ 4.2	≤ 4.7	≤ 5.0	Report
Sound Quality (both positions must meet limits): Front Binaural HEAD and Rear Microphone	Tones, Hz, dB	No prominent tones per criteria D.10.6 and D.10.8 of ECMA-74			Report tones
	Tonality, tu	≤ 0.35	≤ 0.35	≤ 0.35	Report
	Dell Modulation, %	≤ 35	≤ 35	≤ 35	Report
	Loudness, sones	Report	Report	Report	Report
	LpA-single point, dBA	Report	Report	Report	Report

**Table 19. Dell Enterprise Category 1, "Table-top in Office Environment" acoustical specification category (continued)**

Measurement Position re AC0158	Metric, re AC0159	Test Modes, re AC0159 (note must be in steady state, see AC0159, except where noted below)			Simulate (that is, set fan speeds representative) for Idle at 28° C & 35° C Ambient, and for 100% loading and maximum configuration, at 35° C Ambient
		Standby in 23±2° C Ambient	Idle in 23±2° C Ambient	Operating in 23±2° C Ambient – if not otherwise specified in the program’s configuration document, then processor and hard drive operating modes are required	
Front Binaural HEAD	Transients	<ul style="list-style-type: none"> <li>• Oscillation (see AC0159), if observed, during 20-minute steady-state observation, must adhere to the following two criteria: <ul style="list-style-type: none"> <li>○ Max. {ΔLpA} &lt; 3.0 dB</li> <li>○ Event count &lt; 3 for “1.5 dB &lt; ΔLpA &lt; 3.0 dB”</li> <li>○ Acoustical Jump (see AC0159), during air mover speed transition from Idle to Operating Mode must be ≤ 15dB.</li> </ul> </li> <li>• Startup behavior <ul style="list-style-type: none"> <li>○ Report Startup behavior re. AC0159</li> <li>○ Startup must proceed smoothly, i.e., no sudden or large jumps</li> </ul> </li> <li>• Transient inputs: Report time-history sound pressure levels re AC0159 “Train of Step Functions on Processor”</li> </ul>			N/A
Any	Other	<ul style="list-style-type: none"> <li>• No rattles, squeaks, or unexpected noises.</li> <li>• Sound should be “even” around the EUT (one side should not be dramatically louder than another).</li> <li>• Unless otherwise specified, the “default” thermal-related settings shall be selected for BIOS and iDRAC.</li> <li>• Specific operating conditions are defined in “Configurations and Configuration Dependencies” for each platform.</li> </ul>			
Sound Pressure	LpA-reported, dBA, re AC0158 and program configuration document	Report for all mics	Report for all mics	Report for all mics	Report for all mics

### Category 2: Floor-standing in Office Environment

When Dell determines that a specific ISG product is to be used primarily when it is sitting on the floor, i.e., next to a user's feet, then the acoustical specification in the table below applies. Noise from the product should not annoy or otherwise interfere with the user's thoughts or speech, e.g., on the telephone.



**Table 20. Dell Enterprise Category 2, “Floor-standing in Office Environment” acoustical specification category**

Measurement Position re AC0158	Metric, re AC0159	Test Modes, re AC0159 (note must be in steady state, see AC0159, except where noted below)			
		Standby in 23±2° C Ambient	Idle in 23±2° C Ambient	Operating in 23±2° C Ambient – if not otherwise specified in the program’s configuration document, then processor and hard drive operating modes are required	Simulate (that is, set fan speeds representative) for Idle at 28° C & 35° C Ambient, and for 100% loading and maximum configuration, at 35° C Ambient
Sound Power	LWA,m, B	≤ 4.9	≤ 5.1	≤ 5.4	Report
Sound Quality (both positions must meet limits): Front Binaural HEAD and Rear Microphone	Tones, Hz, dB	No prominent tones per criteria D.10.6 and D.10.8 of ECMA-74			Report tones
	Tonality, tu	≤ 0.35	≤ 0.35	≤ 0.35	Report
	Dell Modulation, %	≤ 35	≤ 35	≤ 35	Report
	Loudness, sones	Report	Report	Report	Report
	LpA-single point, dBA	Report	Report	Report	Report
Front Binaural HEAD	Transients	<ul style="list-style-type: none"> <li>• Oscillation (see AC0159), if observed, during 20-minute steady-state observation, must adhere to the following two criteria: <ul style="list-style-type: none"> <li>◦ Max. {ΔLpA} &lt; 3.0 dB</li> <li>◦ Event count &lt; 3 for “1.5 dB &lt; ΔLpA &lt; 3.0 dB”</li> </ul> </li> <li>• Acoustical Jump (see AC0159), during air mover speed transition from Idle to Operating Mode must be ≤ 15 dB.</li> <li>• Startup behavior <ul style="list-style-type: none"> <li>◦ Report Startup behavior re. AC0159</li> <li>◦ Startup must proceed smoothly, that is, no sudden or large jumps</li> </ul> </li> <li>• Transient inputs: Report time-history sound pressure levels re AC0159 “Train of Step Functions on Processor”</li> </ul>			N/A
Any	Other	<ul style="list-style-type: none"> <li>• No rattles, squeaks, or unexpected noises.</li> <li>• Sound should be “even” around the EUT (one side should not be dramatically louder than another).</li> <li>• Unless otherwise specified, the “default” thermal-related settings shall be selected for BIOS and iDRAC.</li> <li>• Specific operating conditions are defined in “Configurations and Configuration Dependencies” for each platform.</li> </ul>			
Sound Pressure	LpA-reported, dBA, re AC0158 and program configuration document	Report for all mics	Report for all mics	Report for all mics	Report for all mics

## Category 3: General Use Space

When Dell determines that a specific ISG product is to be predominantly used in a general use space, then the acoustical specification in the table below applies. These products could be found in laboratories, schools, restaurants, open office space layouts, small ventilated closets, etc., though not in close proximity to any particular person nor in quantities greater than a few in any location. People within proximity of a few of these products should not experience any impact to speech intelligibility or annoyance from the noise of the product. A rack product sitting on a table in a common area is an example.

**Table 21. Dell Enterprise Category 3, “General Use Space” acoustical specification category**

Measurement Position re AC0158	Metric, re AC0159	Test Modes, re AC0159 (note must be in steady state, see AC0159, except where noted below)			Simulate (i.e., set fan speeds representative) for Idle at 28 & 35° C Ambient, and for 100% loading and maximum configuration, at 35° C Ambient
		Standby in 23±2° C Ambient	Idle in 23±2° C Ambient	Operating in 23±2° C Ambient – if not otherwise specified in the program’s configuration document, then processor and hard drive operating modes are required	
Sound Power	LWA,m, B	≤ 5.2	≤ 5.5	≤ 5.8	Report
Sound Quality (both positions must meet limits): Front Binaural HEAD and Rear Microphone	Tones, Hz, dB	No prominent tones per criteria D.10.6 and D.10.8 of ECMA-74			Report tones
	Tonality, tu	≤ 0.35	≤ 0.35	≤ 0.35	Report
	Dell Modulation, %	≤ 40	≤ 40	≤ 40	Report
	Loudness, sones	Report	Report	Report	Report
	LpA-single point, dBA	Report	Report	Report	Report
Front Binaural HEAD	Transients	<ul style="list-style-type: none"> <li>● Oscillation (see AC0159), if observed, during 20-minute steady-state observation, must adhere to the following two criteria: <ul style="list-style-type: none"> <li>○ Max. {ΔLpA} &lt; 3.0 dB</li> <li>○ Event count &lt; 3 for “1.5 dB &lt; ΔLpA &lt; 3.0 dB”</li> <li>○ Acoustical Jump (see AC0159), during air mover speed transition from Idle to Operating Mode must be ≤ 15dB.</li> </ul> </li> <li>● Startup behavior <ul style="list-style-type: none"> <li>○ Report Startup behavior re. AC0159</li> <li>○ Startup must proceed smoothly, i.e., no sudden or large jumps.</li> </ul> </li> <li>● Transient inputs: Report time-history sound pressure levels re AC0159 “Train of Step Functions on Processor”</li> </ul>			N/A
Any	Other	<ul style="list-style-type: none"> <li>● No rattles, squeaks, or unexpected noises.</li> <li>● Sound should be “even” around the EUT (one side should not be dramatically louder than another).</li> <li>● Unless otherwise specified, the “default” thermal-related settings shall be selected for BIOS and iDRAC.</li> <li>● Specific operating conditions are defined in “Configurations and Configuration Dependencies” for each platform.</li> </ul>			
Sound Pressure	LpA-reported, dBA, re AC0158 and program	Report for all mics	Report for all mics	Report for all mics	Report for all mics

**Table 21. Dell Enterprise Category 3, “General Use Space” acoustical specification category (continued)**

Measurement Position re AC0158	Metric, re AC0159	Test Modes, re AC0159 (note must be in steady state, see AC0159, except where noted below)			Simulate (i.e., set fan speeds representative) for Idle at 28 & 35° C Ambient, and for 100% loading and maximum configuration, at 35° C Ambient
		Standby in 23±2° C Ambient	Idle in 23±2° C Ambient	Operating in 23±2° C Ambient – if not otherwise specified in the program’s configuration document, then processor and hard drive operating modes are required	
	configuration document				

### Category 4: Attended Data Center

When Dell determines that a specific ISG product is to be predominantly used in an attended data center, then the acoustical specification in the table below applies. The phrase "attended data center" is used to mean a space in which many (from tens to 1000s) of ISG products are deployed in proximity (i.e., in the same room) to personnel whose speech (perhaps with raised voices) is expected to be intelligible over the data center noise. Hearing protection or hearing monitoring programs are not expected in these areas. Examples in this category include monolithic rack products.

**Table 22. Dell Enterprise Category 4, “Attended Data Center” acoustical specification category**

Measurement Position re AC0158	Metric, re AC0159	Test Modes, re AC0159 (note must be in steady state, see AC0159, except where noted below)			Simulate (that is, set fan speeds representative) for 100% loading and maximum configuration, at 35° C Ambient
		Standby in 23±2° C Ambient	Idle in 23±2° C Ambient	Operating in 23±2° C Ambient – if not otherwise specified in the program’s configuration document, then processor and hard drive operating modes are required	
Sound Power	LWA,m, B	Report	≤ 6.9	≤ 7.1	Report
Front Binaural HEAD	Tones, Hz, dB	Report	< 15 dB	< 15 dB	Report
	Tonality, tu	Report	Report	Report	Report
	Dell Modulation, %	Report	Report	Report	Report
	Loudness, sones	Report	Report	Report	Report
	LpA-single point, dBA	Report	Report	Report	Report
	Transients	<ul style="list-style-type: none"> <li>Oscillation (see AC0159), if observed, during 20-minute steady-state observation, must adhere to the following two criteria:                             <ul style="list-style-type: none"> <li>Max. {ΔLpA} &lt; 3.0 dB</li> <li>Event count &lt; 3 for “1.5 dB &lt; ΔLpA &lt; 3.0 dB”</li> <li>Acoustical Jump (see AC0159), during air mover speed transition from Idle to Operating Mode must be ≤ 15 dB.</li> </ul> </li> </ul>	N/A		

**Table 22. Dell Enterprise Category 4, “Attended Data Center” acoustical specification category (continued)**

Measurement Position re AC0158	Metric, re AC0159	Test Modes, re AC0159 (note must be in steady state, see AC0159, except where noted below)				Simulate (that is, set fan speeds representative) for 100% loading and maximum configuration, at 35° C Ambient
		Standby in 23±2° C Ambient	Idle in 23±2° C Ambient	Operating in 23±2° C Ambient – if not otherwise specified in the program’s configuration document, then processor and hard drive operating modes are required	Simulate (that is, set fan speeds representative) for Idle at 28° C & 35° C Ambient	
		<ul style="list-style-type: none"> <li>○ Startup behavior                             <ul style="list-style-type: none"> <li>▪ Report Startup behavior re. AC0159</li> <li>▪ Startup must proceed smoothly, that is, no sudden or large jumps</li> </ul> </li> <li>● Transient inputs: Report time-history sound pressure levels re AC0159 “Train of Step Functions on Processor”</li> </ul>				
Any	Other	<ul style="list-style-type: none"> <li>● No rattles, squeaks, or unexpected noises.</li> <li>● Sound should be “even” around the EUT (one side should not be dramatically louder than another).</li> <li>● Unless otherwise specified, the “default” thermal-related settings shall be selected for BIOS and iDRAC.</li> <li>● Specific operating conditions are defined in “Configurations and Configuration Dependencies” for each platform.</li> </ul>				
Sound Pressure	LpA-reported, dBA	Report for all mics	Report for all mics	Report for all mics	Report for all mics	Report for all mics

### Category 5: Unattended Data Center

When Dell determines that a specific ISG product is to be predominantly used in an unattended data center (and not blades or blade enclosures; these have their own category), then the acoustical specification in the table below applies. The phrase "unattended data center" is used to mean a space in which many (from tens to 1000s) of ISG products are deployed together, its own heating and cooling systems condition the space, and operators or servicers of equipment enter generally only to deploy, service, or decommission equipment. Hearing protection or hearing monitoring programs may be expected (per government or company guidelines) in these areas. Examples in this category include monolithic rack products.

**Table 23. Dell Enterprise Category 5, “Unattended Data Center” acoustical specification category**

Measurement Position re AC0158	Metric, re AC0159	Test Modes, re AC0159 (note must be in steady state, see AC0159, except where noted below)				Simulate (that is, set air mover speeds representative) for 100% loading and maximum configuration, at 35° C Ambient
		Standby in 23±2° C Ambient	Idle in 23±2° C Ambient	Operating in 23±2° C Ambient – if not otherwise specified in the program’s configuration document, then processor and hard drive operating modes are required	Simulate (that is, set air mover speeds representative) for Idle at 28° C & 35° C Ambient	
Sound Power	LWA,m, B	Report	≤ 7.5	≤ 7.7	Report	Report
Front Binaural HEAD	Tones, Hz, dB	Report	< 15 dB	< 15 dB	Report	Report
	Tonality, tu	Report	Report	Report	Report	Report
	Dell Modulation, %	Report	Report	Report	Report	Report
	Loudness, sones	Report	Report	Report	Report	Report
	LpA-single point, dBA	Report	Report	Report	Report	Report
Front Binaural HEAD	Transients	<ul style="list-style-type: none"> <li>Oscillation (see AC0159), if observed, during 20-minute steady-state observation, must adhere to the following two criteria:                             <ul style="list-style-type: none"> <li>Max. {ΔLpA} &lt; 3.0 dB</li> <li>Event count &lt; 3 for “1.5 dB &lt; ΔLpA &lt; 3.0 dB”</li> </ul> </li> <li>Report Acoustical Jump (see AC0159) during air mover speed transition from Idle to Operating Mode.</li> <li>Startup behavior                             <ul style="list-style-type: none"> <li>Report Startup behavior re. AC0159</li> <li>Startup must proceed smoothly, that is, no sudden or large jumps, and air mover speed during startup must not exceed 50% of its maximum</li> </ul> </li> <li>Transient inputs: Report time-history sound pressure levels re AC0159 “Train of Step Functions on Processor”</li> </ul>			N/A	
Any	Other	<ul style="list-style-type: none"> <li>No rattles, squeaks, or unexpected noises.</li> <li>Sound should be “even” around the EUT (one side should not be dramatically louder than another).</li> <li>Unless otherwise specified, the “default” thermal-related settings shall be selected for BIOS and iDRAC.</li> <li>Specific operating conditions are defined in “Configurations and Configuration Dependencies” for each platform.</li> </ul>				
Sound Pressure	LpA-reported, dBA, re AC0158 and	Report for all mics	Report for all mics	Report for all mics	Report for all mics	Report for all mics

**Table 23. Dell Enterprise Category 5, “Unattended Data Center” acoustical specification category (continued)**

Measurement Position re AC0158	Metric, re AC0159	Test Modes, re AC0159 (note must be in steady state, see AC0159, except where noted below)				Simulate (that is, set air mover speeds representative) for 100% loading and maximum configuration, at 35° C Ambient
		Standby in 23±2° C Ambient	Idle in 23±2° C Ambient	Operating in 23±2° C Ambient – if not otherwise specified in the program’s configuration document, then processor and hard drive operating modes are required	Simulate (that is, set air mover speeds representative) for Idle at 28° C & 35° C Ambient	
	program configuration document					

**Category 6: Data Center Modular/Modular Enclosure**

When the product is a blade for or a blade enclosure itself, then the hosting blade enclosure must adhere to the acoustical specification in below table. One underlying assumption is that blade enclosures are deployed in unattended data centers (see description in Category 5). If the parties responsible for selection of product acoustical specification category determine that a specific blade or blade enclosure will be deployed in a more stringent acoustical environment, then specific configurations, capabilities, and/or user ships must be requested in formal documentation so that features to support the more restrictive performance may be designed as appropriate.

**Table 24. Dell Enterprise Category 6, “Data Center Modular/Modular Enclosure” acoustical specification category**

Measurement Position re AC0158	Metric, re AC0159	Test Modes, re AC0159 (note must be in steady state, see AC0159, except where noted below)				Simulate (that is, set air mover speeds representative) for 100% loading and maximum configuration, at 35° C Ambient
		Standby in 23±2° C Ambient	Idle in 23±2° C Ambient	Operating in 23±2° C Ambient – if not otherwise specified in the program’s configuration document, then processor and hard drive operating modes are required	Simulate (that is, set air mover speeds representative) for Idle at 28° C & 35° C Ambient	
Sound Power	LWA,m, B	Report	≤ 8.2	Report	Report	Report
Front Binaural HEAD	Tones, Hz, dB	Report	< 15 dB	< 15 dB	Report	Report
	Tonality, tu	Report	Report	Report	Report	Report
	Dell Modulation, %	Report	Report	Report	Report	Report

**Table 24. Dell Enterprise Category 6, “Data Center Modular/Modular Enclosure” acoustical specification category (continued)**

Measurement Position re AC0158	Metric, re AC0159	Test Modes, re AC0159 (note must be in steady state, see AC0159, except where noted below)				Simulate (that is, set air mover speeds representative) for 100% loading and maximum configuration, at 35° C Ambient
		Standby in 23±2° C Ambient	Idle in 23±2° C Ambient	Operating in 23±2° C Ambient – if not otherwise specified in the program’s configuration document, then processor and hard drive operating modes are required	Simulate (that is, set air mover speeds representative) for Idle at 28° C & 35° C Ambient	
	Loudness, sones	Report	Report	Report	Report	Report
	LpA-single point, dBA	Report	Report	Report	Report	Report
Front Binaural HEAD	Transients	<ul style="list-style-type: none"> <li>Oscillation (see AC0159), if observed, during 20-minute steady-state observation, must adhere to the following two criteria: <ul style="list-style-type: none"> <li>Max. {ΔLpA} &lt; 3.0 dB</li> <li>Event count &lt; 3 for “1.5 dB &lt; ΔLpA &lt; 3.0 dB”</li> </ul> </li> <li>Report Acoustical Jump (see AC0159) during air mover speed transition from Idle to Operating Mode.</li> <li>Startup behavior <ul style="list-style-type: none"> <li>Report Startup behavior re. AC0159</li> <li>Startup must proceed smoothly, that is, no sudden or large jumps.</li> </ul> </li> <li>Transient inputs: Report time-history sound pressure levels re AC0159 “Train of Step Functions on Processor”</li> </ul>			N/A	
Any	Other	<ul style="list-style-type: none"> <li>No rattles, squeaks, or unexpected noises.</li> <li>Sound should be “even” around the EUT (one side should not be dramatically louder than another).</li> <li>Unless otherwise specified, the “default” thermal-related settings shall be selected for BIOS and iDRAC.</li> <li>Specific operating conditions are defined in “Configurations and Configuration Dependencies” for each platform.</li> </ul>				
Sound Pressure	LpA-reported, dBA, re AC0158 and program configuration document	Report for all mics	Report for all mics	Report for all mics	Report for all mics	Report for all mics

# Rack, rails, and cable management

## Topics:

- [Rails and cable management information](#)

## Rails and cable management information

The rail offerings for the PowerEdge R7625 consist of two general types: sliding and static. The cable management offerings consist of an optional cable management arm (CMA) and an optional strain relief bar (SRB).

See the *Dell Enterprise Systems Rail Sizing and Rack Compatibility Matrix* available at [https://i.dell.com/sites/csdocuments/Business\\_solutions\\_engineering-Docs\\_Documents/en/rail-rack-matrix.pdf](https://i.dell.com/sites/csdocuments/Business_solutions_engineering-Docs_Documents/en/rail-rack-matrix.pdf) for information regarding:

- Specific details about rail types.
- Rail adjustability ranges for various rack mounting flange types
- Rail depth with and without cable management accessories
- Rack types that are supported for various rack mounting flange types

Key factors governing proper rail selection include the following:

- Spacing between the front and rear mounting flanges of the rack
- Type and location of any equipment that is mounted in the back of the rack such as power distribution units (PDUs)
- Overall depth of the rack

## Sliding rails features summary

The sliding rails allow the system to be fully extended out of the rack for service. There are two types of sliding rails available, ReadyRails II sliding rails and Stab-in/Drop-in sliding rails. The sliding rails are available with or without the optional cable management arm (CMA) or strain relief bar (SRB).

### B21 ReadyRails sliding rails for 4-post racks

- Supports drop-in installation of the chassis to the rails.
- Support for tool-less installation in 19" EIA-310-E compliant square or un-threaded round hole 4-post racks including all generations of the Dell racks.
- Support for tooled installation in 19" EIA-310-E compliant threaded hole 4-post racks.
- Support full extension of the system out of the rack to allow serviceability of key internal components.
- Support for optional strain relief bar (SRB).
- Support for optional cable management arm (CMA).

**i** **NOTE:** For situations where CMA support is not required, the outer CMA mounting brackets can be uninstalled from the sliding rails. This reduces the overall length of the rails and eliminates the potential interferences with rear mounted PDUs or the rear rack door.



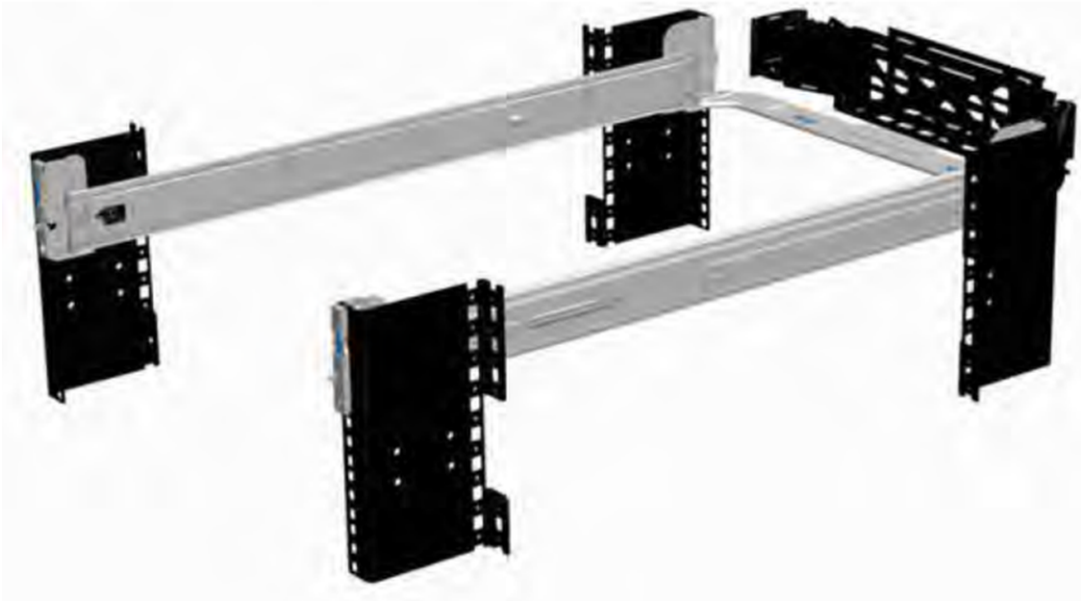

Figure 30. Sliding rails with optional CMA

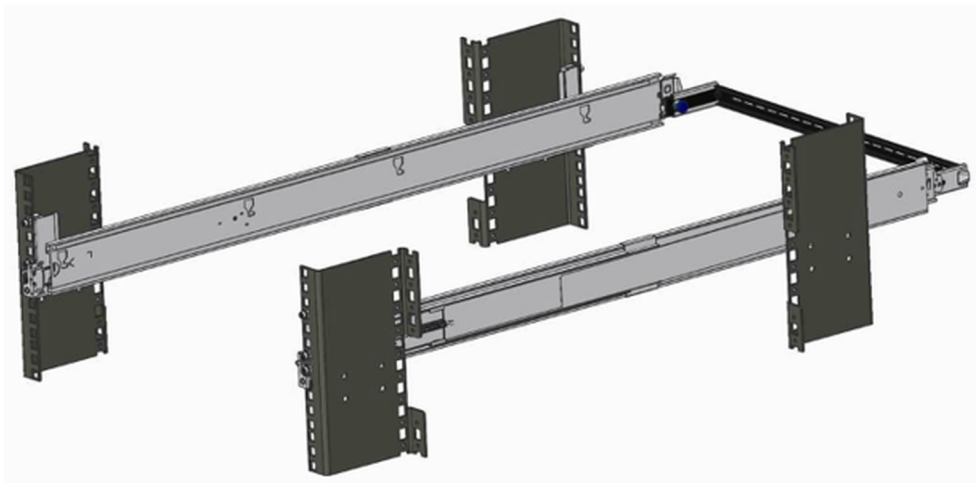

Figure 31. Sliding rails with optional SRB

### B22 Stab-in/Drop-in sliding rails for 4-post racks

- Supports drop-in or stab-in installation of the chassis to the rails.
- Support for tool-less installation in 19" EIA-310-E compliant square, un-threaded round hole racks including all generations of the Dell racks. Also supports tool-less installation in threaded round hole 4-post racks.
- Support for tool-less installation in Dell Titan or Titan-D racks
- Support full extension of the system out of the rack to allow serviceability of key internal components.
- Support for optional cable management arm (CMA).
- Support for optional strain relief bar (SRB).

**i NOTE:** For situations where CMA support is not required, the outer CMA mounting brackets can be uninstalled from the sliding rails. This reduces the overall length of the rails and eliminates the potential interferences with rear mounted PDUs or the rear rack door.

Scan the QRL code for the documentation and trouble-shooting information regarding the installation procedures for Drop-in/Stab-in rail types.



Figure 32. Quick resource locator for combo rails

## B20 static rails summary

The static rails offer a greater adjustability range and a smaller overall mounting footprint than the sliding rails because of their reduced complexity and lack of need for CMA support. The static rails support a wider variety of racks than the sliding rails. However, they do not support serviceability in the rack and are thus not compatible with the CMA. The static rails are also not compatible with SRB.



Figure 33. Static rails

### Static rails features summary

Static rails for 4-post & 2-post racks:

- Supports stab-in installation of the chassis to the rails.
- Support tool-less installation in 19" EIA-310-E compliant square or un-threaded round hole 4-post racks including all generations of Dell racks.
- Support tool-less installation in 19" EIA-310-E compliant threaded hole 4-post and 2-post racks.
- Support for tool-less installation in Dell Titan or Titan-D rack.

#### **i** NOTE:

- Screws are not included with the static rail kit since racks are offered with various thread types. The screws are provided for mounting static rails in racks with threaded mounting flanges.
- Screw head diameter should be 10 mm or less.

### 2-Post racks installation

If installing to 2-Post (Telco) racks, the ReadyRails static rails (B20) must be used. Sliding rails support mounting in 4-post racks only.



**Figure 34. Static rails in 2-post center mount configuration**

#### **Installation in the Dell Titan or Titan-D racks**

For tool-less installation in Titan or Titan-D racks, the Stab-in/Drop-in Sliding rails (B22) must be used. This rail collapses down sufficiently to fit in the rack with mounting flanges that are spaced about 24 inches apart from front to back. The Stab-in/Drop-in Sliding rail allows bezels of the servers and storage systems to be aligned when installed in these racks. For tooled installation, Stab-in Static rails (B20) must be used for bezel alignment with Storage systems.

## Cable management arm (CMA)

The optional cable management arm (CMA) organizes and secures the cords and cables exiting the back of the systems. It unfolds to allow the systems to extend out of the rack without having to detach the cables. Some key features of the CMA include:

- Large U-shaped baskets to support dense cable loads.
- Open vent pattern for optimal airflow.
- Ability to mount on either side by swinging the spring-loaded brackets from one side to the other.
- Utilizes hook-and-loop straps rather than plastic tie wraps to eliminate the risk of cable damage during cycling.
- Includes a low-profile fixed tray to both support and retain the CMA in its fully closed position.
- Both the CMA and the tray mount without the use of tools by simple and intuitive snap-in designs.

The CMA can be mounted to either side of the sliding rails without the use of tools or the need for conversion. For systems with one power supply unit (PSU), it is recommended to mount on the side opposite to that of the power supply to allow easier access to it and the rear drives (if applicable) for service or replacement.

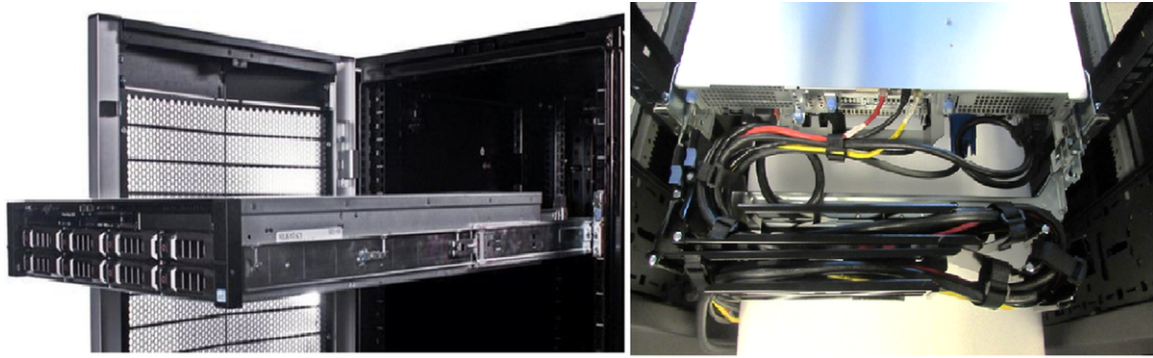

**Figure 35. Sliding rails with CMA cabling**

## Strain Relief Bar (SRB)

The optional strain relief bar (SRB) for the PowerEdge R7625 organizes and supports cable connections at the rear end of the server to avoid damage from bending.

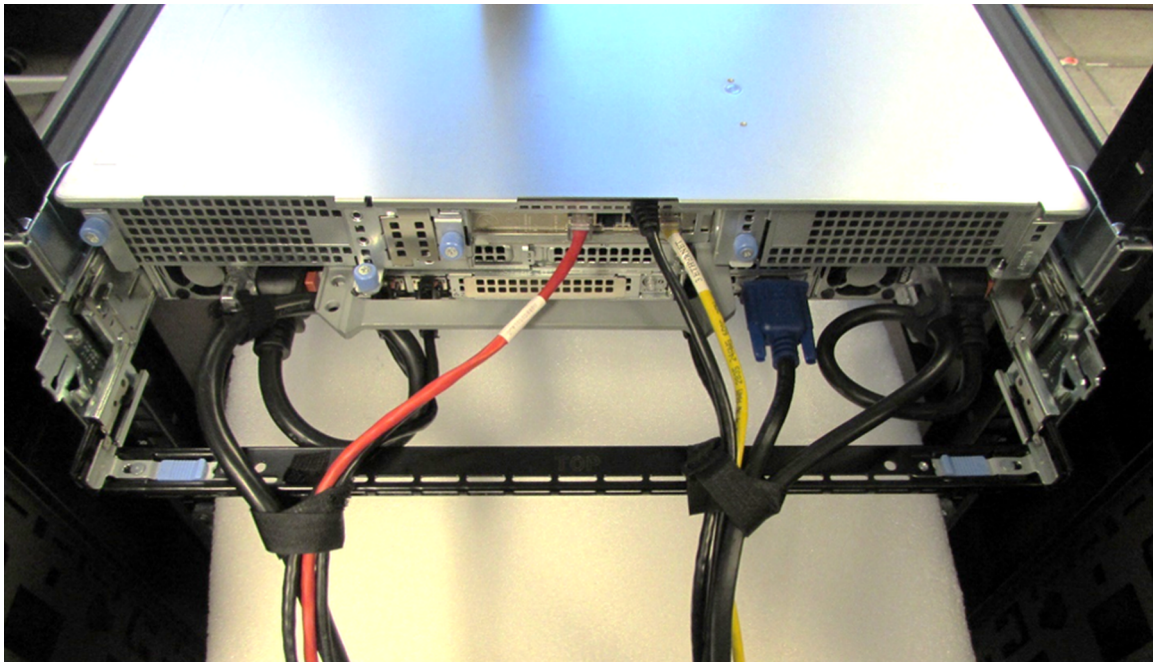
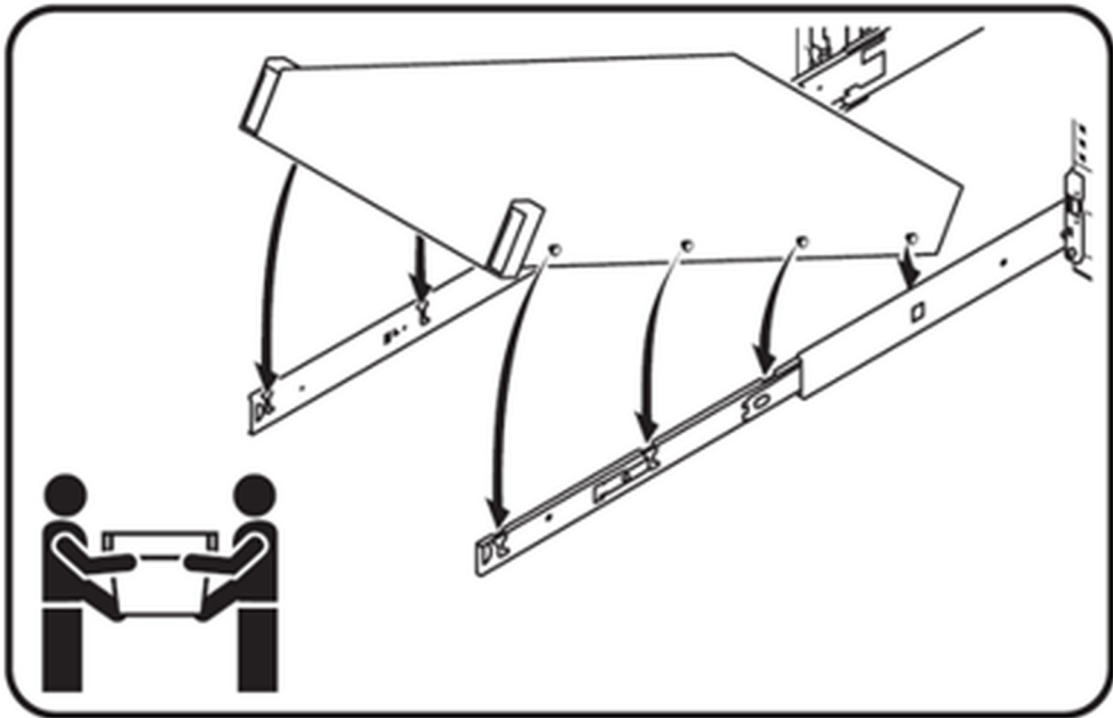

**Figure 36. Cabled strain relief bar**

- Tool-less attachment to the rails
- Two depth positions to accommodate various cable loads and rack depths
- Supports cable loads and controls stresses on server connectors
- Cables can be separated into discrete purpose-specific bundles

## Rack Installation

Drop-in design means that the system is installed vertically into the rails by inserting the standoffs on the sides of the system into the J-slots in the inner rail members with the rails in the fully extended position. The recommended method of installation is to first insert the rear standoffs on the system into the rear J-slots on the rails to free up a hand and then rotate the system down into the remaining J-slots while using the free hand to hold the rail against the side of the system.

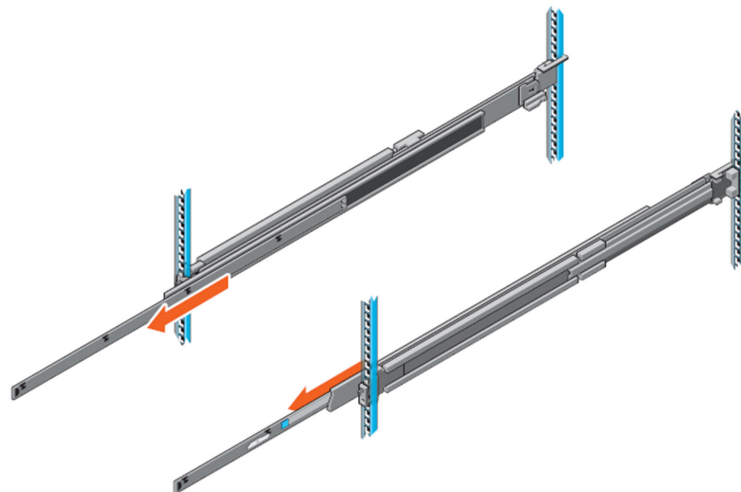

**Figure 37. Installing the system in Drop-in sliding rails**

Stab-in design means that the inner (chassis) rail members must first be attached to the sides of the system and then inserted into the outer (cabinet) members installed in the rack. For a 2U systems, this is a two person lift.

## Installing system into the rack (option A: Drop-In)

1. Pull the inner rails out of the rack until they lock into place.



**Figure 38. Pull out inner rail**

2. Locate the rear rail standoff on each side of the system and lower them into the rear J-slots on the slide assemblies.
3. Rotate the system downward until all the rail standoffs are seated in the J-slots.

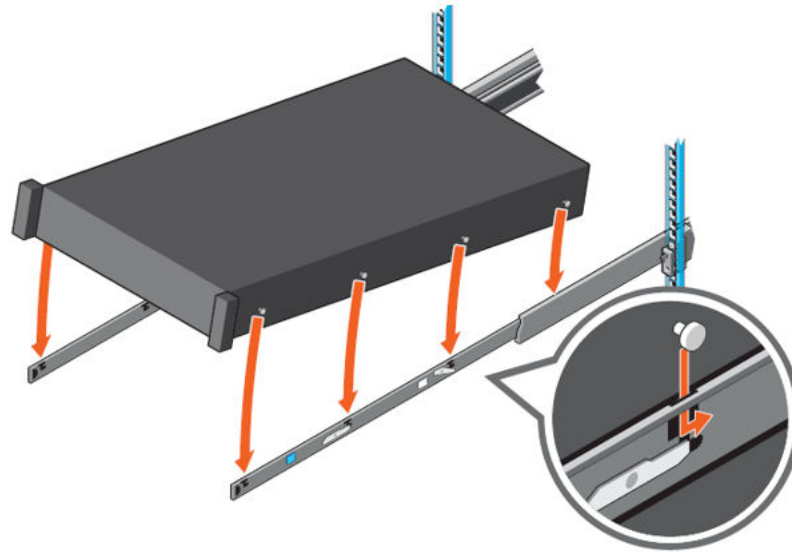

**Figure 39. Rail standoffs seated in J-slots**

4. Push the system inward until the lock levers click into place.
5. Pull the blue side release lock tabs forward or backward on both rails and slide the system into the rack until the system is in the rack.

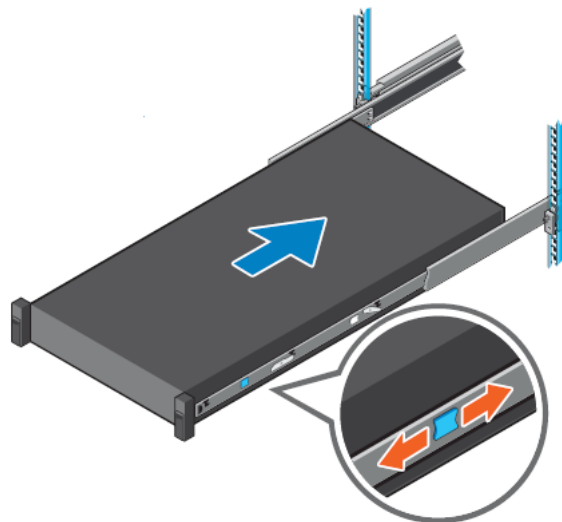

**Figure 40. Slide system into the rack**

## Installing the system into the rack (option B: Stab-In)

1. Pull the intermediate rails out of the rack until they lock into place.
2. Release the inner rail lock by pulling forward on the white tabs and sliding the inner rail out of the intermediate rails.

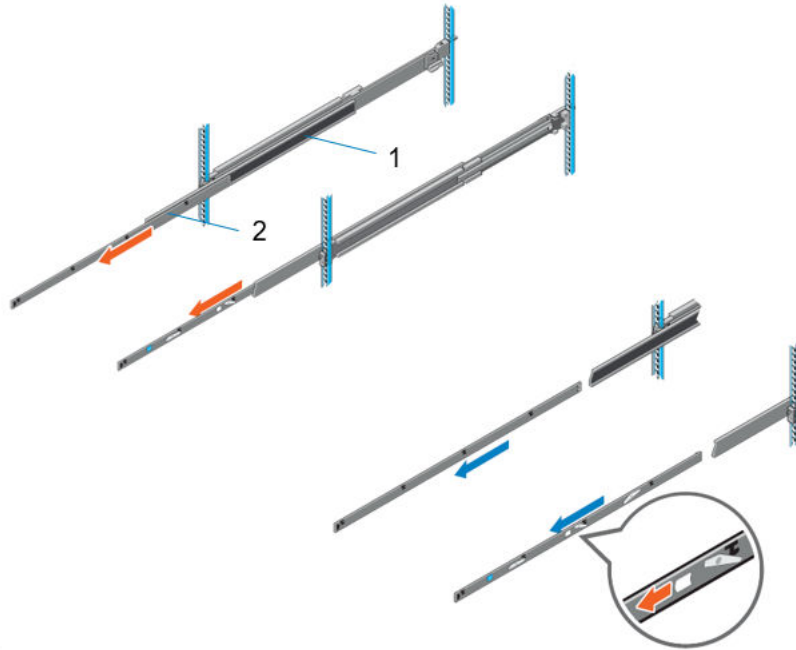
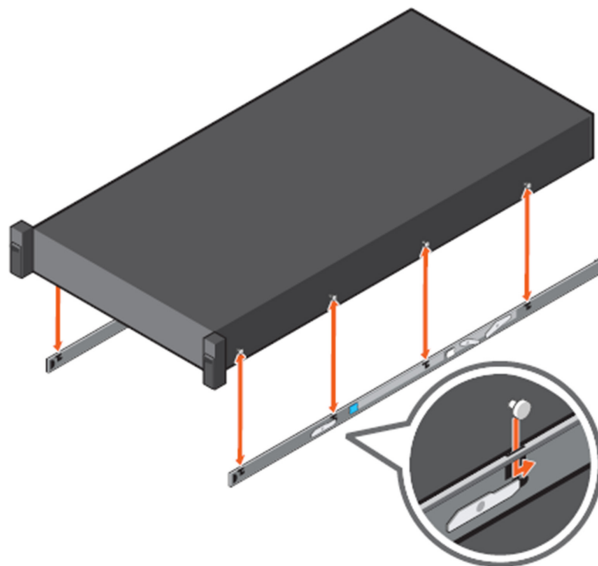

**Figure 41. Pull out the intermediate rail**

**Table 25. Rail component label**

Number	Component
1	Intermediate rail
2	Inner rail

3. Attach the inner rails to the sides of the system by aligning the J-slots on the rail with the standoffs on the system and sliding forward on the system until they lock into place.



**Figure 42. Attach the inner rails to the system**

4. With the intermediate rails extended, install the system into the extended rails.

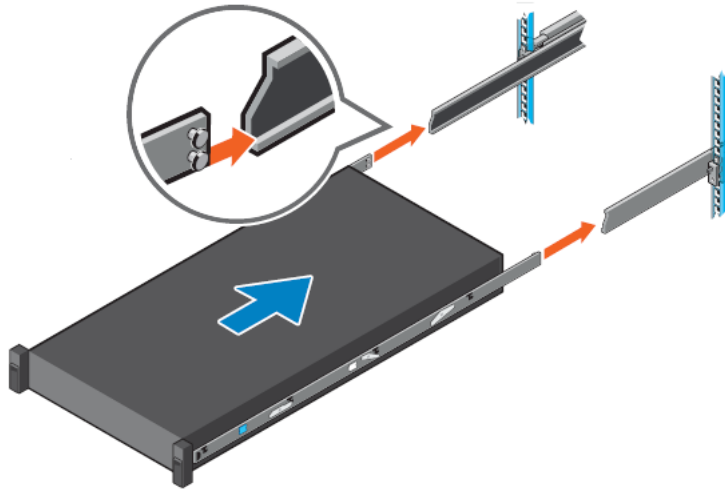

**Figure 43. Install system into the extended rails**

5. Pull blue slide release lock tabs forward or backward on both rails, and slide the system into the rack.

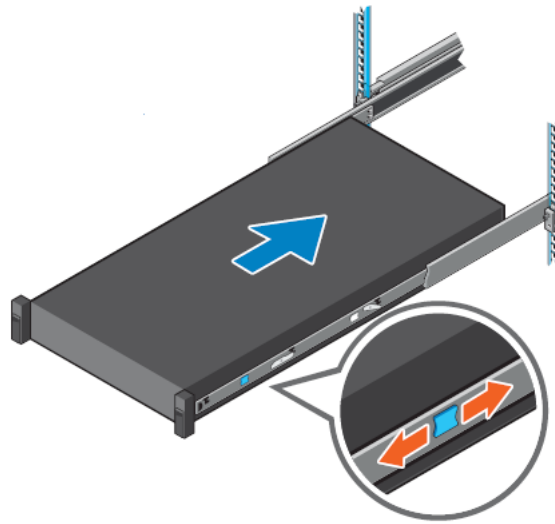

**Figure 44. Slide system into the rack**



# Supported Operating Systems

The PowerEdge system supports the following operating system:

- Canonical Ubuntu Server LTS
- Microsoft Windows Server with Hyper-V
- Red Hat Enterprise Linux
- SUSE Linux Enterprise Server
- VMware vSAN/ESXi

Links to specific OS versions and editions, certification matrices, Hardware Compatibility Lists (HCL) portal, and Hypervisor support are available at [Dell Enterprise Operating Systems](#).

# Dell OpenManage Systems Management

Dell delivers management solutions that help IT administrators effectively deploy, update, monitor, and manage IT assets. OpenManage solutions and tools enable you to quickly respond to problems by helping them to manage Dell servers efficiently; in physical, virtual, local, and remote environments; all without the need to install an agent in the operating system.

The OpenManage portfolio includes:

- Innovative embedded management tools - integrated Dell Remote Access Controller (iDRAC)
- Consoles - OpenManage Enterprise
- Extensible with plug-ins - OpenManage Power Manager
- Update tools - Repository Manager

Dell has developed comprehensive systems management solutions that are based on open standards and has integrated with management consoles from partners such as Microsoft and VMware, allowing advanced management of Dell servers. Dell management capabilities extend to offerings from the industry's top systems management vendors and frameworks such as Ansible, Splunk, and ServiceNow. OpenManage tools automate the full span of server life cycle management activities along with powerful RESTful APIs to script or integrate with your choice of frameworks.

For more information about the entire OpenManage portfolio, see:

- The [OpenManage Consoles and Integrations](#) page at [PowerEdge Central](#).
- The latest [Dell Systems Management Overview Guide](#).

## Topics:

- [Integrated Dell Remote Access Controller \(iDRAC\)](#)
- [Systems Management software support matrix](#)

## Integrated Dell Remote Access Controller (iDRAC)

iDRAC9 delivers advanced, agent-free, local and remote server administration. Embedded in every PowerEdge server, iDRAC9 provides a secure means to automate a multitude of common management tasks. Because iDRAC is embedded within every PowerEdge server, there is no additional software to install; just plug in power and network cables, and iDRAC is ready to go. Even before installing an operating system (operating system) or hypervisor, IT administrators have a complete set of server management features at their fingertips.

With iDRAC9 in-place across the Dell PowerEdge portfolio, the same IT administration techniques and tools can be applied throughout. This consistent management platform allows easy scaling of PowerEdge servers as an organization's infrastructure grows. Customers can use the iDRAC RESTful API for the latest in scalable administration methods of PowerEdge servers. With this API, iDRAC enables support for the Redfish standard and enhances it with Dell extensions to optimize at-scale management of PowerEdge servers. By having iDRAC at the core, the entire OpenManage portfolio of Systems Management tools allows every customer to tailor an effective, affordable solution for any size environment.

Zero Touch Provisioning (ZTP) is embedded in iDRAC. ZTP - Zero Touch Provisioning is Intelligent Automation Dell's agent-free management puts IT administrators in control. Once a PowerEdge server is connected to power and networking, that system can be monitored and fully managed, whether you're standing in front of the server or remotely over a network. In fact, with no need for software agents, an IT administrator can: · Monitor · Manage · Update · Troubleshoot and remediate Dell servers With features like zero-touch deployment and provisioning, iDRAC Group Manager, and System Lockdown, iDRAC9 is purpose-built to make server administration quick and easy. For those customers whose existing management platform utilizes in-band management, Dell does provide iDRAC Service Module, a lightweight service that can interact with both iDRAC9 and the host operating system to support legacy management platforms.

When ordered with DHCP enabled from the factory, PowerEdge servers can be automatically configured when they are initially powered up and connected to your network. This process uses profile-based configurations that ensure each server is configured per your specifications. This feature requires an iDRAC Enterprise license.

iDRAC9 offers following license tiers:

**Table 26. iDRAC9 license tiers**

License	Description
iDRAC9 Basic	<ul style="list-style-type: none"> <li>Available only on 100-500 series rack/tower</li> <li>Basic instrumentation with iDRAC web UI</li> <li>For cost conscious customers that see limited value in management</li> </ul>
iDRAC9 Express	<ul style="list-style-type: none"> <li>Default on 600+ series rack/tower, modular, and XR series</li> <li>Includes all features of Basic</li> <li>Expanded remote management and server life-cycle features</li> </ul>
iDRAC9 Enterprise	<ul style="list-style-type: none"> <li>Available as an upsell on all servers</li> <li>Includes all features of Basic and Express. Includes key features such as virtual console, AD/LDAP support, and more</li> <li>Remote presence features with advanced, Enterprise-class, management capabilities</li> </ul>
iDRAC9 Datacenter	<ul style="list-style-type: none"> <li>Available as an upsell on all servers</li> <li>Includes all features of Basic, Express, and Enterprise. Includes key features such as telemetry streaming, Thermal Manage, automated certificate management, and more</li> <li>Extended remote insight into server details, focused on high end server options, granular power, and thermal management</li> </ul>

For a full list of iDRAC features by license tier, see [Integrated Dell Remote Access Controller 9 User's Guide](#) at [Dell.com](#).

For more details on iDRAC9 including white papers and videos, see:

- [iDRAC and embedded technologies](#) at [PowerEdge Central](#)
- [Support for Integrated Dell Remote Access Controller 9 \(iDRAC9\)](#) on the [Knowledge Base](#) page at [Dell.com](#)

## Systems Management software support matrix

**Table 27. Systems Management software support matrix**

Categories	Features	PE mainstream
Embedded Management and In-band Services	iDRAC9 (Express, Enterprise, and Datacenter licenses)	Supported
	OpenManage Mobile and QuickSync2	Supported
	OM Server Administrator (OMSA)	Supported
	iDRAC Service Module (iSM)	Supported
	Driver Pack	Supported
Change Management	Update Tools (Repository Manager, DSU, Catalogs)	Supported
	Server Update Utility	Supported
	Lifecycle Controller Driver Pack	Supported
	Bootable ISO	Supported
Console and Plug-ins	OpenManage Enterprise	Supported
	Power Manager Plug-in	Supported
	Update Manager Plug-in	Supported
	Services Plug-in	Supported
	CloudIQ	Supported
Integrations and connections	OM Integration with VMware Vcenter/vROps	Supported
	OM Integration with Microsoft System Center (OMIMSC)	Supported
	Integrations with Microsoft System Center and Windows Admin Center (WAC)	Supported

**Table 27. Systems Management software support matrix (continued)**

<b>Categories</b>	<b>Features</b>	<b>PE mainstream</b>
	ServiceNow	Supported
	Ansible	Supported
	Third-party Connectors	Supported
Security	Secure Enterprise Key Management	Supported
	Secure Component Verification	Supported
Standard operating system	Red Hat Enterprise Linux, SUSE, Windows Server 2021 Ubuntu, CentOS	Supported (Tier-1)

For more information, see:

- [OpenManage Consoles and Integrations at PowerEdge Central](#)
- [OpenManage Tools at PowerEdge Central](#)

# Appendix D: Service and support

## Topics:

- [Default support levels](#)
- [Other services and support information](#)

## Default support levels

This system offers 3 years Dell ProSupport Next Business Day (NBD), including 24x7 phone support and NBD parts and labor support.

## Default deployment levels

This system offers **Dell Basic Deployment**, including onsite hardware installation during business hours with packaging materials disposal. Optionally, the customer may choose to any of the factory or field deployment offers listed below.

## Other services and support information

Dell Technologies Services include a wide, customizable range of service options to simplify the assessment, design, implementation, management and maintenance of IT environments and to help transition from platform to platform.

Depending on the current business requirements and correct level of service for customers, we provide factory, onsite, remote, modular, and specialized services that fit the customer requirements and budget. We will help with a little or a lot, based on the customers choice, and provide access to our global resources.

## Dell deployment services

### [Dell ProDeploy Infrastructure Suite](#)

ProDeploy Infrastructure Suite provides a variety of deployment offerings that satisfy a customer's unique needs. It is made up of 5 offers: ProDeploy Configuration Services, ProDeploy Rack Integration Services, Basic Deployment, ProDeploy, and ProDeploy Plus.

# ProDeploy Infrastructure Suite for servers

Versatile choices for accelerated deployments

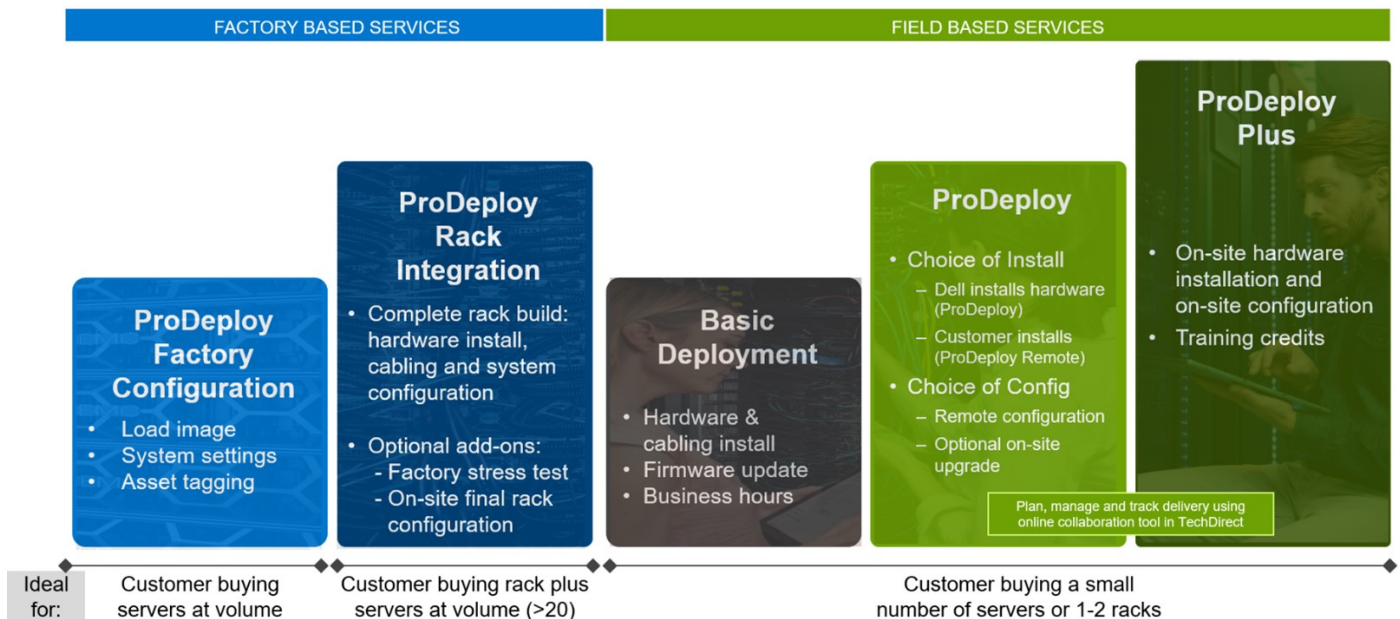

Figure 45. ProDeploy Infrastructure Suite for servers

The new Factory Services consist of two tiers of deployment that happen prior to shipping to the customer's site.

### Factory Based Services:

- ProDeploy Factory Configuration - Ideal for customers buying servers in volume and seeking pre-configuration prior to shipping such as: custom image, system settings, and asset tagging so it arrives ready to use out of the box. Furthermore, servers can be packaged and bundled to meet specific shipping and distribution requirements for each customer location to facilitate the rollout process. Upsell one of the field based services (below) if a customer needs assistance with the final server installation.
- ProDeploy Rack Integration - Ideal for customers seeking to build out fully integrated racks prior to shipping. These rack builds include hardware install, cabling, and full system configuration. You can also add-on a factory stress test and optional on-site final rack configuration to complete the rack installation.
  - STANDARD SKUs for Rack Integration is available in US only and requires:
    - 20 or more devices (R and C series servers and all Dell or non-Dell switches). Use Informational SKUs for Dell switches or 3rd party products
    - Shipping to contiguous US
  - USE CUSTOM QUOTE for Rack Integration for:
    - All countries except USA
    - Racks containing less than 20 servers
    - Any rack that includes VxRail or Storage
    - Shipping outside contiguous US
    - Shipping to multiple locations

### Field Based Services:

- Basic Deployment consists of the hardware installation, cabling and firmware update during normal standard business hours. Basic Deployment is traditionally sold to Competency Enabled Partners. Competency enabled partners often have Dell do the hardware installation while they complete the software configuration.
- ProDeploy consists of your hardware installation and configuration of the software using offshore resources. ProDeploy is great for customers who are price sensitive or who are remote from their data centers and don't require an onsite presence.
- ProDeploy Plus will give you in-region or onsite resources to complete the engagement for the customer. It also comes with additional features such as Post Deployment Configuration Assistance and Training Credits.

# ProDeploy Infrastructure Suite | Factory services

## FACTORY BASED SERVICES

		ProDeploy Factory Configuration	ProDeploy Rack Integration
Asset configuration	Single point of contact for project management	●	●
	RAID, BIOS and iDRAC configuration	●	●
	Firmware freeze	●	●
	Asset Tagging and Reporting	●	●
	Customer system image	●	●
Factory implementation	Site readiness review and implementation planning	-	●
	Hardware racking and cabling	-	●
	SAM engagement for ProSupport Plus entitled accounts/devices	-	●
	Deployment verification, documentation, and knowledge transfer	●	●
Delivery	White glove logistics	-	●
	Onsite final configuration	-	Onsite add-on
	Install support software and connect with Dell Technologies	-	Onsite add-on
	Basic Deployment	Optional onsite installation	-
Online oversight	Online collaborative environment for planning, managing and tracking delivery	-	●

<sup>1</sup> ProDeploy Rack Integration Services are currently only available within the United States. Custom rack integration services are still available globally.\*

Dell Technologies

Figure 46. ProDeploy Infrastructure Suite - Factory services

# ProDeploy Infrastructure Suite | Field services

		Basic Deployment	ProDeploy	ProDeploy Plus
Pre-deployment	Single point of contact for project management	●	●	In-region
	Site readiness review	-	●	●
	Implementation planning <sup>1</sup>	-	●	●
	SAM engagement for ProSupport Plus entitled devices	-	-	●
Deployment	Deployment service hours	Business hours	24x7	24x7
	Onsite hardware installation and packaging material removal <sup>2</sup> or remote guidance for hardware installation <sup>1</sup>	●	Remote guidance or onsite	Onsite
	Install and configure system software	-	Remote	Onsite
	Install support software and connect with Dell Technologies	-	●	●
	Project documentation with knowledge transfer	-	●	●
Post-deployment	Deployment verification	-	●	●
	Configuration data transfer to Dell Technologies technical support	-	●	●
	30-days of post-deployment configuration assistance	-	-	●
	Training credits for Dell Technologies Education Services	-	-	●
Online oversight	Online collaborative environment in <a href="#">TechDirect</a> for planning, managing and tracking delivery <sup>3</sup>	-	●	●

<sup>1</sup> Remote option includes project specific instructions, documentation and live expert guidance for hardware installation. Option available for select hardware. [List is available in the backup portion of this customer presentation](#)

<sup>2</sup> Packaging removal included with onsite hardware installation

<sup>3</sup> Included with ProDeploy or ProDeploy Plus, Not included with Basic Deployment

Figure 47. ProDeploy Infrastructure Suite - Field services

## Dell ProDeploy Plus for Infrastructure

From beginning to end, ProDeploy Plus provides the skill and scale that is must successfully perform demanding deployments in today's complex IT environments. Certified Dell experts start with extensive environmental assessments and detailed migration

planning and recommendations. Software installation includes set up of our enterprise connectivity solution (secure connect gateway) and OpenManage system management utilities.

Postdeployment configuration assistance, testing, and product orientation services are also available.

## Dell ProDeploy for Infrastructure

ProDeploy provides full-service installation and configuration of both server hardware and system software by certified deployment engineers including set up of leading operating systems and hypervisors as well our enterprise connectivity solution (secure connect gateway) and OpenManage system management utilities. To prepare for the deployment, we conduct a site readiness review and implementation planning exercise. System testing, validation, and full project documentation with knowledge transfer complete the process.

## Dell Basic Deployment

Basic Deployment delivers worry-free professional installation by experienced technicians who know Dell servers inside and out.

## Additional Deployment Services

You can tailor the ProDeploy Infrastructure Suite offer to meet your customer's unique needs by leveraging "Additional Deployment Time." ADT will cover additional tasks above the normal scope of the standard offers. ADT can be sold for Project Management or Technical Resources and is sold as blocks of four hours remote or eight hours on-site.

## Dell ProDeploy for HPC (available in US/Canada only. All other regions use custom)

HPC deployments require specialists that understand that cutting edge is yesterday's news. Dell deploys the world 's fastest systems and understands the nuances that make them perform. ProDeploy for HPC provides:

- Global team of dedicated HPC specialists
- Proven track record, thousands of successful HPC deployments
- Design validation, benchmarking, and product orientation

Learn more at [Dell.com/HPC-Services](https://Dell.com/HPC-Services).



## ProDeploy Expansion for HPC

\*Available as standard SKUs in US & Canada and as custom quote in APJC, EMEA, LATAM

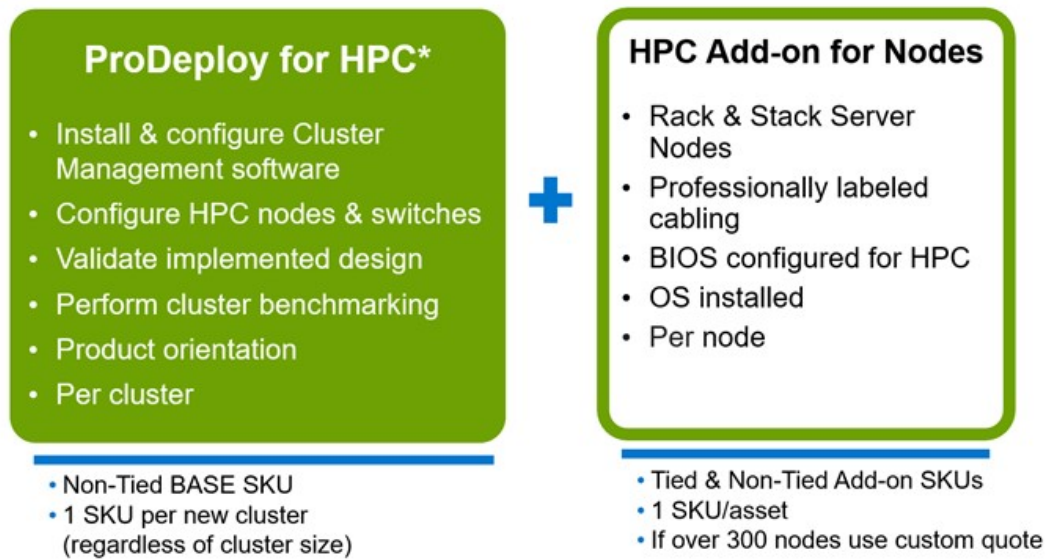

Figure 48. ProDeploy Expansion for HPC

## Dell custom deployment Services

Dell custom rack integration and other Dell configuration services help customers save time by providing systems that are racked, cabled, tested, and ready to be integrated into the data center. Dell support preconfigure RAID, BIOS and iDRAC settings, install system images, and even install third-party hardware and software.

For more information, see [Server Configuration Services](#).

## Dell Residency Services

Residency Services help customers transition to new capabilities quickly with the assistance of onsite or remote Dell experts whose priorities and time they control.

Residency experts can provide post implementation management and knowledge transfer that is related to a new technology acquisition or day-to-day operational management of the IT infrastructure.

## Dell Data Migration Services

Protect business and data of the customer with our single point of contact to manage data migration projects.

A customer project manager works with our experienced team of experts to create a plan using industry-leading tools and proven processes that are based on global best practices to migrate existing files and data, so business systems are up and running quickly and smoothly.

# Dell Enterprise Support Services

## Dell ProSupport Enterprise Suite

With the ProSupport Enterprise Suite, we help keep IT systems running smoothly, so customers can focus on running their business. We help maintain peak performance and availability of the most essential workloads. ProSupport Enterprise Suite is a suite of support services that enable customers to build the solution that is right for their organization. They choose support models that are based on how they use technology and where they want to allocate resources. From the desktop to the data center, address everyday IT challenges, such as unplanned downtime, mission-critical needs, data and asset protection, support planning, resource allocation, software application management and more. Optimize customer IT resources by choosing the right support model.

**Table 28. ProSupport Enterprise Suite**

Service	Support model	Description
ProSupport Enterprise Suite	ProSupport Plus for Enterprise	Proactive, predictive, and reactive support for systems that look after your business-critical applications and workloads
	ProSupport for Enterprise	Comprehensive 24 x 7 predictive and reactive support for hardware and software
	Basic hardware support	Reactive hardware support during normal business hours

## Dell ProSupport Plus for Enterprise

When customers purchase PowerEdge server, we recommend ProSupport Plus, our proactive and preventative support service for business-critical systems. ProSupport Plus provides all the benefits of ProSupport, plus the following:

- An assigned Services Account Manager who knows their business and environment
- Immediate advanced troubleshooting from an engineer
- Personalized, preventive recommendations that are based on analysis of support trends and best practices from across the Dell Technologies infrastructure solutions customer base to reduce support issues and improve performance
- Predictive analysis for issue prevention and optimization that is enabled by secure connect gateway technology
- Proactive monitoring, issue detection, notification, and automated case creation for accelerated issue resolution enabled by secure connect gateway
- On-demand reporting and analytics-based recommendations that are enabled by secure connect gateway and TechDirect

## Dell ProSupport for Enterprise

ProSupport service offers highly trained experts around the clock and around the globe to address IT needs. We help minimize disruptions and maximize availability of PowerEdge server workloads with:

- 24x7 support through phone, chat and online
- Predictive, automated tools and innovative technology
- A central point of accountability for all hardware and software issues
- Collaborative third-party support
- Hypervisor, operating system and application support
- Consistent experience regardless of where customers are located or what language they speak

 **NOTE:** Subject to service offer country or region availability.

- Optional onsite parts and labor response options including next business day or four-hour mission critical

## ProSupport Enterprise Suite Feature Comparison

	Basic	ProSupport	ProSupport Plus
Remote technical support	9x5	24x7	24x7
Covered products	Hardware	Hardware Software	Hardware Software
Onsite hardware support	Next business day	Next business day or 4hr mission critical	Next business day or 4 hr mission critical
3 <sup>rd</sup> party collaborative assistance		●	●
Self-service case initiation and management		●	●
Access to software updates		●	●
Proactive storage health monitoring, predictive analytics and anomaly detection with CloudIQ and the CloudIQ mobile app		●	●
Priority access to specialized support experts			●
Predictive detection of hardware failures			●
3 <sup>rd</sup> party software support			●
An assigned Service Account Manager			●
Proactive, personalized assessments and recommendations			●
Proactive systems maintenance			●

Availability and terms of Dell Technologies Services vary by region and by product. For more information, please view our [service descriptions](#).

Internal Use - Confidential 23 of 117 © Copyright 2022 Dell Inc. DELL Technologies

**Figure 49. ProSupport Enterprise Suite**

## Dell ProSupport One for Data Center

ProSupport One for Data Center offers flexible site-wide support for large and distributed data centers with more than 1,000 assets. This offering is built on standard ProSupport components that leverage our global scale but are tailored to a customer's needs. While not for everyone, this service option offers a truly unique solution for Dell Technologies largest customers with the most complex environments.

- Team of assigned Services Account Managers with remote, on-site options
- Assigned ProSupport One technical and field engineers who are trained on the customer's environment and configurations
- On-demand reporting and analytics-based recommendations that are enabled by secure connect gateway and TechDirect
- Flexible on-site support and parts options that fit their operational model
- A tailored support plan and training for their operations staff

## Dell ProSupport Add-on for HPC

The ProSupport Add-on for HPC provides solution-aware support including:

- Access to senior HPC experts
- Advanced HPC cluster assistance: performance, interoperability, and configuration
- Enhanced HPC solution level end-to-end support
- Remote presupport engagement with HPC Specialists during ProDeploy implementation

Learn more at [Dell.com/HPC-Services](https://Dell.com/HPC-Services).

# ProSupport Add-on for HPC is an add-on to PS or PSP

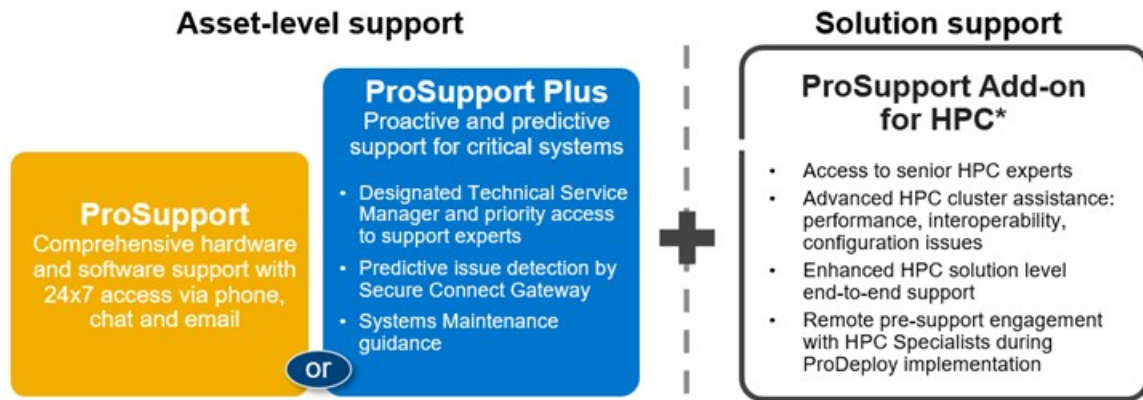

### Eligibility

- All server, storage, and networking nodes in cluster must have PS or PSP **AND** PS Add-on for HPC attached
- All HW expansions to clusters must attach PS or PSP **AND** PS Add-on for HPC
- To retrofit an entire existing cluster with PS Add-on for HPC:
  1. HPC Specialists must review and validate the existing cluster
  2. PS or PSP **AND** the PS Add-on for HPC (APOS) must be attached to all server, storage and networking nodes

\*Available in standard SKUs in NA and EMEA and as custom quote in APJC & LATAM

DELLTechnologies

Figure 50. ProSupport Add-on for HPC is an add-on to PS or PSP

## Support Technologies

Powering the support experience with predictive, data-driven technologies.

**NOTE:** SupportAssist Enterprise capabilities are now part of the secure connect gateway technology.

## Enterprise connectivity

The best time to solve a problem is before it happens. The automated proactive and predictive support features enabled by the secure connect gateway technology helps reduce steps and time to resolution, often detecting issues before they become a crisis. The gateway technology is available in virtual and application editions. It is also implemented as a direct connect version for select Dell hardware and a Services plugin within OpenManage Enterprise for PowerEdge servers. The legacy SupportAssist Enterprise solution has been retired and is now replaced by the secure connect gateway solutions.

Benefits include:

- Value: Our connectivity solutions are available to all customers at no additional charge
- Improve productivity: Replace manual, high-effort routines with automated support
- Accelerate time to resolution: Receive issue alerts, automatic case creation, and proactive contact from Dell experts
- Gain insight and control: Optimize enterprise devices with insights in portals reporting like TechDirect, and get predictive issue detection before the problem starts

**NOTE:** Connect devices can access these features. Features vary depending on the service level agreement for the connected device. ProSupport Plus customers experience the full set of automated support capabilities.

Table 29. Features enabled by connectivity

	Basic hardware warranty	ProSupport	ProSupport Plus
Automated issue detection and system state information collection	Supported	Supported	Supported
Proactive, automated case creation and notification	Not supported	Supported	Supported

**Table 29. Features enabled by connectivity (continued)**

	<b>Basic hardware warranty</b>	<b>ProSupport</b>	<b>ProSupport Plus</b>
Predictive issue detection for failure prevention	Not supported	Not supported	Supported

Get started at [DellTechnologies.com/secureconnectgateway](https://DellTechnologies.com/secureconnectgateway).

## Dell TechDirect

TechDirect helps boost IT team productivity when supporting Dell systems.

Boost your productivity with online service for Dell products from TechDirect. From deployment to technical support, TechDirect lets you do more with less effort and faster resolution. You can:

- Open and manage support requests or in-warranty systems
- Execute online self-service for parts dispatch
- Collaborate on ProDeploy infrastructure deployment projects online
- Manage proactive and predictive alerts from secure connect gateway technology that help maximize uptime
- Integrate services functionality into your help desk with TechDirect APIs
- Join over 10,000 companies that choose TechDirect

Register at [TechDirect.Dell.com](https://TechDirect.Dell.com).

## Dell Technologies Consulting Services

Our expert consultants help customers transform faster, and quickly achieve business outcomes for the high value workloads Dell PowerEdge systems can handle. From strategy to full-scale implementation, Dell Technologies Consulting can help determine how to perform IT, workforce, or application transformation. We use prescriptive approaches and proven methodologies that are combined with portfolio and partner ecosystem of Dell Technologies to help achieve real business outcomes. From multi cloud, applications, DevOps, and infrastructure transformations, to business resiliency, data center modernization, analytics, workforce collaboration, and user experiences-we are here to help.

## Dell Managed Services

Some customers prefer Dell to manage the complexity and risk of daily IT operations, Dell Managed Services utilizes proactive, AI enabled delivery operations and modern automation to help customers realize desired business outcomes from their infrastructure investments. With these technologies, our experts run, update and fine-tune customer environments aligned with service levels, while providing environment-wide and down-to-the-device visibility. There are two types of managed service offers. First the outsourcing model or CAPEX model where Dell manages the customer owned assets using our people and tools. The second is the as-a-Service model or OPEX model called APEX. In this service, Dell owns all technology and all the management of it. Many customers will have a blend of the two management types depending on the goals of the organization.

<b>Managed</b> Outsourcing or CAPEX model		<b>APEX</b> as-a-Service or OPEX model
<p>We manage your technology using our people and tools.<sup>1</sup></p> <ul style="list-style-type: none"> <li>• Managed detection and response*</li> <li>• Technology Infrastructure</li> <li>• End-user (PC/desktop)</li> <li>• Service desk operations</li> <li>• Cloud Managed (Pub/Private)</li> <li>• Office365 or Microsoft Endpoint</li> </ul>		<p>We own all technology so you can off-load all IT decisions.</p> <ul style="list-style-type: none"> <li>• APEX Cloud Services</li> <li>• APEX Flex on Demand elastic capacity</li> <li>• APEX Data Center Utility pay-per-use model</li> </ul>

1 – Some minimum device counts may apply. Order via: [ClientManagedServices.sales@dell.com](mailto:ClientManagedServices.sales@dell.com)

\* Managed detection and response covers the security monitoring of laptops, servers, & virtual servers. Min. 50 devices combined. No Networking or Storage-only systems [SAN/NAS]. Available in 32 countries. [Details here](#)

**Figure 51. Dell Managed Services**

## Dell Technologies Education Services

Build the IT skills required to influence the transformational outcomes of the business. Enable talent and empower teams with the right skills to lead and perform transformational strategy that drives competitive advantage. Leverage the training and certification required for real transformation.

Dell Technologies Education Services offers PowerEdge server training and certifications that are designed to help customers achieve more from their hardware investment. The curriculum delivers the information and the practical, firsthand skills that their team must confidently install, configure, manage, and troubleshoot Dell servers.

To learn more or register for a class today, see [Education.Dell.com](http://Education.Dell.com).

## Appendix A. Additional specifications

### Topics:

- Chassis dimensions
- System weight
- NIC port specifications
- Video specifications
- USB ports specifications
- PSU rating
- Environmental specifications

### Chassis dimensions

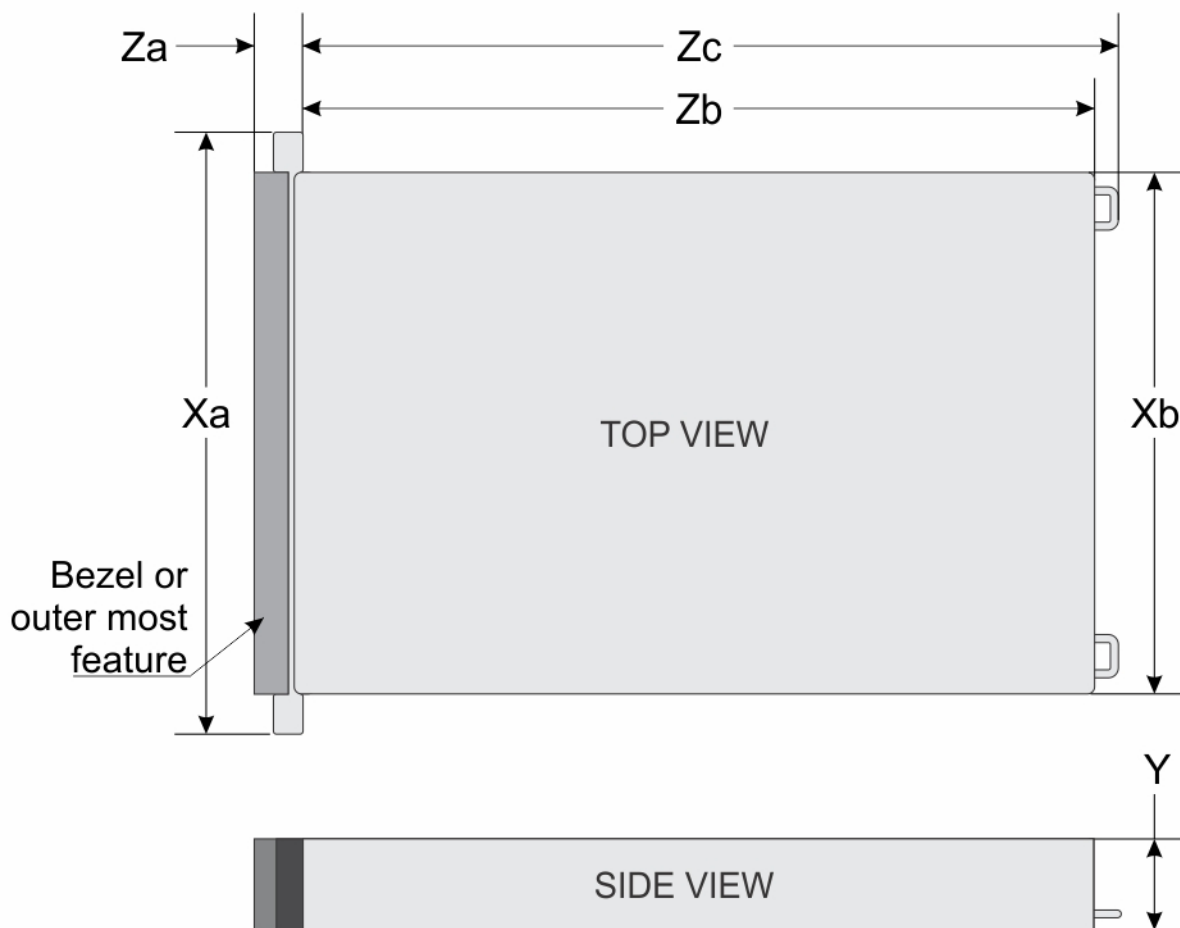

Figure 52. Chassis dimensions

**Table 30. PowerEdge R7625 chassis dimensions**

Xa	Xb	Y	Za	Zb	Zc
482.0 mm (18.97 inches)	434.0 mm (17.08 inches)	86.8 mm (3.41 inches)	35.84 mm (1.4 inches) With bezel  22.0 mm (0.87 inches) Without bezel	700.7 mm (27.58 inches) Ear to Rear wall	736.29 mm (28.98 inches) Ear to PSU handle

**NOTE:** Zb is the nominal rear wall external surface where the system board I/O connectors reside.

## System weight

**Table 31. PowerEdge R7625 system weight**

System configuration	Maximum weight (with all drives/SSDs)
A server with fully populated drives	34.4 kg (75.84 pound)
A server without drives and PSU installed	23.3 kg (51.37 pound)

## NIC port specifications

The PowerEdge R7625 system supports up to two 10/100/1000 Mbps Network Interface Controller (NIC) ports embedded on the LAN on Motherboard (LOM) and integrated on the Open Compute Project (OCP) cards.

**Table 32. NIC port specification for the system**

Feature	Specifications
LOM card (optional)	1 GbE x 2
OCP card 3.0 (optional)	1 GbE x 4, 10 GbE x 2, 10 GbE x 4, 25 GbE x 2, 25 GbE x 4

**NOTE:** The system allows either LOM card or an OCP card or both to be installed in the system.

**NOTE:** On the system board, the supported OCP PCIe width is x8; when x16 PCIe width is installed, it is downgraded to x8.

## Video specifications

The PowerEdge R7625 system supports integrated Matrox G200 graphics controller with 16 MB of video frame buffer.

**Table 33. Supported video resolution options**

Resolution	Refresh rate (Hz)	Color depth (bits)
1024 x 768	60	8, 16, 32
1280 x 800	60	8, 16, 32
1280 x 1024	60	8, 16, 32
1360 x 768	60	8, 16, 32
1440 x 900	60	8, 16, 32
1600 x 900	60	8, 16, 32
1600 x 1200	60	8, 16, 32
1680 x 1050	60	8, 16, 32



**Table 33. Supported video resolution options (continued)**

Resolution	Refresh rate (Hz)	Color depth (bits)
1920 x 1080	60	8, 16, 32
1920 x 1200	60	8, 16, 32

## USB ports specifications

**Table 34. PowerEdge R7625 USB specifications**

Front		Rear		Internal (optional)	
USB port type	No. of ports	USB port type	No. of ports	USB port type	No. of ports
USB 2.0-compliant port	One	USB 3.0-compliant port	One	Internal USB 3.0-compliant port	One
iDRAC Direct port (Micro-AB USB 2.0-compliant port)	One	USB 2.0-compliant ports	One		

**NOTE:** The micro USB 2.0 compliant port can only be used as an iDRAC Direct or a management port.

## PSU rating

**Table 35. PSUs Highline and Lowline ratings**

Features	800 W	1100 W	1100 W	1400 W	1800 W	2400 W	2800 W
	Platinum	Titanium	-48VDC	Platinum	Titanium	Platinum	Titanium
Peak Power (Highline/-72 VDC)	1360 W	1870 W	1870 W	2380 W	3060 W	4080 W	4760 W
Highline/-72 VDC	800 W	1100 W	1100 W	1400 W	1800 W	2400 W	2800 W
Peak Power (Lowline/-40 VDC)	1360 W	1785 W	N/A	1785 W	N/A	2380 W	N/A
Lowline/-40 VDC	800 W	1050 W	N/A	1050 W	N/A	1400 W	N/A
Highline 240 VDC	800 W	1100 W	N/A	1400 W	1800 W	2400 W	2800 W
Highline 380 VDC	N/A	N/A	N/A	N/A	N/A	N/A	N/A
DC-48-60 V	N/A	N/A	1100 W	N/A	N/A	N/A	N/A

The PowerEdge R7625 supports up to two AC or DC power supplies with 1+1 redundancy, autosensing, and auto-switching capability.

If two PSUs are present during POST, a comparison is made between the wattage capacities of the PSUs. In the event that the PSU wattages don't match, the larger of the two PSU's is enabled. Also, there is a PSU mismatch warning displayed in BIOS, iDRAC, or on the System LCD.

If a second PSU is added at run-time, in order for that particular PSU to be enabled, the wattage capacity of the first PSU must equal the second PSU. Otherwise, the PSU will be flagged as unmatched in iDRAC and the second PSU will not be enabled.

Dell PSUs have achieved Platinum efficiency levels as shown in the table below.

**Table 36. PSU Efficiency Levels**

Efficiency Targets by Load						
Form factor	Output	Class	10%	20%	50%	100%
Redundant 60 mm	800 W AC	Platinum	89.00%	93.00%	94.00%	91.50%
	1100 W AC	Titanium	90.00%	94.00%	96.00%	91.50%
	1100 W -48 VDC	N/A	85.00%	90.00%	92.00%	90.00%
	1400 W AC	Platinum	89.00%	93.00%	94.00%	91.50%
	1800 W AC	Titanium	90.00%	94.00%	96.00%	94.00%
Redundant 86 mm	2400 W AC	Platinum	89.00%	93.00%	94.00%	91.50%
	2800 W AC	Titanium	90.00%	94.00%	96.00%	94.00%

## Environmental specifications

**Table 37. Continuous Operation Specifications for ASHRAE A2**

Temperature	Specifications
Allowable continuous operations	
Temperature range for altitudes <= 900 m (<= 2953 ft)	10–35°C (50–95°F) with no direct sunlight on the equipment
Humidity percent range (non-condensing at all times)	8% RH with -12°C minimum dew point to 80% RH with 21°C (69.8°F) maximum dew point
Operational altitude de-rating	Maximum temperature is reduced by 1°C/300 m (1.8°F/984 Ft) above 900 m (2953 Ft)

**Table 38. Continuous Operation Specifications for ASHRAE A3**

Temperature	Specifications
Allowable continuous operations	
Temperature range for altitudes <= 900 m (<= 2953 ft)	5–40°C (41–104°F) with no direct sunlight on the equipment
	Excursion Limited Operation
	5-35°C (41-95°F) Continuous Operation 35-40°C (95-104°F) 10% Annual Runtime
Humidity percent range (non-condensing at all times)	8% RH with -12°C minimum dew point to 85% RH with 24°C (75.2°F) maximum dew point
Operational altitude de-rating	Maximum temperature is reduced by 1°C/175 m (1.8°F/574 Ft) above 900 m (2953 Ft)

**Table 39. Continuous Operation Specifications for ASHRAE A4**

Temperature	Specifications
Allowable continuous operations	
Temperature range for altitudes <= 900 m (<= 2953 ft)	5–45°C (41–113°F) with no direct sunlight on the equipment
	Excursion Limited Operation
	5-35°C (41-95°F) Continuous Operation

**Table 39. Continuous Operation Specifications for ASHRAE A4 (continued)**

Temperature	Specifications
	35-40°C (95-104°F) 10% Annual Runtime
	40-45°C (104-113°F) 1% Annual Runtime
Humidity percent range (non-condensing at all times)	8% RH with -12°C minimum dew point to 90% RH with 24°C (75.2°F) maximum dew point
Operational altitude de-rating	Maximum temperature is reduced by 1°C/125 m (1.8°F/410 Ft) above 900 m (2953 Ft)

**Table 40. Common Environmental Specifications for ASHRAE A2, A3 and A4**

Temperature	Specifications
Allowable continuous operations	
Maximum temperature gradient (applies to both operation and non-operation)	20°C in an hour* (36°F in an hour) and 5°C in 15 minutes (9°F in 15 minutes), 5°C in an hour* (9°F in an hour) for tape hardware <i>i</i> <b>NOTE:</b> * - Per ASHRAE thermal guidelines for tape hardware, these are not instantaneous rates of temperature change.
Non-operational temperature limits	-40 to 65°C (-40 to 149°F)
Non-operational humidity limits	5% to 95% RH with 27°C (80.6°F) maximum dew point
Maximum non-operational altitude	12,000 meters (39,370 feet)
Maximum operational altitude	3,048 meters (10,000 feet)

**Table 41. Maximum vibration specifications**

Maximum vibration	Specifications
Operating	0.21 G <sub>rms</sub> at 5 Hz to 500 Hz for 10 minutes (all operation orientations)
Storage	1.88 G <sub>rms</sub> at 10 Hz to 500 Hz for 15 minutes (all six sides tested)

**Table 42. Maximum shock pulse specifications**

Maximum shock pulse	Specifications
Operating	Six consecutively executed shock pulses in the positive and negative x, y, and z axis of 6 G for up to 11 ms
Storage	Six consecutively executed shock pulses in the positive and negative x, y, and z axis (one pulse on each side of the system) of 71 G for up to 2 ms

## Particulate and gaseous contamination specifications

The following table defines the limitations that help avoid any equipment damage or failure from particulates and gaseous contamination. If the levels of particulates or gaseous pollution exceed the specified limitations and result in equipment damage or failure, you may need to rectify the environmental conditions. Remediation of environmental conditions is the responsibility of the customer.

**Table 43. Particulate contamination specifications**

Particulate contamination	Specifications
Air filtration	Data center air filtration as defined by ISO Class 8 per ISO 14644-1 with a 95% upper confidence limit <i>i</i> <b>NOTE:</b> This condition applies to data center environments only. Air filtration requirements do not apply to IT equipment designed to be

**Table 43. Particulate contamination specifications (continued)**

Particulate contamination	Specifications
	<p>used outside a data center, in environments such as an office or factory floor.</p> <p><b>i</b> <b>NOTE:</b> Air entering the data center must have MERV11 or MERV13 filtration.</p>
Conductive dust	<p>Air must be free of conductive dust, zinc whiskers, or other conductive particles</p> <p><b>i</b> <b>NOTE:</b> This condition applies to data center and non-data center environments.</p>
Corrosive dust	<ul style="list-style-type: none"> <li>• Air must be free of corrosive dust</li> <li>• Residual dust present in the air must have a deliquescent point less than 60% relative humidity</li> </ul> <p><b>i</b> <b>NOTE:</b> This condition applies to data center and non-data center environments.</p>

**Table 44. Gaseous contamination specifications**

Gaseous contamination	Specifications
Copper coupon corrosion rate	<300 Å/month per Class G1 as defined by ANSI/ISA71.04-2013
Silver coupon corrosion rate	<200 Å/month as defined by ANSI/ISA71.04-2013

## Thermal air restrictions

### ASHRAE A3 environment

- Two PSUs are required in redundant mode, however single PSU failure is not supported.
- PCIe SSD is not supported.
- DIMMs greater than 32 GB are not supported.
- Both SW and DW GPGPU/FPGA are not supported.
- CPU TDP greater than 200W are not supported.
- Rear drives are not supported.
- PCIe card TDP more than 25 W is not supported.
- OCP is supported with 85C active optic cable.

### ASHRAE A4 environment

- Two PSUs are required in redundant mode, however single PSU failure is not supported.
- PCIe SSD is not supported.
- DIMMs greater than 32 GB are not supported.
- Both SW and DW GPGPU/FPGA are not supported.
- CPU TDP greater than 200W are not supported.
- Rear drives are not supported.
- PCIe card TDP more than 25 W is not supported.
- OCP is supported with 85C active cable and cards Tier<=4
- BOSS N1 is not supported.

### Liquid cooling: ASHRAE A3 environment

- Two PSUs are required in redundant mode, however single PSU failure is not supported.
- PCIe SSD is not supported.

- DIMMs greater than 32 GB are not supported.
- Both SW and DW GPGPU/FPGA are not supported.
- Rear drives are not supported.
- PCIe card TDP more than 25 W is not supported.
- OCP is supported with 85C active optic cable.

## Liquid cooling: ASHRAE A4 environment

- Two PSUs are required in redundant mode, however single PSU failure is not supported.
- PCIe SSD is not supported.
- DIMMs greater than 32 GB are not supported.
- Both SW and DW GPGPU/FPGA are not supported.
- Rear drives are not supported.
- PCIe card TDP more than 25 W is not supported.
- OCP is supported with 85C active cable and cards Tier<=5
- BOSS N1 is not supported.

## Other Restrictions

High temp spec(85C) active optics cable is required for cards,

- 25Gb and above PCIe/OCP cards require DAC or 85C active optics cable.

## Thermal restriction matrix

**Table 45. Air cooling: Thermal restriction matrix(non-GPU)**

Configuration		No BP	8 x 2.5" U.2	16 x 2.5" SAS (SmartFlow)	16 x 2.5" U.2 (SmartFlow)	24 x 2.5" SAS		16x2.5" SAS + 8x2.5" U.2	8x3.5"	12x3.5"			
Rear storage		No Rear Drives	No Rear Drives	No Rear Drives	No Rear Drives	No Rear Drives	2x Rear 2.5" w/ 2x Rear-Fan	4x Rear 2.5" w/ 3x Rear-Fan	No Rear Drives	No Rear Drives	No Rear Drives	2x Rear 2.5" w/ 2x Rear-Fan	4x Rear 2.5" w/ 3x Rear-Fan
CPU cTDP Max	CPU TDP												
CPU TDP / cTDP	240W	210W	HPR SILVER Fan + 2U STD HSK							HPR SILVER Fan [75%] + 2U STD HSK	HPR GOLD Fan [70%] + 2U EXT HSK		
		200W											
	300 W	290 W	HPR SILVER Fan + 2U EXT HSK							HPR SILVER Fan [75%] + 2U EXT HSK	HPR GOLD Fan [70%] + 2U EXT HSK <b>(Note 1)</b>		
		280 W											
	400 W	360 W	HPR SILVER Fan + 2U EXT HSK			HPR GOLD Fan + 2U EXT HSK			HPR GOLD Fan [75%]	Requires LC			
		320 W											

**Table 45. Air cooling: Thermal restriction matrix(non-GPU) (continued)**

Configuration		No BP	8 x 2.5" U.2	16 x 2.5" SAS (SmartFlow)	16 x 2.5" U.2 (SmartFlow)	24 x 2.5" SAS			16x2.5" SAS + 8x2.5" U.2	8x3.5"	12x3.5"		
Rear storage		No Rear Drives	No Rear Drives	No Rear Drives	No Rear Drives	No Rear Drives	2x Rear 2.5" w/ 2x Rear-Fan	4x Rear 2.5" w/ 3x Rear-Fan	No Rear Drives	No Rear Drives	No Rear Drives	2x Rear 2.5" w/ 2x Rear-Fan	4x Rear 2.5" w/ 3x Rear-Fan
CPU cTDP Max	CPU TDP												
	340 W												
Memory	16GB RDIMM	HPR SILVER Fan			HPR GOLD Fan			HPR SILVER Fan [75%]		HPR GOLD Fan [70%]			
	32GB RDIMM												
	64GB RDIMM												
	128GB RDIMM	HPR GOLD Fan		Not supported		Not supported							
	256GB RDIMM (Note 2)	HPR GOLD Fan		HPR GOLD Fan (Note 1)		Not supported							

**Note 1:** Supported ambient temperature is 30°C.

**Note 2:** Support SKHYNIX RDIMM only

**Table 46. Air cooling: Thermal restriction matrix(GPU Configuration)**

Configuration				No BP	8 x 2.5" U.2	16 x 2.5" SAS (SmartFlow)	16 x 2.5" U.2 (SmartFlow)	24 x 2.5" SAS	16x2.5" SAS + 8x2.5" U.2	8x3.5"		
Rear storage				No Rear Drives								
CPU cTDP Max	CPU TDP	Model										
CPU TDP/ cTDP	240 W	210 W	9334	HPR GOLD Fan + 1U EXT HSK						HPR GOLD Fan [75%] + 1U EXT HSK		
		200 W	9254									
			9224									
			9124									
	300 W	290 W	9634	Not Supported						Requires LC		
		280 W	9534									
		290 W	9454									
		280 W	9354									
	400 W	360 W	9654	HPR GOLD Fan + 1U EXT HSK		Not Supported						Requires LC
			9554	HPR GOLD Fan								
9474F		+ 1U EXT HSK (Note 1)										
320 W				9374F								

**Table 46. Air cooling: Thermal restriction matrix(GPU Configuration) (continued)**

Configuration				No BP	8 x 2.5" U.2	16 x 2.5" SAS (SmartFlow)	16 x 2.5" U.2 (SmartFlow)	24 x 2.5" SAS	16x2.5" SAS + 8x2.5" U.2	8x3.5"
Rear storage				No Rear Drives						
CPU cTDP Max	CPU TDP	Model								
400 W( <b>Note 2</b> )	340 W	9274F	9174F	HPR GOLD Fan + 1U EXT HSK						
		9734								
	360 W	9754	HPR GOLD Fan + 1U EXT HSK ( <b>Note 1</b> )							
Memory	16GB RDIMM		HPR GOLD Fan							HPR GOLD Fan [75%]
	32GB RDIMM									
	64GB RDIMM									
	128GB RDIMM		HPR GOLD Fan		Not Supported	Not Supported				
	256GB RDIMM( <b>Note 3</b> )				HPR GOLD Fan ( <b>Note 1</b> )					
GPU	A2		HPR GOLD Fan							HPR GOLD Fan [75%] ( <b>Note 1</b> )
	A16 64GB									
	A30 24GB									
	A40 48GB									
	A100 80GB									
	MI210 64GB									HPR GOLD Fan [75%]

**Note 1:** Supported ambient temperature is 30°C.

**Note 2:** Bergamo CPUs.

**Note 3:** Support SKHYNIX RDIMM only

**i** **NOTE:** “High-Performance GOLD Fan” to be supported on all GPU configs.

**i** **NOTE:** GPU is not supported on 12x3.5-inch configs and system configs with rear module installed.

**Table 47. Air Cooling: Thermal Guidance(non GPU)**

Configuration			No BP	8 x 2.5" U.2	16 x 2.5" SAS (SmartFlow)	16 x 2.5" U.2 (SmartFlow)	24 x 2.5" SAS		16x2.5" SAS + 8x2.5" U.2	8x3.5"	12x3.5"			
Rear storage			No Rear Drives	No Rear Drives	No Rear Drives	No Rear Drives	No Rear Drives	2x Rear 2.5" w/ 2x Rear-Fan	4x Rear 2.5" w/ 3x Rear-Fan	No Rear Drives	No Rear Drives	No Rear Drives	2x Rear 2.5" w/ 2x Rear-Fan	4x Rear 2.5" w/ 3x Rear-Fan
CPU cTDP Max	Model	Core Count #	No Rear Drives	No Rear Drives	No Rear Drives	No Rear Drives	No Rear Drives	2x Rear 2.5" w/ 2x Rear-Fan	4x Rear 2.5" w/ 3x Rear-Fan	No Rear Drives	No Rear Drives	No Rear Drives	2x Rear 2.5" w/ 2x Rear-Fan	4x Rear 2.5" w/ 3x Rear-Fan
CPU TDP / cTDP	240 W	9334	32	35°C							35°C	35°C		
		9254	24	35°C							35°C	35°C		
		9224	24	35°C							35°C	35°C		
		9124	16	35°C							35°C	35°C		
	300 W	9634	84	35°C							35°C	30°C		
		9534	64	35°C							35°C	30°C		
		9454	48	35°C							35°C	30°C		
		9354	32	35°C							35°C	30°C		
	400 W	9654	96	35°C							35°C	Requires LC		
		9554	64	35°C							35°C	Requires LC		
		9474F	48	35°C							35°C	Requires LC		
		9374F	32	35°C							35°C	Requires LC		
		9274F	24	35°C							35°C	Requires LC		
		9174F	16	35°C							35°C	Requires LC		
		9734	112	35°C							35°C	Requires LC		
Memory	16GB RDIMM		35°C							35°C	35°C			
	32GB RDIMM		35°C							35°C	35°C			
	64GB RDIMM		35°C							35°C	35°C			
	128GB RDIMM		35°C	Not Supported		Not Supported								
	256GB RDIMM (Note 1)		35°C	30°C		Not Supported								

**Note 1:** Support SKHYNIX RDIMM only

**(i) NOTE:** Not all backplanes/risers support liquid cooling; these are listed as "No Support".

**(i) NOTE:** Inlet temperature determined by lowest degree requirement.



**Table 48. Air Cooling: Thermal Guidance (GPU Configuration)**

Configuration			No BP	8 x 2.5" U.2	16 x 2.5" SAS (SmartFlow)	16 x 2.5" U.2 (SmartFlow)	24 x 2.5" SAS	16x2.5" SAS + 8x2.5" U.2	8x3.5"
Rear storage			No Rear Drives						
CPU cTDP Max	Model	Core Count#							
CPU TDP/ cTDP	240W	9334	32	35°C					35°C
		9254	24						
		9224	24						
		9124	16						
	300 W	9634	84	35°C					35°C
		9534	64						
		9454	48						
		9354	32						
	400 W	9654	96	35°C	Not Supported				Requires LC
		9554	64	30°C					
		9474F	48						
		9374F	32						
		9274F	24	35°C					
		9174F	16						
9734		112							
	9754	128	30°C						
Memory	16GB RDIMM		35°C					35°C	
	32GB RDIMM								
	64GB RDIMM								
	128GB RDIMM		35°C	Not Supported	Not Supported		Not Supported		
	256GB RDIMM (Note 1)			30°C					
GPU	A2		35°C					30°C	
	A16 64GB							35°C	
	A30 24GB								
	A40 48GB								
	A100 80GB								
	MI210 64GB								

**Note 1:** Support SKHYNIX RDIMM only

**NOTE:** Not all backplanes/risers support liquid cooling; these are listed as "No Support".

**NOTE:** Inlet temperature determined by lowest degree requirement.

**Table 49. Liquid cooling: Thermal restriction matrix(non-GPU)**

Configuration		No BP	8 x 2.5" U.2	24 x 2.5" SAS		8x3.5"	12x3.5"			
Rear storage		No Rear Drives	No Rear Drives	2x Rear 2.5" w/ 2x Rear-Fan	4x Rear 2.5" w/ 3x Rear-Fan	No Rear Drives	No Rear Drives	2x Rear 2.5" w/ 2x Rear-Fan	4x Rear 2.5" w/ 3x Rear-Fan	
CPU	All CPU TDP SKUs	HPR SILVER Fan				HPR SILVER Fan [75%]	HPR GOLD Fan [70%]			
Memory	16GB RDIMM	HPR SILVER Fan				HPR SILVER Fan [75%]	HPR GOLD Fan [70%]			
	32GB RDIMM									
	64GB RDIMM									
	128GB RDIMM	HPR GOLD Fan		Not supported						
	256GB RDIMM (Note 1)									

**Note 1:** Support SKHYNIX RDIMM only

**Note:** Use “High-Performance Silver” fan for all 2.5” and 8x3.5” configs.

**Note:** Use “High-Performance GOLD” fan for all 12x3.5” configs.

**Table 50. Liquid cooling: Thermal restriction matrix(GPU Configuration)**

Configuration		No BP	8 x 2.5" U.2	8x3.5"
Rear storage		No Rear Drives	No Rear Drives	No Rear Drives
CPU	All CPU TDP SKUs	HPR GOLD Fan		HPR GOLD Fan [75%]
Memory	16GB RDIMM	HPR GOLD Fan		HPR GOLD Fan [75%]
	32GB RDIMM			
	64GB RDIMM			
	128GB RDIMM	HPR GOLD Fan		Not supported
	256GB RDIMM (Note 2)			
GPU	A2	HPR GOLD Fan		HPR GOLD Fan [75%] <b>Note 1</b>
	A16 64GB			
	A30 24GB			
	A40 48GB			
	A100 80GB			
	MI210 64GB			HPR GOLD Fan [75%]

**Note 1:** Supported ambient temperature is 30°C.

**Note 2:** Support SKHYNIX RDIMM only

**Note:** “High-Performance GOLD Fan” to be supported on all GPU configs.

**Note:** GPU is not supported on 12x3.5” configs and system configs with rear module installed.

**Table 51. Label reference**

<b>Label</b>	<b>Description</b>
HPR SILVER (Silver)	High performance (silver grade)
HPR GOLD (Gold)	High performance (gold grade)
HSK	Heat sink
LP	Low profile
FH	Full height

## Appendix B. Standards compliance

The system conforms to the following industry standards.

**Table 52. Industry standard documents**

Standard	URL for information and specifications
<b>ACPI</b> Advance Configuration and Power Interface Specification, v2.0c	<a href="https://uefi.org/specsandtesttools">https://uefi.org/specsandtesttools</a>
<b>Ethernet</b> IEEE 802.3-2005	<a href="https://standards.ieee.org/">https://standards.ieee.org/</a>
<b>HDG</b> Hardware Design Guide Version 3.0 for Microsoft Windows Server	<a href="https://microsoft.com/whdc/system/platform/pcdesign/desguide/serverdg.msp">microsoft.com/whdc/system/platform/pcdesign/desguide/serverdg.msp</a>
<b>IPMI</b> Intelligent Platform Management Interface, v2.0	<a href="https://intel.com/design/servers/ipmi">intel.com/design/servers/ipmi</a>
<b>DDR5 Memory</b> DDR5 SDRAM Specification	<a href="https://jedec.org/standards-documents/docs/jesd79-4.pdf">jedec.org/standards-documents/docs/jesd79-4.pdf</a>
<b>PCI Express</b> PCI Express Base Specification Rev. 2.0 and 3.0	<a href="https://pcisig.com/specifications/pciexpress">pcisig.com/specifications/pciexpress</a>
<b>PMBus</b> Power System Management Protocol Specification, v1.2	<a href="http://pmbus.org/Assets/PDFS/Public/PMBus_Specification_Part_1_Rev_1-1_20070205.pdf">http://pmbus.org/Assets/PDFS/Public/PMBus_Specification_Part_1_Rev_1-1_20070205.pdf</a>
<b>SAS</b> Serial Attached SCSI, v1.1	<a href="http://www.t10.org/">http://www.t10.org/</a>
<b>SATA</b> Serial ATA Rev. 2.6; SATA II, SATA 1.0a Extensions, Rev. 1.2	<a href="https://sata-io.org">sata-io.org</a>
<b>SMBIOS</b> System Management BIOS Reference Specification, v2.7	<a href="https://dmtf.org/standards/smbios">dmtf.org/standards/smbios</a>
<b>TPM</b> Trusted Platform Module Specification, v1.2 and v2.0	<a href="https://trustedcomputinggroup.org">trustedcomputinggroup.org</a>
<b>UEFI</b> Unified Extensible Firmware Interface Specification, v2.1	<a href="https://uefi.org/specifications">uefi.org/specifications</a>
<b>USB</b> Universal Serial Bus Specification, Rev. 2.7	<a href="https://usb.org/developers/docs">usb.org/developers/docs</a>

## Appendix C Additional resources

**Table 53. Additional resources**

Resource	Description of contents	Location
Installation and Service Manual	<p>This manual, available in PDF format, provides the following information:</p> <ul style="list-style-type: none"> <li>• Chassis features</li> <li>• System Setup program</li> <li>• System indicator codes</li> <li>• System BIOS</li> <li>• Remove and replace procedures</li> <li>• Diagnostics</li> <li>• Jumpers and connectors</li> </ul>	<a href="https://Dell.com/Support/Manuals">Dell.com/Support/Manuals</a>
Getting Started Guide	<p>This guide ships with the system, and is also available in PDF format. This guide provides the following information:</p> <ul style="list-style-type: none"> <li>• Initial setup steps</li> </ul>	<a href="https://Dell.com/Support/Manuals">Dell.com/Support/Manuals</a>
Rack Installation Guide	This document ships with the rack kits, and provides instructions for installing a server in a rack.	<a href="https://Dell.com/Support/Manuals">Dell.com/Support/Manuals</a>
System Information Label	The system information label documents the system board layout and system jumper settings. Text is minimized due to space limitations and translation considerations. The label size is standardized across platforms.	Inside the system chassis cover
Quick Resource Locator (QRL)	This code on the chassis can be scanned by a phone application to access additional information and resources for the server, including videos, reference materials, service tag information, and Dell contact information.	Inside the system chassis cover
Enterprise Infrastructure Planning Tool (EIPT)	The Dell online EIPT enables easier and more meaningful estimates to help you determine the most efficient configuration possible. Use EIPT to calculate the power consumption of your hardware, power infrastructure, and storage.	<a href="https://Dell.com/calc">Dell.com/calc</a>