

Dell PowerEdge R760xs

Technical Guide

Notes, cautions, and warnings

 **NOTE:** A NOTE indicates important information that helps you make better use of your product.

 **CAUTION:** A CAUTION indicates either potential damage to hardware or loss of data and tells you how to avoid the problem.

 **WARNING:** A WARNING indicates a potential for property damage, personal injury, or death.

Chapter 1: System overview	5
Key workloads.....	5
New technologies.....	5
Chapter 2: System features and generational comparison	7
Chapter 3: Chassis views and features	9
Chassis views.....	9
Front view of the system.....	9
Rear view of the system.....	12
Inside the system	14
System diagnostics and indicator codes.....	15
Quick Resource Locator.....	17
Chapter 4: Processor	19
Processor features	19
Supported processors.....	19
Chipset.....	20
Chipset features.....	20
Chapter 5: Memory subsystem	21
Supported memory.....	21
General memory module installation guidelines.....	21
Chapter 6: Storage	23
Storage controllers.....	23
Storage controller feature matrix.....	23
Server storage controllers User Guide.....	25
RAID - Redundant Array of Independent Disks.....	25
Datasheets and PERC performance scaling decks.....	25
Boot Optimized Storage Solution (BOSS).....	25
Supported Drives.....	27
External Storage.....	27
Chapter 7: Networking	28
Overview.....	28
OCP 3.0 support.....	28
Chapter 8: Slot priority matrix	29
Expansion card installation guidelines.....	29
Chapter 9: Power, thermal, and acoustics	36
Power.....	36

PSU specifications.....	37
Thermal.....	38
Acoustics.....	38
Acoustical configurations of R760xs	38
Chapter 10: Rack, rails, and cable management.....	40
Rails information.....	40
A11 Sliding Rails features summary.....	40
A8 Static Rails features summary.....	41
Cable Management Arm.....	42
Strain Relief Bar	43
Rack Installation.....	43
Chapter 11: Supported operating systems.....	48
Chapter 12: Dell OpenManage Systems Management.....	49
Integrated Dell Remote Access Controller (iDRAC).....	49
Systems Management software support matrix.....	50
Chapter 13: Appendix A. Standards compliance.....	52
Chapter 14: Appendix B: Additional resources.....	53
Customer kits.....	53
Dell Upgrades.....	53
Upgrades portfolio.....	53
Upgrades reference links.....	55
Documentation.....	55
Chapter 15: Appendix C: Additional specifications.....	56
Chassis dimensions	56
System weight.....	57
Video specifications.....	57
USB ports specifications.....	58
PSU rating.....	58
Environmental specifications.....	59
Thermal restriction matrix.....	60
Chapter 16: Appendix D: Service and support.....	64
Default support levels.....	64
Default deployment levels.....	64
Other services and support information.....	64
Dell deployment services.....	64
Dell custom deployment Services.....	68
Dell Residency Services.....	68
Dell Data Migration Services.....	68
Dell Enterprise Support Services.....	69
Enterprise connectivity.....	71
Dell TechDirect.....	72
Dell Technologies Consulting Services.....	72

System overview

The Dell PowerEdge R760xs is Dell's latest two-socket, rack server that is designed to run complex workloads using highly scalable memory, I/O, and network options. The systems feature the 4th Gen Intel® Xeon® Scalable Processor (Socket P+LGA-4677), up to 16 DIMMs, PCI Express® (PCIe) 5.0 enabled expansion slots, and a broad selection of network interface technologies.

Topics:

- [Key workloads](#)
- [New technologies](#)

Key workloads

The target workloads for the PowerEdge R760xs include virtualization, medium density VM and VDI, and scale-out database. .

New technologies

Table 1. New technologies

Technology	Detailed Description
4 th Gen Intel® Xeon® Scalable Processors	Core count: Up to 32 core processor
	UPI speed: Up to 4 links per CPU, speed: 12.8 GT/s, 14.4 GT/s, 16 GT/s
	Maximum number of PCIe lanes per CPU: Integrated 80 PCIe 5.0 lanes @ 32GT/s PCIe Gen5
	Maximum TDP: 250 W
4800 MT/s DDR5 Memory	Max 8 DIMMs per processor and 16 DIMMs per system
	Supports DDR5 ECC RDIMM
GPUs	Max 2 x 75 W SW GPUs (NVIDIA A2)
Flex I/O	Optional LOM board, 2x1GbE with BCM5720 LAN controller
	Rear I/O with: <ul style="list-style-type: none"> • 1x Dedicated iDRAC Ethernet port • 1 x USB 3.0 • 1 x USB 2.0 • 1 x VGA port
	Serial Port Option with STD RIO board
	Optional OCP Mezz 3.0 (supported by x8 PCIe lanes)
	Front I/O with: <ul style="list-style-type: none"> • 1 x USB 2.0 • 1x iDRAC Direct (Micro-AB USB) port • 1 x VGA port
CPLD 1-wire	Support payload data of Front PERC, Riser, BP and Rear IO to BOSS-N1 and iDRAC
Dedicated PERC	Front Storage module PERC with Front PERC11 & PERC12

Table 1. New technologies (continued)

Technology	Detailed Description
Software RAID	OS RAID / S160
Power Supplies	60 mm dimension is the new PSU form factor on 16G design <ul style="list-style-type: none">● 600 W Platinum 100–240 VAC/ 240 VDC● 700 W Titanium 200–240 VAC/240 VDC● 800 W Platinum 100–240 VAC/ 240 VDC● 1100 W DC/-48-(-60) V● 1100 W Titanium 100–240 VAC/ 240 VDC● 1400 W Platinum 100–240 VAC/ 240 VDC● 1800 W Platinum 100–240 VAC/ 240 VDC

System features and generational comparison

The following table shows the comparison between the PowerEdge R760xs with the PowerEdge R750xs.

Table 2. Features comparison

Feature	PowerEdge R760xs	PowerEdge R750xs
Processor	Maximum two 4 th Generation Intel® Xeon® Scalable processors with maximum 32 cores per processor	Maximum two 3 rd Generation Intel® Xeon® Scalable processors with maximum 32 cores per processor
Processor Interconnect	Intel Ultra Path Interconnect (UPI) , up to 3 links per CPU	Intel Ultra Path Interconnect (UPI)
Memory	16 DDR5 DIMM slots Supports RDIMM 1TB max Speed maximum 4800 MT/s Supports registered ECC DDR5 DIMMs only NVDIMM : No	16 DDR4 DIMM slots Supports RDIMM 1 TB max Speed maximum 3200 MT/s Supports registered ECC DDR4 DIMMs only Apache Pass : No NVDIMM : No
Storage Drives	Front bays: <ul style="list-style-type: none"> 0 drive bay Maximum 8x 3.5-inch SAS/SATA (HDD/SSD) max 160 TB Maximum 12x 3.5-inch SAS/SATA (HDD/SSD) max 240 TB Maximum 8x 2.5-inch SAS/SATA/NVMe (HDD/SSD) max 122.88 TB Maximum 16x 2.5-inch SAS/SATA (HDD/SSD) max 121.6 TB Maximum 16x 2.5-inch (SAS/SATA) + 8x 2.5-inch (NVMe) (HDD/SSD) max 244.48 TB 	Front bays: <ul style="list-style-type: none"> 0 drive bay Maximum 8x 3.5-inch SAS/SATA (HDD/SSD) max 128 TB Maximum 12x 3.5-inch SAS/SATA (HDD/SSD) maximum 192 TB Maximum 8x 2.5-inch SAS/SATA/NVMe (HDD/SSD) maximum 61.44 TB Maximum 16x 2.5-inch SAS/SATA (HDD/SSD) maximum 122.88 TB Maximum 16x 2.5-inch (SAS/SATA) + 8x 2.5-inch (NVMe) (HDD/SSD) maximum 184.32 TB
	Rear bays: <ul style="list-style-type: none"> Maximum 2x 2.5-inch SAS/SATA/NVMe (HDD/SSD) max 30.72 TB 	Rear bays: <ul style="list-style-type: none"> Maximum 2x 2.5-inch SAS/SATA/NVMe (HDD/SSD) maximum 15.36 TB
Storage Controllers	Internal controllers: H965i, HBA465i (post RTS), H755, H755N, H355, HBA355i Internal Boot: Internal Dual SD Module or Boot Optimized Storage Subsystem (BOSS N1): HWRaid 2x M.2 SSDs and Internal USB External: 965e (post RTS), HBA 355e Software RAID: S160	Internal controllers: PERC H345, PERC H355, PERC H745, PERC H755, PERC H755N, HBA355i Internal Boot: Internal Dual SD Module or Boot Optimized Storage Subsystem (BOSS S2): HWRaid 2x M.2 SSDs or Internal USB External PERC (RAID): PERC H840, HBA355e Software RAID: S150
PCIe SSD	Front: Maximum 16 x 2.5-inch (NVMe drives)	Maximum 16 x 2.5-inch (NVMe drives)
	Rear: Up to 2 x 2.5-inch NVMe	
PCIe Slots	Up to 6 PCIe slots (2 x Gen5, 4 x Gen4)	Up to 6 PCIe slots (5 x Gen4, 1 x Gen5)

Table 2. Features comparison (continued)

Feature	PowerEdge R760xs	PowerEdge R750xs
Embedded NIC (LOM)	2x 1GbE LOM	2x 1GbE LOM
Networking Options (OCP 3.0)	Rear: 1 x OCP 3.0 (x8 PCIe lanes)	Maximum 1 OCP 3.0
GPU	Nvidia A2 (60 W, LP)	Not supported
USB Ports	Front ports <ul style="list-style-type: none"> • 1x Dedicated iDRAC micro-USB • 1x USB 2.0 • 1x VGA 	Front ports <ul style="list-style-type: none"> • 1x Dedicated iDRAC micro-USB • 1x USB 2.0 • 1x VGA
	Rear ports: <ul style="list-style-type: none"> • 1x USB 2.0 • 1x Serial (optional) • 1x USB 3.0 • 2x Ethernet • 1x VGA 	Rear ports: <ul style="list-style-type: none"> • 1x USB 2.0 • 1x Serial (optional) • 1x USB 3.0 • 2x Ethernet • 1x VGA
	Internal port: <ul style="list-style-type: none"> • 1x USB 3.0 (optional) 	Internal port: <ul style="list-style-type: none"> • 1x USB 3.0 (optional)
Rack Height	2U rack server	2U rack server
Power Supplies	<ul style="list-style-type: none"> • 1800 W Platinum 100–240 VAC/ 240 VDC • 1400 W Platinum 100–240 VAC/ 240 VDC • 1100 W Titanium 100–240 VAC/ 240 VDC • 1100 W DC/-48–(-60) V • 800 W Platinum 100–240 VAC/ 240 VDC • 700 W Titanium 200–240 VAC/240 VDC • 600 W Platinum 100–240 VAC/ 240 VDC 	<ul style="list-style-type: none"> • 1800 W Platinum 100–240 VAC/ 240 VDC • 1400 W Platinum 100–240 VAC/ 240 VDC • 1100 W Titanium 100–240 VAC/ 240 VDC • 1100 W DC/-48–(-60) V • 800 W Platinum 100–240 VAC/ 240 VDC • 700 W Titanium 200–240 VAC/240 VDC • 600 W Platinum 100–240 VAC/ 240 VDC
System Management	<ul style="list-style-type: none"> • Lifecycle Controller 3.x • OpenManage • QuickSync 2.0 • OpenManage Enterprise Power Manager • Digital License Key • iDRAC Direct (dedicated micro-USB port) • Easy Restore 	<ul style="list-style-type: none"> • Lifecycle Controller 3.x • OpenManage • QuickSync 2.0 • OpenManage Enterprise Power Manager • Digital License Key • iDRAC Direct (dedicated micro-USB port) • Easy Restore
Availability	<p>Hot-plug drives</p> <p>Hot-plug redundant cooling</p> <p>Hot-plug redundant power supplies</p> <p>BOSS-N1</p>	<p>Hot-plug drives</p> <p>Hot-plug redundant cooling</p> <p>Hot-plug redundant power supplies</p> <p>IDSDM</p> <p>BOSS S2</p>

Chassis views and features

Topics:

- Chassis views

Chassis views

Front view of the system



Figure 1. Front view of 16 x 2.5-inch SAS/SATA + 8 x 2.5-inch NVMe drive system



Figure 2. Front view of 16 x 2.5-inch SAS/SATA drive system

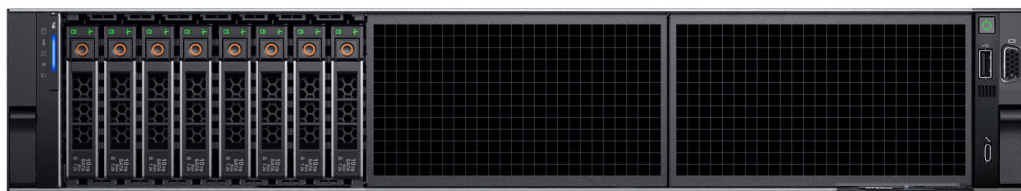

Figure 3. Front view of 8 x 2.5-inch SAS/SATA or NVMe drive system



Figure 4. Front view of 12 x 3.5-inch SAS/SATA drive system



Figure 5. Front view of 8 x 3.5-inch SAS/SATA drive system

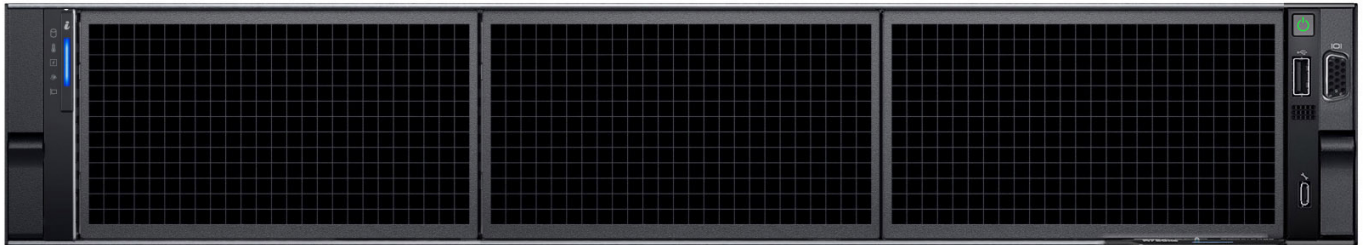

Figure 6. Front view of no backplane configuration (0 drive system)

Left control panel view

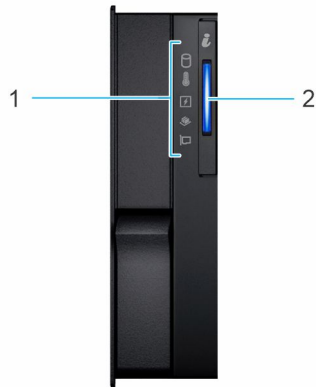

Figure 7. Left control panel

Table 3. Left control panel

Item	Indicator, button, or connector	Icon	Description
1	Status LED indicators	NA	Indicates the status of the system. For more information, see the Status LED indicators section.
2	System health and system ID		Indicates the system health. For more information, see the System health and system ID indicator codes section.

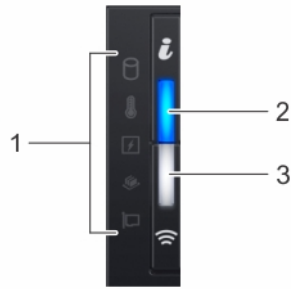

Figure 8. Left control panel with optional iDRAC Quick Sync 2 indicator

Table 4. Left control panel with optional iDRAC Quick Sync 2 indicator

Item	Indicator, button, or connector	Icon	Description
1	Status LED indicators	N/A	Indicates the status of the system. For more information, see the Status LED indicators section.
2	System health and system ID indicator	<i>i</i>	Indicates the system health. For more information, see the System health and system ID indicator codes section.
3	iDRAC Quick Sync 2 wireless indicator (optional)	☰	Indicates if the iDRAC Quick Sync 2 wireless option is activated. The Quick Sync 2 feature allows management of the system using mobile devices. This feature aggregates hardware/firmware inventory and various system level diagnostic/error information that can be used in troubleshooting the system. You can access system inventory, Dell Lifecycle Controller logs or system logs, system health status, and also configure iDRAC, BIOS, and networking parameters. You can also launch the virtual Keyboard, Video, and Mouse (KVM) viewer and virtual Kernel-based Virtual Machine (KVM), on a supported mobile device. For more information, see the Integrated Dell Remote Access Controller User's Guide at www.dell.com/poweredge/manuals .

NOTE: For more information about the indicator codes, see the [System diagnostics and indicator codes](#) section.

Right control panel view

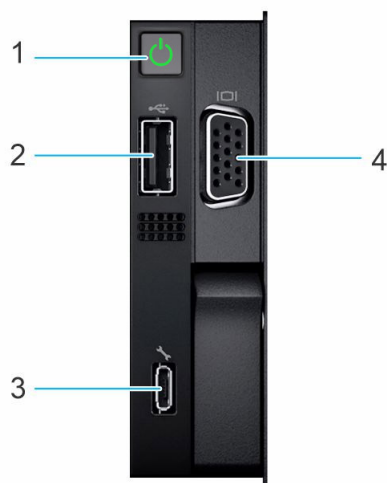





Figure 9. Right control panel

Table 5. Right control panel

Item	Indicator or button	Icon	Description
1	Power button		Indicates if the system is powered on or off. Press the power button to manually power on or off the system. NOTE: Press the power button to gracefully shut down an ACPI-compliant operating system.
2	USB 2.0 port		The USB port is 4-pin, 2.0-compliant. This port enables you to connect USB devices to the system.
3	iDRAC Direct (Micro-AB USB) port		The iDRAC Direct (Micro-AB USB) port enables you to access the iDRAC direct Micro-AB USB features. For more information, see the <i>Integrated Dell Remote Access Controller User's Guide</i> at www.dell.com/poweredge/manuals . NOTE: You can configure iDRAC Direct by using a USB to micro USB (type AB) cable, which you can connect to your laptop or tablet. Cable length should not exceed 3 feet (0.91 meters). Performance could be affected by cable quality.
4	VGA port		Enables you to connect a display device to the system.

Rear view of the system

Figure 10. Rear view of the system



Figure 11. Rear view of the system with no riser and one CPU

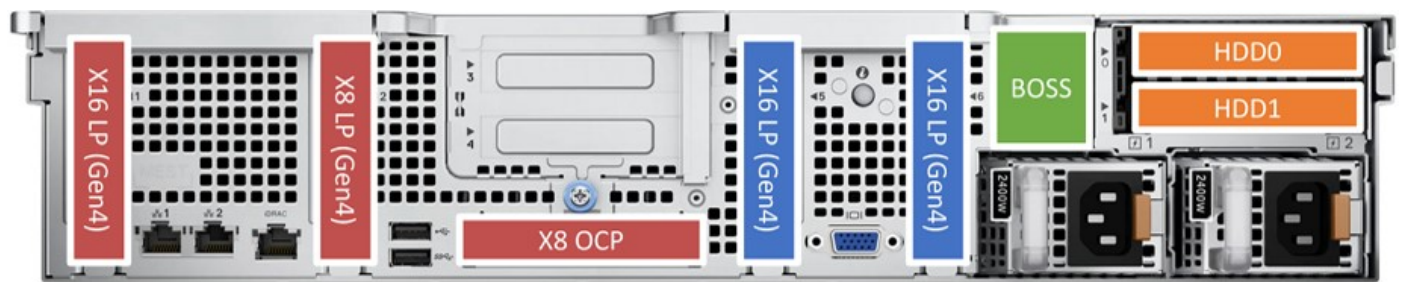

Figure 12. Rear view of the system with no riser and two CPUs

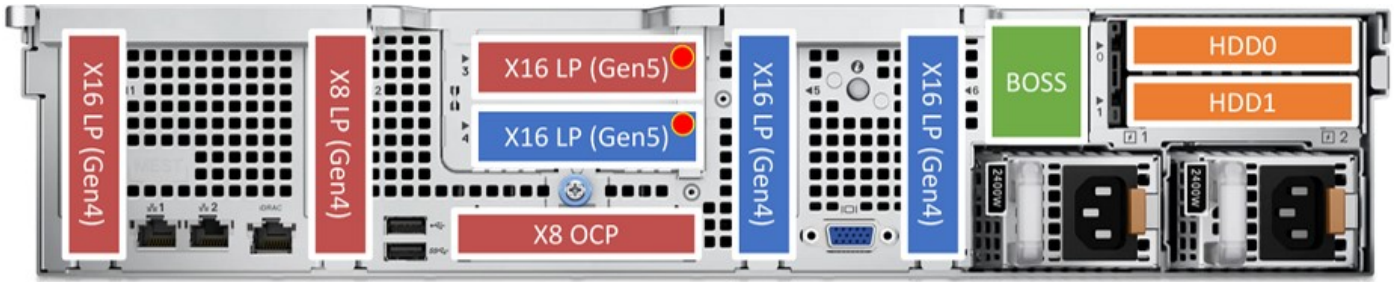

Figure 13. Rear view of the system with Riser 1c

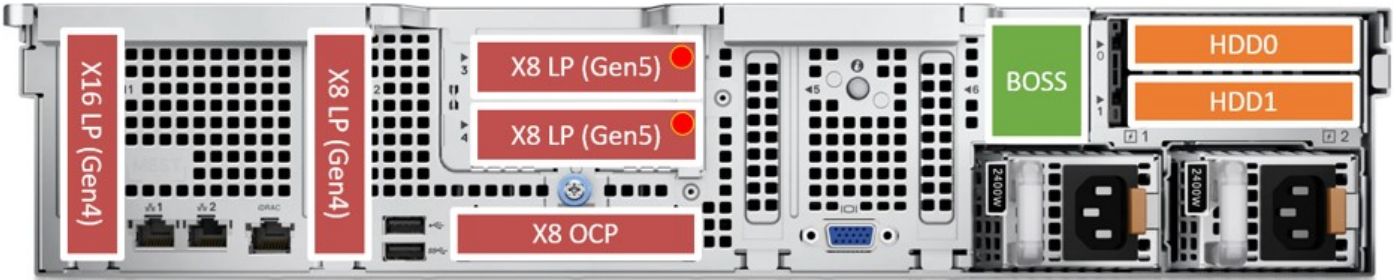

Figure 14. Rear view of the system with Riser 1d

Inside the system

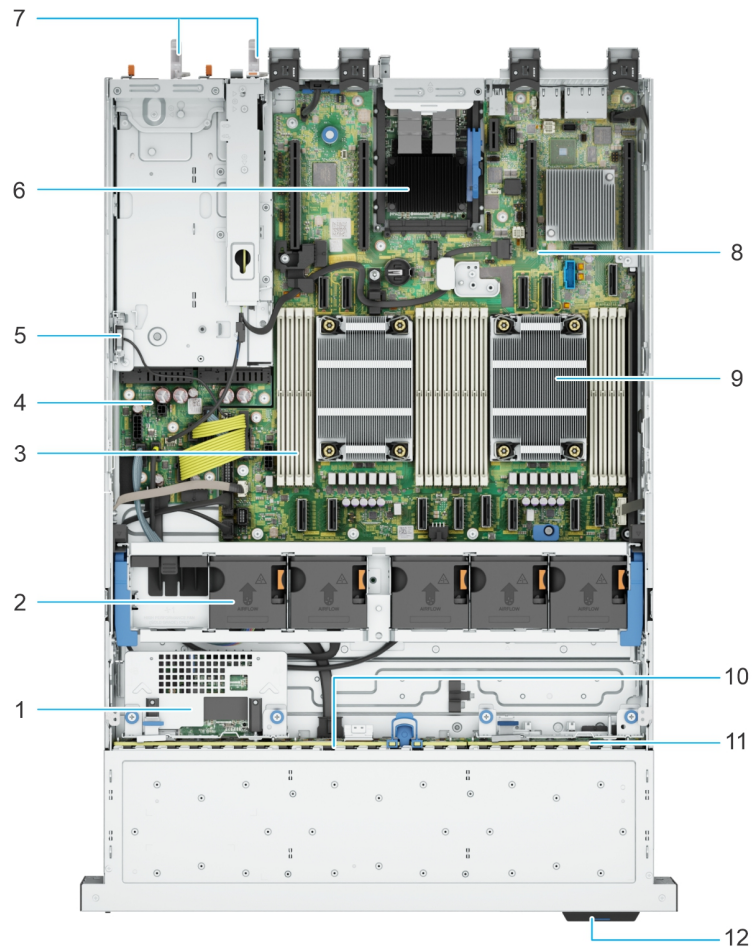

Figure 15. Inside the system without rear drive and riser

- | | |
|----------------------------|---------------------------|
| 1. Rear mounted front PERC | 2. Cooling fan assembly |
| 3. Memory module slots | 4. Power interposer board |
| 5. Intrusion switch | 6. OCP |
| 7. PSU 1 and PSU 2 | 8. System board |
| 9. Processor heat sink | 10. SAS/SATA backplane |
| 11. NVMe backplane | 12. Information tag |

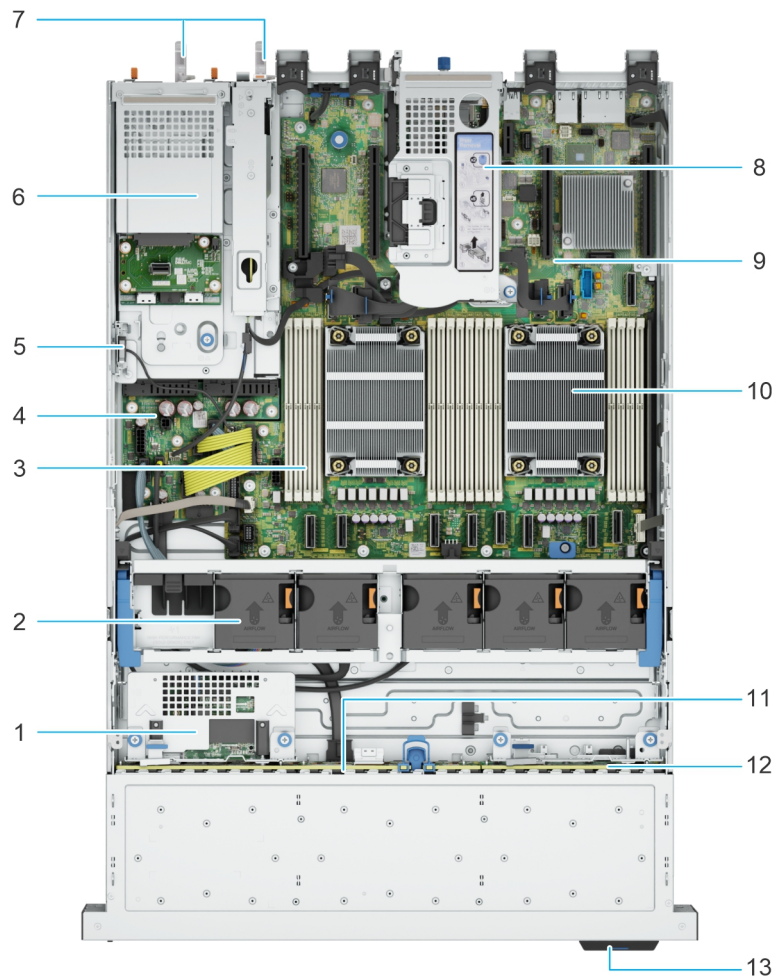

Figure 16. Inside the system with rear drive cage and riser

- | | |
|----------------------------|---------------------------|
| 1. Rear mounted front PERC | 2. Cooling fan assembly |
| 3. Memory module slots | 4. Power interposer board |
| 5. Intrusion switch | 6. Rear drive cage |
| 7. PSU 1 and PSU 2 | 8. Riser |
| 9. System board | 10. Processor heat sink |
| 11. SAS/SATA backplane | 12. NVMe backplane |
| 13. Information tag | |

System diagnostics and indicator codes

The diagnostic indicators on the system front panel display system status during system startup.

Status LED indicators

NOTE: The indicators display solid amber if any error occurs.

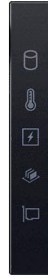







Figure 17. Status LED indicators

Table 6. Status LED indicators and descriptions

Icon	Description	Condition	Corrective action
	Drive indicator	The indicator turns solid amber if there is a drive error.	<ul style="list-style-type: none"> • Check the System Event Log to determine if the drive has an error. • Run the appropriate Online Diagnostics test. Restart the system and run embedded diagnostics (ePSA). • If the drives are configured in a RAID array, restart the system, and enter the host adapter configuration utility program.
	Temperature indicator	The indicator turns solid amber if the system experiences a thermal error (for example, the ambient temperature is out of range or there is a fan failure).	<p>Ensure that none of the following conditions exist:</p> <ul style="list-style-type: none"> • A cooling fan has been removed or has failed. • System cover, air shrouds, or back filler bracket has been removed. • Ambient temperature is too high. • External airflow is obstructed. <p>If the problem persists, see the Getting help section.</p>
	Electrical indicator	The indicator turns solid amber if the system experiences an electrical error (for example, voltage out of range, or a failed power supply unit (PSU) or voltage regulator).	<p>Check the System Event Log or system messages for the specific issue. If it is due to a problem with the PSU, check the LED on the PSU. Reseat the PSU.</p> <p>If the problem persists, see the Getting help section.</p>
	Memory indicator	The indicator turns solid amber if a memory error occurs.	<p>Check the System Event Log or system messages for the location of the failed memory. Reseat the memory module.</p> <p>If the problem persists, see the Getting help section.</p>
	PCIe indicator	The indicator turns solid amber if a PCIe card experiences an error.	<p>Restart the system. Update any required drivers for the PCIe card. Reinstall the card.</p> <p>If the problem persists, see the Getting help section.</p> <p>NOTE: For more information about the supported PCIe cards, see the Expansion cards and expansion card risers > Expansion card installation guidelines section.</p>

System health and system ID indicator codes

The system health and system ID indicator is located on the left control panel of the system.



Figure 18. System health and system ID indicator

Table 7. System health and system ID indicator codes

System health and system ID indicator code	Condition
Solid blue	Indicates that the system is powered on, is healthy, and system ID mode is not active. Press the system health and system ID button to switch to system ID mode.
Blinking blue	Indicates that the system ID mode is active. Press the system health and system ID button to switch to system health mode.
Solid amber	Indicates that the system is in fail-safe mode. If the problem persists, see the Getting help section.
Blinking amber	Indicates that the system is experiencing a fault. Check the System Event Log for specific error messages. For information about the event and error messages generated by the system firmware and agents that monitor system components, go to qrl.dell.com > Look Up > Error Code , type the error code, and then click Look it up .

Quick Resource Locator

The QRL on everything (SILs, GSG, Owner's Manual except on the EST) is a generic QRL for R760xs that leads to a webpage for that product. That webpage has links for things like setup and service videos, iDRAC manual, and other things that apply to the platform. The QRL on the EST is unique and specific to that service tag and will contain the Service Tag number and the iDRAC password. The label and the QRL code within it are printed on demand at the L10 factories. This QRL links to a webpage that shows the exact configuration as built for that customer, and the specific warranty purchased. It is one click away from the same content of generic information that applies to R760xs that is available in the other QRLs.

Quick Resource Locator



Dell.com/QRL/Server/PER760xs

Figure 19. Quick Resource Locator for PowerEdge R760xs system

Processor

Topics:

- [Processor features](#)
- [Chipset](#)

Processor features

The Intel 4th Generation Xeon® Scalable Processors stack is the next generation data center processor offering with significant performance increases, integrated acceleration, and next generation memory and I/O. Sapphire Rapids accelerate customer usages with unique workload optimizations.

The following lists the features and functions that are in the upcoming 4th Generation Intel® Xeon Scalable Processor offering:

- Faster UPI with up to four Intel Ultra Path Interconnect (Intel UPI) at up to 16 GT/s, increasing multisocket bandwidth
- More, faster I/O with PCI Express 5 and up to 80 lanes (per CPU)
- Enhanced Memory Performance with DDR5 support and memory speed up to 4800 MT/s in one DIMM per channel (1DPC).
- New built-in accelerators for data analytics, networking, storage, crypto, and data compression

Supported processors

The following table shows the Intel Sapphire Rapids SKUs that are supported on the R760xs.

Table 8. Supported Processors for R760xs

Processor	Clock Speed (GHz)	Cache (M)	UPI (GT/s)	Cores	Turbo	Memory Speed (MT/s)	TDP
6448Y	2.2	60	16	32	Turbo	4800	225 W
6442Y	2.6	45	16	24	Turbo	4800	225 W
6438Y+	2	60	16	32	Turbo	4800	205 W
6426Y	2.6	30	16	16	Turbo	4800	185 W
6414U	2	60	16	32	Turbo	4800	250 W
5420+	2	53	16	28	Turbo	4400	205 W
5418Y	2	45	16	24	Turbo	4400	185 W
5416S	2	30	16	16	Turbo	4400	150 W
5415+	2.9	15	16	8	Turbo	4400	150 W
5412U	2.1	45	16	24	Turbo	4400	185 W
4416+	2	38	16	20	Turbo	4000	165 W
4410Y	2	23	16	12	Turbo	4000	150 W
4410T	2.7	19	16	10	Turbo	4000	150 W
3408U	1.8	15	16	8	Turbo	4000	125 W

Chipset

The system supports Intel® C741 series chipset.

DMI - 3.0 speed (port width x8, x4)

USB ports - up to 10 superspeed (USB 3.1), 14 highspeed (USB 2.0)

SATA ports - up to 20 SATA port

PCIe Express - Up to 20 lanes, PCIe 3.0

Chipset features

- PCI-E interfaces
 - Integrated PCI Express Gen5 for improved bandwidth and connectivity
 - Up to 80 lanes per processor
 - Connect PCIe x1 to iDRAC- integrated VGA chip
- Integrated USB - maximum of 10 SuperSpeed (USB 3.1), 14 highspeed (USB 2.0)
 - One front port (USB 2.0 / Right front I/O)
 - Two rear ports (USB 2.0/3.0)

Memory subsystem

Topics:

- [Supported memory](#)
- [General memory module installation guidelines](#)

Supported memory

Table 9. Memory technology comparison

Feature	PowerEdge R760xs (DDR5)
DIMM type	RDIMM
Transfer speed	4800 MT/s (1DPC)
Voltage	1.1 V

Table 10. Supported memory matrix

DIMM type	Rank	Capacity	DIMM rated voltage and speed	Operating Speed
				1 DIMM per channel (DPC)
RDIMM	1 R	16 GB	DDR5 (1.1 V), 4800 MT/s	4800 MT/s
	2 R	32 GB, 64 GB	DDR5 (1.1 V), 4800 MT/s	4800 MT/s

 **NOTE:** The processor may reduce the performance of the rated DIMM speed.

General memory module installation guidelines

To ensure optimal performance of your system, observe the following general guidelines when configuring your system memory. If your system's memory configuration fails to observe these guidelines, your system might not boot, stop responding during memory configuration, or operate with reduced memory.

The memory bus may operate at speeds of 4800 MT/s, 4400 MT/s or 4000 MT/s depending on the following factors:

- System profile selected (for example, Performance, Performance Per Watt Optimized (OS), or Custom [can be run at high speed or lower])
- Maximum supported DIMM speed of the processors
- Maximum supported speed of the DIMMs

 **NOTE:** MT/s indicates DIMM speed in MegaTransfers per second.

The system supports Flexible Memory Configuration, enabling the system to be configured and run in any valid chipset architectural configuration. The following are the recommended guidelines for installing memory modules:

- All DIMMs must be DDR5.
- Memory mixing is not supported for different DIMM capacities.
- If memory modules with different speeds are installed, they operate at the speed of the slowest installed memory module(s).
- Populate memory module sockets only if a processor is installed.

- For single-processor systems, sockets A1 to A8 are available.
- For dual-processor systems, sockets A1 to A8 and sockets B1 to B8 are available.
- A minimum of 1 DIMM must be populated for each installed processor.
- In **Optimizer Mode**, the DRAM controllers operate independently in the 64-bit mode and provide optimized memory performance.

Table 11. Memory population rules

Processor	Configuration	Memory population	Memory population information
Single processor	Optimizer (Independent channel) population order	A{1}, A{2}, A{3}, A{4}, A{5}, A{6}, A{7}, A{8}	1, 2, 4, 6, 8 DIMMs are allowed.
Dual processor (Start with processor1. Processor 1 and processor 2 population should match)	Optimizer (Independent channel) population order	A{1}, B{1}, A{2}, B{2}, A{3}, B{3}, A{4}, B{4}, A{5}, B{5}, A{6}, B{6}, A{7}, B{7}, A{8}, B{8}	2, 4, 8, 12, 16 DIMMs are supported per system . <i>i</i> NOTE: Optimizer population order is not traditional for 8 and 16 DIMMs installations for dual processor.

- Always populate memory channels identically with equal DIMMs for best performance.
- Supported RDIMM configurations are 1, 2, 4, 6, and 8 DIMMs per processor.
- Populate eight equal memory modules per processor (one DIMM per channel) at a time to maximize performance.
- i* **NOTE:** Equal memory modules refer to DIMMs with identical electrical specification and capacity that may be from different vendors.

Storage

Topics:

- Storage controllers
- Supported Drives
- External Storage

Storage controllers

Dell RAID controller options offer performance improvements, including the fPERC solution. fPERC provides a base RAID HW controller without consuming a PCIe slot by using a small form factor and high-density connector to the base planar.

16G PERC Controller offerings are a heavy leverage of 15G PERC family. The Value and Value Performance levels carry over to 16G from 15G. New to 16G is the Avenger-based Premium Performance tier offering. This high-end offering drives IOPs performance and enhanced SSD performance.

Table 12. PERC Series controller offerings

Performance Level	Controller and Description
Entry	S160
Value	H355, HBA355e, HBA355i, (internal/external)
Value Performance	H755, H755N
Premium Performance	H965i, Avenger 1 Memory: 8GB DDR4 NV cache 72-bit memory 2133 MHz Low profile form factors Dual A15 1.2 GHz CPU X8PCIe 3.0, x8 12Gb SAS

NOTE: For more information about the features of the Dell PowerEdge RAID controllers (PERC), Software RAID controllers, or BOSS card, and on deploying the cards, see the storage controller documentation at www.dell.com/storagecontrollermanuals.

NOTE: From December 2021, H355 replaces H345 as the entry raid controller. H345 is deprecated in January 2022.

Storage controller feature matrix

Table 13. Storage controller feature matrix

Model & Form Factors	Interface Support	PCI Support	SAS Connection	Cache Memory Size	Write Back Cache	RAID Levels	Max Drive Support	RAID Support
PowerEdge Server-Storage Controllers (PERC) Series 12								

Table 13. Storage controller feature matrix (continued)

Model & Form Factors	Interface Support	PCI Support	SAS Connection	Cache Memory Size	Write Back Cache	RAID Levels	Max Drive Support	RAID Support
H965i Front	24Gb/s SAS 6Gb/s SAS/SATA Gen3 (8 GT/s) NVMe Gen4 (16 GT/s) NVMe	PCIe Gen 4	16 ports/lanes - 2x8 Internal	8GB NV	Flash Backed Cache	0,1,5,6,10,50,60	16	Hardware
H965i Adapter	24Gb/s SAS 6Gb/s SAS/SATA Gen3 (8 GT/s) NVMe Gen4 (16 GT/s) NVMe	PCIe Gen 4	16 ports/lanes - 2x8 Internal	8GB NV	Flash Backed Cache	0,1,5,6,10,50,60	16	Hardware
S160 Software RAID	Gen4 (16 GT/s) NVMe	PCIe Gen 4	N/A	No Cache	No Cache	0,1,5,10	8	Software RAID - Windows only
PowerEdge Server-Storage Controllers (PERC & SAS HBA) Series 11								
H755 Adapter	12Gb/s SAS 6Gb/s SAS/SATA 3Gb/s SAS/SATA Gen3 (8 GT/s) NVMe Gen4 (16 GT/s) NVMe	PCIe Gen 4	16 ports- 2x8 Internal	8GB NV	Flash Backed Cache	0,1,5,6,10,50,60	16/ controller 50 with SAS Expander	Hardware
H755N Front (NVMe Only)	Gen3 (8 GT/s) NVMe Gen4 (16 GT/s) NVMe	PCIe Gen 4	16 ports- 2x8 Internal	8GB NV	Flash Backed Cache	0,1,5,6,10,50,60	8/ controller	Hardware
H755 Front (SAS/SATA only)	12Gb/s SAS 6Gb/s SAS/SATA 3Gb/s SAS/SATA	PCIe Gen 4	16 ports- 2x8 Internal	8GB NV	Flash Backed Cache	0,1,5,6,10,50,60	16/ controller 50 with SAS Expander	Hardware
HBA355i Adapter	12Gb/s SAS 6Gb/s SAS/SATA 3Gb/s SAS/SATA	PCIe Gen 4	16 ports- 2x8 Internal	N/A	N/A	N/A	16/ controller 50 with SAS Expander	N/A
HBA355i Front	12Gb/s SAS 6Gb/s SAS/SATA 3Gb/s SAS/SATA	PCIe Gen 4	16 ports- 2x8 Internal	N/A	N/A	N/A	16/ controller 50 with SAS Expander	N/A

Table 13. Storage controller feature matrix (continued)

Model & Form Factors	Interface Support	PCI Support	SAS Connection	Cache Memory Size	Write Back Cache	RAID Levels	Max Drive Support	RAID Support
HBA355e Adapter	12Gb/s SAS 6Gb/s SAS/SATA 3Gb/s SAS/SATA	PCIe Gen 4	16 ports- 4x4 external	N/A	N/A	N/A	240	N/A
H355 Adapter	12Gb/s SAS 6Gb/s SAS/SATA	PCIe Gen 4	16 ports- 2x8 Internal	No Cache	No Cache	0,1, 10	Up to 32 RAID, or 32 Non- RAID	Hardware
H355 Front	12Gb/s SAS 6Gb/s SAS/SATA	PCIe Gen 4	16 ports- 2x8 Internal	No Cache	No Cache	0,1, 10	Up to 32 RAID, or 32 Non- RAID	Hardware

NOTE:

1. RAID 5/50 removed from entry RAID card
2. SWRAID support for Linux provides a pre-boot configuration utility to configure MDRAID and degraded boot capability.
3. For information, post-RTS, see the Storage controller documentation at www.dell.com/stroagecontrollermanuals.

This document is updated as changes happen, so for the latest version be sure to bookmark it rather than downloading an offline copy or refer to the [Storage Controller Matrix](#) on sales portal.

Server storage controllers User Guide

- Server-Storage Controllers User's Guides, click [here](#)

RAID - Redundant Array of Independent Disks

- Link to Help Me Choose: RAID Configuration [here](#)

Datasheets and PERC performance scaling decks

- Resource Page for Server-Storage (Sales Portal) click [here](#)
- PERC & SAS HBA Datasheets (To be updated)

Boot Optimized Storage Solution (BOSS)

BOSS is a RAID solution that is designed to boot operating systems and segregate operating system boot drives from data on server-internal storage.

BOSS feature matrix

Table 14. BOSS feature matrix

BOSS card	Drive Size	RAID levels	Stripe size	Virtual disk cache function	Maximum number of virtual disks	Maximum number of drives supported	Drive types	PCIe support	Disk cache policy	Support for Non-RAID disks	Cryptographic digital signature to verify firmware payload	Hot Plug
BOSS-N1 Monolithic	M.2 devices are read-intensive with 480 GB or 960 GB capacity	RAID1 and RAID0	Supports default 64K stripe size only	None	1	2	M.2 NVMe SSDs	Gen3	Drive default	No	Yes	Yes

BOSS-N1

BOSS-N1 is offered as a means of booting 16G servers to a full OS when the target OS is a full OS (not just a hypervisor), or the user does not wish to trade off standard hot plug drive slots for OS install

The HW RAID BOSS-N1 card is a RAID controller with a limited feature set that presents M.2 NVMe-only SSDs as either a RAID0 disk or a single RAID1 volume with 2 disks. BOSS-N1 enables support for 480/960 GB Disks from Factory Install.

Hardware: BOSS-N1 Controller and Carrier (x2)

Reliability: Enterprise-Class M.2 NVMe SSDs

Supports dual 80 mm, Read Intensive (1DWPD), M.2 devices 480 GB/960 GB Standard - 1.92 TB QNS

Accessibility: Rear Facing

Serviceability: Full Hot-Plug Support

Supports Hardware RAID1 and RAID0

Supports UEFI boot

Marvell 88NR2241 NVMe RAID Controller

Controlled Firmware Upgrade through iDRAC

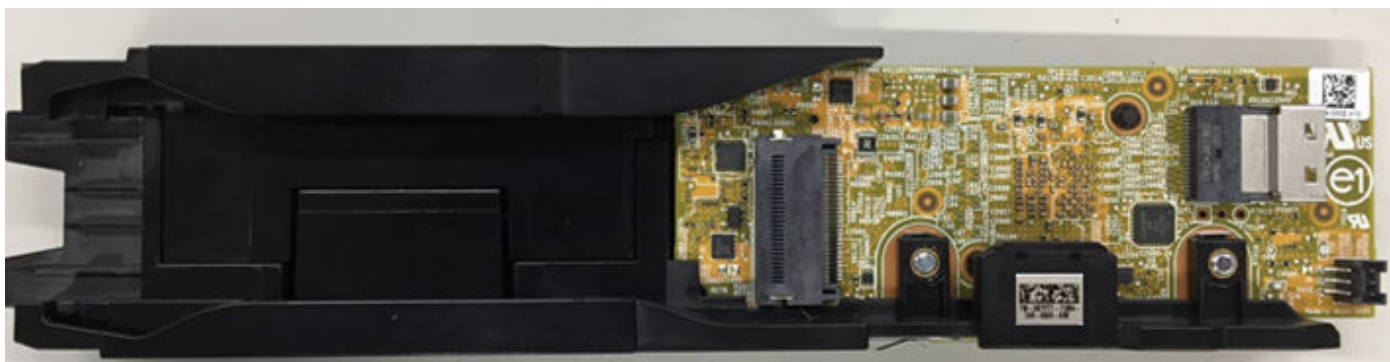

Figure 20. BOSS-N1 Controller

Datasheets

- [BOSS-N1](#) (to be updated)

BOSS User Guides

- [BOSS-N1](#)

Supported Drives

The table shown below lists the internal drives supported by the R760xs. Refer to Agile for the latest SDL

Table 15. Supported Drives

Form Factor	Type	Speed	Rotational Speed	Capacities
2.5 inches	vSAS	12 Gb	SSD	1.92 TB, 3.84 TB, 960 GB, 7.62 TB
2.5 inches	SAS	24 Gb	SSD	1.92 TB, 1.6 TB, 800 GB, 3.84 TB, 960 GB, 7.68 TB
2.5 inches	SATA	6 Gb	SSD	1.92 TB, 480 GB, 960 GB, 3.84 TB
2.5 inches	NVMe	Gen4	SSD	1.6 TB, 3.2 TB, 6.4 TB, 1.92 TB, 3.84 TB, 15.63 TB, 7.68 TB
2.5 inches	DC NVMe	Gen4	SSD	3.84 TB, 960 GB
2.5 inches	SAS	12 Gb	10 K	600 GB, 1.2 TB, 2.4 TB
3.5 inches	SATA	6 Gb	7.2 K	2 TB, 4 TB, 8 TB, 12 TB, 16 TB, 20 TB
3.5 inches	SAS	12 Gb	7.2 K	2 TB, 4 TB, 8 TB, 12 TB, 16 TB, 20 TB

External Storage

The R760xs support the external storage device types listed in the table below.

Table 16. Support External Storage Devices

Device Type	Description
External Tape	Supports connection to external USB tape products
NAS/IDM appliance software	Supports NAS software stack
JBOD	Supports connection to 12 Gb MD-series JBODs

Networking

Topics:

- [Overview](#)
- [OCP 3.0 support](#)

Overview

PowerEdge offers a wide variety of options to get information moving to and from our servers. Industry best technologies are chosen, and systems management features are added by our partners to firmware to tie in with iDRAC. These adapters are rigorously validated for worry-free, fully supported use in Dell servers.

OCP 3.0 support

Table 17. OCP 3.0 feature list

Feature	OCP 3.0
Form factor	SFF
PCIe Gen	Gen4
Max PCIe width	x8
Max no. of ports	4
Port type	BT/SFP/SFP+/SFP28
Max port speed	100 GbE
NC-SI	Yes
SNAPI	No
WoL	Yes
Power consumption	15 W–150 W

Slot priority matrix

For add-in cards that can be mapped to the R760xs and guidelines for installing expansion cards, see the R760xs slot priority matrix file on Sales Portal.

Link: <https://www.delltechnologies.com/resources/en-us/auth/products/servers/category.htm>

Topics:

- Expansion card installation guidelines

Expansion card installation guidelines

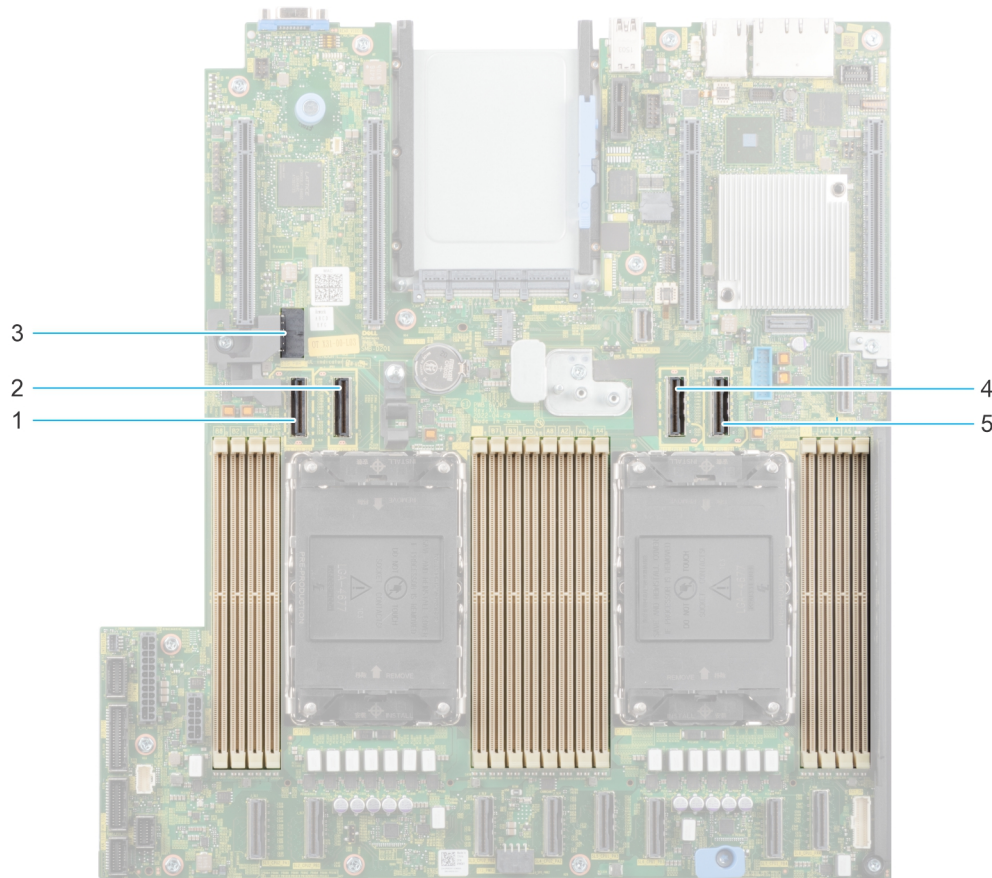

Figure 21. Expansion card slot connectors

1. SL9_CPU2_PB5 (PCIe cable connector for Riser 1C and Riser 1D)
2. SL10_CPU2_PA5 (PCIe cable connector for Riser 1C and Riser 1D)
3. SIG_PWR_0 (Power connector for Riser 1C and Riser 1D)
4. SL11_CPU1_PA6 (PCIe cable connector for Riser 1D)
5. SL12_CPU1_PB6 (PCIe cable connector for Riser 1D)

The following table describes the expansion card riser configurations:

Table 18. Expansion card riser configurations

Configurations	Expansion card risers	PCIe Slots	Controlling processor	Height	Length	Slot width	Power
Config 0-1.	No riser	1, 2	Processor 1	Low profile	Half length	x16, x8	75 W
Config 0-2.	No riser	1, 2	Processor 1	Low profile	Half length	x16, x8	75 W
		5, 6	Processor 2	Low profile	Half length	x16, x16	75 W
Config 1.	R1C	1, 2, 3	Processor 1	Low profile	Half length	x16, x8, x16	75 W
		4, 5, 6	Processor 2	Low profile	Half length	x16, x16, x16	75 W
Config 2.	R1D	1, 2, 3, 4	Processor 1	Low profile	Half length	x16, x8, x8, x8	75 W

NOTE: Only one cable riser can be installed at a time in any given configuration.

NOTE: The slots 1, 2, 5 and 6 are Gen4 slots, slot 3 and 4 located on risers are Gen5 slots.

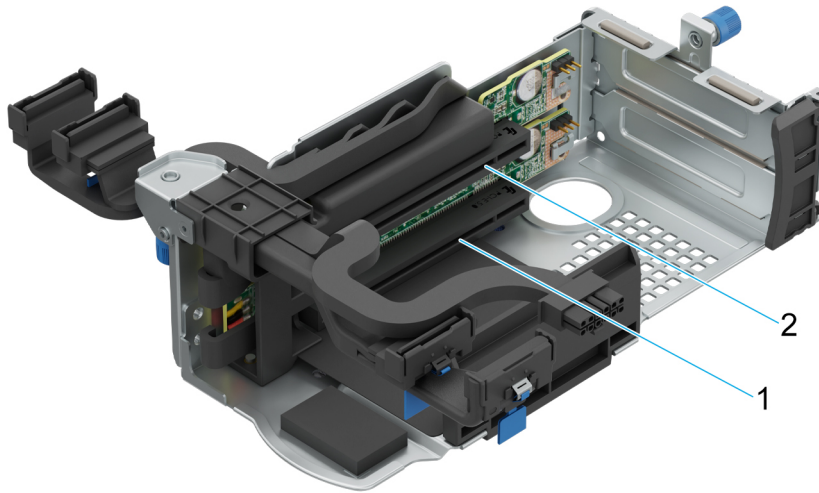

Figure 22. Riser 1C

- 1. Slot 3
- 2. Slot 4

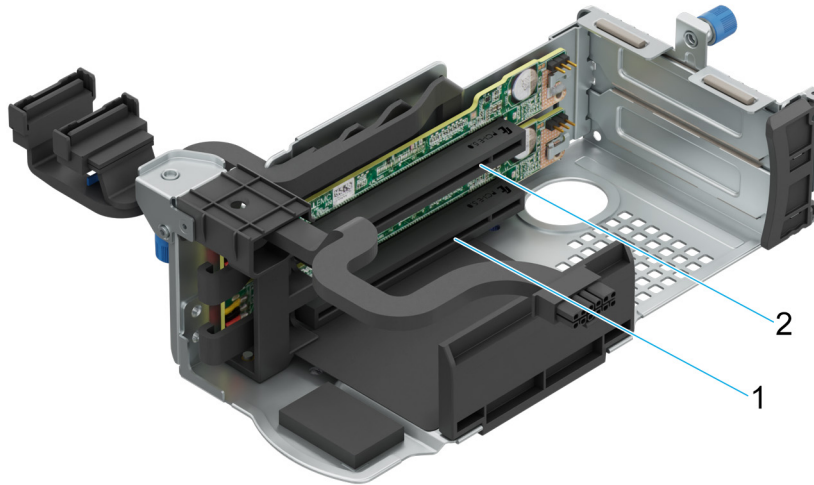

Figure 23. Riser 1D

1. Slot 3
2. Slot 4

NOTE: The expansion-card slots are not hot-swappable.

The following table provides guidelines for installing expansion cards to ensure proper cooling and mechanical fit. The expansion cards with the highest priority should be installed first using the slot priority indicated. All the other expansion cards should be installed in the card priority and slot priority order.

Table 19. Configuration 0-1: No riser configuration

Card type	Slot priority	Maximum number of cards
Dell Serial port module (LP)	2	1
fPERC	Integrated slot	1
Internal PERC adapter	1	1
Dell External Adapter	2, 1	2
Mellanox (NIC: 400Gb)	Not supported	NA
Mellanox (NIC: 200Gb)	Not supported	NA
Mellanox (NIC: 100Gb)	1	1
Mellanox HDR100 VPI	1	1
Mellanox HDR VPI	1	1
Broadcom (NIC: 100Gb)	1	1
Intel (NIC: 100Gb)	1	1
Broadcom (SFP: 25Gb)	2, 1	2
Intel (NIC: 25Gb)	2, 1	2
Qlogic (NIC: 25Gb)	Not supported	NA
Qlogic (NIC: 10Gb)	Not supported	NA
SolarFlare (NIC: 25Gb)	Not supported	NA
Broadcom (HBA: FC64)	2,1	2
Broadcom (HBA: FC32)	2, 1	2
Marvell (HBA: FC32)	2, 1	2

Table 19. Configuration 0-1: No riser configuration (continued)

Card type	Slot priority	Maximum number of cards
Emulex (HBA: FC32)	Not supported	NA
Avago (HBA: FC16)	Not supported	NA
Qlogic (HBA: FC16)	Not supported	NA
Broadcom (NIC: 10Gb)	2, 1	2
Intel (NIC: 10Gb)	2, 1	2
Qlogic (NIC: 10Gb)	Not supported	NA
Broadcom (NIC: 1Gb)	2, 1	NA
Intel (NIC: 1Gb)	2, 1	2
Intel (OCP: 100Gb)	Integrated slot	1
Mellanox (OCP: 100Gb)	Integrated slot	1
Broadcom (OCP: 25Gb)	Integrated slot	1
Intel (OCP: 25Gb)	Integrated slot	1
Marvell (OCP: 25Gb)	Not supported	NA
Mellanox (OCP: 25Gb)	Integrated slot	1
SolarFlare (OCP: 25Gb)	Not supported	NA
Broadcom (OCP: 10Gb)	Integrated slot	1
Marvell (OCP: 10Gb)	Not supported	NA
Intel (OCP: 10Gb)	Not supported	NA
Broadcom (OCP: 1Gb)	Integrated slot	1
Intel (OCP: 1Gb)	Not supported	NA
Dell BOSS N1 Module	Integrated slot	1

Table 20. Configuration 0-2: No riser configuration

Card type	Slot priority	Maximum number of cards
Dell Serial port module (LP)	2	1
fPERC	Integrated slot	1
Internal PERC adapter	1	1
Dell External Adapter	6, 2, 1, 5	4
Mellanox (NIC: 400Gb)	Not supported	NA
Mellanox (NIC: 200Gb)	Not supported	NA
Mellanox (NIC: 100Gb)	6, 1, 5	3
Mellanox HDR100 VPI	6, 1, 5	3
Mellanox HDR VPI	6, 1, 5	3
Broadcom (NIC: 100Gb)	6, 1, 5	3
Intel (NIC: 100Gb)	6, 1, 5	3
Broadcom (SFP: 25Gb)	6, 2, 1, 5	4
Intel (NIC: 25Gb)	2, 1	2
Qlogic (NIC: 25Gb)	Not supported	NA

Table 20. Configuration 0-2: No riser configuration (continued)

Card type	Slot priority	Maximum number of cards
Qlogic (NIC: 10Gb)	Not supported	NA
SolarFlare (NIC: 25Gb)	Not supported	NA
Broadcom (HBA: FC64)	6, 2, 1, 5	4
Broadcom (HBA: FC32)	6, 2, 1, 5	4
Marvell (HBA: FC32)	6, 2, 1, 5	4
Emulex (HBA: FC32)	Not supported	NA
Avago (HBA: FC16)	Not supported	NA
Qlogic (HBA: FC16)	Not supported	NA
Broadcom (NIC: 10Gb)	6, 2, 1, 5	4
Intel (NIC: 10Gb)	6, 2, 1, 5	4
Qlogic (NIC: 10Gb)	Not supported	NA
Broadcom (NIC: 1Gb)	6, 2, 1, 5	4
Intel (NIC: 1Gb)	6, 2, 1, 5	4
Intel (OCP: 100Gb)	Integrated slot	1
Mellanox (OCP: 100Gb)	Integrated slot	1
Broadcom (OCP: 25Gb)	Integrated slot	1
Intel (OCP: 25Gb)	Integrated slot	1
Marvell (OCP: 25Gb)	Not supported	NA
Mellanox (OCP: 25Gb)	Integrated slot	1
SolarFlare (OCP: 25Gb)	Not supported	NA
Broadcom (OCP: 10Gb)	Integrated slot	1
Marvell (OCP: 10Gb)	Not supported	NA
Intel (OCP: 10Gb)	Not supported	NA
Broadcom (OCP: 1Gb)	Integrated slot	1
Intel (OCP: 1Gb)	Not supported	NA
Dell BOSS N1 Module	Integrated slot	1

Table 21. Configuration 1: R1C

Card type	Slot priority	Maximum number of cards
Dell Serial port module (LP)	2	1
Internal PERC adapter	1	1
Dell external PERC adapter	6, 2, 1, 3, 5, 4	6
12Gbps SAS HBA	1	1
Mellanox (NIC: 400Gb)	4, 3	2
Mellanox (NIC: 200Gb)	4, 3	2
Broadcom (NIC: 100Gb)	6, 1, 3, 5, 4	5
Intel (NIC: 100Gb)	6, 1, 3, 5, 4	5
Mellanox (NIC: 100Gb)	6, 1, 3, 5, 4	5

Table 21. Configuration 1: R1C (continued)

Card type	Slot priority	Maximum number of cards
Mellanox HDR100 VPI	6, 1, 3, 5, 4	5
Mellanox HDR VPI	6, 1, 3, 5, 4	5
Intel (NIC: 25Gb)	6, 2, 1, 3, 5, 4	6
Mellanox (NIC: 25Gb)	6, 1, 3, 5, 4	5
Qlogic (NIC: 25Gb)	Not Supported	NA
Broadcom (NIC: 10Gb)	6, 2, 1, 3, 5, 4	6
Broadcom (NIC: 25Gb)	6, 2, 1, 3, 5, 4	6
SolarFlare (NIC: 25Gb)	Not Supported	NA
Broadcom (HBA: FC64)	6, 2, 1, 3, 5, 4	6
Broadcom (HBA: FC32)	6, 2, 1, 3, 5, 4	6
QLogic (HBA: FC32)	6, 2, 1, 3, 5, 4	6
Marvell (HBA: FC32)	6, 2, 1, 3, 5, 4	6
Emulex (HBA: FC32)	Not Supported	NA
Avago (HBA: FC16)	Not Supported	NA
QLogic (HBA: FC16)	Not Supported	NA
Intel (NIC: 10Gb)	6, 2, 1, 3, 5, 4	6
Qlogic (NIC: 10Gb)	Not Supported	NA
Intel (NIC: 1Gb)	6, 2, 1, 3, 5, 4	6
Intel (OCP: 100Gb)	Integrated slot	1
Mellanox (OCP: 100Gb)	Integrated slot	1
Broadcom (OCP: 25Gb)	Integrated slot	1
Intel (OCP: 25Gb)	Integrated slot	1
Marvell (OCP: 25Gb)	Not supported	NA
Mellanox (OCP: 25Gb)	Integrated slot	1
SolarFlare (OCP: 25Gb)	Not supported	NA
Broadcom (OCP: 10Gb)	Integrated slot	1
Marvell (OCP: 10Gb)	Not supported	NA
Intel (OCP: 10Gb)	Not supported	NA
Broadcom (OCP: 1Gb)	Integrated slot	1
Intel (OCP: 1Gb)	Not supported	NA
Dell BOSS N1 Module	Integrated slot	1

Table 22. Configuration 2: R1D

Card type	Slot priority	Maximum number of cards
Dell Serial port module (LP)	2	1
Internal PERC adapter	1	1
Dell external PERC adapter	4, 3, 2, 1	4
12Gbps SAS HBA	1	1

Table 22. Configuration 2: R1D (continued)

Card type	Slot priority	Maximum number of cards
Mellanox (NIC: 400Gb)	Not supported	NA
Mellanox (NIC: 200Gb)	Not supported	NA
Broadcom (NIC: 100Gb)	1	1
Intel (NIC: 100Gb)	1	1
Mellanox (NIC: 100Gb)	1	1
Mellanox HDR100 VPI	1	1
Mellanox HDR VPI	1	1
Intel (NIC: 25Gb)	4, 3, 2, 1	4
Mellanox (NIC: 25Gb)	4, 3, 2, 1	4
Qlogic (NIC: 25Gb)	Not Supported	NA
Broadcom (NIC: 10Gb)	4, 3, 2, 1	4
Broadcom (NIC: 25Gb)	4, 3, 2, 1	4
SolarFlare (NIC: 25Gb)	Not Supported	NA
Broadcom (HBA: FC64)	4, 3, 2, 1	4
Broadcom (HBA: FC32)	4, 3, 2, 1	4
QLogic (HBA: FC32)	4, 3, 2, 1	4
Marvell (HBA: FC32)	4, 3, 2, 1	4
Emulex (HBA: FC32)	Not Supported	NA
Avago (HBA: FC16)	Not Supported	NA
QLogic (HBA: FC16)	Not Supported	NA
Intel (NIC: 10Gb)	4, 3, 2, 1	4
Qlogic (NIC: 10Gb)	Not Supported	NA
Intel (NIC: 1Gb)	4, 3, 2, 1	4
Intel (OCP: 100Gb)	Integrated slot	1
Mellanox (OCP: 100Gb)	Integrated slot	1
Broadcom (OCP: 25Gb)	Integrated slot	1
Intel (OCP: 25Gb)	Integrated slot	1
Marvell (OCP: 25Gb)	Not supported	NA
Mellanox (OCP: 25Gb)	Integrated slot	1
SolarFlare (OCP: 25Gb)	Not supported	NA
Broadcom (OCP: 10Gb)	Integrated slot	1
Marvell (OCP: 10Gb)	Not supported	NA
Intel (OCP: 10Gb)	Not supported	NA
Broadcom (OCP: 1Gb)	Integrated slot	1
Intel (OCP: 1Gb)	Not supported	NA
Dell BOSS N1 Module	Integrated slot	1

 **NOTE:** The serial COM card is not a real PCIe add-in card and has a dedicated slot on the system board.

Power, thermal, and acoustics

PowerEdge servers have an extensive collection of sensors that automatically track thermal activity, which helps to regulate temperature by reducing server noise and power consumption. The table below lists the tools and technologies Dell offers to lower power consumption and increase energy efficiency.

Topics:

- [Power](#)
- [Thermal](#)
- [Acoustics](#)

Power

Table 23. Power tools and technologies

Feature	Description
Power Supply Units(PSU) portfolio	Dell's PSU portfolio includes intelligent features such as dynamically optimizing efficiency while maintaining availability and redundancy. Find additional information in the Power supply units section.
Tools for right sizing	Enterprise Infrastructure Planning Tool (EIPT) is a tool that can help you determine the most efficient configuration possible. With Dell's EIPT, you can calculate the power consumption of your hardware, power infrastructure, and storage at a given workload. Learn more at www.dell.com/calc .
Industry Compliance	Dell's servers are compliant with all relevant industry certifications and guide lines, including 80 PLUS, Climate Savers and ENERGY STAR.
Power monitoring accuracy	PSU power monitoring improvements include: <ul style="list-style-type: none"> • Dell's power monitoring accuracy is currently 1%, whereas the industry standard is 5% • More accurate reporting of power • Better performance under a power cap
Power capping	Use Dell's systems management to set the power cap limit for your systems to limit the output of a PSU and reduce system power consumption. Dell is the first hardware vendor to leverage Intel Node Manager for circuit-breaker fast capping.
Systems Management	iDRAC Enterprise and Datacenter provides server-level management that monitors, reports and controls power consumption at the processor, memory and system level. Dell OpenManage Power Center delivers group power management at the rack, row, and data center level for servers, power distribution units, and uninterruptible power supplies.
Active power management	Intel Node Manager is an embedded technology that provides individual server-level power reporting and power limiting functionality. Dell offers a complete power management solution comprised of Intel Node Manager accessed through Dell iDRAC9 Datacenter and OpenManage Power Center that allows policy-based management of power and thermal at the individual server, rack, and data center level. Hot spare reduces power consumption of redundant power supplies. Thermal control off a speed optimizes the thermal settings for your environment to reduce fan consumption and lower system power consumption. Idle power enables Dell servers to run as efficiently when idle as when at full workload.
Rack infrastructure	Dell offers some of the industry's highest-efficiency power infrastructure solutions, including:

Table 23. Power tools and technologies (continued)

Feature	Description
	<ul style="list-style-type: none"> Power distribution units (PDUs) Uninterruptible power supplies (UPSs) Energy Smart containment rack enclosures Find additional information at: https://www.delltechnologies.com/en-us/servers/power-and-cooling.htm .

PSU specifications

The PowerEdge R760xs system supports up to two AC or DC power supply units (PSUs).

Table 24. R760xs PSU specifications

PSU	Class	Heat dissipation (maximum)	Frequency	Voltage	AC		DC	Current
					High line 200–240 V	Low line 100–120 V		
1800 W Mixed Mode	Titanium	6610 BTU/hr	50/60 Hz	200–240 V AC	1800 W	NA	NA	10 A
	NA	6610 BTU/hr	NA	240 V DC	NA	NA	1800 W	8.2 A
1400 W Mixed Mode	Platinum	5250 BTU/hr	50/60 Hz	100–240 V AC, autoranging	1400 W	1050 W	NA	12 A–8 A
	NA	5250 BTU/hr	NA	240 V DC	NA	NA	1400 W	6.6 A
1100 W Mixed Mode	Titanium	4125 BTU/hr	50/60 Hz	100–240 V AC, autoranging	1100 W	1050 W	NA	12 A–6.3 A
	NA	4125 BTU/hr	NA	240 V DC	NA	NA	1100 W	5.2 A
1100 W DC	NA	4265 BTU/hr	NA	-48 – (-60) V DC	NA	NA	1100 W	27 A
800 W Mixed Mode	Platinum	3000 BTU/hr	50/60 Hz	100–240 V AC, autoranging	800 W	800 W	NA	9.2 A–4.7 A
	NA	3000 BTU/hr	NA	240 V DC	NA	NA	800 W	3.8 A
700 W Mixed Mode	Titanium	2625 BTU/hr	50/60 Hz	200–240 V AC	700 W	NA	NA	4.1 A
	NA	2625 BTU/hr	NA	240 V DC	NA	NA	700 W	3.4 A
600 W Mixed Mode	Platinum	2250 BTU/hr	50/60 Hz	100–240 V AC, autoranging	600 W	600 W	NA	7.1 A–3.6 A
	NA	2250 BTU/hr	NA	240 V DC	NA	NA	600 W	2.9 A

NOTE: This system is also designed to connect to the IT power systems with a phase-to-phase voltage not exceeding 240 V.

NOTE: Heat dissipation is calculated using the PSU wattage rating.

NOTE: When selecting or upgrading the system configuration, to ensure optimum power utilization, verify the system power consumption with the Enterprise Infrastructure Planning Tool available at Dell.com/calc.

Thermal

PowerEdge servers have an extensive collection of sensors that automatically track thermal activity, which helps regulate temperature thereby reducing server noise and power consumption.

Acoustics

Acoustical configurations of R760xs

Dell PowerEdge R760xs is a rack server appropriate for attended data center environment. However, lower acoustical output is attainable with proper hardware or software configurations.

Table 25. Configurations tested for acoustical experience

Configuration	Quietest	12 x 3.5-inch configuration	Quietest - GPU	Volume 1 - 2.5-inch	Volume 2 - 3.5-inch with Rear Storage
CPU TDP	125 W	185 W	150 W	185 W	185 W
CPU Quantity	1	2	2	2	2
RDIMM Memory	16 GB DDR5	32 GB DDR5	16 GB DDR5	16 GB DDR5	32 GB DDR5
Memory Quantity	2	16	4	16	16
Backplane Type	8 x 2.5-inch BP	12 x 3.5-inch BP	8 x 2.5-inch BP	8 x 2.5-inch + 8 x 2.5-inch NVMe BP	12 x 3.5-inch + rear 2 x 2.5-inch BP
HDD Type	SATA 2.5-inch 480 GB	SATA 3.5-inch 12 TB	SATA 2.5-inch 480 GB	SAS 2.5-inch + NVMe 2.5-inch	SATA 3.5-inch 12 TB + rear 2.5-inch U.2 NVMe
HDD Quantity	1	12	4	8+8	12+2
Flash Drives	X	X	X	X	X
Flash Quantity	X	X	X	X	X
PSU Type	600 W	1400 W	800 W	800 W	1400 W
PSU Quantity	1	2	2	2	2
OCP	1G	10/25 2-port	1G	10/25 2-port	10/25 2-port
PCI 1	X	X	X	X	X
PCI 2	X	2-port 25Gb	X	2-port 25Gb	2-port 25Gb
PCI 3	X	X	X	X	X
PCI 4	X	X	A2	X	X
PCI 5	X	2-port 25 Gb	X	2-port 25 Gb	2-port 25 Gb
PCI 6	X	X	X	X	X
PERC	Front H355i	Front H755	Front H355i	Front H755	Rear H755

Table 26. Acoustical experience of R760 configurations

Configuration		Quietest	12 x 3.5-inch configuration	Quietest - GPU	Volume 1 - 2.5-inch	Volume 2 - 3.5-inch with Rear Storage
Acoustical Performance: Idle/ Operating @ 25°C Ambient						
L _{wA,m} (B)	Idle ⁽⁴⁾	4.6	7.0	6.4	6.4	7.2
	Operating/Customer usage operating ⁽⁵⁾⁽⁶⁾	4.6	7.0	8.0	6.4	7.2
K _v (B)	Idle ⁽⁴⁾	0.4	0.4	0.4	0.4	0.4
	Operating/Customer usage operating ⁽⁵⁾⁽⁶⁾	0.4	0.4	0.4	0.4	0.4
L _{pA,m} (dB)	Idle ⁽⁴⁾	32	56	50	49	57
	Operating/Customer usage operating ⁽⁵⁾⁽⁶⁾	32	56	64	50	58
Prominent discrete tones ⁽³⁾		Prominence ratio < ECMA-74	Prominence ratio < 15 dB			
Acoustical Performance: Idle @ 28°C Ambient						
L _{wA,m} ⁽¹⁾ (B)		4.8	7.2	6.6	6.6	7.4
K _v (B)		0.4	0.4	0.4	0.4	0.4
L _{pA,m} ⁽²⁾ (dB)		33	56	52	52	58
Acoustical Performance: Max. loading @ 35°C Ambient						
L _{wA,m} ⁽¹⁾ (B)		5.4	8.0	8.6	8.1	8.1
K _v (B)		0.4	0.4	0.4	0.4	0.4
L _{pA,m} ⁽²⁾ (dB)		38	66	70	65	65

⁽¹⁾L_{wA,m}: The declared mean A-weighted sound power level (L_{wA}) is calculated per section 5.2 of ISO 9296 with data collected using the methods described in ISO 7779 (2010). Engineering data presented here may not be fully compliant with ISO 7779 declaration requirements.

⁽²⁾L_{pA,m}: The declared mean A-weighted emission sound pressure level is at the bystander position per section 5.3 of ISO 9296 and measured using methods described in ISO 7779. The system is placed in a 24U rack enclosure, 25cm above a reflective floor. Engineering data presented here may not be fully compliant with ISO 7779 declaration requirements.

⁽³⁾Prominent tones: Criteria of Annex D of ECMA-74 & Prominence Ratio method of ECMA-418 are followed to determine if discrete tones are prominent and to report them, if so.

⁽⁴⁾Idle mode: Idle mode is the steady-state condition in which the server is energized but not operating any intended function.

⁽⁵⁾Operating mode: Operating mode is represented by the maximum of the steady state acoustical output at 50% of CPU TDP or active storage drives for the respective sections of Annex C of ECMA-74.

⁽⁶⁾ Customer Usage Operating mode: The operating mode is represented by the maximum of the steady state acoustical output at 10%~25% of CPU TDP, 0%~10% IOPs load, and >80% GPU load as the components showed in the above configurations.

Rack, rails, and cable management

Topics:

- [Rails information](#)
- [Cable Management Arm](#)
- [Strain Relief Bar](#)
- [Rack Installation](#)

Rails information

The rail offerings for the R760xs consist of two general types: sliding and static. The cable management offerings consist of an optional cable management arm (CMA) and an strain relief bar (SRB).

See the *Dell Enterprise Systems Rail Sizing and Rack Compatibility Matrix* available at [rail-rack-matrix](#) for information regarding:

- Specific details about rail types.
- Rail adjustability ranges for various rack mounting flange types
- Rail depth with and without cable management accessories
- Rack types that are supported for various rack mounting flange types

Key factors governing proper rail selection include the following:

- Identifying the type of rack in which they will be installed.
- The spacing between the front and rear mounting flanges of the rack.
- The type and location of any equipment mounted in the back of the rack such as power distribution units (PDUs), and the overall depth of the rack
- Overall depth of the rack

A11 Sliding Rails features summary

The sliding rails allow the system to be fully extended out of the rack for service. The sliding rails have a Cable Management Arm (CMA) and a Strain Relief Bar (SRB) option.

There are one types of sliding rails available:

- Stab-in/Drop-in sliding rails

A11 Stab-in/Drop-in sliding rails for 4-post racks

- Supports Drop-in or Stab-in installation of the chassis to the rails
- Supports tool-less installation in 19-inch EIA-310-E compliant square, unthreaded round hole racks including all generations of Dell racks.

Also supports tool-less installation in threaded round hole 4-post racks

- Support for tool-less installation in Dell Titan or Titan-D racks
- Supports full extension of the system out of the rack to allow serviceability of key internal components
- Supports optional Cable Management Arm (CMA)

i **NOTE:** For situations where CMA support is not required, the outer CMA mounting brackets can be uninstalled from the sliding rails. This reduces the overall length of the rails and eliminates the potential interferences with rear mounted PDUs or the rear rack door.

- Supports optional Strain Relief Bar (SRB)

NOTE: Scan the QRL code for the documentation and troubleshooting information regarding the installation procedures for Drop-in/Stab-in rail types.



Figure 24. Quick resource locator for combo rails

A8 Static Rails features summary

The static rails, shown in the figure below, support a wider variety of racks than the sliding rails, but do not support serviceability in the rack. The static rails are not compatible with the CMA and SRB.

- Supports Stab-in installation of the chassis to the rails
- Supports tool-less installation in 19-inch EIA-310-E compliant square or unthreaded round hole 4-post racks including all generations of Dell racks
- Supports tooled installation in 19-inch EIA-310-E compliant threaded hole 4-post and 2-post racks
- Supports tooled installation in Dell Titan or Titan-D rack

NOTE:

- Screws are not included with the static rail kit since racks are offered with various thread types.
- Screw head diameter should be 10mm or less.

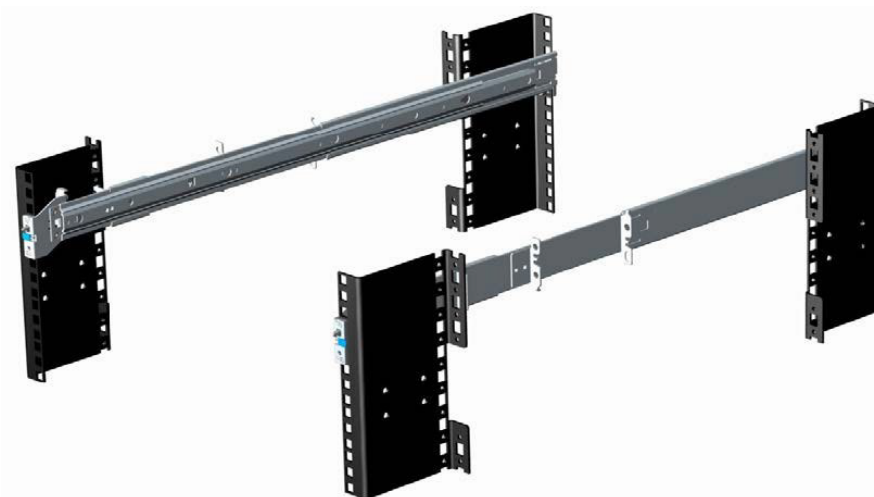

Figure 25. Static rails

2-Post racks installation

If installing to 2-Post (Telco) racks, the ReadyRails II static rails (A8) must be used. Sliding rails support mounting in 4-post racks only.



Figure 26. Static rails in 2-post center mount configuration

Installation in the Dell Titan or Titan-D racks

For tool-less installation in Titan or Titan-D racks, the Stab-in/Drop-in sliding rails (A11) must be used. This rail collapses down sufficiently to fit in the rack with mounting flanges that are spaced about 24 inches apart from front to back. The Stab-in/Drop-in sliding rail allows bezels of the servers and storage systems to be aligned when installed in these racks. For tooled installation, Stab-in Static rails (A8) must be used for bezel alignment with storage systems.

Cable Management Arm

The optional Cable Management Arm (CMA) for the system organizes and secures the cords and cables exiting the back of the server and unfolds to allow the server to extend out of the rack without having to detach the cables.

Some key features of the CMA include:

- Large U-shaped baskets to support dense cable loads
- Open vent pattern for optimal airflow
- Support for mounting on either side by swinging the spring-loaded brackets from one side to the other
- Utilizes hook-and-loop straps rather than plastic tie wraps to eliminate the risk of cable damage during cycling
- Includes a low-profile fixed tray to both support and retain the CMA in its fully closed position
- Both the CMA and the tray mount without the use of tools through simple and intuitive snap-in designs

The CMA can be mounted to either side of the sliding rails without the use of tools or the need for conversion. For systems with one power supply unit (PSU), it is recommended to mount on the side opposite to that of the power supply to allow easier access to it and the rear drives (if applicable) for service or replacement.



Strain Relief Bar

The optional strain relief bar (SRB) for the R760xs organizes and supports cable connections at the rear end of the server to avoid damage from bending.

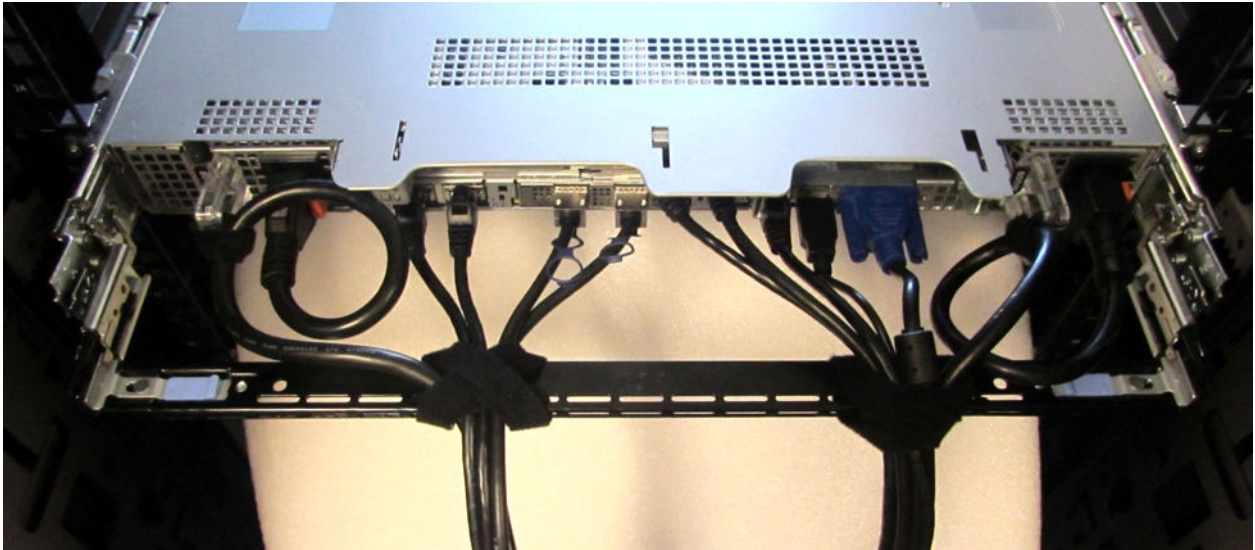

Figure 27. Cabled strain relief bar

Sliding rails with optional SRB:

- Support tool-less attachment to rails
- Support two depth positions to accommodate various cable loads and rack depths
- Support cable loads and controls stress on server connectors
- Support cables can be segregated into discrete, purpose-specific bundles

Rack Installation

Drop-in design means that the system is installed vertically into the rails by inserting the standoffs on the sides of the system into the J-slots in the inner rail members with the rails in the fully extended position. The recommended method of installation is to first insert the rear standoffs on the system into the rear J-slots on the rails to free up a hand and then rotate the system down into the remaining J-slots while using the free hand to hold the rail against the side of the system.

Stab-in design means that the inner (chassis) rail members must first be attached to the sides of the system and then inserted into the outer (cabinet) members installed in the rack.

Installing system into the rack (option A: Drop-In)

1. Pull the inner rails out of the rack until they lock into place.



Figure 28. Pull out inner rail

2. Locate the rear rail standoff on each side of the system and lower them into the rear J-slots on the slide assemblies.
3. Rotate the system downward until all the rail standoffs are seated in the J-slots.

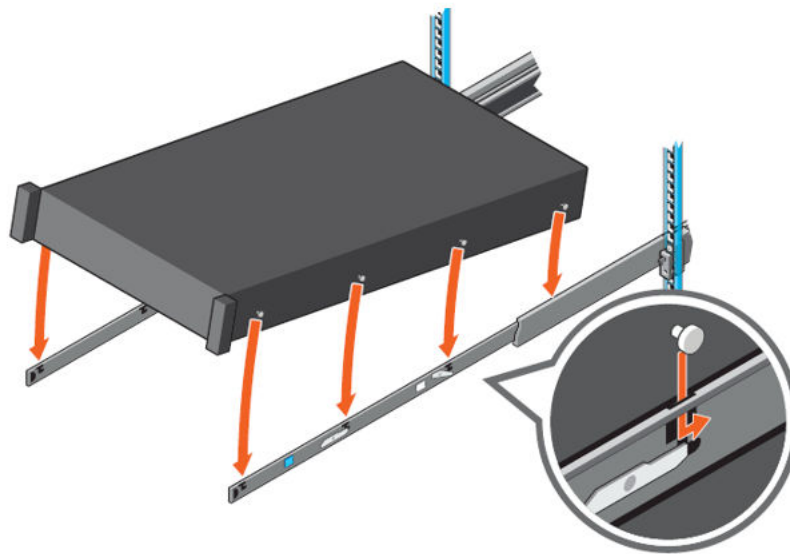

Figure 29. Rail standoffs seated in J-slots

4. Push the system inward until the lock levers click into place.
5. Pull the blue side release lock tabs forward or backward on both rails and slide the system into the rack until the system is in the rack.

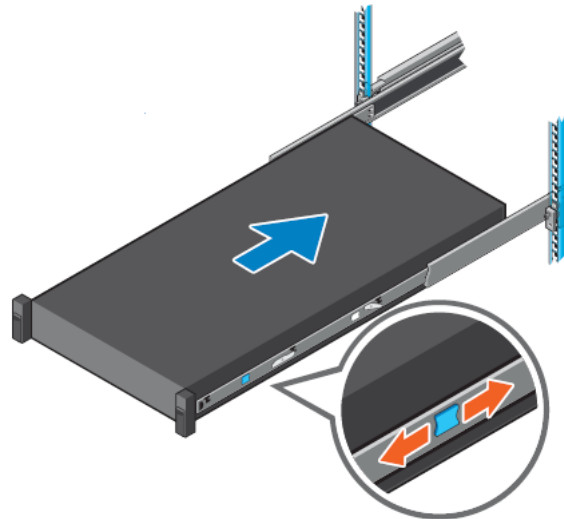

Figure 30. Slide system into the rack

Installing the system into the rack (option B: Stab-In)

1. Pull the intermediate rails out of the rack until they lock into place.
2. Release the inner rail lock by pulling forward on the white tabs and sliding the inner rail out of the intermediate rails.

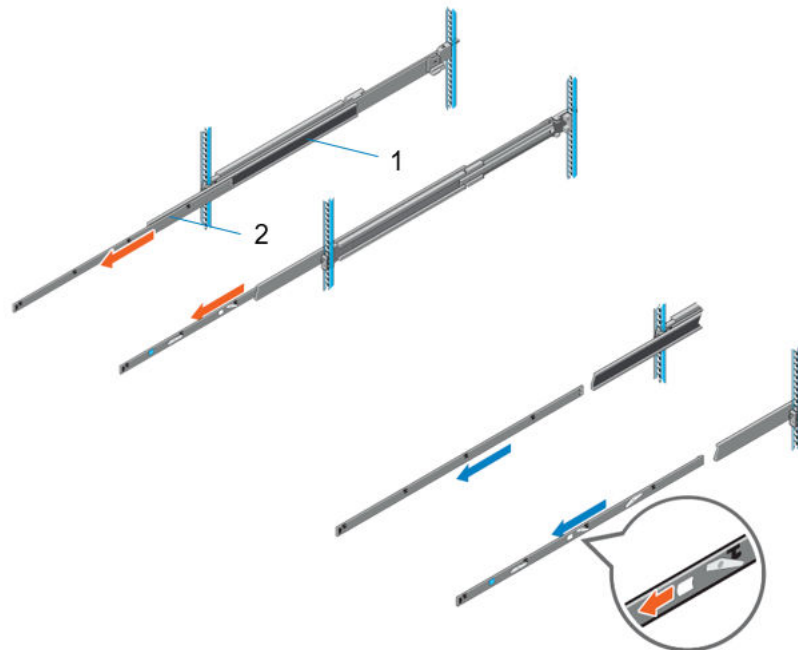

Figure 31. Pull out the intermediate rail

Table 27. Rail component label

Number	Component
1	Intermediate rail
2	Inner rail

3. Attach the inner rails to the sides of the system by aligning the J-slots on the rail with the standoffs on the system and sliding forward on the system until they lock into place.

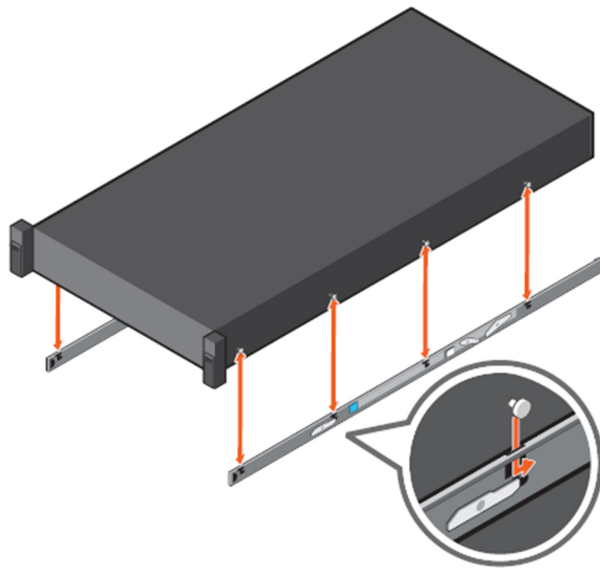

Figure 32. Attach the inner rails to the system

4. With the intermediate rails extended, install the system into the extended rails.

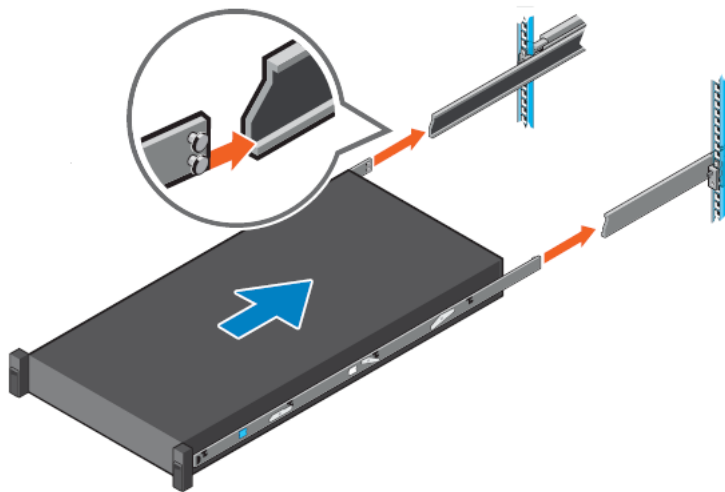

Figure 33. Install system into the extended rails

5. Pull blue slide release lock tabs forward or backward on both rails, and slide the system into the rack.

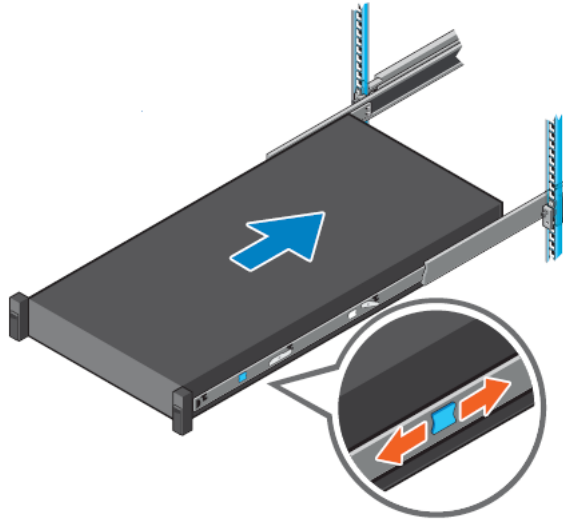

Figure 34. Slide system into the rack

Supported operating systems

The PowerEdge R760xs system supports the following operating systems:

- Canonical Ubuntu Server LTS
- Microsoft Windows Server with Hyper-V
- Red Hat Enterprise Linux
- SUSE Linux Enterprise Server
- VMware vSAN/ESXi

For more information, go to www.dell.com/ossupport.

Dell OpenManage Systems Management

Dell delivers management solutions that help IT administrators effectively deploy, update, monitor, and manage IT assets. OpenManage solutions and tools enable you to quickly respond to problems by helping them to manage Dell servers efficiently; in physical, virtual, local, and remote environments; all without the need to install an agent in the operating system.

The OpenManage portfolio includes:

- Innovative embedded management tools - integrated Dell Remote Access Controller (iDRAC)
- Consoles - OpenManage Enterprise
- Extensible with plug-ins - OpenManage Power Manager
- Update tools - Repository Manager

Dell has developed comprehensive systems management solutions that are based on open standards and has integrated with management consoles from partners such as Microsoft and VMware, allowing advanced management of Dell servers. Dell management capabilities extend to offerings from the industry's top systems management vendors and frameworks such as Ansible, Splunk, and ServiceNow. OpenManage tools automate the full span of server life cycle management activities along with powerful RESTful APIs to script or integrate with your choice of frameworks.

For more information about the entire OpenManage portfolio, see:

- The latest [Dell Systems Management Overview Guide](#).

Topics:

- [Integrated Dell Remote Access Controller \(iDRAC\)](#)
- [Systems Management software support matrix](#)

Integrated Dell Remote Access Controller (iDRAC)

iDRAC9 delivers advanced, agent-free, local and remote server administration. Embedded in every PowerEdge server, iDRAC9 provides a secure means to automate a multitude of common management tasks. Because iDRAC is embedded within every PowerEdge server, there is no additional software to install; just plug in power and network cables, and iDRAC is ready to go. Even before installing an operating system (operating system) or hypervisor, IT administrators have a complete set of server management features at their fingertips.

With iDRAC9 in-place across the Dell PowerEdge portfolio, the same IT administration techniques and tools can be applied throughout. This consistent management platform allows easy scaling of PowerEdge servers as an organization's infrastructure grows. Customers can use the iDRAC RESTful API for the latest in scalable administration methods of PowerEdge servers. With this API, iDRAC enables support for the Redfish standard and enhances it with Dell extensions to optimize at-scale management of PowerEdge servers. By having iDRAC at the core, the entire OpenManage portfolio of Systems Management tools allows every customer to tailor an effective, affordable solution for any size environment.

Zero Touch Provisioning (ZTP) is embedded in iDRAC. ZTP - Zero Touch Provisioning is Intelligent Automation Dell's agent-free management puts IT administrators in control. Once a PowerEdge server is connected to power and networking, that system can be monitored and fully managed, whether you're standing in front of the server or remotely over a network. In fact, with no need for software agents, an IT administrator can: · Monitor · Manage · Update · Troubleshoot and remediate Dell servers With features like zero-touch deployment and provisioning, iDRAC Group Manager, and System Lockdown, iDRAC9 is purpose-built to make server administration quick and easy. For those customers whose existing management platform utilizes in-band management, Dell does provide iDRAC Service Module, a lightweight service that can interact with both iDRAC9 and the host operating system to support legacy management platforms.

When ordered with DHCP enabled from the factory, PowerEdge servers can be automatically configured when they are initially powered up and connected to your network. This process uses profile-based configurations that ensure each server is configured per your specifications. This feature requires an iDRAC Enterprise license.

iDRAC9 offers following license tiers:

Table 28. iDRAC9 license tiers

License	Description
iDRAC9 Basic	<ul style="list-style-type: none"> • Available only on 100-500 series rack/tower • Basic instrumentation with iDRAC web UI • For cost conscious customers that see limited value in management
iDRAC9 Express	<ul style="list-style-type: none"> • Default on 600+ series rack/tower, modular, and XR series • Includes all features of Basic • Expanded remote management and server life-cycle features
iDRAC9 Enterprise	<ul style="list-style-type: none"> • Available as an upsell on all servers • Includes all features of Basic and Express. Includes key features such as virtual console, AD/LDAP support, and more • Remote presence features with advanced, Enterprise-class, management capabilities
iDRAC9 Datacenter	<ul style="list-style-type: none"> • Available as an upsell on all servers • Includes all features of Basic, Express, and Enterprise. Includes key features such as telemetry streaming, Thermal Manage, automated certificate management, and more • Extended remote insight into server details, focused on high end server options, granular power, and thermal management

For a full list of iDRAC features by license tier, see [Integrated Dell Remote Access Controller 9 User's Guide](#) at [Dell.com](#).

For more details on iDRAC9 including white papers and videos, see:

- [Support for Integrated Dell Remote Access Controller 9 \(iDRAC9\)](#) on the [Knowledge Base](#) page at [Dell.com](#)

Systems Management software support matrix

Table 29. Systems Management software support matrix

Categories	Features	PE mainstream
Embedded Management and In-band Services	iDRAC9 (Express, Enterprise, and Datacenter licenses)	Supported
	OpenManage Mobile	Supported
	OM Server Administrator (OMSA)	Supported
	iDRAC Service Module (iSM)	Supported
	Driver Pack	Supported
Change Management	Update Tools (Repository Manager, DSU, Catalogs)	Supported
	Server Update Utility	Supported
	Lifecycle Controller Driver Pack	Supported
	Bootable ISO	Supported
Console and Plug-ins	OpenManage Enterprise	Supported
	Power Manager Plug-in	Supported
	Update Manager Plug-in	Supported
	SupportAssist Plug-in	Supported
	CloudIQ	Supported
Integrations and connections	OM Integration with VMware Vcenter/vROps	Supported
	OM Integration with Microsoft System Center (OMIMSC)	Supported
	Integrations with Microsoft System Center and Windows Admin Center (WAC)	Supported

Table 29. Systems Management software support matrix (continued)

Categories	Features	PE mainstream
	ServiceNow	Supported
	Ansible	Supported
	Third-party Connectors (Nagios, Tivoli, Microfocus)	Supported
Security	Secure Enterprise Key Management	Supported
	Secure Component Verification	Supported
Standard operating system	Red Hat Enterprise Linux, SUSE, Windows Server 2021 Ubuntu, CentOS	Supported (Tier-1)

Appendix A. Standards compliance

The system conforms to the following industry standards.

Table 30. Industry standard documents

Standard	URL for information and specifications
ACPI Advance Configuration and Power Interface Specification, v2.0c	https://uefi.org/specsandtesttools
Ethernet IEEE 802.3-2005	https://standards.ieee.org/
HDG Hardware Design Guide Version 3.0 for Microsoft Windows Server	microsoft.com/whdc/system/platform/pcdesign/desguide/serverdg.msp
IPMI Intelligent Platform Management Interface, v2.0	intel.com/design/servers/ipmi
DDR5 Memory DDR5 SDRAM Specification	jedec.org/standards-documents/docs/jesd79-4.pdf
PCI Express PCI Express Base Specification Rev. 2.0 and 3.0	pcisig.com/specifications/pciexpress
PMBus Power System Management Protocol Specification, v1.2	http://pmbus.org/Assets/PDFS/Public/PMBus_Specification_Part_1_Rev_1-1_20070205.pdf
SAS Serial Attached SCSI, v1.1	http://www.t10.org/
SATA Serial ATA Rev. 2.6; SATA II, SATA 1.0a Extensions, Rev. 1.2	sata-io.org
SMBIOS System Management BIOS Reference Specification, v2.7	dmtf.org/standards/smbios
TPM Trusted Platform Module Specification, v1.2 and v2.0	trustedcomputinggroup.org
UEFI Unified Extensible Firmware Interface Specification, v2.1	uefi.org/specifications
USB Universal Serial Bus Specification, Rev. 2.7	usb.org/developers/docs

Appendix B: Additional resources

Topics:

- [Customer kits](#)
- [Documentation](#)

Customer kits

Dell Upgrades

It is not always possible to plan for new applications, future workloads, and business needs. Unleash the full power of your Dell Technologies Infrastructure. When budget does not permit the purchase of new servers, Dell Upgrades is a cost-effective method to repurpose and unleash the full power of existing server, storage, and networking infrastructure.

- Protect your mission-critical operations by using only genuine Dell OEM-validated Upgrades and the technical expertise of Dell ProSupport
- Flex and scale existing infrastructure by upgrading, adding memory or storage drives to cost-effectively and quickly meet new workloads and demands
- Dell Upgrades are the same peripheral commodities that your customer may improve or maintain their server after the initial point of sale

Upgrades portfolio

Table 31. Upgrade category





Dell Upgrade Category	Sample Picture	Dell Upgrade Category Offerings
<p>Memory</p> <p>Memory upgrades are essential for keeping your customers operating at peak performance as their business needs grow and their workloads increase. We tend to see strong demand for server memory because it is the easiest and most cost-effective way to improve system performance.</p>		<p>DDR5 4800 MT/s</p>
<p>Storage</p> <p>Dell offers both solid-state drive and hard disk drive storage options for enterprise systems with SATA, SAS or NVMe interfaces. SSDs excel in speed, high-performance I/O requirements, and high reliability due to the lack of spinning disks. Hard Disk Drives (HDDs) store data on spinning disks and offer value for the amount of data storage for the price.</p> <p>Dell offers both solid-state drive and hard disk drive storage options for enterprise systems with SATA, SAS</p>		<p>HDD: SATA, SAS interface</p> <p>SSD: SATA, SAS, PCI</p> <p>NVMe interface Tape Drive or Media</p>

Table 31. Upgrade category (continued)

Dell Upgrade Category	Sample Picture	Dell Upgrade Category Offerings
<p>interfaces. SSDs excel in speed, high-performance I/O requirements, and high reliability due to the lack of spinning disks. Hard Disk Drives (HDDs) store data on spinning disks and offer value for the amount of data storage for the price.</p>		
<p>Processor</p> <p>Processor upgrades help customers perform and accomplish more tasks overall, saving them valuable time. Our processor upgrades include Intel® Xeon® Scalable processors to meet your customers workload needs with increased cores and improved security.</p>		<p>Processors (Intel)</p> <p>Heat sinks</p>
<p>Networking and Optics</p> <p>Our networking and optics components—network interface cards, transceivers, optical cables, and more—are key in today’s data center environment, helping customers to improve bandwidth to better manage increase in workloads, devices, users, and interconnected systems.</p>		<p>Network cards</p> <p>Transceivers (Optics)</p>
<p>Accessories: Dell sells accessories like power supplies, cables and power cables, bezels, controller cards, GPU, PERC and other components to complete the Dell Upgrades portfolio and redundancies.</p>		<p>Controller cards</p> <p>Power supplies</p> <p>Cables</p> <p>Rail kits</p> <p>Bezels</p> <p>Power cords</p> <p>GPU</p> <p>PERC</p> <p>BOSS</p> <p>Power cords</p> <p>Cable Management Arm (CAM)</p> <p>Fans</p> <p>Serial board</p> <p>Internal USB</p>

Upgrades reference links

- [Main Upgrades Page](#)
- [Customer Kit Selector](#)
- [Dell Parts Finder Tool](#) (Customer Facing Tool)

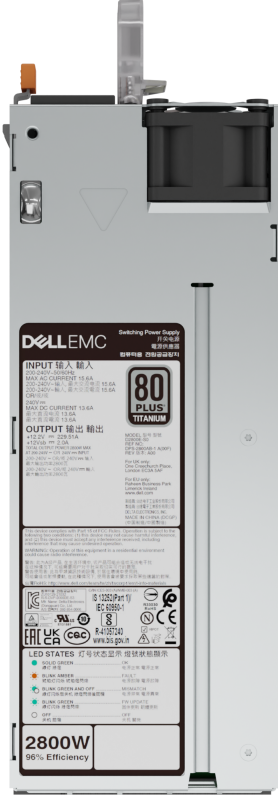
Documentation

This section provides information about the documentation resources for your system.

Table 32. Documentation resources

Document	Location
Factory Configuration Matrix	Sales Portal
SPM (Slot Priority Matrix)	Sales Portal
NDA Deck	Sales Portal
Installation and Service Manual (ISM)	https://www.dell.com/poweredgemanuals
Field Service Manual (FSM)	Educate Dell
Technical Guide	Dell.com > Product page > Product Details
Spec Sheet	Dell.com > Product page > Product Details

Appendix C: Additional specifications

Topics:

- Chassis dimensions
- System weight
- Video specifications
- USB ports specifications
- PSU rating
- Environmental specifications

Chassis dimensions

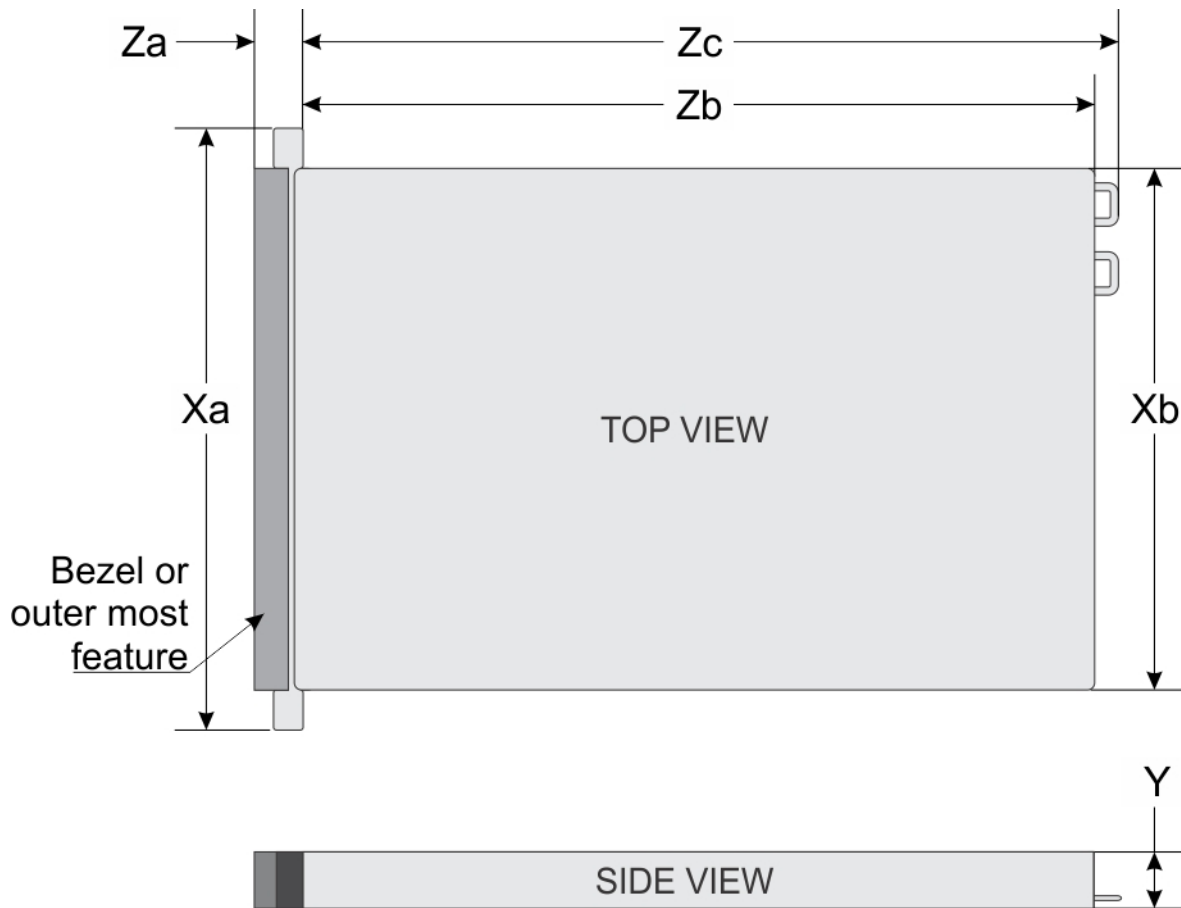

Figure 35. Chassis dimensions

Table 33. PowerEdge R760xs chassis dimensions

Xa	Xb	Y	Za	Zb	Zc
482.0 mm (18.97 inches)	434.0 mm (17.08 inches)	86.8 mm (3.41 inches)	22.0 mm (0.86 inches) Without bezel	677.44 mm (26.67 inches) Ear to L bracket housing	685.78 mm (26.99 inches) Ear to PSU

Table 33. PowerEdge R760xs chassis dimensions

Xa	Xb	Y	Za	Zb	Zc
			35.84 mm (1.41 inches) With bezel	650.24 mm (25.6 inches) Ear to PSU surface	handle without velcro strap

NOTE: Zb is the nominal rear wall external surface where the system board I/O connectors reside.

System weight

Table 34. PowerEdge R760xs systemweight

System configuration	Maximum weight (with all drives/SSDs/bezel)
16+8 x 2.5-inch	25.92 kg (57.14 lb)
16 x 2.5-inch	24.58 kg (54.18 lb)
12 x 3.5-inch	28.82 kg (63.53 lb)
8 x 3.5-inch	25.84 kg (54.96 lb)
8 x 2.5-inch	21.56 kg (47.53 lb)
No backplane configuration	19.40 kg (42.76 lb)

Video specifications

The PowerEdge R760xs system supports integrated Matrox G200 graphics controller with 16 MB of video frame buffer.

Table 35. Supported video resolution options for the system

Resolution	Refresh rate (Hz)	Color depth (bits)
1024 x 768	60	8, 16, 32
1280 x 800	60	8, 16, 32
1280 x 1024	60	8, 16, 32
1360 x 768	60	8, 16, 32
1440 x 900	60	8, 16, 32
1600 x 900	60	8, 16, 32
1600 x 1200	60	8, 16, 32
1680 x 1050	60	8, 16, 32
1920 x 1080	60	8, 16, 32
1920 x 1200	60	8, 16, 32

USB ports specifications

Table 36. PowerEdge R760xs USB specifications

Front		Rear		Internal (Optional)	
USB port type	No. of ports	USB port type	No. of ports	USB port type	No. of ports
USB 2.0-compliant port	One	USB 2.0-compliant port	One	Internal USB 3.0-compliant port	One
iDRAC Direct port (Micro-AB USB 2.0-compliant port)	One	USB 3.0-compliant port	One		

- NOTE:** The micro USB 2.0 compliant port can only be used as an iDRAC Direct or a management port.
- NOTE:** The USB 2.0 specifications provide a 5 V supply on a single wire to power connected USB devices. A unit load is defined as 100 mA in USB 2.0, and 150 mA in USB 3.0. A device may draw a maximum of 5 unit loads (500 mA) from a port in USB 2.0; 6 (900 mA) in USB 3.0.
- NOTE:** The USB 2.0 interface can provide power to low-power peripherals but must adhere to USB specification. An external power source is required for higher-power peripherals to function, such as external CD/DVD Drives.

PSU rating

Below table lists the power capacity the PSUs in high/low line operation mode.

Table 37. PSUs highline and lowline ratings

—	600 W Platinum	700 W Titanium	800 W Platinum	1100 W Titanium	1100 W -48 VDC	1400 W Platinum	1800 W Titanium
Peak Power (Highline/-72 VDC)	600 W	1190 W	1360 W	1870 W	1870 W	2380 W	3060 W
Highline/-72 VDC	600 W	700 W	800 W	1100 W	1100 W	1400 W	1800 W
Peak Power (Lowline/-40 VDC)	600 W	N/A	1360 W	1785 W	N/A	1785 W	N/A
Lowline/-40 VDC	600 W	N/A	800 W	1050 W	N/A	1050 W	N/A
Highline 240 VDC	600 W	700 W	800 W	1100 W	N/A	1400 W	1800 W
DC-48-60 V	N/A	N/A	N/A	N/A	1100 W	N/A	N/A

The PowerEdge R760xs supports up to two AC power supplies with 1+1 redundancy, autosensing, and auto switching capability. If two PSUs are present during POST, a comparison is made between the wattage capacities of the PSUs. In case the PSU wattages do not match, the larger of the two PSUs is enabled. Also, there is a PSU mismatch warning that is displayed in BIOS, iDRAC, or on the system LCD.

If a second PSU is added at run-time, in order for that particular PSU to be enabled, the wattage capacity of the first PSU must equal the second PSU. Otherwise, the PSU is flagged as unmatched in iDRAC and the second PSU is not enabled.

Dell PSUs have achieved Platinum efficiency levels as shown in the table below.

Table 38. PSU efficiency level

Efficiency Targets by Load						
Form factor	Output	Class	10%	20%	50%	100%
Redundant 60 mm	600 W AC	Platinum	89.00%	93.00%	94.00%	91.50%
	700 W AC	Titanium	90.00%	94.00%	96.00%	91.50%
	800 W AC	Platinum	89.00%	93.00%	94.00%	91.50%
	1100 W AC	Titanium	90.00%	94.00%	96.00%	91.50%
	1100 W -48 VDC	N/A	85.00%	90.00%	92.00%	90.00%
	1400 W AC	Platinum	89.00%	93.00%	94.00%	91.50%
	1800 W AC	Titanium	90.00%	94.00%	96.00%	94.00%

Environmental specifications

i **NOTE:** For additional information about environmental certifications, refer to the *Product Environmental Datasheet* located with the *Documentation* on www.dell.com/support/home.

Table 39. Continuous Operation Specifications for ASHRAE A2

Temperature, humidity and, operational altitude	Allowable continuous operations
Temperature range for altitudes <= 900 m (<= 2953 ft)	10–35°C (50–95°F) with no direct sunlight on the equipment
Humidity percent range (non-condensing at all times)	8% RH with -12°C (10.4°F) minimum dew point to 80% RH with 21°C (69.8°F) maximum dew point
Operational altitude de-rating	Maximum temperature is reduced by 1°C/300 m (1.8°F/984 Ft) above 900 m (2953 Ft)

Table 40. Continuous Operation Specifications for ASHRAE A3

Temperature, humidity and, operational altitude	Allowable continuous operations
Temperature range for altitudes <= 900 m (<= 2953 ft)	5–40°C (41–104°F) with no direct sunlight on the equipment
Humidity percent range (non-condensing at all times)	8% RH with -12°C (10.4°F) minimum dew point to 85% RH with 24°C (75.2°F) maximum dew point
Operational altitude de-rating	Maximum temperature is reduced by 1°C/175 m (1.8°F/574 Ft) above 900 m (2953 Ft)

Table 41. Continuous Operation Specifications for ASHRAE A4

Temperature, humidity and, operational altitude	Allowable continuous operations
Temperature range for altitudes <= 900 m (<= 2953 ft)	5–45°C (41–113°F) with no direct sunlight on the equipment
Humidity percent range (non-condensing at all times)	8% RH with -12°C (10.4°F) minimum dew point to 90% RH with 24°C (75.2°F) maximum dew point
Operational altitude de-rating	Maximum temperature is reduced by 1°C/125 m (1.8°F/410 Ft) above 900 m (2953 Ft)

Table 42. Continuous Operation Specifications for Rugged Environment

Temperature, humidity and, operational altitude	Allowable continuous operations
Temperature range for altitudes <= 900 m (<= 2953 ft)	5–45°C (41–113°F) with no direct sunlight on the equipment
Humidity percent range (non-condensing at all times)	8% RH with -12°C (10.4°F) minimum dew point to 90% RH with 24°C (75.2°F) maximum dew point
Operational altitude de-rating	Maximum temperature is reduced by 1°C/125 m (1.8°F/410 Ft) above 900 m (2953 Ft)

Table 43. Common Environmental Specifications for ASHRAE A2, A3, A4 and Rugged

Temperature, humidity and, operational altitude	Allowable continuous operations
Maximum temperature gradient (applies to both operation and non-operation)	20°C in an hour* (36°F in an hour) and 5°C in 15 minutes (9°F in 15 minutes), 5°C in an hour* (9°F in an hour) for tape <i>i</i> NOTE: * - Per ASHRAE thermal guidelines for tape hardware, these are not instantaneous rates of temperature change.
Non-operational temperature limits	-40 to 65°C (-104 to 149°F)
Non-operational humidity limits	5% to 95% RH with 27°C (80.6°F) maximum dew point
Maximum non-operational altitude	12,000 meters (39,370 feet)
Maximum operational altitude	3,048 meters (10,000 feet)

Table 44. Maximum vibration specifications

Maximum vibration	Specifications
Operating	0.21 G _{rms} at 5 Hz to 500 Hz for 10 minutes (all operation orientations)
Storage	1.88 G _{rms} at 10 Hz to 500 Hz for 15 minutes (all six sides tested)

Table 45. Maximum shock pulse specifications

Maximum shock pulse	Specifications
Operating	Six consecutively executed shock pulses in the positive and negative x, y, and z axis of 6 G for up to 11 ms.
Storage	Six consecutively executed shock pulses in the positive and negative x, y, and z axis (one pulse on each side of the system) of 71 G for up to 2 ms.

Thermal restriction matrix

Table 46. Processor and heat sink matrix

Heat sink	Processor TDP
STD HSK	< 185 W CPU SKUs
HPR HSK	185 W-250 W CPU SKUs (12 x 3.5-inch drive configuration not supported)
	125W-250W CPU SKUs (12 x 3.5-inch drive configuration supported)

Table 47. Label reference

Label	Description
STD	Standard

Table 47. Label reference (continued)

Label	Description
HPR (Silver)	High Performance Silver (HPR) fan
HPR (Gold)	High Performance Gold (VHP) fan
HSK	Heat sink

i **NOTE:** The ambient temperature of the configuration is determined by the critical component in that configuration. For example, if the processor's supported ambient temperature is 35°C, the DIMM is 35°C, and the GPU is 30°C, the combined configuration can only support 30°C.

Table 48. Supported ambient temperature for processors for R760xs

R760xs										
configuration			No backplane	8 x 3.5-inch SAS configuration	12 x 3.5-inch SAS configuration	12 x 3.5-inch configuration with rear drive module	8 x 2.5-inch SAS configuration	8 x 2.5-inch NVMe configuration	16 x 2.5-inch SAS configuration	16 x 2.5-inch + 8 x 2.5-inch NVMe configuration
SPR MCC CPU	3408U	125 W	45°C	40°C	35°C	35°C	40°C	40°C	40°C	40°C
	5416S/4410T/4410Y/5415+	150 W	45°C	40°C	35°C	35°C	40°C	40°C	40°C	40°C
	4416	165 W	45°C	40°C	35°C	35°C	40°C	40°C	40°C	40°C
	5418Y/5412U/6426Y	185 W	45°C	40°C	35°C	35°C	40°C	40°C	40°C	40°C
	5420+/6438Y+	205 W	35°C	35°C	35°C	35°C	35°C	35°C	35°C	35°C
	6448Y/6442Y	225 W	35°C	35°C	35°C	35°C	35°C	35°C	35°C	35°C
	6414U	250 W	35°C	35°C	30°C	30°C	35°C	35°C	35°C	35°C
Memory	64 GB RDIMM 4800	12 W, 1DPC	45°C	40°C	35°C	35°C	40°C	40°C	40°C	40°C
	32 GB RDIMM 4800	10 W, 1DPC	45°C	40°C	35°C	35°C	40°C	40°C	40°C	40°C
PCIe			45°C	40°C	35°C ¹	35°C ¹	40°C	40°C	40°C	40°C
A2 GPU ⁶			35°C	30°C	Not supported	Not supported	35°C	35°C	30°C	30°C
OCP			45°C	40°C	35°C ²	35°C ²	40°C	40°C	40°C	40°C
BOSS			35°C	35°C	35°C	35°C	35°C	35°C	35°C	35°C

i **NOTE:**

1. Max supported thermal tier of PCIe card is Tier 5.
2. Max supported thermal tier of OCP is Tier 5.
3. HPR Silver fan is required from fan zone 2 to fan zone 6 for 8 x 2.5-inch NVMe, 16 x 2.5-inch SAS/SATA + 8 x 2.5-inch NVMe, 12 x 3.5-inch drives or GPU configurations.
4. Optional fan zone 1 has to be populated with HPR Gold fan is for BOSS, GPU or rear drive module populations.
5. PCIe slot priority of Nvidia A2 GPU is constrained on slot #3, #4, #6.

6. HPR heatsink is required for ≥ 185 W CPUs, 12 x 3.5-inch drives or 12 x 3.5-inch drives with rear storage module configurations.
7. DIMM blank is required for 12 x 3.5-inch SAS/SATA with rear storage module.
8. Fan blank is required on fan zone 1 when no fan population.
9. OCP shroud is required for OCP card population without PCIe riser module installed.
10. CPU blank is required for single processor configuration.
11. Rear drive module doesn't support Kioxia CM6 series, Samsung PM1735 series, Hynix PE8010 7.68TB, Samsung PM1733a > 1.92TB, Samsung PM1735a > 1.6TB and Redtail NVMe drive.

NOTE: The fan speed in the 3.5-inch chassis is limited to 90% due to the drive dynamic profile.

Table 49. Fan population rule for R760xs

configuration	No backplane	8 x 3.5-inch SAS	12 x 3.5-inch SAS	8 x 2.5-inch SAS	8 x 2.5-inch NVMe	16 x 2.5-inch SAS	24 x 2.5-inch (16 x 2.5-inch + 8 x 2.5-inch NVMe)
Optional HW							
Default	Fan 2 to Fan 6 with STD fan	Fan 2 to Fan 6 with STD fan	Fan 2 to Fan 6 with HPR Silver fan	Fan 2 to Fan 6 with STD fan	Fan 2 to Fan 6 with HPR Silver fan	Fan 2 to Fan 6 with STD fan	Fan 2 to Fan 6 with HPR Silver fan
Rear Module	Not supported	Not supported	Fan 1 with HPR Gold fan Fan 2 to Fan 6 with HPR Silver fan	Not supported	Not supported	Not supported	Not supported
BOSS N1	Fan 1 with HPR Gold fan Fan 2 to Fan 6 with STD fan	Fan 1 with HPR Gold fan Fan 2 to Fan 6 with STD fan	Fan 1 with HPR Gold fan Fan 2 to Fan 6 with HPR Silver fan	Fan 1 with HPR Gold fan Fan 2 to Fan 6 with STD fan	Fan 1 with HPR Gold fan Fan 2 to Fan 6 with HPR Silver fan	Fan 1 with HPR Gold fan Fan 2 to Fan 6 with STD fan	Fan 1 with HPR Gold fan Fan 2 to Fan 6 with HPR Silver fan
GPU	Fan 1 with HPR Gold fan Fan 2 to Fan 6 with HPR Silver fan	Fan 1 with HPR Gold fan Fan 2 to Fan 6 with HPR Silver fan	Not supported	Fan 1 with HPR Gold fan Fan 2 to Fan 6 with HPR Silver fan	Fan 1 with HPR Gold fan Fan 2 to Fan 6 with HPR Silver fan	Fan 1 with HPR Gold fan Fan 2 to Fan 6 with HPR Silver fan	Fan 1 with HPR Gold fan Fan 2 to Fan 6 with HPR Silver fan

Thermal Restrictions for PCIe adapter NIC and other network cards

- Cannot support PCIe card with the cooling requirement more than 300LFM at 55C in 12 x 3.5-inch SAS/SATA configuration.
- Solarflare Melrose DP 25 GBE SFP28 (TTKWY) not supported with 12 x 3.5-inch SAS/SATA configuration.
- 100 Gb network adapter or 100 Gb OCP is not supported in 12 x 3.5-inch SAS/SATA configuration.
- Few 25 GB OCP cards with the cooling requirement more than 250LFM at 55C (3Y64D / 4TRD3 / GGGDF / R1KTR / Y4VV5) is not supported in 12x3.5" SAS/SATA configuration.
- 12 x 3.5-inch SAS/SATA configuration requires the optical transceiver with higher temperature spec ($\geq 85^{\circ}\text{C}$) to support (M14MK / N8TDR).
- Quad port OCP (3Y64D/Y4VV5) requires the optical transceiver with higher temperature spec ($\geq 85^{\circ}\text{C}$) to support (M14MK).
- 100 Gb network adapter can't support the transceivers as 14NV5 / 9JKK2 / QSFP56 (MFS1S00-VxxxE / HxxxE).

Thermal restrictions for extended ambient support (ASHRAE A3/A4)

- Two PSUs are required in redundant mode. Single PSU failure is not supported.
- 12 x 3.5-inch SAS/SATA configuration is not supported.
- BOSS(M.2) module is not supported.
- CPU TDP > 185 W is not supported.
- PCIe card TDP > 25 W is not supported.
- OCP card with transmission rate higher than 25 GB is not supported.
- OCP transceiver spec $\leq 75^{\circ}\text{C}$ is not supported.
- 8 x 3.5-inch SAS/SATA, 8 x 2.5-inch SAS/SATA, 8 x 2.5-inch NVMe, 16 x 2.5-inch SAS/SATA, 16 x 2.5-inch SAS/SATA + 8x 2.5-inch NVMe configurations are limited to support A3.
- 128 GB+ memory is not supported .
- Rear drive is not supported.

Appendix D: Service and support

Topics:

- [Default support levels](#)
- [Other services and support information](#)

Default support levels

This system offers 3 years Dell ProSupport Next Business Day (NBD), including 24x7 phone support and NBD parts and labor support.

Default deployment levels

This system is defaulted to the ProDeploy Dell Server which includes onsite hardware installation and remote software configuration. Optionally, the customer may choose to any of the factory or field deployment offers listed below.

Other services and support information

Dell Technologies Services include a wide, customizable range of service options to simplify the assessment, design, implementation, management and maintenance of IT environments and to help transition from platform to platform.

Depending on the current business requirements and correct level of service for customers, we provide factory, onsite, remote, modular, and specialized services that fit the customer requirements and budget. We will help with a little or a lot, based on the customers choice, and provide access to our global resources.

Dell deployment services

[Dell ProDeploy Infrastructure Suite](#)

ProDeploy Infrastructure Suite provides a variety of deployment offerings that satisfy a customer's unique needs. It is made up of 5 offers: ProDeploy Configuration Services, ProDeploy Rack Integration Services, Basic Deployment, ProDeploy, and ProDeploy Plus.

ProDeploy Infrastructure Suite for servers

Versatile choices for accelerated deployments

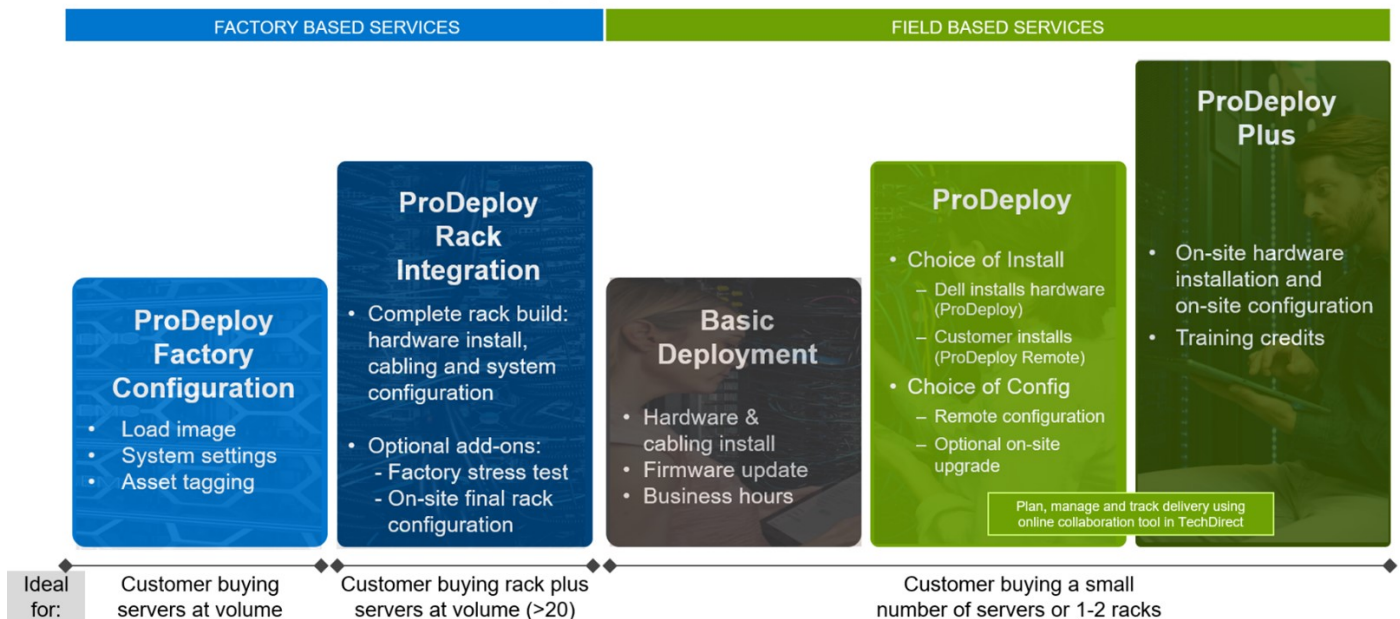

Figure 36. ProDeploy Infrastructure Suite for servers

The new Factory Services consist of two tiers of deployment that happen prior to shipping to the customer's site.

Factory Based Services:

- ProDeploy Factory Configuration - Ideal for customers buying servers in volume and seeking pre-configuration prior to shipping such as: custom image, system settings, and asset tagging so it arrives ready to use out of the box. Furthermore, servers can be packaged and bundled to meet specific shipping and distribution requirements for each customer location to facilitate the rollout process. Upsell one of the field based services (below) if a customer needs assistance with the final server installation.
- ProDeploy Rack Integration - Ideal for customers seeking to build out fully integrated racks prior to shipping. These rack builds include hardware install, cabling, and full system configuration. You can also add-on a factory stress test and optional on-site final rack configuration to complete the rack installation.
 - STANDARD SKUs for Rack Integration is available in US only and requires:
 - 20 or more devices (R and C series servers and all Dell or non-Dell switches). Use Informational SKUs for Dell switches or 3rd party products
 - Shipping to contiguous US
 - USE CUSTOM QUOTE for Rack Integration for:
 - All countries except USA
 - Racks containing less than 20 servers
 - Any rack that includes VxRail or Storage
 - Shipping outside contiguous US
 - Shipping to multiple locations

Field Based Services:

- Basic Deployment consists of the hardware installation, cabling and firmware update during normal standard business hours. Basic Deployment is traditionally sold to Competency Enabled Partners. Competency enabled partners often have Dell do the hardware installation while they complete the software configuration.
- ProDeploy consists of your hardware installation and configuration of the software using offshore resources. ProDeploy is great for customers who are price sensitive or who are remote from their data centers and don't require an onsite presence.
- ProDeploy Plus will give you in-region or onsite resources to complete the engagement for the customer. It also comes with additional features such as Post Deployment Configuration Assistance and Training Credits.

ProDeploy Infrastructure Suite | Factory services

FACTORY BASED SERVICES

		ProDeploy Factory Configuration	ProDeploy Rack Integration
Asset configuration	Single point of contact for project management	●	●
	RAID, BIOS and iDRAC configuration	●	●
	Firmware freeze	●	●
	Asset Tagging and Reporting	●	●
	Customer system image	●	●
Factory implementation	Site readiness review and implementation planning	-	●
	Hardware racking and cabling	-	●
	SAM engagement for ProSupport Plus entitled accounts/devices	-	●
	Deployment verification, documentation, and knowledge transfer	●	●
Delivery	White glove logistics	-	●
	Onsite final configuration	-	Onsite add-on
	Install support software and connect with Dell Technologies	-	Onsite add-on
	Basic Deployment	Optional onsite installation	-
Online oversight	Online collaborative environment for planning, managing and tracking delivery	-	●

¹ ProDeploy Rack Integration Services are currently only available within the United States. Custom rack integration services are still available globally.*

Dell Technologies

Figure 37. ProDeploy Infrastructure Suite - Factory services

ProDeploy Infrastructure Suite | Field services

		Basic Deployment	ProDeploy	ProDeploy Plus
Pre-deployment	Single point of contact for project management	●	●	In-region
	Site readiness review	-	●	●
	Implementation planning ¹	-	●	●
	SAM engagement for ProSupport Plus entitled devices	-	-	●
Deployment	Deployment service hours	Business hours	24x7	24x7
	Onsite hardware installation and packaging material removal ² or remote guidance for hardware installation ¹	●	Remote guidance or onsite	Onsite
	Install and configure system software	-	Remote	Onsite
	Install support software and connect with Dell Technologies	-	●	●
	Project documentation with knowledge transfer	-	●	●
Post-deployment	Deployment verification	-	●	●
	Configuration data transfer to Dell Technologies technical support	-	●	●
	30-days of post-deployment configuration assistance	-	-	●
	Training credits for Dell Technologies Education Services	-	-	●
Online oversight	Online collaborative environment in TechDirect for planning, managing and tracking delivery ³	-	●	●

¹ Remote option includes project specific instructions, documentation and live expert guidance for hardware installation. Option available for select hardware. [List is available in the backup portion of this customer presentation](#)

² Packaging removal included with onsite hardware installation

³ Included with ProDeploy or ProDeploy Plus, Not included with Basic Deployment

Figure 38. ProDeploy Infrastructure Suite - Field services

Dell ProDeploy Plus for Infrastructure

From beginning to end, ProDeploy Plus provides the skill and scale that is must successfully perform demanding deployments in today's complex IT environments. Certified Dell experts start with extensive environmental assessments and detailed migration

planning and recommendations. Software installation includes set up of our enterprise connectivity solution (secure connect gateway) and OpenManage system management utilities.

Postdeployment configuration assistance, testing, and product orientation services are also available.

Dell ProDeploy for Infrastructure

ProDeploy provides full-service installation and configuration of both server hardware and system software by certified deployment engineers including set up of leading operating systems and hypervisors as well our enterprise connectivity solution (secure connect gateway) and OpenManage system management utilities. To prepare for the deployment, we conduct a site readiness review and implementation planning exercise. System testing, validation, and full project documentation with knowledge transfer complete the process.

Dell Basic Deployment

Basic Deployment delivers worry-free professional installation by experienced technicians who know Dell servers inside and out.

Additional Deployment Services

You can tailor the ProDeploy Infrastructure Suite offer to meet your customer's unique needs by leveraging "Additional Deployment Time." ADT will cover additional tasks above the normal scope of the standard offers. ADT can be sold for Project Management or Technical Resources and is sold as blocks of four hours remote or eight hours on-site.

Dell ProDeploy for HPC (available in US/Canada only. All other regions use custom)

HPC deployments require specialists that understand that cutting edge is yesterday's news. Dell deploys the world 's fastest systems and understands the nuances that make them perform. ProDeploy for HPC provides:

- Global team of dedicated HPC specialists
- Proven track record, thousands of successful HPC deployments
- Design validation, benchmarking, and product orientation

Learn more at Dell.com/HPC-Services.

ProDeploy Expansion for HPC

*Available as standard SKUs in US & Canada and as custom quote in APJC, EMEA, LATAM

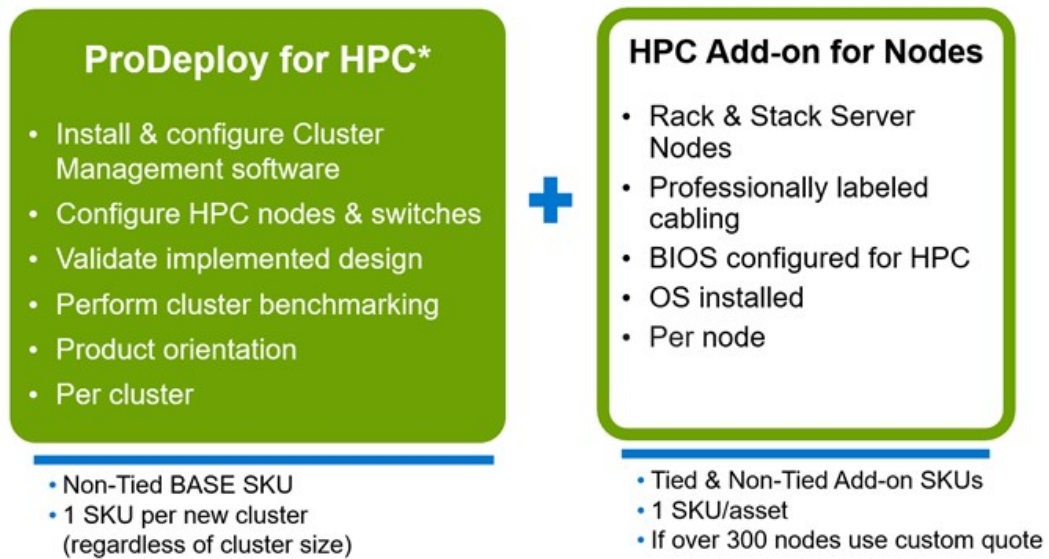

Figure 39. ProDeploy Expansion for HPC

Dell custom deployment Services

Dell custom rack integration and other Dell configuration services help customers save time by providing systems that are racked, cabled, tested, and ready to be integrated into the data center. Dell support preconfigure RAID, BIOS and iDRAC settings, install system images, and even install third-party hardware and software.

For more information, see [Server Configuration Services](#).

Dell Residency Services

Residency Services help customers transition to new capabilities quickly with the assistance of onsite or remote Dell experts whose priorities and time they control.

Residency experts can provide post implementation management and knowledge transfer that is related to a new technology acquisition or day-to-day operational management of the IT infrastructure.

Dell Data Migration Services

Protect business and data of the customer with our single point of contact to manage data migration projects.

A customer project manager works with our experienced team of experts to create a plan using industry-leading tools and proven processes that are based on global best practices to migrate existing files and data, so business systems are up and running quickly and smoothly.

Dell Enterprise Support Services

Dell ProSupport Enterprise Suite

With the ProSupport Enterprise Suite, we help keep IT systems running smoothly, so customers can focus on running their business. We help maintain peak performance and availability of the most essential workloads. ProSupport Enterprise Suite is a suite of support services that enable customers to build the solution that is right for their organization. They choose support models that are based on how they use technology and where they want to allocate resources. From the desktop to the data center, address everyday IT challenges, such as unplanned downtime, mission-critical needs, data and asset protection, support planning, resource allocation, software application management and more. Optimize customer IT resources by choosing the right support model.

Table 50. ProSupport Enterprise Suite

Service	Support model	Description
ProSupport Enterprise Suite	ProSupport Plus for Enterprise	Proactive, predictive, and reactive support for systems that look after your business-critical applications and workloads
	ProSupport for Enterprise	Comprehensive 24 x 7 predictive and reactive support for hardware and software
	Basic hardware support	Reactive hardware support during normal business hours

Dell ProSupport Plus for Enterprise

When customers purchase PowerEdge server, we recommend ProSupport Plus, our proactive and preventative support service for business-critical systems. ProSupport Plus provides all the benefits of ProSupport, plus the following:

- An assigned Services Account Manager who knows their business and environment
- Immediate advanced troubleshooting from an engineer
- Personalized, preventive recommendations that are based on analysis of support trends and best practices from across the Dell Technologies infrastructure solutions customer base to reduce support issues and improve performance
- Predictive analysis for issue prevention and optimization that is enabled by secure connect gateway technology
- Proactive monitoring, issue detection, notification, and automated case creation for accelerated issue resolution enabled by secure connect gateway
- On-demand reporting and analytics-based recommendations that are enabled by secure connect gateway and TechDirect

Dell ProSupport for Enterprise

ProSupport service offers highly trained experts around the clock and around the globe to address IT needs. We help minimize disruptions and maximize availability of PowerEdge server workloads with:

- 24x7 support through phone, chat and online
- Predictive, automated tools and innovative technology
- A central point of accountability for all hardware and software issues
- Collaborative third-party support
- Hypervisor, operating system and application support
- Consistent experience regardless of where customers are located or what language they speak

 **NOTE:** Subject to service offer country or region availability.

- Optional onsite parts and labor response options including next business day or four-hour mission critical

ProSupport Enterprise Suite Feature Comparison			
	Basic	ProSupport	ProSupport Plus
Remote technical support	9x5	24x7	24x7
Covered products	Hardware	Hardware Software	Hardware Software
Onsite hardware support	Next business day	Next business day or 4hr mission critical	Next business day or 4 hr mission critical
3 rd party collaborative assistance		●	●
Self-service case initiation and management		●	●
Access to software updates		●	●
Proactive storage health monitoring, predictive analytics and anomaly detection with CloudIQ and the CloudIQ mobile app		●	●
Priority access to specialized support experts			●
Predictive detection of hardware failures			●
3 rd party software support			●
An assigned Service Account Manager			●
Proactive, personalized assessments and recommendations			●
Proactive systems maintenance			●

Availability and terms of Dell Technologies Services vary by region and by product. For more information, please view our [service descriptions](#).

Internal Use - Confidential 23 of 117 © Copyright 2022 Dell Inc. **DELL** Technologies

Figure 40. ProSupport Enterprise Suite

Dell ProSupport One for Data Center

ProSupport One for Data Center offers flexible site-wide support for large and distributed data centers with more than 1,000 assets. This offering is built on standard ProSupport components that leverage our global scale but are tailored to a customer's needs. While not for everyone, this service option offers a truly unique solution for Dell Technologies largest customers with the most complex environments.

- Team of assigned Services Account Managers with remote, on-site options
- Assigned ProSupport One technical and field engineers who are trained on the customer's environment and configurations
- On-demand reporting and analytics-based recommendations that are enabled by secure connect gateway and TechDirect
- Flexible on-site support and parts options that fit their operational model
- A tailored support plan and training for their operations staff

Dell ProSupport Add-on for HPC

The ProSupport Add-on for HPC provides solution-aware support including:

- Access to senior HPC experts
- Advanced HPC cluster assistance: performance, interoperability, and configuration
- Enhanced HPC solution level end-to-end support
- Remote presupport engagement with HPC Specialists during ProDeploy implementation

Learn more at Dell.com/HPC-Services.

ProSupport Add-on for HPC is an add-on to PS or PSP

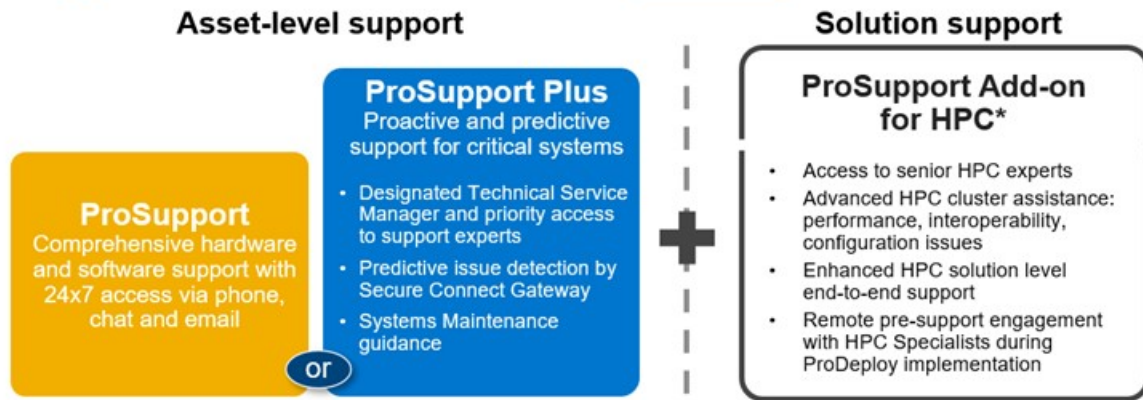

Eligibility

- All server, storage, and networking nodes in cluster must have PS or PSP **AND** PS Add-on for HPC attached
- All HW expansions to clusters must attach PS or PSP **AND** PS Add-on for HPC
- To retrofit an entire existing cluster with PS Add-on for HPC:
 1. HPC Specialists must review and validate the existing cluster
 2. PS or PSP **AND** the PS Add-on for HPC (APOS) must be attached to all server, storage and networking nodes

*Available in standard SKUs in NA and EMEA and as custom quote in APJC & LATAM

DELLTechnologies

Figure 41. ProSupport Add-on for HPC is an add-on to PS or PSP

Support Technologies

Powering the support experience with predictive, data-driven technologies.

NOTE: SupportAssist Enterprise capabilities are now part of the secure connect gateway technology.

Enterprise connectivity

The best time to solve a problem is before it happens. The automated proactive and predictive support features enabled by the secure connect gateway technology helps reduce steps and time to resolution, often detecting issues before they become a crisis. The gateway technology is available in virtual and application editions. It is also implemented as a direct connect version for select Dell hardware and a Services plugin within OpenManage Enterprise for PowerEdge servers. The legacy SupportAssist Enterprise solution has been retired and is now replaced by the secure connect gateway solutions.

Benefits include:

- Value: Our connectivity solutions are available to all customers at no additional charge
- Improve productivity: Replace manual, high-effort routines with automated support
- Accelerate time to resolution: Receive issue alerts, automatic case creation, and proactive contact from Dell experts
- Gain insight and control: Optimize enterprise devices with insights in portals reporting like TechDirect, and get predictive issue detection before the problem starts

NOTE: Connect devices can access these features. Features vary depending on the service level agreement for the connected device. ProSupport Plus customers experience the full set of automated support capabilities.

Table 51. Features enabled by connectivity

	Basic hardware warranty	ProSupport	ProSupport Plus
Automated issue detection and system state information collection	Supported	Supported	Supported
Proactive, automated case creation and notification	Not supported	Supported	Supported

Table 51. Features enabled by connectivity (continued)

	Basic hardware warranty	ProSupport	ProSupport Plus
Predictive issue detection for failure prevention	Not supported	Not supported	Supported

Get started at DellTechnologies.com/secureconnectgateway.

Dell TechDirect

TechDirect helps boost IT team productivity when supporting Dell systems.

Boost your productivity with online service for Dell products from TechDirect. From deployment to technical support, TechDirect lets you do more with less effort and faster resolution. You can:

- Open and manage support requests or in-warranty systems
- Execute online self-service for parts dispatch
- Collaborate on ProDeploy infrastructure deployment projects online
- Manage proactive and predictive alerts from secure connect gateway technology that help maximize uptime
- Integrate services functionality into your help desk with TechDirect APIs
- Join over 10,000 companies that choose TechDirect

Register at TechDirect.Dell.com.

Dell Technologies Consulting Services

Our expert consultants help customers transform faster, and quickly achieve business outcomes for the high value workloads Dell PowerEdge systems can handle. From strategy to full-scale implementation, Dell Technologies Consulting can help determine how to perform IT, workforce, or application transformation. We use prescriptive approaches and proven methodologies that are combined with portfolio and partner ecosystem of Dell Technologies to help achieve real business outcomes. From multi cloud, applications, DevOps, and infrastructure transformations, to business resiliency, data center modernization, analytics, workforce collaboration, and user experiences-we are here to help.

Dell Managed Services

Some customers prefer Dell to manage the complexity and risk of daily IT operations, Dell Managed Services utilizes proactive, AI enabled delivery operations and modern automation to help customers realize desired business outcomes from their infrastructure investments. With these technologies, our experts run, update and fine-tune customer environments aligned with service levels, while providing environment-wide and down-to-the-device visibility. There are two types of managed service offers. First the outsourcing model or CAPEX model where Dell manages the customer owned assets using our people and tools. The second is the as-a-Service model or OPEX model called APEX. In this service, Dell owns all technology and all the management of it. Many customers will have a blend of the two management types depending on the goals of the organization.

Managed Outsourcing or CAPEX model		APEX as-a-Service or OPEX model
<p>We manage your technology using our people and tools.¹</p> <ul style="list-style-type: none"> • Managed detection and response* • Technology Infrastructure • End-user (PC/desktop) • Service desk operations • Cloud Managed (Pub/Private) • Office365 or Microsoft Endpoint 		<p>We own all technology so you can off-load all IT decisions.</p> <ul style="list-style-type: none"> • APEX Cloud Services • APEX Flex on Demand elastic capacity • APEX Data Center Utility pay-per-use model

1 – Some minimum device counts may apply. Order via: ClientManagedServices.sales@dell.com

* Managed detection and response covers the security monitoring of laptops, servers, & virtual servers. Min. 50 devices combined. No Networking or Storage-only systems [SAN/NAS]. Available in 32 countries. [Details here](#)

Figure 42. Dell Managed Services

Dell Technologies Education Services

Build the IT skills required to influence the transformational outcomes of the business. Enable talent and empower teams with the right skills to lead and perform transformational strategy that drives competitive advantage. Leverage the training and certification required for real transformation.

Dell Technologies Education Services offers PowerEdge server training and certifications that are designed to help customers achieve more from their hardware investment. The curriculum delivers the information and the practical, firsthand skills that their team must confidently install, configure, manage, and troubleshoot Dell servers.

To learn more or register for a class today, see Education.Dell.com.