

Dell EMC PowerEdge R7515

Technical Guide

Notes, cautions, and warnings

 **NOTE:** A NOTE indicates important information that helps you make better use of your product.

 **CAUTION:** A CAUTION indicates either potential damage to hardware or loss of data and tells you how to avoid the problem.

 **WARNING:** A WARNING indicates a potential for property damage, personal injury, or death.

Chapter 1: Product overview	5
Introduction.....	5
Featured technologies.....	5
Chapter 2: System features	7
Product comparison.....	7
Chapter 3: Chassis views and features	9
Front view of the system.....	9
Rear view of the system.....	10
Inside the system.....	12
Quick Resource Locator for PowerEdge R7515 system.....	14
Chapter 4: Processor	15
Processor features.....	15
Supported processors.....	15
Chapter 5: Memory	17
Supported memory.....	17
Memory speed.....	18
Chapter 6: Storage	19
Supported drives.....	19
Storage controllers.....	21
Optical drives.....	21
External drives.....	21
Chapter 7: Networking and PCIe	23
Expansion card installation guidelines.....	23
Chapter 8: Power, thermal, and acoustics	29
Power.....	29
Thermal	30
Acoustics.....	30
Chapter 9: Supported operating systems	31
Chapter 10: Dell EMC OpenManage systems management	32
iDRAC9 with Lifecycle Controller.....	33
Agent-free management.....	36
Agent-based management.....	36
Dell EMC consoles.....	36
Dell EMC OpenManage systems management tools, utilities, and protocols.....	38

Integration with third-party consoles.....	39
OpenManage connections with third-party consoles.....	39
Chapter 11: Dell Technologies Services	41
Dell EMC ProDeploy Enterprise Suite	41
Dell EMC ProDeploy Plus.....	42
Dell EMC ProDeploy.....	42
Dell EMC Basic Deployment.....	42
Dell EMC Server Configuration Services.....	42
Dell EMC Residency Services.....	42
Dell EMC Remote Consulting Services.....	42
Dell EMC Data Migration Service.....	42
Prosupport Enterprise Suite.....	42
Dell EMC ProSupport Plus for Enterprise.....	43
Dell EMC ProSupport for Enterprise.....	43
Dell EMC ProSupport One for Data Center.....	44
Support Technologies.....	44
Dell Technologies Education Services.....	45
Dell Technologies Consulting Services.....	45
Dell EMC Managed Services.....	45
Chapter 12: Appendix A. Additional specifications.....	46
Chassis dimensions.....	46
Chassis weight.....	47
Video specifications.....	47
USB ports specifications.....	48
Environmental specifications.....	48
Thermal restriction matrix.....	50
Chapter 13: Appendix B. Standards compliance.....	54
Chapter 14: Appendix C Additional resources.....	55

Product overview

Topics:

- [Introduction](#)
- [Featured technologies](#)

Introduction

The Dell EMC PowerEdge R7515 (2U rack system) is a 1-socket, 2U server that is designed to run complex workloads using highly scalable memory, I/O ports, and network channels. The system is based on the 2nd and 3rd Generation AMD EPYC processors, which support several SKUs ranging from 16 cores and up to 64 cores, up to 16 DIMMs, PCI Express-4.0 enabled expansion slots, and a choice of LOM riser technologies.

The R7515 is a general-purpose platform capable of handling demanding workloads and applications such as data warehouses, ecommerce, databases, and high-performance computing. Also, the server provides extraordinary storage capacity options, making it well-suited for data-intensive applications without sacrificing I/O performance.

Featured technologies

The following table lists the featured technologies for the PowerEdge R7515:

Table 1. PowerEdge R7515 featured technologies

Technology	Detailed Description
2nd Generation and 3rd Generation AMD EPYC Based Server SOCs	<ul style="list-style-type: none"> • A highly scalable, 32-core System on Chip, design with support for two high-performance threads per core • 14 nm processor technology • Industry-leading memory bandwidth, with 8-channels of memory per device. In a 1-socket server, support for up to 16 DIMMs of DDR4 on 8 memory channels, delivering up to 2 TB of total memory capacity • The processor is a complete SoC with fully integrated, high-speed I/O supporting 128 lanes of PCIe Gen3 and Gen4, negating the need for a separate chipset • A highly optimized cache structure for high-performance, energy-efficient compute • Dedicated security hardware
DDR4 Memory	<ul style="list-style-type: none"> • Up to 3200 MT/s for 1 DIMM per channel • Two DIMMs per channel up to 2933 MT/s with these processors • 8x DDR4 channels per socket, 2 DIMMs per channel (2DPC) • RDIMMs up to 64 GB and LRDIMMs up to 128GB
Software RAID	Next Generation SW RAID, PERC S150—The new AMD servers support the latest S150 software RAID together with the H330 and H730P controller cards to enable improved functionality and faster performance. New SW RAID supports RAID 0, 1, 5 and 10.
iDRAC9 w/ Lifecycle Controller	The embedded systems management solution features hardware and firmware inventory alerts, in-depth memory alerts, faster performance, a dedicated Gb port, and many more features.

Table 1. PowerEdge R7515 featured technologies (continued)

Technology	Detailed Description
Wireless Management	<p>The Quick Sync feature is an extension of the NFC-based low-bandwidth interface. Quick Sync 2.0 offers feature parity with previous versions of the NFC interface.</p> <p>Since the introduction of iDRAC in PowerEdge Servers, the server management system has improved, adding different local and remote user interfaces including Web interface, RACADM, WSMAN, BIOS F2 Setup, and LCD to iDRAC. Quick Sync 2.0 replaces previous generations of the NFC technology to extend the feature to a wider variety of mobile operating systems with higher data throughput.</p>

System features

Topics:

- [Product comparison](#)

Product comparison

The following table shows the comparison between the PowerEdge R7515 with the R7415:

Table 2. Product comparison

Feature	PowerEdge R7515	PowerEdge R7415
Processor	2 nd Generation AMD EPYC SP3 3 rd Generation AMD EPYC SP3	AMD Naples SP3
Memory	16x DDR4 RDIMM, LRDIMM, 3DS	16x DDR4 RDIMM, LRDIMM
Disk Drives	3.5-inch and 2.5-inch: <ul style="list-style-type: none"> • 12 G SAS • 6 G SATA HDD/SSD 	3.5-inch and 2.5-inch: <ul style="list-style-type: none"> • 12 G SAS • 6 G SATA HDD/SSD
Storage Controllers	<ul style="list-style-type: none"> • Mini PERC: HBA330, H330, H730P, H740P, H840, HBA355e • Host Bus Adapter: 12 Gbps SAS HBA • SW RAID: S150 	<ul style="list-style-type: none"> • Mini PERC: HBA330, H330, H730P, H740P, H840 • Host Bus Adapter: 12 Gbps SAS HBA • SW RAID: S140
PCIe SSD	Up to 24x PCIe SSD (Gen3)	Up to 24x PCIe SSD (Gen3)
PCIe Slots	Up to 4: <ul style="list-style-type: none"> • 2 Gen3 slot (x16) • 2 Gen4 slot (x16)-Slot 3/4 	Up to 4: <ul style="list-style-type: none"> • 3 Gen3 slot (x16) • 1 Gen3 slot (x8)
OCP 2.0	OCP Type 1: (Connector A)	OCP Type 1: (Connector A)
USB Ports	<ul style="list-style-type: none"> • Front: 2 x USB 2.0, 1 x iDRAC USB(Micro USB) port • Rear: 2 x USB 3.0_Gen1 port • Internal: 1 x USB 3.0 port 	<ul style="list-style-type: none"> • Front: 2x USB 2.0, 1x iDRAC USB(Micro USB) port • Rear: 2x USB 3.0_Gen1 port • Internal: 1 x USB 3.0 port
Rack Height	2U	2U
Power Supplies	<ul style="list-style-type: none"> • 495 W AC Platinum • 1600 W AC Platinum • 750 W Mix Mode Platinum • 750 W AC Titanium • 1100 W Mix Mode Platinum 	<ul style="list-style-type: none"> • 495 W AC Platinum • 1600 W AC Platinum • 750 W AC Mix Mode Platinum • 1100 W AC Mix Mode Platinum
System Management	<ul style="list-style-type: none"> • Lifecycle Controller 3.x • OpenManage • Quick Sync2.0 • OMPC3 • Digital License Key • iDRAC Direct (dedicated micro-USB port) • Easy Restore 	<ul style="list-style-type: none"> • Lifecycle Controller 3.x • OpenManage • Quick Sync2.0 • OMPC3 • Digital License Key • iDRAC Direct (dedicated micro-USB port) • Easy Restore • vFlash

Table 2. Product comparison (continued)

Feature	PowerEdge R7515	PowerEdge R7415
Internal GPU	Up to 4x 75W or 1x 225W	None
Availability	<ul style="list-style-type: none">• Hot-plug drives• Hot-plug redundant power supplies• BOSS• IDSDM	<ul style="list-style-type: none">• Hot-plug drives• Hot-plug redundant power supplies• BOSS• IDSDM

Chassis views and features

Topics:

- Front view of the system
- Rear view of the system
- Inside the system
- [Quick Resource Locator for PowerEdge R7515 system](#)

Front view of the system

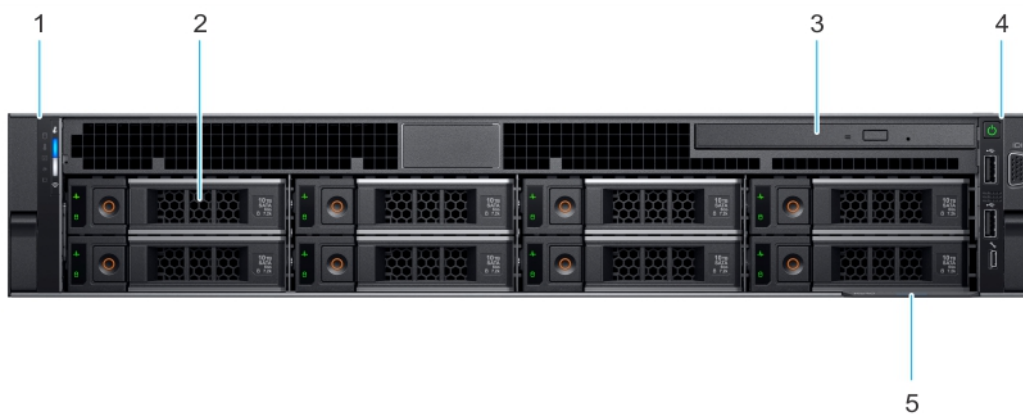

Figure 1. Front view of the 8 x 3.5-inch drive system

- | | |
|-----------------------|------------------------|
| 1. Left control panel | 2. Drive (8) |
| 3. Optical drive slot | 4. Right control panel |
| 5. Information tag | |



Figure 2. Front view of the 12 x 3.5-inch drive system

- | | |
|------------------------|--------------------|
| 1. Left control panel | 2. Drive (12) |
| 3. Right control panel | 4. Information tag |



Figure 3. Front view of the 24 x 2.5-inch drive system

- | | |
|------------------------|--------------------|
| 1. Left control panel | 2. Drive (24) |
| 3. Right control panel | 4. Information tag |

Rear view of the system

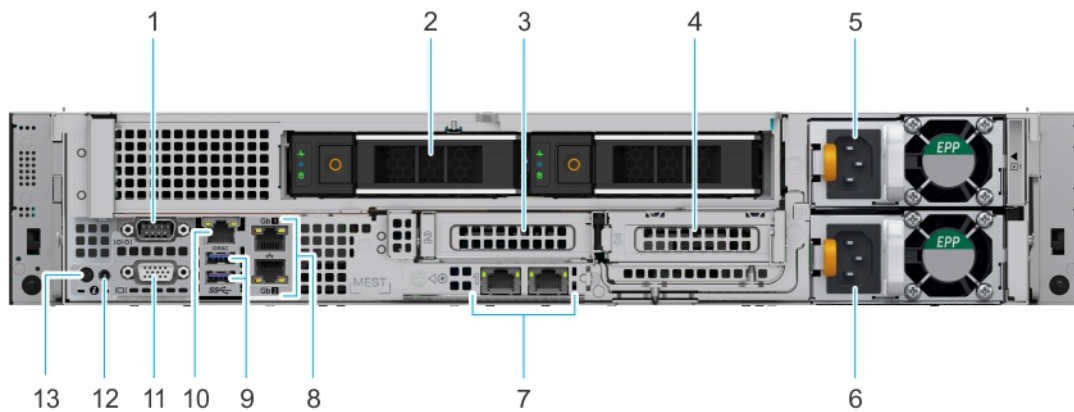

Figure 4. Rear view of the system with two rear drives

- | | |
|--|--|
| 1. Serial port | 2. Drive |
| 3. PCIe expansion card riser 1A (slot 2) | 4. PCIe expansion card riser 2 (slot 3) |
| 5. Power supply unit 1 (PSU) | 6. Power supply unit 2 (PSU) |
| 7. LOM Riser Ethernet port (2) (Optional) (slot 1) | 8. Ethernet port (2) |
| 9. USB 3.0 port (2) | 10. iDRAC dedicated port |
| | i NOTE: Enables you to remotely access iDRAC. |
| 11. VGA port | 12. System status indicator cable port (CMA) |
| 13. System identification button | |

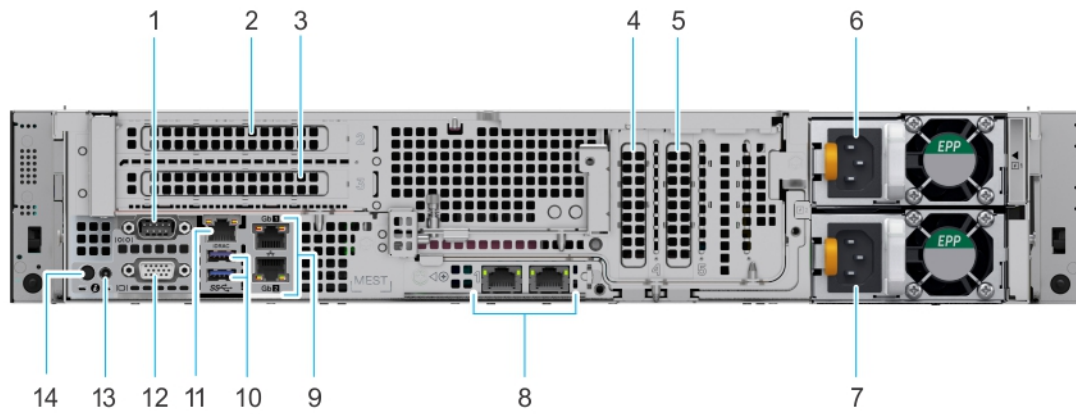

Figure 5. Rear view of the system with no rear drives

- | | |
|--|--|
| 1. Serial port | 2. PCIe expansion card riser 1B (slot 2) |
| 3. PCIe expansion card riser 1B (slot 3) | 4. PCIe slot 4 |
| 5. PCIe slot 5 | 6. Power supply unit 1 (PSU) |
| 7. Power supply unit 2 (PSU) | 8. LOM riser ethernet port (2) (optional slot 1) |
| 9. Ethernet ports (2) | 10. USB 3.0 port (2) |
| 11. iDRAC9 dedicated port | 12. VGA port |
| 13. System status indicator cable port (CMA) | 14. System identification button |

Inside the system

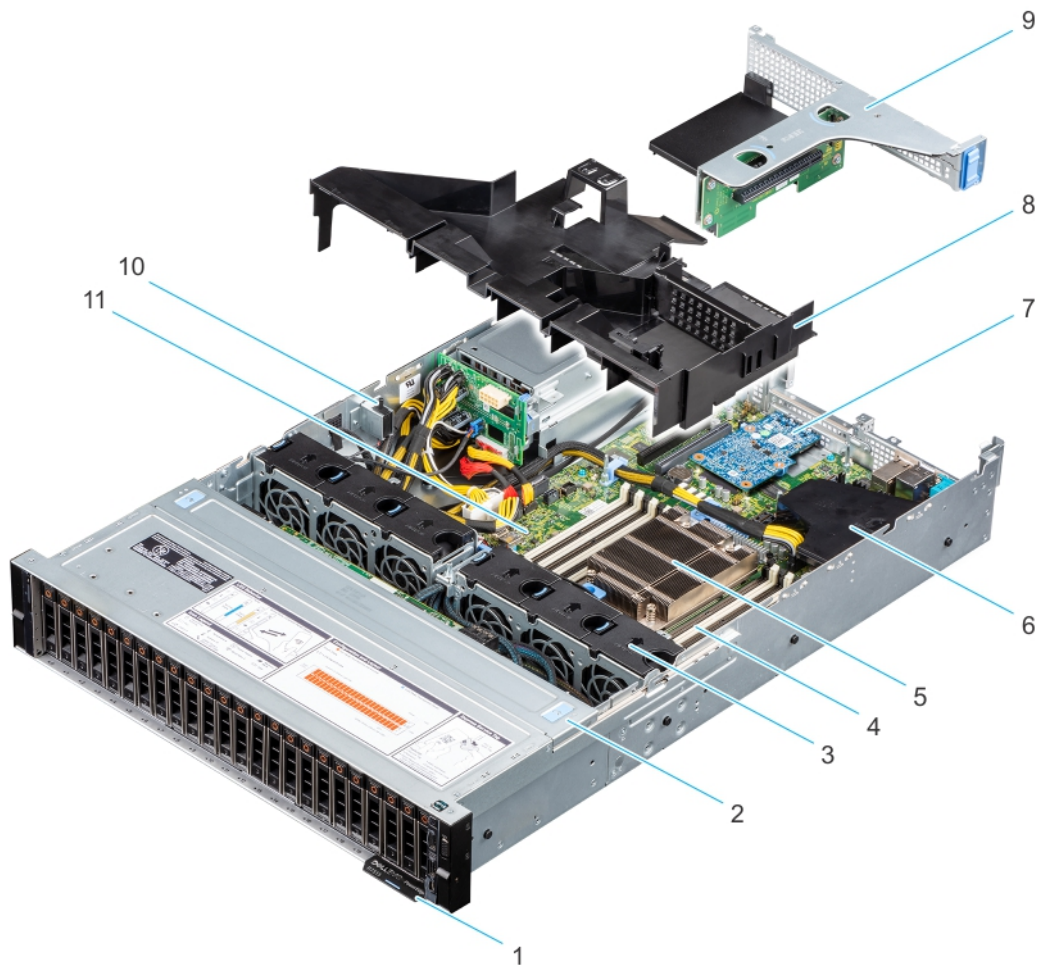

Figure 6. Inside the system

- 1. Information tag
- 2. Drive backplane cover
- 3. Fan (6)
- 4. Memory module sockets
- 5. Heat sink
- 6. Internal PERC mini card and air shroud
- 7. LOM riser card
- 8. Air shroud
- 9. Riser 1B
- 10. Intrusion switch
- 11. System board

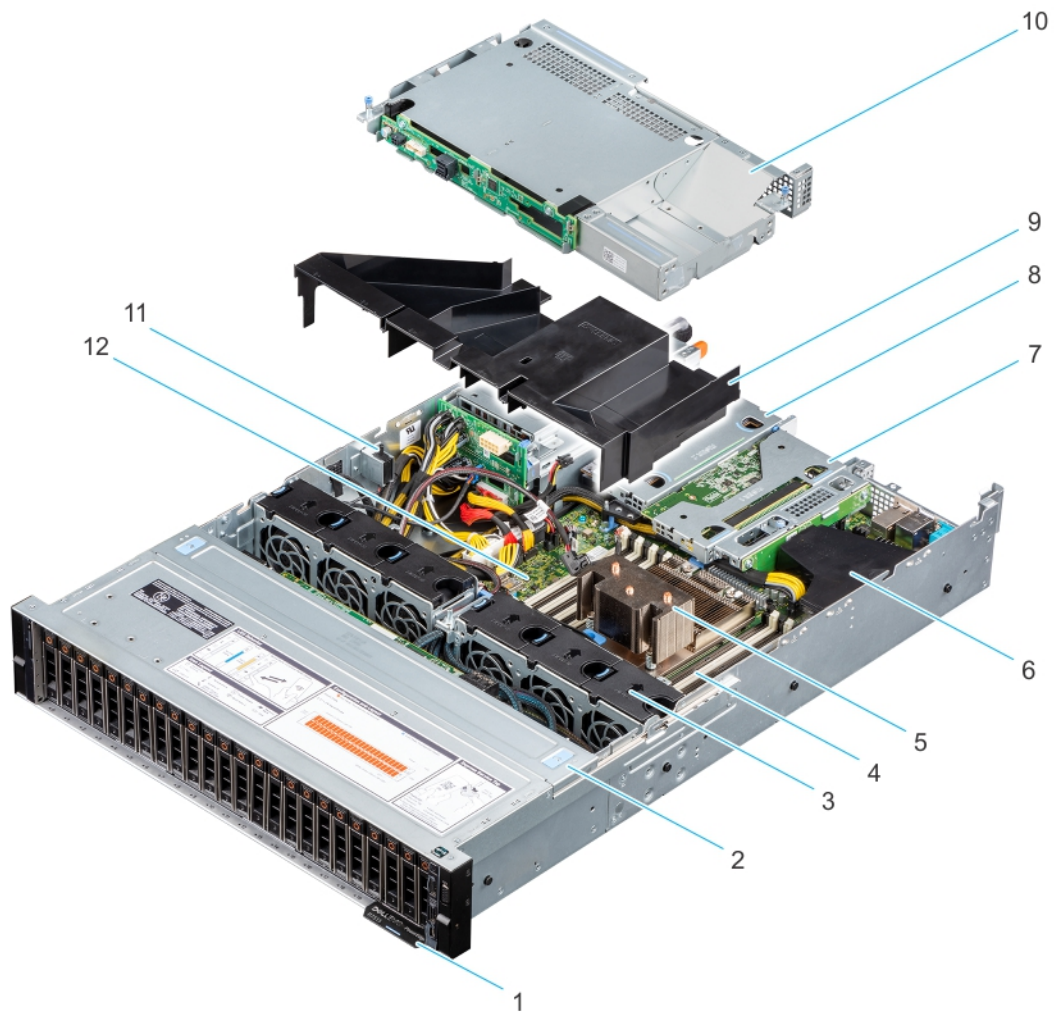

Figure 7. Inside the system with rear drive configuration

1. Information tag
2. Drive backplane cover
3. Fan (6)
4. Memory module sockets
5. Heat sink
6. Internal PERC mini card and air shroud
7. Riser 1A (Low profile right riser)
8. Riser 2 (Low profile left riser)
9. Air shroud
10. Rear drive cage
11. Intrusion switch
12. System board

Quick Resource Locator for PowerEdge R7515 system



Figure 8. Quick Resource Locator for PowerEdge R7515 system

Processor



The AMD EPYC Generation 2 and Generation 3 processors have several SKUs ranging from 16 cores and up to 64 cores to support workloads for data warehouses, e-commerce, high-performance computing, and storage for data centers.

Topics:

- [Processor features](#)
- [Supported processors](#)

Processor features

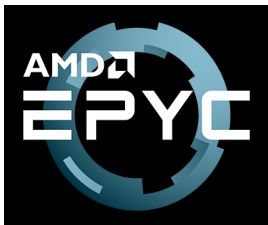

The key features of the 2nd and 3rd Generation AMD EPYC, are as follows:

- A highly scalable, 64-core System on Chip (SoC) design, with support for two high-performance thread per core
- Industry-leading memory bandwidth, with 8-channels of memory per device. In a 2-socket server, support for up to 32 DIMMS of DDR4 on 16 memory channels, delivering up to 4 TB of total memory capacity
- The processor is a complete SoC with fully integrated, high-speed I/O supporting 128 lanes of PCIe® Gen3 and Gen4, negating the need for a separate chipset
- A highly optimized cache structure for high-performance, energy-efficient compute
- AMD Infinity Fabric coherent interconnect for two processors in a 2-socket system
- Dedicated security hardware

Supported processors

The following table lists the AMD 2nd and 3rd Generation EPYC processors supported by the PowerEdge R7515. For the latest information on supported processors, visit [Dell.com/PowerEdge](https://www.dell.com/poweredge).

Table 3. Supported processors for the PowerEdge R7515

Processor	Frequency (GHz)	Cores/Threads	Cache (MB)	Max Memory Speed (MT/s)	Turbo	TDP (W)
7773X	3.50	64/128	768	3200	Yes	280
7573X	3.60	32/64	768	3200	Yes	280
7473X	3.70	24/48	768	3200	Yes	240
7373X	3.80	16/32	768	3200	Yes	240
7713P	2.0	64/128	256	3200	Yes	225
7513	2.6	32/64	128	3200	Yes	200

Table 3. Supported processors for the PowerEdge R7515 (continued)

Processor	Frequency (GHz)	Cores/Threads	Cache (MB)	Max Memory Speed (MT/s)	Turbo	TDP (W)
7543P	2.8	32/64	256	3200	Yes	225
7443P	2.85	24/48	128	3200	Yes	200
7313P	3.0	16/32	128	3200	Yes	155
7413	2.65	24/48	128	3200	Yes	180
75F3	2.95	32/64	256	3200	Yes	280
7763	2.5-2.6	64/128	256	3200	Yes	225-280
7742	2.25	64/128	256	3200	Yes	225
7702P	2	64/128	256	3200	Yes	200
7662	2	64/128	256	3200	Yes	225
7642	2.3	48/96	256	3200	Yes	225
7552	2.2	48/96	192	3200	Yes	200
7542	2.9	32/64	128	3200	Yes	225
7532	2.4	32/64	256	3200	Yes	200
7502P	2.5	32/64	128	3200	Yes	180
7452	2.35	32/64	128	3200	Yes	155
7402P	2.8	24/48	128	3200	Yes	180
7352	2.3	24/48	128	3200	Yes	155
7302P	3	16/32	128	3200	Yes	155
7282	2.8	16/32	64	3200	Yes	120
7272	2.9	12/24	64	3200	Yes	120
7262	3.2	8/16	128	3200	Yes	155
7232P	3.1	8/16	32	3200	Yes	120
7H12	2.6	64/128	256	3200	Yes	280
7F72	3.2	24/48	192	3200	Yes	240
7F52	3.5	16/32	256	3200	Yes	240
7F32	3.7	8/16	128	3200	Yes	180

Memory

The PowerEdge R7515 system supports up to 16 DIMMS, 2 TB of memory, and speeds up to 3200 MT/s

The 2nd and 3rd Generation AMD EPYC processors contain eight 64-bit (64 DATA bits plus 8 CHECK bits) DDR4 SDRAM memory controllers operating in ungangled mode. The system memory is organized into eight channels per processor (two memory sockets per channel) for a total of 16 memory sockets per processor. The memory channels are organized as 4 channels per processor side, with memory channels A,B, C, and D on one side and memory channels E, F, G, and H on the other side.

Support registered (RDIMMs), load reduced DIMMs (LRDIMMs), and 3-Dimensional Stack DIMMs (3-DS DIMMs), use a buffer to reduce memory loading and provide greater density, allowing for the maximum platform memory capacity. Unbuffered DIMMs (UDIMMs) are not supported.

Topics:

- [Supported memory](#)
- [Memory speed](#)

Supported memory

Routing is connected with 2-RDIMM per channel. Therefore, back-to-front population of RDIMM is preferred. Quad-rank and octal-rank are supported for LRDIMMs.

The following table lists the memory technologies that are supported by the R7515 in comparison to the R7415:

Table 4. Memory technology comparison

Feature	R7515(DDR4)	R7415(DDR4)
DIMM type	RDIMM	RDIMM
	LRDIMM	LRDIMM
	3DS	N/A
Transfer speed	3200 MT/s	2667 MT/s
	2933 MT/s	2400 MT/s
	2666 MT/s	2133 MT/s
	N/A	1866 MT/s
Voltage	1.2 V	1.2 V

The following table shows the supported DIMMs for the PowerEdge R7515:

Table 5. Supported DIMMs

DIMM Speed (MT/s)	DIMM Type	DIMM Capacity (GB)	Ranks per DIMM	Data Width	DIMM Volts (V)	Minimum RAM (GB)	Maximum RAM (GB)
3200	RDIMM	8	1	8	1.2	8	128
3200	RDIMM	16	2	8	1.2	16	256
3200	RDIMM	32	2	4	1.2	32	512
3200	RDIMM	64	2	4	1.2	64	1 TB
2666	LRDIMM	128	8	4	1.2	128	2 TB

Memory speed

The table below lists the memory configuration and performance details for the PowerEdge R7515 based on the quantity and type of DIMMs per memory channel.

Table 6. DIMM performance details

DIMM type	DIMM ranking	Capacity	DIMM rated voltage, Speed	AMD	
				1DPC	2DPC
RDIMM	1R	8 GB	DDR4 (1.2 V), 3200 MT/s	3200 MT/s	2933 MT/s
	2R	16 GB, 32 GB, 64 GB	DDR4 (1.2 V), 3200 MT/s	3200 MT/s	2933 MT/s
LRDIMM	8R	128 GB	DDR4 (1.2 V), 2666 MT/s	2666 MT/s	2666 MT/s
	8R	128 GB	DDR4 (1.2 V), 3200 MT/s	3200 MT/s	2933 MT/s

NOTE: The older 32 GB capacity RDIMM memory with x4 data width and 8Gb DRAM density cannot be mixed with the newer 32 GB capacity RDIMM memory with x8 data width and 16Gb DRAM density in the same AMD EPYC™ processor unit.

NOTE: The older 128 GB capacity LRDIMM memory at 2666 MT/s speed cannot be mixed with the new 128 GB capacity LRDIMM memory at 3200 MT/s speed.

Storage

The PowerEdge R7515 supports the following drive configurations:

Table 7. Hard drive configurations

R7515 configuration details	Storage module	Rear storage module	Controllers
8 x 3.5 -inch, SAS or SATA only	8 x 3.5-inch	None	CPU Direct SATA, SWRAID SATA, Mini PERC (H330, H730P, H740P, HBA330)
24 x 2.5-inch, SAS	24 x 2.5-inch	None	Mini PERC (H730P, H740P, HBA330)
24 x 2.5-inch, 12 SAS + 12 Universal	24 x 2.5-inch	None	CPU direct NVMe; SWRAID NVMe, Mini PERC (H740P, HBA330)
12 x 3.5-inch, SAS	12 x 3.5-inch	None	Mini PERC (H730P, H740P, HBA330)
14 x 3.5-inch, 12 SAS (front) + 2 SAS (Back)	12 x 3.5-inch	Rear 2 x 3.5-inch	Mini PERC (H730P, H740P, HBA330)
24 x 2.5-inch, 8 Universal 16 NVMe only (2x16 PCIe uplinks)	24 x 2.4-inch NVMe	None	CPU direct NVMe; SWRAID NVMe, Mini PERC (H740P, HBA330)
24 x 2.5-inch, NVMe	24 x 2.5-inch NVMe	None	Not applicable

NOTE: SAS represents SAS/SATA capable backplane.

NOTE: Universal represents SAS/SATA/NVMe capable slots.

Topics:

- [Supported drives](#)
- [Storage controllers](#)
- [Optical drives](#)
- [External drives](#)

Supported drives

The following table list the internal drives supported by the PowerEdge R7515:

Table 8. Supported drives

Form Factor	Type	Speed	Rotational Speed	Capacities
2.5-inch	SATA SSD (M.2)	6Gb	N/A	120 GB, 240 GB
2.5-inch	SATA	6Gb	7.2K	1 TB, 2 TB
2.5-inch	SAS	12Gb	7.2K	1 TB, 2 TB, 4 TB, 6 TB, 8 TB, 10 TB, 2 TB SED and FIPS

Table 8. Supported drives (continued)

Form Factor	Type	Speed	Rotational Speed	Capacities
2.5-inch	SAS SSD	12Gb	N/A	400 GB, 800 GB, 960 GB, 1.6 TB, 1.92 TB, 3.2 TB, 3.84 TB, 1.92 TB SED and FIPS
2.5-inch	SATA SSD	12Gb	N/A	120 GB, 200 GB, 240 GB, 300 GB, 400 GB, 480 GB, 800 GB, 960 GB, 1.2 TB, 1.6 TB, 1.92 TB, 3.84 TB
2.5-inch	SAS	12Gb	10K	300 GB, 600 GB, 1.2 TB, 1.8 TB, 1.2 TB SED and FIPS, 2.4 TB, 2.4 TB SED and FIPS
2.5-inch	SAS	12Gb	15K	300 GB, 600 GB, 900 GB
3.5-inch	SATA	6Gb	7.2K	1 TB, 2 TB, 4 TB, 6 TB, 8 TB, 10 TB
3.5-inch	SAS	12Gb	7.2K	1 TB, 2 TB, 4 TB, 8 TB, 10 TB, 4 TB SED and FIPS, 8 TB SED and FIPS
2.5-inch	NVMe SSD (U.2)	Gen4	N/A	960 GB, 1.92 TB, 7.68 TB

The following table shows the supported NVMe SSDs for the PowerEdge R7515:

Table 9. Supported NVMe SSDs

Description
SSDR,1.6,NVMEPCIE,2.5,PM1725B
SSDR,6.4,NVMEPCIE,2.5,PM1725B
CRD,CTL,NVME,1.6,HHHL,PM1725B
SSDR,3.2,NVMEPCIE,2.5,PM1725B
SSDR,12.8,NVMEPCIE,2.5,PM1725B
CRD,CTL,NVME,3.2,HHHL,PM1725B
CRD,CTL,NVME,6.4,HHHL,PM1725B
SSDR,960GB,NVMEPCIE,2.5,CD5
SSDR,3.84TB,NVMEPCIE,2.5,CD5
SSDR,1.92TB,NVMEPCIE,2.5,CD5
SSDR,7.68TB,NVMEPCIE,2.5,CD5
SSDR,1TB,NVME,PCIE,2.5,P4510
SSDR,2TB,NVME,PCIE,2.5,P4510
SSDR,4TB,NVME,PCIE,2.5,P4510
SSDR,8TB,NVME,PCIE,2.5,P4510
SSDR,1.6TB,NVME,PCIE,2.5,P4610
SSDR,3.2TB,NVME,PCIE,2.5,P4610
SSDR,6.4TB,NVME,PCIE,2.5,P4610
SSDR,375GB,NVME,PCIE,2.5,P4800
SSDR,750GB,NVME,PCIE,2.5,P4800
CRD,CTL,PCIE,750GB,HHHL,P4800

Storage controllers

Dell EMC RAID controller options offer performance improvements, including the Mini PERC solution. The Mini PERC provides a base RAID hardware controller without consuming a PCIe slot by using a small form factor and a high density connector to the base planar.

The following table describes the supported storage controllers for the PowerEdge R7515:

Table 10. Supported storage controllers

Performance level	Controller description
Entry	<ul style="list-style-type: none"> ● S150 (SATA, NVMe) ● SW RAID SATA
Value	<ul style="list-style-type: none"> ● HBA330 (internal), 12 Gbps SAS HBA (external) <ul style="list-style-type: none"> ○ Fury IOC ○ Memory: None ○ x8 12 Gb SAS ○ x8 PCIe Gen3 and Gen4 ● H330, 12 Gbps SAS HBA (external) <ul style="list-style-type: none"> ○ Fury IOC ○ Memory: None ○ x8 12 Gb SAS ○ x8 PCIe Gen3 and Gen4 ● HBA355e (external) <ul style="list-style-type: none"> ○ x8 PCIe Gen4
Value performance	<ul style="list-style-type: none"> ● H730P <ul style="list-style-type: none"> ○ Invader ROC ○ Memory: 2 GB, NV 72-bit, 866 MHz ○ x8 12 Gb SAS ○ x8 PCIe Gen3 and Gen4
Premium performance	<ul style="list-style-type: none"> ● H740P, H840(UI) <ul style="list-style-type: none"> ○ Harpoon 8x8 ROC ○ Memory: 4/8 GB, NV 72-bit

Optical drives

The PowerEdge R7515 supports the following internal optical drive options:

- DVD-ROM, 9.5 mm, SATA, HLDS (internal)
- DVDRW, 9.5 mm, SATA, HLDS (internal)
- DVD-ROM, 9.5 mm, SATA, PLDS (internal)
- DVDRW, 9.5 mm, SATA, PLDS (internal)
- DVD-ROM, USB, HLDS, (external storage)

External drives

The following table lists the supported external storage for the PowerEdge R7515:

Table 11. Supported external storage

Device Type	Description
External Tape	Connection to external USB tape products
NAS/IDM appliance software	NAS software stack

Table 11. Supported external storage (continued)

Device Type	Description
JBOD	Connection to 12 Gb MD-series JBODs

Networking and PCIe

The PowerEdge R7515 system supports up to two 10/100/1000 Mbps Network Interface Controller (NIC) ports that are located on the back panel. The system also supports LAN on Motherboard (LOM) on an optional riser card.

You can install one LOM riser card. The supported LOM riser options are:

- 2 x 1 Gb Base-T
- 2 x 10 Gb Base-T
- 2 x 10 Gb SFP+
- 2 x 25 Gb SFP+

i NOTE:

- You can install up to four PCIe add-on NIC cards.
- For information about Linux network performance settings, see the *Linux Network Tuning Guide for AMD EPYC Processor Based Servers* white paper at [AMD.com](https://www.amd.com/en/whitepapers/linux-network-tuning-guide-for-amd-epyc-processor-based-servers)

Topics:

- [Expansion card installation guidelines](#)

Expansion card installation guidelines

The following table describes the supported expansion cards:

Table 12. Expansion card riser configurations

Expansion card riser	PCIe slots on the riser	Processor connection	Height	Length	Slot width
Riser-1B (2U riser)	Slot 2	Processor 1	Full Height	Full Length	x16
Riser-1B (2U riser)	Slot 3	Processor 1	Full Height	Full Length	x16
Riser-1A (low profile riser right)	Slot 2	Processor 1	Low Profile	Half Length	x16
Riser-2 (low profile riser left)	Slot 3	Processor 1	Low Profile	Half Length	x16

i NOTE: The expansion-card slots are not hot-swappable.

The following table provides guidelines for installing expansion cards to ensure proper cooling and mechanical fit. The expansion cards with the highest priority should be installed first using the slot priority indicated. All the other expansion cards should be installed in the card priority and slot priority order.

Table 13. Riser configurations: No riser – CPU

Card Type	Slot Priority	Maximum number of cards
LOM riser ; 2x1G BCM5720L (FXN)	1	1
LOM riser ; 2x10G BCM57416 (BASeT/ SFP+) (FXN)	1	1
LOM riser ; 2x25G (Broadcom)	1	1
GPU: Nvidia A2 16GB (LP)	5	1
GPU: Nvidia T4 16GB	5, 4	2

Table 13. Riser configurations: No riser – CPU (continued)

Card Type	Slot Priority	Maximum number of cards
NVMe PCIe SSD	5, 4	2
Mellanox 100G (CX5/CX6 H100)	4, 5	2
Mellanox 25G (CX4LX DP/CX5 DP)	5, 4	2
Emulex (FC32 SP/DP)	4, 5	2
Emulex (FC16 SP/DP)	5, 4	2
Emulex (HBA FC64 LP 2P S28)	4, 5	2
Emulex (HBA FC32 1P S28)	5, 4	2
Qlogic (HBA FC32 SP/DP)	4, 5	2
Qlogic (HBA FC16 SP/DP)	5, 4	2
Qlogic 10G (SFP DP)	5, 4	2
Qlogic 25G (BaseT DP)	5, 4	2
Qlogic (HBA FC32 1P S28)	4, 5	2
Solarflare 25G (SFP DP)	5, 4	2
Intel 10G (BaseT DP)	5, 4	2
Intel 10G (SFP+ DP)	5, 4	2
Intel 1G (QP)	5, 4	2
Intel 25G SFP DP	5, 4	2
Intel 25G LP 2P S28	5, 4	2
Broadcom 1G (QP)	5, 4	2
Broadcom 10G (BaseT DP)	5, 4	2
Broadcom 25G (SFP DP)	5, 4	2
PERC 10: External adapter (Dell)	4, 5	1
HBA: External adapter (Dell)	4, 5	1
Internal storage (BOSS)	5, 4	1
PERC 9: Mini mono (H730P/H330)	Integrated slot	1
PERC 10 : Mini mono (H740P)	Integrated slot	1
PERC 11: Mini mono (H350)	Integrated slot	1
HBA :Mini mono (HBA330/HBA350i)	Integrated slot	1
PERC 10: External adapter (H840)	5, 4	2
PERC 10: External adapter (H840) (FH or LP)	5, 4	2
PERC 11: External adapter (HBA355E)	5, 4	2
HBA: External adapter	5, 4	2
LOM riser (2x1G)/(2x10G)/(2x25G)	1	1
Intel, NIC: 100Gb, CRD,NTWK,INTL,LP,100G,2P,Q28	4,5	2
Emulex, HBA: FC32, CRD,CTL,FC32,2P,LPE35002,EMX,L	4,5	2

Table 13. Riser configurations: No riser – CPU (continued)

Card Type	Slot Priority	Maximum number of cards
Broadcom, NIC: 10Gb, CRD,NTWK,BCME,LP,10G,4P,BT	5,4	2
HBA: External Adapter, KIT,CRD,CTL,HBA,12GBPS-SAS	5,4	2

Table 14. Riser configurations: Riser 1A + Riser 2 – CPU

Card type	Slot priority	Maximum number of cards
LOM riser ; 2x1G BCM5720L	1	1
LOM riser ; 2x10G BCM57416 (BAsE t/ SFP+)	1	1
LOM riser ; 2x25G (Broadcom)	1	1
NVMe PCIe SSD	2, 3	2
Mellanox 100G (CX5/CX6 H100)	3, 2	2
Mellanox 25G (CX4LX DP/CX5 DP)	2, 3	2
Emulex (FC32 SP/DP)	3, 2	2
Emulex (FC16 SP/DP)	2, 3	2
Emulex (HBA FC64 LP 2P S28)	3, 2	2
Emulex (HBA FC32 FH 1P S28)	2, 3	2
Qlogic (HBA FC32 SP/DP)	3, 2	2
Qlogic (HBA FC16 SP/DP)	2, 3	2
Qlogic 10G (SFP DP)	2, 3	2
Qlogic 25G (BaseT DP)	2, 3	2
Qlogic (HBA FC32 FH 1P S28)	3, 2	2
Solarflare 25G (SFP DP)	2, 3	2
Intel 10G (BaseT DP)	2, 3	2
Intel 10G (SFP+ DP)	2, 3	2
Intel 1G (QP)	2, 3	2
Intel 25G SFP DP	2, 3	2
Broadcom 1G (QP)	2, 3	2
Broadcom 10G (BaseT DP)	2, 3	2
Broadcom 25G (SFP DP)	2, 3	2
PERC 10: External adapter (Dell)	2, 3	1
HBA: External adapter (Dell)	2, 3	1
Internal storage (BOSS)	2, 3	1
PERC 9: Mini mono (H730P/H330)	Integrated slot	1
PERC 10: Mini mono (H740P)	Integrated slot	1
PERC 11: Mini mono (H350)	Integrated slot	1
HBA :Mini mono (HBA330/HBA350i)	Integrated slot	1
PERC 10: External adapter (H840)	2, 3	2

Table 14. Riser configurations: Riser 1A + Riser 2 – CPU (continued)

Card type	Slot priority	Maximum number of cards
PERC 10: External adapter (H840) (FH or LP)	2, 3	2
PERC 11: External adapter (HBA355E)	2, 3	2
HBA: External adapter	2, 3	2
Intel,NIC: 100Gb, CRD,NTWK,INTL,LP,100G,2P,Q28	3,2	2
Intel NIC: 25Gb,CRD,NTWK,INTL,FH,25G,2P,S28,F1	2, 3	2
Emulex, HBA: FC32, CRD,CTL,FC32,2P,LPE35002,EMX,L	3,2	2
Broadcom, NIC: 10Gb, CRD,NTWK,BCME,LP,10G,4P,BT	3,2	2
HBA: External Adapter, KIT,CRD,CTL,HBA,12GBPS-SAS	3,2	2

Table 15. Riser configurations: Riser 1B – CPU

Card type	Slot priority	Maximum number of cards
LOM riser ; 2x1G BCM5720L	1	1
LOM riser ; 2x10G BCM57416 (BASeT/ SFP+)	1	1
LOM riser ; 2x25G (Broadcom)	1	1
FPGA: XILINX FH	3	1
GPU: AMD MI210 64GB 300W (FH)	3	1
GPU: Nvidia A30 24GB V2 (FH)	3	1
GPU: Nvidia A2 16GB V2 (FH)	2, 3	2
GPU: Nvidia A2 16GB V2 (LP)	5	1
GPU: Nvidia A16 64GB V2 (FH)	3	1
GPU: Nvidia V100S 32GB (FH)	3	1
GPU: Nvidia T4 16GB 70W V2 (FH)	2, 3	2
GPU: Nvidia T4 16GB 70W (LP)	5, 4	2
Intel 10G (BaseT DP FH)	2, 3	2
Intel 10G (BaseT DP LP)	5, 4	2
Intel 10G (SFP+ DP FH)	2, 3	2
Intel 10G (SFP+ DP LP)	5, 4	2
Intel 1G (QP FH)	2, 3	2
Intel 1G (QP LP)	5, 4	2
Intel 25G (SFP DP FH)	2, 3	2
Intel 25G (SFP DP LP)	5, 4	2
Broadcom 1G (QP FH)	2, 3	2
Broadcom 1G (QP LP)	5, 4	2

Table 15. Riser configurations: Riser 1B – CPU (continued)

Card type	Slot priority	Maximum number of cards
Broadcom 10G (BaseT DP FH)	2, 3	2
Broadcom 10G (BaseT DP LP)	5, 4	2
Broadcom 25G (SFP DP FH)	2, 3	2
Broadcom 25G (SFP DP LP)	5, 4	2
Solarflare 25G (SFP DP FH)	2, 3	2
Solarflare 25G (SFP DP LP)	5, 4	2
Mellanox 25G (CX4LX DP/CX5 DP FH)	2, 3	2
Mellanox 25G (CX4LX DP/CX5 DP LP)	5, 4	2
Qlogic 10G (SFP DP FH)	2, 3	2
Qlogic 10G (SFP DP LP)	5, 4	2
Qlogic 25G (BaseT DP FH)	2, 3	2
Qlogic 25G (BaseT DP LP)	5, 4	2
Mellanox 100G (CX5/CX6 H100, FH)	3, 2	2
Mellanox 100G (CX5/CX6 H100, LP)	4, 5	2
Emulex (FC32 SP/DP, FH)	3, 2	2
Emulex (FC32 SP/DP, LP)	4, 5	2
Emulex (FC16 SP/DP, FH)	2, 3	2
Emulex (FC16 SP/DP, LP)	5, 4	2
Emulex (HBA FC64 FH 2P S28)	3, 2	2
Emulex (HBA FC64 LP 2P S28)	4, 5	2
Emulex (HBA FC32 1P S28, FH)	2, 3	2
Emulex (HBA FC32 1P S28, LP)	5, 4	2
Qlogic (HBA FC32 SP/DP, FH)	3, 2	2
Qlogic (HBA FC32 SP/DP, LP)	4, 5	2
Qlogic (HBA FC16 SP/DP, FH)	2, 3	2
Qlogic (HBA FC16 SP/DP, LP)	5, 4	2
Qlogic (HBA FC32 1P S28, FH)	3, 2	2
Qlogic (HBA FC32 1P S28, LP)	4, 5	2
PERC 10 : External adapter (H840, FH)	2, 3	2
PERC 11: External adapter (HBA355E)	2, 5, 3, 4	2
HBA : External adapter (FH)	2, 3	2
Internal storage (BOSS, FH)	2, 3	1
NVME PCIE SSD (FH)	2, 3	2
NVME PCIE SSD (LP)	5, 4	2
PERC 10 : External adapter (H840, LP)	5, 4	2
PERC 10: External adapter (H840) (FH or LP)	2, 5, 3, 4	4
HBA : External adapter (LP)	5, 4	2

Table 15. Riser configurations: Riser 1B – CPU (continued)

Card type	Slot priority	Maximum number of cards
Internal storage (BOSS, LP)	5, 4	1
PERC 9 : Mini mono (H730P/H330)	Integrated slot	1
PERC 10 : Mini mono (H740P)	Integrated slot	1
PERC 11: Mini mono (H350)	Integrated slot	1
HBA :Mini mono (HBA330/HBA350i)	Integrated slot	1
LOM riser (2x1G)/(2x10G)/(2x25G)	1	1
Intel, NIC: 100Gb, CRD,NTWK,INTL,FH,100G,2P,Q28	3,2	2
Intel, NIC: 100Gb, CRD,NTWK,INTL,LP,100G,2P,Q28	4,5	2
Intel, NIC: 25Gb, CRD,NTWK,INTL,FH,25G,4P,S28	3,2	2
Intel, NIC: 25Gb, CRD,NTWK,INTL,FH,25G,2P,S28	2, 3	2
Intel, NIC: 25Gb, CRD,NTWK,INTL,LP,25G,2P,S28	5, 4	2
NIC: 25Gb, Broadcom, CRD,NTWK,BCME,FH,25G,4P,S28	3,2	2
Emulex, HBA: FC32, CRD,CTL,FC32,2P,LPE35002,EMLX	3,2	2
Emulex, HBA: FC32, CRD,CTL,FC32,2P,LPE35002,EMX,L	4,5	2
Broadcom, NIC: 10Gb, CRD,NTWK,BCME,FH,10G,4P,BT	2,3	2
Broadcom, NIC: 10Gb, CRD,NTWK,BCME,LP,10G,4P,BT	5,4	2
HBA: External Adapter, KIT,CRD,CTL,HBA,12GBPS-SAS	2,5,3,4	4

Power, thermal, and acoustics

Topics:

- Power
- Thermal
- Acoustics

Power

The PowerEdge R7515 system has an extensive collection of sensors that automatically track thermal activity, and helps to regulate temperature and reduce server noise and power consumption.

Table 16. Power tools and technologies

Feature	Description
PSU portfolio	Dell EMC's PSU portfolio includes intelligent features such as dynamically optimizing power usage while maintaining availability and redundancy.
Tools for right sizing	Energy Smart Solution Advisor (ESSA) is a tool that can help determine the most efficient hardware configuration possible. ESSA can calculate the power consumption of hardware, power infrastructure, and storage. ESSA can help determine exactly how much power a server will use at a given workload. The PSU Advisor can help choose the best and most efficient PSU for workloads. See Dell.com/calc . Energy Smart Data Center Assessment is a Dell Services offering that uses infrastructure and thermal analysis to help maximize system efficiency. See Dell.com/EnergySmart .
Industry compliance	Dell EMC's servers are compliant with all relevant industry certifications and guidelines, including 80 PLUS, Climate Savers, and ENERGY STAR.
Power monitoring accuracy	PSU power monitoring improvements include: <ul style="list-style-type: none"> • Power monitoring accuracy of 1%, lower than the industry standard of 5% • Higher power reporting accuracy • Better performance under a power cap
Power capping	Use Dell EMC systems management software to set your system power cap to limit the output of a PSU and reduce system power consumption.
Systems management	iDRAC Enterprise provides server level management that monitors, reports, and controls power consumption at the processor, memory, and system level. Dell OpenManage Power Center delivers group power management at the rack, row, and data center level for servers, power distribution units, and uninterruptible power supplies.
Active power management	Node Manager is an embedded technology that provides individual server- level power reporting and power limiting functionality. Hot spare technology reduces consumption of redundant power supplies.
Fresh air cooling	See dell.com/fresh-air-cooling
Rack infrastructure	Dell EMC offers some of the industry's highest efficiency power infrastructure solutions, including: <ul style="list-style-type: none"> • Power distribution units (PDUs) • Uninterruptible power supplies (UPSs) • Energy Smart containment rack enclosures

Table 16. Power tools and technologies (continued)

Feature	Description
	For additional information see: http://content.dell.com/us/en/enterprise/power-and-cooling-technologies-components-rack-infrastructure.aspx .

Thermal

The thermal design of the PowerEdge R7515 reflects the following:

- Optimized thermal design: architecture built into the system layout.
- System component placement and layout are designed to provide maximum airflow coverage to critical components with minimum expense of fan power.
- Comprehensive thermal management achieved by regulating the fan speed based on several different responses from all system component temperature sensors, as well as inventory for system configurations. Temperature monitoring includes components such as processors, DIMMs, chipset, the inlet air ambient, hard disk drives, and LOM riser.
- Open and closed loop thermal fan control uses system configuration to determine fan speed based on inlet air ambient temperature. Closed loop thermal control method uses feedback temperatures to dynamically determine proper fan speeds.
- User-configurable settings in the iDRAC9 BIOS setup screen.

Cooling N+1 fan redundancy allows continuous operation with one fan failure in the system.

Acoustics

The acoustical design of the PowerEdge R7515 reflects the following:

- Versatility—The PowerEdge R7515 has a reduced power draw in the data center. It is also quiet enough for office environment in typical and minimum configurations.
- High sound quality standards—Sound quality is different from sound power level and sound pressure level in that it describes how humans respond to sound annoyance such as whistles and hums. One of the sound quality metrics in the Dell specifications is the prominence ratio of a tone.
- Noise ramp and descent at boot from power-off—Fan speeds and noise levels ramp during the boot process (from power off to power on) to add a layer of protection to component cooling in when the system is not able to boot properly. To keep the boot process as quiet as possible, the fan speed reached during boot is limited to about half of full speed.
- Noise level dependencies—If acoustics are important to you, then you should consider several configuration choices and settings:
 - For lower acoustical output, use a few lower rotational speed SATA hard drives, nearline SAS hard drives, or non-rotational devices such as SSDs. 15 k hard drives generate more acoustic noise than lower rotational speed hard drives. Also, noise increases with number of hard drives.
 - Fan speeds and noise may increase from baseline factory configurations when certain profiles are changed by the user, or system configurations are updated. The following is a list of items that impact fan speeds and acoustical output:
 - iDRAC9 BIOS settings—Performance Per Watt, DAPC or operating system, may be quieter than Performance or Dense Configuration (**iDRAC Settings > Thermal > Max. Exhaust Temperature or Fan speed offset**).
 - The quantity and type of PCIe cards installed—This affects overall system acoustics. Installation of more than two PCIe cards results in an increase in overall system acoustics.
 - Using a GPU card—GPU card results in an increase in overall system acoustics.
 - PCIe controller-based SSD drives—Drives such as express flash drives and Fusion IO cards require greater airflow for cooling, and result in higher noise levels
 - Systems with an H330 PERC—This configuration may be quieter than configurations with an H740P PERC with battery backup. However, higher noise levels result when a system is configured as non-RAID.
 - Hot spare feature of power supply unit—In the system default setting, the hot spare feature is disabled. Acoustical output from the power supplies is lowest in this setting.

Supported operating systems

The PowerEdge R7515 supports the following operating systems:

- Canonical Ubuntu Server LTS
- Citrix Xen Hypervisor
- Microsoft Windows Server with Hyper-V
- Red Hat Enterprise Linux
- SUSE Linux Enterprise Server
- VMware vSAN/ESXi

For more information, see www.dell.com/ossupport.

Dell EMC OpenManage systems management

Whether your IT environment consists of a few servers or a few thousand servers, Dell EMC OpenManage systems management solutions provide comprehensive management features for evolving IT environments. OpenManage is based on open standards, and provides both agent-based and agent-free server life-cycle management functionality for Dell EMC PowerEdge servers. OpenManage solutions help you automate and streamline essential hardware management tasks.

Start with a firm foundation for efficient hardware management using OpenManage tools, utilities, and management consoles. OpenManage systems management solutions consist of a combination of embedded management features and software products that help you automate and simplify the entire server life cycle: deploy, update, monitor, and maintain. OpenManage solutions are innovatively designed for simplicity and ease of use to help you reduce complexity, save time, achieve efficiency, control costs, and empower productivity. OpenManage centers on efficient management of server life cycle.

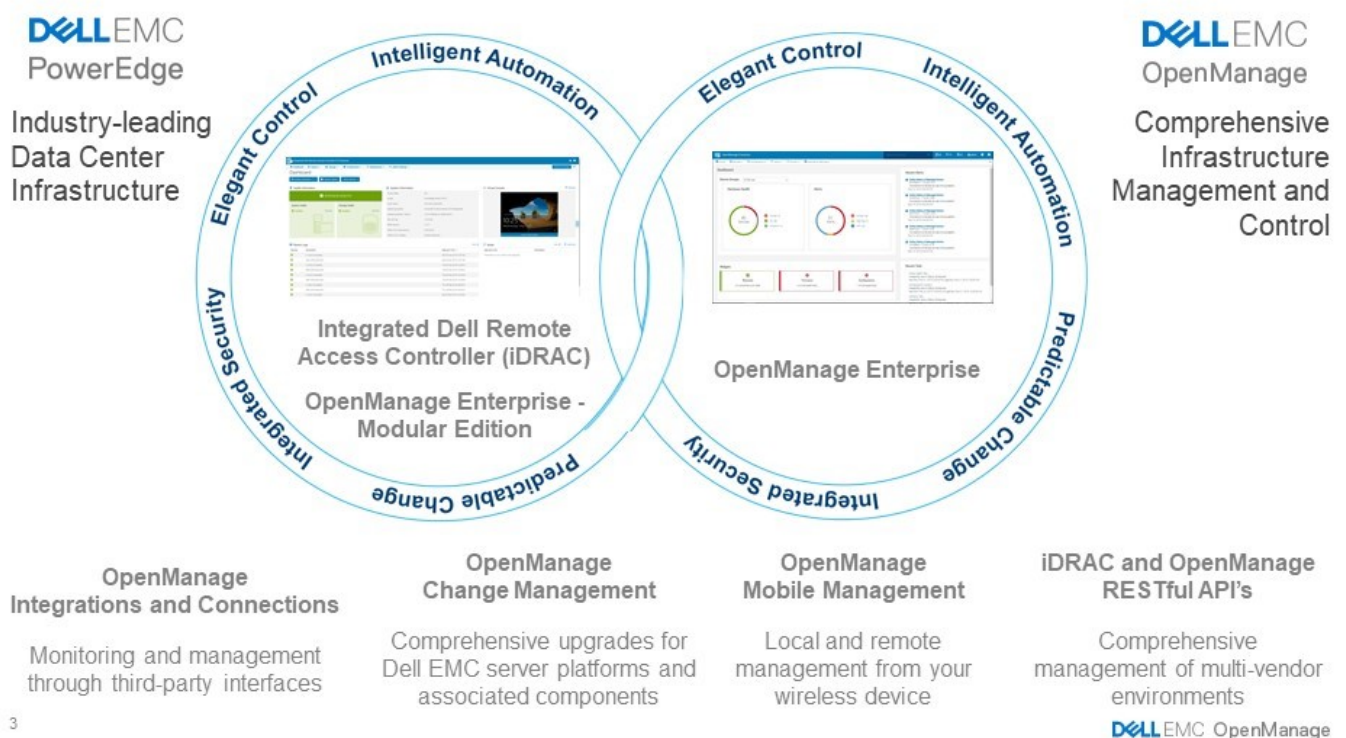

Figure 9. Server lifecycle management operations

Topics:

- iDRAC9 with Lifecycle Controller
- Agent-free management
- Agent-based management
- Dell EMC consoles
- Dell EMC OpenManage systems management tools, utilities, and protocols
- Integration with third-party consoles
- OpenManage connections with third-party consoles

iDRAC9 with Lifecycle Controller

The Integrated Dell Remote Access Controller 9 (iDRAC9) with Lifecycle Controller, the embedded intelligence of every Dell EMC PowerEdge new generation server, helps you manage Dell EMC servers agent-free or with a systems management agent, within physical, virtual, local, and remote environments. iDRAC9 alerts you of server issues, enables remote server management, and reduces the need to physically go to the server. iDRAC9 with Lifecycle Controller is part of Dell EMC comprehensive OpenManage portfolio and works as a stand-alone or with other components such as OpenManage Essentials, OpenManage Mobile, OpenManage Power Center, Chassis Management Controller, and OpenManage Integrations for Microsoft, VMware, and BMC consoles to simplify, automate, and streamline IT operations.

Dell EMC BMC and iDRAC9 feature comparison

iDRAC9 Enterprise is available for the system. Dell EMC also offers BMC. A detailed feature comparison for Dell EMC BMC and iDRAC9 Enterprise is shown in the following table.

Table 17. Feature comparison for Dell EMC BMC and iDRAC9 Enterprise

Feature	Dell EMC BMC	iDRAC9 Enterprise
Interfaces/Standards		
IPMI 2.0	Yes	Yes
DCMI 1.5	Yes	Yes
Web-based UI	Yes	Yes
Racadm command line (local and remote)	Yes	Yes
SMASH-CLP (SSH-only)	Yes	Yes
Telnet	Yes	Yes
SSH	Yes	Yes
WSMAN	Yes	Yes
RedFish API	Yes	Yes
Network Time Protocol	Yes	Yes
Connectivity		
Shared NIC	Yes	Yes
Dedicated NIC (with Ports card)	Yes	Yes
VLAN tagging	Yes	Yes
IPv4	Yes	Yes
IPv6	Yes	Yes
DHCP	Yes	Yes
Dynamic DNS	Yes	Yes
Operating system pass-through	Yes	Yes
Security		
Role-based authority	Yes	Yes
Local users	Yes	Yes
SSL encryption	Yes	Yes
IP blocking	Yes	Yes
Directory services (AD and LDAP)	No	Yes
Two-factor authentication	No	Yes

Table 17. Feature comparison for Dell EMC BMC and iDRAC9 Enterprise (continued)

Feature	Dell EMC BMC	iDRAC9 Enterprise
Single sign-on	No	Yes
PK authentication	Yes	Yes
New generation: Configuration Lockdown	No	Yes
New generation: System Erase of internal storage devices	Yes	Yes
Remote presence		
Power control	Yes	Yes
Boot control	Yes	Yes
Serial-over-LAN	Yes	Yes
Virtual media	Yes	Yes
Virtual folders	No	Yes
Remote file share	No	Yes
Virtual console	Yes for single user	Yes
VNC connection to operating system	No	Yes
Quality/bandwidth control	No	Yes
Virtual console collaboration (6 users)	No	Yes
Virtual console chat	No	Yes
Power and thermal		
Real-time power meter	Yes	Yes
Power thresholds and alerts	Yes	Yes
Real-time power graphing	Yes	Yes
Historical power counters	Yes	Yes
Power capping	Yes	Yes
Power Center integration	Yes	Yes
Temperature monitoring	Yes	Yes
Temperature graphing	Yes	Yes
Health monitoring		
Full agent-free monitoring	Yes	Yes
Predictive failure monitoring	Yes	Yes
SNMPv1, v2, and v3 traps and gets	Yes	Yes
Email Alerting	Yes	Yes
Configurable thresholds	Yes	Yes
Fan monitoring	Yes	Yes
Power supply monitoring	Yes	Yes
Memory monitoring	Yes	Yes
CPU monitoring	Yes	Yes
RAID monitoring for PERC	Yes	Yes

Table 17. Feature comparison for Dell EMC BMC and iDRAC9 Enterprise (continued)

Feature	Dell EMC BMC	iDRAC9 Enterprise
NIC monitoring	Yes	Yes
HD monitoring including JBOD enclosure	Yes	Yes
Out of band performance monitoring	No	Yes
Update		
Remote agent-free update	Yes	Yes
Embedded update tools	No	Yes
Sync with repository for scheduled updates	No	Yes
Autoupdate	No	Yes
Deployment and configuration		
Embedded operating deployment tools	No	Yes
Embedded configuration tools	No	Yes
AutoDiscovery	No	Yes
Remote operating system deployment for vMedia	No	Yes
Embedded driver pack	Yes	Yes
Full configuration inventory	Yes	Yes
Inventory export	Yes	Yes
Remote configuration	Yes	Yes
Zero touch configuration	No	Yes
System retire and repurpose	Yes	Yes
New generation: iDRAC Connection View	No	Yes
New generation: BIOS configuration page in iDRAC UI	Yes	Yes
Diagnostics, service, and logging		
Embedded diagnostic tools	Yes	Yes
Part replacement	No	Yes
Server configuration backup	Yes	Yes
Server configuration restore	Yes	Yes
Easy restore for system configuration, including USB and rSPI	Yes	Yes
Health LED only	Yes	Yes
New generation: Quick Sync 2.0	No	NA
New generation: iDRAC Direct 2.0 with micro USB port on rear	Yes	Yes
iDRAC Service Module (iSM)	Yes	Yes
Embedded Tech Support Report	Yes	Yes
Crash screen capture	No	Yes
Crash video capture, requires iSM or OMSA	No	Yes

Table 17. Feature comparison for Dell EMC BMC and iDRAC9 Enterprise (continued)

Feature	Dell EMC BMC	iDRAC9 Enterprise
Boot capture	No	Yes
Manual reset for iDRAC	Yes	Yes
Virtual NMI	Yes	Yes
Operating system watchdog (requires iSM or OMSA)	Yes	Yes
System event log	Yes	Yes
Lifecycle log	Yes	Yes
Work notes	Yes	Yes
Remote syslog	No	Yes
License management	Yes	Yes

Agent-free management

As Dell EMC PowerEdge servers have embedded server life-cycle management, often, there is no need to install an OpenManage systems management software agent into the operating system of a Dell EMC PowerEdge server. This greatly simplifies and streamlines the management footprint.

Agent-based management

Most systems management solutions require pieces of software, called agents, to be installed on each node to be managed within the IT environment. Also, the same agent is often used as a local interface into hardware health. It may be accessed remotely as a management interface, typically referred to as a one-to-one interface. For customers that continue to use agent-based solutions, Dell EMC provides OpenManage Server Administrator.

Dell EMC consoles

The central console in a systems management solution is often referred to as the one-to-many console. The central console provides a rapid view and insight into the overall health of all systems in the IT environment. The Dell EMC systems management portfolio includes several powerful consoles from which to choose depending on your requirements, including the following:

Dell EMC OpenManage Enterprise

Dell EMC OpenManage Enterprise is an intuitive infrastructure management console. Designed to take the complexity out of IT infrastructure management, it delivers better results with less time and fewer steps. OpenManage Enterprise helps IT professionals balance time and energy between complex IT infrastructure and business goals.

Simplify

- Robust, intuitive management capabilities regardless of form factor
- OpenManage Enterprise reduces learning time with a HTML5 UI that includes an elastic search engine. It goes to critical information and tasks easier and quicker. The automatable processes, templates, and policies can be created and edited using a simple menu-driven interface.

Unify

- One-to-many management from a single console—Built for scale
- OpenManage Enterprise supports up to 8,000 devices regardless of form factors. It supports Dell EMC PowerEdge racks, towers, and modular servers. It also monitors and creates alerts for third-party devices or PowerVault MD and ME Storage systems.

Automated

- Automated IT processes for greater efficiency

- From discovery to retirement, activities can be managed in the same console. In minutes, devices can be deployed automatically with templates based on service tags or node IDs.

Secure

- Designed for security throughout the infrastructure life cycle
- Security is always the top priority. To protect your infrastructure, OpenManage Enterprise detects drift from a user-defined configuration template, alerts users, and remediates misconfigurations based on presetup policies.

For more information, see the [Dell OpenManage Enterprise page](#).

OpenManage Mobile

OpenManage Mobile (OMM) is a software application that enables secure monitoring and management of PowerEdge servers remotely or at-the-server. With OpenManage Mobile, IT Administrators can securely perform several data center monitoring and remediation tasks using an Android or iOS mobile device. The OpenManage Mobile app is available as a free software download from the Apple Store and the Google Play Store.

OMM can also monitor and manage PowerEdge servers through an OpenManage Essentials console or by directly accessing the server's iDRAC.

The OpenManage Essentials console can be accessed through OpenManage Mobile over a secure IP network. This allows you to monitor all devices that are managed by OpenManage Essentials such as Dell EMC servers, storage, networking, firewall, and supported third party devices.

Key features of OpenManage Mobile when connected through OpenManage Essentials console:

- Connect to multiple servers which have OME installed, from a single mobile device.
- Connect to multiple servers individually through the iDRAC interface.
- Receive critical alert notifications on your mobile device as they arrive into your OpenManage Essentials management console.
- Acknowledge, forward, and delete alerts from your mobile device.
- Browse through device details, firmware inventory, and event logs of individual systems.
- Perform several server management functions such as power-on, power cycle, reboot, and shutdown from the mobile application.

Key Features of OpenManage Mobile when connected through iDRAC:

- Connect to any previous generation PowerEdge servers remotely.
- Assign IP address, change credentials, and update common BIOS attributes for bare metal configuration.
- Configure one server manually, or multiple servers simultaneously through a template.
- Browse server details, health status, hardware and firmware inventory, networking details, and system event or LC logs. Share this information easily with other IT Administrators.
- Access SupportAssist reports, Last Crash screen and video for both previous and current generation PowerEdge servers.
- Access virtual console and reduce the need for crash carts.
- Power on, shut down, or reboot your server from anywhere.
- Run any RACADM command.

OpenManage Enterprise Power Manager

OpenManage Enterprise Power Manager is a plugin for OpenManage Enterprise V3.2 and later. Power Manager provides monitoring and management at a one to many levels of server power and thermal. The features of Power Manager are:

- Measure and manage power consumption and monitors thermal readings—OME Power Manager provides greater insight into a data center's energy usage through detailed measurement of energy consumption throughout a data center. Power Manager gives administrators the ability to measure and manage the power consumption of up to 3,000 servers and track both short-term and long-term historical data.
- Create and implement multiple usage policies—Power Managers simplifies implementation of power policies across a data center. When it is used with the previous generation or later versions of the PowerEdge servers, OpenManage Enterprise Advanced license, and an iDRAC Enterprise license, administrators can control power consumption to each row, rack, or group of PE servers. Also, administrators can create reports on energy usage and thermal readings on a group-by-group basis.
- Reduce consumption during low-load hours—Power Manager helps administrators to save power by allowing management of a server room according to business needs. Power Manager allows administrators to implement policies that reduce the power consumption when the demand on the systems is lower. It can also assign maximum power to the servers that run the most important applications.

For more information, see [OpenManage Enterprise Power Manager User's Guide](#).

Dell EMC OpenManage systems management tools, utilities, and protocols

Dell EMC OpenManage systems management tools and utilities consist of the following:

Dell EMC Repository Manager

Dell EMC Repository Manager (DRM) is an application that helps you to:

- Identify the updates that are relevant to the systems in your data center
- Identify and notify you when updates are available
- Package the updates into different deployment formats

To automate the creation of baseline repositories, DRM provides advanced integration capabilities with iDRAC/Lifecycle controller, OpenManage Essentials, Chassis Management Controller, OpenManage Integration for VMware vCenter and OpenManage Integration for Microsoft System Center (OMIMSSC). Also, DRM packages updates into custom catalogs that can be used for deployment.

Dell EMC Repository Manager can create the following deployment tools:

- Custom catalogs
- Lightweight deployment pack
- Bootable Linux ISO
- Custom Server Update Utility (SUU)

For more information, see Dell EMC Repository Manager user's guide available at Dell.com/support/manuals.

Dell Update Packages

Dell Update Packages (DUPs) are self-contained executables supported by Microsoft Windows or Linux that update a component on a server and applications like OMSA, iSM, and DSET.

DUPs can be executed in UI or in CLI mode.

For more information, see the Dell EMC Update Packages user's guide available at www.delltechcenter.com/DSU.

Dell Remote Access Controller Administration (RACADM) CLI

The RACADM command-line utility provides a scriptable interface to perform inventory, configuration, update, and health status check of PowerEdge servers. RACADM operates in multiple modes.

- Local—supports running RACADM commands from the managed server's operating system
- SSH or Telnet—known as Firmware RACADM; is accessible by logging in to iDRAC using SSH or Telnet
- Remote—supports running RACADM commands from a remote management station such as a laptop or desktop

RACADM is supported by the iDRAC with Lifecycle Controller and by the Chassis Management Controller of the M1000e, VRTX and FX2 modular systems. Local and Remote RACADM is supported on Windows Server, Windows clients, and on Red Hat, SuSe, and Ubuntu Linux.

For more information, see the RACADM Command Line reference guide for iDRAC and CMC available at Dell.com/support/manuals.

iDRAC with Lifecycle Controller Embedded Management APIs

iDRAC with Lifecycle Controller provides a range of standards-based applications programming interfaces (APIs) that enable scalable and automated management of PowerEdge servers. Standard systems management APIs have been developed by organizations such as the Institute of Electrical and Electronics Engineers (IEEE) and Distributed Management Task Force (DMTF). These APIs are widely used by commercial systems management products and by custom programs and scripts developed by IT staff to automate management functions such as discovery, inventory, health status checking, configuration, update, and power management. The APIs supported by iDRAC with Lifecycle Controller include:

- **Redfish**—In 2015, the DMTF Scalable Platforms Management Forum (SPMF) published Redfish, an open industry-standard specification and schema designed to meet the needs of IT administrators for simple, modern, and secure management of scalable platform hardware. Dell is a key contributor to the Redfish standard, acting as co-chair of the SPMF, promoting the benefits of Redfish, and working to deliver those benefits within industry-leading systems management solutions. Redfish is a next-generation management standard using a data model representation inside a hypermedia RESTful interface. The data model is defined in terms of a standard, machine-readable schema, with the payload of the messages expressed in JSON and the OData v4 protocol.
- **WSMan**—The Web Services For Management (WSMan) API, first published by the DMTF in 2008, is the most mature and robust API provided by iDRAC with Lifecycle Controller. WSMan uses a Simple Object Access Protocol (SOAP) with

data modeled using the Common Information Model. WSMAN provides interoperability between management applications and managed resources, and identifies a core set of web service specifications and usage requirements that expose a common set of operations central to all systems management.

- **IPMI**—The Intelligent Platform Management Interface (IPMI) is a message-based, hardware-level interface specification that can operate over both LAN and serial interfaces. IPMI is supported broadly by server vendors, systems management solutions, and open source software.
- **SNMP**—The Simple Network Management Protocol (SNMP) helps in standardizing the management of network devices. SNMP allows commercial management consoles created for monitoring network switches and routers to also monitor X86 servers. SNMP is primarily used to deliver event messages to alert administrators of problems on their systems but can also be used to discover, inventory and configure servers.

To assist automating system management tasks and simplify API integration, Dell provides PowerShell and Python libraries and script examples using the WSMAN interface. The iDRAC with Lifecycle Controller pages of Dell Techcenter offer a library of technical white papers detailing the use of the embedded management APIs. For more information, see delltechcenter.com/iDRAC and delltechcenter.com/LC.

Integration with third-party consoles

Dell EMC OpenManage provides integration with several leading third-party consoles, including:

OpenManage Integration Suite for Microsoft System Center

The combination of Dell OpenManage Integration Suite and Microsoft System Center simplifies and enhances deployment, configuration, monitoring and updating of Dell servers and storage in physical and virtual environments. Our agent-free and agent-based plug-ins deliver a unique level of integration and efficiency when managing Dell hardware within a System Center environment.

The OpenManage Integration Suite for Microsoft System Center includes: Dell Server and Storage Management Packs for System Center Operations Manager (SCOM), Dell Server Deployment Packs and Update Catalogs for System Center Configuration Manager (SCCM), and tools for optimizing management of Dell PowerEdge servers in virtual environments using System Center Virtual Machine Manager (SCVMM).

OpenManage Integration for VMware vCenter

The OpenManage Integration for VMware vCenter (OMIVV) allows you to monitor, provision, and manage PowerEdge server hardware and firmware. You can perform these tasks through a dedicated Dell menu that can be accessed directly through the VMware vCenter console. OMIVV also allows granular control and reporting for the hardware environment using the same role-based access control model as vCenter. The OpenManage Management Pack for vRealize Operations Manager is available with OMIVV version 4.0 and later. This helps to checking hardware health and alerting into vRealize operations, which also includes dashboard and reporting on the server environment.

Use the following features to manage and monitor Dell hardware within the virtualized environment:

- Alerting and monitoring environment for servers and chassis
- Monitoring and reporting for servers and chassis
- Updating firmware on servers
- Deploying enhanced options

For more information, see delltechcenter.com/omivv.

 **NOTE:** The Dell EMC Repository Manager integrates with OpenManage Integration for VMware vCenter. The Dell EMC Repository Manager provides advanced functionality, simplifies the discovery, and deployment of new updates.

BMC Software

Dell EMC and BMC Software work together to simplify IT by ensuring tight integration between Dell EMC server, storage, and network management functionality and the BMC Software process and data center automation products.

OpenManage connections with third-party consoles

Dell EMC OpenManage Connections simplifies adding support for third-party devices, so you can continue to use your existing management tools while easily adding Dell EMC server systems to your IT environment. Integrate new systems at your own pace. Manage new Dell EMC servers and storage with your legacy management tools, while extending the useful life of your existing resources. With OpenManage Connections you can add monitoring and troubleshooting of Dell EMC assets to your IT infrastructure.

- OpenManage Connection for Nagios Core and Nagios XI

- OpenManage Connection for HPE Operations Manager i (OMi)

For more information on these OpenManage Connections, visit Dell.com/openmanage.

Dell Technologies Services

Dell Technologies Services include a wide, customizable range of service choices to simplify the assessment, design, implementation, management and maintenance of IT environments and to help you transition from platform to platform. Depending on your current business requirements and the level of service right for you, we provide factory, on-site, remote, modular, and specialized services that fit your needs and budget. We'll help with a little or a lot—your choice—and provide access to our global resources.

For more information, see DellEMC.com/Services.

Topics:

- [Dell EMC ProDeploy Enterprise Suite](#)
- [Dell EMC Remote Consulting Services](#)
- [Dell EMC Data Migration Service](#)
- [Prosupport Enterprise Suite](#)
- [Dell EMC ProSupport Plus for Enterprise](#)
- [Dell EMC ProSupport for Enterprise](#)
- [Dell EMC ProSupport One for Data Center](#)
- [Support Technologies](#)
- [Dell Technologies Education Services](#)
- [Dell Technologies Consulting Services](#)
- [Dell EMC Managed Services](#)

Dell EMC ProDeploy Enterprise Suite

ProDeploy Enterprise Suite gets your server out of the box and into optimized production—fast. Our elite deployment engineers with broad and deep experience utilizing best-in-class processes along with our established global scale can help you around the clock and around the globe. From simple to the most complex server installations and software integration, we take the guess work and risk out of deploying your new server technology.

		Basic Deployment	ProDeploy	ProDeploy Plus
Pre-deployment	Single point of contact for project management	-	●	In-region
	Site readiness review	-	●	●
	Implementation planning	-	●	●
	SAM engagement for ProSupport Plus entitled devices	-	-	●
Deployment	Deployment service hours	Business hours	24x7	24x7
	Remote guidance for hardware installation or Onsite hardware installation and packaging material removal	Onsite	Remote or Onsite	Onsite
	Install and configure system software	-	Remote	Onsite
	Install support software and connect with Dell Technologies	-	●	●
	Project documentation with knowledge transfer	-	●	●
Post-deployment	Deployment verification	-	●	●
	Configuration data transfer to Dell EMC technical support	-	●	●
	30-days of post-deployment configuration assistance	-	-	●
	Training credits for Dell EMC Education Services	-	-	●

Figure 10. ProDeploy Enterprise Suite capabilities

 **NOTE:** Hardware installation not applicable on selected software products.

Dell EMC ProDeploy Plus

From beginning to end, ProDeploy Plus provides the skill and scale needed to successfully execute demanding deployments in today's complex IT environments. Certified Dell EMC experts start with extensive environmental assessments and detailed migration planning and recommendations. Software installation includes set up of most versions of Dell EMC SupportAssist and OpenManage system management utilities. Post-deployment configuration assistance, testing, and product orientation services are also available.

Dell EMC ProDeploy

ProDeploy provides full service installation and configuration of both server hardware and system software by certified deployment engineers including set up of leading operating systems and hypervisors as well as most versions of Dell EMC SupportAssist and OpenManage system management utilities. To prepare for the deployment, we conduct a site readiness review and implementation planning exercise. System testing, validation, and full project documentation with knowledge transfer complete the process.

Dell EMC Basic Deployment

Basic Deployment delivers worry-free professional installation by experienced technicians who know Dell EMC servers inside and out.

Dell EMC Server Configuration Services

With Dell EMC Rack Integration and other Dell EMC PowerEdge Server Configuration Services, you save time by receiving your systems racked, cabled, tested, and ready to integrate into the data center. Dell EMC staff pre-configure RAID, BIOS and iDRAC settings, install system images, and even install third-party hardware and software.

For more information, see [Server Configuration Services](#).

Dell EMC Residency Services

Residency Services helps customers transition to new capabilities quickly with the assistance of on-site or remote Dell EMC experts whose priorities and time you control. Residency experts can provide post implementation management and knowledge transfer related to a new technology acquisition or day-to-day operational management of the IT infrastructure.

Dell EMC Remote Consulting Services

When you are in the final stages of your PowerEdge server implementation, you can rely on Dell EMC Remote Consulting Services and our certified technical experts to help you optimize your configuration with best practices for your software, virtualization, server, storage, networking, and systems management.

Dell EMC Data Migration Service

Protect your business and data with our single point of contact to manage your data migration project. Your project manager will work with our experienced team of experts to create a plan using industry-leading tools and proven processes based on global best practices to migrate your existing files and data so your business system get up and running quickly and smoothly.

Prosupport Enterprise Suite

With Dell EMC ProSupport Services, we can help you keep your operation running smoothly so you can focus on running your business. We will help you maintain peak performance and availability of your most essential workloads. Dell EMC ProSupport is a suite of support services that enable you to build the solution that is right for your organization. Choose support models based on how you use technology and where you want to allocate resources. From the desktop to the data center, address

everyday IT challenges, such as unplanned downtime, mission-critical needs, data and asset protection, support planning, resource allocation, software application management and more. Optimize your IT resources by choosing the right support model.

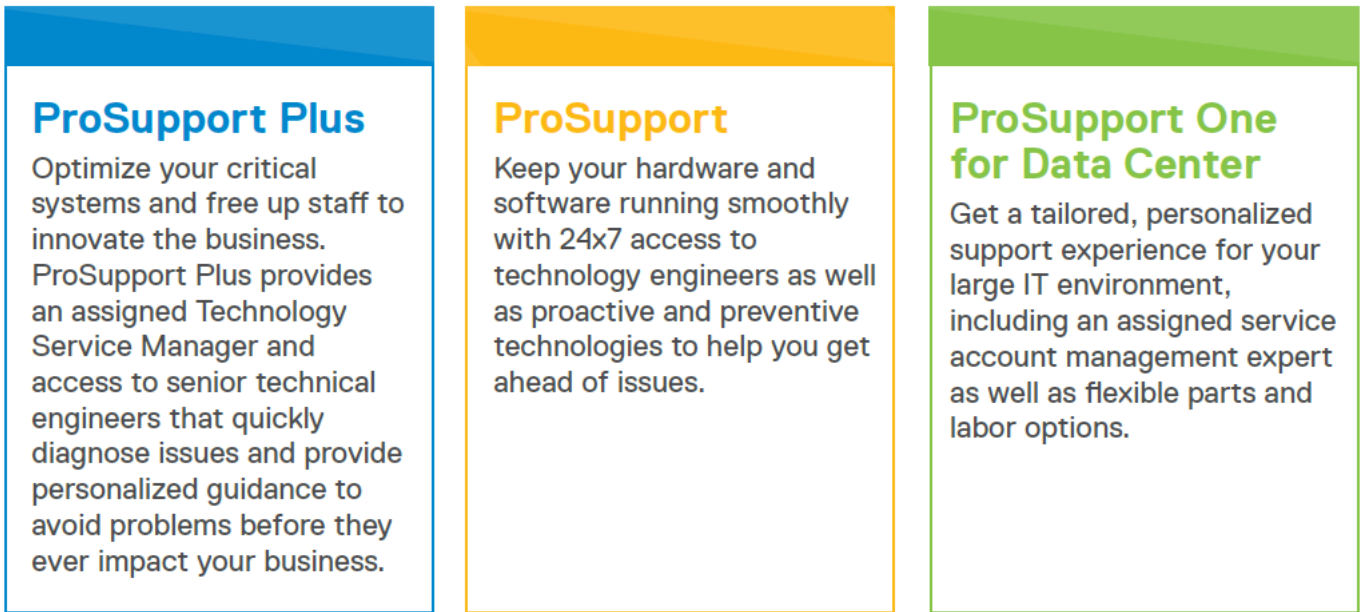

Figure 11. ProSupport Enterprise Suite

Dell EMC ProSupport Plus for Enterprise

When you purchase your PowerEdge server, we recommend ProSupport Plus, our proactive and preventative support service for your business-critical systems. ProSupport Plus provides you with all the benefits of ProSupport, plus the following:

- An assigned Services Account Manager who knows your business and your environment
- Immediate advanced troubleshooting from an engineer who understands your PowerEdge server
- Personalized, preventive recommendations based on analysis of support trends and best practices from across the Dell Technologies infrastructure solutions customer base to reduce support issues and improve performance
- Predictive analysis for issue prevention and optimization enabled by SupportAssist
- Proactive monitoring, issue detection, notification, and automated case creation for accelerated issue resolution enabled by SupportAssist
- On-demand reporting and analytics-based recommendations enabled by SupportAssist and TechDirect

Dell EMC ProSupport for Enterprise

Our ProSupport service offers highly trained experts around the clock and around the globe to address your IT needs. We help minimize disruptions and maximize availability of PowerEdge server workloads with:

- 24x7 support through phone, chat and online
- Predictive, automated tools and innovative technology
- A central point of accountability for all hardware and software issues
- Collaborative 3rd party support
- Hypervisor, operating system and application support
- Consistent experience regardless of where you are located or what language you speak
- Optional onsite parts and labor response options including next business day or four-hour mission critical

NOTE: Subject to service offer country availability.

Enterprise Support Services Feature Comparison

	Basic	ProSupport	ProSupport Plus
Remote technical support	9x5	24x7	24x7
Covered products	Hardware	Hardware Software	Hardware Software
Onsite hardware support	Next business day	Next business day or 4hr mission critical	Next business day or 4 hr mission critical
3 rd party collaborative assistance		●	●
Automated issue detection & proactive case creation		●	●
Self-service case initiation and management		●	●
Access to software updates		●	●
Priority access to specialized support experts			●
3 rd party software support			●
Assigned Services Account Manager			●
Personalized assessments and recommendations			●
Semiannual systems maintenance			●

Availability and terms of Dell Technologies services vary by region and by product. For more information, please view our Service Descriptions available on Dell.com

Figure 12. Dell EMC Enterprise Support model

Dell EMC ProSupport One for Data Center

ProSupport One for Data Center offers flexible site-wide support for large and distributed data centers with more than 1,000 assets. This offering is built on standard ProSupport components that leverage our global scale but are tailored to your company's needs. While not for everyone, this service option offers a truly unique solution for Dell Technologies largest customers with the most complex environments.

- Team of assigned Services Account Managers with remote, on-site options
- Assigned ProSupport One technical and field engineers who are trained on your environment and configurations
- On-demand reporting and analytics-based recommendations enabled by SupportAssist and TechDirect
- Flexible on-site support and parts options that fit your operational model
- A tailored support plan and training for your operations staff

Support Technologies

Powering your support experience with predictive, data-driven technologies.

Dell EMC SupportAssist

The best time to solve a problem is before it happens. The automated proactive and predictive technology SupportAssist helps reduce steps and time to resolution, often detecting issues before they become a crisis. Benefits include:

- Value—SupportAssist is available to all customers at no additional charge
- Improve productivity—replace manual, high-effort routines with automated support
- Accelerate time to resolution—receive issue alerts, automatic case creation, and proactive contact from Dell EMC experts
- Gain insight and control—optimize enterprise devices with on-demand ProSupport Plus reporting in TechDirect, and get predictive issue detection before the problem starts

NOTE: SupportAssist is included with all support plans, but features vary based on service level agreement.

	Basic Hardware Warranty	ProSupport	ProSupport Plus
Automated issue detection and system state information collection	•	•	•
Proactive, automated case creation and notification		•	•
Predictive issue detection for failure prevention			•
Recommendation reporting available on-demand in TechDirect			•

Figure 13. SupportAssist model

Get started at Dell.com/SupportAssist

Dell EMC TechDirect

Boost IT team productivity when supporting Dell EMC systems. With over 1.4 million self-dispatches processed each year, TechDirect has proven its effectiveness as a support tool. You can:

- Self-dispatch replacement parts
- Request technical support
- Integrate APIs into your help desk

Or, access all your Dell EMC certification and authorization requirements. Train your staff on Dell EMC products, as TechDirect allows you to:

- Download study guides
- Schedule certification and authorization exams
- View transcripts of completed courses and exams

Register at techdirect.dell.

Dell Technologies Education Services

Build the IT skills required to influence the transformational outcomes of the business. Enable talent and empower teams with the right skills to lead and execute transformational strategy that drives competitive advantage. Leverage the training and certification required for real transformation.

Dell Technologies Education Services offers PowerEdge server training and certifications designed to help you achieve more from your hardware investment. The curriculum delivers the information and the practical, hands-on skills that you and your team need to confidently install, configure, manage, and troubleshoot your Dell EMC servers. To learn more or register for a class today, see LearnDell.com/Server.

Dell Technologies Consulting Services

Our expert consultants help you transform faster, and quickly achieve business outcomes for the high value workloads Dell EMC PowerEdge systems can handle.

From strategy to full-scale implementation, Dell Technologies Consulting can help you determine how to execute your IT, workforce, or application transformation.

We use prescriptive approaches and proven methodologies combined with Dell Technologies' portfolio and partner ecosystem to help you achieve real business outcomes. From multi-cloud, applications, DevOps, and infrastructure transformations, to business resiliency, data center modernization, analytics, workforce collaboration, and user experiences—we're here to help.

Dell EMC Managed Services

Reduce the cost, complexity, and risk of managing IT. Focus your resources on digital innovation and transformation while our experts help optimize your IT operations and investment with managed services backed by guaranteed service levels.

Appendix A. Additional specifications

Topics:

- Chassis dimensions
- Chassis weight
- Video specifications
- USB ports specifications
- Environmental specifications

Chassis dimensions

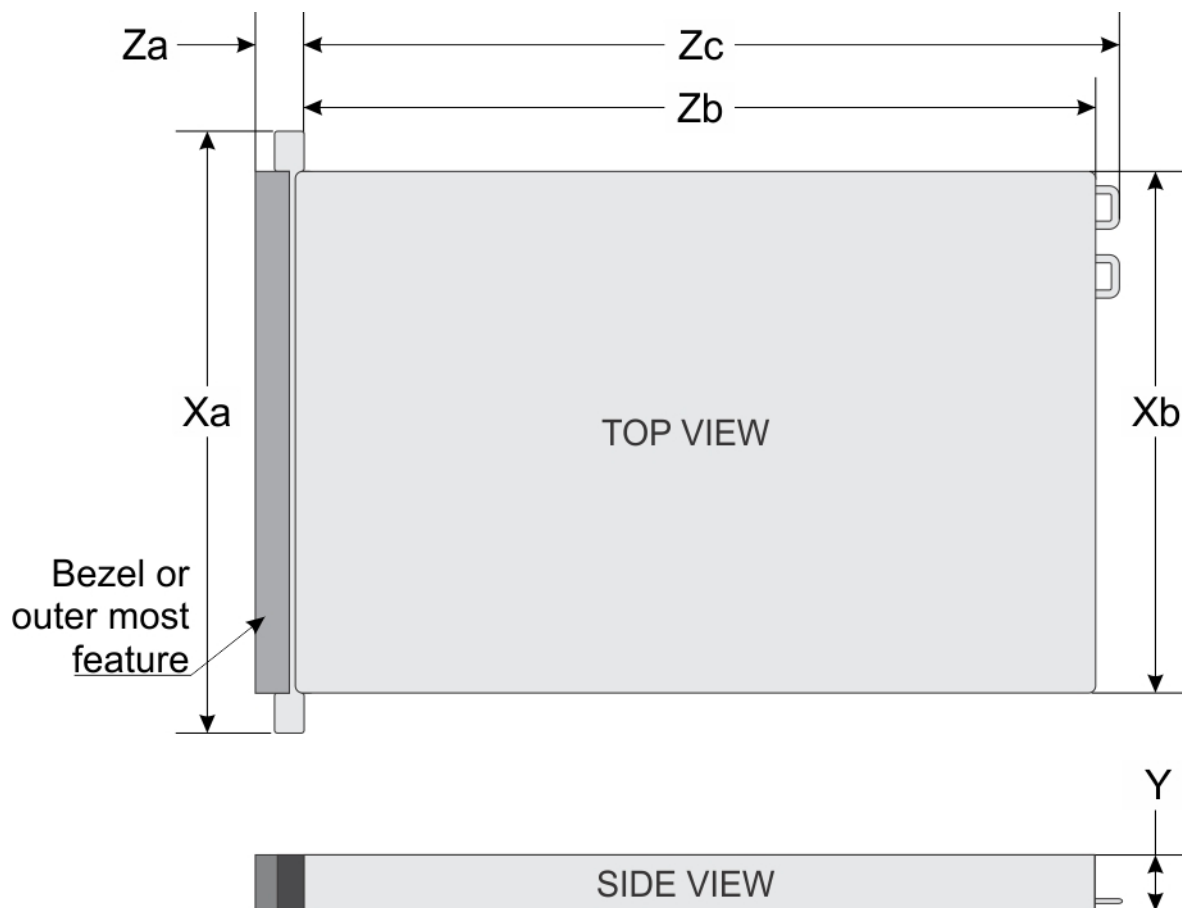

Figure 14. Chassis dimension

Table 18. Dimensions (mm)

Xa	Xb	Y	Za with bezel	Za without bezel	Zb	Zc	Chassis
482 mm (18.97 inches)	434 mm (17.08 inches)	86.8 mm (3.41 inches)	35.84 mm (1.41 inches)	22 mm (0.87 inches)	647.07 mm (25.47 inches)	681.755 mm (26.84 inches)	2U

NOTE: Zb goes to the nominal rear wall external surface where the system board I/O connectors resides.

Chassis weight

Table 19. Chassis weight (kg)

System configuration	Maximum system weight with all drives
8 x 2.5-inch configuration	23.78 kg (52.42 lb)
12 x 3.5-inch configuration	25.68 kg (56.61 lb)
12 x 3.5-inch + rear 2x3.5-inch configuration	27.3 kg (60.18 lb)
24 x 2.5-inch configuration	23.72 kg (52.29 lb)

Video specifications

The PowerEdge R7515 system supports an integrated Matrox G200eR2 graphics card with 16 MB capacity.

NOTE: 1920 x 1080 and 1920 x 1200 resolutions are only supported in reduced blanking mode.

The following table lists the supported front video resolution options:

Table 20. Supported front video resolution options

Resolution	Refresh rate (Hz)	Color depth (bits)
1024 x 768	60	8, 16, 32
1280 x 800	60	8, 16, 32
1280 x 1024	60	8, 16, 32
1360 x 768	60	8, 16, 32
1440 x 900	60	8, 16, 32

This table describes the supported rear video resolution options:

Table 21. Supported rear video resolution options

Resolution	Refresh rate (Hz)	Color depth (bits)
1024 x 768	60	8, 16, 32
1280 x 800	60	8, 16, 32
1280 x 1024	60	8, 16, 32
1360 x 768	60	8, 16, 32
1440 x 900	60	8, 16, 32
1600 x 900	60	8, 16, 32
1600 x 1200	60	8, 16, 32
1680 x 1050	60	8, 16, 32
1920 x 1080	60	8, 16, 32
1920 x 1200	60	8, 16, 32

USB ports specifications

The following table shows the USB specifications for the PowerEdge system.

Table 22. PowerEdge R7515 system USB specifications

Front		Rear		Internal	
USB port type	Number of ports	USB port type	Number of ports	USB port type	Number of ports
USB 2.0-compliant port	Two	USB 3.0-compliant ports	Two	Internal USB 3.0-compliant port	One
Micro USB 2.0-compliant port for iDRAC Direct	One				

NOTE: The micro USB 2.0 compliant port can only be used as an iDRAC Direct or a management port.

Environmental specifications

The following sections contain information about the environmental specifications of the system.

NOTE: For additional information about environmental certifications, refer to the Product Environmental Datasheet located with the Manuals and Documents on www.dell.com/poweredgemanuals.

Operational climatic range category A2

Table 23. Operational climatic range category A2

Allowable continuous operations	
Temperature ranges for altitude ≤900 meters (≤2,953 feet)	10 to 35°C (50 to 95°F) with no direct sunlight on the platform
Humidity percent ranges (noncondensing at all times)	8% RH with—12°C minimum dew point to 80% RH with 21°C (69.8°F) maximum dew point
Operational altitude de-rating	Maximum temperature is reduced by 1°C/300 meters (1.8°F/984 feet) above 900 meters (2,953 feet)

Operational climatic range category A3

Table 24. Operational climatic range category A3

Allowable continuous operations	
Temperature ranges for altitude ≤900 meters (≤2,953 feet)	5 to 40°C (41 to 104°F) with no direct sunlight on the platform
Humidity percent ranges (noncondensing at all times)	8% RH with—12°C minimum dew point to 85% RH with 24°C (75.2°F) maximum dew point
Operational altitude de-rating	Maximum temperature is reduced by 1°C/175 meters (1.8°F/574 feet) above 900 meters (2,953 feet)

Thermal restriction for ASHRAE A3/Fresh air environment (UI)

- Two PSUs are required in redundant mode. Single PSU failure is not supported

- LRDIMM is not supported
- Processor TDP equal or greater than 180 W are not supported
- 128 GB or greater capacity DIMMs are not supported
- Non-Dell qualified peripheral cards greater than 25 W are not supported
- Both SW and DW GPGPU are not supported
- PCIe SSD is not supported
- Rear drive configuration is not supported

Thermal restriction for ASHRAE A4/Fresh air environment (UI)

- Two PSUs are required in redundant mode. Single PSU failure is not supported
- LRDIMM is not supported.
- Processor TDP equal or greater than 155 W are not supported.
- 128 GB or greater capacity DIMMs are not supported.
- Both SW and DW GPGPU are not supported.
- PCIe card without EOT (max 65°C inlet temperature) and cooling tier 5 and above are not supported (UI).
- PCIe SSD is not supported.
- BOSS and OCP are not supported (UI).
- PCIe card TDP greater than 25 W is not supported.
- Rear drive configuration is not supported.

Shared requirements across all categories

Table 25. Shared requirements across all categories

Allowable operations	
Maximum temperature gradient (applies to both operation and non-operation)	20°C in an hour* (36°F in an hour) and 5°C in 15 minutes (9°F in 15 minutes), 5°C in an hour* (9°F in an hour) for tape hardware
Nonoperational temperature limits	-40 to 65°C (-40 to 149°F)
Nonoperational humidity limits	5% to 95% RH with 27°C (80.6°F) maximum dew point
Maximum nonoperational altitude	12,000 meters (39,370 feet)
Maximum operational altitude	3,048 meters (10,000 feet)

*: Per ASHRAE thermal guidelines, these are not instantaneous rates of temperature change.

Table 26. Maximum vibration specifications

Maximum vibration	Specifications
Operating	0.26 Grms at 5 Hz to 350 Hz (all operation orientations)
Storage	1.88 Grms at 10 Hz to 500 Hz for 15 minutes (all six sides tested)

Table 27. Maximum shock pulse specifications

Maximum shock pulse	Specifications
Operating	24 executed shock pulses in the positive and negative x, y, and z axis of 6 G for up to 11 ms. (4 pulse on each side of the system)
Storage	Six consecutively executed shock pulses in the positive and negative x, y, and z axis (one pulse on each side of the system) of 71 G for up to 2 ms.

Thermal restriction matrix

Table 28. Label references

Label references	
STD	Standard
HPR	High Performance
HSK	Heat sink
LP	Low Profile (Riser)
FH	Full Height (Riser)
DW	Double Wide (Xilinx FPGA accelerator)

Table 29. Thermal restriction matrix

Drive type	Configuration	8 x 3.5-inch drives	12 x 3.5-inch drives	12 x 3.5-inch drives	24 x 2.5-inch drives		12 x 2.5-inch drives SAS + 12 x 2.5-inch drives NVMe		24 x 2.5-inch drives NVMe	
Rear Configuration		2LP+2FH	2LP+2FH	Rear 2x3.5-inch drives SAS	2LP+2FH	2LP+1DW	2LP+2FH	2LP+1DW	2LP+2FH	2LP+1DW
Ambient temperature		Up to 35°C	Up to 35°C	Up to 35°C	Up to 35°C	Up to 30°C	Up to 35°C	Up to 30°C	Up to 35°C	Up to 30°C
TDP (W)	120	STD Fan 1U HPR HSK	HPR Fan 1U HPR HSK	HPR Fan 2U HPR HSK	STD Fan 1U HPR HSK	HPR Fan 1U HPR HSK	HPR Fan 1U HPR HSK	HPR Fan 1U HPR HSK	HPR Fan 1U HPR HSK	HPR Fan 1U HPR HSK
	155	STD Fan 1U HPR HSK	HPR Fan 1U HPR HSK	2U HPR HSK	STD Fan 1U HPR HSK	HPR Fan 1U HPR HSK	HPR Fan 1U HPR HSK	HPR Fan 1U HPR HSK	HPR Fan 1U HPR HSK	HPR Fan 1U HPR HSK
	170	STD Fan 1U HPR HSK	HPR Fan 1U HPR HSK	2U HPR HSK	STD Fan 1U HPR HSK	HPR Fan 1U HPR HSK	HPR Fan 1U HPR HSK	HPR Fan 1U HPR HSK	HPR Fan 1U HPR HSK	HPR Fan 1U HPR HSK
	180	STD Fan 1U HPR HSK	HPR Fan 1U HPR HSK	2U HPR HSK	STD Fan 1U HPR HSK	HPR Fan 1U HPR HSK	HPR Fan 1U HPR HSK	HPR Fan 1U HPR HSK	HPR Fan 1U HPR HSK	HPR Fan 1U HPR HSK
	200	STD Fan 1U HPR HSK	HPR Fan 1U HPR HSK	2U HPR HSK	STD Fan 1U HPR HSK	HPR Fan 1U HPR HSK	HPR Fan 1U HPR HSK	HPR Fan 1U HPR HSK	HPR Fan 1U HPR HSK	HPR Fan 1U HPR HSK
	225	HPR Fan 1U HPR HSK	HPR Fan 1U HPR HSK	2U HPR HSK	HPR Fan 1U HPR HSK	HPR Fan 1U HPR HSK	HPR Fan 1U HPR HSK	HPR Fan 1U HPR HSK	HPR Fan 1U HPR HSK	HPR Fan 1U HPR HSK
	240	HPR Fan 1U HPR HSK	HPR Fan 1U HPR HSK	2U HPR HSK	HPR Fan 1U HPR HSK	HPR Fan 1U HPR HSK	HPR Fan 1U HPR HSK	HPR Fan 1U HPR HSK	HPR Fan 1U HPR HSK	HPR Fan 1U HPR HSK

Table 29. Thermal restriction matrix (continued)

Drive type	Configuration	8 x 3.5-inch drives		12 x 3.5-inch drives		24 x 2.5-inch drives		12 x 2.5-inch drives SAS + 12 x 2.5-inch drives NVMe		24 x 2.5-inch drives NVMe	
		HPR Fan	NA	* HPR Fan	HPR Fan	HPR Fan	*HPR Fan	HPR Fan	*HPR Fan	HPR Fan	
	280*	1U HPR HSK		2U HPR HSK	1U HPR HSK	1U HPR HSK	1U HPR HSK	1U HPR HSK	1U HPR HSK	1U HPR HSK	1U HPR HSK
	280 W - 64C/32C	1U HPR HSK		2U HPR HSK	1U HPR HSK	1U HPR HSK	1U HPR HSK	1U HPR HSK	1U HPR HSK	1U HPR HSK	1U HPR HSK
Double Wide FPGA		No	No	Not supported	No	Yes	No	Yes	No	Yes	

NOTE: To ensure proper cooling in the system with 280 W processor, memory module blank should be installed in the memory sockets that are not populated.

NOTE: *For 12 x 3.5-inch drive (Rear 2 x 3.5-inch drives SAS)/24 x 2.5-inch drive/12 x 2.5-inch drives SAS + 12 x 2.5-inch drives NVMe configuration support 280 W CPU up to 30°C ambient temperature.

Table 30. Thermal restriction matrix for T4 and A2 GPU Card

Drive Configuration type	8 x 3.5-inch drives	12 x 3.5-inch drives	12 x 3.5-inch drives	24 x 2.5-inch drives	12 x 2.5-inch drives SAS + 12 x 2.5-inch drives NVMe	24 x 2.5-inch drives NVMe
Rear Configuration	2LP+2FH	2LP+2FH	Rear 2x3.5-inch drives SAS	2LP+2FH	2LP+2FH	2LP+2FH
Ambient temperature	Up to 30°C	Up to 30°C	Up to 30°C	Up to 30°C	Up to 30°C	Up to 30 °C
Slot 2 Slot 3 Slot 4 Slot 5 Slot 2/ Slot 3 Slot 4/ Slot 5 Slot 2/ Slot 3	Slot 2	HPR Fan 1U HPR HSK	N/A	N/A	HPR Fan 1U HPR HSK	HPR Fan 1U HPR HSK
	Slot 3	HPR Fan 1U HPR HSK	N/A	N/A	HPR Fan 1U HPR HSK	HPR Fan 1U HPR HSK
	Slot 4	HPR Fan 1U HPR HSK	N/A	N/A	HPR Fan 1U HPR HSK	HPR Fan 1U HPR HSK
	Slot 5	HPR Fan 1U HPR HSK	N/A	N/A	HPR Fan 1U HPR HSK	HPR Fan 1U HPR HSK
	Slot 2/ Slot 3	HPR Fan 1U HPR HSK	N/A	N/A	HPR Fan 1U HPR HSK	HPR Fan 1U HPR HSK
	Slot 4/ Slot 5	HPR Fan 1U HPR HSK	N/A	N/A	HPR Fan 1U HPR HSK	HPR Fan 1U HPR HSK
	Slot 2/ Slot 3	HPR Fan 1U HPR HSK	N/A	N/A	HPR Fan 1U HPR HSK	HPR Fan 1U HPR HSK

Table 30. Thermal restriction matrix for T4 and A2 GPU Card (continued)

Drive Configuration type	8 x 3.5-inch drives	12 x 3.5-inch drives	12 x 3.5-inch drives	24 x 2.5-inch drives	12 x 2.5-inch drives SAS + 12 x 2.5-inch drives NVMe	24 x 2.5-inch drives NVMe
Slot 4/ Slot 5						

NOTE: The table shows ambient restriction according to T4 and A2 in specific PCIe slots of R7515 PCIe x4 rear end configuration. R7515 rear drive x2 + PCIe x2 does not support T4 and A2 is not considered in this table.

Table 31. Thermal restriction matrix for MI210, A16 and V100S GPU Cards

Drive Configuration type	8 x 3.5-inch drives	12 x 3.5-inch drives	12 x 3.5-inch drives	24 x 2.5-inch drives	12 x 2.5-inch drives SAS + 12 x 2.5-inch drives NVMe	24 x 2.5-inch drives NVMe
Rear Configuration	2LP+2FH	2LP+2FH	Rear 2x3.5-inch drives SAS	2LP+2FH	2LP+2FH	2LP+2FH
Ambient temperature	Up to 30°C	Up to 30°C	Up to 30°C	Up to 30°C	Up to 30°C	Up to 30 °C
Slot 2	N/A	N/A	N/A	N/A	N/A	N/A
Slot 3	N/A	N/A	N/A	HPR Fan 1U HPR HSK	N/A	N/A
Slot 4	N/A	N/A	N/A	N/A	N/A	N/A
Slot 5	N/A	N/A	N/A	N/A	N/A	N/A

NOTE: 8 x 3.5-inch drives chassis do not support AUX power cable, and therefore do not support A16 and V100S GPU cards.

Table 32. Processor support matrix

TDP (W)	Fan type	Fan type (8 x 3.5-inch/ 24 x 2.5-inch)	HSK Type(8 x 3.5-inch/24 x 2.5/12x2.5-inchSAS+ 12 x 2.5-inchNVMe/ 24x2.5-inchNVMe)	HSK Type(12 x 3.5-inch)	HSK Type(12 x 3.5-inch+Rear 2 x 3.5-inch)	ASHRAE A3 support	ASHRAE A4 support
280	HPR Fan	HPR Fan	1U HPR	NA	2U HPR	No	No
240	HPR Fan	HPR Fan	1U HPR	1U HPR	2U HPR	No	No
225	HPR Fan	HPR Fan	1U HPR	1U HPR	2U HPR	No	No
200	HPR Fan	STD Fan	1U HPR	1U HPR	2U HPR	No	No
180	HPR Fan	STD Fan	1U HPR	1U HPR	2U HPR	No	No
155	HPR Fan	STD Fan	1U HPR	1U HPR	2U HPR	Yes	No
120	HPR Fan	STD Fan	1U HPR	1U HPR	2U HPR	Yes	Yes

NOTE: HPR fan is required for T4 GPU, A16 GPU, V100S GPU, NVMe, and Double wide FPGA supporting.

NOTE: NVMe configuration with drive install/Nvidia T4/ Double Width FPGA

NOTE: Except for 8 x 3.5-inch/24 x 2.5-inch(without NVMe), all other configurations have only high-performance fan type.

NOTE: 12 x 3.5-inch does not support 280 W processor.

NOTE: Need DIMM blank support for Evans HDD (RJT6H, 7KT9W, PY7WD, CNXPV, WGXDC, V308G, 3JTD3, 39XRY) in 12 x 3.5-inch drive configuration.

Other thermal restrictions

- Mellanox CX5 with QSFP28 is restricted to slot 4 and slot 5 in no rear drive configuration. Non-Dell qualified cables are not supported.
- Mellanox CX6 with QSFP56 (Mellanox MFS1S00) is restricted to slot 4 and slot 5 in no rear drive configuration. Non-Dell qualified cables are not supported.
- Solarflare XtremeScale X2522-25G adapter is restricted to slot 4 and slot 5 in no rear drive configuration.
- 750 GB PCIe SSD Adapter (P4800) by Intel is restricted to slot 4 and slot 5 in no rear drive configuration.
- 25 G LOM riser is not supported with 128 G LRDIMM or higher on 12 x 3.5-inch drives configuration.
- DIMM blank is required at 12 x 3.5-inch and 12 x 3.5-inch + 2 x 3.5-inch (rear) storage configuration.

Appendix B. Standards compliance

The system conforms to the following industry standards.

Table 33. Industry standard documents

Standard	URL for information and specifications
ACPI Advance Configuration and Power Interface Specification, v2.0c	https://uefi.org/specsandtesttools
Ethernet IEEE 802.3-2005	https://standards.ieee.org/
HDG Hardware Design Guide Version 3.0 for Microsoft Windows Server	microsoft.com/whdc/system/platform/pcdesign/desguide/serverdg.mspx
IPMI Intelligent Platform Management Interface, v2.0	intel.com/design/servers/ipmi
DDR4 Memory DDR4 SDRAM Specification	jedec.org/standards-documents/docs/jesd79-4.pdf
PCI Express PCI Express Base Specification Rev. 2.0 and 3.0	pcisig.com/specifications/pciexpress
PMBus Power System Management Protocol Specification, v1.2	http://pmbus.org/Assets/PDFS/Public/PMBus_Specification_Part_1_Rev_1-1_20070205.pdf
SAS Serial Attached SCSI, v1.1	http://www.t10.org/
SATA Serial ATA Rev. 2.6; SATA II, SATA 1.0a Extensions, Rev. 1.2	sata-io.org
SMBIOS System Management BIOS Reference Specification, v2.7	dmtf.org/standards/smbios
TPM Trusted Platform Module Specification, v1.2 and v2.0	trustedcomputinggroup.org
UEFI Unified Extensible Firmware Interface Specification, v2.1	uefi.org/specifications
USB Universal Serial Bus Specification, Rev. 2.0	usb.org/developers/docs

Appendix C Additional resources

Table 34. Additional resources

Resource	Description of contents	Location
Installation and Service Manual	<p>This manual, available in PDF format, provides the following information:</p> <ul style="list-style-type: none"> • Chassis features • System Setup program • System messages • System codes and indicators • System BIOS • Remove and replace procedures • Troubleshooting • Diagnostics • Jumpers and connectors 	Dell.com/Support/Manuals
Getting Started Guide	<p>This guide ships with the system, and is also available in PDF format. This guide provides the following information:</p> <ul style="list-style-type: none"> • Initial setup steps • Key system features • Technical specifications 	Dell.com/Support/Manuals
Rack Installation Instructions	This document ships with the rack kits, and provides instructions for installing a server in a rack.	Dell.com/Support/Manuals
Information Update	This document ships with the system, is also available in PDF format online, and provides information on system updates.	Dell.com/Support/Manuals
System Information Label	The system information label documents the system board layout and system jumper settings. Text is minimized due to space limitations and translation considerations. The label size is standardized across platforms.	Inside the system chassis cover
Quick Resource Locator (QRL)	This code on the chassis can be scanned by a phone application to access additional information and resources for the server, including videos, reference materials, service tag information, and Dell EMC contact information.	Inside the system chassis cover
Energy Smart Solution Advisor (ESSA)	The Dell EMC online ESSA enables easier and more meaningful estimates to help you determine the most efficient configuration possible. Use ESSA to calculate the power consumption of your hardware, power infrastructure, and storage.	Dell.com/calc