

Dell EMC PowerEdge R750xa

Technical Guide

Notes, cautions, and warnings

 **NOTE:** A NOTE indicates important information that helps you make better use of your product.

 **CAUTION:** A CAUTION indicates either potential damage to hardware or loss of data and tells you how to avoid the problem.

 **WARNING:** A WARNING indicates a potential for property damage, personal injury, or death.

Chapter 1: System overview	5
Key workloads	5
New technologies	5
Chapter 2: System features and generational comparison	7
Chapter 3: Chassis views and features	9
Front view of the system	9
Rear view of the system	10
Inside the system	11
Quick Resource Locator	12
Chapter 4: Processor	13
Processor features	13
Supported processors	13
Chapter 5: Memory subsystem	15
Supported memory	15
Memory speed	15
Chapter 6: Storage	17
Storage controllers	17
Supported drives	17
External Storage	18
Chapter 7: Networking	19
Overview	19
Supported OCP cards	19
OCP NIC 3.0 vs. rack Network Daughter Card comparisons	19
SNAP I/O Support	20
SNAP Input Output value proposition	20
Chapter 8: PCIe subsystem	21
PCIe risers	21
Chapter 9: Power, thermal, and acoustics	25
Power	25
Thermal	26
Acoustics	26
Acoustical performance	26
Chapter 10: Rails information	28
Static rails	28

Sliding rails.....	28
Chapter 11: Supported Operating Systems.....	29
Chapter 12: Dell EMC OpenManage systems management.....	30
Server and Chassis Managers.....	31
Dell EMC consoles.....	31
Automation Enablers.....	31
Integration with third-party consoles.....	31
Connections for third-party consoles.....	31
Dell EMC Update Utilities.....	31
Dell resources.....	31
Chapter 13: Dell Technologies Services	33
Dell EMC ProDeploy Enterprise Suite	33
Dell EMC ProDeploy Plus.....	34
Dell EMC ProDeploy.....	34
Basic Deployment.....	34
Dell EMC Server Configuration Services.....	34
Dell EMC Residency Services.....	34
Dell EMC Remote Consulting Services.....	34
Dell EMC Data Migration Service.....	34
Dell EMC ProSupport Enterprise Suite.....	34
Dell EMC ProSupport Plus for Enterprise.....	35
Dell EMC ProSupport for Enterprise.....	35
Dell EMC ProSupport One for Data Center.....	36
ProSupport for HPC.....	36
Support Technologies.....	37
Dell Technologies Education Services.....	38
Dell Technologies Consulting Services.....	38
Dell EMC Managed Services.....	38
Chapter 14: Appendix A. Additional specifications.....	39
Chassis dimension.....	39
Chassis weight.....	39
Video specifications.....	40
USB Ports.....	40
PSU rating.....	41
Thermal restrictions.....	41
Environmental Specifications.....	44
Chapter 15: Appendix B. Standards compliance.....	46
Chapter 16: Appendix C Additional resources.....	47

System overview

The Dell™ PowerEdge™ R750xa is Dell's latest 2-socket, 2U rack servers purposely designed to run all GPU accelerated workloads by supporting the entire PCIe GPUs in Dell™ PowerEdge™ portfolio and using highly scalable memory, I/O, and network options. The systems feature the Intel Xeon Scalable Processor, support to up to 4 double-wide and 8 single-wide GPUs, up to 32 DIMMs, PCI Express® (PCIe) 4.0 enabled expansion slots, and a choice of network interface technologies to cover NIC.

Topics:

- [Key workloads](#)
- [New technologies](#)

Key workloads

The R750xa is purpose-built to support the most demanding GPU workloads such as:

- AI/ML/DL
- HPC - Simulation modeling
- VDI
- Database analytics
- Rendering and Media & Entertainment

New technologies

Table 1. New Technologies

Technology	Detailed Description
Intel Icelake processors	<ul style="list-style-type: none"> • Core Count up to 40 per processor • UPI Speeds: Up to 3x UPIs/Socket at 10.4GT/s or 11.2GT/s • Max number of PCIe Lanes: Integrated 64 PCIe 4.0 lanes @ 16GT/s PCIe Gen4 • Max TDP: Up to 270W
NVIDIA latest GPUs: A100 with NVLINK Bridges, A40, A30 and A10 AMD latest GPU: MI100	<ul style="list-style-type: none"> • New technologies by NVIDIA include: <ul style="list-style-type: none"> ○ New generation A100, A40 GPU cards deliver more than double the performance of previous generation ○ Multi-instance-GPU (MIG): every A100 GPU can be sliced for up to 7 virtual instances, to enable higher GPU utilization and workload flexibility ○ NVLINK bridges: communication links that connect a pair of A100 or A40 and enable interlinks in a speed of 600GB/s to boost large data sets training and other peer-to-peer intensive applications • New technologies by AMD include: <ul style="list-style-type: none"> ○ MI100 aims to deliver best-in-class single precision performance for HPC workloads
3200 MT/s DDR4 Memory	<ul style="list-style-type: none"> • Max 16 DIMM per CPU and 32 DIMMs in total • Supports DDR4 RDIMM, LRDIMM, 3DS DIMM and with ECC up to 3200 MT/s

Table 1. New Technologies (continued)

Technology	Detailed Description
Persistent Memory	<ul style="list-style-type: none">• Supports DDR4 Intel Optane Persistent Memory 200 Series up to 3200 MT/s, max 8x 512GB Intel Optane Persistent Memory 200 Series per socket
Flex IO	<ul style="list-style-type: none">• LOM board, 2x1Gb with BCM5720 LAN controller• Rear IO with 1Gb Dedicated Management Network Port, USB 3.0x1, USB 2.0x1 and VGA port• LC Rear IO with 1Gb Dedicated Management Network Port, USB 3.0x1, USB 2.0x1• OCP Mezz 3.0 (supported by x8 PCIe lanes)• Serial Port Option with STD Rear IO board• Serial Port or VGA Port option with LC Rear IO board
CPLD 1-wire	<ul style="list-style-type: none">• Support payload data of Front PERC, Riser, BOSS S2, BP and Rear IO to BIOS and iDRAC
Dedicated PERC	<ul style="list-style-type: none">• Front Storage module PERC with Front PERC10.5 & PERC11
Power Supplies	<ul style="list-style-type: none">• 86mm dimension is the new PSU form factor on 15G design• Platinum 1400W AC/HVDC• 2400W AC/HVDC

System features and generational comparison

The following table shows the comparison between the PowerEdge R750xa with the PowerEdge C4140:

Table 2. Features compared to previous version

Feature	PowerEdge R750xa	PowerEdge C4140
CPU	2x 3rd Generation Intel® Xeon® Processor Scalable Family	2x 2nd Generation Intel® Xeon® Processor Scalable Family
CPU Interconnect	Intel Ultra Path Interconnect (UPI)	Intel Ultra Path Interconnect (UPI)
GPU	2-4xDW GPUs (A100, A40, A30, A10, MI100) or 2-6xSW GPUs (T4)	Fixed offering: 4xDW GPUs (V100, V100S only)
GPU Interconnect	600GB/s NVLINK Bridges enabled for A100, A40	300GB/s NVLINK Board enabled for V100
Memory	32x DDR4 RDIMM, LRDIMM, 16x PMem (Intel Optane Persistent Memory 200 Series)	24x DDR4 RDIMM, LRDIMM
Storage Drives	Up to 8x2.5 inches SAS/SATA SSD or NVMe	N/A
Storage Controllers	Adapters: HBA355I, HBA355E, H345, H355, H745, H755, H755N, H840 BOSS S2 BOSS S1 SW RAID: S150	N/A
NVMe	Up to 8x NVMe drives	N/A
PCIe Slots	Max 8 PCIe 4.0 (up to 6 x16 slots)	Max 7 PCIe 3.0 (up to 4 x16 slots) 4xGPU and 3 rear (one dedicated to BOSS)
LOM	2x 1Gb	N/A
OCP 3.0	Max 1 OCP 3.0 (x8 PCIe)	N/A
USB Ports	Front: 1 port (USB 2.0), 1 dedicated (micro-USB) Rear: 2 ports (Bottom: USB 3.0, Top: USB 2.0) Internal: 1 port (USB 3.0) for IDSDM/internal USB cards up-sell option	Front: 2 ports (USB 2.0), 1 managed (micro-USB) Rear: 2 ports (USB 3.0) Internal: 1 port (USB 3.0)
Thermals	Standard thermal limitation (up to 35C)	Some configs are limited to 20C
Rack Height	2U	1U

Table 2. Features compared to previous version (continued)

Feature	PowerEdge R750xa	PowerEdge C4140
Power Supplies	1400W, 2400W	1400W, 2400W

Chassis views and features

Topics:

- Front view of the system
- Rear view of the system
- Inside the system
- Quick Resource Locator

Front view of the system

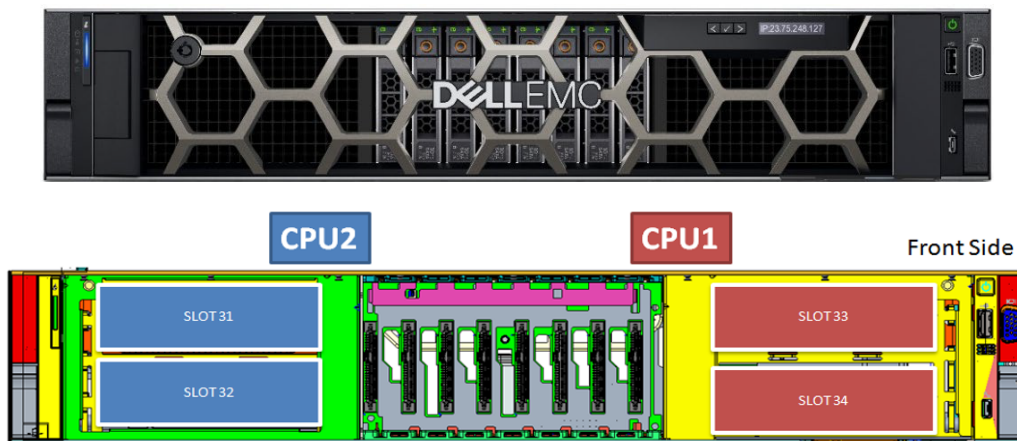

Figure 1. Front view of the R750xa (front riser slot numbering)

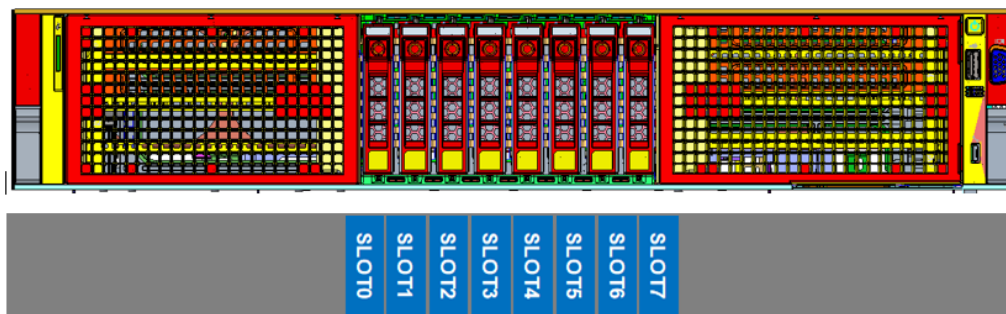

Figure 2. Front view of the R750xa with x8 SAS/SATA SSD on x8 NVMe

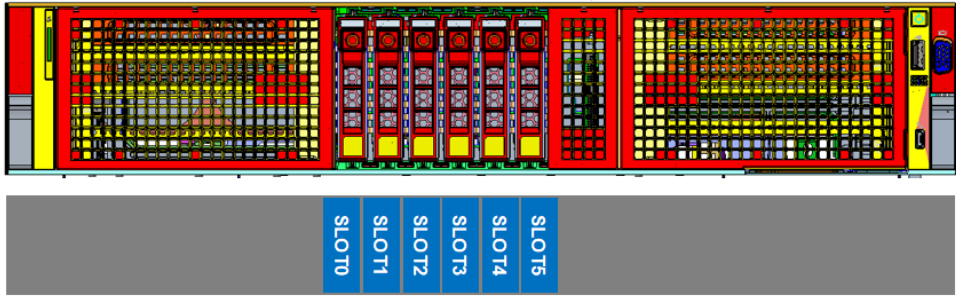

Figure 3. Front view of the R750xa with x6 NVMe direct attached

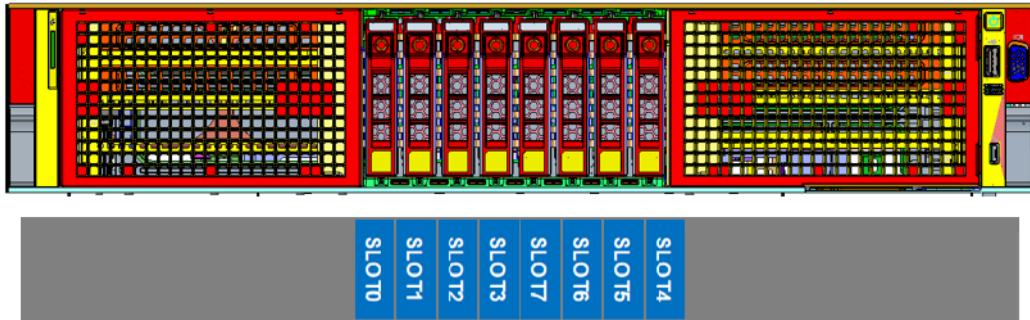

Figure 4. Front view of the R750xa with x8 Universal slots (slots 4-7 are universal)

Rear view of the system

There are only 4 storage configurations in the R750xa, which comprise two backplane options (config 0, config1):

1. Up to 8x SAS/SATA SSD in a RAID config
2. Up to 8x NVMe in a RAID config
3. Up to 6x NVMe direct attach
4. Up to 4x SAS/SATA SSD in a RAID config + Up to 4x NVMe direct attach

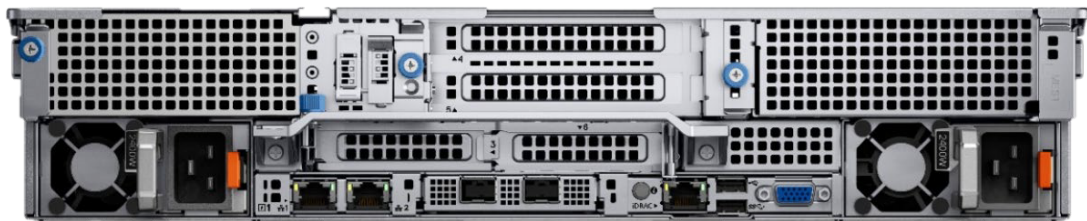

Figure 5. Rear view of the R750xa

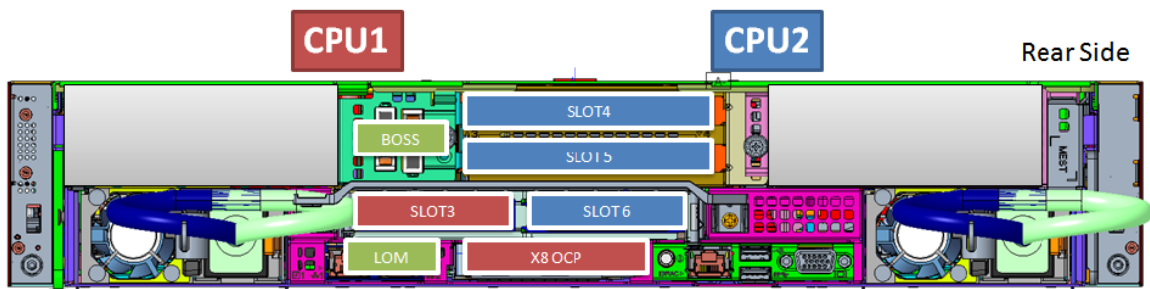

Figure 6. Rear riser slot numbering

Config0. 1U/2U R2A (2 x16 LP/Hirose/CPU1/2) + 2U Riser R3B (2 x 8 FH/Hirose/CPU2)



Figure 7. Rear view of the system with riser config 0: direct attach NVMe cards (either 6x NVMe direct attach or 4x NVMe direct attach + 4 Universal slots)

Config1. 1U/2U R2A (2 x16 LP/Hirose/CPU1/2) + R3-paddlecard for XA cable support 4x NVMe

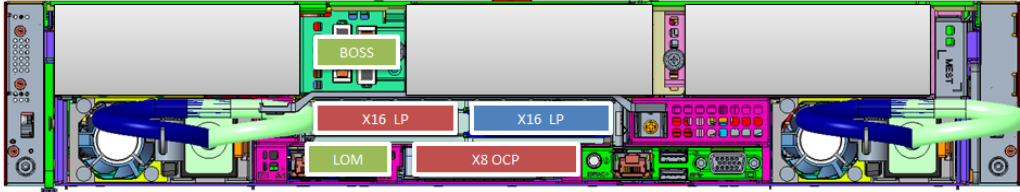

Figure 8. Rear view of the system with riser config 1: SAS/SATA SSD only or NVMe RAID (not direct attach)

Inside the system

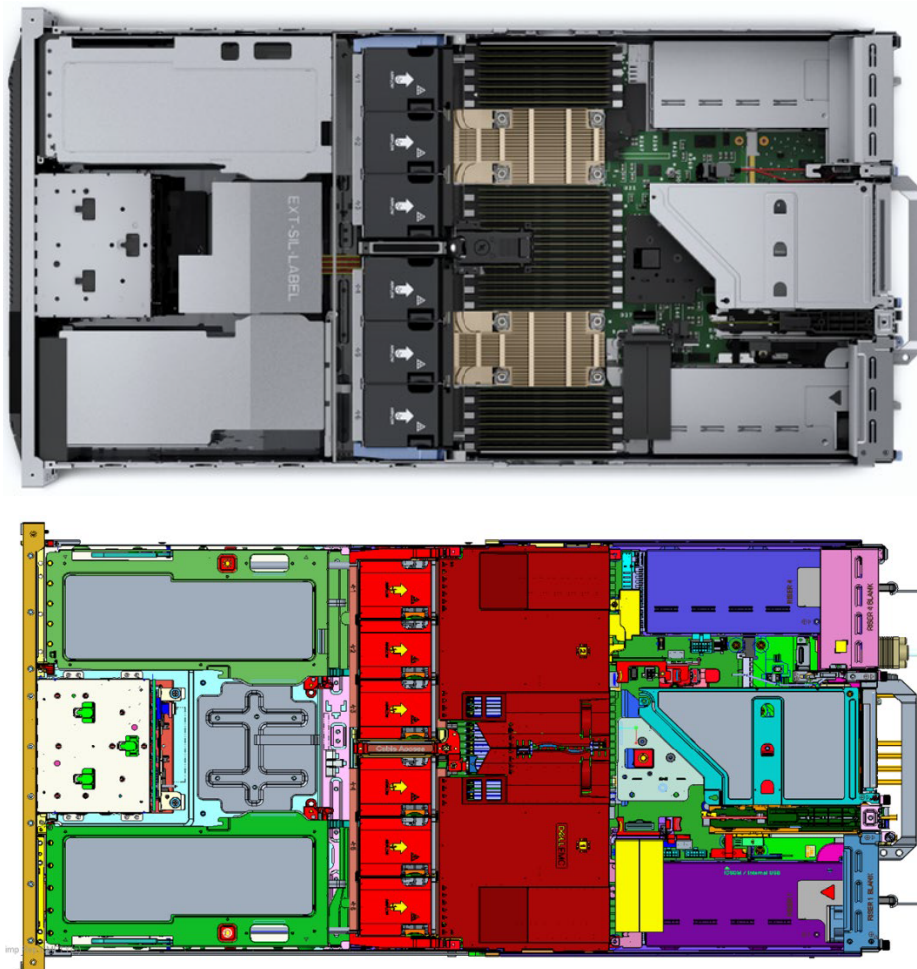

Figure 9. Inside the system R750xa Shroud +R3 riser

Quick Resource Locator

The QRL on everything (SILs, GSG, Installation and Service Manual except on the EST) is a generic QRL for R750xa that leads to a webpage for that product. That webpage has links for things like setup and service videos, iDRAC manual, and other things that apply to the platform. The QRL on the EST is unique and specific to that service tag and will contain the Service Tag number and the iDRAC password. The label and the QRL code within it are printed on demand at the L10 factories. This QRL links to a webpage that shows the exact configuration as built for that customer, and the specific warranty purchased. It is one click away from the same content of generic information that applies to R750xa that is available in the other QRLs.



Figure 10. Quick Resource Locator for R750xa

Processor

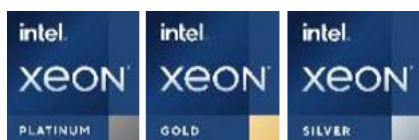

Topics:

- [Processor features](#)
- [Supported processors](#)

Processor features

The 3rd Generation Xeon Scalable Processors stack is next generation data center CPU offering with the latest features, increased performance, and incremental memory options. This latest generation Xeon Scalable processor will support usages from entry designs based on Intel Xeon Silver processors to advanced capabilities offered in new Intel Xeon Platinum processor.

The following lists the features and functions included in the upcoming 3rd Generation Intel Xeon Scalable Processor offering:

- Faster UPI with 3 Intel Ultra Path Interconnect (Intel UPI) at 11.2 GT/s (supported in gold and platinum options)
- More, Faster I/O with PCI Express 4 and up to 64 lanes (per socket) at 16 GT/s
- Enhanced Memory Performance with support for up to 3200MT/s DIMMs (2 DPC)
- Increased Memory Capacity with up to 8 channels and up to 256GB DDR4 DIMM support
- Breakthrough System Memory with Intel Optane persistent memory 200 series (Intel Optane Persistent Memory 200 Series, up to 512GB modules (up to 6TB of total system memory/socket DDR+PMM))

Supported processors

The following table lists the supported processors for R750xa:

Table 3. CPU Bin Stack for R750xa

Proc	Clock Speed (GHz)	Cache (M)	UPI (GT/s)	Cores	Threads	Turbo	Memory Speed (MT/s)	Memory Capacity	Optane Memory Capable	TDP
8380	2.3	60	11.2	40	80	Turbo	3200	6TB	Y	270W
8368	2.4	57	11.2	38	76	Turbo	3200	6TB	Y	270W
8362	2.8	48	11.2	32	64	Turbo	3200	6TB	Y	265W
8358	2.6	48	11.2	32	64	Turbo	3200	6TB	Y	250W
8358P	2.6	48	11.2	32	64	Turbo	3200	6TB	Y	240W
8352S	2.2	48	11.2	32	64	Turbo	3200	6TB	Y	205W
8352M	2.3	48	11.2	32	64	Turbo	3200	6TB	Y	185W
6342	2.8	36	11.2	24	48	Turbo	3200	6TB	Y	230W
6338	2	36	11.2	32	64	Turbo	3200	6TB	Y	205W
6334	3.6	18	11.2	8	16	Turbo	3200	6TB	Y	165W
6330	2	42	11.2	28	56	Turbo	3200	6TB	Y	205W

Table 3. CPU Bin Stack for R750xa (continued)

Proc	Clock Speed (GHz)	Cache (M)	UPI (GT/s)	Cores	Threads	Turbo	Memory Speed (MT/s)	Memory Capacity	Optane Memory Capable	TDP
6326	2.9	24	11.2	16	32	Turbo	3200	6TB	Y	185W
5320	2.2	39	11.2	26	52	Turbo	2933	6TB	Y	158W
5318S	2.1	36	11.2	24	48	Turbo	2933	6TB	Y	165W
5317	3	18	11.2	12	24	Turbo	2933	6TB	Y	150W
4316	2.3	30	10.4	20	40	Turbo	2667	6TB	N	150W
4314	2.4	24	10.4	16	32	Turbo	2666	6TB	Y	135W
4310	2.1	18	10.4	12	24	Turbo	2666	6TB	N	120W
4309Y	2.8	12	10.4	8	16	Turbo	2666	6TB	N	105W

Memory subsystem

The R750xa supports up to 32 DIMMs, with maximum capacity around 10TB per system for 8x 512GB Intel Optane Persistent Memory 200 Series and 8x 128GB LRDIMM connected to per CPU and speeds of up to 3200MT/s.

The R750xa supports registered (RDIMMs) and load reduced DIMMs (LRDIMMs) which use a buffer to reduce memory loading and provide greater density, allowing for the maximum platform memory capacity. Unbuffered DIMMs (UDIMMs) are not supported.

Topics:

- [Supported memory](#)
- [Memory speed](#)

Supported memory

The table below lists the memory technologies supported by the platform.

Table 4. Memory technology comparison

Feature	PowerEdge R750xa (DDR4)	C4140 (DDR4)
DIMM type	RDIMM	RDIMM
	LRDIMM (DDP/3DS)	LRDIMM
	3DS (Intel Optane Persistent Memory 200 Series)	Not Supported
Transfer speed	3200 MT/s	2667 MT/s
	2933 MT/s	2400 MT/s
	2666 MT/s	2133 MT/s
	N/A	1866 MT/s
Voltage	1.2 V	1.2 V

The following table lists the supported DIMMs for the R750xa at launch. For the latest information on supported DIMMS, refer to the [Memory NDA Deck](#). For specific memory configuration information, please refer to the User Manual.

Memory speed

The table below lists the memory configuration and performance details for R750xa based on the quantity and type of DIMMs per memory channel.

Table 5. DIMM performance details

DIMM Type	DIMM Ranking	Capacity	DIMM Rated Voltage, Speed	15G ICX	
				1 DPC	2 DPC
RDIMM	1R	8GB	DDR4 (1.2V), 3200	D: 3200	D: 3200
RDIMM	2R	16GB, 32GB, 64GB	DDR4 (1.2V), 3200	D: 3200	D: 3200
LRDIMM	4R	128GB	DDR4 (1.2V), 3200	D: 3200	D: 3200

 **NOTE:** D = Dell POR

Storage

Topics:

- [Storage controllers](#)
- [Supported drives](#)
- [External Storage](#)

Storage controllers

Dell's RAID controller options offer performance improvements, including the fPERC solution. fPERC provides a base RAID HW controller without consuming a PCIe slot by using a small form factor and high-density connector to the base planar.

15G PERC Controller offerings will be a heavy leverage of 14G PERC family. The Value and Value Performance levels will carry over to 15G from 14G. New to 15G, is the Harpoon-based Premium Performance tier offering. This high-end offering will drive IOPs performance and enhanced SSD performance.

Table 6. PERC Series Controller Offerings

Performance Level	Controller and Description
Entry	S150 (SATA, NVMe) SW RAID SATA, NVMe
Value	H345, H355, HBA355 (Internal/External)
Value Performance	H745, H755, H755N
Premium Performance	H840 Harpoon Chip (LSI 3508) Memory: 8GB DDR4 NV cache 72-bit memory 2133MHz Low profile form factors Dual A15 1.2GHz CPU X8PCIe 3.0, x8 12Gb SAS

Supported drives

The table shown below lists the internal drives supported by the R750xa. Refer to Agile for the latest SDL.

Table 7. Supported drives

Form Factor	Type	Speed	Rotational Speed	Capacities
2.5 inches	SAS	12 Gb	SSD	400 GB, 480 GB, 800 GB, 960 GB, 1.6 TB, 1.92 TB, 3.2 TB, 3.84 TB, 6.4 TB, 7.68 TB, 12.8 TB, 15.36 TB, 30.72 TB
M.2	SATA	6 Gb	SSD	240 GB, 480 GB

Table 7. Supported drives (continued)

Form Factor	Type	Speed	Rotational Speed	Capacities
U.2	NVMe	NA	SSD	960 GB, 1.6 TB, 1.92 TB, 3.2 TB, 3.84 TB, 6.4 TB, 7.68 TB, 12.8 TB, 15.36 TB
uSD	NA	NA	NA	16 GB, 32 GB, 64 GB

External Storage

The R750xa support the external storage device types listed in the table below.

Table 8. Support External Storage Devices

Device Type	Description
External Tape	Supports connection to external USB tape products
NAS/IDM appliance software	Supports NAS software stack
JBOD	Supports connection to 12Gb MD14xx and ME484 JBODs

Networking

Topics:

- [Overview](#)
- [Supported OCP cards](#)
- [SNAP I/O Support](#)

Overview

PowerEdge offers a wide variety of options to get information moving to and from our servers. Industry best technologies are chosen and systems management features are added by our partners to firmware to tie in with iDRAC and Lifecycle Controller. These adapters are rigorously validated for worry-free, fully supported use in our servers.

The Server Adapter Matrix posted to our knowledge portal is the central repository for PowerEdge NIC, HBA and HCA information. The matrix covers:

- Part Numbers, Tied SKUs and Customer Kits
- Server Compatibility & Support
- Optics & Cable Support
- Systems Management
- Adapter Features
- Spec Sheet Links

This document is updated as changes happen, so be sure to bookmark it rather than downloading an offline copy to stay with the latest information.

[PowerEdge Server Adapter Matrix](#)

 **NOTE:** This is a direct download link to an .XLSX, and may not open in a tab as expected depending on your browser.

Supported OCP cards

OCP NIC 3.0 vs. rack Network Daughter Card comparisons

Table 9. R750xa OCP 3.0, 2.0, and rNDC NIC Comparison

Form Factor	Dell rNDC	OCP 2.0 (LOM Mezz)	OCP 3.0	Note
PCIe Gen	Gen 3	Gen 3	Gen 4	Supported OCP3 are SFF (small form factor)
Max PCIe Lanes	x8	Up to x16	Up to x16	See server slot priority matrix
Shared LOM	Yes	Yes	Yes	This is iDRAC port redirect
Aux Power	Yes	Yes	Yes	Used for Shared LOM

SNAP I/O Support

SNAP Input Output value proposition

Dual-socket servers offer ample compute power to meet the needs of a wide range of workloads. However, if the network adapters in the system are unbalanced, users may be at risk of creating a bottleneck that will reduce bandwidth and increase latency. SNAP I/O is a solution which leverages Mellanox socket direct technology to balance I/O performance without increasing the TCO. By allowing both processors to share one adapter, data can avoid traversing the UPI inter-processor link when accessing remote memory

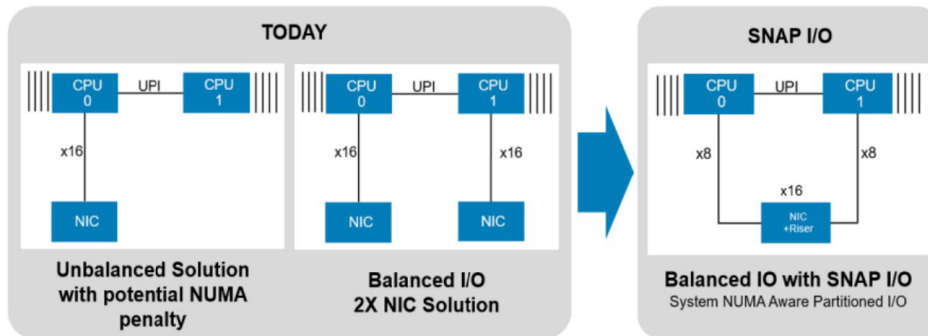

Figure 11. Comparing an unbalanced one-NIC solution and a balanced two-NIC solution to a SNAP I/O one-NIC solution

The SNAP I/O solution on the right allows CPU 0 and 1 to communicate to their corresponding NIC card without traversing the UPI channels, therefore reducing latency/TCO and freeing up UPI bandwidth for applications.

PCIe subsystem

Topics:

- PCIe risers

PCIe risers

For a full list of supported cards and slot priority, please see the PCIe Slot Priority Matrix found in Agile. Slot Priority Matrix Agile P/N: [WR2CY](#).

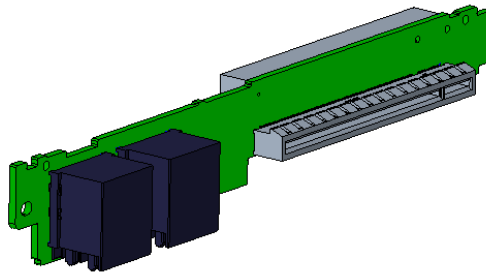

Figure 12. RSR2A, DPN: 3FJFH

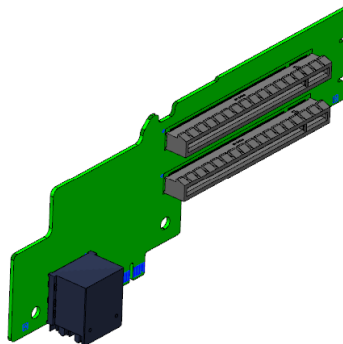

Figure 13. RSR3B, DPN: 5HC7T

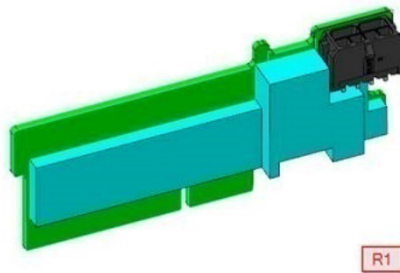

Figure 14. R1 paddle, DPN: 29CH8

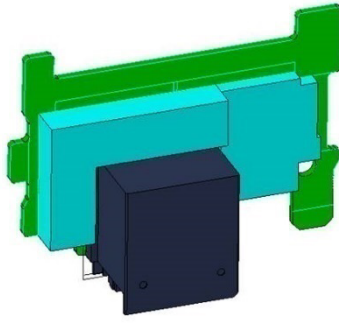

Figure 15. R3 paddle, DPN: PFYP2

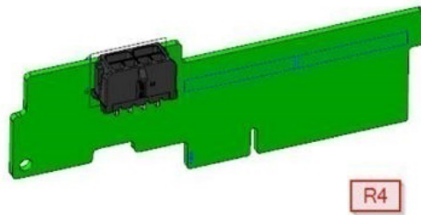

Figure 16. R4 paddle, DPN: MDVFJ

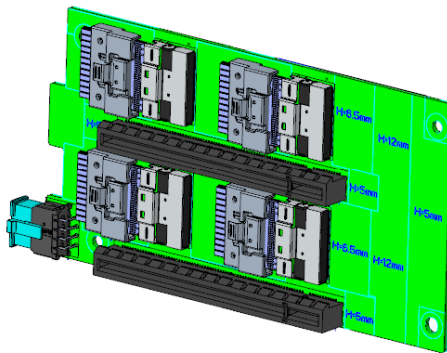

Figure 17. GPU RISER R slot 33/34, DPN: 3YJ8R

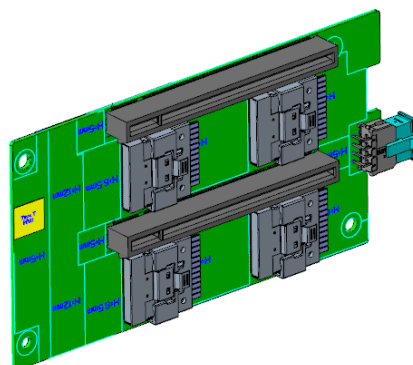

Figure 18. GPU RISER L slot 31/32, DPN: RHJNM

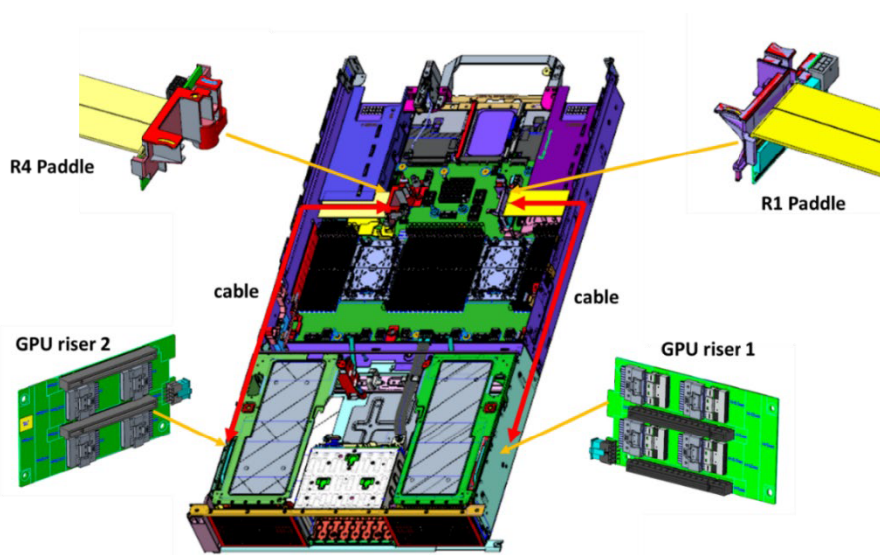

Figure 19. GPU Riser ½ connection with R1/R4 paddle by cables

The table below is a matrix showing PCIe card support and which CPU supports these cards:

Table 10. PCIe Riser Slot CPU Orientation Matrix for R750xa

			CPU1				CPU2			
Location	Card Support	Card Support	XAR1 paddle + GPU Riser R		R2a		R3b	R3 paddle	XA R4 paddle + GPU Riser L	
Agile p/n	Regular Shroud	GPGPU Shroud	29CH8 + 3YJ8R		3FJFH		5HC7T	PFYP2	MDVFJ + RHJNM	
PCIe Slot -3	LP-HL	LP-HL	—	—	X16		—	—	—	—
PCIe Slot -4	FH-HL	FH-HL	—	—	—	—	—	X8	—	—
PCIe Slot -5	FH-HL	FH-HL	—	—	—	—	—	X8	—	—
PCIe Slot -6	LP-HL	LP-HL	—	—	—	—	X16		—	—
PCIe Slot -31	FH-HL	SW/DW-HL	—	—	—	—	—	—	—	X16
PCIe Slot -32	FH-HL	SW/DW-HL	—	—	—	—	—	—	—	X16
PCIe Slot -33	FH-HL	SW/DW-HL	X16	—	—	—	—	—	—	—
PCIe Slot -34	FH-HL	SW/DW-HL	—	X16	—	—	—	—	—	—

Table 11. Riser Offerings

RSR Configuration	# of CPUs	PERC type supported	Rear Storage Possible
R1 paddle + R2a + R3b + R4 paddle	2	fPERC	No

Table 11. Riser Offerings (continued)

RSR Configuration	# of CPUs	PERC type supported	Rear Storage Possible
R1 paddle + R2a + R3 paddle + R4 paddle to support 4x NVMe	2	fPERC	No

Power, thermal, and acoustics

PowerEdge servers have an extensive collection of sensors that automatically track thermal activity, which helps regulate temperature thereby reducing server noise and power consumption. The table below lists the tools and technologies Dell offers to lower power consumption and increase energy efficiency.

Topics:

- [Power](#)
- [Thermal](#)
- [Acoustics](#)

Power

Table 12. Power tools and technologies

Feature	Description
Power Supply Units (PSU) portfolio	Dell's PSU portfolio includes intelligent features such as dynamically optimizing efficiency while maintaining availability and redundancy. Find additional information in the Power supply units section of the R750xa source book.
Industry Compliance	Dell's servers are compliant with all relevant industry certifications and guidelines, including 80 PLUS, Climate Savers, and ENERGY STAR.
Power monitoring accuracy	PSU power monitoring improvements include: <ul style="list-style-type: none"> • Dell's power monitoring accuracy is currently 1%, whereas the industry standard is 5% • More accurate reporting of power • Better performance under a power cap
Power capping	Use Dell's systems management to set the power cap limit for your systems to limit the output of a PSU and reduce system power consumption.
Systems Management	iDRAC Enterprise provides server- level management that monitors, reports, and controls power consumption at the processor, memory, and system level. Dell OpenManage Power Center delivers group power management at the rack, row, and data center level for servers, power distribution units, and uninterruptible power supplies.
Rack infrastructure	Dell offers some of the industry's highest- efficiency power infrastructure solutions, including: <ul style="list-style-type: none"> • Power distribution units (PDUs) • Uninterruptible power supplies (UPSs) • Energy Smart containment rack enclosures

Thermal

PowerEdge servers have an extensive collection of sensors that automatically track thermal activity, which helps regulate temperature thereby reducing server noise and power consumption.

Acoustics

Acoustical performance

Acoustical performance is provided in terms of one configuration: Details are provided in table - Acoustical Reference Points and Output Comparisons for GPU configuration; acoustical performance data for this configuration is included in below table. Each configuration has been tested according to Dell EMC acoustical standards for rack-mounted servers.

Table 13. Acoustical configurations of R750xa

Configuration	Typical
CPU Type	Intel
CPU TDP / Cores	185W / 16C
CPU Quantity	2
RDIMM Memory	16GB, DDR4
Memory Quantity	24
Backplane Type	8x 2.5 inches BP
SSD Type	NVMe
SSD Quantity	8
PSU Type	2400W
PSU Quantity	2
OCP	Dual Port 10GbE
PCI 1	GPU 300W
PCI 2	GPU 300W
PCI 3	GPU 300W
PCI 4	GPU 300W
Front PERC	H755

Table 14. Acoustical performance of R750xa acoustical configurations

Configuration	Typical	
Acoustical Performance: Idle/ Operating @ 25 °C Ambient		
L _{WA,m} (B)	Idle	6.2
	Operating	6.2
K _v (B)	Idle	0.4
	Operating	0.4
L _{pA,m} (dB)	Idle	53
	Operating	53

Table 14. Acoustical performance of R750xa acoustical configurations (continued)

Configuration	Typical
Prominent tones	No prominent tones in Idle and Operating
Acoustical Performance: Idle @ 28 °C Ambient	
L _{wA,m} (B)	6.7
K _v (B)	0.4
L _{pA,m} (dB)	55
Acoustical Performance: Max. Loading @ 35 °C Ambient	
L _{wA,m} (B)	9.0
K _v (B)	0.4
L _{pA,m} (dB)	79

i NOTE:

- L_{wA,m}: The declared mean A-weighted sound power level (L_{wA}) is calculated per section 5.2 of ISO 9296 (2017) with data collected using the methods described in ISO 7779 (2010). Data presented here may not be fully compliant with ISO 7779.
- L_{pA,m}: The declared mean A-weighted emission sound pressure level is at the bystander position per section 5.3 of ISO 9296 (2017) and measured using methods described in ISO 7779 (2010). The system is placed in a 24U rack enclosure, 25cm above a reflective floor. Data presented here may not be fully compliant with ISO 7779.
- Prominent tones: Criteria of D.6 and D.11 of ECMA-74 (17th ed., Dec. 2019) are followed to determine if discrete tones are prominent and to report them, if so.
- Idle mode: The steady-state condition in which the server is energized but not operating any intended function.
- Operating mode: The maximum of the steady state acoustical output at 50% of CPU TDP or active SSDs per C.9.3.2 in ECMA-74 (17th ed., Dec. 2019).

The following table describes the acoustic performance of the R750xa server:

Table 15. Acoustic Performance of the R750xa Server

R750xa configs	Typical
Acoustical Target	Cat. 4
CPU	Gold 6-Series
Memory	24 x 16GB RDIMM
Storage Configuration: Front, Internal, Rear, PCIe	8 X 2.5 inches NVMe
Cards	3x 300W DW GPU H755 OCP+ 2x25G; LOM Down, 1-GB

Rails information

The R750xa support both sliding rails and static rails. Both rails have a slim rail design that supports the wide system chassis.

Topics:

- [Static rails](#)
- [Sliding rails](#)

Static rails

The static rails (shown in the figure below) support a wider variety of racks than the sliding rails, but do not support serviceability in the rack and are not compatible with the SRB.

Ready Rails Static Rails for 4-post & 2-post Racks:

- Supports Stab-in installation of the chassis to the rails.
- Support tool-less installation in 19 inches EIA-310-E compliant square or unthreaded round hole 4-post racks including all generations of Dell racks
- Support tooled installation in 19 inches EIA-310-E compliant threaded hole 4-post and 2-post racks

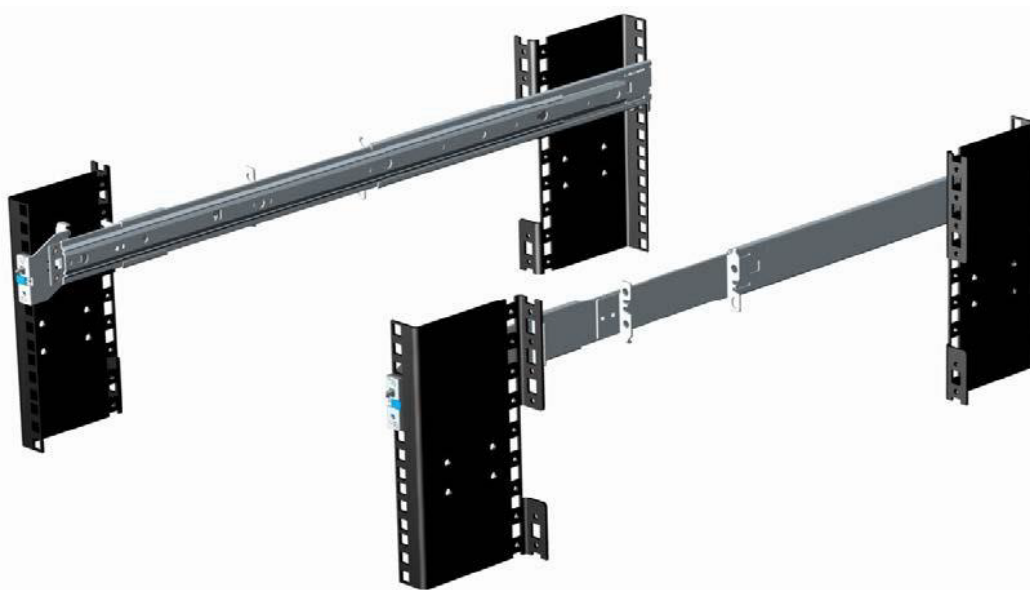

Figure 20. R750xa Static Rails

Sliding rails

TBD

Supported Operating Systems

The following lists the supported operating systems for the R750xa:

- Canonical(R) Ubuntu(R) Server LTS
- Citrix(R) Hypervisor (R)
- Microsoft(R) Windows Server(R) with Hyper-V
- Red Hat(R) Enterprise Linux
- SUSE(R) Linux Enterprise server
- VMware(R) ESXi(R)

The link to the specific OS versions and editions, certification matrices, Hardware Compatibility Lists (HCL) portal, and Hypervisor support can be found at [Dell EMC Enterprise Operating Systems](#).

Dell EMC OpenManage systems management

Dell EMC OpenManage Portfolio

Simplifying hardware management through ease of use and automation

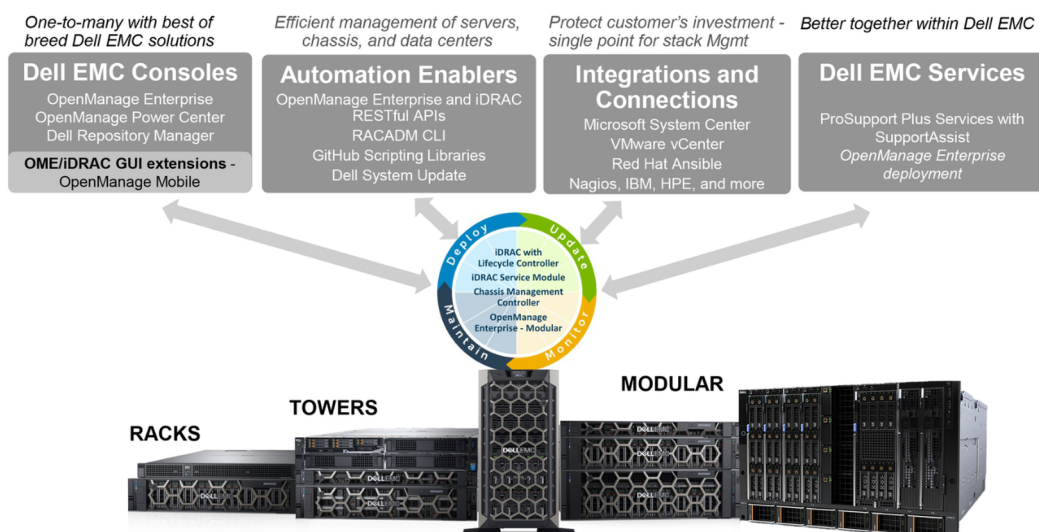

Figure 21. Dell EMC OpenManage Portfolio

Dell EMC delivers management solutions that help IT Administrators effectively deploy, update, monitor, and manage IT assets. OpenManage solutions and tools enable you to quickly respond to problems by helping them to manage Dell EMC servers effectively and efficiently; in physical, virtual, local, and remote environments, operating in-band, and out-of-band (agent-free). The OpenManage portfolio includes innovative embedded management tools such as the integrated Dell Remote Access Controller (iDRAC), Chassis Management Controller and Consoles like OpenManage Enterprise, OpenManage Power Manager plug in, and tools like Repository Manager.

Dell EMC has developed comprehensive systems management solutions based on open standards and has integrated with management consoles that can perform advanced management of Dell hardware. Dell EMC has connected or integrated the advanced management capabilities of Dell hardware into offerings from the industry's top systems management vendors and frameworks such as Ansible, thus making Dell EMC platforms easy to deploy, update, monitor, and manage.

The key tools for managing Dell EMC PowerEdge servers are iDRAC and the one-to-many OpenManage Enterprise console. OpenManage Enterprise helps the system administrators in complete lifecycle management of multiple generations of PowerEdge servers. Other tools such as Repository Manager, which enables simple yet comprehensive change management.

OpenManage tools integrate with systems management framework from other vendors such as VMware, Microsoft, Ansible, and ServiceNow. This enables you to use the skills of the IT staff to efficiently manage Dell EMC PowerEdge servers.

Topics:

- [Server and Chassis Managers](#)
- [Dell EMC consoles](#)
- [Automation Enablers](#)
- [Integration with third-party consoles](#)
- [Connections for third-party consoles](#)
- [Dell EMC Update Utilities](#)
- [Dell resources](#)

Server and Chassis Managers

- Integrated Dell Remote Access Controller (iDRAC)
- iDRAC Service Module (iSM)

Dell EMC consoles

- Dell EMC OpenManage Enterprise
- Dell EMC Repository Manager (DRM)
- Dell EMC OpenManage Enterprise Power Manager plugin to OpenManage Enterprise
- Dell EMC OpenManage Mobile (OMM)

Automation Enablers

- OpenManage Ansible Modules
- iDRAC RESTful APIs (Redfish)
- Standards-based APIs (Python, PowerShell)
- RACADM Command Line Interface (CLI)
- GitHub Scripting Libraries

Integration with third-party consoles

- Dell EMC OpenManage Integrations with Microsoft System Center
- Dell EMC OpenManage Integration for VMware vCenter (OMIVV)
- Dell EMC OpenManage Ansible Modules
- Dell EMC OpenManage Integration with ServiceNow

Connections for third-party consoles

- Micro Focus and other HPE tools
- OpenManage Connection for IBM Tivoli
- OpenManage Plug-in for Nagios Core and XI

Dell EMC Update Utilities

- Dell System Update (DSU)
- Dell EMC Repository Manager (DRM)
- Dell EMC Update Packages (DUP)
- Dell EMC Server Update Utility (SUU)
- Dell EMC Platform Specific Bootable ISO (PSBI)

Dell resources

For additional information about white papers, videos, blogs, forums, technical material, tools, usage examples, and other information, go to the OpenManage page at <https://www.dell.com/openmanagemanuals> or the following product pages:

Table 16. Dell resources

Resource	Location
Integrated Dell Remote Access Controller (iDRAC)	https://www.dell.com/idracmanuals
iDRAC Service Module (iSM)	https://www.dell.com/support/kbdoc/000178050/
OpenManage Ansible Modules	https://www.dell.com/support/kbdoc/000177308/
OpenManage Essentials (OME)	https://www.dell.com/support/kbdoc/000175879/
OpenManage Mobile (OMM)	https://www.dell.com/support/kbdoc/000176046
OpenManage Integration for VMware vCenter (OMIVV)	https://www.dell.com/support/kbdoc/000176981/
OpenManage Integration for Microsoft System Center (OMIMSSC)	https://www.dell.com/support/kbdoc/000147399
Dell EMC Repository Manager (DRM)	https://www.dell.com/support/kbdoc/000177083
Dell EMC System Update (DSU)	https://www.dell.com/support/kbdoc/000130590
Dell EMC Platform Specific Bootable ISO (PSBI)	Dell.com/support/article/sln296511
Dell EMC Chassis Management Controller (CMC)	www.dell.com/support/article/sln311283
OpenManage Connections for Partner Consoles	https://www.dell.com/support/kbdoc/000146912
OpenManage Enterprise Power Manager	https://www.dell.com/support/kbdoc/000176254
OpenManage Integration with ServiceNow (OMISNOW)	Dell.com/support/article/sln317784

 **NOTE:** Features may vary by server. Please refer to the product page on <https://www.dell.com/manuals> for details.

Dell Technologies Services

Dell Technologies Services include a wide, customizable range of service choices to simplify the assessment, design, implementation, management and maintenance of IT environments and to help you transition from platform to platform. Depending on your current business requirements and the level of service right for you, we provide factory, on-site, remote, modular, and specialized services that fit your needs and budget. We'll help with a little or a lot—your choice—and provide access to our global resources.

For more information, see DellEMC.com/Services.

Topics:

- [Dell EMC ProDeploy Enterprise Suite](#)
- [Dell EMC Remote Consulting Services](#)
- [Dell EMC Data Migration Service](#)
- [Dell EMC ProSupport Enterprise Suite](#)
- [Dell EMC ProSupport Plus for Enterprise](#)
- [Dell EMC ProSupport for Enterprise](#)
- [Dell EMC ProSupport One for Data Center](#)
- [ProSupport for HPC](#)
- [Support Technologies](#)
- [Dell Technologies Education Services](#)
- [Dell Technologies Consulting Services](#)
- [Dell EMC Managed Services](#)

Dell EMC ProDeploy Enterprise Suite

ProDeploy Enterprise Suite gets your server out of the box and into optimized production—fast. Our elite deployment engineers with broad and deep experience utilizing best-in-class processes along with our established global scale can help you around the clock and around the globe. From simple to the most complex server installations and software integration, we take the guess work and risk out of deploying your new server technology.

		Basic Deployment	ProDeploy	ProDeploy Plus
Pre-deployment	Single point of contact for project management	-	●	In-region
	Site readiness review	-	●	●
	Implementation planning	-	●	●
	SAM engagement for ProSupport Plus entitled devices	-	-	●
Deployment	Deployment service hours	Business hours	24x7	24x7
	Remote guidance for hardware installation or Onsite hardware installation and packaging material removal	Onsite	Remote or Onsite	Onsite
	Install and configure system software	-	Remote	Onsite
	Install support software and connect with Dell Technologies	-	●	●
	Project documentation with knowledge transfer	-	●	●
Post-deployment	Deployment verification	-	●	●
	Configuration data transfer to Dell EMC technical support	-	●	●
	30-days of post-deployment configuration assistance	-	-	●
	Training credits for Dell EMC Education Services	-	-	●

Figure 22. ProDeploy Enterprise Suite capabilities

NOTE: Hardware installation not applicable on selected software products.

Dell EMC ProDeploy Plus

From beginning to end, ProDeploy Plus provides the skill and scale needed to successfully execute demanding deployments in today's complex IT environments. Certified Dell EMC experts start with extensive environmental assessments and detailed migration planning and recommendations. Software installation includes set up of most versions of Dell EMC SupportAssist and OpenManage system management utilities. Post-deployment configuration assistance, testing, and product orientation services are also available.

Dell EMC ProDeploy

ProDeploy provides full service installation and configuration of both server hardware and system software by certified deployment engineers including set up of leading operating systems and hypervisors as well as most versions of Dell EMC SupportAssist and OpenManage system management utilities. To prepare for the deployment, we conduct a site readiness review and implementation planning exercise. System testing, validation, and full project documentation with knowledge transfer complete the process.

Basic Deployment

Basic Deployment delivers worry-free professional installation by experienced technicians who know Dell EMC servers inside and out.

Dell EMC Server Configuration Services

With Dell EMC Rack Integration and other Dell EMC PowerEdge Server Configuration Services, you save time by receiving your systems racked, cabled, tested, and ready to integrate into the data center. Dell EMC staff pre-configure RAID, BIOS and iDRAC settings, install system images, and even install third-party hardware and software.

For more information, see [Server Configuration Services](#).

Dell EMC Residency Services

Residency Services helps customers transition to new capabilities quickly with the assistance of on-site or remote Dell EMC experts whose priorities and time you control. Residency experts can provide post implementation management and knowledge transfer related to a new technology acquisition or day-to-day operational management of the IT infrastructure.

Dell EMC Remote Consulting Services

When you are in the final stages of your PowerEdge server implementation, you can rely on Dell EMC Remote Consulting Services and our certified technical experts to help you optimize your configuration with best practices for your software, virtualization, server, storage, networking, and systems management.

Dell EMC Data Migration Service

Protect your business and data with our single point of contact to manage your data migration project. Your project manager will work with our experienced team of experts to create a plan using industry-leading tools and proven processes based on global best practices to migrate your existing files and data so your business system get up and running quickly and smoothly.

Dell EMC ProSupport Enterprise Suite

With the ProSupport Enterprise Suite, we help keep your IT systems running smoothly, so you can focus on running your business. We will help maintain peak performance and availability of your most essential workloads. ProSupport Enterprise Suite is a suite of support services that enable you to build the solution that is right for your organization.

Choose support models based on how you use technology and where you want to allocate resources. From the desktop to the data center, address everyday IT challenges, such as unplanned downtime, mission-critical needs, data and asset protection, support planning, resource allocation, software application management and more. Optimize IT resources by choosing the right support model.

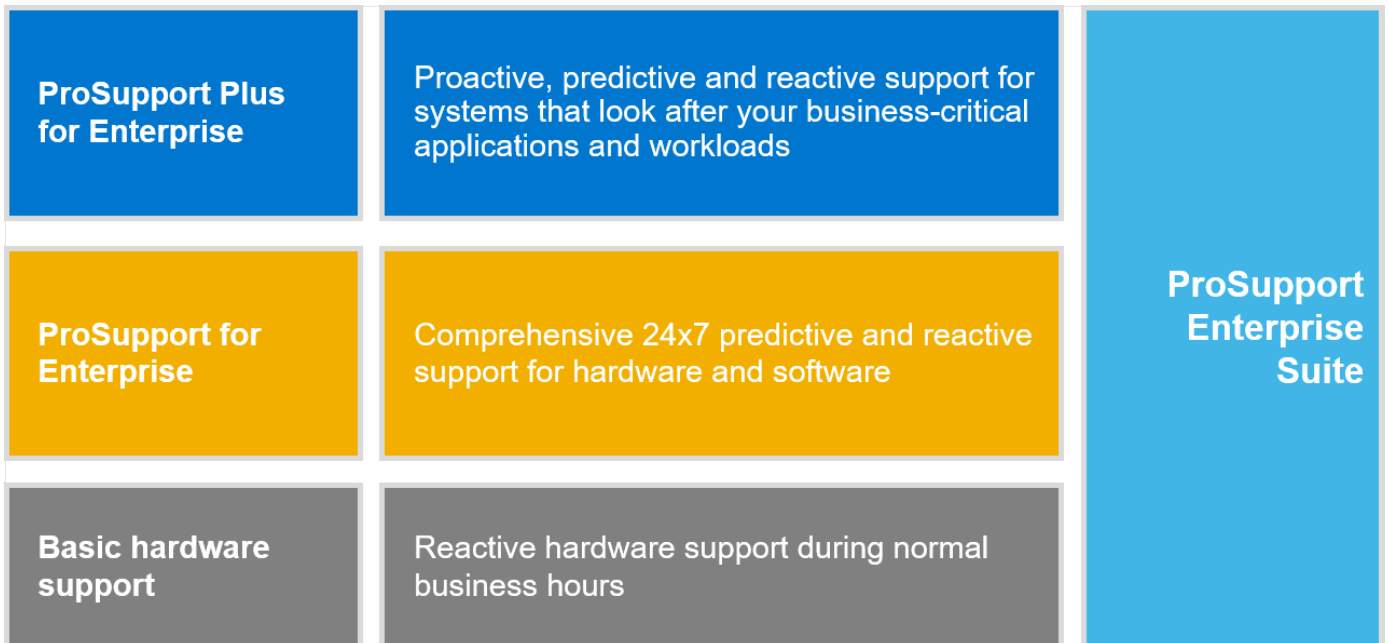

Figure 23. Dell EMC ProSupport Enterprise Suite

Dell EMC ProSupport Plus for Enterprise

When you purchase your PowerEdge server, we recommend ProSupport Plus, our proactive and preventative support service for your business-critical systems. ProSupport Plus provides you with all the benefits of ProSupport, plus the following:

- An assigned Services Account Manager who knows your business and your environment
- Immediate advanced troubleshooting from an engineer who understands your PowerEdge server
- Personalized, preventive recommendations based on analysis of support trends and best practices from across the Dell Technologies infrastructure solutions customer base to reduce support issues and improve performance
- Predictive analysis for issue prevention and optimization enabled by SupportAssist
- Proactive monitoring, issue detection, notification, and automated case creation for accelerated issue resolution enabled by SupportAssist
- On-demand reporting and analytics-based recommendations enabled by SupportAssist and TechDirect

Dell EMC ProSupport for Enterprise

Our ProSupport service offers highly trained experts around the clock and around the globe to address your IT needs. We help minimize disruptions and maximize availability of PowerEdge server workloads with:

- 24x7 support through phone, chat and online
- Predictive, automated tools and innovative technology
- A central point of accountability for all hardware and software issues
- Collaborative 3rd party support
- Hypervisor, operating system and application support
- Consistent experience regardless of where you are located or what language you speak
- Optional onsite parts and labor response options including next business day or four-hour mission critical

i **NOTE:** Subject to service offer country availability.

Enterprise Support Services Feature Comparison

	Basic	ProSupport	ProSupport Plus
Remote technical support	9x5	24x7	24x7
Covered products	Hardware	Hardware Software	Hardware Software
Onsite hardware support	Next business day	Next business day or 4hr mission critical	Next business day or 4 hr mission critical
3 rd party collaborative assistance		●	●
Automated issue detection & proactive case creation		●	●
Self-service case initiation and management		●	●
Access to software updates		●	●
Priority access to specialized support experts			●
3 rd party software support			●
Assigned Services Account Manager			●
Personalized assessments and recommendations			●
Semiannual systems maintenance			●

Availability and terms of Dell Technologies services vary by region and by product. For more information, please view our Service Descriptions available on Dell.com

Figure 24. Dell EMC Enterprise Support model

Dell EMC ProSupport One for Data Center

ProSupport One for Data Center offers flexible site-wide support for large and distributed data centers with more than 1,000 assets. This offering is built on standard ProSupport components that leverage our global scale but are tailored to your company's needs. While not for everyone, this service option offers a truly unique solution for Dell Technologies largest customers with the most complex environments.

- Team of assigned Services Account Managers with remote, on-site options
- Assigned ProSupport One technical and field engineers who are trained on your environment and configurations
- On-demand reporting and analytics-based recommendations enabled by SupportAssist and TechDirect
- Flexible on-site support and parts options that fit your operational model
- A tailored support plan and training for your operations staff

ProSupport for HPC

The ProSupport for HPC provides solution-aware support including:

- Access to senior HPC experts
- Advanced HPC cluster assistance: performance, interoperability & configuration
- Enhanced HPC solution level end-to-end support
- Remote pre-support engagement with HPC Specialists during ProDeploy implementation

Learn more at DellEMC.com/HPC-Services.

ProSupport Add-on for HPC

Delivering a true end-to-end support experience across your HPC environment

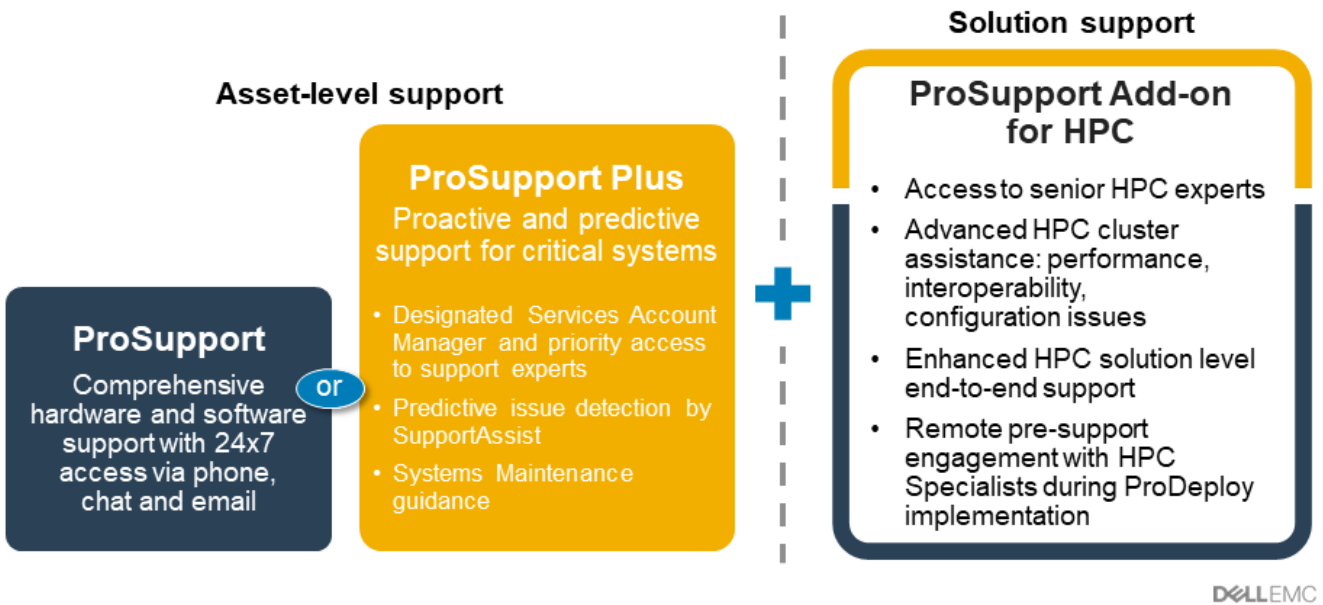

8 © Copyright 2020 Dell Inc.

DELLEMC

Figure 25. ProSupport for HPC

Support Technologies

Powering your support experience with predictive, data-driven technologies.

Dell EMC SupportAssist

The best time to solve a problem is before it happens. The automated proactive and predictive technology SupportAssist helps reduce steps and time to resolution, often detecting issues before they become a crisis. Benefits include:

- Value—SupportAssist is available to all customers at no additional charge
- Improve productivity—replace manual, high-effort routines with automated support
- Accelerate time to resolution—receive issue alerts, automatic case creation, and proactive contact from Dell EMC experts
- Gain insight and control—optimize enterprise devices with on-demand ProSupport Plus reporting in TechDirect, and get predictive issue detection before the problem starts

NOTE: SupportAssist is included with all support plans, but features vary based on service level agreement.

	Basic Hardware Warranty	ProSupport	ProSupport Plus
Automated issue detection and system state information collection	•	•	•
Proactive, automated case creation and notification		•	•
Predictive issue detection for failure prevention			•
Recommendation reporting available on-demand in TechDirect			•

Figure 26. SupportAssist model

Get started at Dell.com/SupportAssist

Dell EMC TechDirect

Boost IT team productivity when supporting Dell EMC systems. With over 1.4 million self-dispatches processed each year, TechDirect has proven its effectiveness as a support tool. You can:

- Self-dispatch replacement parts
- Request technical support
- Integrate APIs into your help desk

Or, access all your Dell EMC certification and authorization requirements. Train your staff on Dell EMC products, as TechDirect allows you to:

- Download study guides
- Schedule certification and authorization exams
- View transcripts of completed courses and exams

Register at techdirect.dell.

Dell Technologies Education Services

Build the IT skills required to influence the transformational outcomes of the business. Enable talent and empower teams with the right skills to lead and execute transformational strategy that drives competitive advantage. Leverage the training and certification required for real transformation.

Dell Technologies Education Services offers PowerEdge server training and certifications designed to help you achieve more from your hardware investment. The curriculum delivers the information and the practical, hands-on skills that you and your team need to confidently install, configure, manage, and troubleshoot your Dell EMC servers. To learn more or register for a class today, see LearnDell.com/Server.

Dell Technologies Consulting Services

Our expert consultants help you transform faster, and quickly achieve business outcomes for the high value workloads Dell EMC PowerEdge systems can handle.

From strategy to full-scale implementation, Dell Technologies Consulting can help you determine how to execute your IT, workforce, or application transformation.

We use prescriptive approaches and proven methodologies combined with Dell Technologies' portfolio and partner ecosystem to help you achieve real business outcomes. From multi-cloud, applications, DevOps, and infrastructure transformations, to business resiliency, data center modernization, analytics, workforce collaboration, and user experiences—we're here to help.

Dell EMC Managed Services

Reduce the cost, complexity, and risk of managing IT. Focus your resources on digital innovation and transformation while our experts help optimize your IT operations and investment with managed services backed by guaranteed service levels.

Appendix A. Additional specifications

Topics:

- Chassis dimension
- Chassis weight
- Video specifications
- USB Ports
- PSU rating
- Thermal restrictions
- Environmental Specifications

Chassis dimension

The R750xa has the following dimensions:

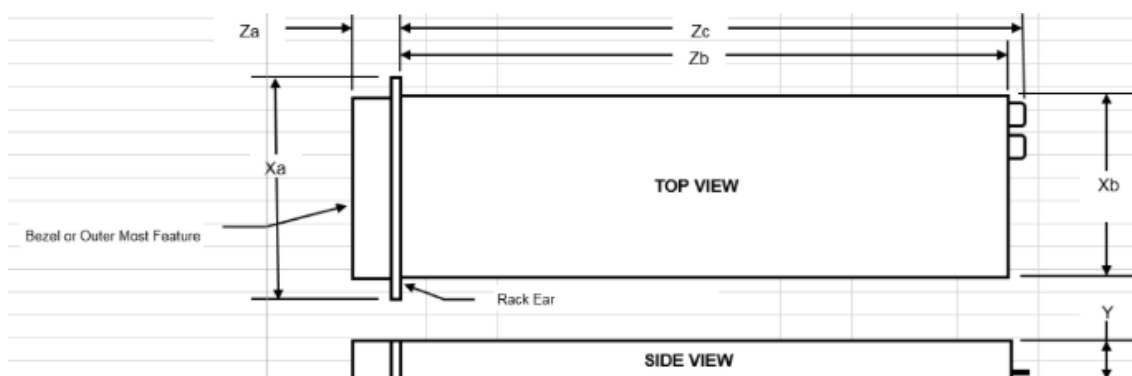

Figure 27. Chassis dimensions

Table 17. Chassis dimensions

Model number	Xa	Xb	Y	Za with bezel	Za without bezel	Zb	Zc	Max Sys Wgt	Chassis (U)
R750xa	482.0 (mm)	434.0 (mm)	86.8 (mm)	35.8 (mm)	22.0 (mm)	837.2 (Ear to Rear wall) (mm)	872.8 (mm)	35 kg	2U

Chassis weight

Table 18. Chassis maximum weight

System	Maximum Weight
8x 2.5 inches SSD	34.9 Kg
6x 2.5 inches SSD	29.0 Kg

Video specifications

The R750xa supports the following video resolution and refresh rates [graphic cards]:

Table 19. Video specifications for R750xa

Resolution	Refresh Rate	Horizontal Frequency	Pixel Clock	DVO DisplayPort
1024 x 768	60 Hz	48.4 kHz	65.0 MHz	Yes*
1280 x 800	60 Hz	49.7 kHz	83.5 MHz	Yes*
1280 x 1024	60 Hz	64.0 kHz	108.0 MHz	Yes*
1360 x 768	60 Hz	47.71 kHz	85.5 MHz	Yes*
1440 x 900	60 Hz	55.9 kHz	106.5 MHz	Yes*
1600 x 900	60 Hz	55.54 kHz	97.75 MHz	Yes*
1600 x 1200	60 Hz	75.0 kHz	162.0 MHz	Yes*
1680 x 1050	60 Hz	64.7 kHz	119.0 MHz	Yes*
1920 x 1080	60 Hz (RB)	67.158 kHz	173.0 MHz	No
1920 x 1200	60 Hz (RB)	74.556 kHz	193.25 MHz	No

* DVO - DP is for investigation only, dependent on Nuvoton DVO capabilities to support up to 165MHz.Rear Panel Performance is TBD subject to final board design and losses to rear VGA connector

*(RB) - Reduced Blanking for Digital Displays requiring less blank time. This was introduced for Signal Integrity improvements by reducing Pixel Clock rates for VGA- Analog input devices.

USB Ports

All USB ports follow USB spec. Front USB 2.0 port only supports output current up to 0.5A and can't support high power consumption devices such as CD-ROM. The bottom port of the rear USB connector can support USB3.0 to supply output current up to 0.9A.

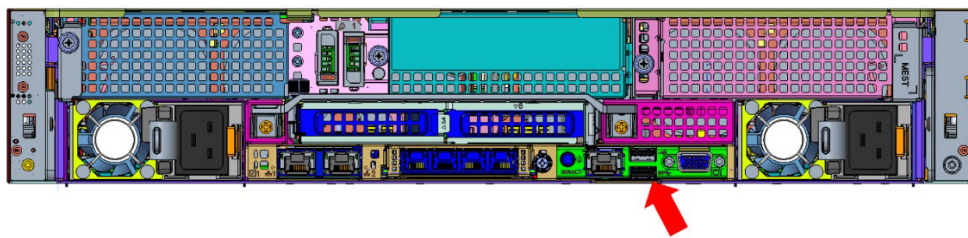

Figure 28. Rear USB Ports

The size of the internal USB card dongle is 40 x 16 x 8 mm (L x W x H).

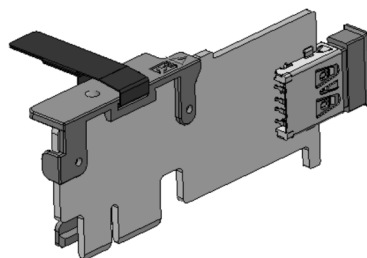

Figure 29. Internal USB

PSU rating

Below table lists the power capacity the PSUs in High/Low line operation mode.

Table 20. PSUs Highline and Lowline ratings

	800W Platinum	1100W Titanium	1400W -48VDC	1400W Platinum	2400W Platinum
Peak Power (Highline/-72VDC)	1360W	1870W	1870W	2380W	4080W
Highline/-72VDC	800W	1100W	1100W	1400W	2400W
Peak Power (Lowline/-40VDC)	1360W	1785W	1870W	1785W	2380W
Lowline/-40VDC	800W	1050W	1100W	1050W	1400W
Highline 240VDC	800W	1100W	N/A	1400W	2400W
Highline 200-380VDC	N/A	N/A	N/A	N/A	N/A
DC -48~-60V	N/A	N/A	1100W	N/A	N/A

The PowerEdge R750 supports up to 2 AC power supplies with 1+1 redundancy, autosensing, and auto-switching capability.

If two PSUs are present during POST, a comparison is made between the wattage capacities of the PSUs. In the event that the PSU wattages don't match, the larger of the two PSU's is enabled. Also, there is a PSU mismatch warning displayed in BIOS, iDRAC, or on the System LCD.

If a second PSU is added at run-time, in order for that particular PSU to be enabled, the wattage capacity of the first PSU must equal the second PSU. Otherwise, the PSU will be flagged as unmatched in iDRAC and the second PSU will not be enabled.

Dell PSUs have achieved Platinum efficiency levels as shown in the table below.

Table 21. PSU Efficiency Levels

Efficiency Targets by Load						
Output	Class	Form Factor	10%	20%	50%	100%
1400W AC	Platinum	60mm	89.00%	93.00%	94.00%	91.50%
2400W AC	Platinum	86mm	89.00%	93.00%	94.00%	91.50%

Thermal restrictions

The R750xa must follow the thermal restrictions below. All configs support at 35C ambient. All configs besides Intel Optane Persistent Memory 200 Series configs are limited to the standard 35C. Intel Optane Persistent Memory 200 Series configs are limited to 30C.

Table 22. CPU Restriction

		15G Intel 2U (R750xa PT phase)		
Configuration		R750xa Min	R750xa Typical	R750xa Max
x4 Front GPU TDP		70W SW x4	250W DW x4	300W DW x4
Front Drives		x1 SAS/SATA	x8 SAS/SATA	x8 NVMe
CPU TDP	105W	System Fan (60 x 76mm) (DPN: FD00R) 2U XP Full HSK (DPN: 8F34X)		
	120W			
	135W			

Table 22. CPU Restriction (continued)

		15G Intel 2U (R750xa PT phase)		
Configuration		R750xa Min	R750xa Typical	R750xa Max
x4 Front GPU TDP		70W SW x4	250W DW x4	300W DW x4
Front Drives		x1 SAS/SATA	x8 SAS/SATA	x8 NVMe
	150W	(Supported at 35°C)		
	165W			
	185W			
	205W			
	220W			
	230W			
	240W			
	250W			
	265W			
	270W			

ASHRAE (Ambient) Restrictions		
Dell EMC PowerEdge Server Standard Operating Support (ASHRAE A2 compliant) All options supported unless otherwise noted	Dell EMC PowerEdge Server Extended Ambient 40°C Operating Support (ASHRAE A3 compliant)	Dell EMC PowerEdge Server Extended Ambient 45°C Operating Support (ASHRAE A4 compliant)
Intel® Optane™ Persistent Memory 200 Series not supported	A3 Environment not supported	A4 Environment not supported

Table 23. Memory Restriction

		15G Intel 2U (R750xa BUT phase)			
Configuration		R750xa Min R750XA	R750xa Typical R750XA	R750xa Max R750XA	
Test Stage/Date		Min	Typical	Max	
	2DPC				
Memory (System is Air Cooled, no Liquid)	128GB LRDIMM 3200	9.4 W	Supported at 35°C ambient	Supported at 35°C ambient	Supported at 35°C ambient
	64GB RDIMM 3200	5.8 W	Supported at 35°C ambient	Supported at 35°C ambient	Supported at 35°C ambient
	32GB RDIMM 3200	4.8 W	Supported at 35°C ambient	Supported at 35°C ambient	Supported at 35°C ambient
	16GB RDIMM 3200	3.0 W	Supported at 35°C ambient	Supported at 35°C ambient	Supported at 35°C ambient
	8GB RDIMM 3200	2.0 W	Supported at 35°C ambient	Supported at 35°C ambient	Supported at 35°C ambient
	NVDIMM	—	N/A (Not Support)	N/A (Not Support)	N/A (Not Support)
	Intel Optane Persistent Memory 200	—	Max 30°C support	Max 30°C support	Max 30°C support

Table 23. Memory Restriction (continued)

		15G Intel 2U (R750xa BUT phase)		
Configuration		R750xa Min R750XA	R750xa Typical R750XA	R750xa Max R750XA
Test Stage/Date		Min	Typical	Max
	2DPC			
	Series DCPMM, 15-18W			
Double Wide 300W GPU		System Fan (60 x 76mm) 2U XP Full HSK Supported at 35°C ambient	System Fan (60 x 76mm) 2U XP Full HSK Supported at 35°C ambient	System Fan (60 x 76mm) 2U XP Full HSK Supported at 35°C ambient

Table 24. Maximum typical and Minimum

Module/Pop option	MIN	TYPE	MAX
GPUs	2x (1 per CPU)	x4 DW 250W	x4 DW 300W
CPUs	2x	2x (205W)	2x (270W)
DIMMs	2 (1 per CPU)	16x (32GB DIMMs)	32x (64GB DIMMs)
Front SSDs	1x SSD	8x SSD or 4x NVME + 4x SSD	8x NVMe
fPERC	HBA	HBA	PERC11 (NVMe RAID)
Superfly Riser	None (blanked)	4xX8 LP	2xX16 LP
OCP	1	1	2
BOSS	0	1	1
Rear Lower Modules	Rear I/O/LOM		
PSUs	2x2400W 86mm PSU		

PCIe Card Type	Form Factor	Fan	CPU HSK	Shroud	Riser Cage
Non-GPU / Non-FPGA	HL	HPR	2U HPR	STD Shroud	Short

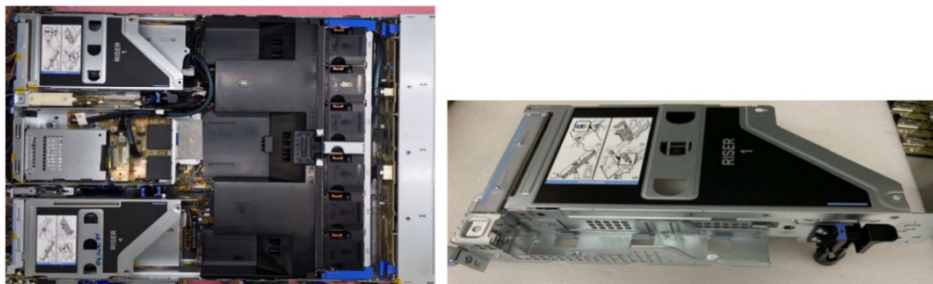

Figure 30. Shroud/HSK/Riser Cage

NOTE:

1. The R750xa thermal component can cover the maximum power condition. 270W CPU x2 with 300W GPU card x4.
2. There is no limitation for PSU/Memory/CPU/GPU combination.
3. The LP T4 GPU card can be installed at rear IO (R2a slot 3/6) with maximum power loading.

Environmental Specifications

The table below details the environmental specifications for the platform. For additional information about environmental measurements for specific system configurations, see [Product Safety, EMC and Environmental datasheets](#).

An important feature of having a broad menu of different categories is to allow the same platform model to have different operational ranges depending on the MRD defined.

A list of range categories for different configurations shall be identified by thermal team as early in the project as possible. Post release it may be found in the Installation and Service Manual.

Table 25. Operational Climatic Range Categories

Category A2	Allowable Operation
Temperature Ranges (For Altitude <900 meters or 2953 feet)	10 to 35°C (50 to 95°F) with no direct sunlight on the platform
Humidity Percent Ranges (Non-Condensing at all times)	8%RH with -12°C minimum dew point to 80%RH with 21°C (69.8°F) maximum dew point
Operational Altitude De-Rating	Maximum temperature is reduced by 1°C/300 meters (1.8°F/984 feet) above 900 meters (2,953 feet)

Category A3	Allowable Operation
Temperature Ranges (For Altitude <900 meters or 2953 feet)	5 to 40°C (41 to 104°F) with no direct sunlight on the platform
Humidity Percent Ranges (Non-Condensing at all times)	8%RH with -12°C minimum dew point to 85%RH with 24°C (75.2°F) maximum dew point
Operational Altitude De-Rating	Maximum temperature is reduced by 1°C/175 meters (1.8°F/574 feet) above 900 meters (2,953 feet)

Category A4	Allowable Operation
Temperature Ranges (For Altitude <900 meters or 2953 feet)	5 to 40°C (41 to 104°F) with no direct sunlight on the platform
Humidity Percent Ranges (Non-Condensing at all times)	8%RH with -12°C minimum dew point to 85%RH with 24°C (75.2°F) maximum dew point
Operational Altitude De-Rating	Maximum temperature is reduced by 1°C/175 meters (1.8°F/574 feet) above 900 meters (2,953 feet)

The table below shows the requirements shared across all environmental categories

Table 26. Shared Requirements

Allowable Operation	
Maximum Temperature Gradient (applies to both operation and non-operation)	20°C in an hour* (36°F in an hour) and 5°C in 15 minutes (9°F in 15 minutes), 5°C in an hour* (9°F in an hour) for tape hardware
Non-Operational Temperature Limits	-40 to 65°C (-40 to 149°F)
Non-Operational Humidity Limits (Non-Condensing at all times)	5% to 95%RH with 27°C (80.6°F) maximum dew point.
Maximum Non-Operational Altitude	12,000 meters (39,370 feet)
Maximum Operational Altitude	3,048 meters (10,000 feet)

Table 27. Maximum vibration specifications

Maximum vibration	Specifications
Operating	0.21Grms at 5Hz to 500Hz (x, y, and z axes)
Storage	1.88Grms at 10Hz to 500Hz for 15min (all six sides tested)

Table 28. Maximum shock specifications

Maximum shock	Specifications
Operating	Six consecutively executed shock pulses in the positive and negative x, y, and z axes of 6G for up to 11ms
Storage	Six consecutively executed shock pulses in the positive and negative x, y, and z axes (one pulse on each side of the system) of 71 G for up to 2 ms.

Appendix B. Standards compliance

The system conforms to the following industry standards.

Table 29. Industry standard documents

Standard	URL for information and specifications
ACPI Advance Configuration and Power Interface Specification, v2.0c	https://uefi.org/specsandtesttools
Ethernet IEEE 802.3-2005	https://standards.ieee.org/
HDG Hardware Design Guide Version 3.0 for Microsoft Windows Server	microsoft.com/whdc/system/platform/pcdesign/desguide/serverdg.mspx
IPMI Intelligent Platform Management Interface, v2.0	intel.com/design/servers/ipmi
DDR4 Memory DDR4 SDRAM Specification	jedec.org/standards-documents/docs/jesd79-4.pdf
PCI Express PCI Express Base Specification Rev. 2.0 and 3.0	pcisig.com/specifications/pciexpress
PMBus Power System Management Protocol Specification, v1.2	http://pmbus.org/Assets/PDFS/Public/PMBus_Specification_Part_1_Rev_1-1_20070205.pdf
SAS Serial Attached SCSI, v1.1	http://www.t10.org/
SATA Serial ATA Rev. 2.6; SATA II, SATA 1.0a Extensions, Rev. 1.2	sata-io.org
SMBIOS System Management BIOS Reference Specification, v2.7	dmtf.org/standards/smbios
TPM Trusted Platform Module Specification, v1.2 and v2.0	trustedcomputinggroup.org
UEFI Unified Extensible Firmware Interface Specification, v2.1	uefi.org/specifications
USB Universal Serial Bus Specification, Rev. 2.0	usb.org/developers/docs

Appendix C Additional resources

Table 30. Additional resources

Resource	Description of contents	Location
Installation and Service Manual	This manual, available in PDF format, provides the following information: <ul style="list-style-type: none"> • Chassis features • System Setup program • System indicator codes • System BIOS • Remove and replace procedures • Diagnostics • Jumpers and connectors 	Dell.com/Support/Manuals
Getting Started Guide	This guide ships with the system, and is also available in PDF format. This guide provides the following information: <ul style="list-style-type: none"> • Initial setup steps 	Dell.com/Support/Manuals
Rack Installation Guide	This document ships with the rack kits, and provides instructions for installing a server in a rack.	Dell.com/Support/Manuals
System Information Label	The system information label documents the system board layout and system jumper settings. Text is minimized due to space limitations and translation considerations. The label size is standardized across platforms.	Inside the system chassis cover
Quick Resource Locator (QRL)	This code on the chassis can be scanned by a phone application to access additional information and resources for the server, including videos, reference materials, service tag information, and Dell EMC contact information.	Inside the system chassis cover
Energy Smart Solution Advisor (ESSA)	The Dell EMC online ESSA enables easier and more meaningful estimates to help you determine the most efficient configuration possible. Use ESSA to calculate the power consumption of your hardware, power infrastructure, and storage.	Dell.com/calc