

# Dell EMC PowerEdge R750

## Technical Guide

## Notes, cautions, and warnings

 **NOTE:** A NOTE indicates important information that helps you make better use of your product.

 **CAUTION:** A CAUTION indicates either potential damage to hardware or loss of data and tells you how to avoid the problem.

 **WARNING:** A WARNING indicates a potential for property damage, personal injury, or death.

<b>Chapter 1: System overview</b> .....	<b>5</b>
Key workloads.....	5
New technologies.....	6
<b>Chapter 2: System features and generational comparison</b> .....	<b>7</b>
<b>Chapter 3: Chassis views and features</b> .....	<b>9</b>
Chassis views.....	9
Front view of the system.....	9
Rear view of the system.....	10
Inside the system.....	11
Quick Resource Locator .....	11
<b>Chapter 4: Processor</b> .....	<b>13</b>
Processor features.....	13
Supported processors.....	13
<b>Chapter 5: Memory subsystem</b> .....	<b>16</b>
Supported memory.....	16
Memory speed.....	16
<b>Chapter 6: Storage</b> .....	<b>17</b>
Storage controllers .....	17
Supported Drives.....	17
Internal storage configurations.....	18
External storage.....	18
<b>Chapter 7: Networking</b> .....	<b>20</b>
Overview.....	20
Supported OCP cards.....	20
OCP NIC 3.0 and rack network daughter card (rNDC) comparisons.....	20
SNAP I/O support.....	20
SNAP Input Output value proposition.....	20
<b>Chapter 8: PCIe subsystem</b> .....	<b>22</b>
PCIe risers.....	22
<b>Chapter 9: Power, thermal, and acoustics</b> .....	<b>26</b>
Power.....	26
Thermal.....	26
Acoustics.....	27
Acoustical performance.....	27

<b>Chapter 10: Rack information.....</b>	<b>28</b>
Static rails.....	28
Sliding rails.....	29
<b>Chapter 11: Supported Operating Systems.....</b>	<b>31</b>
<b>Chapter 12: Dell EMC OpenManage systems management.....</b>	<b>32</b>
Server and Chassis Managers.....	33
Dell EMC consoles.....	33
Automation Enablers.....	33
Integration with third-party consoles.....	33
Connections for third-party consoles.....	33
Dell EMC Update Utilities.....	33
Dell resources.....	33
<b>Chapter 13: Dell Technologies Services .....</b>	<b>35</b>
Dell EMC ProDeploy Enterprise Suite .....	35
Dell EMC ProDeploy Plus.....	36
Dell EMC ProDeploy.....	36
Basic Deployment.....	36
Dell EMC Server Configuration Services.....	36
Dell EMC Residency Services.....	36
Dell EMC Remote Consulting Services.....	36
Dell EMC Data Migration Service.....	36
Dell EMC ProSupport Enterprise Suite.....	36
Dell EMC ProSupport Plus for Enterprise.....	37
Dell EMC ProSupport for Enterprise.....	37
Dell EMC ProSupport One for Data Center.....	38
ProSupport for HPC.....	38
Support Technologies.....	39
Dell Technologies Education Services.....	40
Dell Technologies Consulting Services.....	40
Dell EMC Managed Services.....	40
<b>Chapter 14: Appendix A: Additional specifications.....</b>	<b>41</b>
Chassis dimension.....	41
Chassis weight.....	41
Video specifications.....	42
USB ports.....	42
PSU rating.....	43
Environmental Specifications.....	44
Thermal restrictions.....	44
<b>Chapter 15: Appendix B. Standards compliance.....</b>	<b>45</b>
<b>Chapter 16: Appendix C Additional resources.....</b>	<b>46</b>

# System overview

The Dell EMC™ PowerEdge™ R750 is Dell EMC's latest 2U 2-socket designed to run complex workloads using highly scalable memory, I/O, and network options. The system features the 3rd Generation Intel® Xeon® Processor Scalable family, with up to 32 DDR4 DIMMs, up to 8 PCI Express® Gen4 enabled expansion slots, and a choice of embedded NIC technologies.

## Topics:

- [Key workloads](#)
- [New technologies](#)

## Key workloads

The R750 is high performance, general purpose platform that is ready to run any workload found within a customer's datacenter. The following table lists some of these workloads and the situations wherein the R750 is a good fit.

**Table 1. Key workloads**

Workload	PowerEdge R750 is best for...
General Data Center Standardization	Customers with a wide range of workloads requiring a single server model to handle them all. Flexible configuration options allow these to match the performance needed for the most demanding workloads
Virtualization & Cloud Applications	High density virtualization Cloud-native applications High performance local storage requirements
Virtual Desktop Infrastructure	VDI deployments requiring high performance GPUs Medium-large local storage capacity
Database & Analytics	Large traditional or in-memory databases Medium-large local storage capacity Persistent memory
High-Performance Computing	HPC that requires large memory capacity High performance CPU support GPU assistance
Software Defined Storage build-out	High performance SDS node Large local storage capacity Persistent memory

# New technologies

**Table 2. New Technologies**

Technology	Detailed Description
3rd Generation Intel® Xeon® Processor Scalable Family	Consult the Processor section for specific SKU details. 10nm process technology 3x Intel® Ultra Path Interconnect (UPI) per CPU at 10.4GT/s or 11.2GT/s 64 PCIe Gen4 lanes at 16GT/s Up to 40 cores per socket Up to 3.6 GHz Max TDP: 270W
3200 MT/s DDR4 Memory	Max 16 DIMMs per CPU Supports DDR4 RDIMM, LRDIMM, 3DS DIMM and with ECC up to 3200MT/s
Persistent Memory	Supports DDR4 Intel Optane Persistent Memory 200 Series up to 3200 MT/s, max 8x 512GB Intel Optane Persistent Memory 200 Series DIMMs per CPU.
Flex IO	LOM board, 2x1Gb with BCM5720 LAN controller STD Rear IO with 1Gb Dedicated Management Network Port, USB3.0x1, USB2.0x1 and VGA port Serial Port Option with STD Rear IO board. OCP Mezz 3.0 (supported by x8 PCIe lanes) LC Rear IO with 1Gb Dedicated Management Network Port, USB3.0x1, USB2.0x1. Serial Port or VGA Port Option with LC Rear IO board.
Dedicated PERC	Front Storage module PERC with Front PERC10.5 & PERC11
Software RAID	OS RAID / S150
Power Supplies	60mm / 86mm dimension is the new PSU form factor on 15G design Platinum 800W mixed mode Titanium 1100W mixed mode -48 - (-60) V 1100 W DC Platinum 1400W mixed mode 2400W mixed mode

# System features and generational comparison

The following table shows the comparison between the PowerEdge R750 with the PowerEdge R740:

**Table 3. Features compared to previous version**

Feature	PowerEdge R750	PowerEdge 740
CPU	2x 3rd Generation Intel® Xeon® Processor Scalable Family	2x 2nd Generation Intel® Xeon® Processor Scalable Family
CPU Interconnect	Intel Ultra Path Interconnect (UPI)	Intel Ultra Path Interconnect (UPI)
Memory	32x DDR4 RDIMM, LRDIMM 16x PMem ( Intel Optane Persistent Memory 200 Series)	24x DDR4 RDIMM, LRDIMM 12x NVDIMM 12x PMem (Intel Optane Apache Pass)
Storage Drives	3.5 inches, 2.5 inches- 12Gb SAS, 6Gb SATA, NVMe	3.5 inches, 2.5 inches- 12Gb SAS, 6Gb SATA, NVMe
Storage Controllers	Adapters: HBA355I, HBA355E, H345, H745, H755, H755N, H840 BOSS S1 BOSS S2 SW RAID: S150	Adapters: HBA330, H330, H730P, H740P, H840, 12G SAS HBA Mini Mono: HBA330, H330, H730P, H740P SW RAID: S140
NVMe	Up to 24x NVMe drives	Up to 24x NVMe drives
PCIe Slots	Max 8 PCIe 4.0 (up to 6 x16 slots)	Max 8 PCIe 3.0 (up to 4 x16 slots)
LOM	2x 1Gb	N/A
Networking	OCP 3.0 (x8 PCIe)	rNDC
USB Ports	Front: 1 ports (USB 2.0), 1 dedicated (micro-USB) Rear: 2 ports (Bottom: USB 3.0, Top: USB 2.0) Internal: 1 port (USB 3.0) for IDSDM/ internal USB cards up-sell option	Front: 2 ports (USB 2.0), 1 managed (micro-USB) Rear: 2 ports (USB 3.0) Internal: 1 port (USB 3.0) Optional Upsell: 1 Front port (USB 3.0) - Not offered on xd
Rack Height	2U	2U
Power Supplies	100~240VAC/240VDC: 800W, 1100W, 1400W, 2400W DC-48V~-60V :1100W	AC (Platinum): 495W, 750W, 1100W, 1600W, 2000W, 2400W AC(Titanium): 750W DC: 1100W Mix Mode/HVDC: 750W, 1100W

**Table 3. Features compared to previous version (continued)**

<b>Feature</b>	<b>PowerEdge R750</b>	<b>PowerEdge 740</b>
System Management	LC 3.x, OpenManage, QuickSync2.0, OMPC3, Digital License Key, iDRAC Direct (dedicated micro-USB port), Easy Restore	LC 3.x, OpenManage, QuickSync 2.0, OMPC3, Digital License Key, iDRAC Direct (dedicated micro-USB port), Easy Restore, vFlash
Internal GPU	Up to 2x double width, FH, FL (300W each)  Up to 4x16 single width, FH, FL (150W each) or 6x8 PCIe single width FH, FL (75W each)  Up to 6x single width, LP/FH, HL (75W each)	3x 300W (DW) or 6x 75W (SW)
Availability	Hot-plug Drives Hot-plug Redundant Cooling Hot-plug Redundant Power Supplies IDSDM Hot-plug BOSS S2 BOSS S1	Hot-plug Drives Hot-plug Redundant Cooling Hot-plug Redundant Power Supplies BOSS IDSDM



# Chassis views and features

## Topics:

- Chassis views

## Chassis views

### Front view of the system

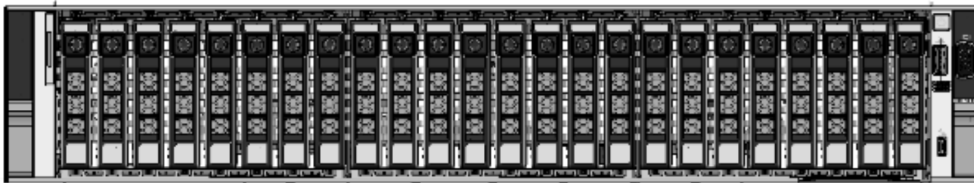

Figure 1. Front view of the R750, 24x 2.5 inches Chassis



Figure 2. 24x SAS/SATA or 24x NVMe



Figure 3. 16x SAS/SATA + 8x NVMe



Figure 4. Front view of the R750, 16x 2.5 inches SAS/SATA Chassis



Figure 5. Front view of the R750, 16x 2.5 inches SAS/SATA Chassis

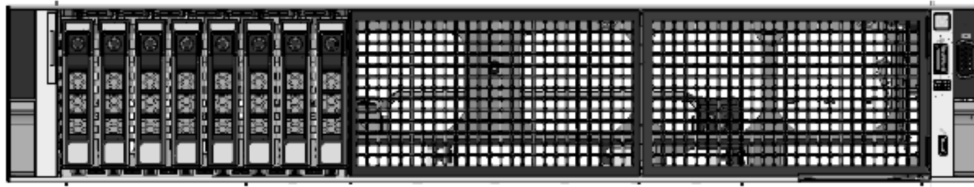

Figure 6. Front view of the R750, 8x 2.5 inches Chassis



Figure 7. Front view of the R750, 8x 2.5 inches Chassis



Figure 8. Front View of the R750, 12x 3.5 inches SAS/SATA Chassis

SLOT0	SLOT3	SLOT6	SLOT9
SLOT1	SLOT4	SLOT7	SLOT10
SLOT2	SLOT5	SLOT8	SLOT11

Figure 9. Front View of the R750, 12x 3.5 inches SAS/SATA Chassis

## Rear view of the system



Figure 10. Rear view of the R750 with 2x 2.5 inches storage drives, 6x PCIe Gen4 slots and Hot-plug BOSS



Figure 11. Rear view of the R750 with 8x PCIe Gen4 slots and Hot-plug BOSS

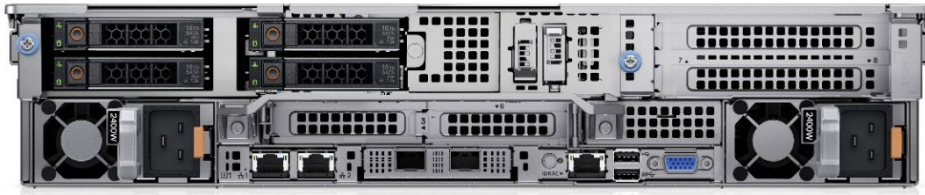

Figure 12. Rear view of the R750 with 4x 2.5 inches storage drives, 4x PCIe Gen4 slot and Hot-plug BOSS

## Inside the system

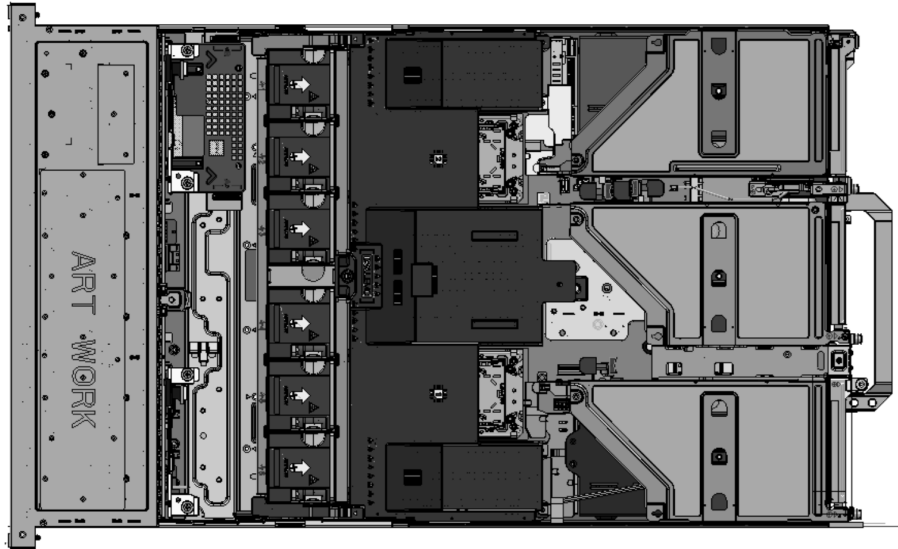

Figure 13. Inside the system of the R750

## Quick Resource Locator

The QRL on everything (SILs, GSG, Owner's Manual except on the EST) is a generic QRL for R750 that leads to a webpage for that product. That webpage has links for things like setup and service videos, iDRAC manual, and other things that apply to the platform. The QRL on the EST is unique and specific to that service tag and will contain the Service Tag number and the iDRAC password. The label and the QRL code within it are printed on demand at the L10 factories. This QRL links to a webpage that shows the exact configuration as built for that customer, and the specific warranty purchased. It is one click away from the same content of generic information that applies to R750 that is available in the other QRLs.



Figure 14. R750 Quick Resource Locator

# Processor

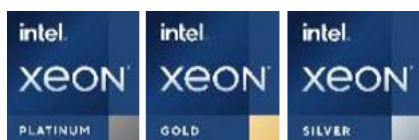

## Topics:

- [Processor features](#)
- [Supported processors](#)

## Processor features

The 3<sup>rd</sup> Generation Xeon Scalable Processors stack is next generation data center CPU offering with the latest features, increased performance, and incremental memory options. This latest generation Xeon Scalable processor will support usages from entry designs based on Intel Xeon Silver processors to advanced capabilities offered in new Intel Xeon Platinum processor.

The following lists the features and functions included in the upcoming 3<sup>rd</sup> Generation Intel Xeon Scalable Processor offering:

- Faster UPI with 3 Intel Ultra Path Interconnect (Intel UPI) at 11.2 GT/s (supported in gold and platinum options)
- More, Faster I/O with PCI Express 4 and up to 64 lanes (per socket) at 16 GT/s
- Enhanced Memory Performance with support for up to 3200MT/s DIMMs (2 DPC)
- Increased Memory Capacity with up to 8 channels and up to 256GB DDR4 DIMM support

Breakthrough System Memory with Intel Optane persistent memory 200 series (Intel Optane Persistent Memory 200 Series, up to 512GB modules) up to 6TB of total system memory/socket DDR+PMM.

## Supported processors

The following table shows the Intel Ice Lake XCC SKUs that are supported on the R750.

**Table 4. Supported processors for R750**

Proc	Clock Speed (GHz)	Cache (M)	UPI (GT/s)	Cores	Threads	Turbo	Memory Speed (MT/s)	Memory Capacity	Optane Memory Capable	TDP	R750
8380	2.3	60	11.2	40	80	Turbo	3200	6TB	Y	270W	May '21 RTS
8368Q	2.6	57	11.2	38	76	Turbo	3200	6TB	Y	270W	May '21 RTS
8368	2.4	57	11.2	38	76	Turbo	3200	6TB	Y	270W	May '21 RTS
8362	2.8	48	11.2	32	64	Turbo	3200	6TB	Y	265W	Jul '21 RTS
8360Y	2.4	54	11.2	36	72	Turbo	3200	6TB	Y	250W	May '21 RTS
8358	2.6	48	11.2	32	64	Turbo	3200	6TB	Y	250W	May '21 RTS

**Table 4. Supported processors for R750 (continued)**

Proc	Clock Speed (GHz)	Cache (M)	UPI (GT/s)	Cores	Threads	Turbo	Memory Speed (MT/s)	Memory Capacity	Optane Memory Capable	TDP	R750
8358P	2.6	48	11.2	32	64	Turbo	3200	6TB	Y	240W	May '21 RTS
8352Y	2.2	48	11.2	32	64	Turbo	3200	6TB	Y	205W	May '21 RTS
8352V	2.1	54	11.2	36	72	Turbo	2933	6TB	Y	195W	May '21 RTS
8352S	2.2	48	11.2	32	64	Turbo	3200	6TB	Y	205W	May '21 RTS
8352M	2.3	48	11.2	32	64	Turbo	3200	6TB	Y	185W	Jul '21 RTS
8351N	2.4	54	11.2	36	72	Turbo	2933	6TB	Y	205W	May '21 RTS
6354	3	39	11.2	18	36	Turbo	3200	6TB	Y	235W	May '21 RTS
6348	2.6	42	11.2	28	56	Turbo	3200	6TB	Y	235W	May '21 RTS
6346	3.1	36	11.2	16	32	Turbo	3200	6TB	Y	205W	May '21 RTS
6342	2.8	36	11.2	24	48	Turbo	3200	6TB	Y	230W	Jul '21 RTS
6338	2	36	11.2	32	64	Turbo	3200	6TB	Y	205W	May '21 RTS
6338N	2.2	48	11.2	32	64	Turbo	3200	6TB	Y	185W	May '21 RTS
6336Y	2.4	36	11.2	24	48	Turbo	2666	6TB	Y	185W	Jul '21 RTS
6334	3.6	18	11.2	8	16	Turbo	3200	6TB	Y	165W	Jul '21 RTS
6330	2	42	11.2	28	56	Turbo	2933	6TB	Y	205W	May '21 RTS
6330N	2.2	42	11.2	28	56	Turbo	3200	6TB	Y	165W	May '21 RTS
6326	2.9	24	11.2	16	32	Turbo	3200	6TB	Y	185W	Jul '21 RTS
6314U	2.3	48	11.2	32	64	Turbo	2666	6TB	Y	205W	May '21 RTS
6312U	2.4	36	11.2	24	48	Turbo	3200	6TB	Y	185W	Jul '21 RTS
5320	2.2	39	11.2	26	52	Turbo	2933	6TB	Y	185W	Jul '21 RTS
5318Y	2.1	36	11.2	24	48	Turbo	2933	6TB	Y	165W	Jul '21 RTS
5317	3	18	11.2	12	24	Turbo	2933	6TB	Y	150W	Jul '21 RTS

**Table 4. Supported processors for R750 (continued)**

Proc	Clock Speed (GHz)	Cache (M)	UPI (GT/s)	Cores	Threads	Turbo	Memory Speed (MT/s)	Memory Capacity	Optane Memory Capable	TDP	R750
5315Y	3.2	12	11.2	8	16	Turbo	2933	6TB	Y	140W	Jul '21 RTS
4316	2.3	30	10.4	20	40	Turbo	2666	6TB	N	150W	Jul '21 RTS
4314	2.4	24	10.4	16	32	Turbo	2666	6TB	Y	135W	Jul '21 RTS
4310	2.1	18	10.4	12	24	Turbo	2666	6TB	N	120W	Jul '21 RTS
4309Y	2.8	12	10.4	8	16	Turbo	2666	6TB	N	105W	Jul '21 RTS

**NOTE:**

- 8368Q\* requires liquid cooling
- 6312U and 6314U\*\* are supported only in 1S configurations

## Memory subsystem

The R750 supports up to 32 DIMMs, with maximum capacity around 12 TB per system for 8x512 GB Intel Optane Persistent Memory 200 Series and 8x 256 GB LRDIMM connected to per CPU and speeds of up to 3200MT/s.

The R750 supports registered (RDIMMs) and load reduced DIMMs (LRDIMMs) which use a buffer to reduce memory loading and provide greater density, allowing for the maximum platform memory capacity. Unbuffered DIMMs (UDIMMs) are not supported.

For detailed Intel Optane Persistent Memory 200 Series matrix support, please refer the tables below.

### Topics:

- [Supported memory](#)
- [Memory speed](#)

## Supported memory

The table below lists the memory technologies supported by the platform.

**Table 5. Memory technology**

Feature	PowerEdge R750 (DDR4)
DIMM type	RDIMM
	LRDIMM (DDP/3DS)
	3DS (Intel Optane Persistent Memory 200 Series)
Transfer speed	3200 MT/s
Voltage	1.2 V

## Memory speed

The table below lists the memory configuration and performance details for PowerEdge R750 based on the quantity and type of DIMMs per memory channel.

**Table 6. DIMM performance details**

DIMM Type	DIMM Ranking	Capacity	DIMM Rated Voltage, Speed	Operating speed (MT/s)	
				1 DPC	2 DPC
RDIMM	1R	8 GB	DDR4 (1.2 V), 3200	3200	3200
RDIMM	2R	16 GB, 32 GB, 64 GB	DDR4 (1.2 V), 3200	3200	3200
LRDIMM	4R	128 GB	DDR4 (1.2 V), 3200	3200	3200
LRDIMM	8R	256 GB	DDR4 (1.2 V), 3200	3200	3200



# Storage

## Topics:

- [Storage controllers](#)
- [Supported Drives](#)
- [Internal storage configurations](#)
- [External storage](#)

## Storage controllers

Dell's RAID controller options offer performance improvements, including the fPERC solution. fPERC provides a base RAID HW controller without consuming a PCIe slot by using a small form factor and high-density connector to the base planar.

15G PERC Controller offerings will be a heavy leverage of 14G PERC family. The Value and Value Performance levels will carry over to 15G from 14G. New to 15G, is the Harpoon-based Premium Performance tier offering. This high-end offering will drive IOPs performance and enhanced SSD performance.

**Table 7. PERC Series Controller Offerings**

Performance Level	Controller and Description
Entry	S150 (SATA, NVMe) SW RAID SATA, NVMe
Value	H345, HBA355 (Internal/External)
Value Performance	H745, H755, H755N
Premium Performance	H840 Harpoon Chip (LSI 3508) Memory: 8GB DDR4 NV cache 72-bit memory 2133MHz Low profile form factors Dual A15 1.2GHz CPU X8PCIe 3.0, x8 12Gb SAS

## Supported Drives

The table shown below lists the internal drives supported by the PowerEdge R750.

**Table 8. Supported drives - SAS and SATA or NVMe SSD**

Form Factor	Type	Speed	Rotational Speed	Capacities
2.5-inch	SATA SSD	6 Gb	N/A	240 GB, 480 GB, 960 GB, 1.92 TB, 3.84 TB

**Table 8. Supported drives - SAS and SATA or NVMe SSD (continued)**

Form Factor	Type	Speed	Rotational Speed	Capacities
	SAS	12 Gb	10 K	600 GB, 1.2 TB, 2.4 TB
	SAS	12 Gb	15 K	900 GB
	SAS SSD	12 Gb	N/A	400 GB, 480 GB, 800 GB, 960 GB, 1.6 TB, 1.92 TB, 3.84 TB, 6.4 TB, 7.68 TB, 12.8 TB, 15.36 TB
2.5-inch (U.2)	NVMe SSD	Gen4	N/A	400 GB, 800 GB, 960 GB, 1.6 TB, 1.92 TB, 3.2 TB, 3.84 TB, 6.4 TB, 7.68 TB
	NVMe SSD	Gen3	N/A	375 GB, 400 GB, 750 GB, 800 GB, 960 GB, 1.6 TB, 1.92 TB, 3.2 TB, 3.84 TB, 6.4 TB, 7.68 TB
3.5-inch	SATA	6 Gb	7.2 K	2 TB, 4 TB, 8 TB, 12 TB, 16 TB, 18 TB
	SAS	12 Gb	7.2 K	2 TB, 4 TB, 8 TB, 12 TB, 16TB, 18 TB
M.2	SATA SSD	6 GB	N/A	240 GB, 480 GB
uSD	N/A	N/A	uSD	16 GB, 32 GB, 64 GB

## Internal storage configurations

The PowerEdge R750 internal storage configurations are available in the list below.

- 12x3.5" SAS/SATA
- 12x3.5" w/ rear 2x2.5" SAS/SATA or NVMe
- 12x3.5" SAS/SATA + 4x2.5" SAS/SATA or NVMe
- 8x2.5" NVMe
- 8x2.5" NVMe RAID
- 8x2.5" Universal
- 16x2.5" SAS/SATA
- 16x2.5" NVMe
- 16x2.5" NVMe RAID - Dual Controller Required
- 16x2.5" SAS/SATA + 8x2.5" NVMe
- 24x2.5" NVMe switch\*
- 24x2.5" NVMe RAID switched - Dual Controller\*
- 24x2.5" SAS/SATA
- 24x2.5" SAS/SATA with 8x Universal slots
- 24x2.5" SAS/SATA - Dual Controller
- 24x2.5" SAS/SATA + 2x2.5" SAS/SATA or NVMe
- 24x2.5" SAS/SATA + 2x2.5" SAS/SATA - Dual Controller
- 24x2.5" SAS/SATA + 4x2.5" SAS/SATA or NVMe
- 12x3.5" SAS/SATA + 4x2.5" NVMe - 1S only
- 12x3.5" + 4x2.5" SAS/SATA - 1S only
- 24x2.5" SAS/SATA with 4x Universal slots - 1S only

 **NOTE:** \*Available post-RTS.

## External storage

The PowerEdge R750 supports the external storage device types listed in the table below.

**Table 9. Supported external storage devices**

<b>Device Type</b>	<b>Description</b>
External Tape	Supports connection to external USB tape products
NAS/IDM appliance software	Supports NAS software stack
JBOD	Supports connection to 12 Gb MD14xx and ME484 JBODs RBOD supports connection to 12 Gb ME40xx series

# Networking

## Topics:

- [Overview](#)
- [Supported OCP cards](#)
- [SNAP I/O support](#)

## Overview

PowerEdge offers a wide variety of options to get information moving to and from our servers. Industry best technologies are chosen and systems management features are added by our partners to firmware to tie in with iDRAC and Lifecycle Controller. These adapters are rigorously validated for worry-free, fully supported use in our servers.

## Supported OCP cards

### OCP NIC 3.0 and rack network daughter card (rNDC) comparisons

**Table 10. PowerEdge R750 OCP 3.0, 2.0, and rNDC NIC Comparison**

Form Factor	Dell rNDC	OCP 2.0 (LOM Mezz)	OCP 3.0	Note
PCIe Gen	Gen 3	Gen 3	Gen 4	Supported OCP3 are SFF (small form factor)
Max PCIe Lanes	x8	Up to x16	Up to x16	See server slot priority matrix
Shared LOM	Yes	Yes	Yes	This is iDRAC port redirect
Aux power	Yes	Yes	Yes	Used for shared LOM

## SNAP I/O support

### SNAP Input Output value proposition

Dual-socket servers offer ample compute power to meet the needs of a wide range of workloads. However, if the network adapters in the system are unbalanced, users may be at risk of creating a bottleneck that will reduce bandwidth and increase latency. SNAP I/O is a solution which leverages Mellanox socket direct technology to balance I/O performance without increasing the TCO. By allowing both processors to share one adapter, data can avoid traversing the UPI inter-processor link when accessing remote memory.

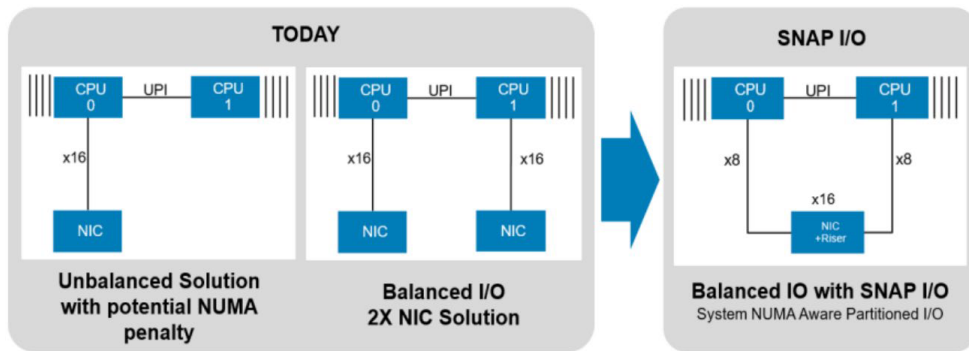

**Figure 15. Comparing an unbalanced one-NIC solution and a balanced two-NIC solution to a SNAP I/O one-NIC solution.**

The SNAP I/O solution on the right allows CPU 0 and 1 to communicate to their corresponding NIC card without traversing the UPI channels, therefore reducing latency/TCO and freeing up UPI bandwidth for applications.

# PCIe subsystem

## Topics:

- PCIe risers

## PCIe risers

The PowerEdge R750 have a no riser option. Shown below are the riser offerings for the PowerEdgeR750.

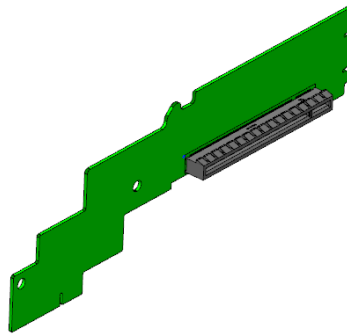

Figure 16. Riser 1A: 1 slot

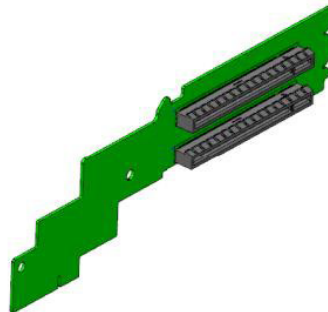

Figure 17. Riser 1B: 2 slots

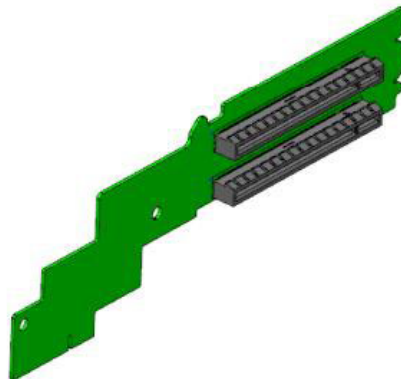

Figure 18. Riser 1C: 2 slots

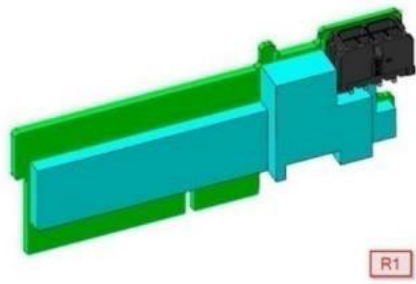

Figure 19. R1 Paddle (routes PCIe lanes to front backplane for additional NVMe)

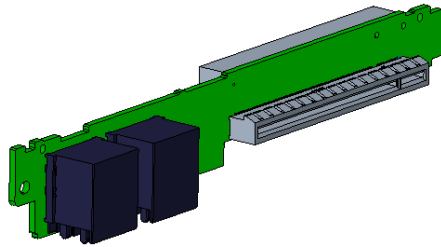

Figure 20. Riser 2A: 2 Slots

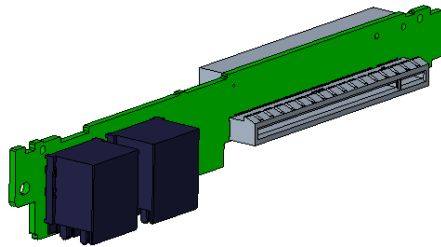

Figure 21. R750 Riser 2B: 2 Slots

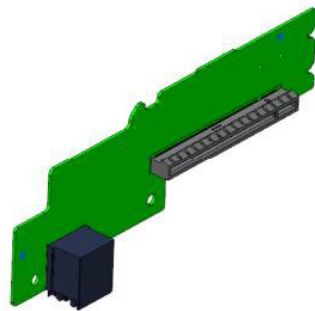

Figure 22. Riser 3A: 1 Slot

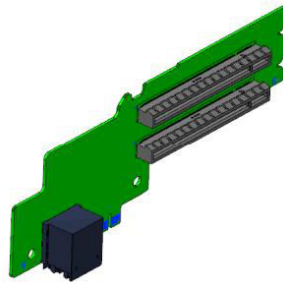

Figure 23. Riser 3B: 2 Slots

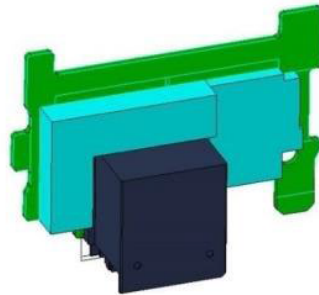

Figure 24. R3 Paddle (routes PCIe lanes to front backplane for additional NVMe)

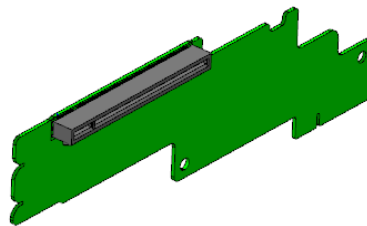

Figure 25. Riser 4A: 1 Slot

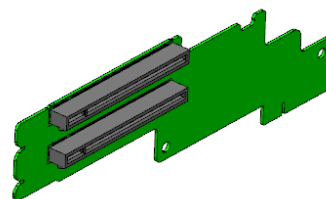

Figure 26. Riser 4B: 2 Slots

Table 11. Riser offerings

Config No.	RSR configuration	No. of CPUs	PERC type supported	Rear storage possible	x8 CPU1	x16 CPU1	x8 CPU 2	x16 CPU 2
0	R1b+R4b	2	fPERC/ Adapter	No	2	0	2	0
1	R1b+R2a+R3b+R4b	2	fPERC/ Adapter	No	2	1	4	1
2-1	R1a+R2a+R3b+R4a (FL)	2	fPERC/ Adapter	No	0	2	2	2



**Table 11. Riser offerings (continued)**

Config No.	RSR configuration	No. of CPUs	PERC type supported	Rear storage possible	x8 CPU1	x16 CPU1	x8 CPU 2	x16 CPU 2
2-2	R1a+R2a+R3b+R4a (HL)	2	fPERC/Adapter	No	0	2	2	2
3-1	R1a+R2b+R3b+R4a (FL)	2	fPERC	No	0	2	3	1
3-2	R1a+R2b+R3b+R4a (HL)	2	fPERC	No	0	2	3	1
4-1	R1c+R2a+R3a+R4a (FL)	2	fPERC	No	0	3	0	3
4-2	R1c+R2a+R3a+R4a (HL)	2	fPERC	No	0	3	0	3
5	R2a+R4b	2	fPERC/Adapter	Yes	0	1	2	1
6	R1b+R2a+R4b	2	fPERC/Adapter	Yes	2	1	2	1
7	R2a+R4b + R1-paddle for XA cable + R3-paddle for XA cable	2	No	No	0	1	2	1
8	R1b+R2a	1	fPERC	No	2	1	0	0
9	R2a	1	Adapter	Yes	0	1	0	0

# Power, thermal, and acoustics

## Topics:

- Power
- Thermal
- Acoustics

## Power

**Table 12. Power tools and technologies**

Feature	Description
Power Supply Units(PSU) portfolio	Dell's PSU portfolio includes intelligent features such as dynamically optimizing efficiency while maintaining availability and redundancy. Find additional information in the Power supply units section.
Industry Compliance	Dell's servers are compliant with all relevant industry certifications and guidelines, including 80 PLUS, Climate Savers, and ENERGY STAR.
Power monitoring accuracy	PSU power monitoring improvements include: <ul style="list-style-type: none"> <li>• Dell's power monitoring accuracy is currently 1%, whereas the industry standard is 5%</li> <li>• More accurate reporting of power</li> <li>• Better performance under a power cap</li> </ul>
Power capping	Use Dell's systems management to set the power cap limit for your systems to limit the output of a PSU and reduce system power consumption.
Systems Management	iDRAC Enterprise provides server- level management that monitors, reports, and controls power consumption at the processor, memory, and system level.  Dell OpenManage Power Center delivers group power management at the rack, row, and data center level for servers, power distribution units, and uninterruptible power supplies.
Rack infrastructure	Dell offers some of the industry's highest- efficiency power infrastructure solutions, including: <ul style="list-style-type: none"> <li>• <a href="#">Power distribution units (PDUs)</a></li> <li>• <a href="#">Uninterruptible power supplies (UPSs)</a></li> <li>• <a href="#">Energy Smart containment rack enclosures</a></li> </ul>

## Thermal

PowerEdge servers have an extensive collection of sensors that automatically track thermal activity, which helps regulate temperature thereby reducing server noise and power consumption.

Thermal management of PowerEdge R750 delivers high performance for the right amount of cooling to components at the lowest fan speeds across a wide range of ambient temperatures from 10°C to 35°C (50°F to 86°F) and to extended ambient temperature ranges (see Environmental Specifications). The benefits to you are lower fan power consumption (lower server system power and data center power consumption) and greater acoustical versatility.

## Acoustics

### Acoustical performance

Dell EMC PowerEdge R750 is a rack-mount server appropriate for attended data center environment. However, lower acoustical output is attainable with proper hardware or software configurations. For example, the minimum configuration of R750 is quiet enough for typical office environment.

## Rack information

The PowerEdge R750 offers two different varieties of sliding rails: Drop-in sliding rails, and combination Stab-in/Drop-in sliding rails. Only one variety of static rail is offered: stab-in.

A “Drop-in” design means that the system is installed vertically into the rails by inserting the standoffs on the sides of the system into the “J-slots” in the inner rail members with the rails in the fully extended position. The recommended method of installation is to first insert the rear standoffs on the system into the rear J-slots on the rails in order to free up a hand and then rotate the system down into the remaining J-slots while using the free hand to hold the rail against the side of the system.

A “Stab-in” design means that means that the inner (chassis) rail members must first be attached to the sides of the system and then inserted into the outer (cabinet) members installed in the rack. For 2U systems, this is a 2- person lift.

### Topics:

- [Static rails](#)
- [Sliding rails](#)

## Static rails

The static rails (shown in the figure below) support a wider variety of racks than the sliding rails, but do not support serviceability in the rack. The static rails are not compatible with the CMA and SRB.

B4 Ready Rails Static Rails for 4-post & 2-post Racks:

- Supports Stab-in installation of the chassis to the rails.
- Support tool-less installation in 19 inches EIA-310-E compliant square or unthreaded round hole 4-post racks including all generations of Dell racks
- Support tooled installation in 19 inches EIA-310-E compliant threaded hole 4-post and 2-post racks
- Support for tooled installation in Dell EMC Titan or Titan-D rack

### **i** NOTE:

- Screws are not included with the static rail kit since racks are offered with various thread types. The screws are provided for mounting static rails in racks with threaded mounting flanges
- Screw head diameter should be 10 mm or less.

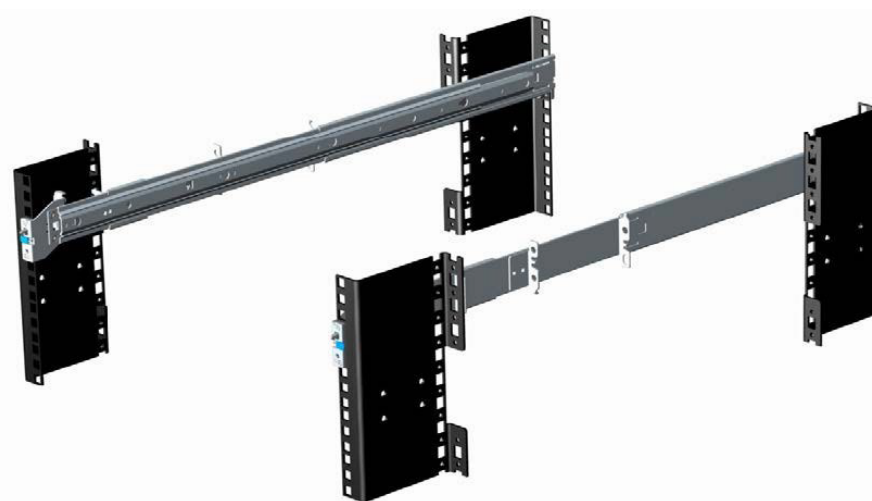

Figure 27. Static Rails

# Sliding rails

The sliding rails (shown in the figure below) allow the system to be fully extended out of the rack for service. The sliding rails have a CMA and a SRB option. There are two types of Sliding rails available in 15G, ReadyRails II sliding rails and Stab-in/Drop-in sliding rails.

B6 ReadyRails™ II sliding rails for 4-post racks:

- Supports Drop-in Installation of the chassis to the rails.
- Support for tool-less installation in 19 inches EIA-310-E compliant square or unthreaded round hole 4-post racks including all generations of Dell racks.
- Support for toolled installation in 19 inches EIA-310-E compliant threaded hole 4-post racks.
- Support full extension of the system out of the rack to allow serviceability of key internal components.
- Support for optional cable management arm (CMA).
- Support for optional strain relief bar (SRB).

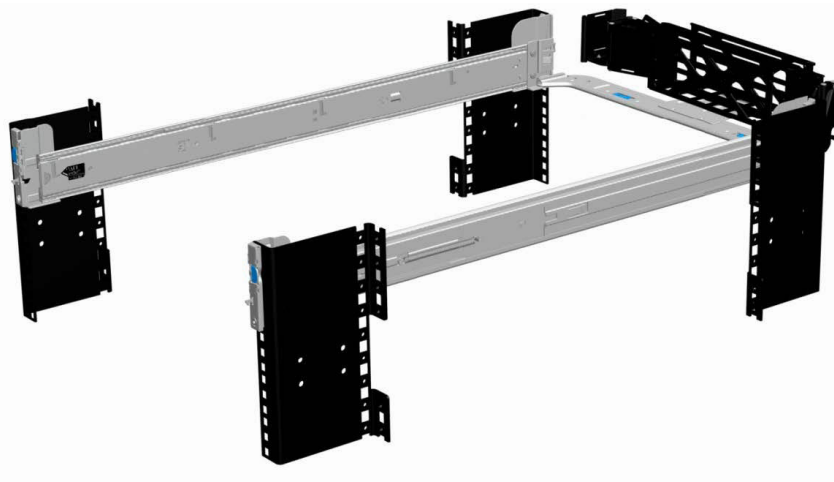

Figure 28. Sliding rails with optional CMA



Figure 29. Sliding rails with optional SRB

B13 Stab-in/Drop-in Sliding Rails for 4-post Racks

- Supports Drop-in or Stab-in installation of the chassis to the rails.
- Support for tool-less installation in 19 inches EIA-310-E compliant square, unthreaded round hole racks including all generations of Dell racks. Also supports tool-less installation in threaded round hole 4-post racks.
- Support full extension of the system out of the rack to allow serviceability of key internal components.
- Support for optional cable management arm (CMA).
- Support for optional strain relief bar (SRB).

 **NOTE:**

- For situations where CMA support is not required, the outer CMA mounting brackets can be uninstalled from the sliding rails. This reduces the overall length of the rails and eliminates the potential interferences with rear mounted PDUs or the rear rack door.
- Scan the QRL code for the documentation and trouble-shooting information regarding the installation procedures for Drop-in/Stab in rail types.

# Supported Operating Systems

The following lists the supported operating systems for the PowerEdge R750:

- RedHat Enterprise Linux 7.9 Server x86\_64
- RedHat Enterprise Linux 8.2 Server x86\_64
- RedHat Enterprise Linux 8.3 Server x86\_64
- Novell SuSE Linux Enterprise Server 15 SP2 x86\_64
- MS, Windows Server 2016
- MS, Windows Server 2019
- Ubuntu 20.04
- VMWare vSphere 7.0 U2 (ESXi 7.0 U2)
- VMWare vSphere 2019 (ESXi 2019)
- Citrix Xen Server 8.2 LTSR

The link to the specific OS versions and editions, certification matrices, Hardware Compatibility Lists (HCL) portal, and Hypervisor support can be found at [Dell EMC Enterprise Operating Systems](#)

# Dell EMC OpenManage systems management

## Dell EMC OpenManage Portfolio

Simplifying hardware management through ease of use and automation

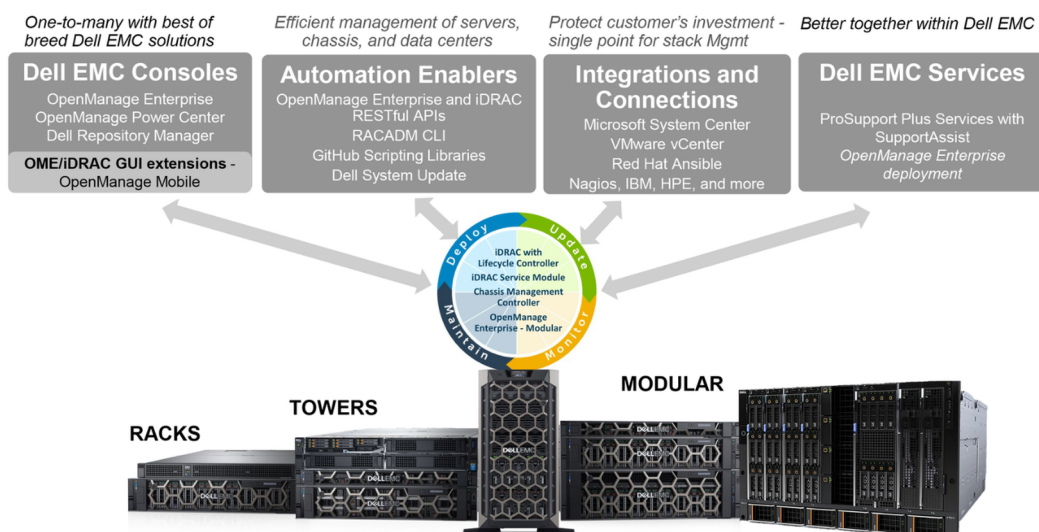

Figure 30. Dell EMC OpenManage Portfolio

Dell EMC delivers management solutions that help IT Administrators effectively deploy, update, monitor, and manage IT assets. OpenManage solutions and tools enable you to quickly respond to problems by helping them to manage Dell EMC servers effectively and efficiently; in physical, virtual, local, and remote environments, operating in-band, and out-of-band (agent-free). The OpenManage portfolio includes innovative embedded management tools such as the integrated Dell Remote Access Controller (iDRAC), Chassis Management Controller and Consoles like OpenManage Enterprise, OpenManage Power Manager plug in, and tools like Repository Manager.

Dell EMC has developed comprehensive systems management solutions based on open standards and has integrated with management consoles that can perform advanced management of Dell hardware. Dell EMC has connected or integrated the advanced management capabilities of Dell hardware into offerings from the industry's top systems management vendors and frameworks such as Ansible, thus making Dell EMC platforms easy to deploy, update, monitor, and manage.

The key tools for managing Dell EMC PowerEdge servers are iDRAC and the one-to-many OpenManage Enterprise console. OpenManage Enterprise helps the system administrators in complete lifecycle management of multiple generations of PowerEdge servers. Other tools such as Repository Manager, which enables simple yet comprehensive change management.

OpenManage tools integrate with systems management framework from other vendors such as VMware, Microsoft, Ansible, and ServiceNow. This enables you to use the skills of the IT staff to efficiently manage Dell EMC PowerEdge servers.

### Topics:

- [Server and Chassis Managers](#)
- [Dell EMC consoles](#)
- [Automation Enablers](#)
- [Integration with third-party consoles](#)
- [Connections for third-party consoles](#)
- [Dell EMC Update Utilities](#)
- [Dell resources](#)



# Server and Chassis Managers

- Integrated Dell Remote Access Controller (iDRAC)
- iDRAC Service Module (iSM)

## Dell EMC consoles

- Dell EMC OpenManage Enterprise
- Dell EMC Repository Manager (DRM)
- Dell EMC OpenManage Enterprise Power Manager plugin to OpenManage Enterprise
- Dell EMC OpenManage Mobile (OMM)

## Automation Enablers

- OpenManage Ansible Modules
- iDRAC RESTful APIs (Redfish)
- Standards-based APIs (Python, PowerShell)
- RACADM Command Line Interface (CLI)
- GitHub Scripting Libraries

## Integration with third-party consoles

- Dell EMC OpenManage Integrations with Microsoft System Center
- Dell EMC OpenManage Integration for VMware vCenter (OMIVV)
- Dell EMC OpenManage Ansible Modules
- Dell EMC OpenManage Integration with ServiceNow

## Connections for third-party consoles

- Micro Focus and other HPE tools
- OpenManage Connection for IBM Tivoli
- OpenManage Plug-in for Nagios Core and XI

## Dell EMC Update Utilities

- Dell System Update (DSU)
- Dell EMC Repository Manager (DRM)
- Dell EMC Update Packages (DUP)
- Dell EMC Server Update Utility (SUU)
- Dell EMC Platform Specific Bootable ISO (PSBI)

## Dell resources

For additional information about white papers, videos, blogs, forums, technical material, tools, usage examples, and other information, go to the OpenManage page at <https://www.dell.com/openmanagemanuals> or the following product pages:

**Table 13. Dell resources**

<b>Resource</b>	<b>Location</b>
Integrated Dell Remote Access Controller (iDRAC)	<a href="https://www.dell.com/idracmanuals">https://www.dell.com/idracmanuals</a>
iDRAC Service Module (iSM)	<a href="https://www.dell.com/support/kbdoc/000178050/">https://www.dell.com/support/kbdoc/000178050/</a>
OpenManage Ansible Modules	<a href="https://www.dell.com/support/kbdoc/000177308/">https://www.dell.com/support/kbdoc/000177308/</a>
OpenManage Essentials (OME)	<a href="https://www.dell.com/support/kbdoc/000175879/">https://www.dell.com/support/kbdoc/000175879/</a>
OpenManage Mobile (OMM)	<a href="https://www.dell.com/support/kbdoc/000176046">https://www.dell.com/support/kbdoc/000176046</a>
OpenManage Integration for VMware vCenter (OMIVV)	<a href="https://www.dell.com/support/kbdoc/000176981/">https://www.dell.com/support/kbdoc/000176981/</a>
OpenManage Integration for Microsoft System Center (OMIMSSC)	<a href="https://www.dell.com/support/kbdoc/000147399">https://www.dell.com/support/kbdoc/000147399</a>
Dell EMC Repository Manager (DRM)	<a href="https://www.dell.com/support/kbdoc/000177083">https://www.dell.com/support/kbdoc/000177083</a>
Dell EMC System Update (DSU)	<a href="https://www.dell.com/support/kbdoc/000130590">https://www.dell.com/support/kbdoc/000130590</a>
Dell EMC Platform Specific Bootable ISO (PSBI)	<a href="https://Dell.com/support/article/sln296511">Dell.com/support/article/sln296511</a>
Dell EMC Chassis Management Controller (CMC)	<a href="https://www.dell.com/support/article/sln311283">www.dell.com/support/article/sln311283</a>
OpenManage Connections for Partner Consoles	<a href="https://www.dell.com/support/kbdoc/000146912">https://www.dell.com/support/kbdoc/000146912</a>
OpenManage Enterprise Power Manager	<a href="https://www.dell.com/support/kbdoc/000176254">https://www.dell.com/support/kbdoc/000176254</a>
OpenManage Integration with ServiceNow (OMISNOW)	<a href="https://Dell.com/support/article/sln317784">Dell.com/support/article/sln317784</a>

 **NOTE:** Features may vary by server. Please refer to the product page on <https://www.dell.com/manuals> for details.

## Dell Technologies Services

Dell Technologies Services include a wide, customizable range of service choices to simplify the assessment, design, implementation, management and maintenance of IT environments and to help you transition from platform to platform. Depending on your current business requirements and the level of service right for you, we provide factory, on-site, remote, modular, and specialized services that fit your needs and budget. We'll help with a little or a lot—your choice—and provide access to our global resources.

For more information, see [DellEMC.com/Services](http://DellEMC.com/Services).

### Topics:

- [Dell EMC ProDeploy Enterprise Suite](#)
- [Dell EMC Remote Consulting Services](#)
- [Dell EMC Data Migration Service](#)
- [Dell EMC ProSupport Enterprise Suite](#)
- [Dell EMC ProSupport Plus for Enterprise](#)
- [Dell EMC ProSupport for Enterprise](#)
- [Dell EMC ProSupport One for Data Center](#)
- [ProSupport for HPC](#)
- [Support Technologies](#)
- [Dell Technologies Education Services](#)
- [Dell Technologies Consulting Services](#)
- [Dell EMC Managed Services](#)

## Dell EMC ProDeploy Enterprise Suite

ProDeploy Enterprise Suite gets your server out of the box and into optimized production—fast. Our elite deployment engineers with broad and deep experience utilizing best-in-class processes along with our established global scale can help you around the clock and around the globe. From simple to the most complex server installations and software integration, we take the guess work and risk out of deploying your new server technology.

		Basic Deployment	ProDeploy	ProDeploy Plus
<b>Pre-deployment</b>	Single point of contact for project management	-	●	In-region
	Site readiness review	-	●	●
	Implementation planning	-	●	●
	SAM engagement for ProSupport Plus entitled devices	-	-	●
<b>Deployment</b>	Deployment service hours	Business hours	24x7	24x7
	Remote guidance for hardware installation or Onsite hardware installation and packaging material removal	Onsite	Remote or Onsite	Onsite
	Install and configure system software	-	Remote	Onsite
	Install support software and connect with Dell Technologies	-	●	●
	Project documentation with knowledge transfer	-	●	●
	<b>Post-deployment</b>	Deployment verification	-	●
Configuration data transfer to Dell EMC technical support		-	●	●
30-days of post-deployment configuration assistance		-	-	●
Training credits for Dell EMC Education Services		-	-	●

Figure 31. ProDeploy Enterprise Suite capabilities

**NOTE:** Hardware installation not applicable on selected software products.

## Dell EMC ProDeploy Plus

From beginning to end, ProDeploy Plus provides the skill and scale needed to successfully execute demanding deployments in today's complex IT environments. Certified Dell EMC experts start with extensive environmental assessments and detailed migration planning and recommendations. Software installation includes set up of most versions of Dell EMC SupportAssist and OpenManage system management utilities. Post-deployment configuration assistance, testing, and product orientation services are also available.

## Dell EMC ProDeploy

ProDeploy provides full service installation and configuration of both server hardware and system software by certified deployment engineers including set up of leading operating systems and hypervisors as well as most versions of Dell EMC SupportAssist and OpenManage system management utilities. To prepare for the deployment, we conduct a site readiness review and implementation planning exercise. System testing, validation, and full project documentation with knowledge transfer complete the process.

## Basic Deployment

Basic Deployment delivers worry-free professional installation by experienced technicians who know Dell EMC servers inside and out.

## Dell EMC Server Configuration Services

With Dell EMC Rack Integration and other Dell EMC PowerEdge Server Configuration Services, you save time by receiving your systems racked, cabled, tested, and ready to integrate into the data center. Dell EMC staff pre-configure RAID, BIOS and iDRAC settings, install system images, and even install third-party hardware and software.

For more information, see [Server Configuration Services](#).

## Dell EMC Residency Services

Residency Services helps customers transition to new capabilities quickly with the assistance of on-site or remote Dell EMC experts whose priorities and time you control. Residency experts can provide post implementation management and knowledge transfer related to a new technology acquisition or day-to-day operational management of the IT infrastructure.

## Dell EMC Remote Consulting Services

When you are in the final stages of your PowerEdge server implementation, you can rely on Dell EMC Remote Consulting Services and our certified technical experts to help you optimize your configuration with best practices for your software, virtualization, server, storage, networking, and systems management.

## Dell EMC Data Migration Service

Protect your business and data with our single point of contact to manage your data migration project. Your project manager will work with our experienced team of experts to create a plan using industry-leading tools and proven processes based on global best practices to migrate your existing files and data so your business system get up and running quickly and smoothly.

## Dell EMC ProSupport Enterprise Suite

With the ProSupport Enterprise Suite, we help keep your IT systems running smoothly, so you can focus on running your business. We will help maintain peak performance and availability of your most essential workloads. ProSupport Enterprise Suite is a suite of support services that enable you to build the solution that is right for your organization.

Choose support models based on how you use technology and where you want to allocate resources. From the desktop to the data center, address everyday IT challenges, such as unplanned downtime, mission-critical needs, data and asset protection, support planning, resource allocation, software application management and more. Optimize IT resources by choosing the right support model.

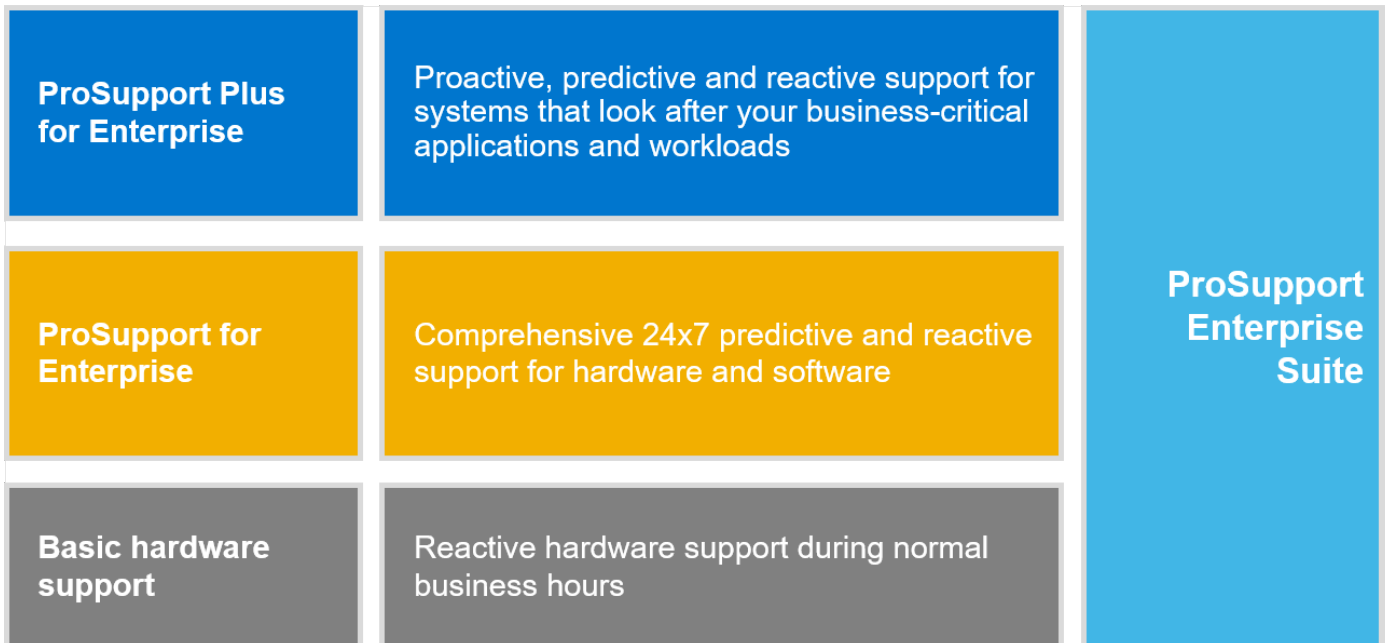

Figure 32. Dell EMC ProSupport Enterprise Suite

## Dell EMC ProSupport Plus for Enterprise

When you purchase your PowerEdge server, we recommend ProSupport Plus, our proactive and preventative support service for your business-critical systems. ProSupport Plus provides you with all the benefits of ProSupport, plus the following:

- An assigned Services Account Manager who knows your business and your environment
- Immediate advanced troubleshooting from an engineer who understands your PowerEdge server
- Personalized, preventive recommendations based on analysis of support trends and best practices from across the Dell Technologies infrastructure solutions customer base to reduce support issues and improve performance
- Predictive analysis for issue prevention and optimization enabled by SupportAssist
- Proactive monitoring, issue detection, notification, and automated case creation for accelerated issue resolution enabled by SupportAssist
- On-demand reporting and analytics-based recommendations enabled by SupportAssist and TechDirect

## Dell EMC ProSupport for Enterprise

Our ProSupport service offers highly trained experts around the clock and around the globe to address your IT needs. We help minimize disruptions and maximize availability of PowerEdge server workloads with:

- 24x7 support through phone, chat and online
- Predictive, automated tools and innovative technology
- A central point of accountability for all hardware and software issues
- Collaborative 3rd party support
- Hypervisor, operating system and application support
- Consistent experience regardless of where you are located or what language you speak
- Optional onsite parts and labor response options including next business day or four-hour mission critical

**i** **NOTE:** Subject to service offer country availability.

## Enterprise Support Services Feature Comparison

	Basic	ProSupport	ProSupport Plus
Remote technical support	9x5	24x7	24x7
Covered products	Hardware	Hardware Software	Hardware Software
Onsite hardware support	Next business day	Next business day or 4hr mission critical	Next business day or 4 hr mission critical
3 <sup>rd</sup> party collaborative assistance		●	●
Automated issue detection & proactive case creation		●	●
Self-service case initiation and management		●	●
Access to software updates		●	●
Priority access to specialized support experts			●
3 <sup>rd</sup> party software support			●
Assigned Services Account Manager			●
Personalized assessments and recommendations			●
Semiannual systems maintenance			●

Availability and terms of Dell Technologies services vary by region and by product. For more information, please view our Service Descriptions available on [Dell.com](http://Dell.com)

Figure 33. Dell EMC Enterprise Support model

## Dell EMC ProSupport One for Data Center

ProSupport One for Data Center offers flexible site-wide support for large and distributed data centers with more than 1,000 assets. This offering is built on standard ProSupport components that leverage our global scale but are tailored to your company's needs. While not for everyone, this service option offers a truly unique solution for Dell Technologies largest customers with the most complex environments.

- Team of assigned Services Account Managers with remote, on-site options
- Assigned ProSupport One technical and field engineers who are trained on your environment and configurations
- On-demand reporting and analytics-based recommendations enabled by SupportAssist and TechDirect
- Flexible on-site support and parts options that fit your operational model
- A tailored support plan and training for your operations staff

## ProSupport for HPC

The ProSupport for HPC provides solution-aware support including:

- Access to senior HPC experts
- Advanced HPC cluster assistance: performance, interoperability & configuration
- Enhanced HPC solution level end-to-end support
- Remote pre-support engagement with HPC Specialists during ProDeploy implementation

Learn more at [DellEMC.com/HPC-Services](http://DellEMC.com/HPC-Services).

# ProSupport Add-on for HPC

Delivering a true end-to-end support experience across your HPC environment

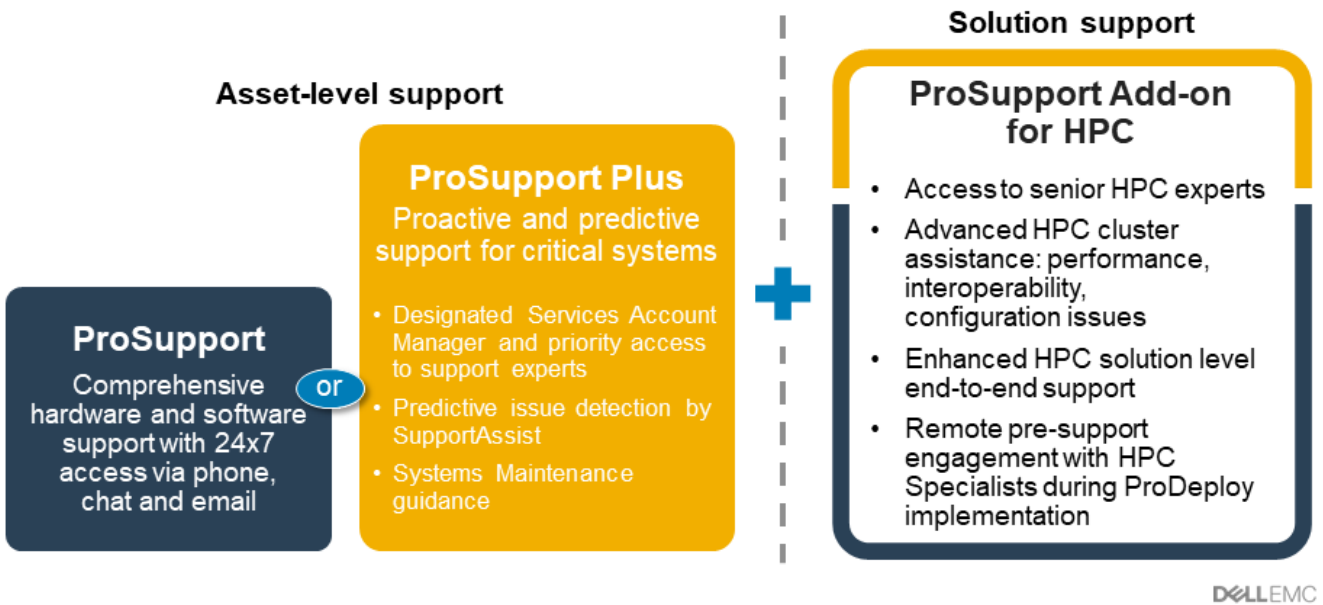

Figure 34. ProSupport for HPC

## Support Technologies

Powering your support experience with predictive, data-driven technologies.

### Dell EMC SupportAssist

The best time to solve a problem is before it happens. The automated proactive and predictive technology SupportAssist helps reduce steps and time to resolution, often detecting issues before they become a crisis. Benefits include:

- Value—SupportAssist is available to all customers at no additional charge
- Improve productivity—replace manual, high-effort routines with automated support
- Accelerate time to resolution—receive issue alerts, automatic case creation, and proactive contact from Dell EMC experts
- Gain insight and control—optimize enterprise devices with on-demand ProSupport Plus reporting in TechDirect, and get predictive issue detection before the problem starts

**NOTE:** SupportAssist is included with all support plans, but features vary based on service level agreement.

	Basic Hardware Warranty	ProSupport	ProSupport Plus
Automated issue detection and system state information collection	•	•	•
Proactive, automated case creation and notification		•	•
Predictive issue detection for failure prevention			•
Recommendation reporting available on-demand in TechDirect			•

Figure 35. SupportAssist model

Get started at [Dell.com/SupportAssist](https://Dell.com/SupportAssist)

## Dell EMC TechDirect

Boost IT team productivity when supporting Dell EMC systems. With over 1.4 million self-dispatches processed each year, TechDirect has proven its effectiveness as a support tool. You can:

- Self-dispatch replacement parts
- Request technical support
- Integrate APIs into your help desk

Or, access all your Dell EMC certification and authorization requirements. Train your staff on Dell EMC products, as TechDirect allows you to:

- Download study guides
- Schedule certification and authorization exams
- View transcripts of completed courses and exams

Register at [techdirect.dell](https://techdirect.dell).

## Dell Technologies Education Services

Build the IT skills required to influence the transformational outcomes of the business. Enable talent and empower teams with the right skills to lead and execute transformational strategy that drives competitive advantage. Leverage the training and certification required for real transformation.

Dell Technologies Education Services offers PowerEdge server training and certifications designed to help you achieve more from your hardware investment. The curriculum delivers the information and the practical, hands-on skills that you and your team need to confidently install, configure, manage, and troubleshoot your Dell EMC servers. To learn more or register for a class today, see [LearnDell.com/Server](https://LearnDell.com/Server).

## Dell Technologies Consulting Services

Our expert consultants help you transform faster, and quickly achieve business outcomes for the high value workloads Dell EMC PowerEdge systems can handle.

From strategy to full-scale implementation, Dell Technologies Consulting can help you determine how to execute your IT, workforce, or application transformation.

We use prescriptive approaches and proven methodologies combined with Dell Technologies' portfolio and partner ecosystem to help you achieve real business outcomes. From multi-cloud, applications, DevOps, and infrastructure transformations, to business resiliency, data center modernization, analytics, workforce collaboration, and user experiences—we're here to help.

## Dell EMC Managed Services

Reduce the cost, complexity, and risk of managing IT. Focus your resources on digital innovation and transformation while our experts help optimize your IT operations and investment with managed services backed by guaranteed service levels.



## Appendix A: Additional specifications

### Topics:

- Chassis dimension
- Chassis weight
- Video specifications
- USB ports
- PSU rating
- Environmental Specifications

## Chassis dimension

The PowerEdge R750 has the following dimensions:

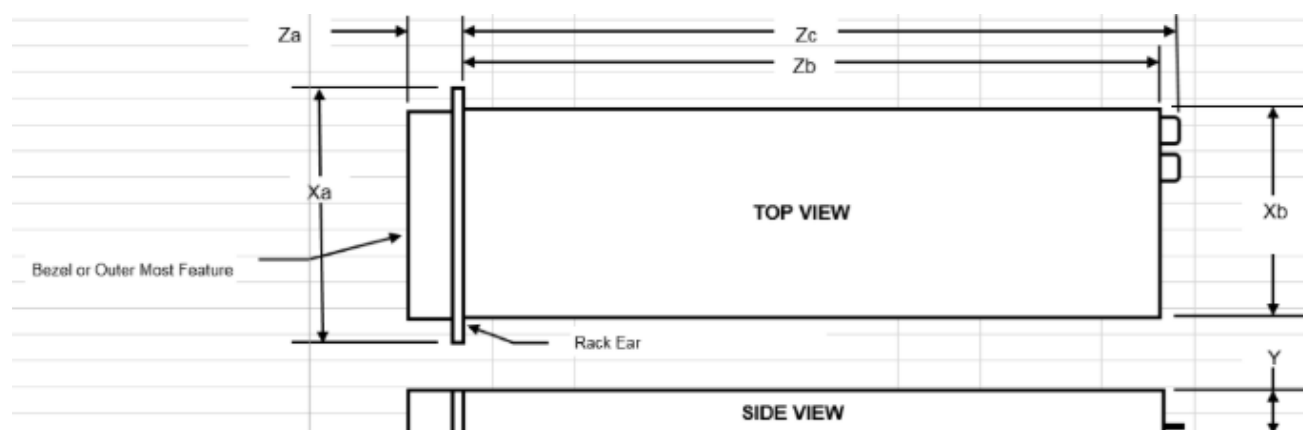

Figure 36. Chassis dimensions

Table 14. Chassis dimensions

Model number	Xa	Xb	Y	Za with bezel	Za without bezel	Zb	Zc	Max Sys Wgt	Chassis (U)
R750	482 mm	434 mm	86.8 mm	35.84 mm	22 mm	700.7 mm	736.29 mm	35.3 kg	2U

## Chassis weight

Table 15. Chassis weight

System	Maximum weight
12x 3.5-inch chassis	35.3 kg
8x 2.5-inch chassis	29.6 Kg
16x 2.5-inch chassis	32.6 kg

**Table 15. Chassis weight (continued)**

System	Maximum weight
24x 2.5-inch chassis	35.2 kg
No drive chassis	27.7 kg

## Video specifications

The PowerEdge R750 supports the following video resolution and refresh rates:

**Table 16. Video specifications for PowerEdge R750**

Resolution	Refresh Rate	Freq.	Pixel Clock	DVO DisplayPort
1024 x 768	60 Hz	48.4 kHz	65.0 MHz	Yes*
1280 x 800	60 Hz	49.7 kHz	83.5 MHz	Yes*
1280 x 1024	60 Hz	64.0 kHz	108.0 MHz	Yes*
1360 x 768	60 Hz	47.71 kHz	85.5 MHz	Yes*
1440 x 900	60 Hz	55.9 kHz	106.5 MHz	Yes*
1600 x 900	60 Hz	55.54 kHz	97.75 MHz	Yes*
1600 x 1200	60 Hz	75.0 kHz	162.0 MHz	Yes*
1680 x 1050	60 Hz	64.7 kHz	119.0 MHz	Yes*
1920 x 1080	60 Hz (RB)	67.158 kHz	173.0 MHz	No
1920 x 1200	60 Hz (RB)	74.556 kHz	193.25 MHz	No

\*DVO - DP is for investigation only, dependent on Nuvoton DVO capabilities to support up to 165MHz.

\*(RB) - Reduced Blanking for Digital Displays requiring less blank time. This was introduced for Signal Integrity improvements by reducing Pixel Clock rates for VGA- Analog input devices.

## USB ports

All USB ports follow USB specifications. Front USB 2.0 port only supports output current up to 0.5A and can't support high power consumption devices such as CD-ROM. The bottom port of the rear USB connector can support USB 3.0 to supply output current up to 0.9A.



**Figure 37. Front USB 2.0**

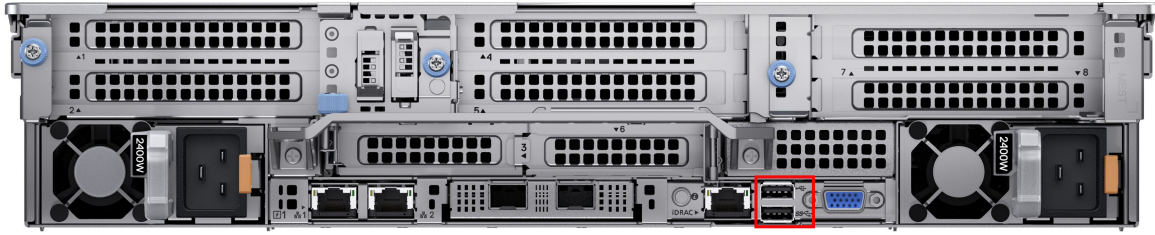

Figure 38. Rear USB 3.0 port (bottom) and USB 2.0 port (top)

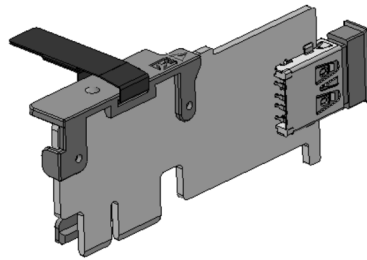

Figure 39. Internal USB 3.0 Card, size is 40 x 16 x 8 mm (L x W x H)

## PSU rating

Below table lists the power capacity the PSUs in High/Low line operation mode.

Table 17. PSUs Highline and Lowline ratings

Highline and lowline ratings	800 W Platinum	1100 W Titanium	1400 W Platinum	2400 W Platinum
Peak Power (Highline/-72 V DC)	1360 W	1870 W	2380 W	4080 W
Highline/-72 V DC	800 W	1100 W	1400 W	2400 W
Peak Power (Lowline/-40 V DC)	1360 W	1785 W	1785 W	2380 W
Lowline/-40 V DC	800 W	1050 W	1050 W	1400 W
Highline 240 V DC	800 W	1100 W	1400 W	2400 W
Highline 200-380 V DC	N/A	N/A	N/A	N/A

The PowerEdge R750 supports up to 2 AC power supplies with 1+1 redundancy, autosensing, and auto-switching capability.

If two PSUs are present during POST, a comparison is made between the wattage capacities of the PSUs. In the event that the PSU wattages don't match, the larger of the two PSU's is enabled. Also, there is a PSU mismatch warning displayed in BIOS, iDRAC, or on the System LCD.

If a second PSU is added at run-time, in order for that particular PSU to be enabled, the wattage capacity of the first PSU must equal the second PSU. Otherwise, the PSU will be flagged as unmatched in iDRAC and the second PSU will not be enabled.

Dell PSUs have achieved Platinum efficiency levels as shown in the table below.

**Table 18. PSU Efficiency Levels**

<b>Efficiency Targets by Load</b>						
<b>Output</b>	<b>Class</b>	<b>Form Factor</b>	<b>10%</b>	<b>20%</b>	<b>50%</b>	<b>100%</b>
800 W AC	Platinum	60 mm	89.00%	93.00%	94.00%	91.50%
1100 W AC	Titanium	60 mm	90.00%	94.00%	96.00%	91.50%
1400 W AC	Platinum	60 mm	89.00%	93.00%	94.00%	91.50%
2400 W AC	Platinum	86 mm	89.00%	93.00%	94.00%	91.50%

## Environmental Specifications

See the *PowerEdge R750 Technical Specifications* on [www.dell.com/poweredgemanuals](http://www.dell.com/poweredgemanuals) for detailed environmental specifications.

## Thermal restrictions

See *Dell EMC PowerEdge R750 Technical Specifications* on [www.dell.com/poweredgemanuals](http://www.dell.com/poweredgemanuals) for detailed thermal restrictions.

## Appendix B. Standards compliance

The system conforms to the following industry standards.

**Table 19. Industry standard documents**

Standard	URL for information and specifications
<b>ACPI</b> Advance Configuration and Power Interface Specification, v2.0c	<a href="https://uefi.org/specsandtesttools">https://uefi.org/specsandtesttools</a>
<b>Ethernet</b> IEEE 802.3-2005	<a href="https://standards.ieee.org/">https://standards.ieee.org/</a>
<b>HDG</b> Hardware Design Guide Version 3.0 for Microsoft Windows Server	<a href="https://microsoft.com/whdc/system/platform/pcdesign/desguide/serverdg.mspx">microsoft.com/whdc/system/platform/pcdesign/desguide/serverdg.mspx</a>
<b>IPMI</b> Intelligent Platform Management Interface, v2.0	<a href="https://intel.com/design/servers/ipmi">intel.com/design/servers/ipmi</a>
<b>DDR4 Memory</b> DDR4 SDRAM Specification	<a href="https://jedec.org/standards-documents/docs/jesd79-4.pdf">jedec.org/standards-documents/docs/jesd79-4.pdf</a>
<b>PCI Express</b> PCI Express Base Specification Rev. 2.0 and 3.0	<a href="https://pcisig.com/specifications/pciexpress">pcisig.com/specifications/pciexpress</a>
<b>PMBus</b> Power System Management Protocol Specification, v1.2	<a href="http://pmbus.org/Assets/PDFS/Public/PMBus_Specification_Part_1_Rev_1-1_20070205.pdf">http://pmbus.org/Assets/PDFS/Public/PMBus_Specification_Part_1_Rev_1-1_20070205.pdf</a>
<b>SAS</b> Serial Attached SCSI, v1.1	<a href="http://www.t10.org/">http://www.t10.org/</a>
<b>SATA</b> Serial ATA Rev. 2.6; SATA II, SATA 1.0a Extensions, Rev. 1.2	<a href="https://sata-io.org">sata-io.org</a>
<b>SMBIOS</b> System Management BIOS Reference Specification, v2.7	<a href="https://dmtf.org/standards/smbios">dmtf.org/standards/smbios</a>
<b>TPM</b> Trusted Platform Module Specification, v1.2 and v2.0	<a href="https://trustedcomputinggroup.org">trustedcomputinggroup.org</a>
<b>UEFI</b> Unified Extensible Firmware Interface Specification, v2.1	<a href="https://uefi.org/specifications">uefi.org/specifications</a>
<b>USB</b> Universal Serial Bus Specification, Rev. 2.0	<a href="https://usb.org/developers/docs">usb.org/developers/docs</a>

## Appendix C Additional resources

**Table 20. Additional resources**

Resource	Description of contents	Location
Installation and Service Manual	This manual, available in PDF format, provides the following information: <ul style="list-style-type: none"> <li>• Chassis features</li> <li>• System Setup program</li> <li>• System indicator codes</li> <li>• System BIOS</li> <li>• Remove and replace procedures</li> <li>• Diagnostics</li> <li>• Jumpers and connectors</li> </ul>	<a href="http://Dell.com/Support/Manuals">Dell.com/Support/Manuals</a>
Getting Started Guide	This guide ships with the system, and is also available in PDF format. This guide provides the following information: <ul style="list-style-type: none"> <li>• Initial setup steps</li> </ul>	<a href="http://Dell.com/Support/Manuals">Dell.com/Support/Manuals</a>
Rack Installation Guide	This document ships with the rack kits, and provides instructions for installing a server in a rack.	<a href="http://Dell.com/Support/Manuals">Dell.com/Support/Manuals</a>
System Information Label	The system information label documents the system board layout and system jumper settings. Text is minimized due to space limitations and translation considerations. The label size is standardized across platforms.	Inside the system chassis cover
Quick Resource Locator (QRL)	This code on the chassis can be scanned by a phone application to access additional information and resources for the server, including videos, reference materials, service tag information, and Dell EMC contact information.	Inside the system chassis cover
Energy Smart Solution Advisor (ESSA)	The Dell EMC online ESSA enables easier and more meaningful estimates to help you determine the most efficient configuration possible. Use ESSA to calculate the power consumption of your hardware, power infrastructure, and storage.	<a href="http://Dell.com/calc">Dell.com/calc</a>