

Dell EMC PowerEdge R6525

Technical Guide

Notes, cautions, and warnings

 **NOTE:** A NOTE indicates important information that helps you make better use of your product.

 **CAUTION:** A CAUTION indicates either potential damage to hardware or loss of data and tells you how to avoid the problem.

 **WARNING:** A WARNING indicates a potential for property damage, personal injury, or death.

Chapter 1: Product overview	5
Introduction.....	5
Featured technologies.....	5
Chapter 2: System features	7
Product comparison.....	7
Chapter 3: Chassis views and features	9
Front view of the system.....	9
Rear view of the system.....	10
Inside the system	11
Quick Resource Locator for PowerEdge R6525 system.....	12
Chapter 4: Processor	13
Processor features.....	13
Supported processors.....	14
Chapter 5: Memory	16
Supported memory.....	16
Memory speed.....	17
Chapter 6: Storage	18
Supported drives.....	18
Storage controllers.....	18
External drives.....	19
Chapter 7: Networking and PCIe	20
Expansion card installation guidelines.....	20
Chapter 8: Power, thermal, and acoustics	31
Power.....	31
Thermal	31
Acoustics.....	32
Chapter 9: Supported operating systems	33
Chapter 10: Dell EMC OpenManage systems management	34
Server and Chassis Managers.....	35
Dell EMC consoles.....	35
Automation Enablers.....	35
Integration with third-party consoles.....	35
Connections for third-party consoles.....	35
Dell EMC Update Utilities.....	35

Dell resources.....	35
Chapter 11: Dell Technologies Services	37
Dell EMC ProDeploy Enterprise Suite	37
Dell EMC ProDeploy Plus.....	38
Dell EMC ProDeploy.....	38
Basic Deployment.....	38
Dell EMC Server Configuration Services.....	38
Dell EMC Residency Services.....	38
Dell EMC Remote Consulting Services.....	38
Dell EMC Data Migration Service.....	38
Dell EMC ProSupport Enterprise Suite.....	38
Dell EMC ProSupport Plus for Enterprise.....	39
Dell EMC ProSupport for Enterprise.....	39
Dell EMC ProSupport One for Data Center.....	40
ProSupport for HPC.....	40
Support Technologies.....	41
Dell Technologies Education Services.....	42
Dell Technologies Consulting Services.....	42
Dell EMC Managed Services.....	42
Chapter 12: Appendix A. Additional specifications.....	43
Chassis dimensions.....	43
Chassis weight.....	44
Video specifications.....	44
USB ports specifications.....	45
Environmental specifications.....	45
Thermal restriction matrix.....	46
Chapter 13: Appendix B. Standards compliance.....	51
Chapter 14: Appendix C Additional resources.....	52

Product overview

Topics:

- [Introduction](#)
- [Featured technologies](#)

Introduction

The Dell EMC PowerEdge R6525 is Dell's latest 2-socket, 1U servers designed to run complex workloads using highly scalable memory, I/O, and network options. The PowerEdge R6525 features the AMD® EPYC™ Generation 2 and Generation 3 processors, supports up to 32 DIMMs, PCI Express (PCIe) Gen 4.0 enabled expansion slots, and a choice of network interface technologies to cover networking options.

The PowerEdge R6525 is a general-purpose platform capable of handling demanding workloads and applications, such as data warehouses, ecommerce, databases, and high-performance computing (HPC).

Featured technologies

The following table shows the new technologies for the PowerEdge R6525:

Table 1. New technologies

Technology	Detailed Description
AMD® EPYC™ Generation 2 and Generation 3 processors.	<ul style="list-style-type: none"> • Consult the Processor section for specific details • 7nm processor technology • AMD Inter-chip global memory interconnect (xGMI) up to 64 lanes. • Up to 64 cores per socket • Up to 3.8 GHz • Max TDP: 280W
3200 MT/s DDR4 memory	<ul style="list-style-type: none"> • Up 32 DIMMs • 8x DDR4 Channels per socket, 2 DIMMs per channel (2DPC) • Up to 3200 MT/s (configuration-dependent) • Supports RDIMM, LRDIMM and 3DS DIMM
iDRAC9 with Lifecycle Controller	The embedded systems management solution for Dell servers features hardware and firmware inventory and alerting, in-depth memory alerting, faster performance, a dedicated gigabit port and many more features.
Wireless Management	The Quick Sync feature is an extension of NFC based low bandwidth interface. Quick Sync 2.0 offers feature parity with the previous versions of the NFC interface with improved user experience. To extend this Quick Sync feature to wide variety of Mobile OS's with higher data throughput, the Quick Sync 2 version replaces previous generation NFC technology with wireless at-the-box system management.
Power supply	<ul style="list-style-type: none"> • 60mm dimension is the new PSU form factor • Platinum 800W AC or HVDC (China Only) • Platinum Mixed Mode 800W AC or HVDC (China Only) • Titanium 1100 W Mixed Mode AC/HVDC • (-48 V) 1100 W DC PSU • Platinum 1400W AC or HVDC (China Only) • Platinum Mixed Mode 1400W AC or HVDC (China Only)

Table 1. New technologies (continued)

Technology	Detailed Description
Boot Optimized Storage Subsystem S2 (BOSS S2)	Boot Optimized Storage Subsystem S2 (BOSS S2) is a RAID solution card that is designed for booting a server's operating system that supports up to: <ul style="list-style-type: none">● 80 mm M.2 SATA Solid-State Devices (SSDs)● PCIe card which is a Single Gen2 PCIe x 2 host interface● Dual SATA Gen3 device interfaces
Liquid cooling solution	The new liquid cooling solution provides efficient method to manage the system temperature. It also provides liquid leak detection mechanism via iDRAC. This technology is managed by the Liquid Leak Sensor (LLS) mechanism. LLS is able to determine liquid leaks as small as 0.02 ml or large leaks (0.2 ml).

System features

Topics:

- [Product comparison](#)

Product comparison

Table 2. Product comparison

Feature	PowerEdge R6525	PowerEdge R6415
Processor	Two AMD® EPYC™ Generation 2 or Generation 3 processors	One AMD Naples® socket SP3 compatible processor
Processor Interconnect	Interchip global memory interconnect (xGMI)	N/A
Memory	32x DDR4 RDIMM, LRDIMM, 3DS	16x DDR4 RDIMM, LRDIMM
Disk Drives	3.5-inch, 2.5-inch: 12G SAS, 6G SATA hard drive	3.5-inch, 2.5-inch: 12G SAS, 6G SATA HDD/SSD
Storage Controllers	H755N, H840, H745, HBA345, H345, HBA355, HBA355E SW RAID: S150	Mini PERC: HBA330, H330, H730P, H740P SW RAID: S140
PCIe SSD	Up to 10+2 PCIe SSD	Up to 10x PCIe SSD
PCIe Slots	Up to 3 (PCIe 4.0 x16)	Up to 2 (PCIe 3.0 x16)
NIC	No LOM riser supported on R6525.	LOM riser options: <ul style="list-style-type: none"> • 2 x 1 Gb • 2 x 10 Gb Base-T • 2 x 10 Gb SFP+
OCP	OCP 3.0 SCFF (Small Card Form Factor)	OCP 2.0 Type 1: (Connector A)
USB Ports	Front: 1x USB 2.0, 1x iDRAC USB (Micro-AB USB) Rear: 1x USB 3.0, 1x USB 2.0	Front: 1x USB2.0, 1x iDRAC USB (Micro USB) Rear: 2x USB3.1_Gen1
Rack Height	1U	1U
Power Supplies	AC/HVDC (Platinum) 800 W, 1400 W , Mixed Mode AC/HVDC (Platinum) 800 W, 1400 W, (Titanium) 1100 W Mixed Mode AC/HVDC, (-48 V) 1100 W DC PSU , (Titanium) 700 W, 1800 W Mixed Mode AC	AC (gold) 450 W cabled AC (Platinum) 550 W
System Management	LC 3.x, OpenManage, QuickSync2.0, OMPC3, Digital License Key, iDRAC Direct (dedicated micro-USB port), Easy Restore	LC 3.x, OpenManage, QuickSync2.0, OMPC3, Digital License Key, iDRAC Direct (dedicated micro-USB port), Easy Restore, vFlash
Internal GPU	<ul style="list-style-type: none"> • 2x 75 W (SW/FH) • 1x 75 W (SW/FH) 	N/A

Table 2. Product comparison (continued)

Feature	PowerEdge R6525	PowerEdge R6415
	<ul style="list-style-type: none">• 3x 75 W (SW/LP)	
Availability	Hot-plug drives, Hot-plug Redundant Power supplies, BOSS, IDSDM.	Hot-plug drives, Hot-plug Redundant Power supplies, BOSS, IDSDM.

Chassis views and features

Topics:

- Front view of the system
- Rear view of the system
- Inside the system
- [Quick Resource Locator for PowerEdge R6525 system](#)

Front view of the system

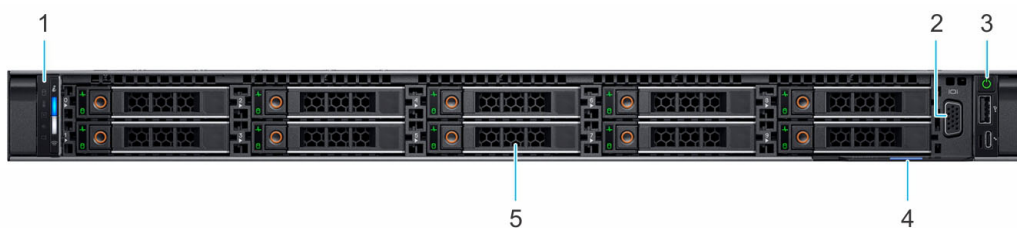

Figure 1. Front view of the 10 x 2.5-inch drive system

1. Left control panel
2. VGA port
3. Right control panel
4. Information tag
5. Drive (10)



Figure 2. Front view of the 8 x 2.5-inch drive system

1. Left control panel
2. Drive (8)
3. Right control panel
4. VGA port
5. Information tag

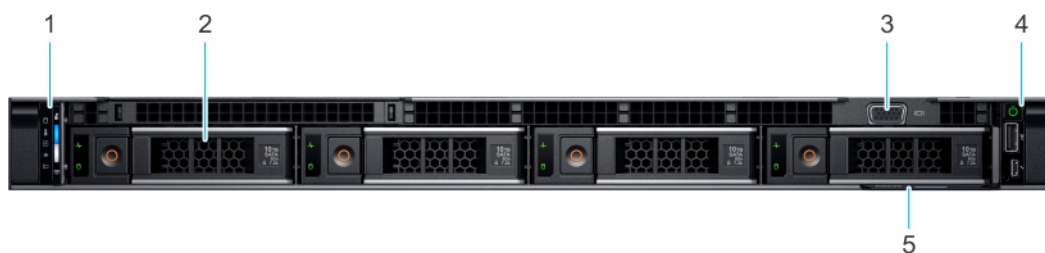

Figure 3. Front view of the 4 x 3.5-inch drive system

1. Left control panel
2. Drive (4)
3. VGA port
4. Right control panel
5. Information tag

Rear view of the system

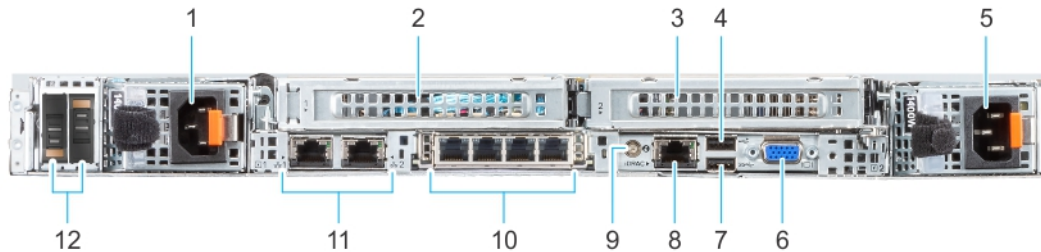

Figure 4. Rear view of the 10 x 2.5-inch drive system

1. Power supply unit (PSU 1)
2. PCIe expansion card riser (slot 1)
3. PCIe expansion card riser (slot 2)
4. USB 2.0 port (1)
5. Power supply unit (PSU 2)
6. VGA port
7. USB 3.0 port (1)
8. iDRAC dedicated port
9. System identification button
10. OCP NIC port (optional)
11. NIC port (2)
12. BOSS S2 card (optional)

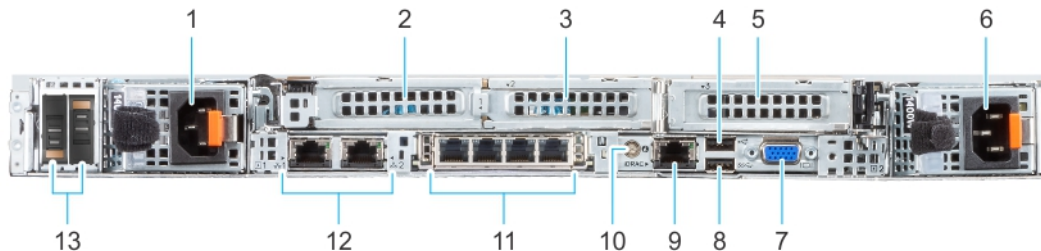

Figure 5. Rear view of the 8 x 2.5-inch drive system.

1. Power supply unit (PSU 1)
2. PCIe expansion card riser (slot 1)
3. PCIe expansion card riser (slot 2)
4. USB 2.0 port (1)
5. PCIe expansion card riser (slot 3)
6. Power supply unit (PSU 2)
7. VGA port
8. USB 3.0 port (1)
9. iDRAC dedicated port
10. System identification button
11. OCP NIC port (optional)
12. NIC port (2)
13. BOSS S2 card (optional)

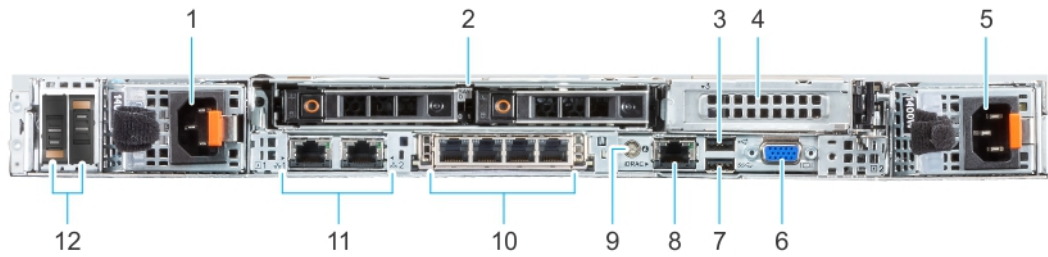

Figure 6. Rear view of the 4 x 3.5-inch drive system with 2 x 2.5-inch rear drive module

1. Power supply unit (PSU 1)
2. Rear drive module
3. USB 2.0 port (1)
4. PCIe expansion card riser (slot 3)
5. Power supply unit (PSU 2)
6. VGA port
7. USB 3.0 port (1)
8. iDRAC dedicated port
9. System identification button
10. OCP NIC port (optional)
11. NIC port (2)
12. BOSS S2 card (optional)

Inside the system

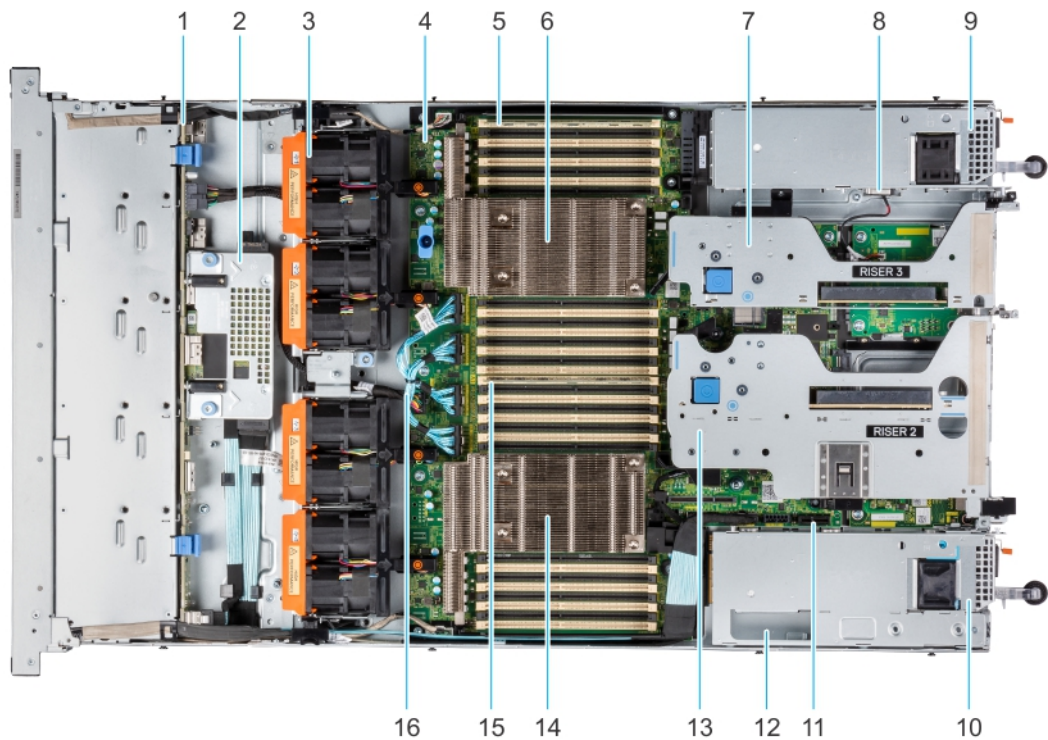

Figure 7. Inside the system

- | | |
|--|---|
| <ol style="list-style-type: none"> 1. Drive backplane 3. Dual fan module (4) 5. Memory DIMM socket for processor 2 (B1) 7. Riser 3 9. Power supply unit (PSU 2) | <ol style="list-style-type: none"> 2. Rear mounting front PERC module 4. System board 6. Heat sink for processor 2 8. Intrusion switch 10. Power supply unit (PSU 1) |
|--|---|

- 11. IDSDM/Internal USB card port
- 13. Riser 2
- 15. Memory DIMM socket for processor 1 (A1)

- 12. BOSS slot
- 14. Heat sink for processor 1
- 16. xGMI cables

Quick Resource Locator for PowerEdge R6525 system



Figure 8. Quick Resource Locator for PowerEdge R6525 system

Processor



The AMD® EPYC™ Generation 2 and Generation 3 processors supports up to 64 cores.

Topics:

- [Processor features](#)
- [Supported processors](#)

Processor features

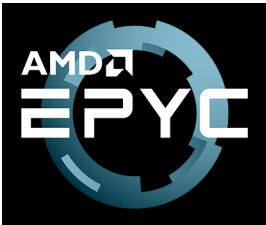

The key features of the AMD® EPYC™ Generation 2 and Generation 3 processors:

- Support up to 64 cores
- Up to 8 channels with 2 DPC per processor and 32 DIMMs in total
- Supports RDIMM, LRDIMM, NVDIMM-N, 3DS DIMM DDR4 with ECC up to 3200 MT/s
- Integrated PCI Express Gen 4 for improved bandwidth and connectivity
- Up to 128 lanes per processor

Single processor Configuration

The system is designed such that a single processor placed in the processor 1 socket will function normally. processor and memory blanks associated with processor 2 are required to be populated for thermal reasons. The system will not boot if only the processor 2 socket is populated.

With Single processor configuration, any Riser1 (xR1a/xR1b/xR2a/xR2b/aR3a/xR4c+aR4d) card and only xR1a will be functional.

Processor Restrictions

The following are AMD EPYC processor restrictions:

- The RTC/COMS is build in the processor. Therefore, by remove or re-installing the processor 1 the RTC/COMS will be lost
- AMD does not support early boot. There is no error message when there is no memory populating in the system

Supported processors

Table 3. Supported processor for the PowerEdge R6525

Processor model number	Base frequency in GHz	Cores/Threads	TDP in W	L3 Cache in MB	Max DDR frequency (1 DPC) MHz
7773X	3.50	64/128	280	768	3200
7573X	3.60	32/64	280	768	3200
7473X	3.70	24/48	240	768	3200
7373X	3.80	16/32	240	768	3200
7763	2.45	64/128	280	256	3200
7742	2.25	64/128	225	256	3200
7713P	2.0	64	225	256	3200
7713	2.0	64/128	225	256	3200
7702	2.00	64/128	200	256	3200
7663	2.0	56	240	256	3200
7662	2.0	64/128	225	256	3200
7643	2.3	48	225	256	3200
7642	2.30	48/96	225	256	3200
7552	2.20	48/96	200	192	3200
7543P	2.8	32	225	256	3200
75F3	2.95	32/64	280	256	3200
7543	2.8	32/64	225	256	3200
7532	2.40	32/64	200	256	3200
7542	2.90	32/64	225	128	3200
7513	2.60	32	200	128	3200
7502	2.50	32/64	180	128	3200
74F3	3.2	24	240	256	3200
7452	2.35	32/64	155	128	3200
7443P	2.85	24	200	128	3200
7443	2.85	24	200	128	3200
7413	2.65	24/48	180	128	3200
7402	2.80	24/48	180	128	3200
7352	2.30	24/48	155	128	3200
7343	2.4	32	200	128	3200
7313P	3.0	16	155	128	3200
7313	3.00	16/32	155	128	3200
7302	3.00	16/32	155	128	3200
72F3	3.7	8	180	256	3200
7262	3.20	8/16	155	128	3200

Table 3. Supported processor for the PowerEdge R6525 (continued)

Processor model number	Base frequency in GHz	Cores/Threads	TDP in W	L3 Cache in MB	Max DDR frequency (1 DPC) MHz
7282	2.80	16/32	120	64	3200
7272	2.90	12/24	120	64	3200
7232P	3.10	8/16	120	32	3200
7H12	2.60	64/128	280	256	3200
7F72	3.2	NA	240	192	3200
7F52	3.5	NA	240	256	3200
7F32	3.7	NA	180	128	3200

Memory

The PowerEdge R6525 system supports up to 32 DIMMS, 2 TB of memory, and speeds up to 3200MT/s.

The R6525 support registered (RDIMMs) and load reduced DIMMs (LRDIMMs) which use a buffer to reduce memory loading and provide greater density, allowing for the maximum platform memory capacity. Unbuffered DIMMs (UDIMMs) are not supported.

Topics:

- [Supported memory](#)
- [Memory speed](#)

Supported memory

The following table lists the memory technologies that are supported by the R6525:

Table 4. Memory technology comparison

Feature	R6525(DDR4)
DIMM type	RDIMM
	LRDIMM
Transfer speed	3200 MT/s
	2666 MT/s
Voltage	1.2 V

The following table shows the supported DIMMs for the PowerEdge R6525:

Table 5. supported DIMMs for the PowerEdge R6525

DIMM Speed(MT/s)	DIMM Type	DIMM Capacity(GB)	Ranks per DIMM	Data Width	DIMM Volts	Minimum RAM	Maximum RAM
3200	RDIMM	8	1	8	1.2	8 GB	128 GB
3200	RDIMM	16	2	8	1.2	16 GB	256 GB
3200	RDIMM	32	2	8	1.2	32 GB	512 GB
3200	RDIMM	32	2	4	1.2	32 GB	512 GB
3200	RDIMM	64	2	4	1.2	64 GB	1 TB
2666	LRDIMM	128	8	4	1.2	128 GB	2 TB
3200	LRDIMM	128	4	4	1.2	128 GB	2 TB

NOTE: The older 32 GB capacity RDIMM memory with x4 data width and 8Gb DRAM density cannot be mixed with the newer 32 GB capacity RDIMM memory with x8 data width and 16Gb DRAM density in the same AMD EPYC™ processor unit.

Memory speed

Table 6. Supported memory matrix

DIMM type	Rank	Capacity	DIMM rated voltage and speed	AMD EPYC™ processor	
				1 DIMM per channel (1DPC)	2 DIMMs per channel (2DPC)
RDIMM	1R	8 GB	DDR4 (1.2V), 3200 MT/s	3200 MT/s	2933 MT/s
	2R	16 GB, 32 GB, 64 GB	DDR4 (1.2V), 3200 MT/s	3200 MT/s	2933 MT/s
LRDIMM	8R	128 GB	DDR4 (1.2V), 2666 MT/s	2666 MT/s	2666 MT/s
	4R	128 GB	DDR4 (1.2V), 3200 MT/s	3200 MT/s	2933 MT/s

NOTE: The older 32 GB capacity RDIMM memory with x4 data width and 8Gb DRAM density cannot be mixed with the newer 32 GB capacity RDIMM memory with x8 data width and 16Gb DRAM density in the same AMD EPYC™ processor unit.

NOTE: The older 128 GB capacity LRDIMM memory at 2666 MT/s speed cannot be mixed with the new 128 GB capacity LRDIMM memory at 3200 MT/s speed.

Storage

The PowerEdge R6525 enables multiple storage configurations to tune the system configuration for variety of workloads. The R6525 is available in the following configuration types:

- 4 x 3.5-inch backplane configuration with support up to 4 SAS/SATA drives
- 8 x 2.5-inch backplane configuration with support up to 8 SAS/SATA drives
- 10 x 2.5-inch backplane configuration with support up to 10 SAS/SATA/NVMe drives
- 10 (front) + 2 (rear) x 2.5-inch hot-swappable SAS, SATA , or NVMe drives

Topics:

- [Supported drives](#)
- [Storage controllers](#)
- [External drives](#)

Supported drives

Table 7. Supported drives - SAS and SATA or SSD

Form Factor	Type	Speed	Rotational Speed	Capacities
2.5-inch	SAS	12 Gb	10 K	300 GB, 600 GB, 1.2 TB, 1.8 TB, 1.2 TB (SED/FIPS), 2.4 TB, 2.4 TB (SED/FIPS)
	SATA	6 Gb	7.2 K	1 TB, 2 TB
	SATA SSD (M.2)	6 Gb	N/A	120 GB, 240 GB
	SAS SSD	12 Gb	N/A	400 GB, 800 GB, 960 GB, 1.633 TB, 1.92 TB, 3.2 TB, 3.840 TB, 1.92 TB (SED/FIPS)
	SATA SSD	6 Gb	N/A	120 GB, 200 GB, 240 GB, 300 GB, 400 GB, 480 GB, 800 GB, 960 GB, 1.2 TB, 1.6 TB, 1.92 TB, 3.84 TB
	SAS	12 Gb	15 K	300 GB, 600 GB, 900 GB
	SAS	12 Gb	7.2 K	1 TB, 2 TB, 4 TB, 6 TB, 8 TB, 10 TB, 2 TB (SED/FIPS)
3.5-inch	SATA	6 Gb	7.2 K	1 TB, 2 TB, 4 TB, 6 TB, 8 TB, 10 TB
	SAS	12 Gb	7.2 K	1 TB, 2 TB, 4 TB, 8 TB, 10 TB, 4 TB (SED FIPS), 8 TB (SED FIPS)
2.5-inch	NVMe SSD (U.2)	Gen4	N/A	960 GB, 1.6TB, 1.92TB, 3.2TB, 3.84TB, 6.4TB, 7.68TB, 12.8TB, 15.36TB

Storage controllers

Dell EMC RAID controller options offer performance improvements, including the Mini PERC solution. Mini PERC provides a base RAID HW controller without consuming a PCIe slot by using a small form factor and high density connector to the base planar.

The following table shows the supported storage controllers for the PowerEdge R6525:

Table 8. Supported storage controllers

Performance level	Description
Entry	S150 (SATA, NVMe) Software RAID SATA
Value	H745 (internal), H345, HBA345 (internal), H840 (external), 12Gbps SAS HBA (external)
Value Performance	H755N (internal), HBA355 (internal), HBA355E (external)

External drives

The following table shows the supported external storage for the PowerEdge R6525:

Table 9. Supported external storage

Device Type	Description
External Tape	Supports connection to external USB tape products
NAS/IDM appliance software	Supports NAS software stack
JBOD	Supports connection to 12Gb MD-series JBODs

Networking and PCIe

The PowerEdge R6525 system supports two Network Interface Controller (NIC) ports embedded on the LOM card.

The PowerEdge R6525 system also supports OCP NIC port integrated on the optional OCP card.

Table 10. NIC port specification

Feature	Specifications
LOM card	1 GB x 2
OCP card (OCP 3.0)	1 GbE x 4, 10 GbE x 2, 25 GbE x 2, 25 GbE x 4, 50 GbE x 2, 100 GbE x 2

Topics:

- [Expansion card installation guidelines](#)

Expansion card installation guidelines

The following table describes the supported expansion cards:

Table 11. Expansion card riser configurations

Expansion card riser	PCIe slots on the riser	Processor connection	Height	Length	Slot width
R1a (Riser 1)	Slot 1	Processor 1	Full Height	3/4th Length	x16
R2a (Riser 2)	Slot 1	Processor 1	Low Profile	Half Length	x16
	Slot 2	Processor 2	Low Profile	Half Length	x16
R3a (Riser 3)	Slot 3	Processor 2	Low Profile	Half Length	x16
R4c + R4d (Riser 4)	Slot 2	Processor 2	Full Height	3/4th Length	x16

NOTE: The expansion-card slots are not hot-swappable.

The following table provides guidelines for installing expansion cards to ensure proper cooling and mechanical fit. The expansion cards with the highest priority should be installed first using the slot priority indicated. All the other expansion cards should be installed in the card priority and slot priority order.

Table 12. Configuration 0 - No riser

Card type	Slot priority	Maximum number of cards
Broadcom (OCP: 25 Gb)	Internal Slot	1
QLogic (OCP: 25 Gb)	Internal Slot	1
Mellanox (OCP: 25 Gb)	Internal Slot	1
Intel (OCP: 10 Gb)	Internal Slot	1
Broadcom (OCP: 10 Gb)	Internal Slot	1
QLogic (OCP: 10 Gb)	Internal Slot	1
Inventec (ASSY,CRD,CTL,BOSS,ADPT,S2V2,15G)	Internal Slot	1

Table 12. Configuration 0 - No riser (continued)

Card type	Slot priority	Maximum number of cards
Broadcom (OCP: 1 Gb)	Internal Slot	1
Intel (OCP: 1 Gb)	Internal Slot	1
SolarFlare (OCP: 25 Gb)	Internal Slot	1
FOXCONN (Front PERC)	Internal Slot	1
ASSY,CRD,CTL,H755,FRONT	Internal Slot	1

Table 13. Configuration 1: R1a

Card type	Slot priority	Maximum number of cards
Mellanox (NIC: 100 Gb)	1	1
Intel (NIC: 25 Gb)	1	1
Mellanox (NIC: 25 Gb)	1	1
QLogic (NIC: 25 Gb)	1	1
Emulex (HBA: FC32)	1	1
QLogic (HBA: FC32)	1	1
Emulex (HBA: FC64, FH)	1	1
Emulex (HBA: FC16)	1	1
QLogic (HBA: FC16)	1	1
FOXCONN (HBA355E)	1	1
Intel (NIC: 10 Gb)	1	1
Broadcom (NIC: 10 Gb)	1	1
QLogic (NIC: 10 Gb)	1	1
Intel (NIC: 1 Gb)	1	1
Broadcom (NIC: 1 Gb)	1	1
Mellanox (NIC: HDR100 VPI)	1	1
Dell PERC Adapter	1	1
Dell BOSS Adapter	1	1
Samsung (PCIE SSD)	1	1
Intel (PCIE SSD)	1	1
Broadcom (NIC: 10Gb)	1	1
Intel (NIC: 25Gb)	1	1
Intel (NIC: 100Gb)	1	1
Emulex (CRD,CTL,EMLX,FH,FC32,1P,S28)	1	1
Intel (CRD,NTWK,INTL,FH,25G,2P,S28,F1)	1	1
Intel (CRD,NTWK,INTL,LP,25G,2P,S28,F10)	Not supported	0
Inventec (ASSY,CRD,CTL,BOSS,ADPT,S2V2,15G)	Internal Slot	1

Table 13. Configuration 1: R1a (continued)

Card type	Slot priority	Maximum number of cards
FOXCONN (Front PERC)	Internal Slot	1
Dell Front PERC	Internal Slot	1
Broadcom (OCP: 25 Gb)	Internal Slot	1
QLogic (OCP: 25 Gb)	Internal Slot	1
Mellanox (OCP: 25 Gb)	Internal Slot	1
Intel (OCP: 10 Gb)	Internal Slot	1
Broadcom (OCP: 10 Gb)	Internal Slot	1
QLogic (OCP: 10 Gb)	Internal Slot	1
Broadcom (OCP: 1 Gb)	Internal Slot	1
Intel (OCP: 1 Gb)	Internal Slot	1
SolarFlare (OCP: 25 Gb)	Internal Slot	1
Intel (OCP: 25 Gb)	Internal Slot	1
FOXCONN (Front PERC, ASSY,CRD,CTL,H755,FRONT)	Internal Slot	1
Emulex (HBA FC 32, FH,FC32,2P,V1.1)	1	1

Table 14. Configuration 2: R2a + R3a

Card type	Slot priority	Maximum number of cards
Inventec (BOSS)	1	1
GPU: NVIDIA T4 16 GB (Low Profile)	2, 1, 3	3
GPU: NVIDIA A2 16GB (Low Profile)	2, 1, 3	3
Mellanox (NIC: 100 Gb)	2, 1, 3	3
Mellanox (NIC: 50 Gb)	2, 1, 3	3
Intel (NIC: 25 Gb)	2, 1, 3	3
Mellanox (NIC: 25 Gb)	2, 1, 3	3
SolarFlare (NIC: 25 Gb)	2, 1, 3	3
Broadcom (NIC: 25 Gb)	2, 1, 3	3
QLogic (NIC: 25 Gb)	2, 1, 3	3
Emulex (HBA: FC64 LP)	2, 1, 3	3
Emulex (HBA: FC32)	2, 1, 3	3
QLogic (HBA: FC32)	2, 1, 3	3
Emulex (HBA: FC16)	2, 1, 3	3
QLogic (HBA: FC16)	2, 1, 3	3
FOXCONN (HBA355E)	2, 1, 3	2
Intel (NIC: 10 Gb)	2, 1, 3	3
Broadcom (NIC: 10 Gb)	2, 1, 3	3
QLogic (NIC: 10 Gb)	2, 1, 3	3
Intel (NIC: 1 Gb)	2, 1, 3	3

Table 14. Configuration 2: R2a + R3a (continued)

Card type	Slot priority	Maximum number of cards
Broadcom (NIC: 1 Gb)	2, 1, 3	3
Mellanox (NIC: HDR100 VPI)	2, 1, 3	3
Mellanox (NIC: HDR VPI)	2, 1, 3	3
Foxconn (External adapter)	2, 1, 3	3
Samsung (PCIe SSD)	2, 1, 3	3
Intel (PCIe SSD)	2, 1, 3	3
Intel (NIC: 100Gb)	2, 1, 3	3
Broadcom (NIC: 10Gb)	2, 1, 3	3
Emulex (CRD,CTL,EMLX,LP,FC32,1P,S28)	2, 1, 3	3
Intel (CRD,NTWK,INTL,LP,25G,2P,S28,F1)	2, 1, 3	3
Inventec (ASSY,CRD,CTL,BOSS,ADPT,S2V2,15G)	Internal Slot	1
Inventec (Front PERC)	Internal Slot	1
Foxconn (Front PERC)	Internal Slot	1
Mellanox (OCP: 100 Gb)	Internal Slot	1
Mellanox (OCP: 50 Gb)	Internal Slot	1
Broadcom (OCP: 25 Gb)	Internal Slot	1
QLogic (OCP: 25 Gb)	Internal Slot	1
Mellanox (OCP: 25 Gb)	Internal Slot	1
SolarFlare (OCP: 25 Gb)	Internal Slot	1
Intel (OCP: 25 Gb)	Internal Slot	1
Intel (OCP: 10 Gb)	Internal Slot	1
Broadcom (OCP: 10 Gb)	Internal Slot	1
QLogic (OCP: 10 Gb)	Internal Slot	1
QLogic (CRD,CTL,MRVL,LP,FC32,1P,S28,F1)	2, 1, 3	3
Broadcom (OCP: 1 Gb)	Internal Slot	1
Intel (OCP: 1 Gb)	Internal Slot	1
Intel (OCP: 25Gb)	Internal Slot	1
Foxconn (Front PERC, ASSY,CRD,CTL,H755,FRONT)	Internal Slot	1
Emulex (HBA FC 32, LP,FC32,2P,V1.1)	2,1,3	3

Table 15. Configuration 4: R1a + R4c +R4d

Card type	Slot priority	Maximum number of cards
Dell BOSS Adapter	2, 1	1
GPU: NVIDIA T4 16 GB (Full Height)	2 ,1	2
GPU: NVIDIA A2 16GB (Full Height)	2, 1	2

Table 15. Configuration 4: R1a + R4c +R4d (continued)

Card type	Slot priority	Maximum number of cards
Mellanox (NIC: 100 Gb)	2, 1	2
Intel (NIC: 25 Gb)	2, 1	2
Mellanox (NIC: 25 Gb)	2, 1	2
Broadcom (NIC: 25 Gb)	2, 1	2
QLogic (NIC: 25 Gb)	2, 1	2
Emulex (HBA: FC64 FH)	2, 1	2
Emulex (HBA: FC32)	2, 1	2
QLogic (HBA: FC32)	2, 1	2
Emulex (HBA: FC16)	2, 1	2
QLogic (HBA: FC16)	2, 1	2
FOXCONN (HBA355E)	2, 1	2
Intel (NIC: 10 Gb)	2, 1	2
Broadcom (NIC: 10 Gb)	2, 1	2
QLogic (NIC: 10 Gb)	2, 1	2
Intel (NIC: 1 Gb)	2, 1	2
Broadcom (NIC: 1 Gb)	2, 1	2
Dell PERC Adapter	2, 1	2
Samsung (PCIe SSD)	2, 1	2
Intel (PCIe SSD)	2, 1	2
Intel (NIC: 25Gb)	2, 1	2
Intel (NIC: 100Gb)	2, 1	2
Broadcom (NIC: 10Gb)	2,1	2
Emulex (CRD,CTL,EMLX,FH,FC32,1P,S28)	2, 1	2
CRD,NTWK,INTL,FH,25G,2P,S28,F1	2, 1	2
Inventec (ASSY,CRD,CTL,BOSS,ADPT,S2V2,15G)	Internal Slot	1
FOXCONN (Front PERC)	Internal Slot	1
Dell Front PERC	Internal Slot	1
Broadcom (OCP: 25 Gb)	Internal Slot	1
QLogic (OCP: 25 Gb)	Internal Slot	1
Mellanox (OCP: 25 Gb)	Internal Slot	1
Intel (OCP: 10 Gb)	Internal Slot	1
Broadcom (OCP: 10 Gb)	Internal Slot	1
QLogic (OCP: 10 Gb)	Internal Slot	1
Broadcom (OCP: 1 Gb)	Internal Slot	1
Intel (OCP: 1 Gb)	Internal Slot	1
SolarFlare (OCP: 25 Gb)	Internal Slot	1

Table 15. Configuration 4: R1a + R4c +R4d (continued)

Card type	Slot priority	Maximum number of cards
Intel (OCP: 25Gb)	Internal Slot	1
ASSY,CRD,CTL,H755,FRONT	Internal Slot	1
Emulex (HBA FC 32, FH,FC32,2P,V1.1)	2,1	2

Table 16. Configuration 5: R3a

Card type	Slot priority	Maximum number of cards
Mellanox (NIC: 100 Gb)	3	1
Mellanox (NIC: 50 Gb)	3	1
Intel (NIC: 25 Gb)	3	1
Mellanox (NIC: 25 Gb)	3	1
SolarFlare (NIC: 25 Gb)	3	1
Broadcom (NIC: 25 Gb)	3	1
QLogic (NIC: 25 Gb)	3	1
Emulex (HBA: FC64 LP)	3	1
Emulex (HBA: FC32)	3	1
QLogic (HBA: FC32)	3	1
Emulex (HBA: FC16)	3	1
QLogic (HBA: FC16)	3	1
FOXCONN (HBA355E)	3	1
Intel (NIC: 10 Gb)	3	1
Broadcom (NIC: 10 Gb)	3	1
QLogic (NIC: 10 Gb)	3	1
Intel (NIC: 1 Gb)	3	1
Broadcom (NIC: 1 Gb)	3	1
Foxconn (External adapter)	3	1
Inventec (BOSS)	3	1
Samsung (PCIe SSD)	3	1
Intel (PCIe SSD)	3	1
Intel (NIC: 100Gb, LP)	3	1
Broadcom (NIC: 10Gb)	3	1
QLogic (CRD,CTL,MRVL,LP,FC32,1P,S28,F1)	3	1
Emulex (CRD,CTL,EMLX,LP,FC32,1P,S28)	3	1
Intel (CRD,NTWK,INTL,LP,25G,2P,S28,F1)	3	1
Inventec (ASSY,CRD,CTL,BOSS,ADPT,S2V2,15G)	Internal Slot	1
Inventec (Front PERC)	Internal Slot	1

Table 16. Configuration 5: R3a (continued)

Card type	Slot priority	Maximum number of cards
Foxconn (Front PERC)	Internal Slot	1
Mellanox (OCP: 100 Gb)	Internal Slot	1
Mellanox (OCP: 50 Gb)	Internal Slot	1
Broadcom (OCP: 25 Gb)	Internal Slot	1
QLogic (OCP: 25 Gb)	Internal Slot	1
Mellanox (OCP: 25 Gb)	Internal Slot	1
SolarFlare (OCP: 25 Gb)	Internal Slot	1
Intel (OCP: 25 Gb)	Internal Slot	1
Intel (OCP: 10 Gb)	Internal Slot	1
Broadcom (OCP: 10 Gb)	Internal Slot	1
QLogic (OCP: 10 Gb)	Internal Slot	1
Broadcom (OCP: 1 Gb)	Internal Slot	1
Intel (OCP: 1 Gb)	Internal Slot	1
Intel (OCP: 25 Gb)	Internal Slot	1
FOXCONN (Front OERC, ASSY,CRD,CTL,H755,FRONT)	Internal Slot	1
Emulex (HBA FC 32, LP,FC32,2P,V1.1)	3	1

Table 17. Configuration 6: R1D+R2A+R3A

Card type	Slot priority	Maximum number of cards
Inventec (Serial)	3	1
GPU: NVIDIA T4 16 GB (Low Profile)	2, 1, 3	3
GPU: NVIDIA A2 16GB (Low Profile)	2, 1, 3	3
Mellanox (NIC: 100Gb)	2, 1, 3	3
Broadcom (NIC: 100Gb)	2, 1, 3	3
Intel (NIC: 100Gb)	2, 1, 3	3
Mellanox (NIC: 50Gb)	2, 1, 3	3
QLogic (NIC: 25Gb)	2, 1, 3	3
Intel (NIC: 25Gb)	2, 1, 3	3
Mellanox (NIC: 25Gb)	2, 1, 3	3
Broadcom (NIC: 25Gb)	2, 1, 3	3
Mellanox (NIC: 25Gb)	2, 1, 3	3
Emulex (HBA: FC64 LP)	2, 1, 3	3
Emulex (HBA: FC32)	2, 1, 3	3
QLogic (HBA: FC32)	2, 1, 3	3
Emulex (HBA: FC16)	2, 1, 3	3
Emulex (HBA: FC16)	2, 1, 3	3
QLogic (HBA: FC16)	2, 1, 3	3

Table 17. Configuration 6: R1D+R2A+R3A (continued)

Card type	Slot priority	Maximum number of cards
QLogic (NIC: 10Gb)	2, 1, 3	3
Intel (NIC: 10Gb)	2, 1, 3	3
Broadcom (NIC: 10Gb)	2, 1, 3	3
Intel (NIC: 1Gb)	2, 1, 3	3
Broadcom (NIC: 1Gb)	2, 1, 3	3
Mellanox (NIC: HDR100 VPI)	2, 1, 3	3
Mellanox (NIC:HDR VPI)	2, 1, 3	3
Broadcom (OCP: 100Gb)	Internal Slot	1
Broadcom (OCP: 25Gb)	Internal Slot	1
QLogic (OCP: 25Gb)	Internal Slot	1
Mellanox (OCP: 25Gb)	Internal Slot	1
SolarFlare (OCP: 25Gb)	Internal Slot	1
Intel (OCP: 25Gb)	Internal Slot	1
Intel (OCP: 10Gb)	Internal Slot	1
Broadcom (OCP: 10Gb)	Internal Slot	1
QLogic (OCP: 10Gb)	Internal Slot	1
Broadcom (OCP: 10Gb)	Internal Slot	1
Intel (OCP: 1Gb)	Internal Slot	1
FOXCONN H840 (External Adapter)	2, 1, 3	2
FOXCONN HBA355E (External Adapter)	2, 1, 3	2
FOXCONN 12GB SAS HBA (External Adapter)	2, 1, 3	2
Inventec (BOSS-S2)	Internal Slot	1
Inventec (BOSS-S1)	2, 1, 3	1
SAMSUNG (PCIE SSD)	2, 1, 3	3
INTEL (PCIE SSD)	2, 1, 3	3
Inventec (Serial IO)	3	1

Table 18. Configuration 8: R1A

Card type	Slot priority	Maximum number of cards
FOXCONN H755 (Front PERC)	Internal Slot	1
INVENTEC H745 (Front PERC)	Internal Slot	1
FOXCONN H345 (Front PERC)	Internal Slot	1
FOXCONN H355 (Front PERC)	Internal Slot	1
FOXCONN H355I (Front PERC)	Internal Slot	1
Mellanox (NIC: 100Gb)	1	1
Intel (NIC: 100Gb)	1	1
Broadcom (NIC: 100Gb)	1	1

Table 18. Configuration 8: R1A (continued)

Card type	Slot priority	Maximum number of cards
QLogic (NIC: 25Gb)	1	1
Broadcom (NIC: 25Gb)	1	1
Intel (NIC: 25Gb)	1	1
Mellanox (NIC: 25Gb)	1	1
Emulex (HBA: FC64 FH)	1	1
Emulex (HBA: FC32)	1	1
QLogic (HBA: FC32)	1	1
Emulex (HBA: FC16)	1	1
QLogic (HBA: FC16)	1	1
QLogic (NIC: 10Gb)	1	1
QLogic (NIC: 10Gb)	1	1
QLogic (NIC: 10Gb)	1	1
Intel (NIC: 10Gb)	1	1
Broadcom (NIC: 10Gb)	1	1
QLogic (NIC: 10Gb)	1	1
Intel (NIC: 1Gb)	1	1
Broadcom (NIC: 1Gb)	1	1
Mellanox (NIC: HDR100 VPI)	1	1
Mellanox (NIC:HDR VPI)	1	1
Broadcom (OCP: 100Gb)	Internal Slot	1
Broadcom (OCP: 25Gb)	Internal Slot	1
QLogic (OCP: 25Gb)	Internal Slot	1
Mellanox (OCP: 25Gb)	Internal Slot	1
SolarFlare (OCP: 25Gb)	Internal Slot	1
Intel (OCP: 25Gb)	Internal Slot	1
Intel (OCP: 10Gb)	Internal Slot	1
Broadcom (OCP: 10Gb)	Internal Slot	1
QLogic (OCP: 10Gb)	Internal Slot	1
Broadcom (OCP: 1Gb)	Internal Slot	1
Intel (OCP: 1Gb)	Internal Slot	1
FOXCONN HBA355E (External Adapter)	1	1
FOXCONN 12GB SAS HBA (External Adapter)	1	1
Inventec (BOSS-S2)	Internal Slot	1
Inventec (BOSS-S1)	1	1
SAMSUNG (PCIE SSD)	1	1
SAMSUNG (PCIE SSD)	1	1
INTEL (PCIE SSD)	1	1

Table 19. Configuration 9: R1A+R4C+R4D

Card type	Slot priority	Maximum number of cards
GPU NVIDIA T4 16 GB (Full Height)	2, 1	2
GPU: NVIDIA A2 16GB (Full Height)	2, 1	2
FOXCONN H755 (Front PERC)	Internal Slot	1
INVENTEC H745 (Front PERC)	Internal Slot	1
FOXCONN H345 (Front PERC)	Internal Slot	1
FOXCONN H355 (Front PERC)	Internal Slot	1
FOXCONN H355I (Front PERC)	Internal Slot	1
FOXCONN H345 (Front PERC)	Internal Slot	1
Mellanox (NIC: 100Gb)	2, 1	2
Intel (NIC: 100Gb)	2, 1	2
Broadcom (NIC: 100Gb)	2, 1	2
QLogic (NIC: 25Gb)	2, 1	2
Broadcom (NIC: 25Gb)	2, 1	2
Intel (NIC: 25Gb)	2, 1	2
Mellanox (NIC: 25Gb)	2, 1	2
Emulex (HBA: FC64 FH)	2, 1	2
Emulex (HBA: FC32)	2, 1	2
QLogic (HBA: FC32)	2, 1	2
Emulex (HBA: FC16)	2, 1	2
QLogic (HBA: FC16)	2, 1	2
QLogic (NIC: 10Gb)	2, 1	2
Intel (NIC: 10Gb)	2, 1	2
Broadcom (NIC: 10Gb)	2, 1	2
QLogic (NIC: 10Gb)	2, 1	2
Intel (NIC: 1Gb)	2, 1	2
Broadcom (NIC: 1Gb)	2, 1	2
Mellanox (NIC: HDR100 VPI)	2, 1	2
Mellanox (NIC:HDR VPI)	2, 1	2
Broadcom (OCP: 100Gb)	Internal Slot	1
Broadcom (OCP: 25Gb)	Internal Slot	1
QLogic (OCP: 25Gb)	Internal Slot	1
Mellanox (OCP: 25Gb)	Internal Slot	1
SolarFlare (OCP: 25Gb)	Internal Slot	1
Intel (OCP: 25Gb)	Internal Slot	1
Intel (OCP: 10Gb)	Internal Slot	1
Broadcom (OCP: 10Gb)	Internal Slot	1
QLogic (OCP: 10Gb)	Internal Slot	1

Table 19. Configuration 9: R1A+R4C+R4D (continued)

Card type	Slot priority	Maximum number of cards
Broadcom (OCP: 1Gb)	Internal Slot	1
Intel (OCP: 1Gb)	Internal Slot	1
FOXCONN H840 (External Adapter)	2, 1	2
FOXCONN HBA355E (External Adapter)	2, 1	2
FOXCONN 12GB SAS HBA (External Adapter)	2, 1	2
Inventec (BOSS -S2)	Internal Slot	1
Inventec (BOSS-S1)	2, 1	1
SAMSUNG (PCIE SSD)	2, 1	2
SAMSUNG (PCIE SSD)	2, 1	2
INTEL (PCIE SSD)	2, 1	2

Power, thermal, and acoustics

Topics:

- Power
- Thermal
- Acoustics

Power

The PowerEdge R6525 system has an extensive collection of sensors that automatically track thermal activity, and helps to regulate temperature and reduce server noise and power consumption.

Table 20. Power tools and technologies

Feature	Description
PSU portfolio	Dell EMC's PSU portfolio includes intelligent features such as dynamically optimizing power usage while maintaining availability and redundancy.
Industry compliance	Dell EMC's servers are compliant with all relevant industry certifications and guidelines, including 80 PLUS, Climate Savers, and ENERGY STAR.
Power monitoring accuracy	PSU power monitoring improvements include: <ul style="list-style-type: none"> • Power monitoring accuracy of 1%, lower than the industry standard of 5% • Higher power reporting accuracy • Better performance under a power cap
Power capping	Use Dell EMC systems management software to set your system power cap to limit the output of a PSU and reduce system power consumption.
Systems management	iDRAC Enterprise provides server level management that monitors, reports, and controls power consumption at the processor, memory, and system level. Dell OpenManage Power Center delivers group power management at the rack, row, and data center level for servers, power distribution units, and uninterruptible power supplies.
Active power management	Node Manager is an embedded technology that provides individual server- level power reporting and power limiting functionality. Hot spare technology reduces consumption of redundant power supplies.
Fresh air cooling	See dell.com/fresh-air-cooling
Rack infrastructure	Dell EMC offers some of the industry's highest efficiency power infrastructure solutions, including: <ul style="list-style-type: none"> • Power distribution units (PDUs) • Uninterruptible power supplies (UPSs) • Energy Smart containment rack enclosures For additional information see: http://content.dell.com/us/en/enterprise/power-and-cooling-technologies-components-rack-infrastructure.aspx .

Thermal

The thermal management of the platform helps deliver high performance with the right amount of cooling to components, while maintaining the lowest fan speeds possible. This is done across a wide range of ambient temperatures from 10°C to 35°C (50°F to 95°F) and to extended ambient temperature ranges.

The thermal design of the PowerEdge R6525 reflects the following:

- Optimized thermal design: architecture built into the system layout.
- System component placement and layout are designed to provide maximum airflow coverage to critical components with minimum expense of fan power.
- Comprehensive thermal management achieved by regulating the fan speed based on several different responses from all system component temperature sensors, as well as inventory for system configurations. Temperature monitoring includes components such as processors, DIMMs, chipset, the inlet air ambient, hard disk drives, and LOM riser.
- Open and closed loop thermal fan control uses system configuration to determine fan speed based on inlet air ambient temperature. Closed loop thermal control method uses feedback temperatures to dynamically determine proper fan speeds.
- User-configurable settings in the iDRAC BIOS setup screen.

Cooling N+1 fan redundancy allows continuous operation with one fan failure in the system.

Acoustics

The PowerEdge R6525 is a rack-mount server appropriate for attended data center environment. However, lower acoustical output is attainable with proper hardware or software configurations. For example, the minimum configuration of R6525 is quiet enough for typical office environment.

Table 21. PowerEdgeR6525 acoustical performance

Configuration	Entry	Volume - 1 (HPC)	Volume - 2 (Rear Storage)	Margin Rich
Acoustical Category	Category 2	Category 4	Category 3	Category 5
CPU Type	AMD® EPYC™ Generation 2 and Generation 3 processors	AMD EPYC Generation 2 and Generation 3 processors	AMD EPYC Generation 2 and Generation 3 processors	AMD EPYC Generation 2 and Generation 3 processors
CPU TDP	120 W (8 cores)	E 200 W (64 cores)	120 W (16 cores)	225 W (64 cores)
CPU Quantity	1	2	2	2
Memory Type	8 GB DDR4 RDIMM	32 GB DDR4 RDIMM	16 GB DDR4 RDIMM	64 GB DDR4 RDIMM
DIMM Quantity	8	16	8	32
Backplane Type	4x 3.5-inch	10x 2.5-inch	4x 3.5-inch + 2x 2.5-inch	10x 2.5-inch
Hard drive Type	3.5-inch SATA 1 TB	2.5-inch SAS 1-K 2.4 TB + 2.5-inch NVMe	3.5-inch SAS 4 TB + 2.5-inch SSD	Intel P4500 2 TB NVMe SSD
Hard drive Quantity	2	6+4	4+2	10
PSU Type	800 W	1400 W	800 W	1400 W
PSU Quantity	2	2	2	2
PCI 1		Dual Port 25 GbE		Dual Port 200 GbE
PCI 2		Dual Port 25 GbE		
Front PERC	PERC H345	PERC H745P	PERC H745P	PERC H745P
OCP	Dual Port 10 GbE	Dual Port 25 GbE	Dual Port 10 GbE	Dual Port 25 GbE

Supported operating systems

The PowerEdge R6525 supports the following operating systems:

- Canonical Ubuntu Server LTS
- Citrix XenServer
- Microsoft Windows Server with Hyper-V
- Red Hat Enterprise Linux
- SUSE Linux Enterprise Server
- VMware vSAN/ESXi

For more information, see www.dell.com/ossupport.

Dell EMC OpenManage systems management

Dell EMC OpenManage Portfolio

Simplifying hardware management through ease of use and automation

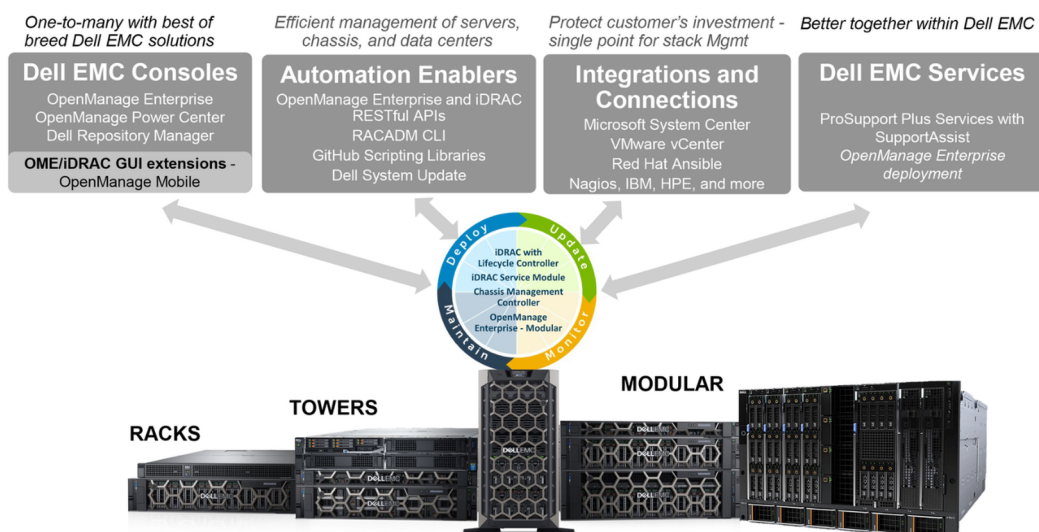

Figure 9. Dell EMC OpenManage Portfolio

Dell EMC delivers management solutions that help IT Administrators effectively deploy, update, monitor, and manage IT assets. OpenManage solutions and tools enable you to quickly respond to problems by helping them to manage Dell EMC servers effectively and efficiently; in physical, virtual, local, and remote environments, operating in-band, and out-of-band (agent-free). The OpenManage portfolio includes innovative embedded management tools such as the integrated Dell Remote Access Controller (iDRAC), Chassis Management Controller and Consoles like OpenManage Enterprise, OpenManage Power Manager plug in, and tools like Repository Manager.

Dell EMC has developed comprehensive systems management solutions based on open standards and has integrated with management consoles that can perform advanced management of Dell hardware. Dell EMC has connected or integrated the advanced management capabilities of Dell hardware into offerings from the industry's top systems management vendors and frameworks such as Ansible, thus making Dell EMC platforms easy to deploy, update, monitor, and manage.

The key tools for managing Dell EMC PowerEdge servers are iDRAC and the one-to-many OpenManage Enterprise console. OpenManage Enterprise helps the system administrators in complete lifecycle management of multiple generations of PowerEdge servers. Other tools such as Repository Manager, which enables simple yet comprehensive change management.

OpenManage tools integrate with systems management framework from other vendors such as VMware, Microsoft, Ansible, and ServiceNow. This enables you to use the skills of the IT staff to efficiently manage Dell EMC PowerEdge servers.

Topics:

- [Server and Chassis Managers](#)
- [Dell EMC consoles](#)
- [Automation Enablers](#)
- [Integration with third-party consoles](#)
- [Connections for third-party consoles](#)
- [Dell EMC Update Utilities](#)
- [Dell resources](#)

Server and Chassis Managers

- Integrated Dell Remote Access Controller (iDRAC)
- iDRAC Service Module (iSM)

Dell EMC consoles

- Dell EMC OpenManage Enterprise
- Dell EMC Repository Manager (DRM)
- Dell EMC OpenManage Enterprise Power Manager plugin to OpenManage Enterprise
- Dell EMC OpenManage Mobile (OMM)

Automation Enablers

- OpenManage Ansible Modules
- iDRAC RESTful APIs (Redfish)
- Standards-based APIs (Python, PowerShell)
- RACADM Command Line Interface (CLI)
- GitHub Scripting Libraries

Integration with third-party consoles

- Dell EMC OpenManage Integrations with Microsoft System Center
- Dell EMC OpenManage Integration for VMware vCenter (OMIVV)
- Dell EMC OpenManage Ansible Modules
- Dell EMC OpenManage Integration with ServiceNow

Connections for third-party consoles

- Micro Focus and other HPE tools
- OpenManage Connection for IBM Tivoli
- OpenManage Plug-in for Nagios Core and XI

Dell EMC Update Utilities

- Dell System Update (DSU)
- Dell EMC Repository Manager (DRM)
- Dell EMC Update Packages (DUP)
- Dell EMC Server Update Utility (SUU)
- Dell EMC Platform Specific Bootable ISO (PSBI)

Dell resources

For additional information about white papers, videos, blogs, forums, technical material, tools, usage examples, and other information, go to the OpenManage page at <https://www.dell.com/openmanagemanuals> or the following product pages:

Table 22. Dell resources

Resource	Location
Integrated Dell Remote Access Controller (iDRAC)	https://www.dell.com/idracmanuals
iDRAC Service Module (iSM)	https://www.dell.com/support/kbdoc/000178050/
OpenManage Ansible Modules	https://www.dell.com/support/kbdoc/000177308/
OpenManage Essentials (OME)	https://www.dell.com/support/kbdoc/000175879/
OpenManage Mobile (OMM)	https://www.dell.com/support/kbdoc/000176046
OpenManage Integration for VMware vCenter (OMIVV)	https://www.dell.com/support/kbdoc/000176981/
OpenManage Integration for Microsoft System Center (OMIMSSC)	https://www.dell.com/support/kbdoc/000147399
Dell EMC Repository Manager (DRM)	https://www.dell.com/support/kbdoc/000177083
Dell EMC System Update (DSU)	https://www.dell.com/support/kbdoc/000130590
Dell EMC Platform Specific Bootable ISO (PSBI)	Dell.com/support/article/sln296511
Dell EMC Chassis Management Controller (CMC)	www.dell.com/support/article/sln311283
OpenManage Connections for Partner Consoles	https://www.dell.com/support/kbdoc/000146912
OpenManage Enterprise Power Manager	https://www.dell.com/support/kbdoc/000176254
OpenManage Integration with ServiceNow (OMISNOW)	Dell.com/support/article/sln317784

 **NOTE:** Features may vary by server. Please refer to the product page on <https://www.dell.com/manuals> for details.

Dell Technologies Services

Dell Technologies Services include a wide, customizable range of service choices to simplify the assessment, design, implementation, management and maintenance of IT environments and to help you transition from platform to platform. Depending on your current business requirements and the level of service right for you, we provide factory, on-site, remote, modular, and specialized services that fit your needs and budget. We'll help with a little or a lot—your choice—and provide access to our global resources.

For more information, see DellEMC.com/Services.

Topics:

- [Dell EMC ProDeploy Enterprise Suite](#)
- [Dell EMC Remote Consulting Services](#)
- [Dell EMC Data Migration Service](#)
- [Dell EMC ProSupport Enterprise Suite](#)
- [Dell EMC ProSupport Plus for Enterprise](#)
- [Dell EMC ProSupport for Enterprise](#)
- [Dell EMC ProSupport One for Data Center](#)
- [ProSupport for HPC](#)
- [Support Technologies](#)
- [Dell Technologies Education Services](#)
- [Dell Technologies Consulting Services](#)
- [Dell EMC Managed Services](#)

Dell EMC ProDeploy Enterprise Suite

ProDeploy Enterprise Suite gets your server out of the box and into optimized production—fast. Our elite deployment engineers with broad and deep experience utilizing best-in-class processes along with our established global scale can help you around the clock and around the globe. From simple to the most complex server installations and software integration, we take the guess work and risk out of deploying your new server technology.

		Basic Deployment	ProDeploy	ProDeploy Plus
Pre-deployment	Single point of contact for project management	-	●	In-region
	Site readiness review	-	●	●
	Implementation planning	-	●	●
	SAM engagement for ProSupport Plus entitled devices	-	-	●
Deployment	Deployment service hours	Business hours	24x7	24x7
	Remote guidance for hardware installation or Onsite hardware installation and packaging material removal	Onsite	Remote or Onsite	Onsite
	Install and configure system software	-	Remote	Onsite
	Install support software and connect with Dell Technologies	-	●	●
	Project documentation with knowledge transfer	-	●	●
	Post-deployment	Deployment verification	-	●
Configuration data transfer to Dell EMC technical support		-	●	●
30-days of post-deployment configuration assistance		-	-	●
Training credits for Dell EMC Education Services		-	-	●

Figure 10. ProDeploy Enterprise Suite capabilities

NOTE: Hardware installation not applicable on selected software products.

Dell EMC ProDeploy Plus

From beginning to end, ProDeploy Plus provides the skill and scale needed to successfully execute demanding deployments in today's complex IT environments. Certified Dell EMC experts start with extensive environmental assessments and detailed migration planning and recommendations. Software installation includes set up of most versions of Dell EMC SupportAssist and OpenManage system management utilities. Post-deployment configuration assistance, testing, and product orientation services are also available.

Dell EMC ProDeploy

ProDeploy provides full service installation and configuration of both server hardware and system software by certified deployment engineers including set up of leading operating systems and hypervisors as well as most versions of Dell EMC SupportAssist and OpenManage system management utilities. To prepare for the deployment, we conduct a site readiness review and implementation planning exercise. System testing, validation, and full project documentation with knowledge transfer complete the process.

Basic Deployment

Basic Deployment delivers worry-free professional installation by experienced technicians who know Dell EMC servers inside and out.

Dell EMC Server Configuration Services

With Dell EMC Rack Integration and other Dell EMC PowerEdge Server Configuration Services, you save time by receiving your systems racked, cabled, tested, and ready to integrate into the data center. Dell EMC staff pre-configure RAID, BIOS and iDRAC settings, install system images, and even install third-party hardware and software.

For more information, see [Server Configuration Services](#).

Dell EMC Residency Services

Residency Services helps customers transition to new capabilities quickly with the assistance of on-site or remote Dell EMC experts whose priorities and time you control. Residency experts can provide post implementation management and knowledge transfer related to a new technology acquisition or day-to-day operational management of the IT infrastructure.

Dell EMC Remote Consulting Services

When you are in the final stages of your PowerEdge server implementation, you can rely on Dell EMC Remote Consulting Services and our certified technical experts to help you optimize your configuration with best practices for your software, virtualization, server, storage, networking, and systems management.

Dell EMC Data Migration Service

Protect your business and data with our single point of contact to manage your data migration project. Your project manager will work with our experienced team of experts to create a plan using industry-leading tools and proven processes based on global best practices to migrate your existing files and data so your business system get up and running quickly and smoothly.

Dell EMC ProSupport Enterprise Suite

With the ProSupport Enterprise Suite, we help keep your IT systems running smoothly, so you can focus on running your business. We will help maintain peak performance and availability of your most essential workloads. ProSupport Enterprise Suite is a suite of support services that enable you to build the solution that is right for your organization.

Choose support models based on how you use technology and where you want to allocate resources. From the desktop to the data center, address everyday IT challenges, such as unplanned downtime, mission-critical needs, data and asset protection, support planning, resource allocation, software application management and more. Optimize IT resources by choosing the right support model.

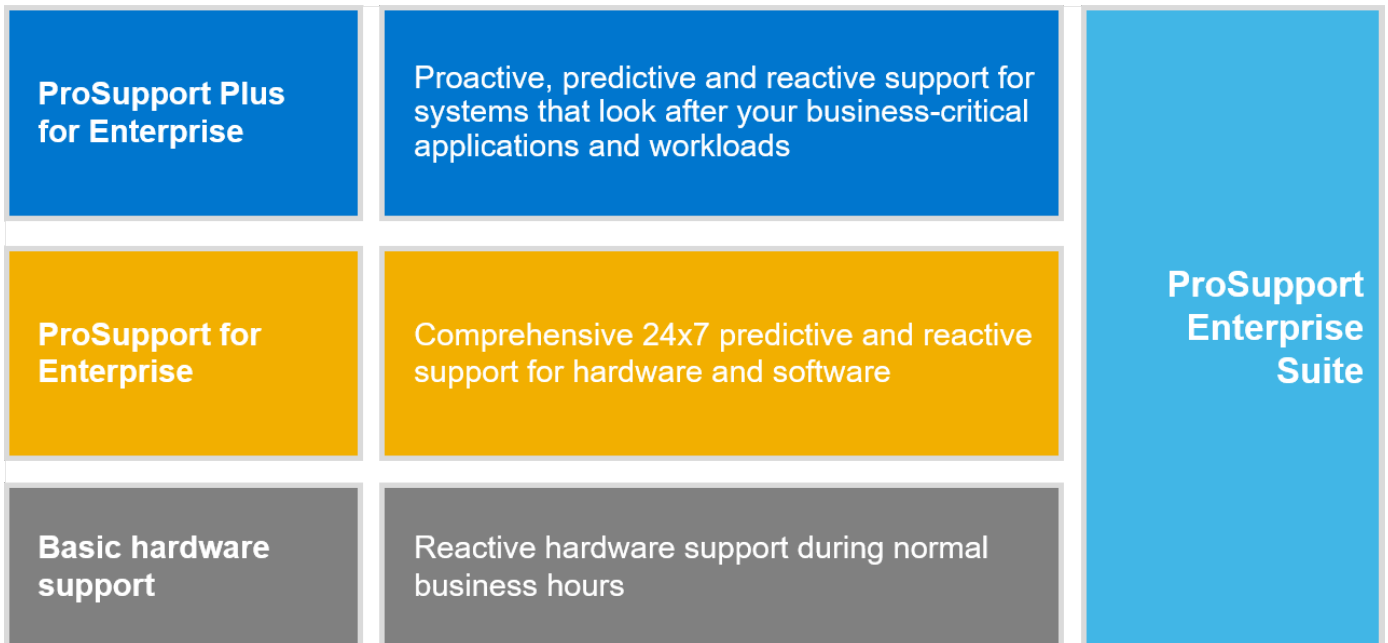

Figure 11. Dell EMC ProSupport Enterprise Suite

Dell EMC ProSupport Plus for Enterprise

When you purchase your PowerEdge server, we recommend ProSupport Plus, our proactive and preventative support service for your business-critical systems. ProSupport Plus provides you with all the benefits of ProSupport, plus the following:

- An assigned Services Account Manager who knows your business and your environment
- Immediate advanced troubleshooting from an engineer who understands your PowerEdge server
- Personalized, preventive recommendations based on analysis of support trends and best practices from across the Dell Technologies infrastructure solutions customer base to reduce support issues and improve performance
- Predictive analysis for issue prevention and optimization enabled by SupportAssist
- Proactive monitoring, issue detection, notification, and automated case creation for accelerated issue resolution enabled by SupportAssist
- On-demand reporting and analytics-based recommendations enabled by SupportAssist and TechDirect

Dell EMC ProSupport for Enterprise

Our ProSupport service offers highly trained experts around the clock and around the globe to address your IT needs. We help minimize disruptions and maximize availability of PowerEdge server workloads with:

- 24x7 support through phone, chat and online
- Predictive, automated tools and innovative technology
- A central point of accountability for all hardware and software issues
- Collaborative 3rd party support
- Hypervisor, operating system and application support
- Consistent experience regardless of where you are located or what language you speak
- Optional onsite parts and labor response options including next business day or four-hour mission critical

i **NOTE:** Subject to service offer country availability.

Enterprise Support Services Feature Comparison

	Basic	ProSupport	ProSupport Plus
Remote technical support	9x5	24x7	24x7
Covered products	Hardware	Hardware Software	Hardware Software
Onsite hardware support	Next business day	Next business day or 4hr mission critical	Next business day or 4 hr mission critical
3 rd party collaborative assistance		●	●
Automated issue detection & proactive case creation		●	●
Self-service case initiation and management		●	●
Access to software updates		●	●
Priority access to specialized support experts			●
3 rd party software support			●
Assigned Services Account Manager			●
Personalized assessments and recommendations			●
Semiannual systems maintenance			●

Availability and terms of Dell Technologies services vary by region and by product. For more information, please view our Service Descriptions available on Dell.com

Figure 12. Dell EMC Enterprise Support model

Dell EMC ProSupport One for Data Center

ProSupport One for Data Center offers flexible site-wide support for large and distributed data centers with more than 1,000 assets. This offering is built on standard ProSupport components that leverage our global scale but are tailored to your company's needs. While not for everyone, this service option offers a truly unique solution for Dell Technologies largest customers with the most complex environments.

- Team of assigned Services Account Managers with remote, on-site options
- Assigned ProSupport One technical and field engineers who are trained on your environment and configurations
- On-demand reporting and analytics-based recommendations enabled by SupportAssist and TechDirect
- Flexible on-site support and parts options that fit your operational model
- A tailored support plan and training for your operations staff

ProSupport for HPC

The ProSupport for HPC provides solution-aware support including:

- Access to senior HPC experts
- Advanced HPC cluster assistance: performance, interoperability & configuration
- Enhanced HPC solution level end-to-end support
- Remote pre-support engagement with HPC Specialists during ProDeploy implementation

Learn more at DellEMC.com/HPC-Services.

ProSupport Add-on for HPC

Delivering a true end-to-end support experience across your HPC environment

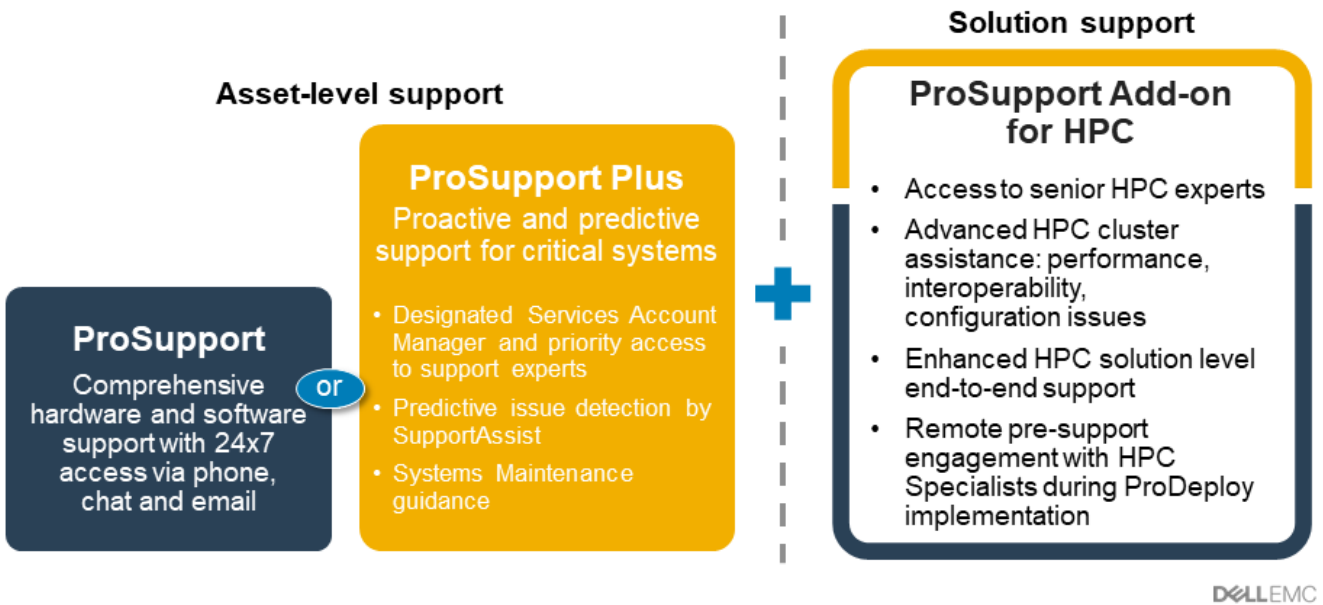

Figure 13. ProSupport for HPC

Support Technologies

Powering your support experience with predictive, data-driven technologies.

Dell EMC SupportAssist

The best time to solve a problem is before it happens. The automated proactive and predictive technology SupportAssist helps reduce steps and time to resolution, often detecting issues before they become a crisis. Benefits include:

- Value—SupportAssist is available to all customers at no additional charge
- Improve productivity—replace manual, high-effort routines with automated support
- Accelerate time to resolution—receive issue alerts, automatic case creation, and proactive contact from Dell EMC experts
- Gain insight and control—optimize enterprise devices with on-demand ProSupport Plus reporting in TechDirect, and get predictive issue detection before the problem starts

NOTE: SupportAssist is included with all support plans, but features vary based on service level agreement.

	Basic Hardware Warranty	ProSupport	ProSupport Plus
Automated issue detection and system state information collection	•	•	•
Proactive, automated case creation and notification		•	•
Predictive issue detection for failure prevention			•
Recommendation reporting available on-demand in TechDirect			•

Figure 14. SupportAssist model

Get started at Dell.com/SupportAssist

Dell EMC TechDirect

Boost IT team productivity when supporting Dell EMC systems. With over 1.4 million self-dispatches processed each year, TechDirect has proven its effectiveness as a support tool. You can:

- Self-dispatch replacement parts
- Request technical support
- Integrate APIs into your help desk

Or, access all your Dell EMC certification and authorization requirements. Train your staff on Dell EMC products, as TechDirect allows you to:

- Download study guides
- Schedule certification and authorization exams
- View transcripts of completed courses and exams

Register at techdirect.dell.

Dell Technologies Education Services

Build the IT skills required to influence the transformational outcomes of the business. Enable talent and empower teams with the right skills to lead and execute transformational strategy that drives competitive advantage. Leverage the training and certification required for real transformation.

Dell Technologies Education Services offers PowerEdge server training and certifications designed to help you achieve more from your hardware investment. The curriculum delivers the information and the practical, hands-on skills that you and your team need to confidently install, configure, manage, and troubleshoot your Dell EMC servers. To learn more or register for a class today, see LearnDell.com/Server.

Dell Technologies Consulting Services

Our expert consultants help you transform faster, and quickly achieve business outcomes for the high value workloads Dell EMC PowerEdge systems can handle.

From strategy to full-scale implementation, Dell Technologies Consulting can help you determine how to execute your IT, workforce, or application transformation.

We use prescriptive approaches and proven methodologies combined with Dell Technologies' portfolio and partner ecosystem to help you achieve real business outcomes. From multi-cloud, applications, DevOps, and infrastructure transformations, to business resiliency, data center modernization, analytics, workforce collaboration, and user experiences—we're here to help.

Dell EMC Managed Services

Reduce the cost, complexity, and risk of managing IT. Focus your resources on digital innovation and transformation while our experts help optimize your IT operations and investment with managed services backed by guaranteed service levels.

Appendix A. Additional specifications

Topics:

- Chassis dimensions
- Chassis weight
- Video specifications
- USB ports specifications
- Environmental specifications

Chassis dimensions

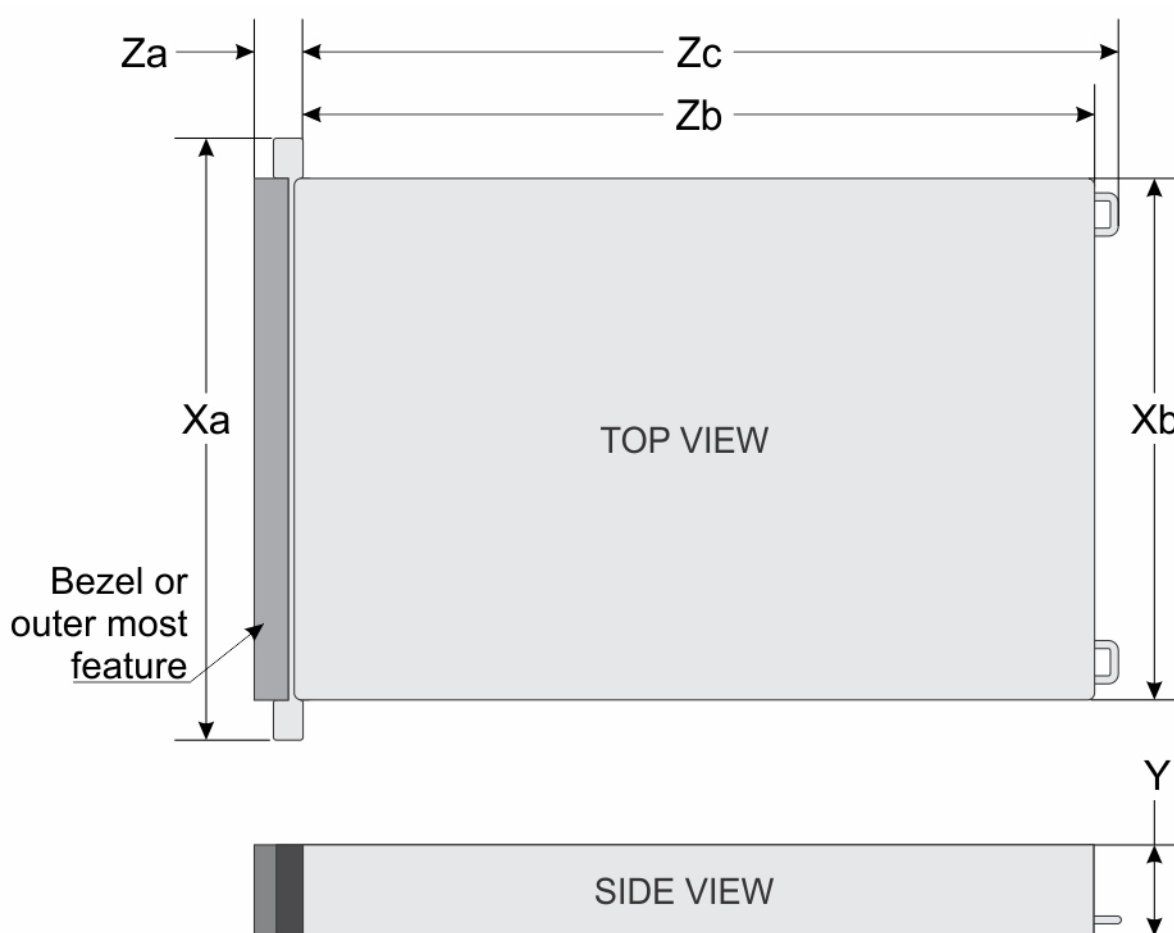

Figure 15. Chassis dimensions

Table 23. PowerEdge R6525 chassis dimensions

Drives	Xa	Xb	Y	Za	Zb	Zc
Eight drives	482.0 mm (18.97 inches)	434.0 mm (17.08 inches)	42.8 mm (1.68 inches)	With bezel: 35.84 mm (1.4 inches)	700.53 mm (27.58 inches)	736.27 mm (28.98 inches)

Table 23. PowerEdge R6525 chassis dimensions (continued)

Drives	Xa	Xb	Y	Za	Zb	Zc
				Without bezel: 22.0 mm (0.87 inches)	(Ear to rear wall)	(Ear to PSU handle)
Four or ten drives	482.0 mm (18.97 inches)	434.0 mm (17.08 inches)	42.8 mm (1.68 inches)	With bezel: 35.84 mm (1.4 inches) Without bezel: 22.0 mm (0.87 inches)	751.48 mm (29.58 inches) (Ear to I/O label)	787.05 mm (30.98 inches) (Ear to PSU handle)

NOTE: Zb* is the nominal rear wall external surface where the system board I/O connectors reside.

Chassis weight

Table 24. PowerEdge R6525 chassis weight

System configuration	Maximum weight (with all drives/SSDs)
4 x 3.5-inch	21.8 kg (48.06 lb)
8 x 2.5-inch	19.2 kg (42.33 lb)
10 x 2.5-inch	21.8 kg (48.06 lb)

Video specifications

The PowerEdge R6525 system supports an integrated Matrox G200 graphics controller with 16 MB of video frame buffer.

Table 25. Supported front video resolution options

Resolution	Refresh rate (Hz)	Color depth (bits)
1024 x 768	60	8, 16, 32
1280 x 800	60	8, 16, 32
1280 x 1024	60	8, 16, 32
1360 x 768	60	8, 16, 32
1440 x 900	60	8, 16, 32

Table 26. Supported rear video resolution options

Resolution	Refresh rate (Hz)	Color depth (bits)
1024 x 768	60	8, 16, 32
1280 x 800	60	8, 16, 32
1280 x 1024	60	8, 16, 32
1360 x 768	60	8, 16, 32
1440 x 900	60	8, 16, 32
1600 x 900	60	8, 16, 32
1600 x 1200	60	8, 16, 32
1680 x 1050	60	8, 16, 32
1920 x 1080	60	8, 16, 32

Table 26. Supported rear video resolution options (continued)

Resolution	Refresh rate (Hz)	Color depth (bits)
1920 x 1200	60	8, 16, 32

USB ports specifications

Table 27. PowerEdge R6525 system USB specifications

Front		Rear		Internal	
USB port type	No. of ports	USB port type	No. of ports	USB port type	No. of ports
USB 2.0-compliant port	One	USB 3.0-compliant ports	One	Internal USB 3.0-compliant port	One
Micro-USB 2.0 compliant port	One	USB 2.0-compliant ports	One		

NOTE: The micro USB 2.0 compliant port can only be used as an iDRAC Direct or a management port.

Environmental specifications

The following sections contain information about the environmental specifications of PowerEdge R6525.

NOTE: For additional information about environmental certifications, refer to the *Product Environmental Datasheet* located with the Manuals & Documents on <https://www.dell.com/support/>

Table 28. Operational climatic range category A2

Temperature	Specifications
Allowable continuous operations	
Temperature ranges for altitudes <= 900 m (<= 2953 ft)	10–35°C (50–95°F) with no direct sunlight on the equipment
Humidity percent ranges (noncondensing at all times)	8% RH with -12°C minimum dew point to 80% RH with 21°C (69.8°F) maximum dew point
Operational altitude de-rating	Maximum temperature is reduced by 1°C/300 m (1.8°F/984 Ft) above 900 m (2953 Ft)

Table 29. Operational climatic range category A3

Temperature	Specifications
Allowable continuous operations	
Temperature ranges for altitudes <= 900 m (<= 2953 ft)	5–40°C (41–104°F) with no direct sunlight on the equipment
Humidity percent ranges (noncondensing at all times)	8% RH with -12°C minimum dew point to 85% RH with 24°C (75.2°F) maximum dew point
Operational altitude de-rating	Maximum temperature is reduced by 1°C/175 m (1.8°F/574 Ft) above 900 m (2953 Ft)

Table 30. Operational climatic range category A4

Temperature	Specifications
Allowable continuous operations	

Table 30. Operational climatic range category A4 (continued)

Temperature	Specifications
Temperature ranges for altitudes <= 900 m (<= 2953 ft)	5–45°C (41–113°F) with no direct sunlight on the equipment
Humidity percent ranges (noncondensing at all times)	8% RH with -12°C minimum dew point to 90% RH with 24°C (75.2°F) maximum dew point
Operational altitude de-rating	Maximum temperature is reduced by 1°C/125 m (1.8°F/410 Ft) above 900 m (2953 Ft)

Table 31. Shared requirements across all categories

Temperature	Specifications
Allowable continuous operations	
Maximum temperature gradient (applies to both operation and non-operation)	20°C in an hour* (36°F in an hour) and 5°C in 15 minutes (9°F in 15 minutes), 5°C in an hour* (9°F in an hour) for tape <i>i</i> NOTE: * - Per ASHRAE thermal guidelines for tape hardware, these are not instantaneous rates of temperature change.
Non-operational temperature limits	-40 to 65°C (-104 to 149°F)
Non-operational humidity limits	5% to 95% RH with 27°C (80.6°F) maximum dew point
Maximum non-operational altitude	12,000 meters (39,370 feet)
Maximum operational altitude	3,048 meters (10,000 feet)

Table 32. Maximum vibration specifications

Maximum vibration	Specifications
Operating	0.26 G _{rms} at 5 Hz to 350 Hz (all operation orientations)
Storage	1.88 G _{rms} at 10 Hz to 500 Hz for 15 minutes (all six sides tested)

Table 33. Maximum shock pulse specifications

Maximum shock pulse	Specifications
Operating	Six consecutively executed shock pulses in the positive and negative x, y, and z axis of 6 G for up to 11 ms.
Storage	Six consecutively executed shock pulses in the positive and negative x, y, and z axis (one pulse on each side of the system) of 71 G for up to 2 ms.

Thermal restriction matrix

Table 34. Thermal restriction matrix

Configuration		4 x 3.5-inch			8 x 2.5-inch		10 x 2.5-inch SAS			10 x 2.5-inch NVMe	
Rear configuration		3 LP/ 2 FH	Rear 2 x 2.5-inch SAS	Rear 2 x 2.5-inch NVMe	3 LP/ 2 FH	Rear 2 x 2.5-inch NVMe (single processor)	3 LP/ 2 FH	Rear 2 x 2.5-inch SAS	Rear 2 x 2.5-inch NVMe	3 LP/ 2 FH	Rear 2 x 2.5-inch NVMe
CPU TDP	CPU cTDP Max										
120 W	150 W	STD fan	HPR Fan	HPR Fan	STD fan	HPR Fan	VHP fan	VHP fan	VHP fan	VHP fan	VHP fan

Table 34. Thermal restriction matrix (continued)

Configuration		4 x 3.5-inch			8 x 2.5-inch		10 x 2.5-inch SAS			10 x 2.5-inch NVMe	
Rear configuration		3 LP/ 2 FH	Rear 2 x 2.5-inch SAS	Rear 2 x 2.5-inch NVMe	3 LP/ 2 FH	Rear 2 x 2.5-inch NVMe (single processor)	3 LP/ 2 FH	Rear 2 x 2.5-inch SAS	Rear 2 x 2.5-inch NVMe	3 LP/ 2 FH	Rear 2 x 2.5-inch NVMe
CPU TDP	CPU cTDP Max										
		STD HSK	STD HSK	STD HSK	STD HSK	STD HSK	STD HSK	STD HSK	STD HSK	STD HSK	STD HSK
155 W	180 W	STD fan STD HSK	HPR Fan STD HSK	HPR Fan STD HSK	STD fan STD HSK	HPR Fan STD HSK	VHP fan STD HSK	VHP fan STD HSK	VHP fan STD HSK	VHP fan STD HSK	VHP fan STD HSK
180 W	200 W	HPR fan L-type HSK	HPR Fan L-type HSK	HPR Fan L-type HSK	HPR fan L-type HSK	HPR Fan L-type HSK	VHP fan L-type HSK	VHP fan L-type HSK	VHP fan L-type HSK	VHP fan L-type HSK	VHP fan L-type HSK
200 W	200 W	HPR fan L-type HSK	HPR Fan L-type HSK	HPR Fan L-type HSK	HPR fan L-type HSK	HPR Fan L-type HSK	VHP fan L-type HSK	VHP fan L-type HSK	VHP fan L-type HSK	VHP fan L-type HSK	VHP fan L-type HSK
225 W	240 W	HPR fan L-type HSK	HPR Fan L-type HSK	HPR Fan L-type HSK	HPR fan L-type HSK	HPR Fan L-type HSK	VHP fan L-type HSK	VHP fan L-type HSK	VHP fan L-type HSK	VHP fan L-type HSK	VHP fan L-type HSK
280 W - 64C (7H12,7763)		HPR fan* L-type HSK	HPR Fan* L-type HSK	HPR Fan* L-type HSK	HPR fan L-type HSK	HPR Fan* L-type HSK	VHP fan* L-type HSK	VHP fan* L-type HSK	VHP fan* L-type HSK	VHP fan L-type HSK	VHP fan* L-type HSK
280 W - 32C (75F3)		-	-	-	VHP fan* L-type HSK	-	VHP fan* L-type HSK	-	-	VHP fan* L-type HSK	-
280 W - 64C/32C/24C 280 W (7773X,7573X,7473X)		-	-	-	-	-	VHP fan L-type HSK	VHP fan* L-type HSK	VHP fan* L-type HSK	-	-
280 W - 16C 280 W (7373X)		-	-	-	-	-	VHP fan** L-type HSK	-	-	-	-
T4 or A2 GPU		HPR fan*	HPR Fan*	HPR Fan*	HPR fan*	-	VHP fan*	VHP fan*	VHP fan*	VHP fan*	VHP fan*

NOTE: * Supported ambient temperature is 30°C.

NOTE: ** Supported ambient temperature is 25°C.

Table 35. Liquid cooling thermal restriction matrix

Configuration		4 x 3.5-inch			8 x 2.5-inch	10 x 2.5-inch SAS			10 x 2.5-inch NVMe	
Rear storage		3 LP/ 2 FH	Rear 2 x 2.5-inch SAS	Rear 2 x 2.5-inch NVMe	3 LP/ 2 FH	3 LP/ 2 FH	Rear 2 x 2.5-inch SAS	Rear 2 x 2.5-inch NVMe	3 LP/ 2 FH	Rear 2 x 2.5-inch NVMe
CPU TDP	CPU cTDP Max									
120 W	150 W	HPR fan	HPR fan	HPR fan	HPR fan	HPR fan	HPR fan	HPR fan	HPR fan	HPR fan
155 W	180 W	HPR fan	HPR fan	HPR fan	HPR fan	HPR fan	HPR fan	HPR fan	HPR fan	HPR fan
180 W	200 W	HPR fan	HPR fan	HPR fan	HPR fan	HPR fan	HPR fan	HPR fan	HPR fan	HPR fan
200 W	200 W	HPR fan	HPR fan	HPR fan	HPR fan	HPR fan	HPR fan	HPR fan	HPR fan	HPR fan
225 W	240 W	HPR fan	HPR fan	HPR fan	HPR fan	HPR fan	HPR fan	HPR fan	HPR fan	HPR fan
280 W	280 W	HPR fan	HPR fan	HPR fan	HPR fan	HPR fan	HPR fan	HPR fan	HPR fan	HPR fan
T4 GPU		HPR fan	HPR fan	HPR fan	HPR fan	HPR fan	HPR fan	HPR fan	HPR fan	HPR fan

NOTE: Three dual fan modules are required for single processor, and four dual fan modules are required for dual processor system.

NOTE: For T4 GPU and 280 W CPU, maximum supported ambient temperature is 30°C. For other configurations maximum supported ambient temperature is 35°C.

Table 36. Processor and heat sink matrix

Heat sink	Processor TDP
STD HSK	< 180 W
L-type HSK	Processor 1 >= 180 W
L-type HSK	Processor 2 >= 180 W

Table 37. Processor support matrix

Processor	TDP (W)	cTDP Max (W)	Cores	Heat sink (HSK) type	Fan type (x4/x8)	Fan type (x10)	Support A3	Support A4
7773X	280	280	64	L-type HSK	NA	HPR (gold) fan	No	No
7573X	280	280	32	L-type HSK	NA	HPR (gold) fan	No	No
7H12	280	280	64	L-type HSK	HPR (silver) fan	HPR (gold) fan	No	No
7F72	240	240	24	L-type HSK	HPR(silver) fan	HPR (gold) fan	No	No
7F52	225	240	16	L-type HSK	HPR (silver) fan	HPR (gold) fan	No	No
7662	225	240	64	L-type HSK	HPR (silver) fan	HPR (gold) fan	No	No
7643	240	240	56	L-type HSK	HPR (silver) fan	HPR (gold) fan	No	No

Table 37. Processor support matrix (continued)

Processor	TDP (W)	cTDP Max (W)	Cores	Heat sink (HSK) type	Fan type (x4/x8)	Fan type (x10)	Support A3	Support A4
7742	225	240	64	L-type HSK	HPR (silver) fan	HPR (gold) fan	No	No
7713P	225	240	64	L-type HSK	HPR (silver) fan	HPR (gold) fan	No	No
7642	225	240	48	L-type HSK	HPR (silver) fan	HPR (gold) fan	No	No
7552	200	200	48	L-type HSK	HPR (silver) fan	HPR (gold) fan	No	No
7702	200	200	64	L-type HSK	HPR (silver) fan	HPR (gold) fan	No	No
7663	240	240	56	L-type HSK	HPR (silver) fan	HPR (gold) fan	No	No
7543P	225	240	32	L-type HSK	HPR (silver) fan	HPR (gold) fan	No	No
7542	225	240	32	L-type HSK	HPR (silver) fan	HPR (gold) fan	No	No
7532	200	200	32	L-type HSK	HPR (silver) fan	HPR (gold) fan	No	No
7F32	180	180	8	L-type HSK	HPR (silver) fan	HPR (gold) fan	No	No
7513	200	200	32	L-type HSK	HPR (silver) fan	HPR (gold) fan	No	No
7502	180	200	32	L-type HSK	HPR (silver) fan	HPR (gold) fan	No	No
74F3	240	240	24/48	L-type HSK	HPR (silver) fan	HPR (gold) fan	No	No
7402	180	200	24	L-type HSK	HPR (silver) fan	HPR (gold) fan	No	No
7452	155	180	32	STD HSK	STD fan	HPR (gold) fan	Yes	No
7443P	200	200	24	L-type HSK	HPR (silver) fan	HPR (gold) fan	No	No
7443	200	200	24	L-type HSK	HPR (silver) fan	HPR (gold) fan	No	No
7352	155	180	24	STD HSK	STD fan	HPR (gold) fan	Yes	No
7343	200	200	32	L-type HSK	HPR (silver) fan	HPR (gold) fan	No	No
7313P	155	180	16	STD HSK	STD fan	HPR (gold) fan	Yes	No
7302	155	180	16	STD HSK	STD fan	HPR (gold) fan	Yes	No
72F3	180	200	8	L-type HSK	HPR (silver) fan	HPR (gold) fan	No	No
7282	120	150	16	STD HSK	STD fan	HPR (gold) fan	Yes	Yes

Table 37. Processor support matrix (continued)

Processor	TDP (W)	cTDP Max (W)	Cores	Heat sink (HSK) type	Fan type (x4/x8)	Fan type (x10)	Support A3	Support A4
7272	120	150	12	STD HSK	STD fan	HPR (gold) fan	Yes	Yes
7252	120	150	8	STD HSK	STD fan	HPR (gold) fan	Yes	Yes
7262	155	180	8	STD HSK	STD fan	HPR (gold) fan	Yes	No

NOTE: DIMM blanks are required on empty slots if 280 W CPU is installed.

NOTE: Processors 7573X and 7773X support only x10 SAS/SATA drives.

Table 38. T4 GPU support restriction

Rear Config	2.5-inch x 10		2.5-inch x 8		3.5-inch x 4	
	3 x LP	2 x FH	3 x LP	2 x FH	3 x LP	2 x FH
Slot 1	Supported	Supported	Supported	Supported	Supported	Supported
Slot 2	Supported	Supported	Supported	Supported	Supported	Supported
Slot 3	Supported	NA	Not supported	NA	Not supported	NA

NOTE: 128 GB LRDIMM 3200 MT/s or higher memory is not supported with 280 W T4/A2 configuration.

Table 39. Label reference

Label	Description
STD	Standard
HPR	High performance (silver grade)
VHP	Very high performance (gold grade)
HSK	Heat sink
LP	Low profile
FH	Full height

Appendix B. Standards compliance

The system conforms to the following industry standards.

Table 40. Industry standard documents

Standard	URL for information and specifications
ACPI Advance Configuration and Power Interface Specification, v2.0c	https://uefi.org/specsandtesttools
Ethernet IEEE 802.3-2005	https://standards.ieee.org/
HDG Hardware Design Guide Version 3.0 for Microsoft Windows Server	microsoft.com/whdc/system/platform/pcdesign/desguide/serverdg.msp
IPMI Intelligent Platform Management Interface, v2.0	intel.com/design/servers/ipmi
DDR4 Memory DDR4 SDRAM Specification	jedec.org/standards-documents/docs/jesd79-4.pdf
PCI Express PCI Express Base Specification Rev. 2.0 and 3.0	pcisig.com/specifications/pciexpress
PMBus Power System Management Protocol Specification, v1.2	http://pmbus.org/Assets/PDFS/Public/PMBus_Specification_Part_1_Rev_1-1_20070205.pdf
SAS Serial Attached SCSI, v1.1	http://www.t10.org/
SATA Serial ATA Rev. 2.6; SATA II, SATA 1.0a Extensions, Rev. 1.2	sata-io.org
SMBIOS System Management BIOS Reference Specification, v2.7	dmtf.org/standards/smbios
TPM Trusted Platform Module Specification, v1.2 and v2.0	trustedcomputinggroup.org
UEFI Unified Extensible Firmware Interface Specification, v2.1	uefi.org/specifications
USB Universal Serial Bus Specification, Rev. 2.7	usb.org/developers/docs

Appendix C Additional resources

Table 41. Additional resources

Resource	Description of contents	Location
Installation and Service Manual	<p>This manual, available in PDF format, provides the following information:</p> <ul style="list-style-type: none"> • Chassis features • System Setup program • System indicator codes • System BIOS • Remove and replace procedures • Diagnostics • Jumpers and connectors 	Dell.com/Support/Manuals
Getting Started Guide	<p>This guide ships with the system, and is also available in PDF format. This guide provides the following information:</p> <ul style="list-style-type: none"> • Initial setup steps 	Dell.com/Support/Manuals
Rack Installation Guide	<p>This document ships with the rack kits, and provides instructions for installing a server in a rack.</p>	Dell.com/Support/Manuals
System Information Label	<p>The system information label documents the system board layout and system jumper settings. Text is minimized due to space limitations and translation considerations. The label size is standardized across platforms.</p>	Inside the system chassis cover
Quick Resource Locator (QRL)	<p>This code on the chassis can be scanned by a phone application to access additional information and resources for the server, including videos, reference materials, service tag information, and Dell EMC contact information.</p>	Inside the system chassis cover
Enterprise Infrastructure Planning Tool (EIPT)	<p>The Dell EMC online EIPT enables easier and more meaningful estimates to help you determine the most efficient configuration possible. Use EIPT to calculate the power consumption of your hardware, power infrastructure, and storage.</p>	Dell.com/calc