

# Dell EMC PowerEdge R650xs

## Installation and Service Manual

## Notes, cautions, and warnings

 **NOTE:** A NOTE indicates important information that helps you make better use of your product.

 **CAUTION:** A CAUTION indicates either potential damage to hardware or loss of data and tells you how to avoid the problem.

 **WARNING:** A WARNING indicates a potential for property damage, personal injury, or death.

<b>Chapter 1: About this document</b> .....	<b>7</b>
<b>Chapter 2: Dell EMC PowerEdge R650xs system overview</b> .....	<b>8</b>
Front view of the system.....	8
Left control panel view.....	11
Right control panel view.....	12
Rear view of the system.....	13
Inside the system .....	14
Locating the Express Service Code and Service Tag.....	15
System information label.....	15
Rail sizing and rack compatibility matrix.....	17
<b>Chapter 3: Initial system setup and configuration</b> .....	<b>19</b>
Setting up the system.....	19
iDRAC configuration.....	19
Options to set up iDRAC IP address.....	19
Options to log in to iDRAC.....	20
Resources to install operating system.....	21
Options to download firmware .....	21
Options to download and install OS drivers .....	22
Downloading drivers and firmware.....	22
<b>Chapter 4: Minimum to POST and system management configuration validation</b> .....	<b>23</b>
Minimum configuration to POST .....	23
Configuration validation.....	23
Error messages.....	24
<b>Chapter 5: Installing and removing system components</b> .....	<b>25</b>
Safety instructions.....	25
Before working inside your system.....	26
After working inside your system.....	26
Recommended tools.....	26
Optional front bezel.....	27
Removing the front bezel.....	27
Installing the front bezel.....	28
System cover.....	29
Removing the system cover.....	29
Installing the system cover.....	30
Drive backplane cover.....	31
Removing the drive backplane cover.....	31
Installing the drive backplane cover.....	32
Air shroud.....	34
Removing the air shroud.....	34
Installing the air shroud.....	34

Cooling fans.....	35
Removing a cooling fan.....	35
Installing a cooling fan.....	36
Intrusion switch module.....	37
Removing the intrusion switch module.....	37
Installing the intrusion switch.....	38
Drives.....	39
Removing a drive blank.....	39
Installing a drive blank.....	40
Removing the drive carrier.....	40
Installing the drive carrier.....	41
Removing the drive from the drive carrier.....	42
Installing the drive into the drive carrier.....	43
Optional optical drive.....	44
Removing the optical drive.....	44
Installing the optical drive.....	45
Drive backplane.....	46
Drive backplane.....	46
Removing the backplane.....	47
Installing the drive backplane.....	48
Cable routing.....	50
System memory.....	58
System memory guidelines.....	58
General memory module installation guidelines.....	59
Removing a memory module.....	60
Installing a memory module.....	61
Processor and heat sink module.....	62
Removing a processor and heat sink module.....	62
Removing the processor from the processor and heat sink module.....	63
Installing the processor into a processor and heat sink module.....	65
Installing the processor and heat sink module.....	68
Expansion cards and expansion card risers.....	70
Expansion card installation guidelines.....	71
Removing the expansion card risers.....	80
Installing the expansion card risers.....	82
Removing expansion card from the expansion card riser.....	85
Installing an expansion card into the expansion card riser.....	89
Drive cage.....	93
Removing the 2.5-inch rear drive cage.....	93
Installing the 2.5-inch rear drive cage.....	94
Optional serial COM port.....	95
Removing the serial COM port.....	95
Installing the serial COM port.....	96
MicroSD card.....	98
Removing the MicroSD card.....	98
Installing the MicroSD card.....	98
Optional BOSS S1 card.....	99
Removing the M.2 BOSS riser.....	99
Installing the M.2 BOSS riser.....	100
Removing the M.2 BOSS card from the M.2 BOSS riser.....	101

Installing the M2 BOSS card into the M.2 BOSS riser.....	102
Removing the M.2 SSD module.....	103
Installing the M.2 SSD module.....	103
Optional IDSDM module.....	104
Removing the IDSDM module.....	104
Installing the IDSDM module.....	105
Optional OCP card.....	106
Removing the OCP card.....	106
Installing the OCP card.....	107
Front mounting front PERC module.....	108
Removing the front mounting front PERC module.....	108
Installing the front mounting front PERC module.....	109
System battery .....	110
Replacing the system battery.....	110
Optional internal USB card.....	112
Removing the optional internal USB card.....	112
Installing the internal USB card.....	113
VGA module.....	113
Removing the VGA module.....	113
Installing the VGA module.....	114
Power supply unit.....	115
Hot spare feature.....	115
Removing a power supply unit blank.....	116
Installing a power supply unit blank.....	116
Removing a power supply unit.....	117
Installing a power supply unit.....	118
Power interposer board.....	119
Removing the power interposer board.....	119
Installing the power interposer board.....	119
System board.....	120
Removing the system board.....	120
Installing the system board.....	121
Trusted Platform Module.....	123
Upgrading the Trusted Platform Module.....	123
Initializing TPM for users.....	124
Initializing the TPM 1.2 for users.....	124
Initializing the TPM 2.0 for users.....	125
Control panel.....	125
Removing the left control panel.....	125
Installing the left control panel.....	126
Removing the right control panel.....	127
Installing the right control panel.....	128
<b>Chapter 6: Jumpers and connectors.....</b>	<b>130</b>
System board connectors.....	130
System board jumper settings.....	131
Disabling a forgotten password.....	131
<b>Chapter 7: System diagnostics and indicator codes.....</b>	<b>133</b>

Status LED indicators.....	133
System health and system ID indicator codes.....	135
iDRAC Quick Sync 2 indicator codes.....	135
iDRAC Direct LED indicator codes.....	136
LCD panel.....	136
Viewing Home screen.....	137
Setup menu.....	137
View menu.....	138
NIC indicator codes.....	138
Power supply unit indicator codes.....	139
Drive indicator codes.....	141
Using system diagnostics.....	141
Dell Embedded System Diagnostics.....	141
<b>Chapter 8: Getting help.....</b>	<b>143</b>
Recycling or End-of-Life service information.....	143
Contacting Dell Technologies.....	143
Accessing system information by using QRL.....	143
Quick Resource Locator for PowerEdge R650xs system.....	144
Receiving automated support with SupportAssist .....	144
<b>Chapter 9: Documentation resources.....</b>	<b>145</b>

# About this document

This document provides an overview about the system, information about installing and replacing components, diagnostic tools, and guidelines to be followed while installing certain components.

# Dell EMC PowerEdge R650xs system overview

The PowerEdge R650xs system is a 1U server that supports:

- Up to two 3<sup>rd</sup> Generation Intel Xeon Scalable processors with up to 32 cores
- 16 DIMM slots
- Two redundant AC or DC power supply units
- Up to 10 x 2.5-inch SAS/SATA/NVMe (HDD/SSD) drives
- Up to 4 x 3.5-inch SAS/SATA (HDD/SSD) drives
- Up to 8 x 2.5-inch SAS/SATA/NVMe (HDD/SSD) drives

**NOTE:** For more information about how to hot swap NVMe PCIe SSD U.2 device, see the *Dell Express Flash NVMe PCIe SSD User's Guide* at <https://www.dell.com/support> > **Browse all Products** > **Data Center Infrastructure** > **Storage Adapters & Controllers** > **Dell PowerEdge Express Flash NVMe PCIe SSD** > **Documentation** > **Manuals and Documents**.

**NOTE:** All instances of SAS, SATA drives are referred to as drives in this document, unless specified otherwise.

**CAUTION:** Do not install GPUs, network cards, or other PCIe devices on your system that are not validated and tested by Dell. Damage caused by unauthorized and invalidated hardware installation will null and void the system warranty.

**NOTE:** For more information, see the *Dell EMC PowerEdge R650xs Technical Specifications* on the product documentation page.

## Topics:

- [Front view of the system](#)
- [Rear view of the system](#)
- [Inside the system](#)
- [Locating the Express Service Code and Service Tag](#)
- [System information label](#)
- [Rail sizing and rack compatibility matrix](#)

## Front view of the system



Figure 1. Front view of 4 x 3.5-inch drive system



**Table 1. Features available on the front of the system**

Item	Ports, panels, and slots	Icon	Description
1	Left control panel	N/A	<p>Contains the system health, system ID, status LED, and the iDRAC Quick Sync 2 (wireless) indicator.</p> <p><b>NOTE:</b> The iDRAC Quick Sync 2 indicator is available only on certain configurations.</p> <ul style="list-style-type: none"> <li>Status LED: Enables you to identify any failed hardware components. There are up to five status LEDs and an overall system health LED (Chassis health and system ID) bar. For more information, see the Status LED indicators section.</li> <li>Quick Sync 2 (wireless): Indicates a Quick Sync enabled system. The Quick Sync feature is optional. This feature allows management of the system by using mobile devices called as OpenManage Mobile (OMM) feature. Using iDRAC Quick Sync 2 with OpenManage Mobile (OMM) aggregates hardware or firmware inventory and various system level diagnostic and error information that can be used in troubleshooting the system. For more information, see the <i>iDRAC User's Guide</i> available at <a href="https://www.dell.com/idracmanuals">https://www.dell.com/idracmanuals</a></li> </ul>
2	Optical drive (optional)	N/A	One optional slim SATA DVD-ROM drive or DVD+/-RW drive.
3	VGA port		Enables you to connect a display device to the system.
4	Right control panel	N/A	Contains the power button, USB port, iDRAC Direct micro port, and the iDRAC Direct status LED.
5	Information tag		The Information tag is a slide-out label panel that contains system information such as Service Tag, NIC, MAC address, and so on. If you have opted for the secure default access to iDRAC, the Information tag also contains the iDRAC secure default password.
6	Drive	N/A	Enables you to install drives that are supported on your system.



**Figure 2. Front view of 8 x 2.5-inch drive system**

**Table 2. Features available on the front of the system**

Item	Ports, panels, and slots	Icon	Description
1	Left control panel	N/A	<p>Contains the system health, system ID, status LED, and the iDRAC Quick Sync 2 (wireless) indicator.</p> <p><b>NOTE:</b> The iDRAC Quick Sync 2 indicator is available only on certain configurations.</p> <ul style="list-style-type: none"> <li>Status LED: Enables you to identify any failed hardware components. There are up to five status LEDs and an overall system health LED (Chassis health and system ID) bar. For more information, see the Status LED indicators section.</li> </ul>

**Table 2. Features available on the front of the system (continued)**

Item	Ports, panels, and slots	Icon	Description
			<ul style="list-style-type: none"> <li>Quick Sync 2 (wireless): Indicates a Quick Sync enabled system. The Quick Sync feature is optional. This feature allows management of the system by using mobile devices called as OpenManage Mobile (OMM) feature. Using iDRAC Quick Sync 2 with OpenManage Mobile (OMM) aggregates hardware or firmware inventory and various system level diagnostic and error information that can be used in troubleshooting the system. For more information, see the <i>iDRAC User's Guide</i> available at <a href="https://www.dell.com/idracmanuals">https://www.dell.com/idracmanuals</a></li> </ul>
2	Drive	N/A	Enables you to install drives that are supported on your system.
3	VGA port		Enables you to connect a display device to the system.
4	Right control panel	N/A	Contains the power button, USB port, iDRAC Direct micro port, and the iDRAC Direct status LED.
5	Information tag		The Information tag is a slide-out label panel that contains system information such as Service Tag, NIC, MAC address, and so on. If you have opted for the secure default access to iDRAC, the Information tag also contains the iDRAC secure default password.
6	Drive blank	N/A	Enables you to install drive blank.



**Figure 3. Front view of 10 x 2.5-inch drive system**

**Table 3. Features available on the front of the system**

Item	Ports, panels, and slots	Icon	Description
1	Left control panel	N/A	<p>Contains the system health, system ID, status LED, and the iDRAC Quick Sync 2 (wireless) indicator.</p> <p><b>NOTE:</b> The iDRAC Quick Sync 2 indicator is available only on certain configurations.</p> <ul style="list-style-type: none"> <li>Status LED: Enables you to identify any failed hardware components. There are up to five status LEDs and an overall system health LED (Chassis health and system ID) bar. For more information, see the Status LED indicators section.</li> <li>Quick Sync 2 (wireless): Indicates a Quick Sync enabled system. The Quick Sync feature is optional. This feature allows management of the system by using mobile devices called as OpenManage Mobile (OMM) feature. Using iDRAC Quick Sync 2 with OpenManage Mobile (OMM) aggregates hardware or firmware inventory and various system level diagnostic and error information that can be used in troubleshooting the system. For more information, see the <i>iDRAC User's Guide</i> available at <a href="https://www.dell.com/idracmanuals">https://www.dell.com/idracmanuals</a></li> </ul>

**Table 3. Features available on the front of the system (continued)**

Item	Ports, panels, and slots	Icon	Description
2	VGA port		Enables you to connect a display device to the system. For more information, see the VGA port specifications section.
3	Right control panel	N/A	Contains the power button, USB port, iDRAC Direct micro port, and the iDRAC Direct status LED.
4	Information tag		The Information tag is a slide-out label panel that contains system information such as Service Tag, NIC, MAC address, and so on. If you have opted for the secure default access to iDRAC, the Information tag also contains the iDRAC secure default password.
5	Drive	N/A	Enables you to install drives that are supported on your system. For more information about drives, see the Drives section.

For more information about the ports, see the Dell EMC PowerEdge R650xs Technical Specifications on the product documentation page.

## Left control panel view

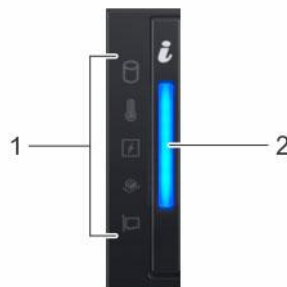

**Figure 4. Left control panel**

**Table 4. Left control panel**

Item	Indicator, button, or connector	Icon	Description
1	Status LED indicators	NA	Indicates the status of the system. For more information, see the <a href="#">Status LED indicators</a> section.
2	System health and system ID indicator		Indicates the status of the system. For more information, see the <a href="#">System health and system ID indicator codes</a> section.



**NOTE:** For more information about the indicator codes, see the [System diagnostics and indicator codes](#) section.

## Right control panel view



Figure 5. Right control panel

Table 5. Right control panel

Item	Indicator or button	Icon	Description
1	Power button		Indicates if the system is powered on or off. Press the power button to manually power on or off the system.  <b>NOTE:</b> Press the power button to gracefully shut down an ACPI-compliant operating system.
2	USB 2.0-compliant port		The USB port is a 4-pin connector and 2.0-compliant. This port enables you to connect USB devices to the system.
3	iDRAC Direct LED indicator	N/A	The iDRAC Direct LED indicator lights up to indicate that the iDRAC Direct port is actively connected to a device.
4	iDRAC Direct port (Micro-AB USB)		The iDRAC Direct port (Micro-AB USB) enables you to access the iDRAC direct Micro-AB USB features. For more information, see the <a href="https://www.dell.com/idracmanuals">https://www.dell.com/idracmanuals</a> .  <b>NOTE:</b> You can configure iDRAC Direct by using a USB to micro USB (type AB) cable, which you can connect to your laptop or tablet. Cable length should not exceed 3 feet (0.91 meters). Performance could be affected by cable quality.

For more information about the ports, see the Dell EMC PowerEdge R650xs Technical Specifications on the product documentation page.

# Rear view of the system

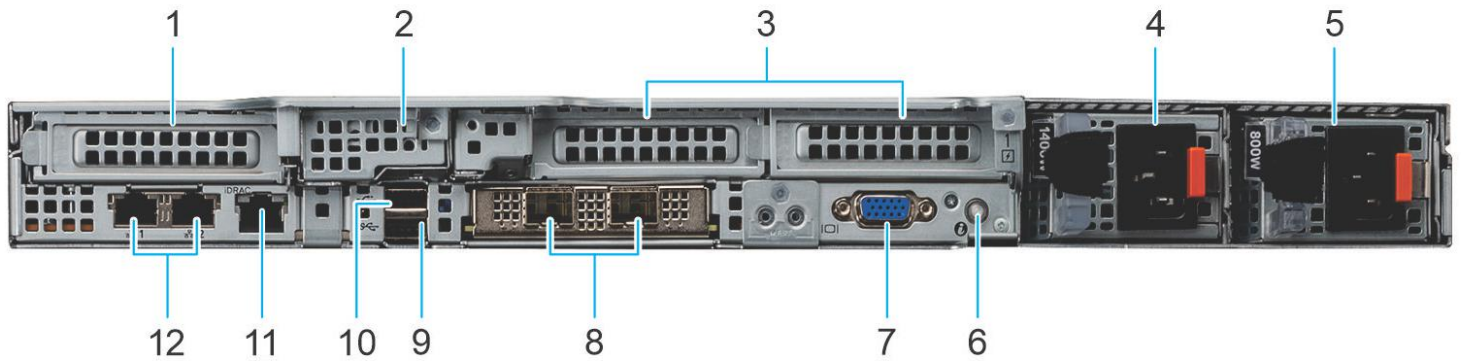



Figure 6. Rear view of the system

Table 6. Rear view of the system

Item	Ports, panels, or slots	Icon	Description
1	PCIe expansion card riser 1	N/A	Enables you to connect PCI Express expansion cards.
2	BOSS riser	N/A	Enables you to connect BOSS card.
3	PCIe expansion card riser 2c	N/A	Enables you to connect PCI Express expansion cards.
4	Power supply unit (PSU 1)		Indicates the PSU.
5	Power supply unit (PSU 2)		Indicates the PSU.
6	System identification button		<p>Press the system ID button:</p> <ul style="list-style-type: none"> <li>To locate a particular system within a rack.</li> <li>To turn the system ID on or off.</li> </ul> <p>To reset iDRAC, press and hold the button for 16 seconds.</p> <p><b>NOTE:</b></p> <ul style="list-style-type: none"> <li>To reset iDRAC using system ID, ensure that the system ID button is enabled in the iDRAC setup.</li> <li>If the system stops responding during POST, press and hold the system ID button (for more than five seconds) to enter the BIOS progress mode.</li> </ul>
7	VGA port		Enables you to connect a display device to the system.
8	OCP NIC port	N/A	This port supports OCP 3.0.
9	USB 3.0 port		This port is USB 3.0-compliant.
10	USB 2.0 port		This port is USB 2.0-compliant.

**Table 6. Rear view of the system (continued)**

Item	Ports, panels, or slots	Icon	Description
11	iDRAC dedicated port		Enables you to remotely access iDRAC. For more information, see the iDRAC User's Guide at <a href="http://www.dell.com/poweredgemanuals">www.dell.com/poweredgemanuals</a> .
12	NIC ports		The NIC ports that are integrated on the system board provide network connectivity. These NIC ports can also be shared with iDRAC when iDRAC network settings is set to shared mode.

For more information about the ports, see the Dell EMC PowerEdge R650xs Technical Specifications on the product documentation page.

## Inside the system

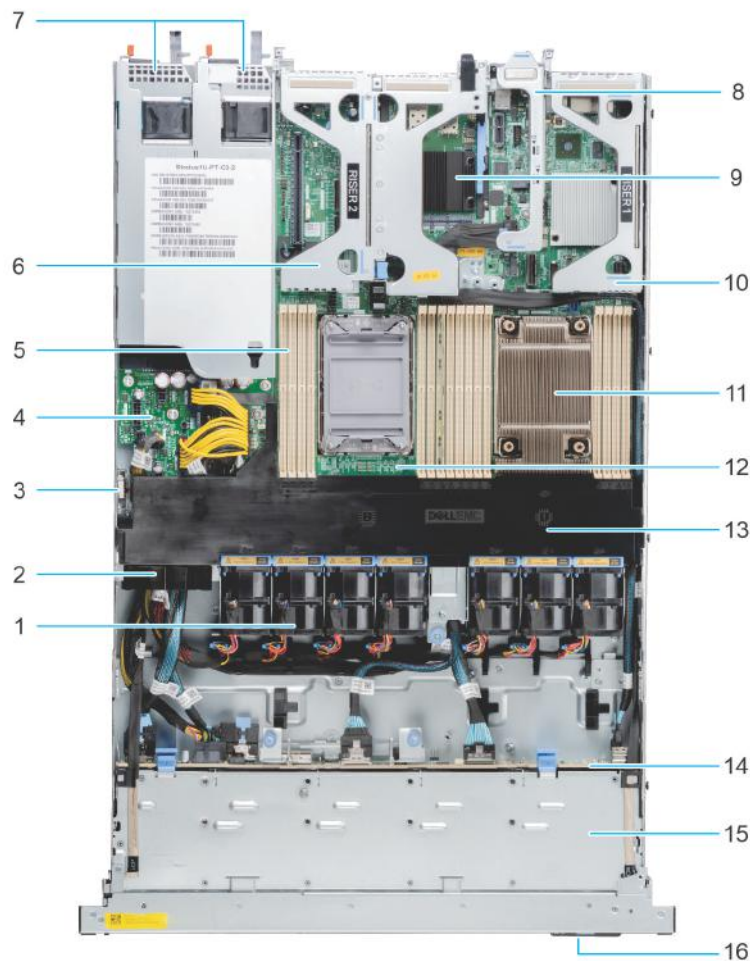

**Figure 7. Inside the system**

- |                        |                           |
|------------------------|---------------------------|
| 1. Fan                 | 2. Cable retention latch  |
| 3. Intrusion switch    | 4. Power interposer board |
| 5. Memory module slots | 6. Riser 2a/2b/2c         |
| 7. PSU 1 and PSU 2     | 8. BOSS riser             |
| 9. OCP                 | 10. Riser 1               |
| 11. Heat sink          | 12. System board          |
| 13. Air shroud         | 14. Drive backplane       |
| 15. Backplane cover    | 16. Information tag       |

# Locating the Express Service Code and Service Tag

The unique Express Service Code and Service Tag are used to identify the system.

The information tag is located on the front includes system information such as the Service Tag, Express Service Code, Manufacture date, NIC, MAC address, QRL label, and so on.

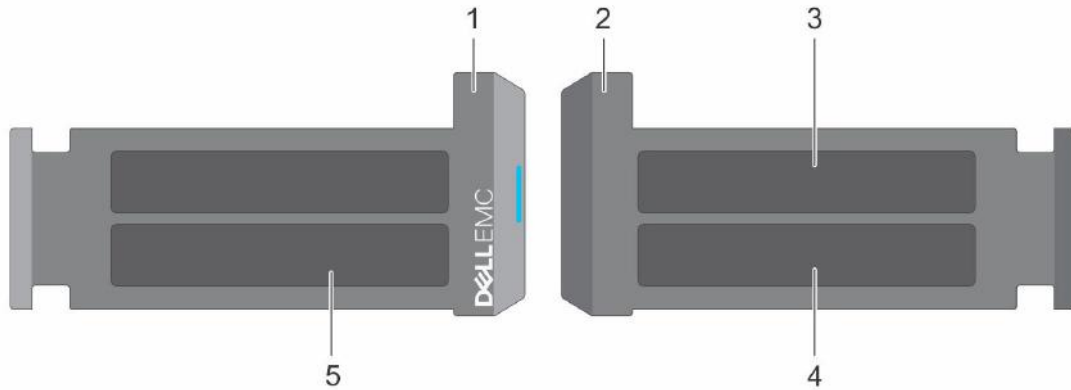

**Figure 8. Locating the Express Service Code and Service tag**

1. Information tag (front view)
2. Information tag (back view)
3. OpenManage Mobile (OMM) label
4. iDRAC MAC address and iDRAC secure password label
5. Service Tag, Express Service Code, QRL label

The Mini Enterprise Service Tag (MEST) label is located on the rear of the system that includes the Service Tag (ST), Express Service Code (Exp Svc Code), and Manufacture Date (Mfg. Date). The Exp Svc Code is used by Dell EMC to route support calls to the appropriate personnel.

Alternatively, the Service Tag information is located on a label on the left wall of the chassis.

## System information label

The system information label is located on back of the system cover.

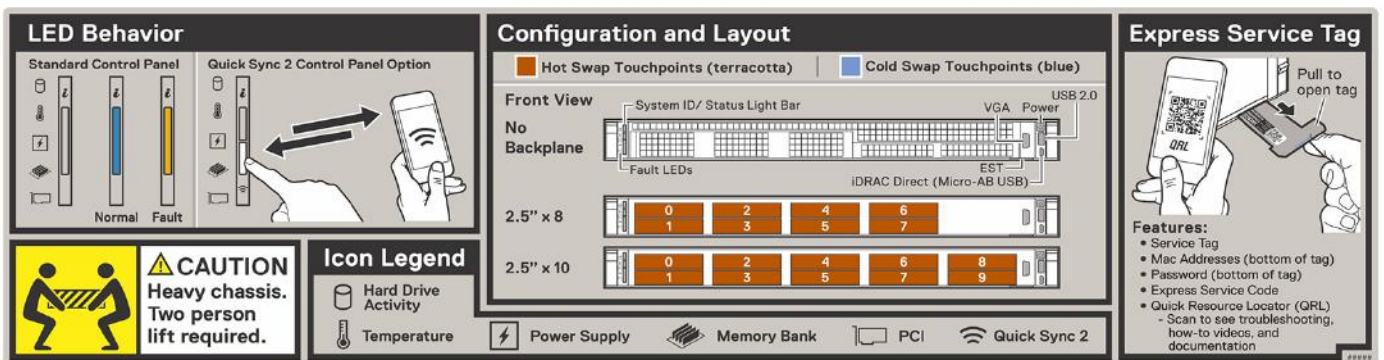

**Figure 9. LED behaviour, Configuration and layout, Express Service Tag**

## Service Information

### System Touchpoints

- Hot swap touchpoints:  
Components with terracotta touchpoints can be serviced while the system is running.
- Cold swap touchpoints:  
Components with blue touchpoints require a full system shutdown before servicing.

Scan to see hardware servicing and software setup videos, how-to's, and documentation.



**Quick Resource Locator**  
Dell.com/QRL/Server/PER650xs

### Mechanical Overview

#### Top View

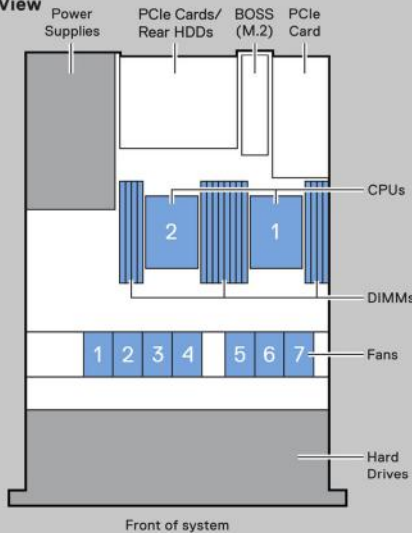

#### Rear View

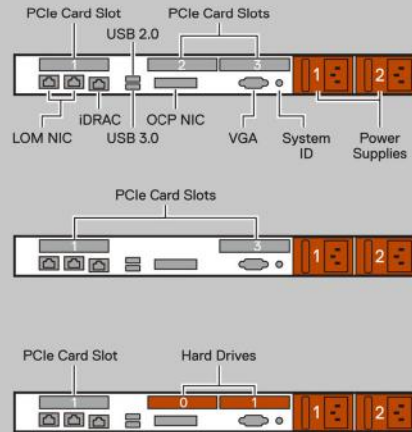

### Electrical Overview

#### System Board Connections

- |  |  |
|--|--|
| <b>1</b> System ID Connector               | <b>20</b> CPU1                             |
| <b>2</b> OCP NIC 3.0 Connector             | <b>21</b> DIMMs for CPU 1 Channels A,B,C,D |
| <b>3</b> iDSM/Internal USB Connector       | <b>22</b> Right Control Panel              |
| <b>4</b> Serial Port Connector             | <b>23</b> PCIe Connector 4 (SL4_CPU1_PA2)  |
| <b>5</b> BOSS Riser Slot (PCH)             | <b>24</b> PCIe Connector 3 (SL3_CPU1_PB2)  |
| <b>6</b> Front VGA                         | <b>25</b> System Power Connector 2         |
| <b>7</b> PCH                               | <b>26</b> PCIe Connector 2 (SL2_CPU2_PA1)  |
| <b>8</b> Jumper                            | <b>27</b> PCIe Connector 1 (SL1_CPU2_PB1)  |
| <b>9</b> Riser 1 Connector (CPU 1)         | <b>28</b> Left Control Panel               |
| <b>10</b> SATA Connector 9 (SL9_PCH_SA1)   | <b>29</b> Fan Signal 1                     |
| <b>11</b> PCIe Connector 7 (SL7_CPU1_PA4)  | <b>30</b> Fan Signal 2                     |
| <b>12</b> TPM Connector                    | <b>31</b> PIB Signal 1                     |
| <b>13</b> PCIe Connector 8 (SL8_CPU1_PB4)  | <b>32</b> PIB Signal 2                     |
| <b>14</b> Coin Cell Battery                | <b>33</b> Intrusion Switch Connector       |
| <b>15</b> ODD                              | <b>34</b> System Power Connector 1         |
| <b>16</b> DIMMs for CPU 2 Channels E,F,G,H | <b>35</b> Backplane Signal and Power 0     |
| <b>17</b> CPU2                             | <b>36</b> Riser 2 Connector (CPU 2)        |
| <b>18</b> DIMMs for CPU 2 Channels A,B,C,D |  |
| <b>19</b> DIMMs for CPU 1 Channels E,F,G,H |  |

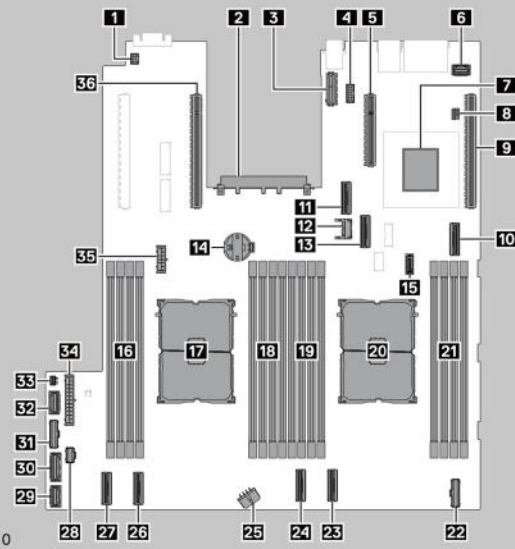

\* Refer to the Installation and Service Manual for supported connectors.

#### Jumper Settings

Jumper	Setting	Description
PWRD_EN	(default)	BIOS password is enabled.
	(default)	BIOS password is disabled, iDRAC local access unlocked at next AC power cycle. iDRAC password reset is enabled in F2 iDRAC settings menu.
NVRAM_CLR	(default)	BIOS configuration settings retained at system boot.
	(default)	BIOS configuration settings cleared at system boot.

Figure 10. Service information



### Icon Legend

EST Express Service Tag	Hard Drive Activity	Power Supply	Fan	CPU
Memory Bank	Push	System ID	iDRAC Direct (Micro-AB USB)	

### Memory Information

**Caution:** Memory (DIMMs) and CPUs may be hot during servicing.

#### Memory Population

Configuration	Sequence
Memory-Optimized	1, 2, 3, 4, 5, 6, 7, 8

Latest population rules are documented in the Installation and Service Manual.

---

#### Cabled Fan

#### System Tasks

##### Boot Optimized M.2 Drives

**Caution:** Many repairs may only be done by a certified service technician. You should only perform troubleshooting and simple repairs as authorized in your product documentation, or as directed by the online or telephone service and support team. Damage due to servicing that is not authorized by Dell is not covered by your warranty. Read and follow the safety instructions that came with the product.

To learn more about this Dell product or to order additional or replacement parts, go to [Dell.com/support](https://Dell.com/support)

Copyright © 2020 Dell Inc. or its subsidiaries. All Rights Reserved. Rev A00. Label Part No. MYX83 ####

Figure 11. Icon Legend, Memory information, System task

## Rail sizing and rack compatibility matrix

For specific information about the rail solutions compatible with your system, see the *Dell EMC Enterprise Systems Rail Sizing and Rack Compatibility Matrix* available at [https://i.dell.com/sites/csdocuments/Business\\_solutions\\_engineering-Docs\\_Documents/en/rail-rack-matrix.pdf](https://i.dell.com/sites/csdocuments/Business_solutions_engineering-Docs_Documents/en/rail-rack-matrix.pdf).

The document provides the information that is listed below:

- Specific details about rail types and their functionalities.
- Rail adjustability range for various types of rack mounting flanges.
- Rail depth with and without cable management accessories.
- Types of racks supported for various types of rack mounting flanges.

# Initial system setup and configuration

This section describes the tasks for initial setup and configuration of the Dell EMC system. The section also provides general steps to set up the system and the reference guides for detailed information.

## Topics:

- [Setting up the system](#)
- [iDRAC configuration](#)
- [Resources to install operating system](#)

## Setting up the system

Perform the following steps to set up the system:

### Steps

1. Unpack the system.
2. Install the system into the rack. For more information, see the rail installation and cable management accessory guides relevant to your rail and cable management solution at [www.dell.com/poweredgemanuals](http://www.dell.com/poweredgemanuals).
3. Connect the peripherals to the system and the system to the electrical outlet.
4. Power on the system.

For more information about setting up the system, see the *Getting Started Guide* that is shipped with your system.

**NOTE:** For information about managing the basic settings and features of the system, see the *Dell EMC PowerEdge R650xs BIOS and UEFI Reference Guide* on the product documentation page.

## iDRAC configuration

The Integrated Dell Remote Access Controller (iDRAC) is designed to make you more productive as a system administrator and improve the overall availability of Dell EMC servers. iDRAC alerts you to system issues, helps you to perform remote management, and reduces the need for physical access to the system.

### Options to set up iDRAC IP address

To enable communication between your system and iDRAC, you must first configure the network settings based on your network infrastructure. The network settings option is set to **DHCP**, by default.





**NOTE:** For static IP configuration, you must request for the settings at the time of purchase.

You can set up the iDRAC IP address using one of the interfaces in the table below. For information about setting up iDRAC IP address, see the documentation links provided in the table below.

**Table 7. Interfaces to set up iDRAC IP address**

Interface	Documentation links
iDRAC Settings utility	<i>Integrated Dell Remote Access Controller User's Guide</i> at <a href="https://www.dell.com/idracmanuals">https://www.dell.com/idracmanuals</a> or for system specific <i>Integrated Dell Remote Access Controller User's Guide</i> , go to <a href="https://www.dell.com/poweredgemanuals">https://www.dell.com/poweredgemanuals</a> > <b>Product Support</b> page of your system > <b>Documentation</b> .

**Table 7. Interfaces to set up iDRAC IP address (continued)**

Interface	Documentation links
	<p> <b>NOTE:</b> To determine the most recent iDRAC release for your platform and for latest documentation version, see KB article <a href="https://www.dell.com/support/article/sln308699">https://www.dell.com/support/article/sln308699</a>.</p>
OpenManage Deployment Toolkit	<p><i>OpenManage Deployment Toolkit User's Guide</i> available at <a href="https://www.dell.com/openmanagemanuals">https://www.dell.com/openmanagemanuals</a> &gt; Open Manage Deployment Toolkit.</p>
iDRAC Direct	<p><i>Integrated Dell Remote Access Controller User's Guide</i> at <a href="https://www.dell.com/idracmanuals">https://www.dell.com/idracmanuals</a> or for system specific <i>Integrated Dell Remote Access Controller User's Guide</i>, go to <a href="https://www.dell.com/poweredgemanuals">https://www.dell.com/poweredgemanuals</a> &gt; <b>Product Support</b> page of your system &gt; <b>Documentation</b>.</p> <p> <b>NOTE:</b> To determine the most recent iDRAC release for your platform and for latest documentation version, see KB article <a href="https://www.dell.com/support/article/sln308699">https://www.dell.com/support/article/sln308699</a>.</p>
Lifecycle Controller	<p><i>Lifecycle Controller User's Guide</i> at <a href="https://www.dell.com/idracmanuals">https://www.dell.com/idracmanuals</a> or for system specific <i>Lifecycle Controller User's Guide</i>, go to <a href="https://www.dell.com/poweredgemanuals">https://www.dell.com/poweredgemanuals</a> &gt; <b>Product Support</b> page of your system &gt; <b>Documentation</b>.</p> <p> <b>NOTE:</b> To determine the most recent iDRAC release for your platform and for latest documentation version, see KB article <a href="https://www.dell.com/support/article/sln308699">https://www.dell.com/support/article/sln308699</a>.</p>
Server LCD panel	<p>LCD panel section.</p>
iDRAC Direct and Quick Sync 2 (optional)	<p><i>Integrated Dell Remote Access Controller User's Guide</i> at <a href="https://www.dell.com/idracmanuals">https://www.dell.com/idracmanuals</a> or for system specific <i>Integrated Dell Remote Access Controller User's Guide</i>, go to <a href="https://www.dell.com/poweredgemanuals">https://www.dell.com/poweredgemanuals</a> &gt; <b>Product Support</b> page of your system &gt; <b>Documentation</b>.</p> <p> <b>NOTE:</b> To determine the most recent iDRAC release for your platform and for latest documentation version, see KB article <a href="https://www.dell.com/support/article/sln308699">https://www.dell.com/support/article/sln308699</a>.</p>

 **NOTE:** To access iDRAC, ensure that you connect the ethernet cable to the iDRAC dedicated network port or use the iDRAC Direct port by using the USB cable. You can also access iDRAC through the shared LOM mode, if you have opted for a system that has the shared LOM mode enabled.

## Options to log in to iDRAC

To log in to the iDRAC Web User Interface, open a browser and enter the IP address.

You can log in to iDRAC as:

- iDRAC user
- Microsoft Active Directory user
- Lightweight Directory Access Protocol (LDAP) user

In the login screen displayed, if you have opted for secure default access to iDRAC, enter the iDRAC secure default password available on back of the Information Tag. If you have not opted for secure default access to iDRAC, enter the default user name and password – `root` and `calvin`. You can also log in by using your Single Sign-On or Smart Card.

 **NOTE:** Ensure that you change the default username and password after setting up the iDRAC IP address.

For more information about logging in to the iDRAC and iDRAC licenses, see the latest *Integrated Dell Remote Access Controller User's Guide* at [www.dell.com/idracmanuals](http://www.dell.com/idracmanuals).

**NOTE:** To determine the most recent iDRAC release for your platform and for latest documentation version, see KB article <https://www.dell.com/support/article/sln308699>.

You can also access iDRAC using command-line protocol - RACADM. For more information, see the *iDRAC with Lifecycle Controller RACADM CLI Guide* available at [www.dell.com/idracmanuals](http://www.dell.com/idracmanuals).

You can also access iDRAC using automation tool - Redfish API. For more information, see the *iDRAC9 with Lifecycle Controller Redfish API Guide* available at <https://www.dell.com/idracmanuals>.

## Resources to install operating system

If the system is shipped without an operating system, you can install a supported operating system by using one of the resources provided in the table below. For information about how to install the operating system, see the documentation links provided in the table below.

**Table 8. Resources to install the operating system**

Resource	Documentation links
iDRAC	<i>Integrated Dell Remote Access Controller User's Guide</i> at <a href="https://www.dell.com/idracmanuals">https://www.dell.com/idracmanuals</a> or for system specific <i>Integrated Dell Remote Access Controller User's Guide</i> , go to <a href="https://www.dell.com/poweredgemanuals">https://www.dell.com/poweredgemanuals</a> > <b>Product Support</b> page of your system > <b>Documentation</b> . <b>NOTE:</b> To determine the most recent iDRAC release for your platform and for latest documentation version, see KB article at <a href="https://www.dell.com/support/article/sln308699">https://www.dell.com/support/article/sln308699</a> .
Lifecycle Controller	<i>Lifecycle Controller User's Guide</i> at <a href="https://www.dell.com/idracmanuals">https://www.dell.com/idracmanuals</a> or for system specific <i>Lifecycle Controller User's Guide</i> , go to <a href="https://www.dell.com/poweredgemanuals">https://www.dell.com/poweredgemanuals</a> > <b>Product Support</b> page of your system > <b>Documentation</b> . Dell recommends using Lifecycle Controller to install the OS, since all required drivers are installed on the system. <b>NOTE:</b> To determine the most recent iDRAC release for your platform and for latest documentation version, see KB article at <a href="https://www.dell.com/support/article/sln308699">https://www.dell.com/support/article/sln308699</a> .
OpenManage Deployment Toolkit	<a href="http://www.dell.com/openmanagemanuals">www.dell.com/openmanagemanuals</a> > OpenManage Deployment Toolkit
Dell certified VMware ESXi	<a href="http://www.dell.com/virtualizationsolutions">www.dell.com/virtualizationsolutions</a>

**NOTE:** For more information about Installation and How-to videos for supported operating systems on PowerEdge system, see [Supported Operating Systems for Dell EMC PowerEdge systems](#).

## Options to download firmware

You can download firmware from the Dell support site. For information about downloading firmware, see the [Downloading drivers and firmware](#) section.

You can also choose any one of the following options to download the firmware. For information about how to download the firmware, see the documentation links provided in the table below.

**Table 9. Options to download firmware**

Option	Documentation link
Using Integrated Dell Remote Access Controller Lifecycle Controller (iDRAC with LC)	<a href="http://www.dell.com/idracmanuals">www.dell.com/idracmanuals</a>
Using Dell Repository Manager (DRM)	<a href="http://www.dell.com/openmanagemanuals">www.dell.com/openmanagemanuals</a> > Repository Manager
Using Dell Server Update Utility (SUU)	<a href="http://www.dell.com/openmanagemanuals">www.dell.com/openmanagemanuals</a> > Server Update Utility
Using Dell OpenManage Deployment Toolkit (DTK)	<a href="http://www.dell.com/openmanagemanuals">www.dell.com/openmanagemanuals</a> > OpenManage Deployment Toolkit

**Table 9. Options to download firmware (continued)**

Option	Documentation link
Using iDRAC virtual media	<a href="http://www.dell.com/idracmanuals">www.dell.com/idracmanuals</a>

## Options to download and install OS drivers

You can choose any one of the following options to download and install OS drivers. For information about how to download or install OS drivers, see the documentation links provided in the table below.

**Table 10. Options to download and install OS drivers**

Option	Documentation
Dell EMC support site	<a href="#">Downloading drivers and firmware</a> section.
iDRAC virtual media	<i>Integrated Dell Remote Access Controller User's Guide</i> at <a href="https://www.dell.com/idracmanuals">https://www.dell.com/idracmanuals</a> or for system specific <i>Integrated Dell Remote Access Controller User's Guide</i> , go to <a href="https://www.dell.com/poweredgemanuals">https://www.dell.com/poweredgemanuals</a> > <b>Product Support</b> page of your system > <b>Documentation</b> . <b>NOTE:</b> To determine the most recent iDRAC release for your platform and for latest documentation version, see <a href="https://www.dell.com/support/article/sln308699">https://www.dell.com/support/article/sln308699</a> .

## Downloading drivers and firmware

It is recommended that you download and install the latest BIOS, drivers, and systems management firmware on the system.

### Prerequisites

Ensure that you clear the web browser cache before downloading the drivers and firmware.

### Steps

1. Go to [www.dell.com/support/drivers](http://www.dell.com/support/drivers).
2. Enter the Service Tag of the system in the **Enter a Dell Service Tag, Dell EMC Product ID or Model** field, and then press Enter.  
**NOTE:** If you do not have the Service Tag, click **Browse all products**, and navigate to your product.
3. On the displayed product page, click **Drivers & Downloads**.  
On the **Drivers & Downloads** page, all drivers that are applicable to the system are displayed.
4. Download the drivers to a USB drive, CD, or DVD.

# Minimum to POST and system management configuration validation

This section describes the minimum to POST system requirement and system management configuration validation of the Dell EMC system.

## Topics:

- [Minimum configuration to POST](#)
- [Configuration validation](#)

## Minimum configuration to POST

The components listed below are the minimum configuration to POST:

- One power supply unit
- System board
- One processor in socket processor 1
- One memory module (DIMM) installed in the socket A1

## Configuration validation

The new generation of PowerEdge systems have added interconnect flexibility and advanced iDRAC management features to collect precise system configuration information and report configuration errors.

When the system is powered on, information about installed cables, risers, backplanes, floating card (fPERC or BOSS), and processor is obtained from the CPLD and backplane memory maps is analyzed. This information forms a unique configuration, which is compared with one of the qualified configurations stored in a table maintained by iDRAC.

One or more sensors are assigned to each of the configuration elements. During POST, any configuration validation error is logged in the System Event Log (SEL)/LifeCycle (LC) log. The reported events are categorized in the configuration validation error table.

**Table 11. Configuration validation error**

Error	Description	Possible cause and recommendations	Example
Config Error	A configuration element within the closest match contains something that is unexpected and does not match any Dell qualified configuration.	Wrong configuration	Config Error: Backplane cable CTRS_SRC_SA1 and BP-DST_SA1
		The element reported in HWC8010 errors are assembled incorrectly. Verify element (cable, riser, etc) placement in the system.	Config Error : SL Cable PLANAR_SL7 and CTRL_DST_PA1
Config Missing	iDRAC found a configuration element missing within the closest match detected.	Missing or damaged cable, device, or part	Config Missing: Float card front PERC/HBA
		Missing element or cable is reported in HWC8010 error logs. Install the missing element (cable, riser, etc).	Config Missing : SL cable PLANAR_SL8 and CTRL_DST_PA1

**Table 11. Configuration validation error (continued)**

Error	Description	Possible cause and recommendations	Example
Comm Error	A configuration element is not responding to iDRAC using the management interface while running an inventory check.	System management sideband communication  Unplug AC Power, reseal the element and replace the element if the problem persists.	Comm Error: Backplane 2

## Error messages

This section describes the error messages displayed on the screen during POST or captured in the system event log (SEL)/ LifeCycle (LC) log.

**Table 12. Error message HWC8010**

Error code	HWC8010
Message	The System Configuration Check operation resulted in the following issue involving the indicated component type
Arguments	Riser, floating card (fPERC or BOSS), backplane, processor, cable, or other components
Detailed Description	The issue identified in the message is observed in the System Configuration Check operation.
Recommended Response Action	Do the following and retry the operation: <ol style="list-style-type: none"> <li>1. Disconnect the input power.</li> <li>2. Check for proper cable connection and component placement. If the issue persists, contact the service provider.</li> </ol>
Category	System Health (HWC = Hardware Config)
Severity	Critical
Trap/EventID	2329

**Table 13. Error message HWC8011**

Error code	HWC8011
Message	The System Configuration Check operation resulted in multiple issues involving the indicated component type
Arguments	Riser, floating card (fPERC or BOSS), backplane, processor, cable, or other components
Detailed Description	Multiple issues are observed in the System Configuration Check operation.
Recommended Response Action	Do the following and retry the operation: <ol style="list-style-type: none"> <li>1. Disconnect the input power.</li> <li>2. Check for proper cable connection and component placement. If the issue persists, contact the service provider.</li> </ol>
Category	System Health (HWC = Hardware Config)
Severity	Critical



# Installing and removing system components

## Topics:

- Safety instructions
- Before working inside your system
- After working inside your system
- Recommended tools
- Optional front bezel
- System cover
- Drive backplane cover
- Air shroud
- Cooling fans
- Intrusion switch module
- Drives
- Optional optical drive
- Drive backplane
- Cable routing
- System memory
- Processor and heat sink module
- Expansion cards and expansion card risers
- Drive cage
- Optional serial COM port
- MicroSD card
- Optional BOSS S1 card
- Optional IDSDM module
- Optional OCP card
- Front mounting front PERC module
- System battery
- Optional internal USB card
- VGA module
- Power supply unit
- Power interposer board
- System board
- Trusted Platform Module
- Control panel

## Safety instructions

 **NOTE:** Whenever you need to lift the system, get others to assist you. To avoid injury, do not attempt to lift the system by yourself.

 **CAUTION:** Ensure to have two or more people to lift the system horizontally from the box and place it on a flat surface, rack lift, or into the rails.

 **WARNING:** Opening or removing the system cover while the system is powered on may expose you to a risk of electric shock.

 **WARNING:** Do not operate the system without the cover for a duration exceeding five minutes. Operating the system without the system cover can result in component damage.

**CAUTION:** Many repairs may only be done by a certified service technician. You should only perform troubleshooting and simple repairs as authorized in your product documentation, or as directed by the online or telephone service and support team. Damage due to servicing that is not authorized by Dell is not covered by your warranty. Read and follow the safety instructions that are shipped with your product.

**NOTE:** It is recommended that you always use an antistatic mat and antistatic strap while working on components inside the system.

**CAUTION:** To ensure proper operation and cooling, all system bays and fans must always be populated with a component or a blank.

**NOTE:** While replacing the hot swappable PSU, after next server boot; the new PSU automatically updates to the same firmware and configuration of the replaced one. For more information about the Part replacement configuration, see the *Lifecycle Controller User's Guide* at <https://www.dell.com/idracmanuals>.

**NOTE:** While replacing faulty storage controller, FC, or NIC card with the same type of card, after you power on the system; the new card automatically updates to the same firmware and configuration of the faulty one. For more information about the Part replacement configuration, see the *Lifecycle Controller User's Guide* at <https://www.dell.com/idracmanuals>.

## Before working inside your system

### Prerequisites

Follow the safety guidelines listed in the [Safety instructions](#).

### Steps

1. Power off the system and all attached peripherals.
2. Disconnect the system from the electrical outlet, and disconnect the peripherals.
3. If applicable, remove the system from the rack.

For more information, see the *Rail Installation Guide* relevant to your rail solutions at [www.dell.com/poweredgemanuals](http://www.dell.com/poweredgemanuals).

4. Remove the system cover.

## After working inside your system

### Prerequisites

Follow the safety guidelines listed in [Safety instructions](#).

### Steps

1. Replace the system cover.
2. If applicable, install the system into the rack.

For more information, see the *Rail Installation Guide* relevant to your rail solutions at [www.dell.com/poweredgemanuals](http://www.dell.com/poweredgemanuals).

3. Reconnect the peripherals and connect the system to the electrical outlet, and then power on the system.

## Recommended tools

You need the following tools to perform the removal and installation procedures:

- Key to the bezel lock. The key is required only if your system includes a bezel.
- Phillips #1 screwdriver
- Phillips #2 screwdriver
- Torx #T30 screwdriver
- 5 mm hex nut screwdriver
- Plastic scribe
- 1/4-inch flat blade screwdriver

- Wrist grounding strap connected to the ground
- ESD mat
- Needle-nose pliers

You need the following tools to assemble the cables for a DC power supply unit:

- AMP 90871-1 hand-crimping tool or equivalent
- Tyco Electronics 58433-3 or equivalent
- Wire-stripper pliers to remove insulation from size 10 AWG solid or stranded, insulated copper wire

 **NOTE:** Use alpha wire part number 3080 or equivalent (65/30 stranding).

## Optional front bezel

 **NOTE:** LCD panel is optional on the front bezel. If the front bezel has an LCD panel, see [LCD panel](#) section.

## Removing the front bezel

The procedure to remove the front bezel with and without the LCD panel is the same.

### Prerequisites

1. Follow the safety guidelines listed in the [Safety instructions](#) on page 25.
2. Keep the bezel key handy.

 **NOTE:** The bezel key is part of the LCD bezel package.

### Steps

1. Unlock the bezel.
2. Press the release button, and disengage the left end of the bezel.
3. Unhook the right end, and remove the bezel.



**Figure 12. Removing the front bezel with the LCD panel**

#### Next steps

Replace the front bezel.

## Installing the front bezel

The procedure to install the front bezel with and without the LCD panel is the same.

#### Prerequisites

1. Follow the safety guidelines listed in the [Safety instructions](#).
2. Locate and remove the bezel key.

**NOTE:** The bezel key is part of the LCD bezel package.

#### Steps

1. Align and insert the tabs on the bezel into the slots on the system.
2. Press the bezel until the release button clicks in place.
3. Lock the bezel.



Figure 13. Installing the front bezel with the LCD panel

## System cover

### Removing the system cover

#### Prerequisites

1. Follow the safety guidelines listed in the [Safety instructions](#) on page 25.
2. Power off the system, and any attached peripherals.
3. Disconnect the system from the electrical outlet and peripherals.

#### Steps

1. Using a 1/4 inch flat head or Phillips #2 screwdriver, rotate the lock counterclockwise to the unlock position.
2. Lift the release latch until the system cover slides back.
3. Lift the cover from the system.



**Figure 14. Removing the system cover**

### **Next steps**

Replace the system cover.

## **Installing the system cover**

### **Prerequisites**

1. Follow the safety guidelines listed in the [Safety instructions](#) on page 25.
2. Follow the procedure listed in [Before working inside your system](#) on page 26.
3. Ensure that all internal cables are connected and routed properly, and no tools or extra parts are left inside the system.

### **Steps**

1. Align the tabs on the system cover with the guide slots on the system.
2. Close the system cover release latch.
3. Using a 1/4 inch flat head or Phillips #2 screwdriver, rotate the lock clockwise to the lock position.



**Figure 15. Installing the system cover**

#### **Next steps**

Follow the procedure listed in [After working inside your system](#) on page 26.

## **Drive backplane cover**

### **Removing the drive backplane cover**

#### **Prerequisites**

1. Follow the safety guidelines listed in the [Safety instructions](#) on page 25.
2. Follow the procedure listed in [Before working inside your system](#) on page 26.

#### **Steps**

1. Slide the backplane cover in the direction of the arrows marked on the backplane cover.
2. Lift the backplane cover from the system.

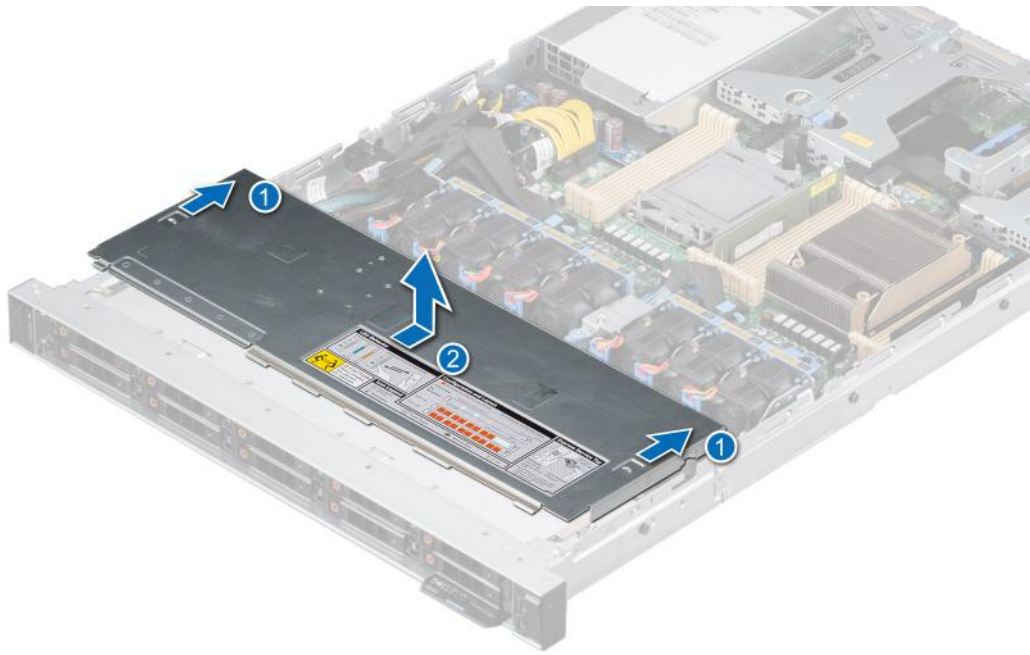

**Figure 16. Removing the drive backplane cover**

#### **Next steps**

Replace the backplane cover.

## **Installing the drive backplane cover**

#### **Prerequisites**

Follow the safety guidelines listed in the [Safety instructions](#) on page 25.

#### **Steps**

1. Align the backplane cover with the guide slots on the system.
2. Slide the backplane cover toward the front of the system until the backplane cover fits into place.



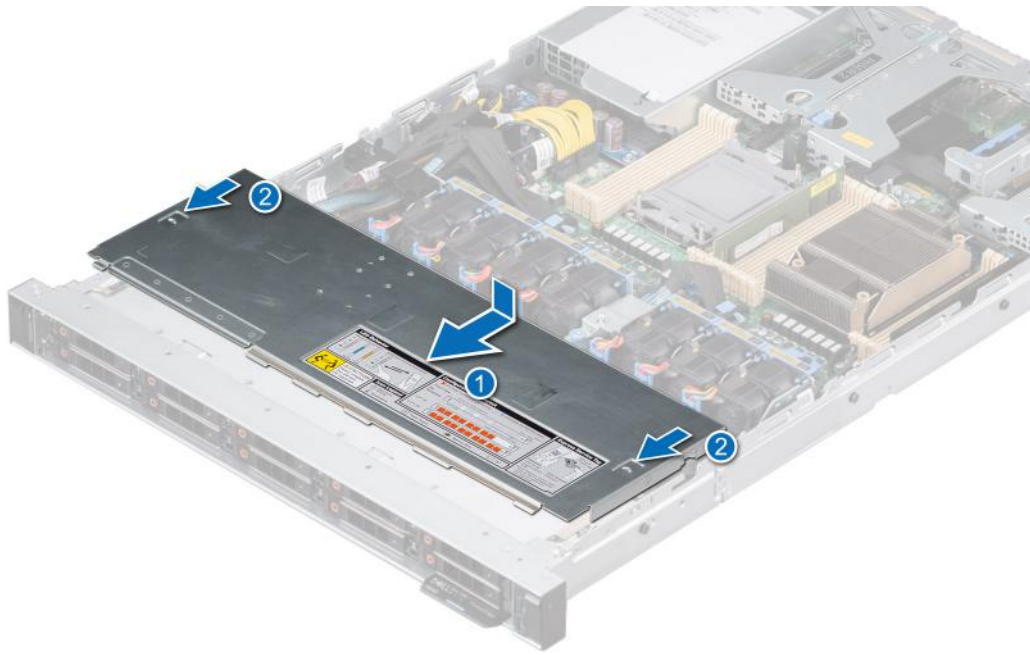

**Figure 17. Installing the drive backplane cover**

**Next steps**

Follow the procedure listed in [After working inside your system](#) on page 26.

# Air shroud

## Removing the air shroud

### Prerequisites

**CAUTION:** Never operate your system with the air shroud removed. The system may get overheated quickly, resulting in shutdown of the system and loss of data.

1. Follow the safety guidelines listed in the [Safety instructions](#) on page 25.
2. Follow the procedure listed in [Before working inside your system](#) on page 26.

### Steps

Hold the air shroud at both ends and lift the air shroud out of the system.

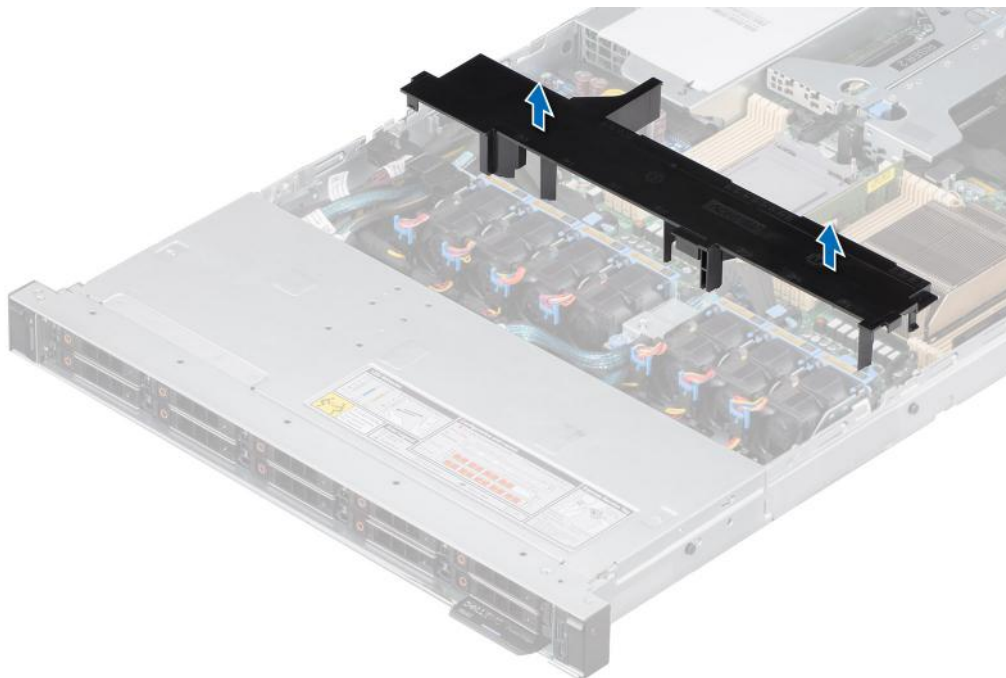

Figure 18. Removing the air shroud

### Next steps

[Replace the air shroud.](#)

## Installing the air shroud

### Prerequisites

1. Follow the safety guidelines listed in the [Safety instructions](#) on page 25.
2. Follow the procedure listed in [Before working inside your system](#) on page 26.

### Steps

1. Align the slot on the air shroud with the standoff on the chassis.
2. Lower the air shroud into the system until it is firmly seated.

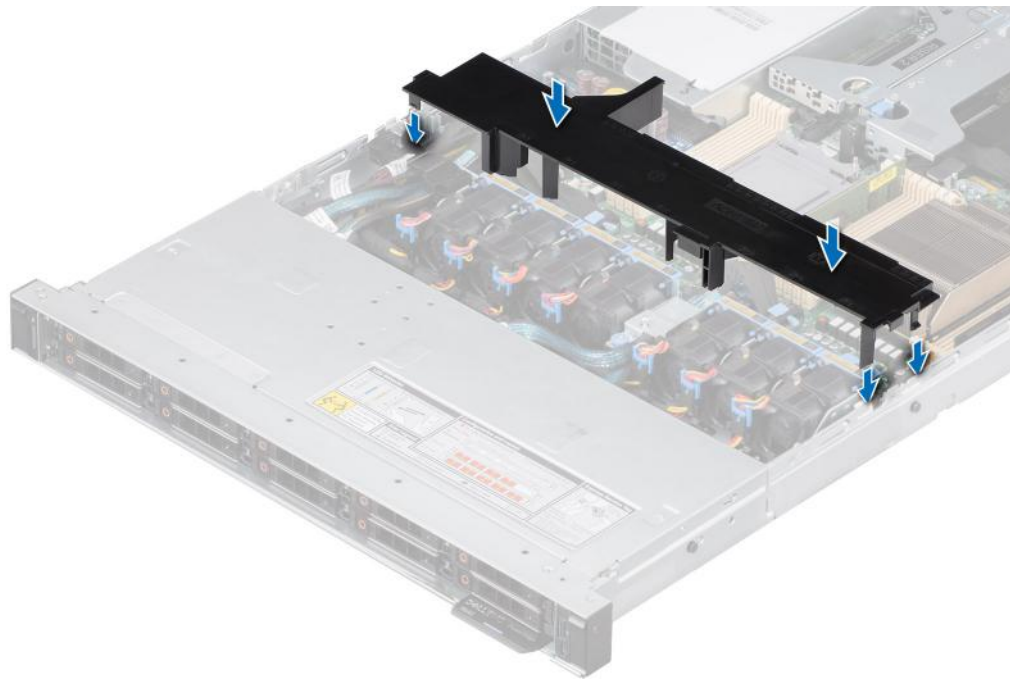

**Figure 19. Installing the air shroud**

#### **Next steps**

Follow the procedure listed in [After working inside your system](#) on page 26.

## **Cooling fans**

### **Removing a cooling fan**

#### **Prerequisites**

1. Follow the safety guidelines listed in the [Safety instructions](#) on page 25.
2. Follow the procedure listed in [Before working inside your system](#) on page 26.
3. [Remove the air shroud.](#)
4. Move the cables out of way to access the fan cable connector on the system board.

**i** **NOTE:** Observe the fan cable routing or make a note on the fan cable routing.

#### **Steps**

1. Disconnect the cooling fan cable connected to the fan dongle cable.
2. Holding the blue tab, lift the cooling fan out of the fan cage.

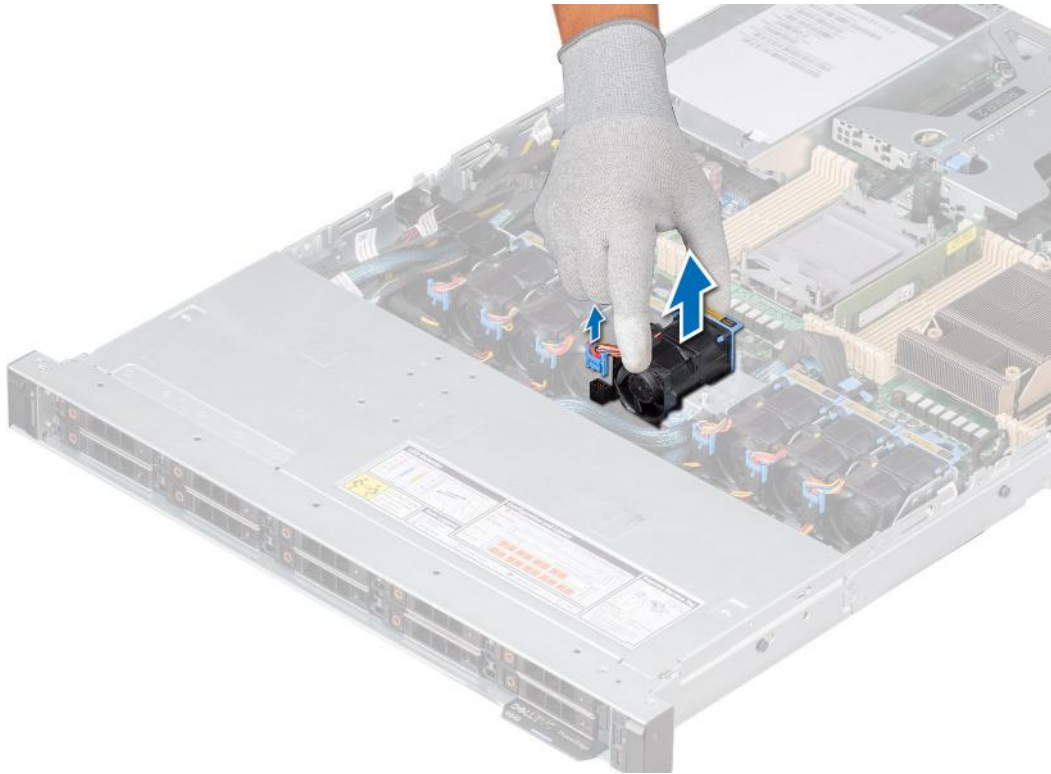

**Figure 20. Removing a cooling fan**

### **Next steps**

[Replace a fan.](#)

## **Installing a cooling fan**

### **Prerequisites**

1. Follow the safety guidelines listed in the [Safety instructions](#) on page 25.
2. Follow the procedure listed in the [Before working inside your system](#) on page 26.

### **Steps**

1. Lower the cooling fan into the cage until it is seated firmly.
2. Route the cable properly to prevent the cable from being pinched or crimped.
3. Press the release tabs on the fan cable connector and connect to the fan dangle cable.

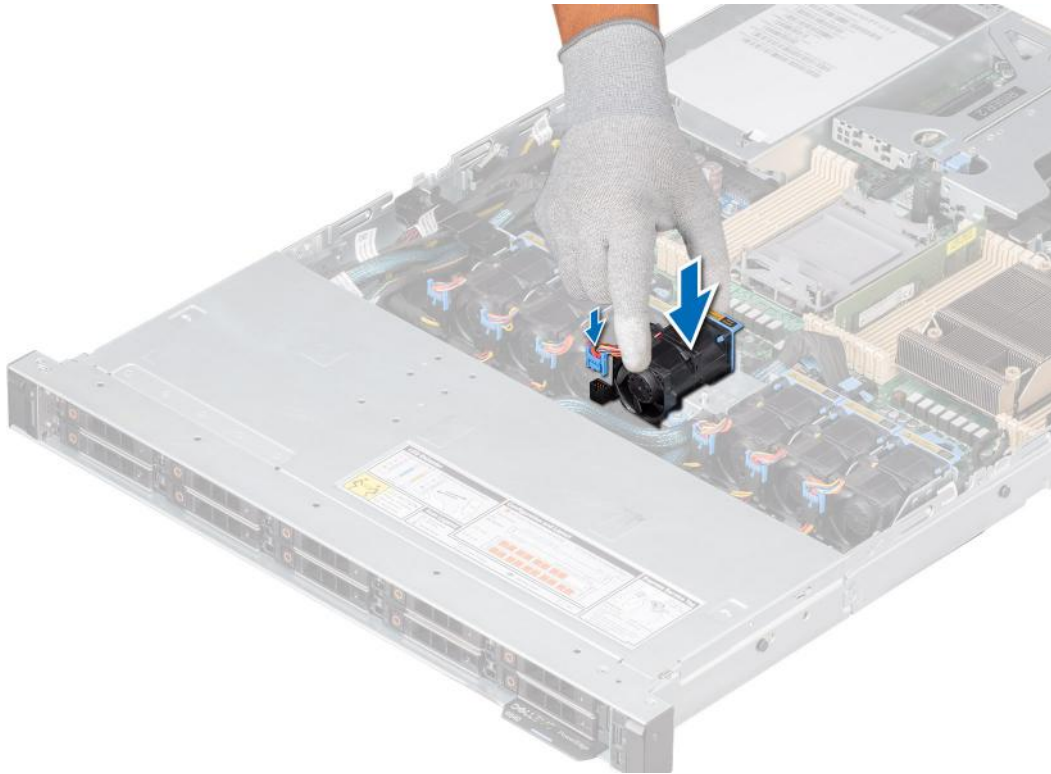

**Figure 21. Installing a cooling fan**

#### **Next steps**

1. [Install the air shroud.](#)
2. Follow the procedure listed in [After working inside your system](#) on page 26.

## **Intrusion switch module**

This is a service technician replaceable part only.

## **Removing the intrusion switch module**

#### **Prerequisites**

1. Follow the safety guidelines listed in the [Safety instructions](#) on page 25.
2. Follow the procedure listed in [Before working inside your system](#) on page 26.
3. [Remove the air shroud.](#)

#### **Steps**

1. Disconnect and remove the intrusion switch cable from the connector on the system board.  
Observe the routing of the cable as you remove it from the system.
2. Using the Phillips #1 screwdriver, remove the screw securing the intrusion switch module.
3. Lift the intrusion switch module out of the system.

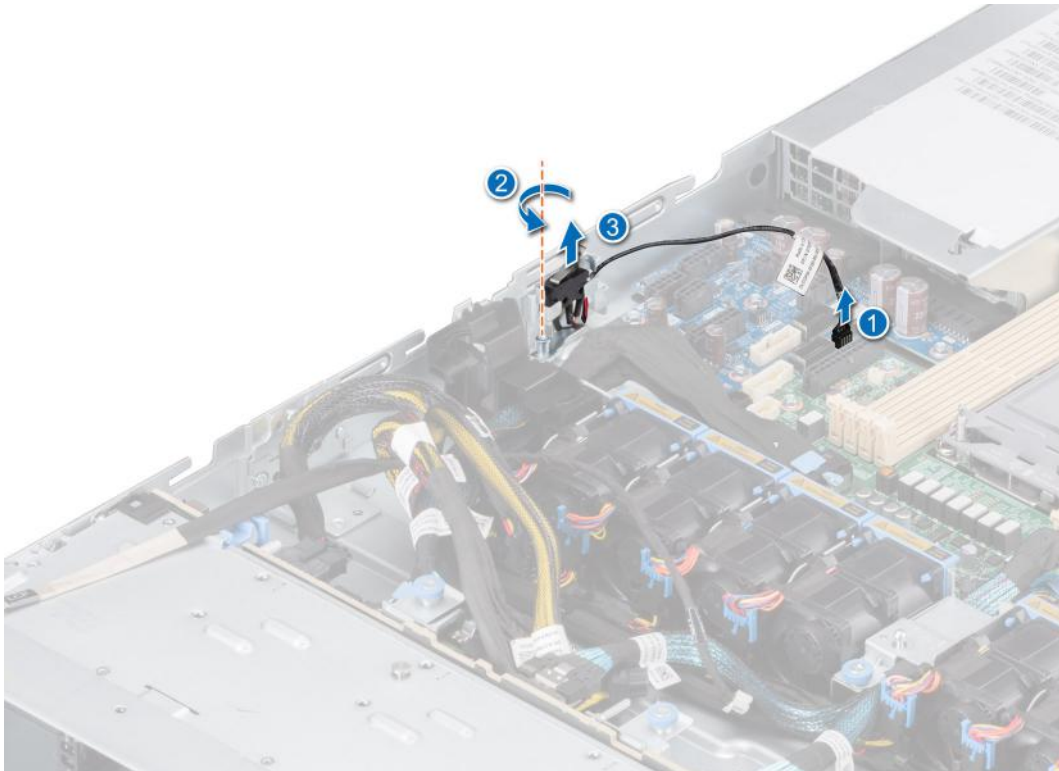

**Figure 22. Removing the intrusion switch module**

### Next steps

Replace the intrusion switch.

## Installing the intrusion switch

### Prerequisites

1. Follow the safety guidelines listed in the [Safety instructions](#) on page 25.
2. Follow the procedure listed in [Before working inside your system](#) on page 26.
3. [Remove the air shroud](#).

### Steps

1. Align and insert the intrusion switch module until it is firmly seated in the slot on the system.
2. Using the Phillips #1 screwdriver, tighten the screw securing the intrusion switch module.
3. Connect the intrusion switch cable to the connector on the system board.

**NOTE:** Route the cable properly when you replace it to prevent the cable from being pinched or crimped.

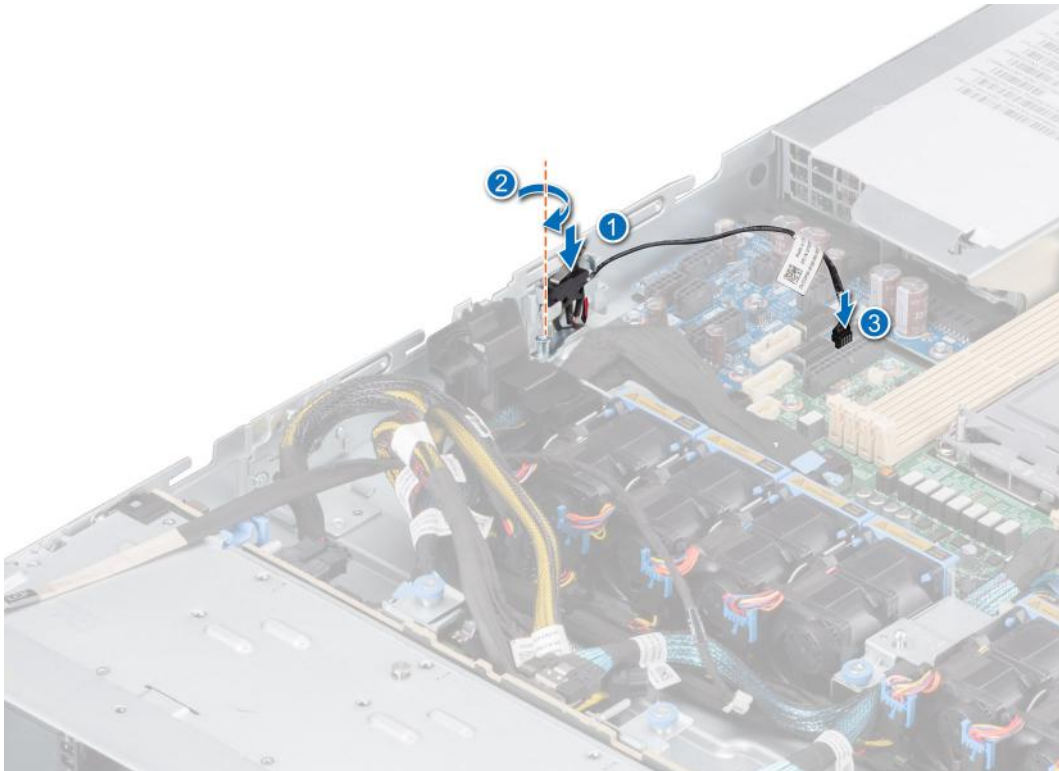

**Figure 23. Installing the intrusion switch**

#### **Next steps**

1. [Install the air shroud.](#)
2. Follow the procedure listed in [After working inside your system](#) on page 26.

## **Drives**

### **Removing a drive blank**

#### **Prerequisites**

1. Follow the safety guidelines listed in the [Safety instructions](#) on page 25.
2. If installed, [remove the front bezel.](#)

**CAUTION:** To maintain proper system cooling, drive blanks must be installed in all empty drive slots.

#### **Steps**

Press the release button, and slide the drive blank out of the drive slot.

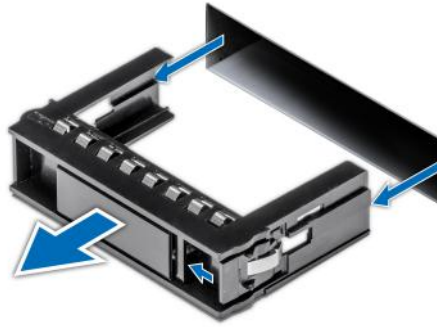

**Figure 24. Removing a drive blank**

**Next steps**

Installing a drive or replace the drive blank.

## Installing a drive blank

**Prerequisites**

1. Follow the safety guidelines listed in the [Safety instructions](#) on page 25.
2. If installed, [remove the front bezel](#).

**Steps**

Insert the drive blank into the drive slot until the release button clicks into place.



**Figure 25. Installing a drive blank**

**Next steps**

If removed, [install the front bezel](#).

## Removing the drive carrier

**Prerequisites**

1. Follow the safety guidelines listed in the [Safety instructions](#) on page 25.
2. If installed, [remove the front bezel](#).
3. Using the management software, prepare the drive for removal.

If the drive is online, the green activity or fault indicator blinks while the drive is powering off. When the drive indicators are off, the drive is ready for removal. For more information, see the documentation for the storage controller.



**CAUTION:** Before attempting to remove or install a drive while the system is running, see the documentation for the storage controller card to ensure that the host adapter is configured correctly to support drive removal and insertion.

**CAUTION:** To prevent data loss, ensure that your operating system supports drive installation. See the documentation supplied with your operating system.

### Steps

1. Press the release button to open the drive carrier release handle.
2. Holding the drive carrier release handle, slide the drive carrier out of the drive slot.



Figure 26. Removing a drive carrier

### Next steps

Install a drive carrier or drive blank.

## Installing the drive carrier

### Prerequisites

**CAUTION:** Before removing or installing a drive while the system is running, see the documentation for the storage controller card to ensure that the host adapter is configured correctly to support drive removal and insertion.

**CAUTION:** Combining SAS and SATA drives in the same RAID volume is not supported.

**CAUTION:** When installing a drive, ensure that the adjacent drives are fully installed. Inserting a drive carrier and attempting to lock its handle next to a partially installed carrier can damage the partially installed carrier's shield spring and make it unusable.

**CAUTION:** To prevent data loss, ensure that your operating system supports hot-swap drive installation. See the documentation supplied with your operating system.

**CAUTION:** When a replacement hot swappable drive is installed and the system is powered on, the drive automatically begins to rebuild. Ensure that the replacement drive is blank or contains data that you wish to overwrite. Any data on the replacement drive is immediately lost after the drive is installed.

**NOTE:** Ensure that the drive carrier's release handle is in the open position before inserting the carrier into the slot.

1. Follow the safety guidelines listed in the [Safety instructions](#) on page 25.
2. If installed, [remove the front bezel](#).
3. Remove the drive carrier or remove the drive blank when you want to assemble the drives in to the system.

### Steps

1. Hold the release handle and slide the drive carrier into the drive slot.
2. Close the drive carrier release handle to lock the drive in place.



Figure 27. Installing a drive carrier

### Next steps

If removed, [install the front bezel](#).

## Removing the drive from the drive carrier

### Prerequisites

1. Follow the safety guidelines listed in the [Safety instructions](#) on page 25.

### Steps

1. Using a Phillips #1 screwdriver, remove the screws from the slide rails on the drive carrier.

**NOTE:** If the hard drive or SSD carrier has Torx screw, use Torx 6 (for 2.5-inch drive) or Torx 8 (for 3.5-inch drive) screwdriver to remove the drive. 

2. Lift the drive out of the drive carrier.



**Figure 28. Removing the drive from the drive carrier**

### Next steps

Install the drive into the drive carrier.

## Installing the drive into the drive carrier

### Prerequisites

Follow the safety guidelines listed in the [Safety instructions](#)

**NOTE:** When installing a drive into the drive carrier, ensure that the screws are torqued to 4 in-lbs.

### Steps

1. Insert the drive into the drive carrier with the drive connector facing towards the rear of the carrier.
2. Align the screw holes on the drive with the screws holes on the drive carrier.
3. Using a Phillips #1 screwdriver, secure the drive to the drive carrier with the screws.

**NOTE:** If the hard drive or SSD carrier has Torx screw, use Torx 6 (for 2.5-inch drive) or Torx 8 (for 3.5-inch drive) screwdriver to install the drive. 



**Figure 29. Installing a drive into the drive carrier**

### Next steps

Install the drive carrier.

## Optional optical drive

This is a service technician replaceable part only.

## Removing the optical drive

The procedure for removing an optical drive and optical drive blank is the same.

### Prerequisites

1. Follow the safety guidelines listed in the [Safety instructions](#) on page 25.
2. Follow the procedure listed in the [Before working inside your system](#) on page 26.
3. If installed, [remove the front bezel](#).
4. [Remove the drive backplane cover](#).

### Steps

1. Disconnect the power and data cables from the connectors on the optical drive.

**NOTE:** Observe the routing of the cable as you remove it from the system.

2. To release the optical drive, press the release tab and push the drive towards the front of the system.
3. Slide the optical drive out of the system.

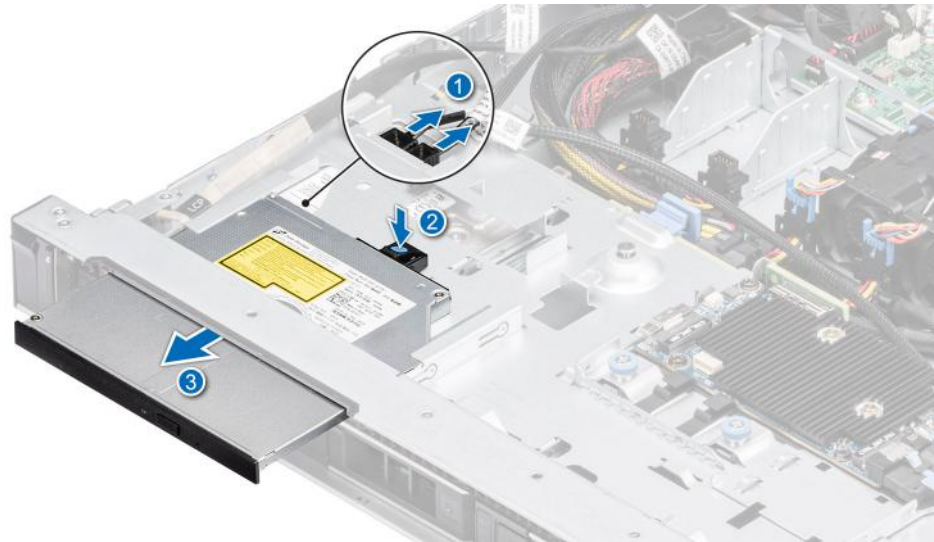

**Figure 30. Removing the optical drive**

### Next steps

Replace the optical drive.

**i** **NOTE:** Blanks must be installed on empty optical drive slot to maintain FCC certification of the system. The blank also keep dust and dirt out of the system and aid in proper cooling and airflow inside the system.

## Installing the optical drive

The procedure for installing an optical drive and optical drive blank.

### Prerequisites

1. Follow the safety guidelines listed in the [Safety instructions](#) on page 25.
2. Follow the procedure listed in the [Before working inside your system](#) on page 26.
3. If installed, remove the optical drive blank by pressing the blue release tab at the back of the blank and pushing the blank out of the system.  
**i** **NOTE:** Route the cable properly when you replace it to prevent the cable from being pinched or crimped.
4. If installed, [remove the front bezel](#).
5. [Remove the drive backplane cover](#).

### Steps

1. Align the optical drive with the optical drive slot on the front of the system.
2. Insert the optical drive until the blue release tab locks in the slot on the system.  
**i** **NOTE:** Route the cable properly to prevent the cable from being pinched or crimped.

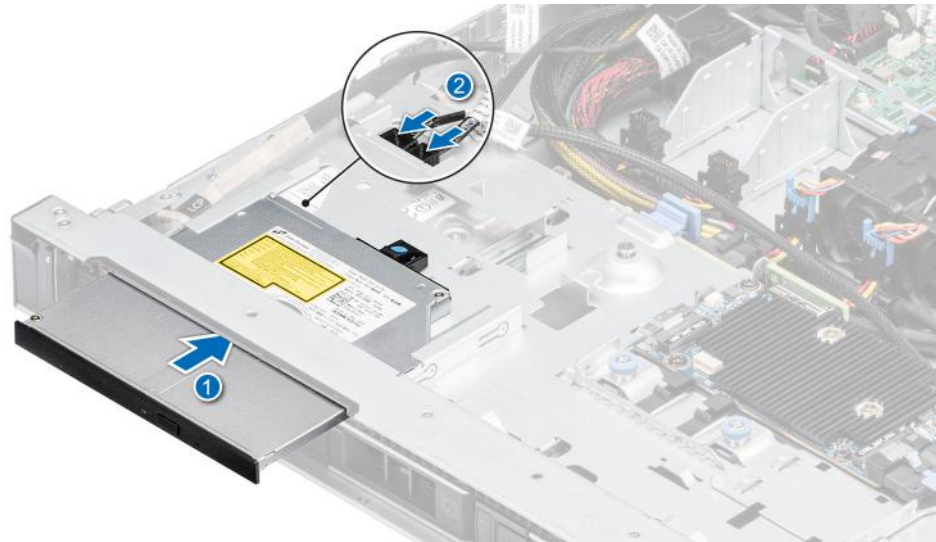

**Figure 31. Installing the optical drive**

3. Connect the power and data cables to the connectors on the system board.

**Next steps**

1. If removed, [install the front bezel](#).
2. [Install the drive backplane cover](#).
3. Follow the procedure listed in [After working inside your system](#) on page 26.

## Drive backplane

This is a service technician replaceable part only.

## Drive backplane

Depending on your system configuration, the drive backplanes supported are listed here:

**Table 14. Supported backplane options**

System	Supported hard drives options
PowerEdge R650xs	Up to 4 x 3.5-inch SAS/SATA (HDD/SSD) backplane
	Up to 8 x 2.5-inch SAS/SATA/NVMe (HDD/SSD) backplane
	Up to 10 x 2.5-inch SAS/SATA/NVMe (HDD/SSD) backplane



**Figure 32. 4 x 3.5-inch drive backplane**

1. BP\_PWR\_1 (backplane power and signal cable to PIB)

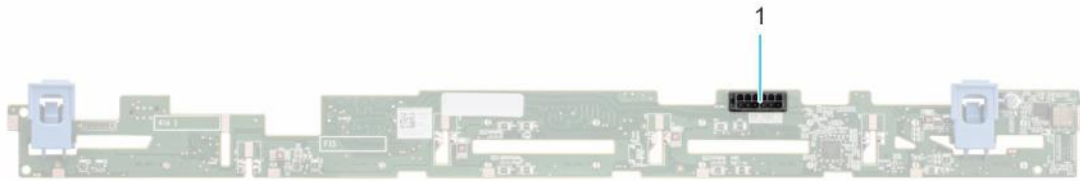

**Figure 33. 8 x 2.5-inch drive backplane**

1. BP\_PWR\_1 (backplane power and signal cable to PIB)

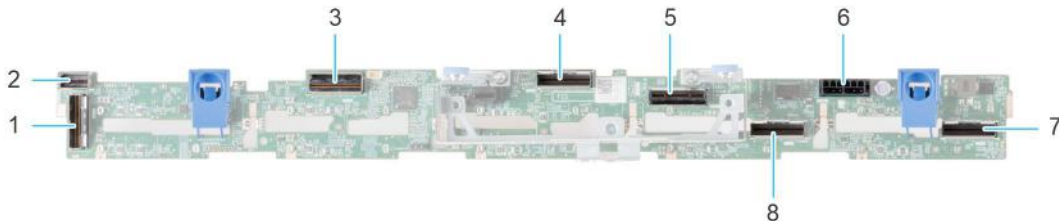

**Figure 34. 10 x 2.5-inch NVMe drive backplane**

- |                                  |   |
|----------------------------------|---|
| 1. DST_PA3 (PCIe/NVMe connector) | 2. DST_SA2 (backplane to front PERC)                  |
| 3. DST_PB2 (PCIe/NVMe connector) | 4. DST_PA2 (PCIe/NVMe connector)                      |
| 5. DST_SA1 (PERC to backplane)   | 6. BP_PWR_1 (backplane power and signal cable to PIB) |
| 7. DST_PA1 (PCIe/NVMe connector) | 8. DST_PB1 (PCIe/NVMe connector)                      |

## Removing the backplane

### Prerequisites

**CAUTION:** To prevent damage to the drives and backplane, remove the drives from the system before removing the backplane.

**CAUTION:** Note the number of each drive and temporarily label them before you remove the drive so that you can reinstall them in the same location.

**NOTE:** The procedure to remove the backplane is similar for all backplane configurations.

1. Follow the safety guidelines listed in the [Safety instructions](#) on page 25.
2. Follow the procedure listed in the [Before working inside your system](#) on page 26.
3. [Remove the air shroud.](#)
4. [Remove the backplane cover](#)
5. Remove all the drives.
6. Disconnect the VGA cable from the system board.
  - NOTE:** Observe the routing of the cable as you remove it from the system.
7. If installed, disconnect the optical drive signal and power cables from the system.
8. Disconnect the drive backplane cables from the connectors on the system board.

### Steps

1. Press the blue release tabs to disengage the drive backplane from the hooks on the system.
2. Lift the drive backplane out of the system.
  - NOTE:** To avoid damaging the backplane, ensure that you move the control panel cables from the cable routing clips before removing the backplane.



**Figure 35. Removing the backplane**

### Next steps

Replace the drive backplane.

## Installing the drive backplane

### Prerequisites

1. Follow the safety guidelines listed in the [Safety instructions](#) on page 25.
2. Follow the procedure listed in the [Before working inside your system](#) on page 26.
3. [Remove the air shroud.](#)
4. [Remove the backplane cover](#)
5. Remove all the drives.

**i** **NOTE:** To avoid damaging the backplane, ensure to move the control panel cables from the cable routing clips before removing the backplane.

**i** **NOTE:** Route the cable properly when you replace it to prevent the cable from being pinched or crimped.

### Steps

1. Use the hooks on the system as guides to align the slots on the backplane with the guides on the system.
2. Insert the backplane into the guides and lower the backplane until the blue release tabs click into place.





**Figure 36. Installing the drive backplane**

**Next steps**

1. Reconnect all the disconnected cables to the backplane.
2. Install all the drives.
3. [Install the air shroud.](#)
4. [Install the backplane cover.](#)
5. Follow the procedure listed in [After working inside your system](#) on page 26.

# Cable routing

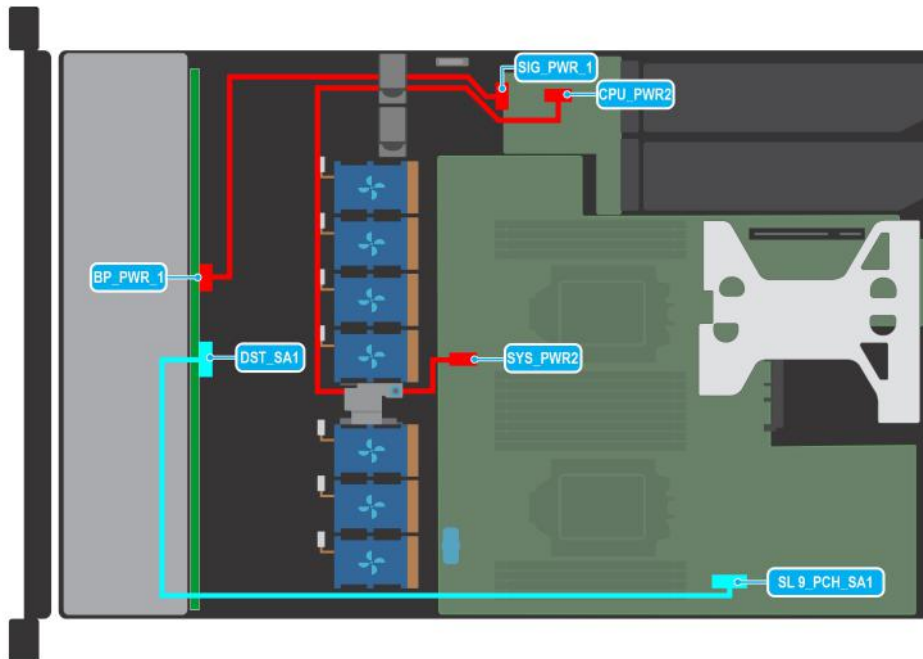

Figure 37. Cable routing - 4 x 3.5-inch drive backplane with Butterfly riser

Table 15. Connector descriptions for 4 x 3.5-inch drive backplane with Butterfly riser

From	To
BP_PWR_1 (backplane power connector)	SIG_PWR_1 (system board power connector)
DST_SA1 (backplane SATA connector, cable marking BP SA1)	SL_9_PCH_SA1 (signal connector on the system board, cable marking MB SL9)
SYS_PWR_2 (system board power connector)	CPU_PWR_2 (PSU power connector)

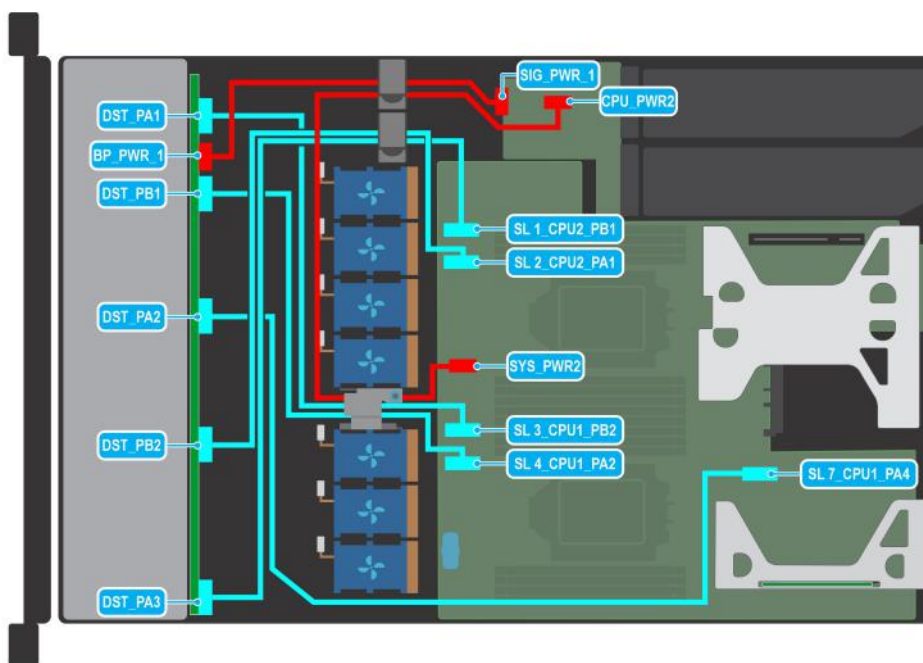
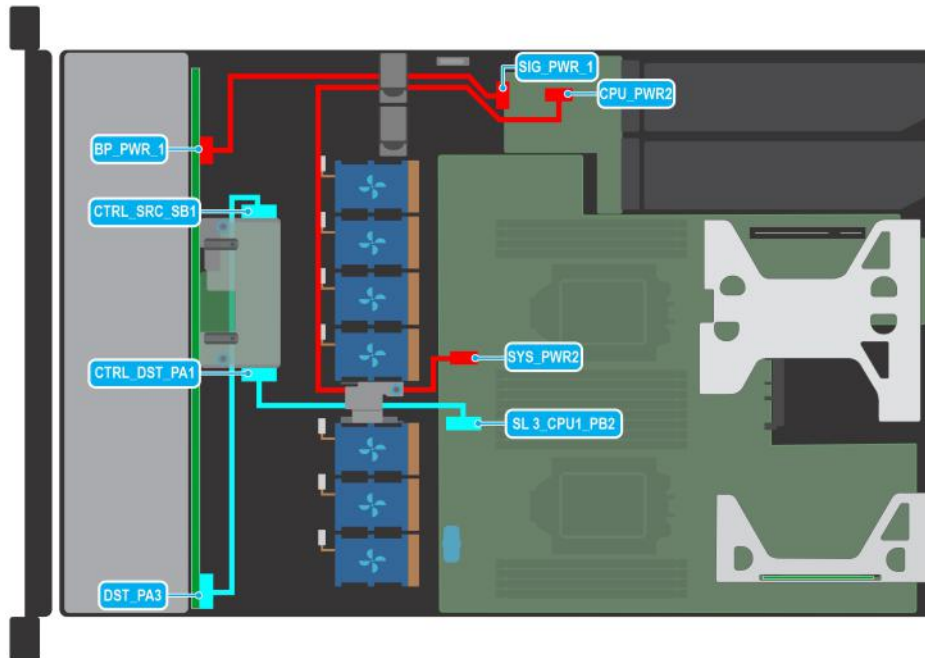

Figure 38. Cable routing - 10 x 2.5-inch drive backplane to the onboard controller (6:4 NVMe)

**Table 16. Connector descriptions for 10 x 2.5-inch drive backplane to the onboard controller (6:4 NVMe)**

From	To
BP_PWR_1 (backplane power connector)	SIG_PWR_1 (system board power connector)
DST_PA1 (backplane SATA connector, cable marking BP PA1)	SL3_CPU1_PB2 (signal connector on the system board, cable marking MB SL3)
SYS_PWR2 (system board power connector)	CPU_PWR2 (PSU power connector)
DST_PB1 (backplane SATA connector, cable marking BP PB1)	SL4_CPU1_PA2 (signal connector on the system board, cable marking MB SL4)
DST_PA2 (backplane SATA connector, cable marking BP PA2)	SL7_CPU1_PA4 (signal connector on the system board, cable marking MB SL7)
DST_PB2 (backplane SATA connector, cable marking BP PB2)	SL2_CPU2_PA1 (signal connector on the system board, cable marking MB SL2)
DST_PA3 (backplane SATA connector, cable marking BP PA3)	SL1_CPU2_PB1 (signal connector on the system board, cable marking MB SL1)



**Figure 39. Cable routing - 10 x 2.5-inch drive backplane with Butterfly riser and fPERC**

**Table 17. Connector descriptions for 10 x 2.5-inch drive backplane with Butterfly riser and fPERC**

From	To
BP_PWR_1 (backplane power connector)	SIG_PWR_1 (system board power connector)
SYS_PWR2 (system board power connector)	CPU_PWR2 (PSU power connector)
DST_PA3 (backplane SATA connector, cable marking BP PA3)	CTRL_SRC_SB1 (fPERC connector on the backplane)
CTRL_DST_PA1 (fPERC connector on the backplane)	SL3_CPU1_PB2 (signal connector on the system board, cable marking MB SL3)

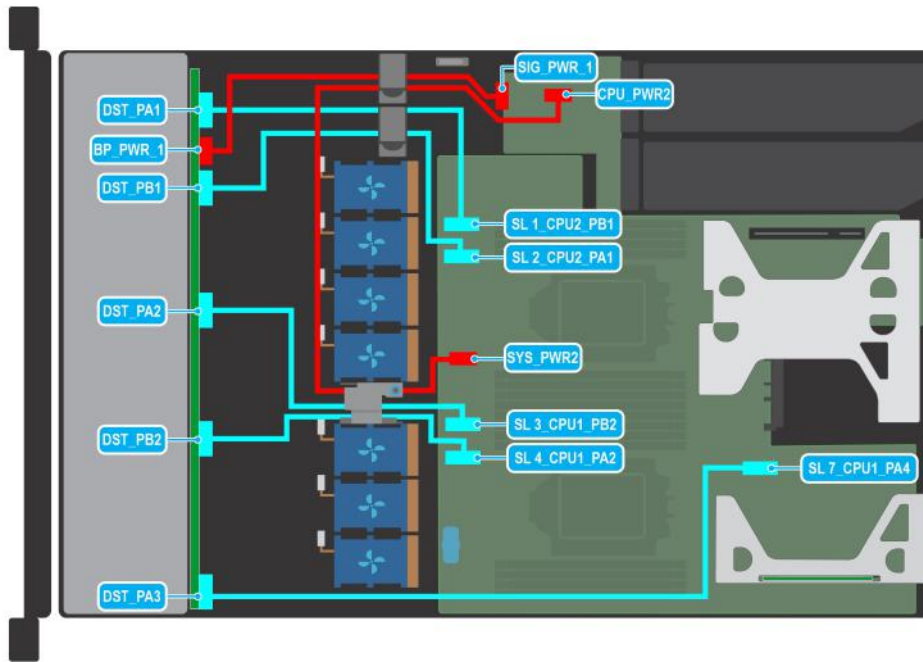

Figure 40. Cable routing - 10 x 2.5-inch drive backplane on the onboard controller (4:6 NVMe)

Table 18. Connector descriptions for 10 x 2.5-inch drive backplane to the onboard controller (6:4 NVMe)

From	To
BP_PWR_1 (backplane power connector)	SIG_PWR_1 (system board power connector)
DST_PA1 (backplane SATA connector, cable marking BP PA1)	SL1_CPU22_PB1 (signal connector on the system board, cable marking MB SL9)
SYS_PWR2 (system board power connector)	CPU_PWR2 (PSU power connector)
DST_PB1 (backplane SATA connector, cable marking BP PB1)	SL2_CPU2_PA1 (signal connector on the system board, cable marking MB SL2)
DST_PA2 (backplane SATA connector, cable marking BP PA2)	SL3_CPU1_PB2 (signal connector on the system board, cable marking MB SL3)
DST_PB2 (backplane SATA connector, cable marking BP PB2)	SL4_CPU2_PA2 (signal connector on the system board, cable marking MB SL4)
DST_PA3 (backplane SATA connector, cable marking BP PA3)	SL7_CPU1_PA4 (signal connector on the system board, cable marking MB SL7)

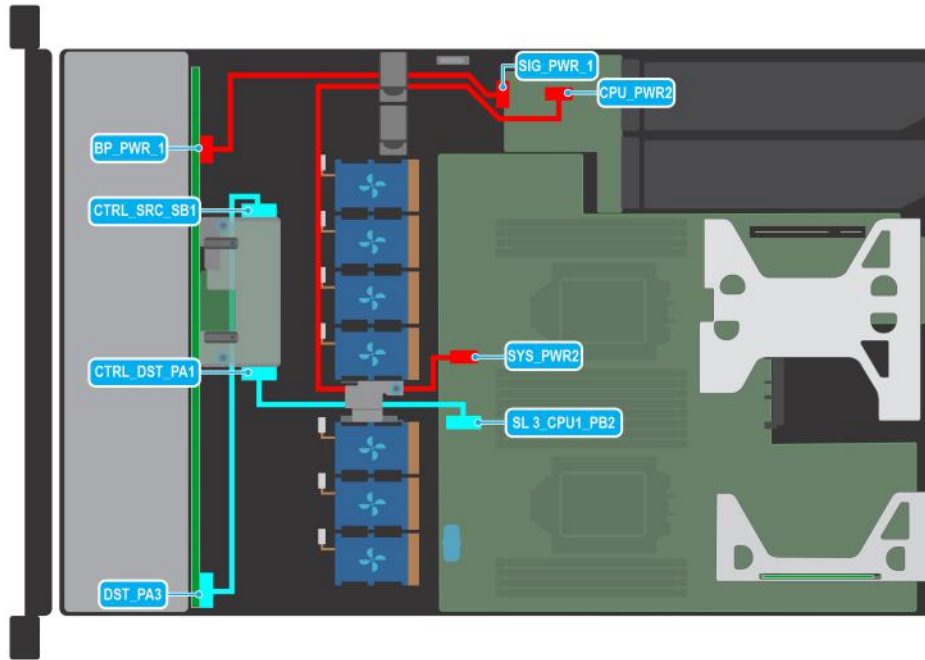

Figure 41. Cable routing - 10 x 2.5-inch drive SAS/SATA backplane with fPERC, Butterfly riser

Table 19. Connector descriptions for 10 x 2.5-inch drive SAS/SATA backplane with fPERC, Butterfly riser

From	To
BP_PWR_1 (backplane power connector)	SIG_PWR_1 (system board power connector)
SYS_PWR2 (system board power connector)	CPU_PWR2 (PSU power connector)
DST_PA3 (backplane SATA connector, cable marking BP PA3)	CTRL_SRC_SB1 (fPERC connector on the backplane)
CTRL_DST_PA1 (fPERC connector on the backplane)	SL_3_CPU1_PB2 (signal connector on the system board, cable marking MB SL3)

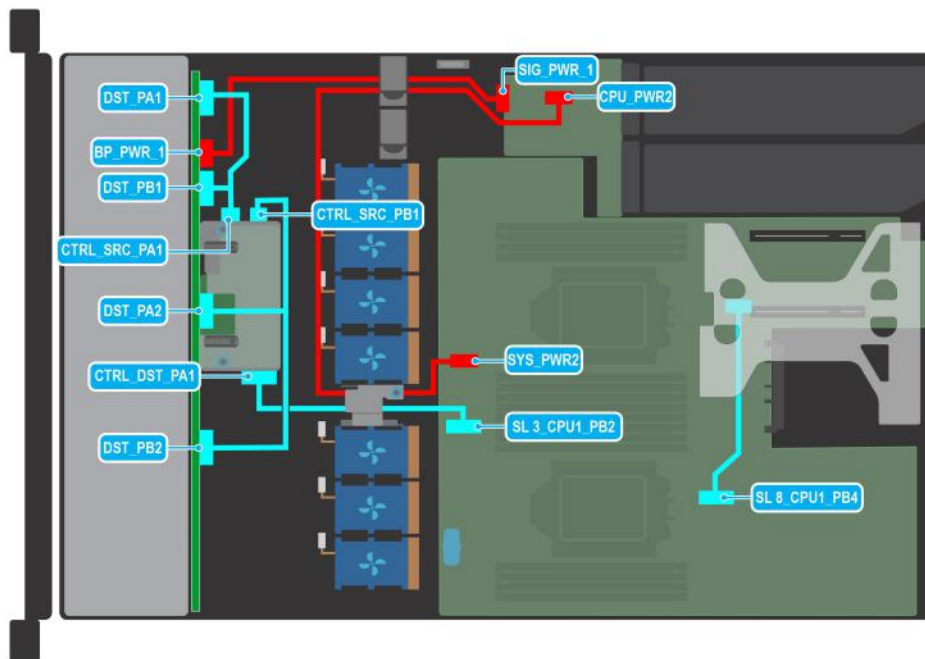
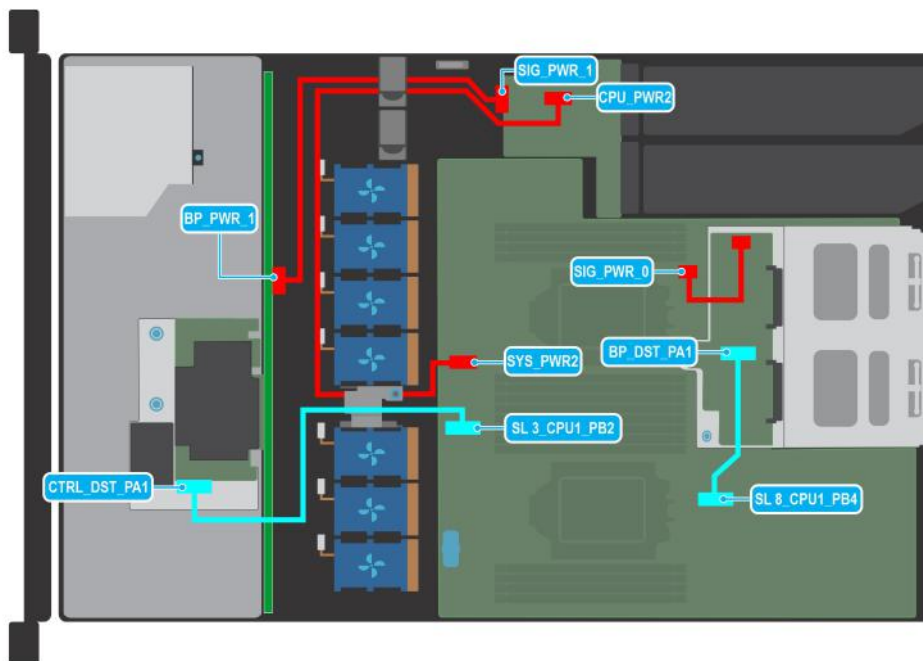

Figure 42. Cable routing - 8 x 2.5-inch drive NVMe backplane with fPERC, Butterfly riser, BOSS riser, SNAPi

**Table 20. Connector descriptions for 8 x 2.5-inch drive NVMe backplane with fPERC, Butterfly riser, BOSS riser, SNAPI**

From	To
BP_PWR_1 (backplane power connector)	SIG_PWR_1 (system board power connector)
SYS_PWR2 (system board power connector)	CPU_PWR2 (PSU power connector)
DST_PA1 and DST_PB1 (backplane SATA connector, cable marking BP PA1 and PB1)	CTRL_SRC_PB1 (fPERC connector on the backplane)
DST_PA2 and DST_PB2 (backplane SATA connector, cable marking BP PA2 and PB2)	CTRL_SRC_PB1 (fPERC connector on the backplane)
CTRL_DST_PA1 (fPERC connector on the backplane)	SL3_CPU1_PB2 (signal connector on the system board, cable marking MB SL3)
Connect riser	SL8_CPU1_PB4 (signal connector on the system board, cable marking MB SL8)



**Figure 43. Cable routing - 4 x 3.5-inch drive SAS/SATA backplane with fPERC with rear drive cage with NVMe backplane**

**Table 21. Connector descriptions for 4 x 3.5-inch drive SAS/SATA backplane with fPERC with rear drive cage with NVMe backplane**

From	To
BP_PWR_1 (backplane power connector)	SIG_PWR_1 (system board power connector)
SYS_PWR2 (system board power connector)	CPU_PWR2 (PSU power connector)
CTRL_DST_PA1 (fPERC connector on the backplane)	SL3_CPU1_PB2 (signal connector on the system board, cable marking MB SL3)
BP_DST_PA1 (backplane SATA connector, cable marking BP PA1)	SL8_CPU1_PB4 (signal connector on the system board, cable marking MB SL8)

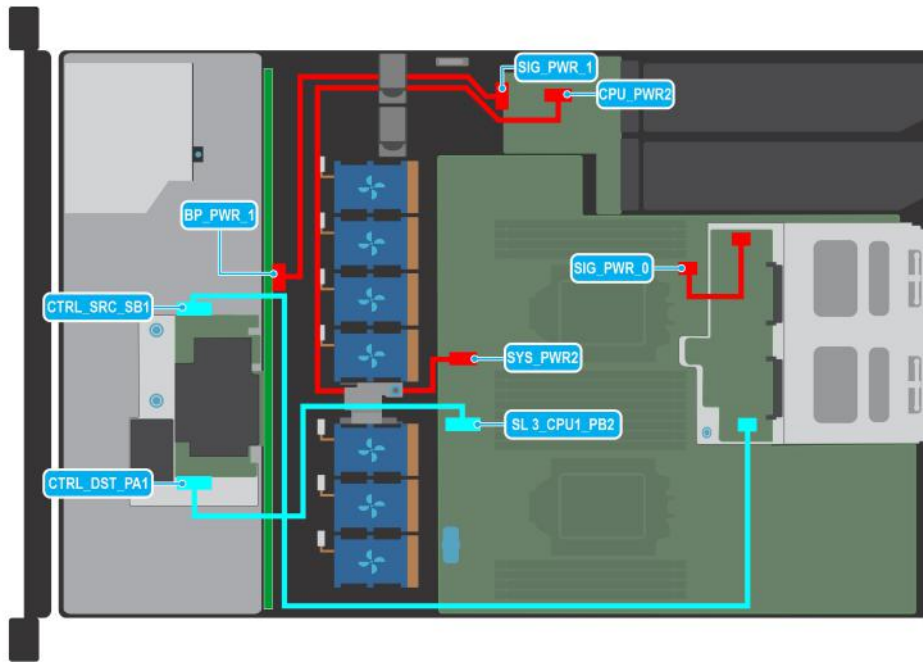

Figure 44. Cable routing - 4 x 3.5-inch drive SAS/SATA backplane with rear drive cage with SAS backplane, Butterfly riser

Table 22. Connector descriptions for 4 x 3.5-inch drive SAS/SATA backplane with rear drive cage with SAS backplane, Butterfly riser

From	To
BP_PWR_1 (backplane power connector)	SIG_PWR_1 (system board power connector)
SYS_PWR2 (system board power connector)	CPU_PWR2 (PSU power connector)
CTRL_DST_PA1 (fPERC connector on the backplane)	SL3_CPU1_PB2 (signal connector on the system board, cable marking MB SL3)

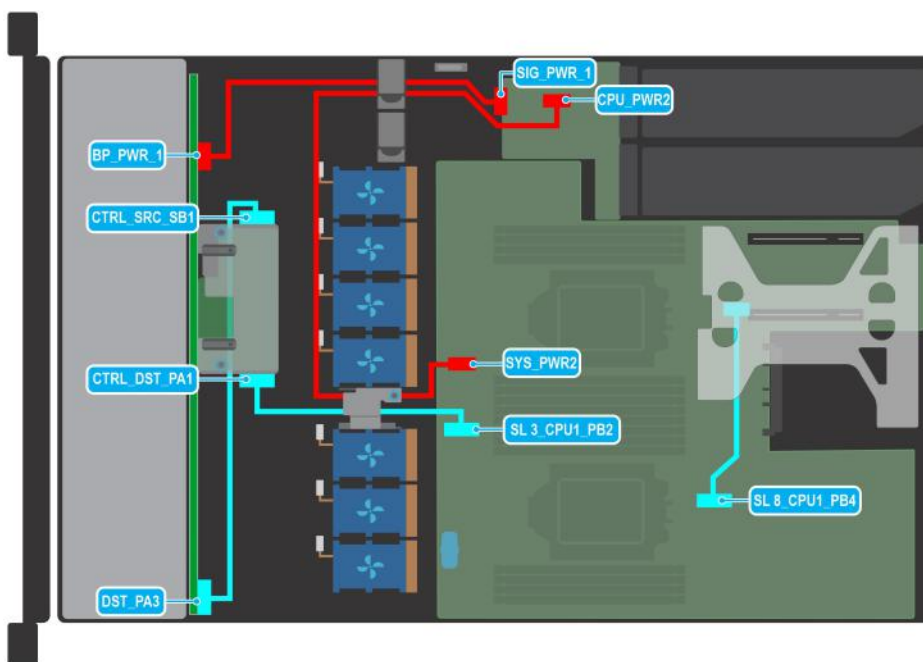
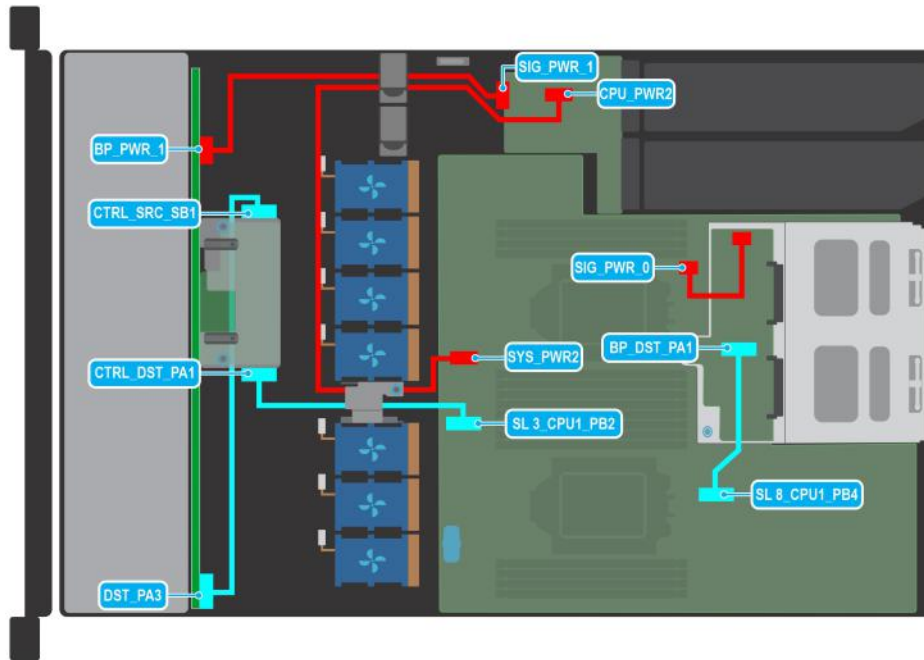

Figure 45. Cable routing - 10 x 2.5-inch drive SAS/SATA backplane with Butterfly riser

**Table 23. Connector descriptions for 10 x 2.5-inch drive SAS/SATA backplane with Butterfly riser**

From	To
BP_PWR_1 (backplane power connector)	SIG_PWR_1 (system board power connector)
SYS_PWR2 (system board power connector)	CPU_PWR2 (PSU power connector)
CTRL_DST_PA1 (fPERC connector on the backplane)	SL3_CPU1_PB2 (signal connector on the system board, cable marking MB SL3)
DST_PA3 (backplane SATA connector, cable marking BP PA3)	CTRL_SRC_ SB1 (fPERC connector on the backplane)



**Figure 46. Cable routing - 10 x 2.5-inch drive SAS/SATA backplane with rear drive cage with NVMe backplane, Butterfly riser**

**Table 24. Connector descriptions for 10 x 2.5-inch drive SAS/SATA backplane with rear drive cage with NVMe backplane, Butterfly riser**

From	To
BP_PWR_1 (backplane power connector)	SIG_PWR_1 (system board power connector)
SYS_PWR2 (system board power connector)	CPU_PWR2 (PSU power connector)
CTRL_DST_PA1 (fPERC connector on the backplane)	SL3_CPU1_PB2 (signal connector on the system board, cable marking MB SL3)
DST_PA3 (backplane SATA connector, cable marking BP PA3)	CTRL_SRC_ SB1 (fPERC connector on the backplane)
BP_DST_PA1 (backplane SATA connector, cable marking BP PA1)	SL8_CPU1_PB4 (signal connector on the system board, cable marking MB SL8)



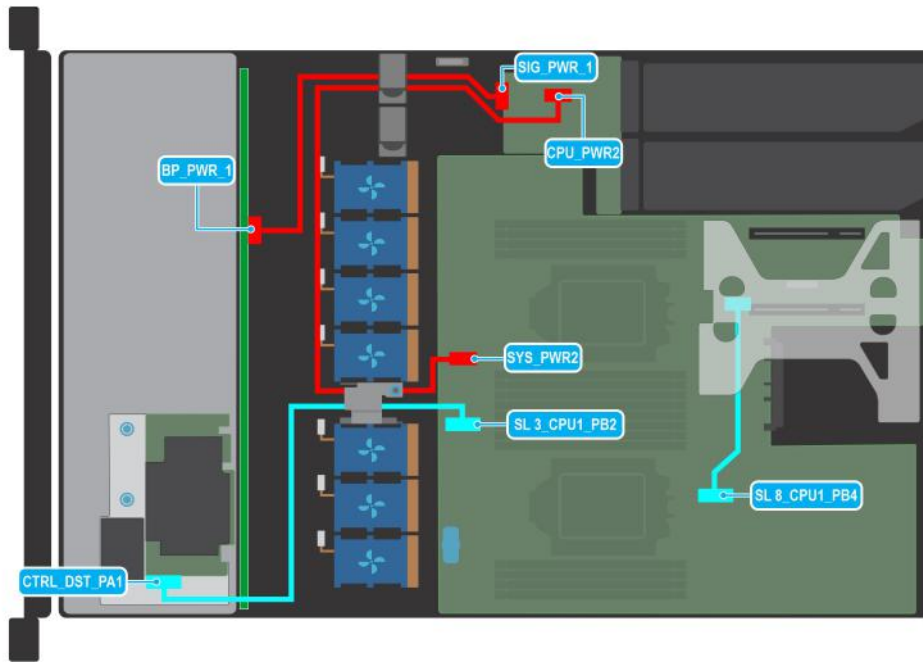

Figure 47. Cable routing - 8 x 2.5-inch drive SAS/SATA backplane with SNAPI riser

Table 25. Connector descriptions for 8 x 2.5-inch drive SAS/SATA backplane with SNAPI riser

From	To
BP_PWR_1 (backplane power connector)	SIG_PWR_1 (system board power connector)
SYS_PWR2 (system board power connector)	CPU_PWR2 (PSU power connector)
CTRL_DST_PA1 (fPERC connector on the backplane)	SL3_CPU1_PB2 (signal connector on the system board, cable marking MB SL3)

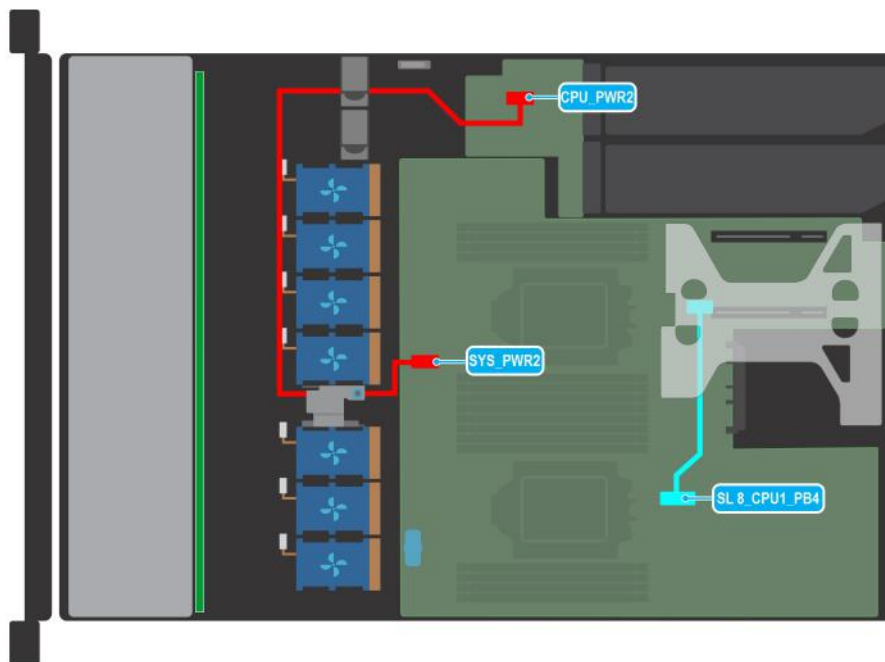

Figure 48. Cable routing - No drives with SNAPI riser

**Table 26. Connector descriptions for No drive configuration**

From	To
SYS_PWR2 (system board power connector)	CPU_PWR2 (PSU power connector)

## System memory

### System memory guidelines

The PowerEdge R650xs system supports DDR4 registered DIMMs (RDIMMs). System memory holds the instructions that are executed by the processor.

Your system contains 16 memory sockets organized into 8 channels per processor.

Memory channels are organized as follows:

**Table 27. Memory channels**

Processor	Channel A	Channel B	Channel C	Channel D	Channel E	Channel F	Channel G	Channel H
Processor 1	A1	A5	A3	A7	A2	A6	A4	A8
Processor 2	B1	B5	B3	B7	B2	B6	B4	B8

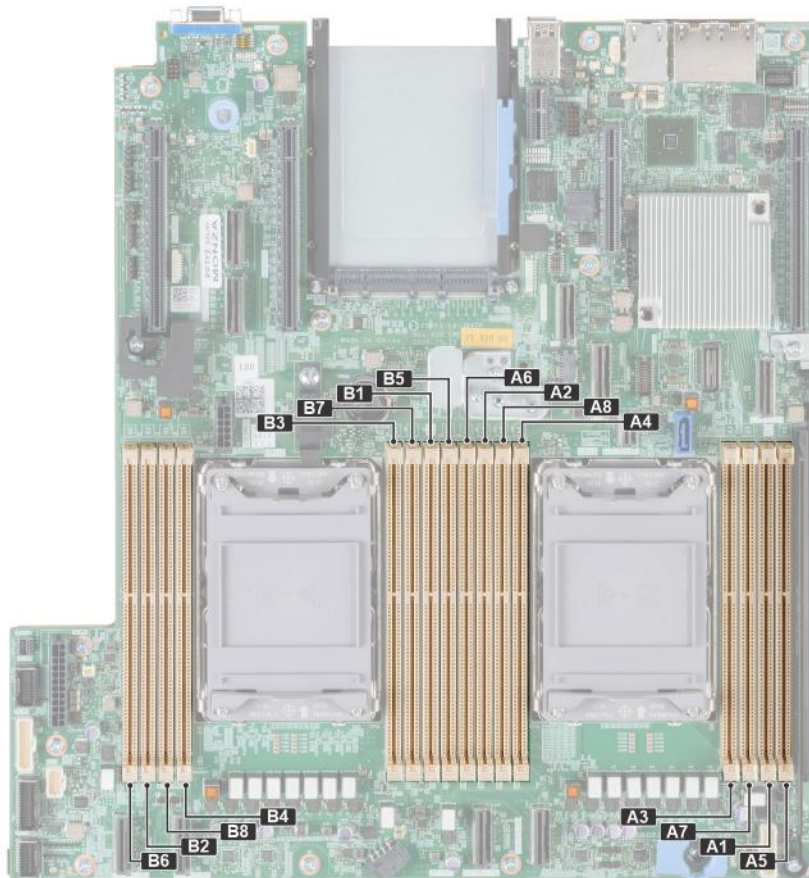

**Figure 49. Memory socket location**

**Table 28. Supported memory matrix**

DIMM type	Rank	Capacity	DIMM rated voltage and speed	DIMMs per Channel (DPC)
RDIMM	1R	8 GB	DDR4 (1.2V), 3200 MT/s	3200 MT/s
	2R	16 GB / 32 GB / 64 GB	DDR4 (1.2V), 3200 MT/s	3200 MT/s

## General memory module installation guidelines

To ensure optimal performance of your system, observe the following general guidelines when configuring your system memory. If your system's memory configurations fail to observe these guidelines, your system might not boot, stop responding during memory configuration, or operate with reduced memory.

The memory bus may operate at speeds of 3200 MT/s, 2933 MT/s depending on the following factors:

- System profile selected (for example, Performance Optimized, or Custom [can be run at high speed or lower])
- Maximum supported DIMM speed of the processors
- Maximum supported speed of the DIMMs

**i NOTE:** MT/s indicates DIMM speed in MegaTransfers per second.

The system supports Flexible Memory Configuration, enabling the system to be configured and run in any valid chipset architectural configuration. The following are the recommended guidelines for installing memory modules:

- All DIMMs must be DDR4.
- x4 and x8 DRAM based memory modules can be mixed.
- If memory modules with different speeds are installed, they operate at the speed of the slowest installed memory module(s).
- Populate memory module sockets only if a processor is installed.
  - For single-processor systems, sockets A1 to A8 are available.
  - For dual-processor systems, sockets A1 to A8 and sockets B1 to B8 are available.
- In Optimizer Mode, the DRAM controllers operate independently in the 64-bit mode and provide optimized memory performance.

**Table 29. Memory population rules**

Processor	Configuration	Memory population	Memory population information
Single processor	Optimizer (Independent channel) population order	A{1}, A{2}, A{3}, A{4}, A{5}, A{6}, A{7}, A{8}	1, 2, 3, 4 DIMMs are allowed.
Dual processor (Start with processor1. Processor 1 and processor 2 population should match)	Optimizer (Independent channel) population order	A{1}, B{1}, A{2}, B{2}, A{3}, B{3}, A{4}, B{4}, A{5}, B{5}, A{6}, B{6}, A{7}, B{7}, A{8}, B{8}	1, 2, 3, 4, 5, 6, 7, 8 DIMMs are supported per system . <b>i NOTE:</b> Optimizer population order is not traditional for 8 and 16 DIMMs installations for dual processor.

- Memory modules of different capacities can be mixed provided other memory population rules are followed.
  - i NOTE:** For example, 8 GB and 16 GB memory modules can be mixed.
- Mixing of more than two memory module capacities in a system is not supported.
- Unbalanced or odd memory configuration results in a performance loss and system may not identify the memory modules being installed, so always populate memory channels identically with equal DIMMs for best performance.
- Supported RDIMM / LRDIMM configurations are 1, 2, 4, 6, 8 DIMMs per processor.
- Populate eight equal memory modules per processor (one DIMM per channel) at a time to maximize performance.
  - i NOTE:** Equal memory modules refer to DIMMs with identical electrical specification and capacity that may be from different vendors.

# Removing a memory module

## Prerequisites

1. Follow the safety guidelines listed in the [Safety instructions](#) on page 25.
2. Follow the procedure listed in the [Before working inside your system](#) on page 26.
3. [Remove the air shroud](#).

**⚠ WARNING:** The memory modules are hot to touch for some time after the system has been powered off. Allow the memory modules to cool before handling them.

**ℹ NOTE:** To ensure proper system cooling, memory module blanks must be installed in any memory socket that is not occupied. Remove memory module blanks only if you intend to install memory modules in those sockets.

## Steps

1. Locate the appropriate memory module socket.
2. To release the memory module from the socket, simultaneously press the ejectors on both ends of the memory module socket to fully open.

**⚠ CAUTION:** Handle each memory module only by the card edges, ensuring not to touch the middle of the memory module or metallic contacts.

3. Lift the memory module away from the system.

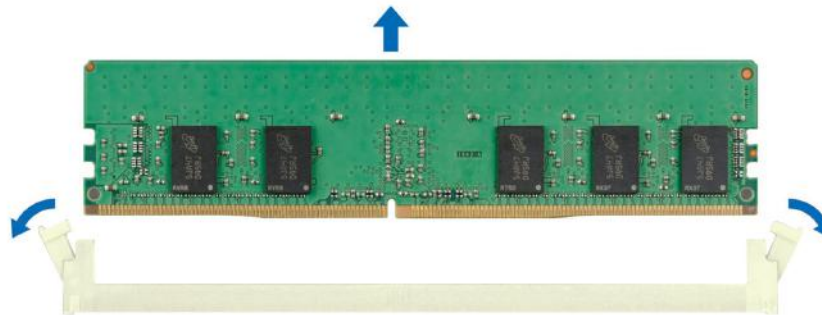

Figure 50. Removing a memory module

## Next steps

1. [Replace the memory module](#).
2. If you are removing the memory module permanently, install a memory module blank. The procedure to install a memory module blank is similar to that of the memory module.

**ℹ NOTE:** When operating your system with single processor, install memory module blanks in processor 2 memory sockets.

# Installing a memory module

## Prerequisites

1. Follow the safety guidelines listed in the [Safety instructions](#) on page 25.
2. Follow the procedure listed in [Before working inside your system](#) on page 26.
3. [Remove the air shroud](#).

## Steps

1. Locate the appropriate memory module socket.

**CAUTION:** Handle each memory module only by the card edges, ensuring not to touch the middle of the memory module or metallic contacts.

2. If a memory module is installed in the socket, remove it.

**NOTE:** Ensure the socket ejector latches are fully open, before installing the memory module.

3. Align the edge connector of the memory module with the alignment key of the memory module socket, and insert the memory module in the socket.

**CAUTION:** To prevent damage to the memory module or the memory module socket during installation, do not bend or flex the memory module; insert both ends of the memory module simultaneously.

**NOTE:** The memory module socket has an alignment key that enables you to install the memory module in the socket in only one orientation.

**CAUTION:** Do not apply pressure at the center of the memory module; apply pressure at both ends of the memory module evenly.

4. Press the memory module with your thumbs until the ejectors firmly click into place. When the memory module is properly seated in the socket, the levers on the memory module socket align with the levers on the other sockets that have memory modules installed.

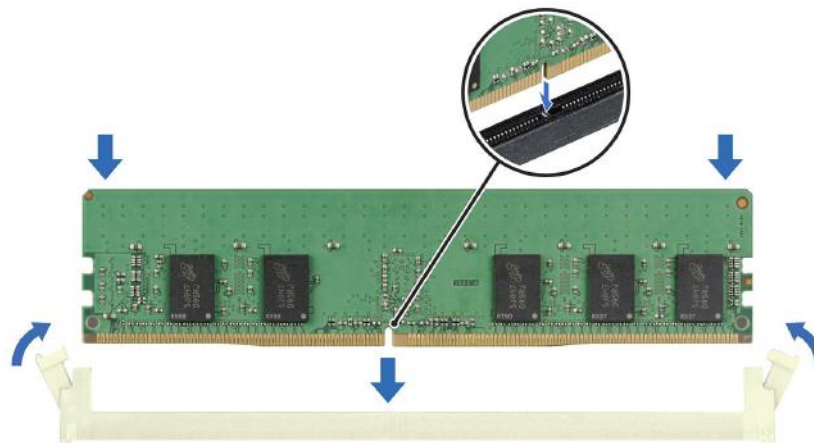

Figure 51. Installing a memory module

## Next steps

1. [Install the air shroud](#).
2. Follow the procedure listed in [After working inside your system](#) on page 26.

3. To verify if the memory module has been installed properly, press F2 and navigate to **System Setup Main Menu > System BIOS > Memory Settings**. In the **Memory Settings** screen, the System Memory Size must reflect the updated capacity of the installed memory.
4. If the System Memory Size is incorrect, one or more of the memory modules may not be installed properly. Ensure that the memory modules are firmly seated in their sockets.
5. Run the system memory test in system diagnostics.

## Processor and heat sink module

This is a service technician replaceable part only.

### Removing a processor and heat sink module

#### Prerequisites

1. Follow the safety guidelines listed in the [Safety instructions](#) on page 25.
2. Follow the procedure listed in the [Before working inside your system](#) on page 26.
3. [Remove the air shroud](#).
  - NOTE:** The heat sink and processor are hot to touch for some time after the system has been powered down. Allow the heat sink and processor to cool down before handling them.

#### Steps

1. Ensure all four anti-tilt wires are in the locked position (outward position), and then using a Torx T30 tool, loosen the captive nuts on the heat sink in the order that is mentioned below:
  - a. Loosen the first nut three turns.
  - b. Loosen the nut diagonally opposite to the nut you loosened first.
  - c. Repeat the procedure for the remaining two nuts.
  - d. Return to the first nut to loosen it completely.
2. Set the Anti-Tilt wires to the unlocked position (inward position).

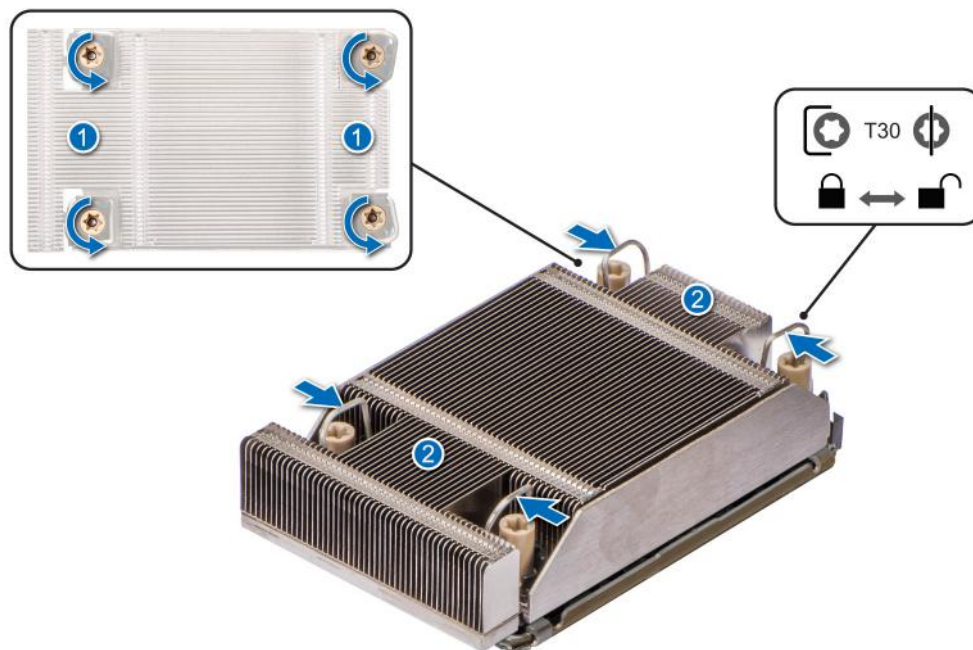

**Figure 52. Loosening the nuts and set the Anti-Tilt wires to the unlocked position**

3. Lift the processor and heat sink module (PHM) from the system and set the PHM aside with the processor side facing up.

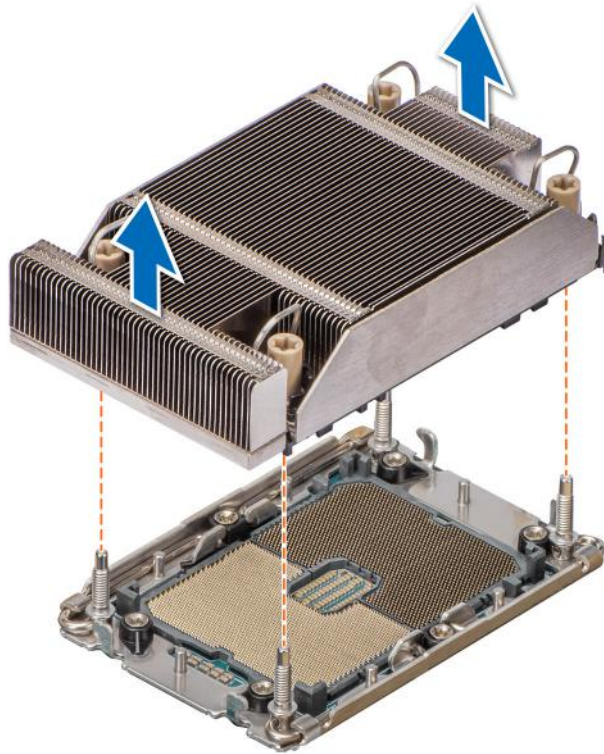

Figure 53. Removing a processor and heat sink module

#### Next steps

Remove the processor from the processor and heat sink module.

## Removing the processor from the processor and heat sink module

#### Prerequisites

**⚠ WARNING:** Remove the processor from the processor and heat sink module (PHM) only if you are replacing the processor or heat sink.

1. Follow the safety guidelines listed in the [Safety instructions](#) on page 25.
2. Follow the procedure listed in [Before working inside your system](#) on page 26.
3. [Remove the air shroud.](#)
4. [Remove the processor and heat sink module \(PHM\).](#)

**⚠ CAUTION:** An expected CMOS battery loss or CMOS checksum error message may be displayed during the first instance of powering on the system after replacing the processor or system board. To resolve this issue, go to [setup option to configure the system settings.](#)

#### Steps

1. Place the heat sink with the processor side facing up.
2. Using your thumb lift up the Thermal Interface Material (TIM) break lever to release the processor from the TIM and carrier.  
**i NOTE:** Ensure to hold the carrier to the heat sink as you lift the TIM break lever.
3. Holding the processor by its edges, lift the processor away from the carrier, and then place the processor connector side down on the processor tray. Ensure pin 1 marks are aligned.

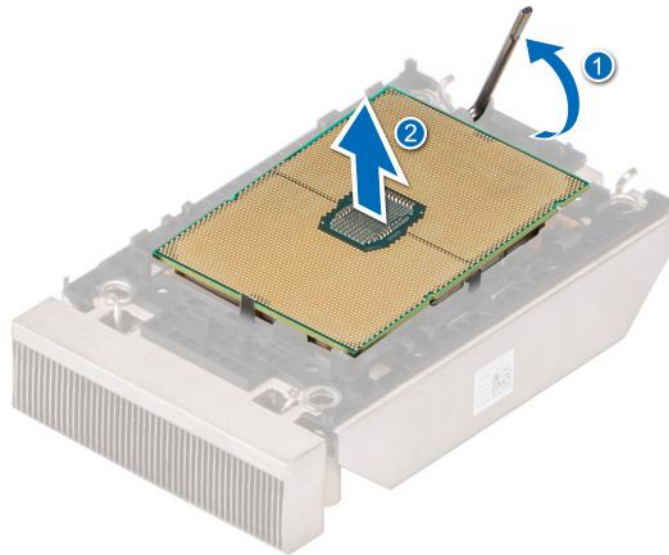

Figure 54. Lift the TIM break lever

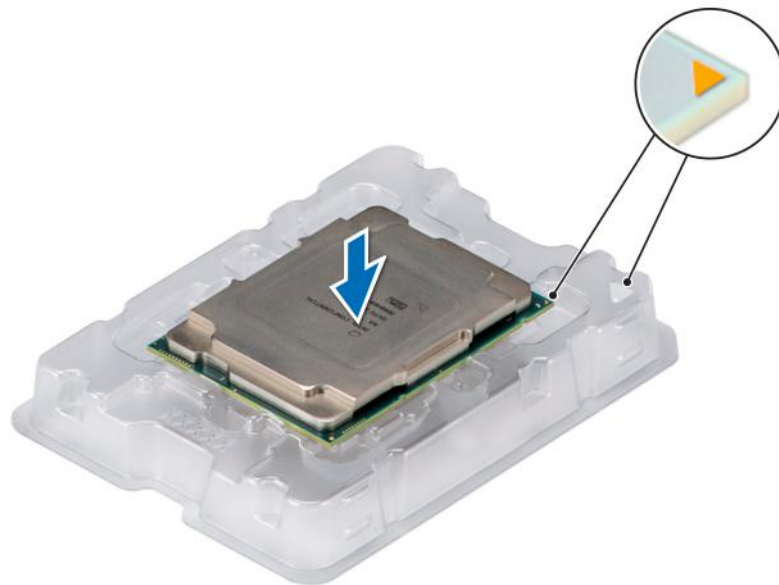

Figure 55. Aligning pin 1 marks of processor with tray

**NOTE:** Ensure that to return the TIM break lever back to its original position.

4. Using your thumb and index finger, first hold the carrier release tab at the pin 1 connector, pull out the tip of the carrier release tab, and then lift the carrier partially from the heat sink.
5. Repeat the procedure at the remaining three corners of the carrier.
6. After all the corners are released from the heat sink, lift the carrier from the pin 1 corner of the heat sink.



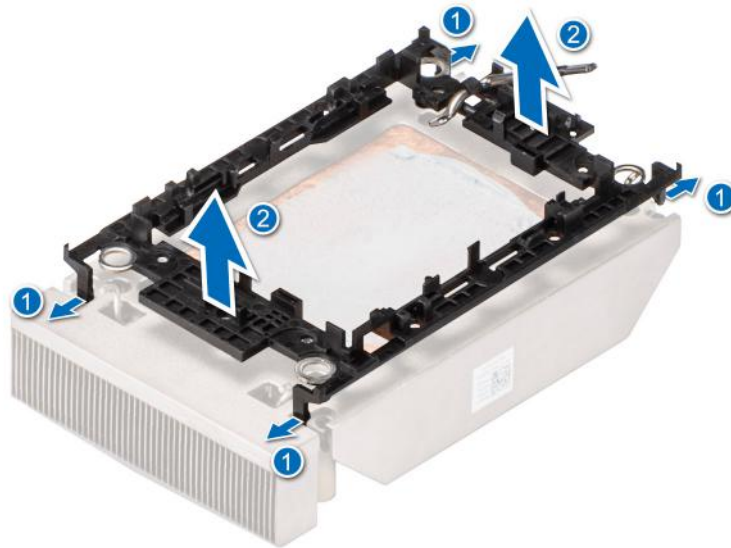

Figure 56. Removing the processor carrier

### Next steps

Replace the processor into a processor and heat sink module (PHM).

## Installing the processor into a processor and heat sink module

### Prerequisites

1. Follow the safety guidelines listed in the [Safety instructions](#) on page 25.
2. Follow the procedure listed in [Before working inside your system](#) on page 26.

### Steps

1. Place the processor in the processor tray.

**NOTE:** Ensure that the pin 1 indicator on the processor tray is aligned with the pin 1 indicator on the processor.

2. Place the processor carrier on top of the processor that is in the processor tray aligning pin 1 indicator on the processor.

**NOTE:** Ensure that the pin 1 indicator on the carrier is aligned with the pin 1 indicator on the processor before placing the carrier on the processor.

**NOTE:** Ensure that the processor and the carrier are placed in the tray before you install the heat sink.

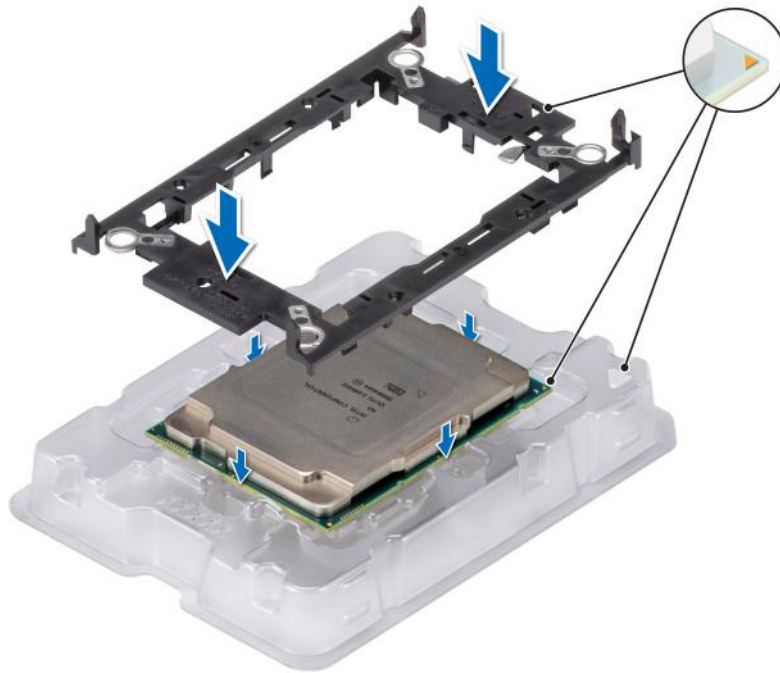

**Figure 57. Installing the processor carrier**

3. Align the processor with processor carrier by using your fingers to press the carrier on all the four sides until it clicks into place.

**NOTE:** Ensure that the processor is securely latched to the processor carrier.

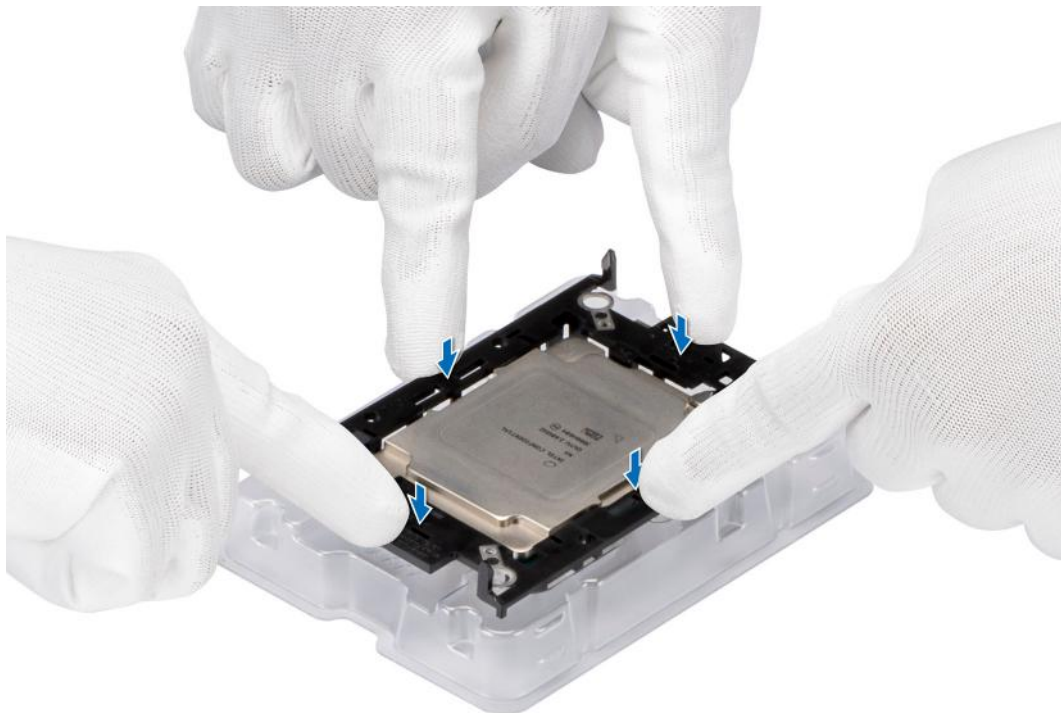

**Figure 58. Press the carrier on the four sides**

4. If you are using an existing heat sink, remove the thermal grease on the heat sink by using a clean lint-free cloth.
5. Use the thermal grease syringe included with your processor kit to apply the grease in a thin spiral on the bottom of the heat sink.



Figure 59. Applying thermal grease

**CAUTION:** Applying too much thermal grease can result in excess grease coming in contact with and contaminating the processor socket.

**NOTE:** The thermal grease syringe is intended for single use only. Dispose of the syringe after you use it.

6. For new heat sink, remove the Thermal Interface Material (TIM) protective film from the base of heat sink.

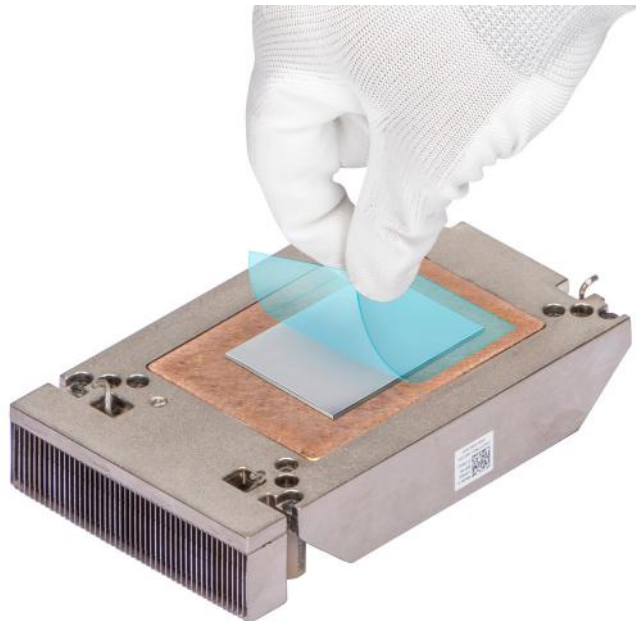

Figure 60. Remove the Thermal Interface Material (TIM) protective film

7. Place the heat sink on the processor and press the heat sink until the carrier locks onto the heat sink at all the four corners.

**CAUTION:** To avoid damaging the fins on the heat sink, do not press down on the heat sink fins.

**NOTE:** Ensure that the pin 1 indicator on the heat sink is aligned with the pin 1 indicator on the carrier before placing the heat sink onto the processor carrier.

**NOTE:** Ensure latching features on processor carrier and heat sink are aligned during assembly.

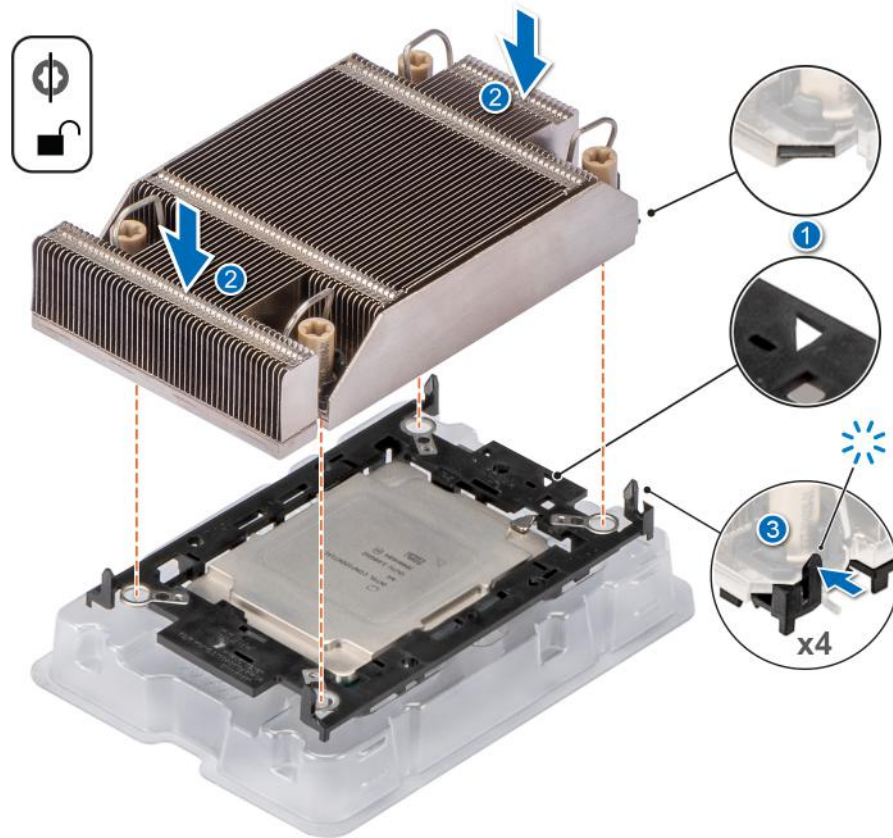

**Figure 61. Installing the heat sink onto the processor**

### Next steps

1. Install the processor and heat sink module.
2. Install the air shroud.
3. Follow the procedure listed in [After working inside your system](#) on page 26.

## Installing the processor and heat sink module

### Prerequisites

**CAUTION:** Never remove the heat sink from a processor unless you intend to replace the processor. The heat sink is necessary to maintain proper thermal conditions.

1. Follow the safety guidelines listed in the [Safety instructions](#) on page 25.
2. Follow the procedure listed in [Before working inside your system](#) on page 26.
3. [Remove the air shroud](#).
4. If installed, remove the processor dust cover.

### Steps

1. Set the Anti-Tilt wires to the unlocked position on the heat sink (inward position).
2. Align the pin 1 indicator of the heat sink to the system board, and then place the processor and heat sink on the processor socket.

**CAUTION:** To avoid damaging the fins on the heat sink, do not press down on the heat sink fins.

**NOTE:** Ensure that the processor and heat sink is held parallel to the system board to prevent damaging the components.

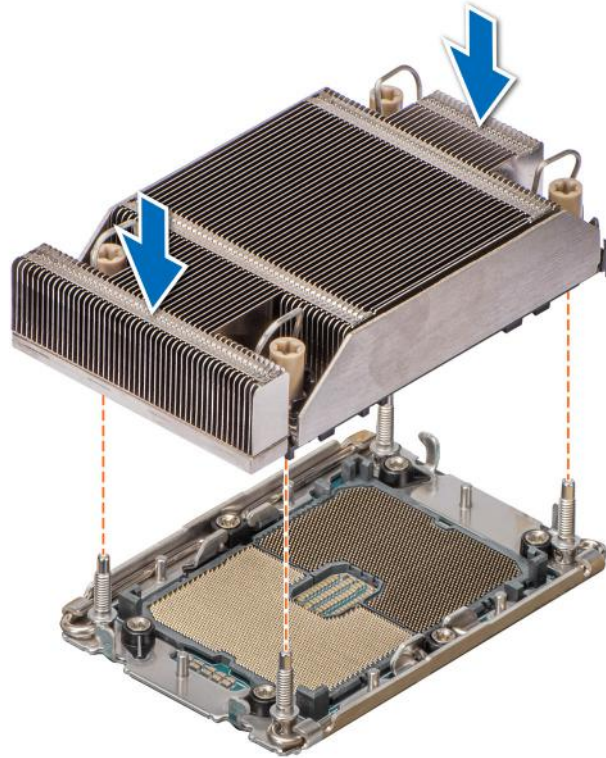

**Figure 62. Installing the processor and heat sink (PHM)**

3. Set the anti-tilt wires to the locked position (outward position), and then using the Torx T30 tool, tighten the captive nuts (8 in-lbf) on the heat sink in the order below:
  - a. In a random order, tighten the first nut three turns.
  - b. Tighten the nut diagonally opposite to the nut you tighten first.
  - c. Repeat the procedure for the remaining two nuts.
  - d. Return to the first nut to tighten it completely.
  - e. Check all the nuts to ensure they are firmly secured.

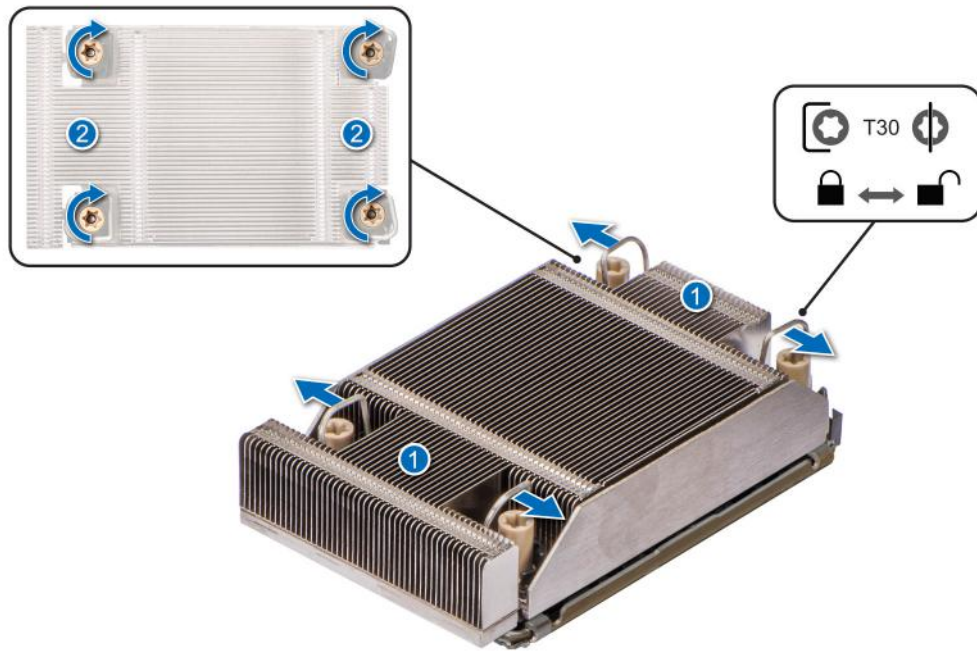

Figure 63. Set the anti-tilt wires to the locked position and tightening the captive nuts

#### Next steps

1. [Install the air shroud.](#)
2. Follow the procedure listed in [After working inside your system](#) on page 26.

## Expansion cards and expansion card risers

**NOTE:** A system event entry is logged in the iDRAC Lifecycle Controller if an expansion card riser is not supported or missing. It does not prevent your system from turning on. However, if a F1/F2 pause occurs with an error message, see *Troubleshooting expansion cards* section in the *Dell EMC PowerEdge Servers Troubleshooting Guide* at [www.dell.com/poweredgemanuals](http://www.dell.com/poweredgemanuals).

## Expansion card installation guidelines

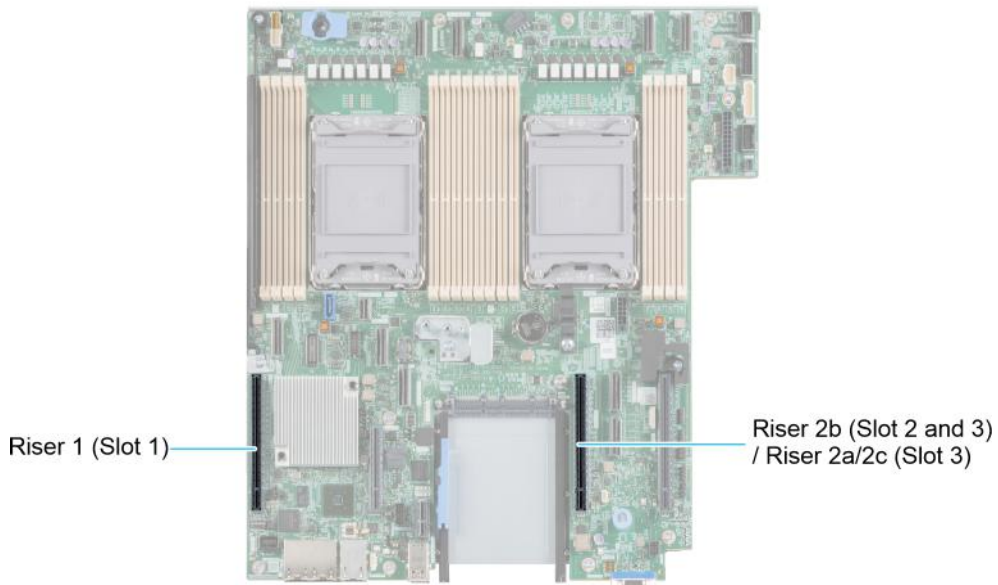

**Figure 64. Expansion card slot connectors**

The following table describes the expansion card riser configurations:

Configurations	Expansion card risers	PCIe Slots	Controlling processor	Height	Length	Slot width
Config0. with 1x LP	R1 + rear 2 drives	1	Processor 1	Low Profile	Half length	x16
Config1. with 3x LP	R1	1	Processor 1	Low Profile	Half length	x16
	R2a	2 and 3	Processor 2	Low Profile	Half length	x8 + x8
Config2. with 2x LP	R1	1	Processor 1	Low Profile	Half length	x16
	R2b (SNAPI)	3	Processor 1 and 2	Low Profile	Half length	x16
Config3. with 2x LP	R1	1	Processor 1	Low Profile	Half length	x16
	R2c	3	Processor 2	Low Profile	Half length	x16
Config4. with 1x LP	R1	1	Processor 1	Low Profile	Half length	x16
Config5. with 0x LP	NA	NA	NA	NA	NA	NA
Config6. with 1x LP	R2c	3	Processor 2	Low Profile	Half length	x16

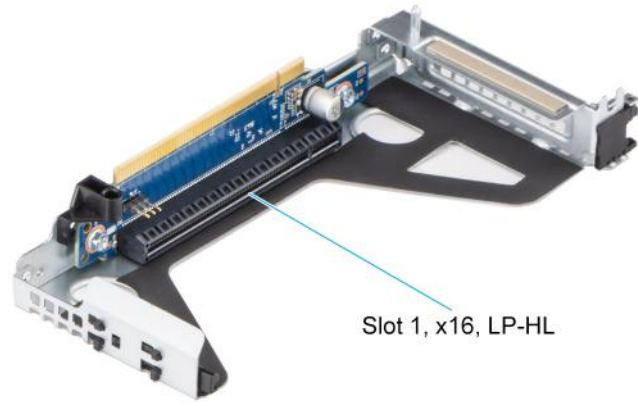

Slot 1, x16, LP-HL

Figure 65. Riser 1

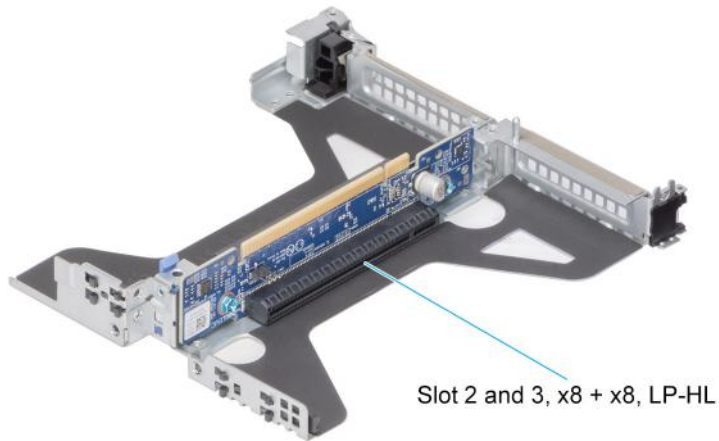

Slot 2 and 3, x8 + x8, LP-HL

Figure 66. Riser 2a



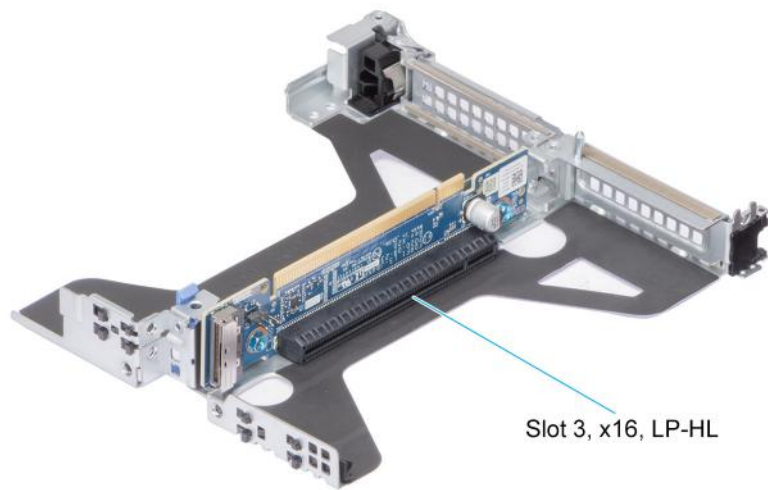

**Figure 67. Riser 2b (SNAPI)**

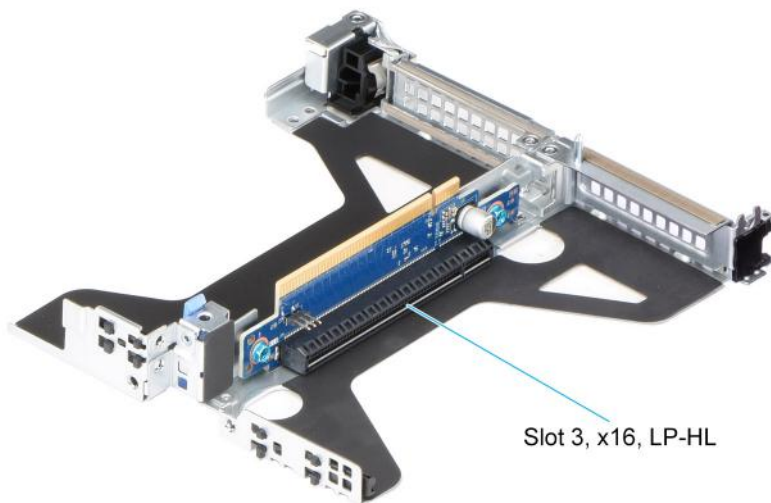

**Figure 68. Riser 2c**

**NOTE:** The expansion-card slots are not hot-swappable.

The following table provides guidelines for installing expansion cards to ensure proper cooling and mechanical fit. The expansion cards with the highest priority should be installed first using the slot priority indicated. All the other expansion cards should be installed in the card priority and slot priority order.

**Table 30. Configuration 0: R1**

Card type	Slot priority	Maximum number of cards
Dell Front PERC	Integrated slot	1
Dell Serial port module (LP)	1	1
Intel (NIC: 100Gb)	1	1
Mellanox (NIC: 100Gb)	1	1

**Table 30. Configuration 0: R1 (continued)**

Card type	Slot priority	Maximum number of cards
Broadcom (NIC: 25Gb)	1	1
Intel (NIC: 25Gb)	1	1
Mellanox (NIC: 25Gb)	1	1
Qlogic (NIC: 25Gb)	1	1
SolarFlare (NIC: 25Gb)	1	1
Broadcom (HBA: FC32)	1	1
Marvell (HBA: FC32)	1	1
Avago (HBA: FC16)	1	1
QLogic (HBA: FC16)	1	1
Broadcom (NIC: 10Gb)	1	1
Intel (NIC: 10Gb)	1	1
Qlogic (NIC: 10Gb)	1	1
Broadcom (NIC: 1Gb)	1	1
Intel (NIC: 1Gb)	1	1
Mellanox (NIC: HDR100 VPI)	1	1
Mellanox (NIC: HDR VPI)	1	1
Intel (OCP: 100Gb)	Integrated slot	1
Broadcom (OCP: 25Gb)	Integrated slot	1
Intel (OCP: 25Gb)	Integrated slot	1
Marvell (OCP: 25Gb)	Integrated slot	1
Mellanox (OCP: 25Gb)	Integrated slot	1
SolarFlare (OCP: 25Gb)	Integrated slot	1
Broadcom (OCP: 10Gb)	Integrated slot	1
Marvell (OCP: 10Gb)	Integrated slot	1
Intel (OCP: 10Gb)	Integrated slot	1
Broadcom (OCP: 1Gb)	Integrated slot	1
Intel (OCP: 1Gb)	Integrated slot	1
Dell External PERC Adapter	1	1
Dell BOSS S1 Module	Integrated slot	1
Intel (PCIe SSD AIC)	1	1
Samsung (PCIe SSD AIC)	1	1

**Table 31. Configuration 1: R1+R2a**

Card type	Slot priority	Maximum number of cards
Dell Front PERC	Integrated slot	1
Dell Serial port module (LP)	2, 1	1
Intel (NIC: 100Gb)	1	1
Mellanox (NIC: 100Gb)	1	1

**Table 31. Configuration 1: R1+R2a (continued)**

Card type	Slot priority	Maximum number of cards
Broadcom (NIC: 25Gb)	3, 1, 2	3
Intel (NIC: 25Gb)	3, 1, 2	3
Mellanox (NIC: 25Gb)	1	1
Qlogic (NIC: 25Gb)	3, 1, 2	3
SolarFlare (NIC: 25Gb)	3, 1, 2	3
Broadcom (HBA: FC32)	3, 1, 2	3
Marvell (HBA: FC32)	3, 1, 2	3
Avago (HBA: FC16)	3, 1, 2	3
QLogic (HBA: FC16)	3, 1, 2	3
Broadcom (NIC: 10Gb)	3, 1, 2	3
Intel (NIC: 10Gb)	3, 1, 2	3
Qlogic (NIC: 10Gb)	3, 1, 2	3
Broadcom (NIC: 1Gb)	3, 1, 2	3
Intel (NIC: 1Gb)	3, 1, 2	3
Mellanox (NIC: HDR100 VPI)	1	1
Mellanox (NIC: HDR VPI)	1	1
Intel (OCP: 100Gb)	Integrated slot	1
Broadcom (OCP: 25Gb)	Integrated slot	1
Intel (OCP: 25Gb)	Integrated slot	1
Marvell (OCP: 25Gb)	Integrated slot	1
Mellanox (OCP: 25Gb)	Integrated slot	1
SolarFlare (OCP: 25Gb)	Integrated slot	1
Broadcom (OCP: 10Gb)	Integrated slot	1
Marvell (OCP: 10Gb)	Integrated slot	1
Intel (OCP: 10Gb)	Integrated slot	1
Broadcom (OCP: 1Gb)	Integrated slot	1
Intel (OCP: 1Gb)	Integrated slot	1
Dell External PERC Adapter	3, 1, 2	3
Dell BOSS S1 Module	Integrated slot	1
Intel (PCIe SSD AIC)	3, 1, 2	3
Samsung (PCIe SSD AIC)	3, 1, 2	3

**Table 32. Configuration 2: R1+R2b**

Card type	Slot priority	Maximum number of cards
Dell Front PERC	Integrated slot	1
Dell Serial port module (LP)	2	1
Intel (NIC: 100Gb)	1	1
Mellanox (NIC: 100Gb)	3, 1	2

**Table 32. Configuration 2: R1+R2b (continued)**

Card type	Slot priority	Maximum number of cards
Mellanox (NIC: 100Gb) - CSP	1	1
Broadcom (NIC: 25Gb)	1	1
Intel (NIC: 25Gb)	1	1
Mellanox (NIC: 25Gb)	3, 1	2
Mellanox (NIC: 25Gb) - CSP	1	1
Qlogic (NIC: 25Gb)	1	1
SolarFlare (NIC: 25Gb)	1	1
Broadcom (HBA: FC32)	1	1
Marvell (HBA: FC32)	1	1
Avago (HBA: FC16)	1	1
QLogic (HBA: FC16)	1	1
Broadcom (NIC: 10Gb)	1	1
Intel (NIC: 10Gb)	1	1
Qlogic (NIC: 10Gb)	1	1
Broadcom (NIC: 1Gb)	1	1
Intel (NIC: 1Gb)	1	1
Mellanox (NIC: HDR100 VPI)	3, 1	2
Mellanox (NIC: HDR VPI)	3, 1	2
Intel (OCP: 100Gb)	Integrated slot	1
Broadcom (OCP: 25Gb)	Integrated slot	1
Intel (OCP: 25Gb)	Integrated slot	1
Marvell (OCP: 25Gb)	Integrated slot	1
Mellanox (OCP: 25Gb)	Integrated slot	1
SolarFlare (OCP: 25Gb)	Integrated slot	1
Broadcom (OCP: 10Gb)	Integrated slot	1
Marvell (OCP: 10Gb)	Integrated slot	1
Intel (OCP: 10Gb)	Integrated slot	1
Broadcom (OCP: 1Gb)	Integrated slot	1
Intel (OCP: 1Gb)	Integrated slot	1
Dell External PERC Adapter	1	1
Dell BOSS S1 Module	Integrated slot	1
Intel (PCIe SSD AIC)	1	1
Samsung (PCIe SSD AIC)	1	1

**Table 33. Configuration 3: R1+R2c**

Card type	Slot priority	Maximum number of cards
Dell Front PERC	Integrated slot	1
Dell Serial port module (LP)	2	1

**Table 33. Configuration 3: R1+R2c (continued)**

Card type	Slot priority	Maximum number of cards
Intel (NIC: 100Gb)	3, 1	2
Mellanox (NIC: 100Gb)	3, 1	2
Broadcom (NIC: 25Gb)	3, 1	2
Intel (NIC: 25Gb)	3, 1	2
Mellanox (NIC: 25Gb)	3, 1	2
Qlogic (NIC: 25Gb)	3, 1	2
SolarFlare (NIC: 25Gb)	3, 1	2
Broadcom (HBA: FC32)	3, 1	2
Marvell (HBA: FC32)	3, 1	2
Avago (HBA: FC16)	3, 1	2
QLogic (HBA: FC16)	3, 1	2
Broadcom (NIC: 10Gb)	3, 1	2
Intel (NIC: 10Gb)	3, 1	2
Qlogic (NIC: 10Gb)	3, 1	2
Broadcom (NIC: 1Gb)	3, 1	2
Intel (NIC: 1Gb)	3, 1	2
Mellanox (NIC: HDR100 VPI)	3, 1	2
Mellanox (NIC: HDR VPI)	3, 1	2
Intel (OCP: 100Gb)	Integrated slot	1
Broadcom (OCP: 25Gb)	Integrated slot	1
Intel (OCP: 25Gb)	Integrated slot	1
Marvell (OCP: 25Gb)	Integrated slot	1
Mellanox (OCP: 25Gb)	Integrated slot	1
SolarFlare (OCP: 25Gb)	Integrated slot	1
Broadcom (OCP: 10Gb)	Integrated slot	1
Marvell (OCP: 10Gb)	Integrated slot	1
Intel (OCP: 10Gb)	Integrated slot	1
Broadcom (OCP: 1Gb)	Integrated slot	1
Intel (OCP: 1Gb)	Integrated slot	1
Dell External PERC Adapter	3, 1	2
Dell BOSS S1 Module	Integrated slot	1
Intel (PCIe SSD AIC)	3, 1	2
Samsung (PCIe SSD AIC)	3, 1	2

**Table 34. Configuration 4: R1**

Card type	Slot priority	Maximum number of cards
Dell Front PERC	Integrated slot	1
Dell Serial port module (LP)	1	1

**Table 34. Configuration 4: R1 (continued)**

Card type	Slot priority	Maximum number of cards
Intel (NIC: 100Gb)	1	1
Mellanox (NIC: 100Gb)	1	1
Broadcom (NIC: 25Gb)	1	1
Intel (NIC: 25Gb)	1	1
Mellanox (NIC: 25Gb)	1	1
Qlogic (NIC: 25Gb)	1	1
SolarFlare (NIC: 25Gb)	1	1
Broadcom (HBA: FC32)	1	1
Marvell (HBA: FC32)	1	1
Avago (HBA: FC16)	1	1
QLogic (HBA: FC16)	1	1
Broadcom (NIC: 10Gb)	1	1
Intel (NIC: 10Gb)	1	1
Qlogic (NIC: 10Gb)	1	1
Broadcom (NIC: 1Gb)	1	1
Intel (NIC: 1Gb)	1	1
Mellanox (NIC: HDR100 VPI)	1	1
Mellanox (NIC: HDR VPI)	1	1
Intel (OCP: 100Gb)	Integrated slot	1
Broadcom (OCP: 25Gb)	Integrated slot	1
Intel (OCP: 25Gb)	Integrated slot	1
Marvell (OCP: 25Gb)	Integrated slot	1
Mellanox (OCP: 25Gb)	Integrated slot	1
SolarFlare (OCP: 25Gb)	Integrated slot	1
Broadcom (OCP: 10Gb)	Integrated slot	1
Marvell (OCP: 10Gb)	Integrated slot	1
Intel (OCP: 10Gb)	Integrated slot	1
Broadcom (OCP: 1Gb)	Integrated slot	1
Intel (OCP: 1Gb)	Integrated slot	1
Dell External PERC Adapter	1	1
Dell BOSS S1 Module	Integrated slot	1
Intel (PCIe SSD AIC)	1	1
Samsung (PCIe SSD AIC)	1	1

**Table 35. Configuration 5: No Riser**

Card type	Slot priority	Maximum number of cards
Intel (OCP: 100Gb)	Integrated slot	1
Broadcom (OCP: 25Gb)	Integrated slot	1

**Table 35. Configuration 5: No Riser (continued)**

Card type	Slot priority	Maximum number of cards
Intel (OCP: 25Gb)	Integrated slot	1
Marvell (OCP: 25Gb)	Integrated slot	1
Mellanox (OCP: 25Gb)	Integrated slot	1
SolarFlare (OCP: 25Gb)	Integrated slot	1
Broadcom (OCP: 10Gb)	Integrated slot	1
Intel (OCP: 10Gb)	Integrated slot	1
Marvell (OCP: 10Gb)	Integrated slot	1
Broadcom (OCP: 1Gb)	Integrated slot	1
Intel (OCP: 1Gb)	Integrated slot	1
Dell BOSS S1 Module	Integrated slot	1

**Table 36. Configuration 6: R2c**

Card type	Slot priority	Maximum number of cards
Dell Front PERC	Integrated slot	1
Dell Serial port module (LP)	2	1
Intel (NIC: 100Gb)	3	1
Mellanox (NIC: 100Gb)	3	1
Broadcom (NIC: 25Gb)	3	1
Intel (NIC: 25Gb)	3	1
Mellanox (NIC: 25Gb)	3	1
Qlogic (NIC: 25Gb)	3	1
SolarFlare (NIC: 25Gb)	3	1
Broadcom (HBA: FC32)	3	1
Marvell (HBA: FC32)	3	1
Avago (HBA: FC16)	3	1
QLogic (HBA: FC16)	3	1
Broadcom (NIC: 10Gb)	3	1
Intel (NIC: 10Gb)	3	1
Qlogic (NIC: 10Gb)	3	1
Broadcom (NIC: 1Gb)	3	1
Intel (NIC: 1Gb)	3	1
Mellanox (NIC: HDR100 VPI)	3	1
Mellanox (NIC: HDR VPI)	3	1
Intel (OCP: 100Gb)	Integrated slot	1
Broadcom (OCP: 25Gb)	Integrated slot	1
Intel (OCP: 25Gb)	Integrated slot	1
Marvell (OCP: 25Gb)	Integrated slot	1
Mellanox (OCP: 25Gb)	Integrated slot	1

**Table 36. Configuration 6: R2c (continued)**

Card type	Slot priority	Maximum number of cards
SolarFlare (OCP: 25Gb)	Integrated slot	1
Broadcom (OCP: 10Gb)	Integrated slot	1
Marvell (OCP: 10Gb)	Integrated slot	1
Intel (OCP: 10Gb)	Integrated slot	1
Broadcom (OCP: 1Gb)	Integrated slot	1
Intel (OCP: 1Gb)	Integrated slot	1
Dell External PERC Adapter	3	1
Dell BOSS S1 Module	Integrated slot	1
Intel (PCIe SSD AIC)	3	1
Samsung (PCIe SSD AIC)	3	1

## Removing the expansion card risers

### Prerequisites

1. Follow the safety guidelines listed in the [Safety instructions](#) on page 25.
2. Follow the procedure listed in the [Before working inside your system](#) on page 26.
3. [Remove the air shroud](#).

### Steps

1. For Riser 1, hold the blue touch points, and lift the expansion card riser from the riser connector on the system board.

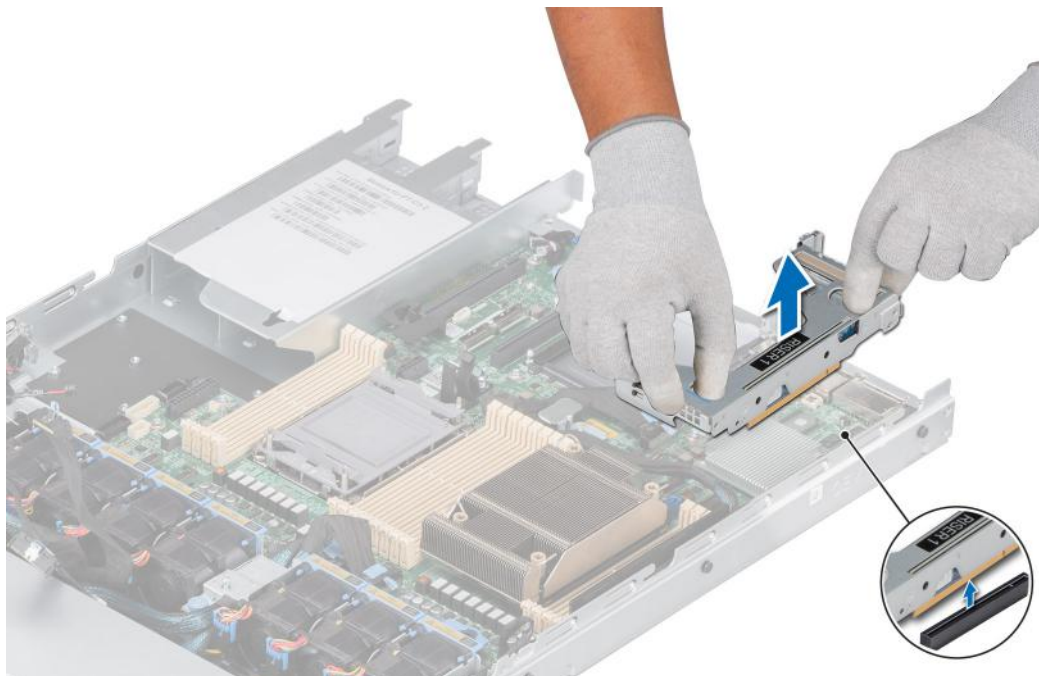

**Figure 69. Removing the Riser 1**

2. For Riser 2a, release the blue latch and hold the blue touch points, and lift the expansion card riser from the riser connector on the system board.





**Figure 70. Removing the Riser 2a**

3. For Riser 2b, first disconnect the cable from system board, then release the blue latch, and then holding the blue touch points, lift the expansion card riser from the riser connector on the system board.

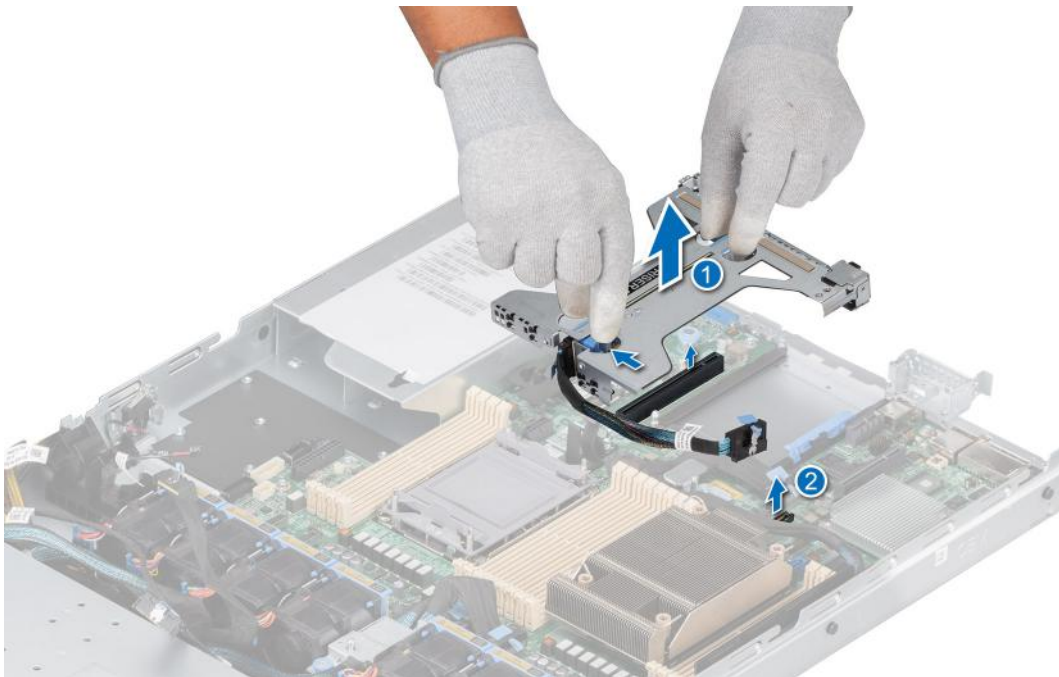

**Figure 71. Removing the Riser 2b with SNAPI module**

4. For Riser 2c, release the blue latch and hold the blue touch points, and lift the expansion card riser from the riser connector on the system board.



**Figure 72. Removing the Riser 2c**

### **Next steps**

Replace the expansion card riser.

## **Installing the expansion card risers**

### **Prerequisites**

1. Follow the safety guidelines listed in the [Safety instructions](#) on page 25.
2. Follow the procedure listed in the [Before working inside your system](#) on page 26.
3. [Remove the air shroud](#).
4. If removed, install the expansion cards into the expansion card risers.

### **Steps**

1. For Riser 1, release the blue latch and holding the touch points, align the expansion card riser with the connector and the riser guide pin on the system board. Lower the expansion card riser into place until the expansion card riser connector is fully seated in the connector.

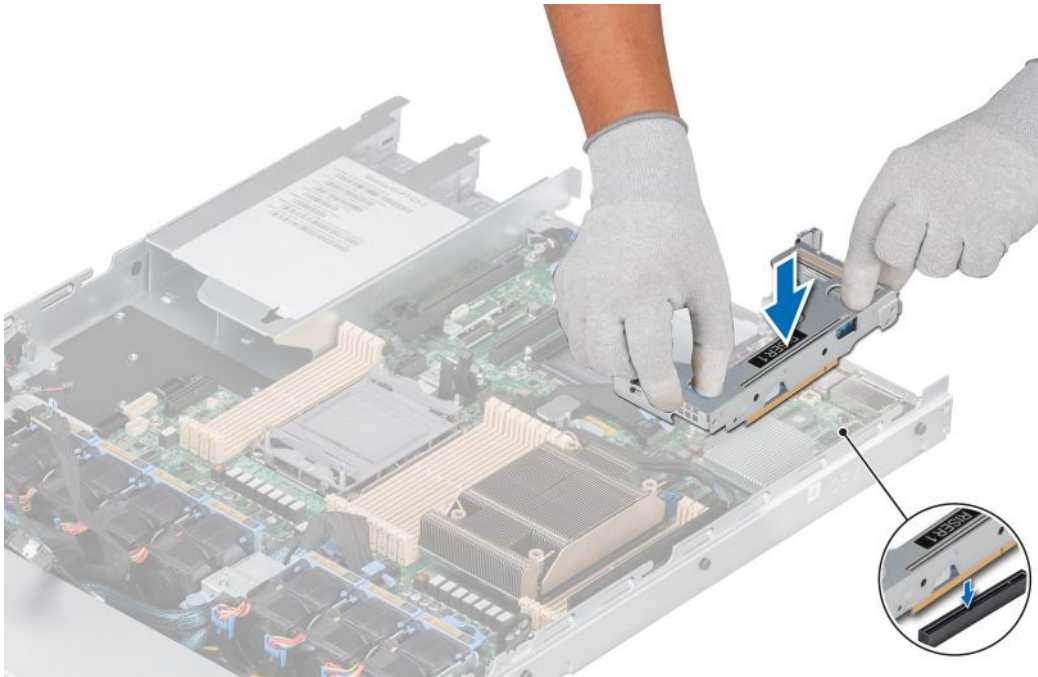

**Figure 73. Installing the Riser 1**

2. For Riser 2a, release the blue latch and holding the touch points, align the expansion card riser with the connector and the riser guide pin on the system board. Lower the expansion card riser into place until the expansion card riser connector is fully seated in the connector.



**Figure 74. Installing the Riser 2a**

3. For Riser 2b, re-connect the cable from the system board, then release the blue latch and holding the touch points, align the expansion card riser with the connector and the riser guide pin on the system board. Lower the expansion card riser into place until the expansion card riser connector is fully seated in the connector.

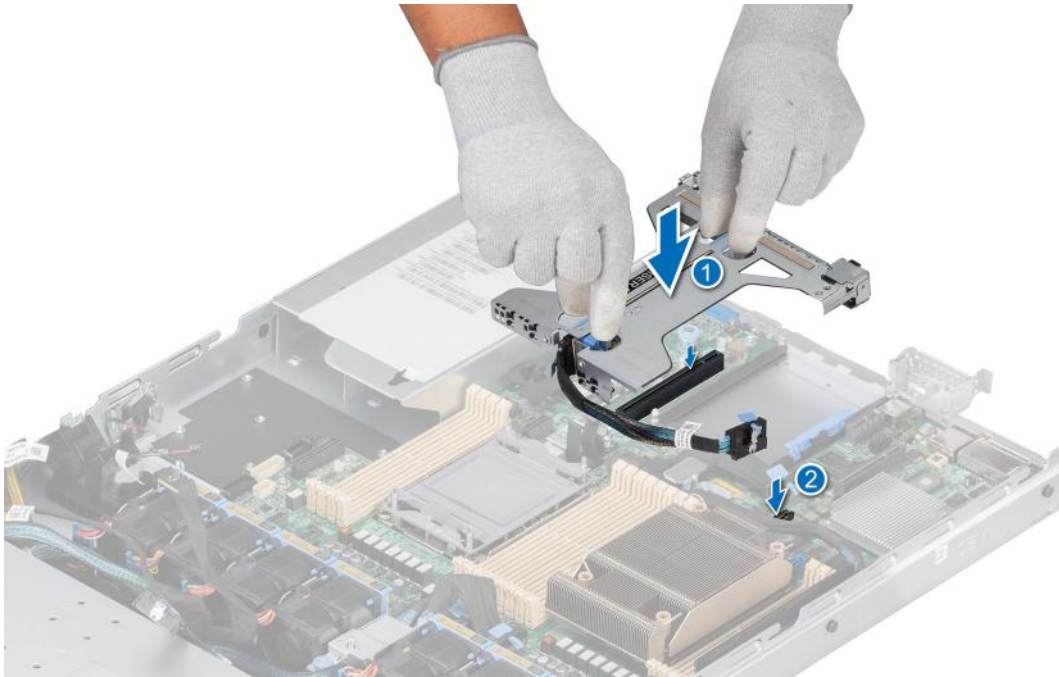

**Figure 75. Installing the Riser 2b with SNAPI module**

4. For Riser 2c, release the blue latch and holding the touch points, align the expansion card riser with the connector and the riser guide pin on the system board. Lower the expansion card riser into place until the expansion card riser connector is fully seated in the connector.



**Figure 76. Installing the Riser 2c**

### **Next steps**

1. [Install the air shroud.](#)
2. Follow the procedure listed in [After working inside your system](#) on page 26.
3. Install any device drivers required for the card as described in the documentation for the card.

## Removing expansion card from the expansion card riser

### Prerequisites

1. Follow the safety guidelines listed in the [Safety instructions](#) on page 25.
2. Follow the procedure listed in [Before working inside your system](#) on page 26.
3. [Remove the air shroud](#).
4. [Remove the expansion card risers](#).

### Steps

1. Pull and lift up the expansion card retention latch lock to open.
2. Hold the expansion card by its edges and pull the card until the card edge connector disengages from the expansion card connector on the riser.



Figure 77. Removing an expansion card from the Riser 1

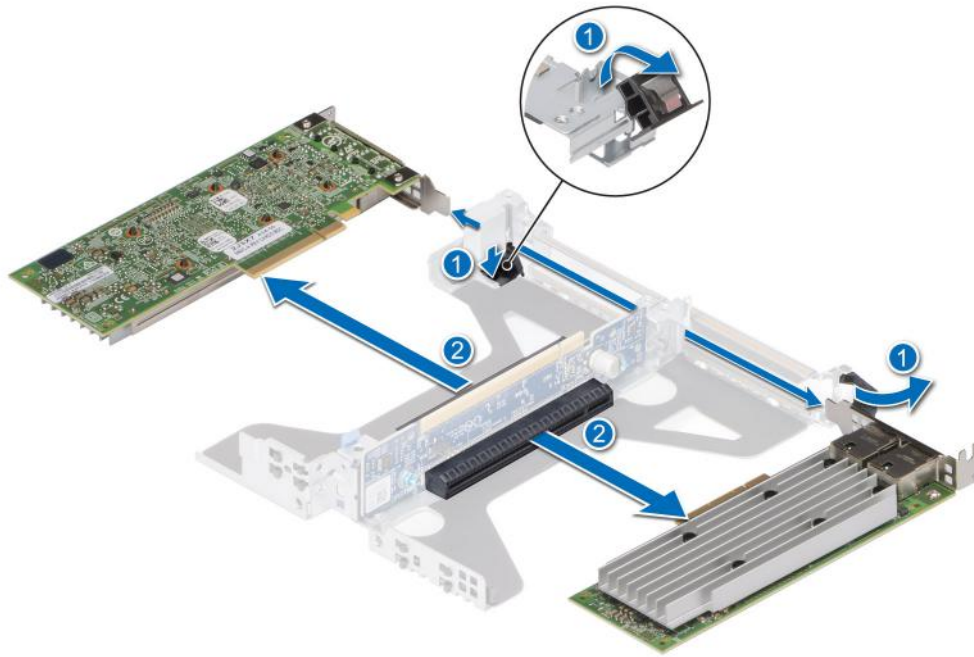

Figure 78. Removing an expansion card from Riser 2a

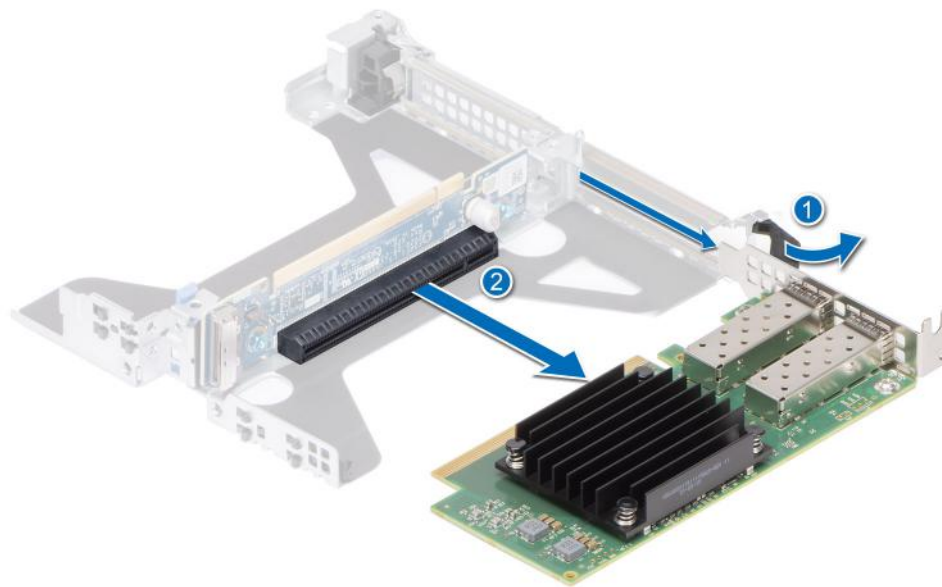
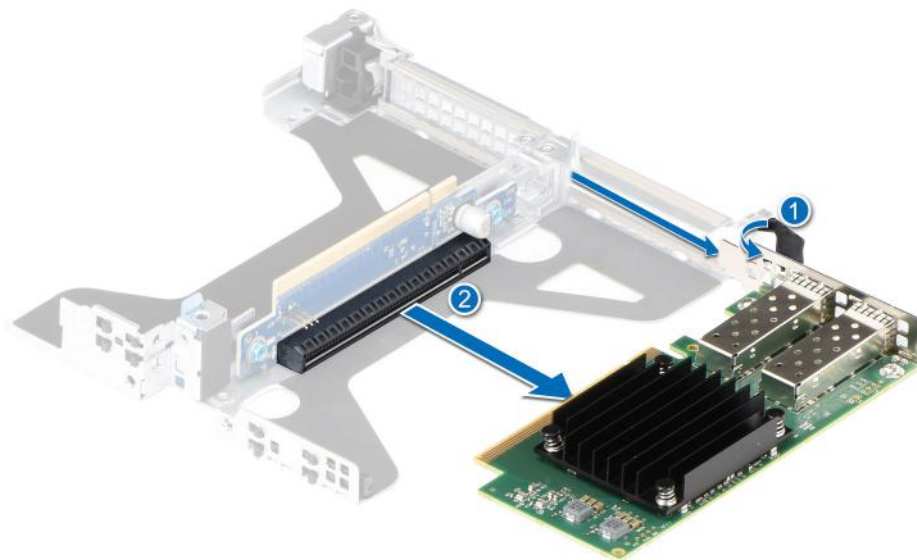

Figure 79. Removing an expansion card from Riser 2b (SNAPI)

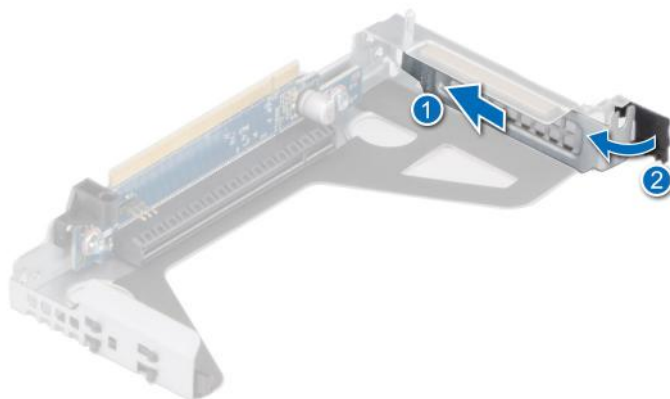

**Figure 80. Removing an expansion card from Riser 2c**

3. If the expansion card is not going to be replaced, install a filler bracket and close the card retention latch.

**i** **NOTE:** You must install a filler bracket over an empty expansion card slot to maintain Federal Communications Commission (FCC) certification of the system. The brackets also keep dust and dirt out of the system and aid in proper cooling and airflow inside the system.

**i** **NOTE:** The numbers on the image do not depict the exact steps. The numbers are for representation of sequence.



**Figure 81. Installing filler bracket in the Riser 1**

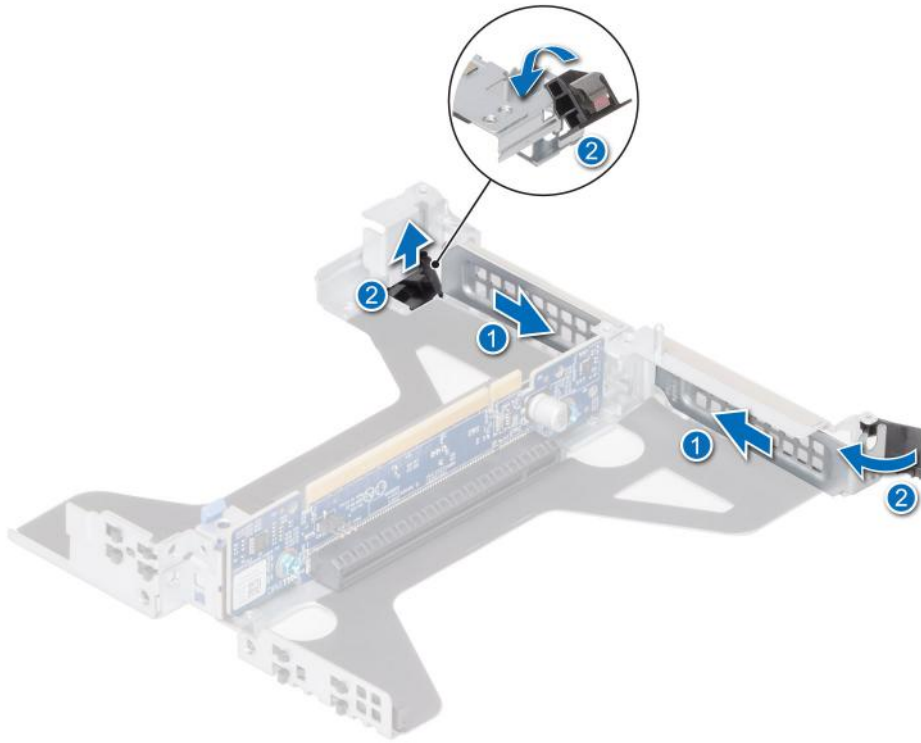

Figure 82. Installing filler bracket in the Riser 2a

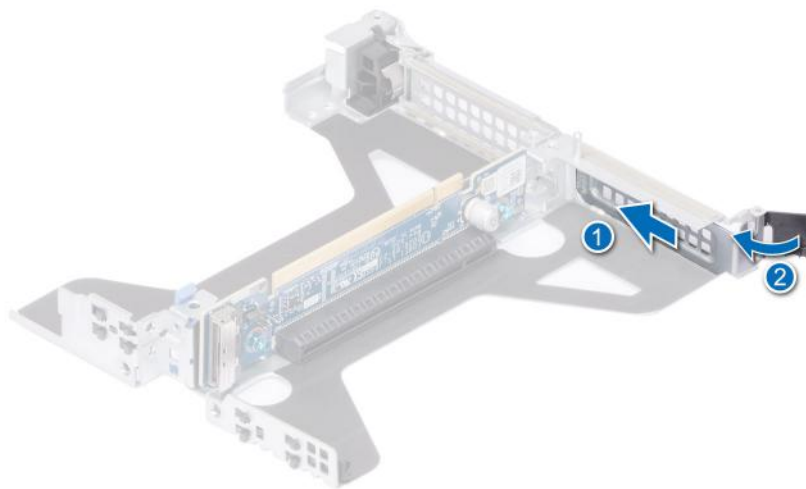
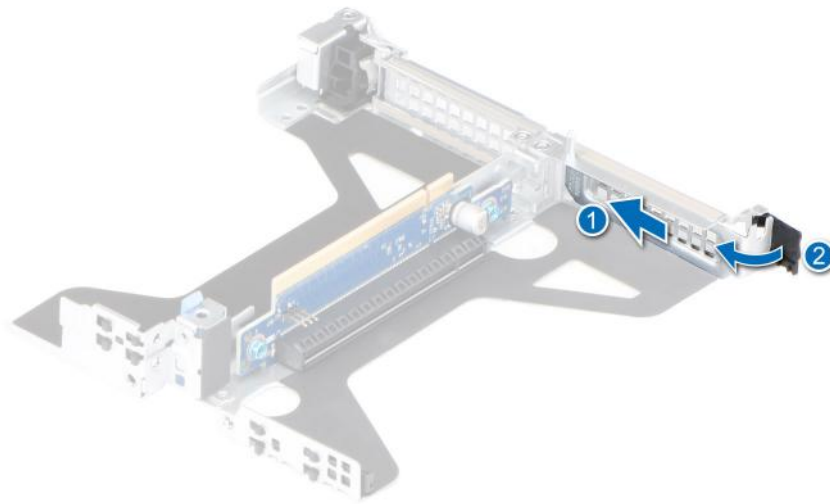

Figure 83. Installing filler bracket in the Riser 2b (SNAPI)





**Figure 84. Installing filler bracket in the Riser 2c**

### Next steps

If applicable, install an [expansion card into the expansion card riser](#).

## Installing an expansion card into the expansion card riser

### Prerequisites

1. Follow the safety guidelines listed in the [Safety instructions](#) on page 25.
2. Follow the procedure listed in [Before working inside your system](#) on page 26.
3. If installing a new expansion card, unpack it and prepare the card for installation.

**i NOTE:** For instructions, see the documentation accompanying the card.

### Steps

1. Pull and lift up the expansion card retention latch lock to open.
2. If installed, remove the filler bracket.

**i NOTE:** Store the filler bracket for future use. Filler brackets must be installed in empty expansion card slots to maintain Federal Communications Commission (FCC) certification of the system. The brackets also keep dust and dirt out of the system and aid in proper cooling and airflow inside the system.

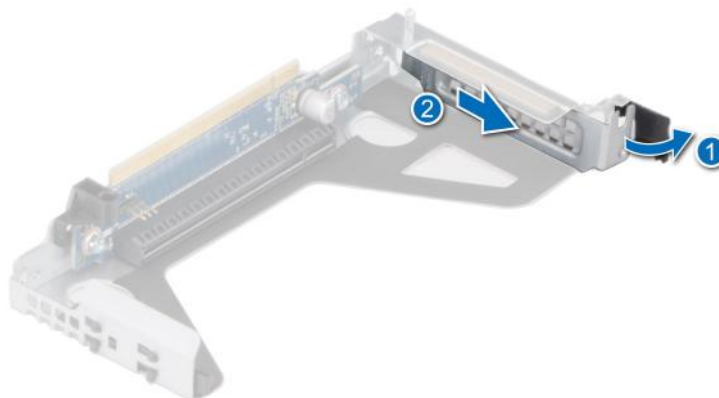

**Figure 85. Removing a filler bracket from Riser 1**

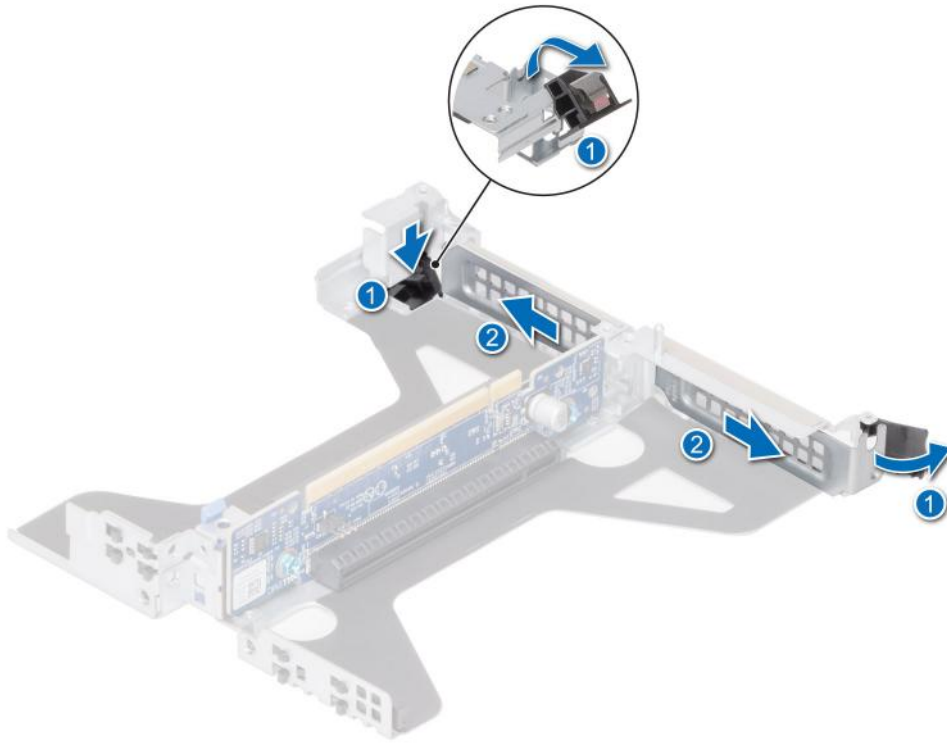

Figure 86. Removing filler bracket from Riser 2a

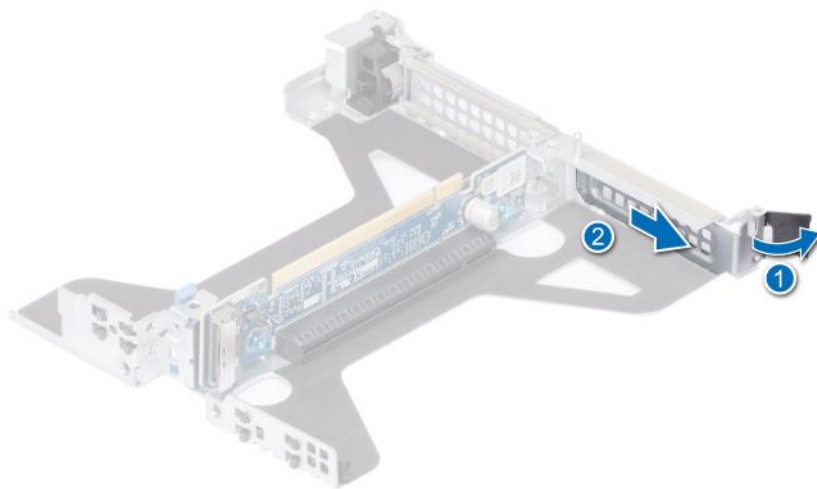
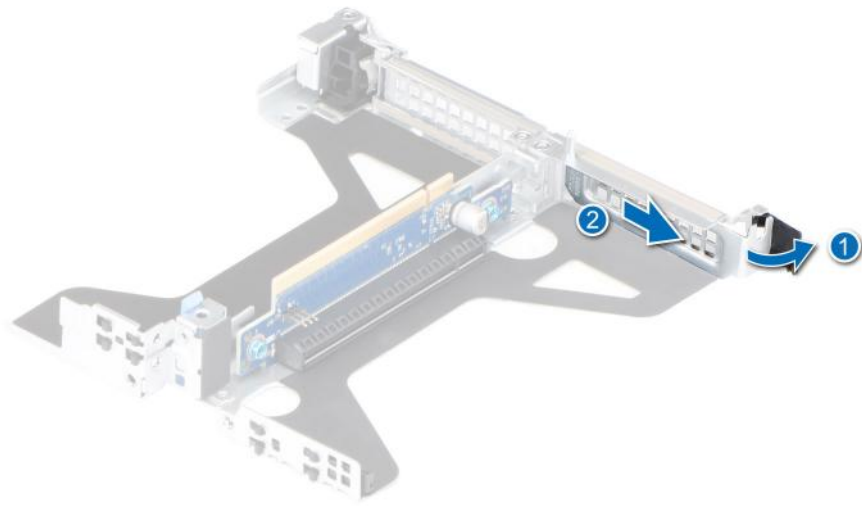

Figure 87. Removing filler bracket from Riser 2b (SNAPI)



**Figure 88. Removing filler bracket from Riser 2c**

3. Hold the card by the edges, and align the card edge connector with the expansion card connector on the riser.
4. Insert the card edge connector firmly into the expansion card connector until the card is fully seated.
5. Close the expansion card retention latch.

**NOTE:** The numbers on the image do not depict the exact steps. The numbers are for representation of sequence.



**Figure 89. Installing an expansion card into a Riser 1**

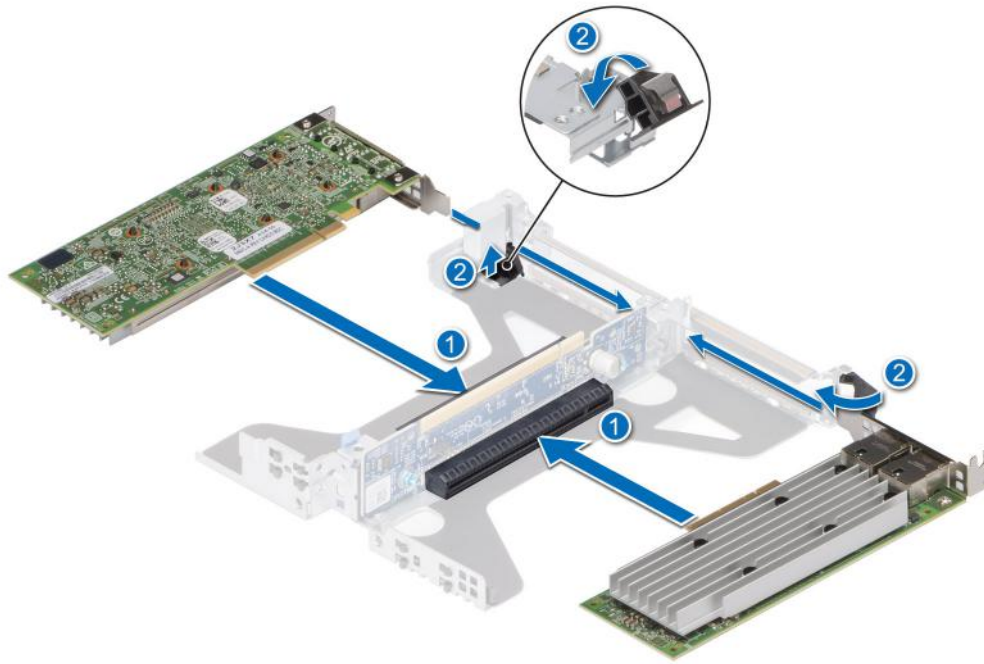

Figure 90. Installing an expansion card into a Riser 2a

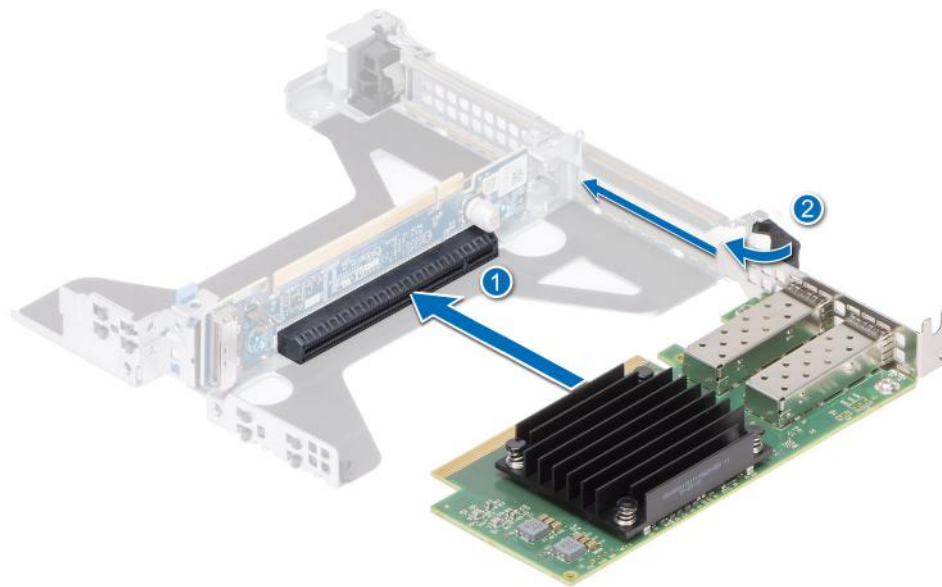
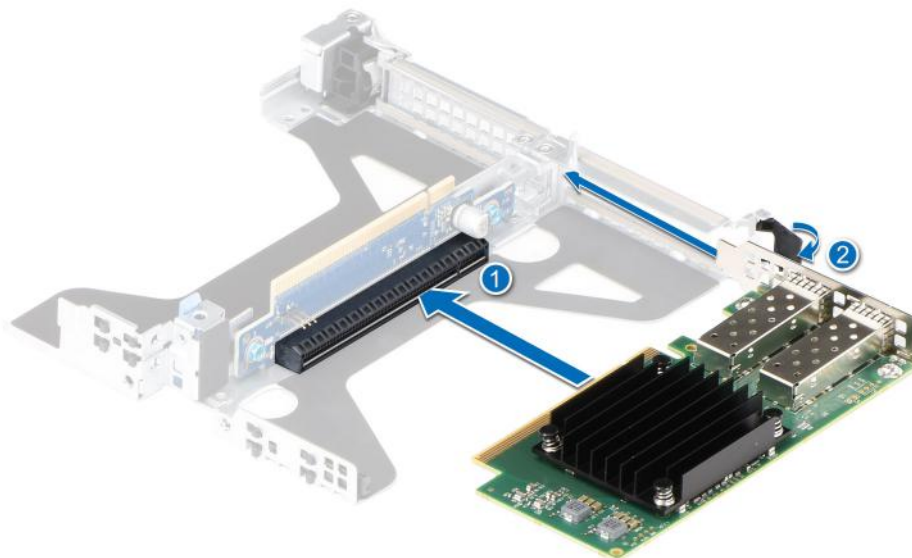

Figure 91. Installing an expansion card into a Riser 2b (SNAPI)



**Figure 92. Installing an expansion card into a Riser 2c**

### Next steps

1. If applicable, connect the cables to the expansion card.
2. [Install the air shroud.](#)
3. Follow the procedure listed in [After working inside your system](#) on page 26.
4. Install any device drivers required for the card as described in the documentation for the card.

**i NOTE:** While replacing faulty storage controller, FC, or NIC card with the same type of card, after you power on the system; the new card automatically updates to the same firmware and configuration of the faulty one. For more information about the Part replacement configuration, see the *Lifecycle Controller User's Guide* at <https://www.dell.com/idracmanuals>.

## Drive cage

This is a service technician replaceable part only.

## Removing the 2.5-inch rear drive cage

### Prerequisites

1. Follow the safety guidelines listed in [Safety instructions](#).
2. Follow the procedure listed in [Before working inside your system](#).
3. If required, [remove the air shroud](#).
4. [Remove the drives](#).
5. Disconnect the cables from the rear drive cage.

### Steps

1. Using a Phillips #2 screwdriver, loosen the blue thumbscrew that secures the rear drive cage to the system.
2. Slide the rear drive cage towards the front of the chassis and lift it away from the system.

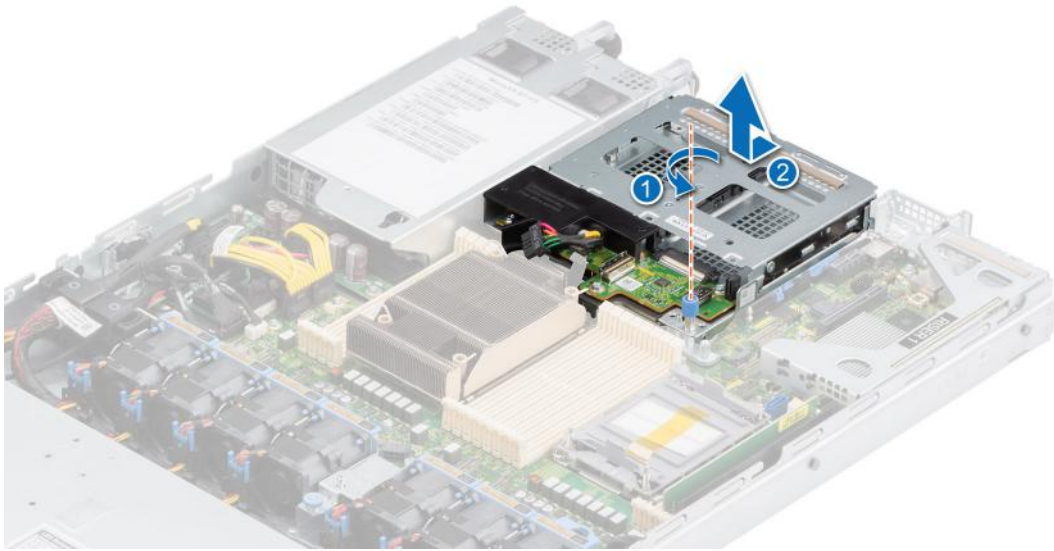

**Figure 93. Removing the 2.5-inch rear drive cage**

#### **Next steps**

Replace the 2.5-inch rear drive cage.

## **Installing the 2.5-inch rear drive cage**

#### **Prerequisites**

1. Follow the safety guidelines listed in [Safety instructions](#).
2. Follow the procedure listed in [Before working inside your system](#).
3. If required, [remove the air shroud](#).
4. [Remove the drives](#).
5. Disconnect the cables from the rear drive cage.

#### **Steps**

1. Align the slot on the rear drive cage with the guide on the system.
2. Slide the rear drive cage towards the rear of the chassis.
3. Using a Phillips #2 screwdriver, tighten the blue thumbscrew that secures the rear drive cage to the system.

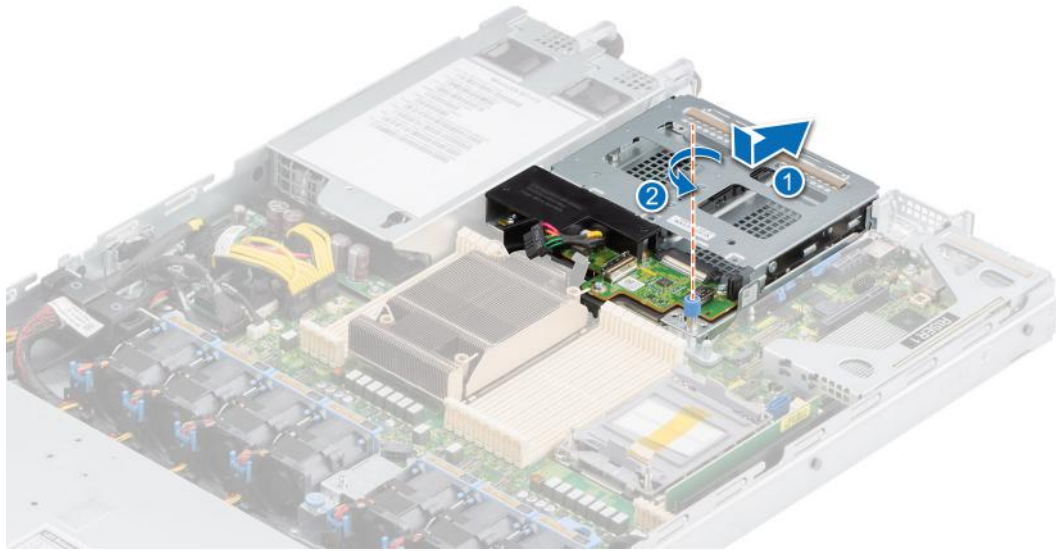

**Figure 94. Installing the 2.5-inch rear drive cage**

#### Next steps

1. Connect all the cables to the rear drive cage.
2. [Install the drives.](#)
3. If removed, [install the air shroud.](#)
4. Follow the procedure listed in [After working inside your system.](#)

## Optional serial COM port

This is a service technician replaceable part only.

## Removing the serial COM port

#### Prerequisites

1. Follow the safety guidelines listed in the [Safety instructions](#) on page 25.
2. Follow the procedure listed in [Before working inside your system](#) on page 26.
3. [Remove the air shroud.](#)

#### Steps

1. [Lift the expansion card riser](#) (Riser 1, Riser 2a, Riser 2b, Riser 2c) and disconnect the serial COM port cable from the connector on the system board.
2. Open the latch, slide the serial COM port out of the expansion card riser, and lock the latch .

**NOTE:** The numbers on the image do not depict the exact steps. The numbers are for representation of sequence.

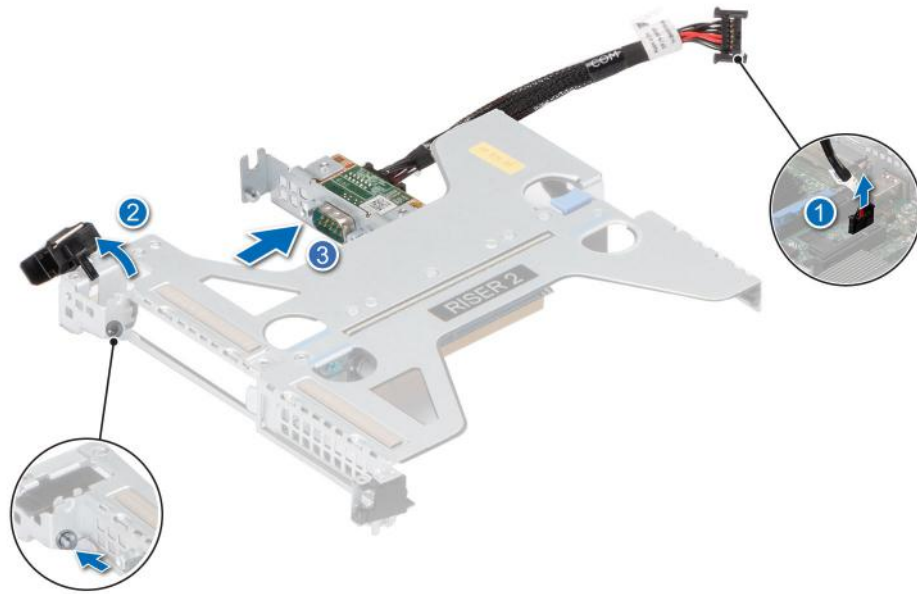

**Figure 95. Removing the Serial COM port**

3. Tighten the screws and install the PCIe blank on the expansion card riser.

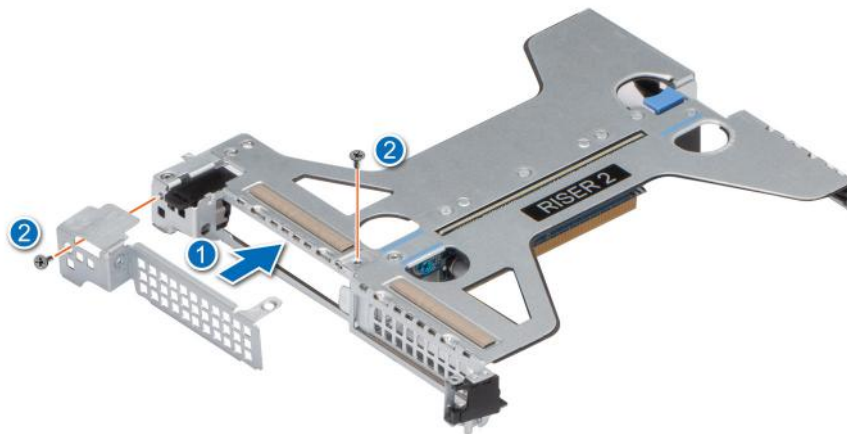

**Figure 96. Installing the PCIe blank**

### Next steps

Replace the serial COM port.

## Installing the serial COM port

### Prerequisites

1. Follow the safety guidelines listed in the [Safety instructions](#) on page 25.
2. Follow the procedure listed in [Before working inside your system](#) on page 26.
3. [Lift the expansion card riser](#) from the connector on the system board.



### Steps

1. Remove the screws, lift the PCIe blank, and then open the latch on the expansion card riser. (Riser 1, Riser 2c).

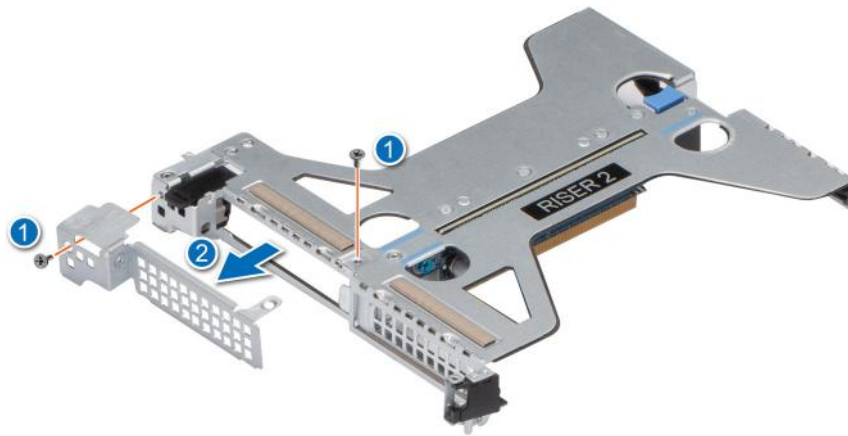

**Figure 97. Removing the PCIe blank**

2. Slide and lock the serial COM port into the expansion card riser.
3. Connect the serial COM port cable to the serial port.

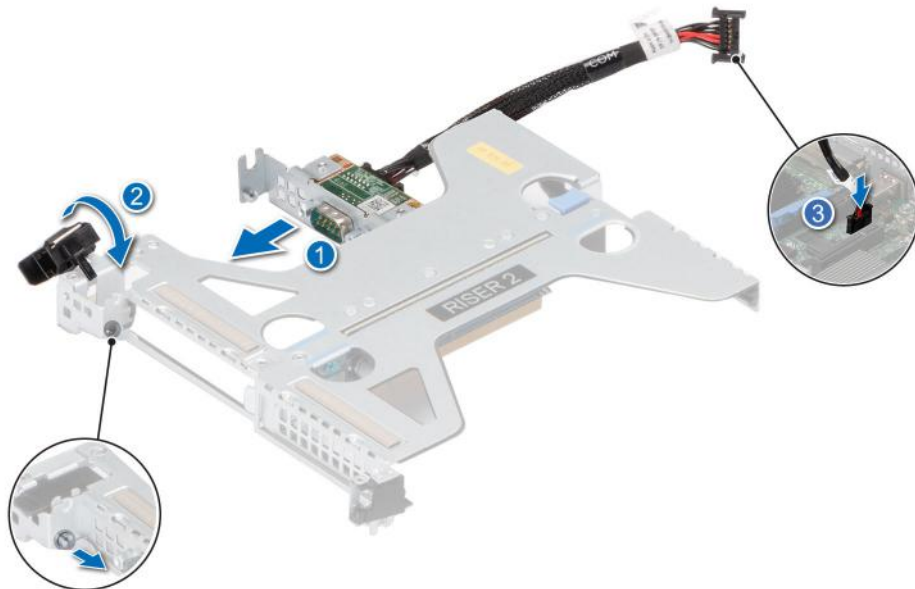

**Figure 98. Installing the Serial COM port**

### Next steps

1. [Install the expansion card riser.](#)
2. [Install the air shroud.](#)
3. Follow the procedure listed in [After working inside your system](#) on page 26.

# MicroSD card

## Removing the MicroSD card

### Prerequisites

1. Follow the safety guidelines listed in the [Safety instructions](#) on page 25.
2. Follow the procedure listed in [Before working inside your system](#) on page 26.
3. [Remove the air shroud](#).
4. [Remove the IDSDM module](#).

### Steps

1. Locate the MicroSD card slot on the IDSDM module, and press the card to partially release it from the slot. For more information on the slot location, see System board jumpers and connectors section.
2. Hold the MicroSD card and remove it from the slot..

 **NOTE:** Temporarily label each MicroSD card with its corresponding slot number after removal.

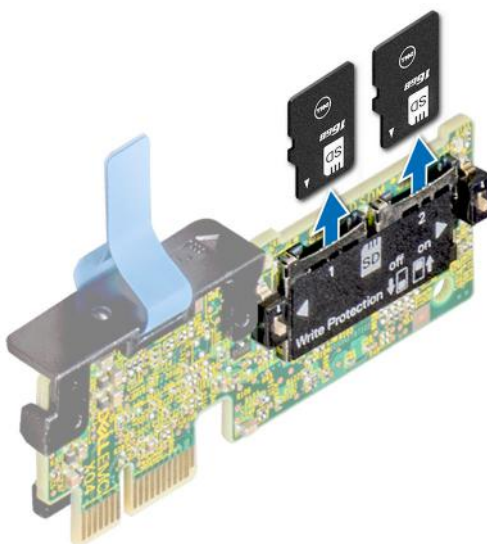

Figure 99. Removing the MicroSD card

### Next steps

[Install the MicroSD cards](#).

## Installing the MicroSD card

### Prerequisites

1. Follow the safety guidelines listed in the [Safety instructions](#) on page 25.
2. Follow the procedure listed in [Before working inside your system](#) on page 26.
3. [Remove the air shroud](#).

 **NOTE:** To use an MicroSD card with your system, ensure that the **Internal SD Card Port** is enabled in System Setup.

 **NOTE:** Ensure that you install the MicroSD cards into the same slots based on the labels you had marked on the cards during removal.

### Steps

1. Locate the MicroSD card slot on the IDSDM module. Orient the MicroSD card appropriately and insert the contact-pin end of the card into the slot. To locate IDSDM, see the System board jumpers and connectors section.

**NOTE:** The slot is keyed to ensure correct insertion of the card.

2. Press the card into the slot to lock it into place.

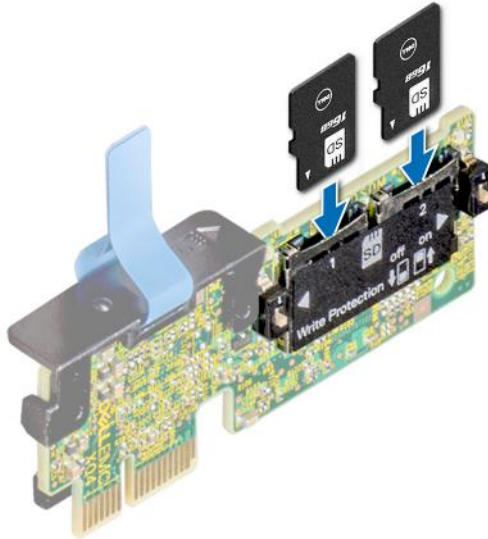

**Figure 100. Installing the MicroSD card**

### Next steps

1. [Install the IDSDM module.](#)
2. [Install the air shroud.](#)
3. Follow the procedure listed in the [After working inside your system](#) on page 26.

## Optional BOSS S1 card

### Removing the M.2 BOSS riser

#### Prerequisites

1. Follow the safety guidelines listed in the [Safety instructions](#) on page 25.
2. Follow the procedure listed in the [Before working inside your system](#) on page 26.

#### Steps

Hold the blue touch points, and lift the M.2 BOSS riser from the riser connector on the system board.

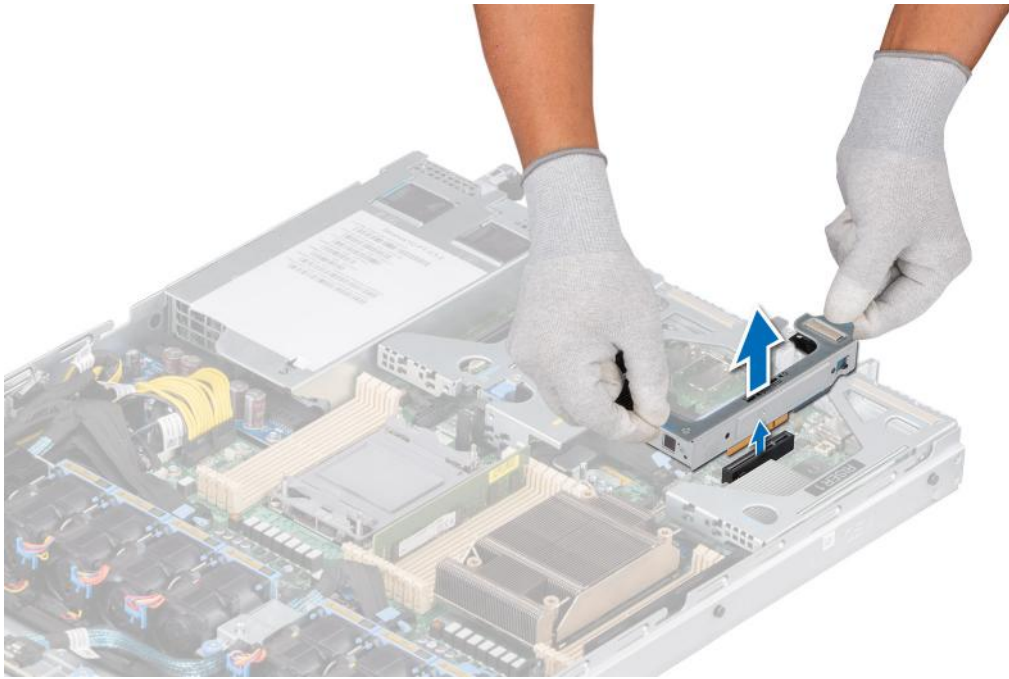

**Figure 101. Removing the M.2 BOSS riser**

**Next steps**

Replace the M.2 BOSS riser.

## Installing the M.2 BOSS riser

**Prerequisites**

1. Follow the safety guidelines listed in the [Safety instructions](#) on page 25.
2. Follow the procedure listed in [Before working inside your system](#) on page 26.

**Steps**

1. Align the M.2 BOSS riser connector with the connectors on the system board and the guide on the M.2 BOSS riser with the guiding slot on the system board.
2. Lower the M.2 BOSS riser into place until the M.2 BOSS riser connector is fully seated in the connector.



**Figure 102. Installing the M.2 BOSS riser**

### **Next steps**

Follow the procedure listed in [After working inside your system](#) on page 26.

## **Removing the M.2 BOSS card from the M.2 BOSS riser**

### **Prerequisites**

1. Follow the safety guidelines listed in the [Safety instructions](#) on page 25.
2. Follow the procedure listed in the [Before working inside your system](#) on page 26.
3. [Removing the M.2 BOSS riser.](#)

### **About this task**

Holding the blue tag, pull the M.2 BOSS card away from the M.2 BOSS riser.

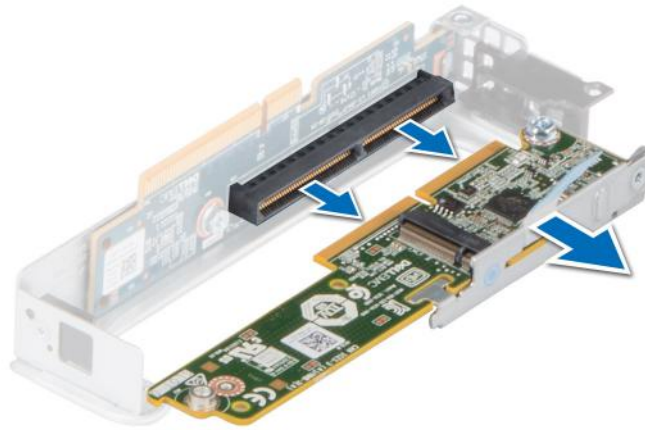

**Figure 103. Removing the M.2 BOSS card from the M.2 BOSS riser**

**Next steps**

If applicable, [install an card into the M.2 BOSS riser.](#)

## Installing the M2 BOSS card into the M.2 BOSS riser

**Prerequisites**

1. Follow the safety guidelines listed in the [Safety instructions](#) on page 25.
2. Follow the procedure listed in [Before working inside your system](#) on page 26.
3. [Removing the M.2 BOSS riser.](#)

**Steps**

1. Align and insert the M.2 BOSS card connector with the connectors on the M.2 BOSS riser.
2. Press the blue touch point on the M.2 BOSS card until it is firmly seated.

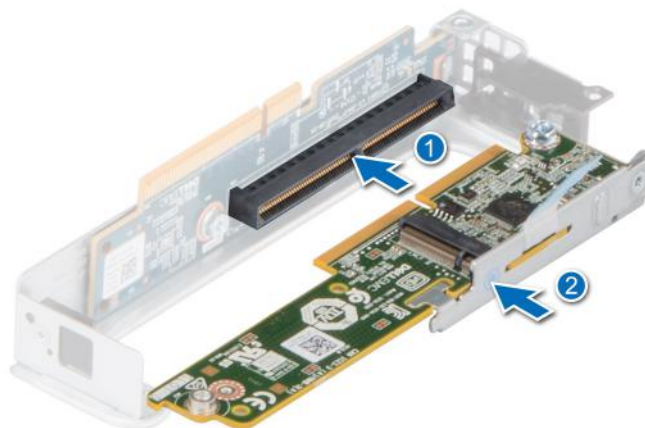

**Figure 104. Installing the M2 BOSS card into the M.2 BOSS riser**

### Next steps

1. If applicable, [Install the M.2 BOSS riser](#).
2. Follow the procedure listed in [After working inside your system](#) on page 26.

## Removing the M.2 SSD module

### Prerequisites

1. Follow the safety guidelines listed in the [Safety instructions](#) on page 25.
2. Follow the procedure listed in the [Before working inside your system](#) on page 26.
3. [Removing the M.2 BOSS riser](#).
4. [Remove the M.2 BOSS card from the M.2 BOSS riser](#).

### Steps

1. Using the Phillips #1 screwdriver, remove the screws securing the M.2 SSD module to the BOSS card.
2. Pull the M.2 SSD module to disconnect from the connector on the M.2 BOSS card.

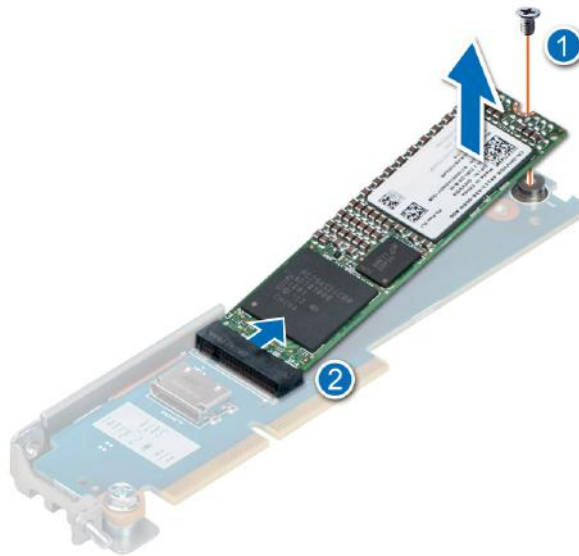

**Figure 105. Removing the M.2 SSD module**

### Next steps

1. If applicable, [Install the M.2 BOSS card into the M.2 BOSS riser](#).
2. If applicable, [Install the M.2 BOSS riser](#).

## Installing the M.2 SSD module

### Prerequisites

1. Follow the safety guidelines listed in the [Safety instructions](#) on page 25.
2. Follow the procedure listed in [Before working inside your system](#) on page 26.
3. [Removing the M.2 BOSS riser](#).
4. [Remove the M.2 BOSS card from the M.2 BOSS riser](#).

### Steps

1. Align the M.2 SSD module at angle with the connector on the M.2 BOSS card.
2. Insert the M.2 SSD module until it is firmly seated in M.2 BOSS card connector.

- Using the Phillips #1 screwdriver, secure the M.2 SSD module on the M.2 BOSS card with the screw.

**NOTE:** The numbers on the image do not depict the exact steps. The numbers are for representation of sequence.

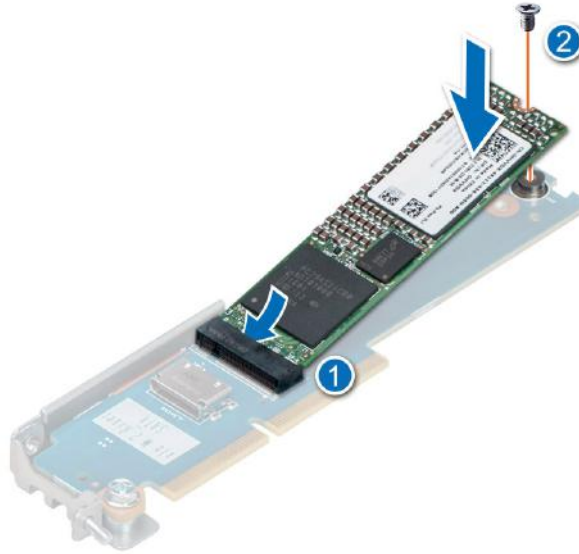

**Figure 106. Installing the M.2 SSD module**

#### Next steps

- If applicable, [Install the M.2 BOSS card into the M.2 BOSS riser](#).
- If applicable, [Install the M,2 BOSS riser](#).
- Follow the procedure listed in the [After working inside your system](#) on page 26.

## Optional IDSDM module

### Removing the IDSDM module

#### Prerequisites

- Follow the safety guidelines listed in the [Safety instructions](#) on page 25.
- Follow the procedure listed in [Before working inside your system](#) on page 26.
- [Remove the air shroud](#).
- If you are replacing the IDSDM card, remove the MicroSD cards.

**NOTE:** Temporarily label each SD card with its corresponding slot number before removal. Reinstall the SD cards into the corresponding slots.

#### Steps

Holding the pull tab, lift the IDSDM card out of the system.



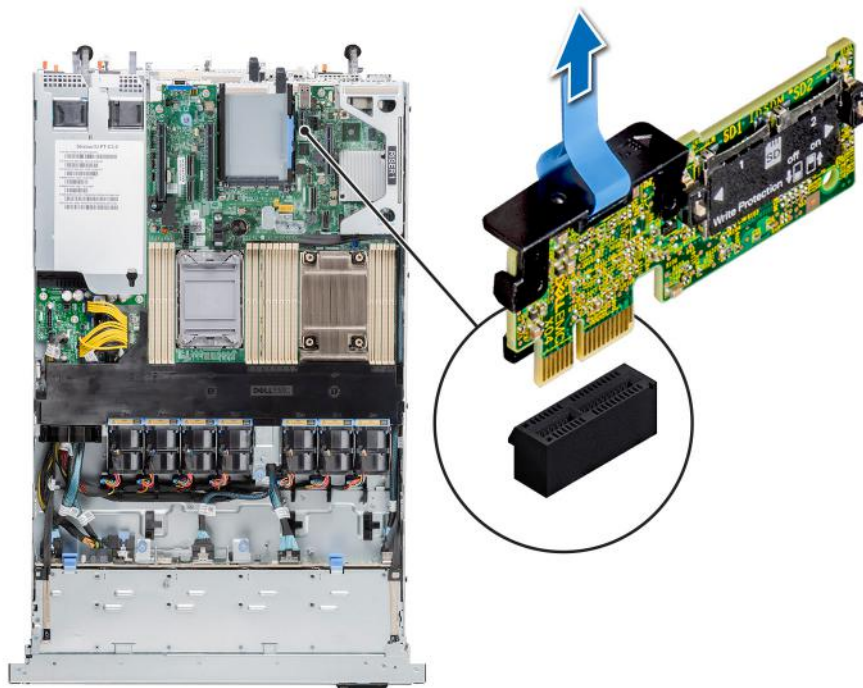

**Figure 107. Removing the IDSDM module**

#### **Next steps**

Replace the IDSDM module.

## **Installing the IDSDM module**

#### **Prerequisites**

1. Follow the safety guidelines listed in the [Safety instructions](#) on page 25.
2. Follow the procedure listed in [Before working inside your system](#) on page 26.
3. [Remove the air shroud](#).

#### **Steps**

1. Locate the IDSDM connector on the system board.  
To locate IDSDM, see the System board jumpers and connectors section.
2. Align IDSDM module with the connector on the system board.
3. Push IDSDM module until it is firmly seated in the connector on the system board.

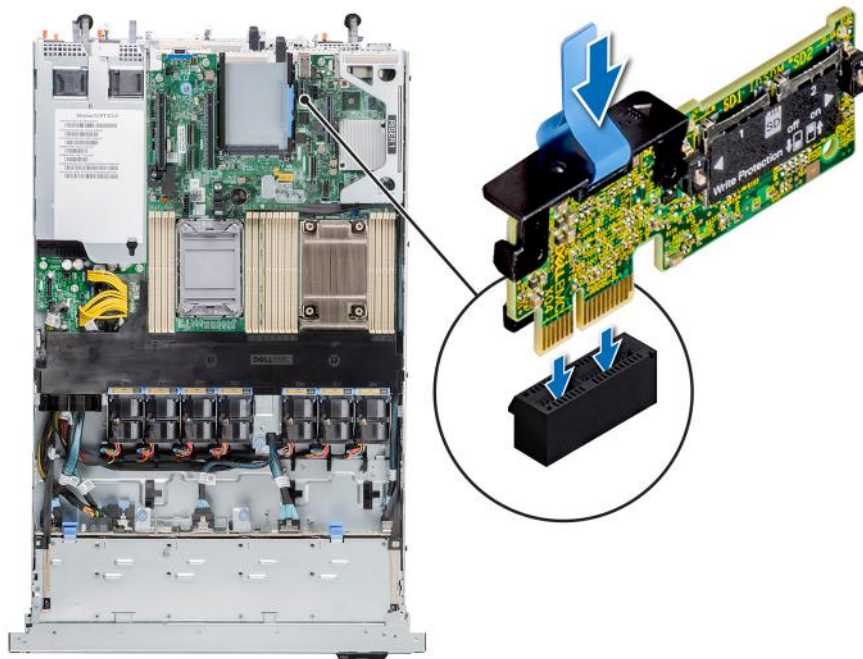

**Figure 108. Installing the IDSDM module**

#### Next steps

1. Install the MicroSD cards.  
**NOTE:** Reinstall the MicroSD cards into the same slots based on the labels you had marked on the cards during removal.
2. Install the air shroud.
3. Follow the procedure listed in the [After working inside your system](#) on page 26.

## Optional OCP card

### Removing the OCP card

#### Prerequisites

1. Follow the safety guidelines listed in the [Safety instructions](#) on page 25.
2. Follow the procedure listed in [Before working inside your system](#) on page 26.
3. [Remove the expansion card riser.](#)

#### Steps

1. Open the blue latch to unlock the OCP card.
2. Push the OCP card towards the rear end of the system to disconnect from the connector on the system board.
3. Slide the OCP card out of the slot on the system.

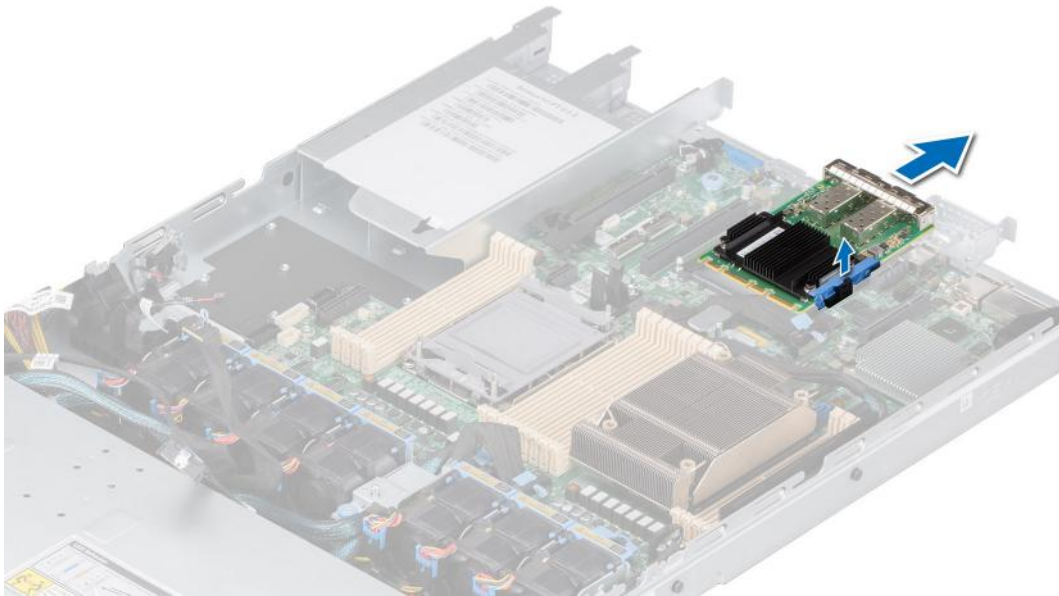

**Figure 109. Removing the OCP card**

### Next steps

Replace the OCP card.

## Installing the OCP card

### Prerequisites

1. Follow the safety guidelines listed in the [Safety instructions](#) on page 25.
2. Follow the procedure listed in [Before working inside your system](#) on page 26.
3. [Remove the expansion card riser.](#)

### Steps

1. Open the blue latch on the system board.
2. Slide the OCP card into the slot in the system.
3. Push until the OCP card is connected to the connector on the system board.
4. Close the latch to lock the OCP card to the system.

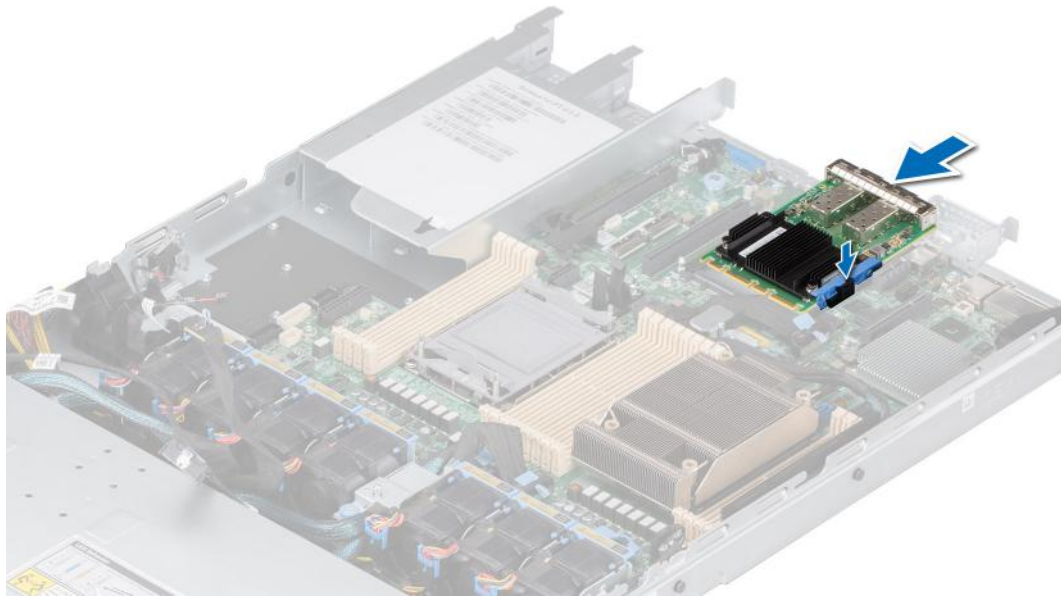

Figure 110. Installing the OCP card

#### Next steps

1. [Install the expansion card riser.](#)
2. Follow the procedure listed in [After working inside your system](#) on page 26.

## Front mounting front PERC module

This is a service technician replaceable part only.

## Removing the front mounting front PERC module

#### Prerequisites

1. Follow the safety guidelines listed in the [Safety instructions](#) on page 25.
2. Follow the procedure listed in the [Before working inside your system](#) on page 26.
3. [Remove the drive backplane cover.](#)
4. If installed, [remove the air shroud.](#)
5. Disconnect all the cables, observe the cable routing.

#### Steps

1. Using a Phillips #2 screwdriver, loosen the thumbscrews on the front PERC module.
2. Pull the front PERC module to disengage from the connector on the drive backplane.
3. Tilt and lift the front PERC module out of the system.

**i** **NOTE:** The numbers on the image do not depict the exact steps. The numbers are for representation of sequence.

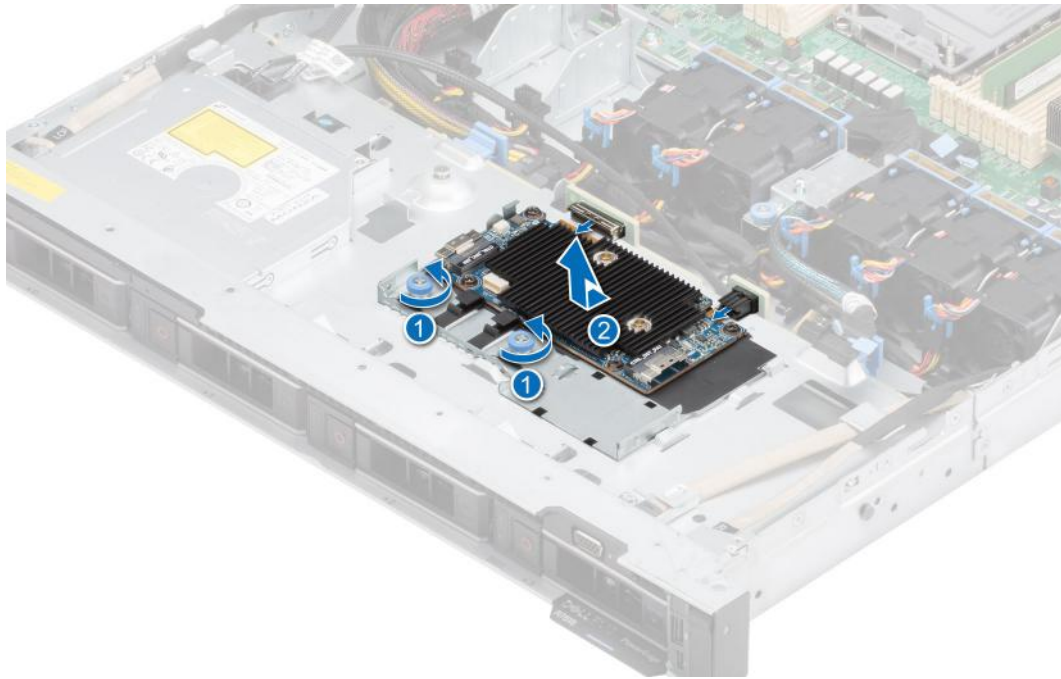

**Figure 111. Removing the front mounting front PERC module**

### Next steps

Replace the front mounting front PERC module.

## Installing the front mounting front PERC module

### Prerequisites

1. Follow the safety guidelines listed in the [Safety instructions](#) on page 25.
2. Follow the procedure listed in [Before working inside your system](#) on page 26.
3. [Remove the drive backplane cover](#).
4. If installed, [remove the air shroud](#).
5. Route the cable properly to prevent the cable from being pinched or crimped.

### Steps

1. Connect the PERC cable to the front PERC module.
2. Align the front PERC module at an angle until the tray touches the slot in the system.
3. Press the front PERC module connector with the connector on the drive backplane until firmly seated.
4. Using a Phillips #2 screwdriver, tighten the thumbscrews on the front PERC module.

**NOTE:** The numbers on the image do not depict the exact steps. The numbers are for representation of sequence.

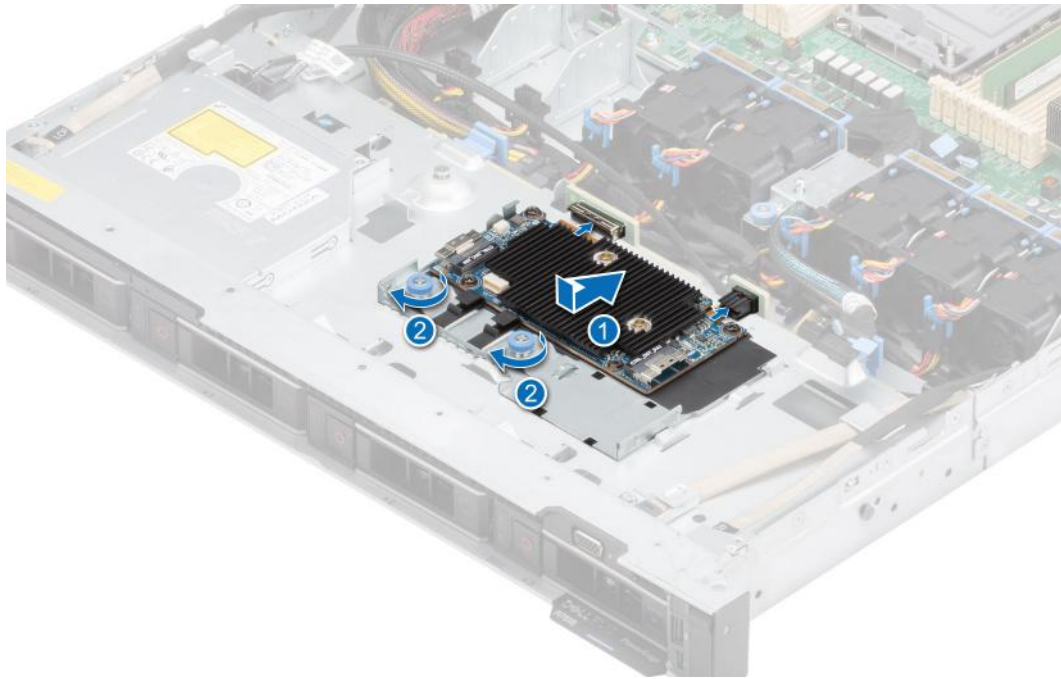

Figure 112. Installing the front mounting front PERC module

#### Next steps

1. Reconnect all the required cables.
2. If removed, [install the air shroud](#).
3. [Install the drive backplane cover](#).
4. Follow the procedure listed in [After working inside your system](#) on page 26.

## System battery

This is a service technician replaceable part only.

## Replacing the system battery

#### Prerequisites

**⚠ WARNING:** There is a danger of a new battery exploding if it is incorrectly installed. Replace the battery only with the same or equivalent type recommended by the manufacturer. Discard used batteries according to the manufacturer's instructions. See the Safety instructions that came with your system for more information.

1. Follow the safety guidelines listed in the [Safety instructions](#) on page 25.
2. Follow the procedure listed in [Before working inside your system](#) on page 26.
3. [Remove the expansion card riser](#).
4. If applicable, disconnect the power or data cables from the expansion card(s).

#### Steps

1. To remove the battery:
  - a. Use a plastic scribe to pry out the system battery.

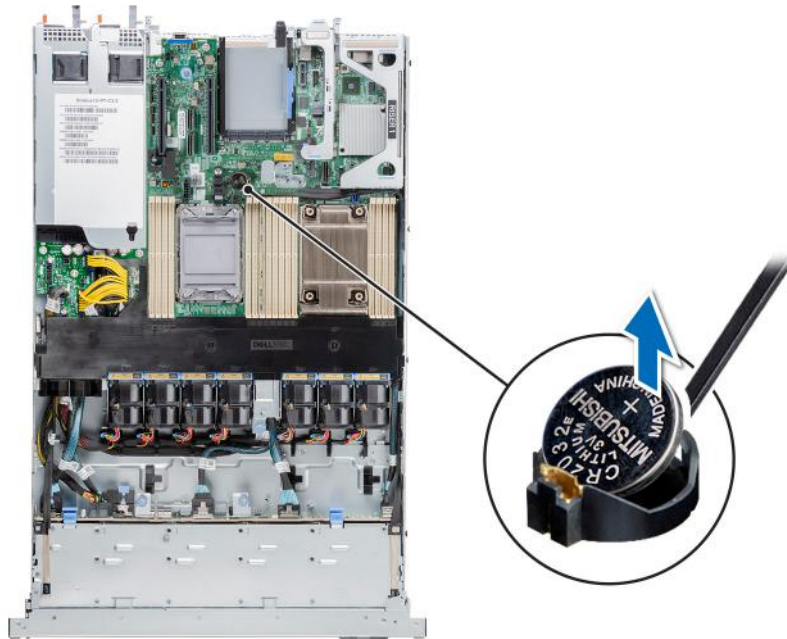

Figure 113. Removing the system battery

**CAUTION:** To avoid damage to the battery connector, you must firmly support the connector while installing or removing a battery.

2. To install a new system battery:
  - a. Hold the battery with the positive side facing up and slide it under the securing tabs.
  - b. Press the battery into the connector until it snaps into place.

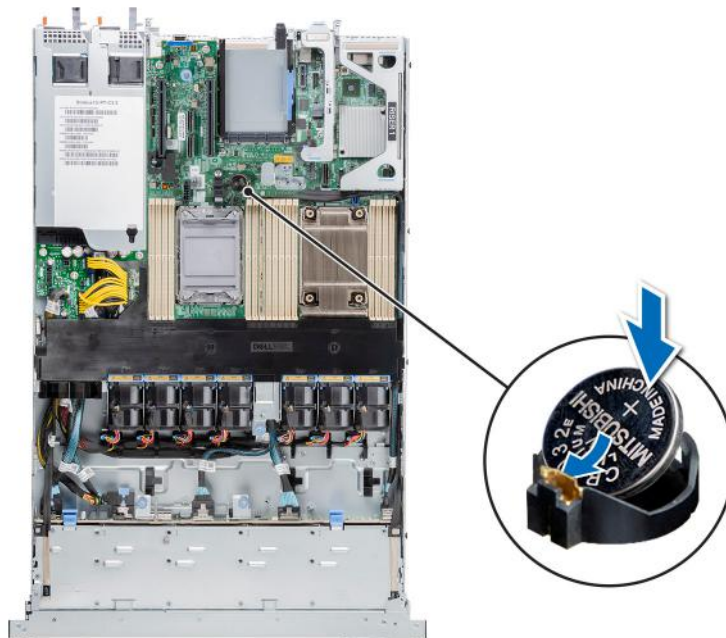

Figure 114. Installing the system battery

#### Next steps

1. If applicable, [Install the expansion card riser](#) and connect the cables to the expansion card(s).
2. Follow the procedure listed in the [After working inside your system](#) on page 26.

3. Confirm that the battery is operating properly, by performing the following steps:
  - a. Enter the System Setup, while booting, by pressing F2.
  - b. Enter the correct time and date in the System Setup **Time** and **Date** fields.
  - c. **Exit** the System Setup.
  - d. To test the newly installed battery, remove the system from the enclosure for at least an hour.
  - e. Reinstall the system into the enclosure after an hour.
  - f. Enter the System Setup and if the time and date are still incorrect, see [Getting help](#) section.

## Optional internal USB card

**NOTE:** To locate the internal USB port on the system board, see the [System board jumpers and connectors](#) section.

## Removing the optional internal USB card

### Prerequisites

**CAUTION:** To avoid interference with other components in the server, the maximum permissible dimensions of the USB memory key are 15.9 mm width x 57.15 mm length x 7.9 mm height.

1. Follow the safety guidelines listed in the [Safety instructions](#).
2. Follow the procedure listed in the [Before working inside your system](#).
3. [Removing the M.2 riser](#).

### Steps

1. Holding the blue tag, lift the internal USB card to disconnect from the connector on the system board.
2. Remove the USB memory key from the internal USB card.

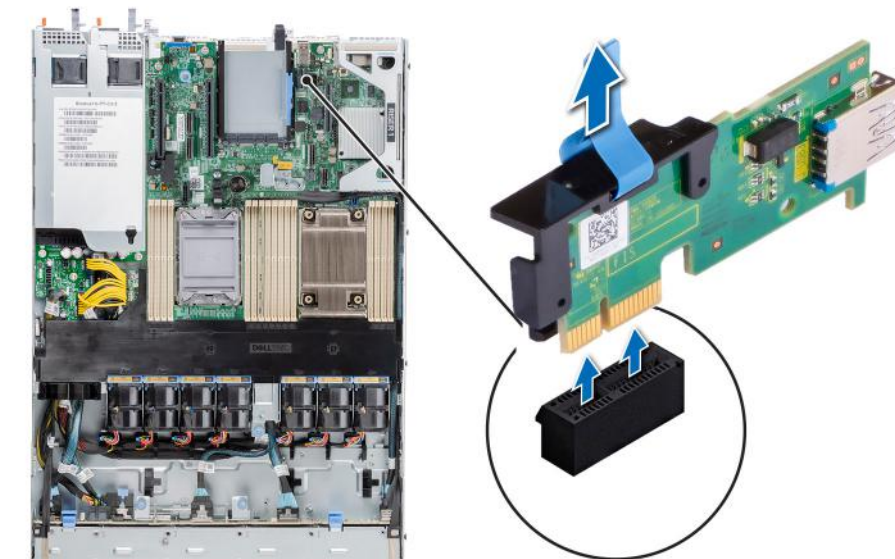

Figure 115. Removing the internal USB card

### Next steps

[Replace the internal USB card.](#)



# Installing the internal USB card

## Prerequisites

1. Follow the safety guidelines listed in the [Safety instructions](#).
2. Follow the procedure listed in the [Before working inside your system](#).
3. [Removing the M.2 BOSS riser](#).

## Steps

1. Connect the USB key to the internal USB card.
2. Align the internal USB card with the connector on the system board and press firmly until the internal USB card is seated.

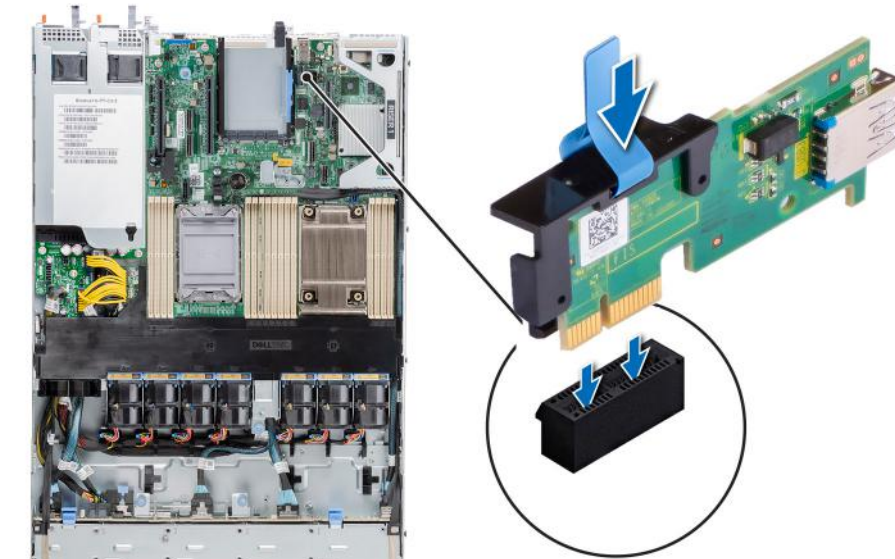

Figure 116. Installing the internal USB card

## Next steps

1. Follow the procedure listed in [After working inside your system](#).
2. While booting, press F2 to enter **System Setup** and verify that the system detects the USB memory key.

# VGA module

This is a service technician replaceable part only.

# Removing the VGA module

## Prerequisites

1. Follow the safety guidelines listed in the [Safety instructions](#) on page 25.
2. Follow the procedure listed in [Before working inside your system](#) on page 26.
3. [Remove the front bezel](#).
4. [Remove the backplane cover](#).
5. [Remove the air shroud](#).
6. Disconnect the VGA cable from the VGA connector on the system board. For locating the connector, see the [System board jumpers and connectors](#) section.

**NOTE:** Ensure that you note the routing of the cables as you remove them from the system board. Route the cable properly when you replace it to prevent the cable from being pinched or crimped

### Steps

1. Using Phillips #1 screwdriver, remove the screw on the VGA module.
2. Slide the module out of the system.

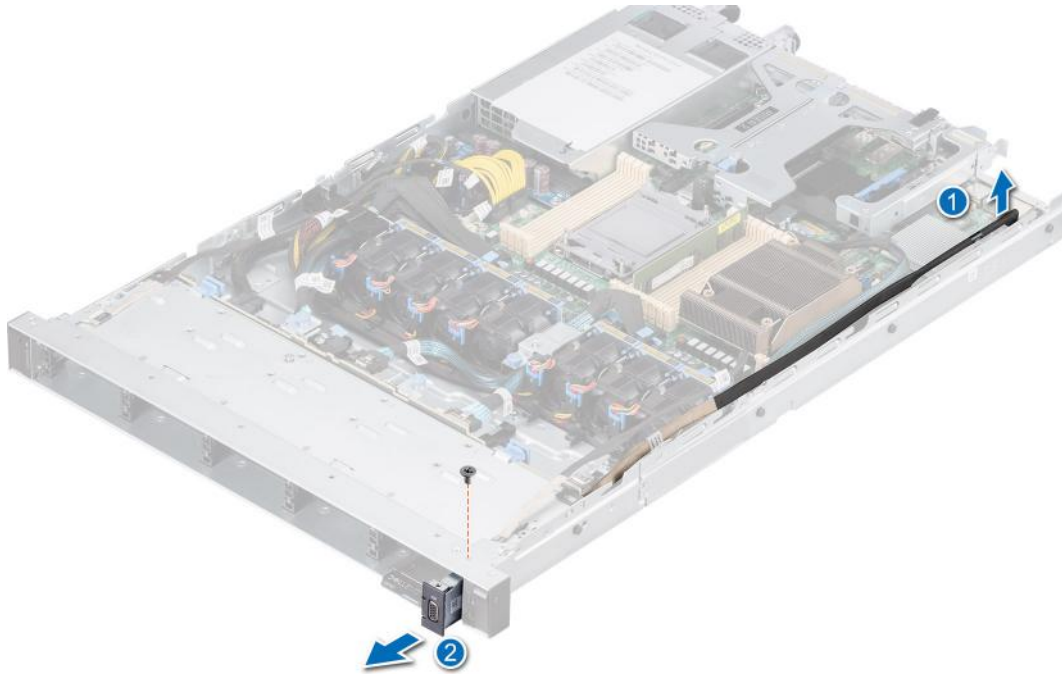

Figure 117. Removing the VGA module

### Next steps

Replace the VGA module.

## Installing the VGA module

### Prerequisites

1. Follow the safety guidelines listed in the [Safety instructions](#) on page 25.
2. Follow the procedure listed in [Before working inside your system](#) on page 26.
3. [Remove the front bezel.](#)
4. [Remove the backplane cover.](#)
5. [Remove the air shroud.](#)

**NOTE:** Ensure that you note the routing of the cables as you remove them from the system board. Route the cable properly when you replace it to prevent the cable from being pinched or crimped

### Steps

1. Route the VGA cable through the VGA module slot on the front of the system and slide the VGA module into the slot.
2. Align the hole on the module with the screw hole on the system.
3. Using the Phillips #1 screwdriver, secure the VGA module to the system with the screw.

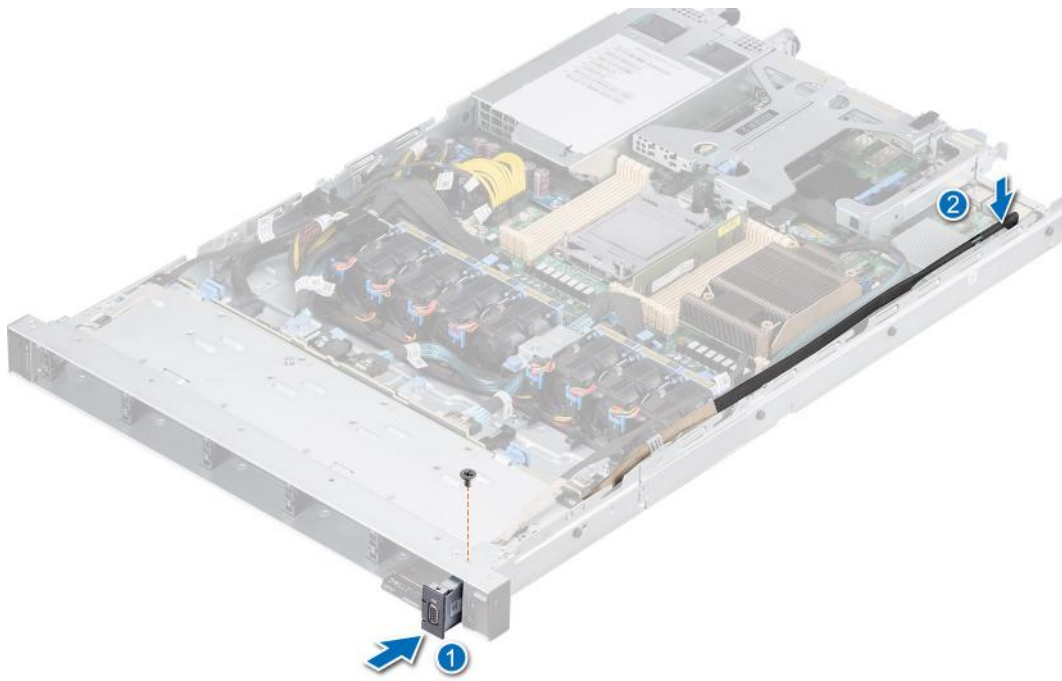

**Figure 118. Installing the VGA module**

#### Next steps

1. Route the VGA cable and connect it to the VGA connector on the system board. For locating the connector, see the [System board jumpers and connectors](#) section.
2. [Install the air shroud.](#)
3. [Install the backplane cover.](#)
4. [Install the front bezel.](#)
5. Follow the procedure listed in [After working inside your system](#) on page 26.

## Power supply unit

**NOTE:** While replacing the hot swappable PSU, after next server boot; the new PSU automatically updates to the same firmware and configuration of the replaced one. For more information about the Part replacement configuration, see the *Lifecycle Controller User's Guide* at <https://www.dell.com/idracmanuals>

## Hot spare feature

Your system supports the hot spare feature that significantly reduces the power overhead associated with the power supply unit (PSU) redundancy.

When the hot spare feature is enabled, one of the redundant PSUs is switched to the sleep state. The active PSU supports 100 percent of the system load, thus operating at higher efficiency. The PSU in the sleep state monitors output voltage of the active PSU. If the output voltage of the active PSU drops, the PSU in the sleep state returns to an active output state.

If having both PSUs active is more efficient than having one PSU in the sleep state, the active PSU can also activate the sleeping PSU.

The default PSU settings are as follows:

- If the load on the active PSU is more than 50 percent of PSU rated power wattage, then the redundant PSU is switched to the active state.
- If the load on the active PSU falls below 20 percent of PSU rated power wattage, then the redundant PSU is switched to the sleep state.

You can configure the hot spare feature by using the iDRAC settings. For more information, see the *iDRAC User's Guide* available at [www.dell.com/poweredgemanuals](http://www.dell.com/poweredgemanuals).

## Removing a power supply unit blank

### Prerequisites

Follow the safety guidelines listed in the [Safety instructions](#) on page 25.

### Steps

Pull the blank out of the system.

**CAUTION:** To ensure proper system cooling, the PSU blank must be installed in the second PSU bay in a non-redundant configuration. Remove the PSU blank only if you are installing a second PSU.

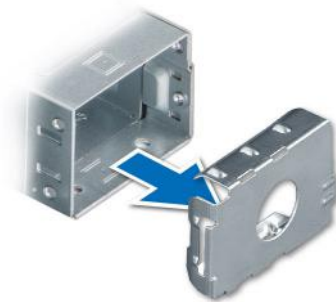

Figure 119. Removing a power supply unit blank

### Next steps

Replace the [PSU](#) or [PSU blank](#).

## Installing a power supply unit blank

### Prerequisites

1. Follow the safety guidelines listed in the [Safety instructions](#) on page 25.  
**NOTE:** Install the power supply unit (PSU) blank only in the second PSU bay.
2. [Remove the PSU](#).

### Steps

Align the PSU blank with the PSU bay and push it into the PSU bay until it clicks into place.

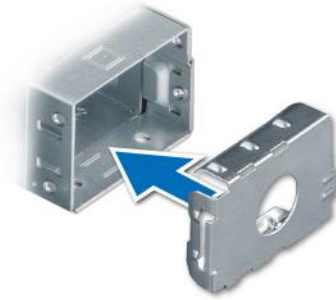

Figure 120. Installing a power supply unit blank

## Removing a power supply unit

### Prerequisites

**CAUTION:** The system requires one power supply unit (PSU) for normal operation. On power-redundant systems, remove and replace only one PSU at a time in a system that is powered on.

1. Follow the safety guidelines listed in the [Safety instructions](#) on page 25.
2. Disconnect the power cable from the power outlet and from the PSU you intend to remove.
3. Remove the cable from the strap on the PSU handle.
4. Unlatch and lift the optional cable management arm if it interferes with the PSU removal.

For information about the cable management arm, see the system's rack documentation at <https://www.dell.com/poweredgemanuals>.

### Steps

Press the release latch, and holding the PSU handle slide the PSU out of the PSU bay.



Figure 121. Removing a power supply unit

### Next steps

Replace the PSU or install the PSU blank.

# Installing a power supply unit

## Prerequisites

1. Follow the safety guidelines listed in the [Safety instructions](#) on page 25.
2. For systems that support redundant PSU, ensure that both the PSUs are of the same type and have the same maximum output power.

**i** **NOTE:** The maximum output power (shown in watts) is listed on the PSU label.

3. Remove the [PSU blank](#).

## Steps

Slide the PSU into the PSU bay until the release latch snaps into place.



Figure 122. Installing a power supply unit

## Next steps

1. If you have unlatched the cable management arm, relatch it. For information about the cable management arm, see the system's rack documentation at <https://www.dell.com/poweredgemanuals>.
2. Connect the power cable to the PSU, and plug the cable into a power outlet.

**⚠ CAUTION:** When connecting the power cable to the PSU, secure the cable to the PSU with the strap.

**i** **NOTE:** When installing, hot swapping, or hot adding a new PSU, wait for 15 seconds for the system to recognize the PSU and determine its status. The PSU redundancy may not occur until discovery is complete. The PSU status indicator turns green to indicate that the PSU is functioning properly.

**i** **NOTE:** For certain premium configurations with high power consumption, system PSU might stay with 2+0 mode only, 1+1 redundant mode is not available.

**i** **NOTE:** While replacing the hot swappable PSU, after next server boot; the new PSU automatically updates to the same firmware and configuration of the replaced one. For more information about the Part replacement configuration, see the *Lifecycle Controller User's Guide* at <https://www.dell.com/idracmanuals>.

# Power interposer board

This is a service technician replaceable part only.

## Removing the power interposer board

### Prerequisites

1. Follow the safety guidelines listed in the [Safety instructions](#) on page 25.
2. Follow the procedure listed in [Before working inside your system](#) on page 26.
3. [Remove the air shroud](#).
4. Remove the [PSU](#) or [PSU blank](#).
5. Disconnect the cables that are connected to power interposer board (PIB).

### Steps

1. Using a Phillips #2 screwdriver, remove the screws securing the power interposer board to the system.

 **NOTE:** Observe the routing of the cable as you remove it from the system.

2. Lift the PIB away from the system.

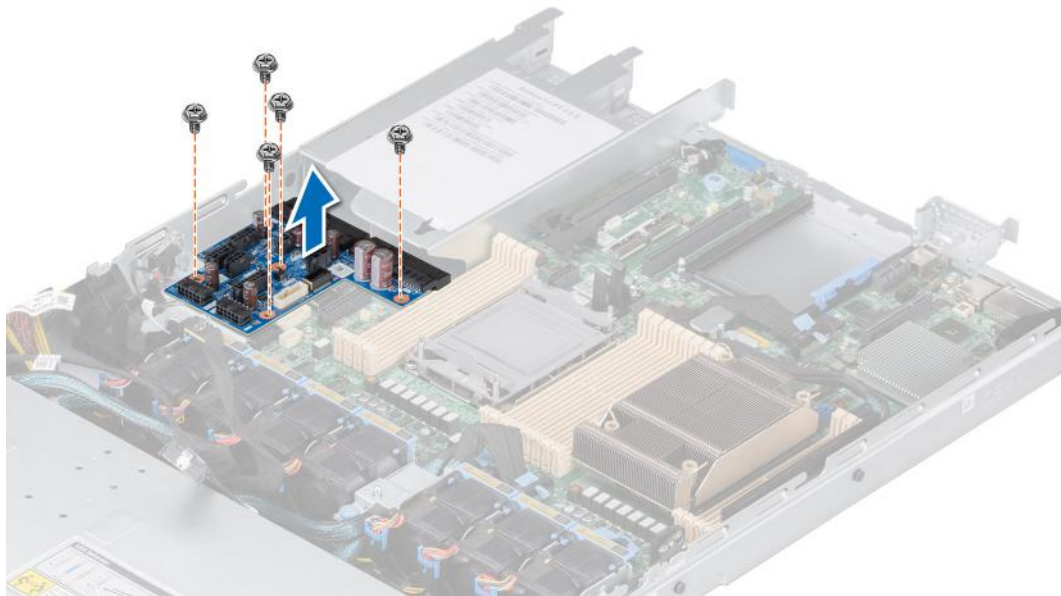

**Figure 123. Removing the power interposer board**

### Next steps

[Replace the power interposer board.](#)

## Installing the power interposer board

### Prerequisites

1. Follow the safety guidelines listed in the [Safety instructions](#) on page 25.
2. Follow the procedure listed in [Before working inside your system](#) on page 26.

## Steps

1. Align the slots on the PIB with the hook on the chassis and slide it into place.
2. Using Phillips #2 screwdriver, tighten the screws to secure the PIB to the system.

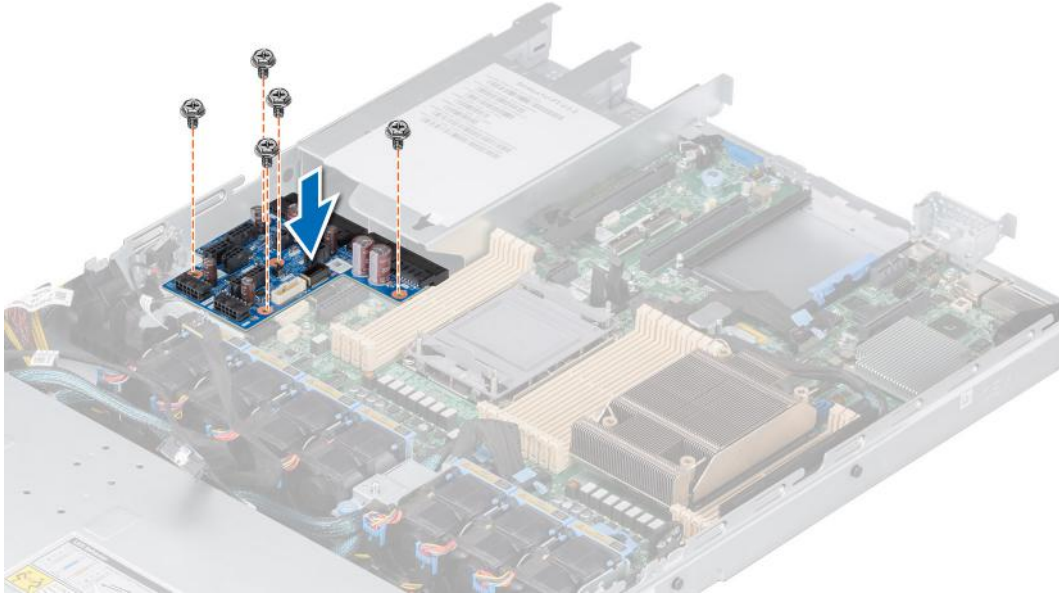

**Figure 124. Installing the power interposer board**

3. Reconnect all the required cables.

## Next steps

1. [Install the PSU.](#)
2. [Install the air shroud.](#)
3. Follow the procedure listed in [After working inside your system](#) on page 26.

# System board

This is a service technician replaceable part only.

## Removing the system board

### Prerequisites

**CAUTION:** If you are using the Trusted Platform Module (TPM) with an encryption key, you may be prompted to create a recovery key during program or System Setup. Be sure to create and safely store this recovery key. If you replace this system board, you must supply the recovery key when you restart your system or program before you can access the encrypted data on your drives.

1. Follow the safety guidelines listed in the [Safety instructions](#) on page 25.
2. Follow the procedure listed in [Before working inside your system](#) on page 26.
3. Remove the following components:
  - a. [Air shroud](#)
  - b. [Expansion cards](#)
  - c. [Expansion card risers](#)
  - d. [M.2 BOSS riser](#)
  - e. [Internal USB key \(if installed\)](#)



- f. Processor
- g. Heat sink
- h. Memory modules
- i. OCP
- j. Disconnect all cables from the system board.

**CAUTION:** Take care not to damage the system identification button while removing the system board from the system.

### Steps

1. Using the system board holder, slide the system board toward the front of the chassis.
2. Incline the system board at an angle and lift the system board out of the chassis.

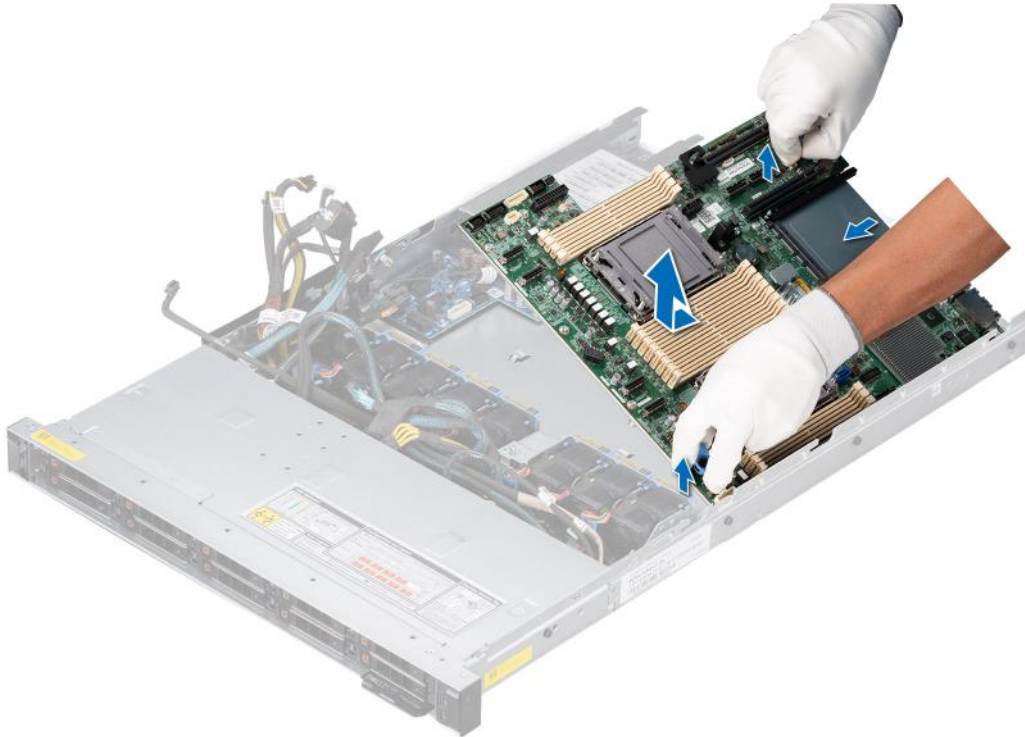

**Figure 125. Removing the system board**

### Next steps

Install the system board.

## Installing the system board

### Prerequisites

**NOTE:** Before replacing the system board, replace the old iDRAC MAC address label in the Information tag with the iDRAC MAC address label of the replacement system board

1. Follow the safety guidelines listed in the [Safety instructions](#) on page 25.
2. Follow the procedure listed in [Before working inside your system](#) on page 26.
3. If you are replacing the system board, remove all the components that are listed in the [removing the system board](#) section.

### Steps

1. Unpack the new system board assembly.

**CAUTION:** Do not lift the system board by holding a memory module, processor, or other components.

**CAUTION:** Take care not to damage the system identification button while placing the system board into the chassis.

2. Using the system board holder, lower the system board it into the system.
3. Incline the system board at an angle and align the connectors on the system board with the slots on the rear of the chassis until the connectors are firmly seated in the slots.

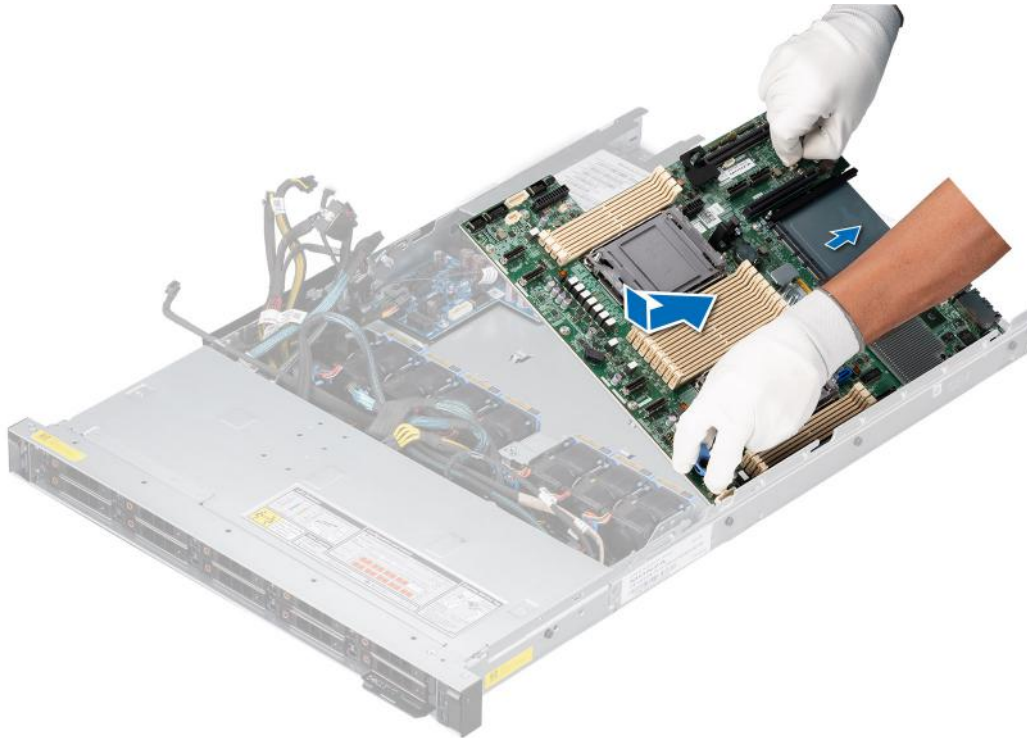

**Figure 126. Installing the system board**

### Next steps

1. Replace the following components:
  - a. [Trusted Platform Module \(TPM\)](#)  
**i** **NOTE:** The TPM Module must be replaced only while installing new system board.
  - b. [Expansion cards](#)
  - c. [Expansion card risers](#)
  - d. [M.2 BOSS riser](#)
  - e. [Processor](#)
  - f. [Heat sink](#)
  - g. [Memory modules](#)
  - h. [OCP card](#)
  - i. [Air shroud](#)
2. Reconnect all cables to the system board.  
**i** **NOTE:** Ensure that the cables inside the system are routed along the chassis wall and secured using the cable securing bracket.
3. Ensure that you perform the following steps:
  - a. Use the Easy Restore feature to restore the Service Tag. See the [Restoring the system by using the Easy Restore feature](#) section.
  - b. If the service tag is not backed up in the backup flash device, enter the system service tag manually. See the [Manually update the Service Tag by using System Setup](#) section.
  - c. Update the BIOS and iDRAC versions.

Re-enable the Trusted Platform Module (TPM). See the [Upgrading the Trusted Platform Module](#) section.

4. If you are not using Easy restore, import your new or existing iDRAC Enterprise license. For more information, see the *iDRAC User's Guide* available at <https://www.dell.com/idracmanuals>.
5. Follow the procedure listed in [After working inside your system](#) on page 26.

## Restoring the system using Easy Restore

The Easy Restore feature enables you to restore your service tag, license, UEFI configuration, and the system configuration data after replacing the system board. All data is backed up in a backup flash device automatically. If BIOS detects a new system board, and the service tag in the backup flash device, BIOS prompts the user to restore the backup information.

### About this task

Below is a list of options/steps available:

- Restore the service tag, license, and diagnostics information, press **Y**
- Navigate to the Lifecycle Controller based restore options, press **N**
- Restore data from a previously created **Hardware Server Profile**, press **F10**  
**i** **NOTE:** When the restore process is complete, BIOS prompts to restore the system configuration data.
- Restore data from a previously created **Hardware Server Profile**, press **F10**
- To restore the system configuration data, press **Y**
- To use the default configuration settings, press **N**
- **i** **NOTE:** After the restore process is complete, system reboots.

## Manually update the Service Tag

After replacing a system board, if Easy Restore fails, follow this process to manually enter the Service Tag, using **System Setup**.

### About this task

If you know the system service tag, use the **System Setup** menu to enter the service tag.

### Steps

1. Power on the system.
2. To enter the **System Setup**, press **F2**.
3. Click **Service Tag Settings**.
4. Enter the service tag.  
**i** **NOTE:** You can enter the service tag only when the **Service Tag** field is empty. Ensure that you enter the correct service tag. Once the service tag is entered, it cannot be updated or changed.
5. Click **OK**.

## Trusted Platform Module

This is a service technician replaceable part only.

## Upgrading the Trusted Platform Module

### Prerequisites

- i** **NOTE:**
  - Ensure that your operating system supports the version of the TPM module being installed.
  - Ensure that you download and install the latest BIOS firmware on your system.

- Ensure that the BIOS is configured to enable UEFI boot mode.

**CAUTION:** After the TPM plug-in module is installed, it is cryptographically bound to that specific system board. When the system is powered on, any attempt to remove an installed TPM plug-in module breaks the cryptographic binding, and the removed TPM cannot be installed on another system board. Ensure any keys you have stored on the TPM have been securely transferred.

## Removing the TPM

### Steps

1. Locate the TPM connector on the system board.
2. Press to hold the module down and remove the screw using the security Torx 8-bit shipped with the TPM module.
3. Slide the TPM module out from its connector.
4. Push the plastic rivet away from the TPM connector and rotate it 90° counterclockwise to release it from the system board.
5. Pull the plastic rivet out of its slot on the system board.

## Installing the TPM

### Steps

1. To install the TPM, align the edge connectors on the TPM with the slot on the TPM connector.
2. Insert the TPM into the TPM connector such that the plastic rivet aligns with the slot on the system board.
3. Press the plastic rivet until the rivet snaps into place.
4. Replace the screw that secures the TPM to the system board.



Figure 127. Installing the TPM

## Initializing TPM for users

### Steps

1. Initialize the TPM.  
For more information, see [Initializing the TPM for users](#).
2. The **TPM Status** changes to **Enabled, Activated**.

## Initializing the TPM 1.2 for users

### Steps

1. While booting your system, press F2 to enter System Setup.
2. On the **System Setup Main Menu** screen, click **System BIOS > System Security Settings**.

3. From the **TPM Security** option, select **On with Preboot Measurements**.
4. From the **TPM Command** option, select **Activate**.
5. Save the settings.
6. Restart your system.

## Initializing the TPM 2.0 for users

### Steps

1. While booting your system, press F2 to enter System Setup.
2. On the **System Setup Main Menu** screen, click **System BIOS > System Security Settings**.
3. From the **TPM Security** option, select **On**.
4. Save the settings.
5. Restart your system.

## Control panel

This is a service technician replaceable part only.

## Removing the left control panel

### Prerequisites

1. Follow the safety guidelines listed in the [Safety instructions](#) on page 25.
2. Follow the procedure listed in the [Before working inside your system](#) on page 26.
3. [Remove the air shroud](#).
4. If applicable, [remove the backplane cover](#).

### Steps

1. Disconnect the control panel cable from the system board connector.

 **NOTE:** Observe the routing of the cable as you remove it from the system.

2. Open the cable retention latch.
3. Remove the cable from cable clip.
4. Using the Phillips #1 screwdriver, remove the screws that secure the left control panel assembly to the system.
5. Hold the left control panel assembly and remove the control panel along with the cable from the system.

 **NOTE:** The numbers on the image do not depict the exact steps. The numbers are for representation of sequence.



**Figure 128. Removing the left control panel**

### Next steps

Replace the left control panel.

## Installing the left control panel

### Prerequisites

1. Follow the safety guidelines listed in the [Safety instructions](#) on page 25.
2. Follow the procedure listed in [Before working inside your system](#) on page 26.
3. [Remove the front bezel](#).
4. [Remove the backplane cover](#).
5. [Remove the air shroud](#).

### Steps

1. Route the control panel cable through the cable clip, the guide slots in the system and connector on system board.

**NOTE:** Route the cable properly to prevent the cable from being pinched or crimped.

2. Close and secure the cable guiding latch.
3. Align and insert the left control panel assembly in the slot on the system.
4. Using the Phillips #1 screwdriver, tighten the screws that secure the left control panel assembly to the system.

**NOTE:** The numbers on the image do not depict the exact steps. The numbers are for representation of sequence.



**Figure 129. Installing the left control panel**

#### Next steps

1. [Install the air shroud.](#)
2. [Install the backplane cover.](#)
3. [Install the front bezel.](#)
4. Follow the procedure listed in [After working inside your system](#) on page 26.

## Removing the right control panel

#### Prerequisites

1. Follow the safety guidelines listed in the [Safety instructions](#) on page 25.
2. Follow the procedure listed in [Before working inside your system](#) on page 26.
3. [Remove the front bezel.](#)
4. [Remove the backplane cover.](#)
5. [Remove the air shroud.](#)

#### Steps

1. Disconnect the control panel cable and the VGA cable from the system board connector and remove the cable from cable clip.

**i** **NOTE:** Observe the routing of the cable as you remove it from the system.

2. Using the Phillips #1 screwdriver, remove the screws that secure the right control panel assembly.
3. Hold the right control panel assembly and remove the control panel along with the cable from the system.

**i** **NOTE:** The numbers on the image do not depict the exact steps. The numbers are for representation of sequence.

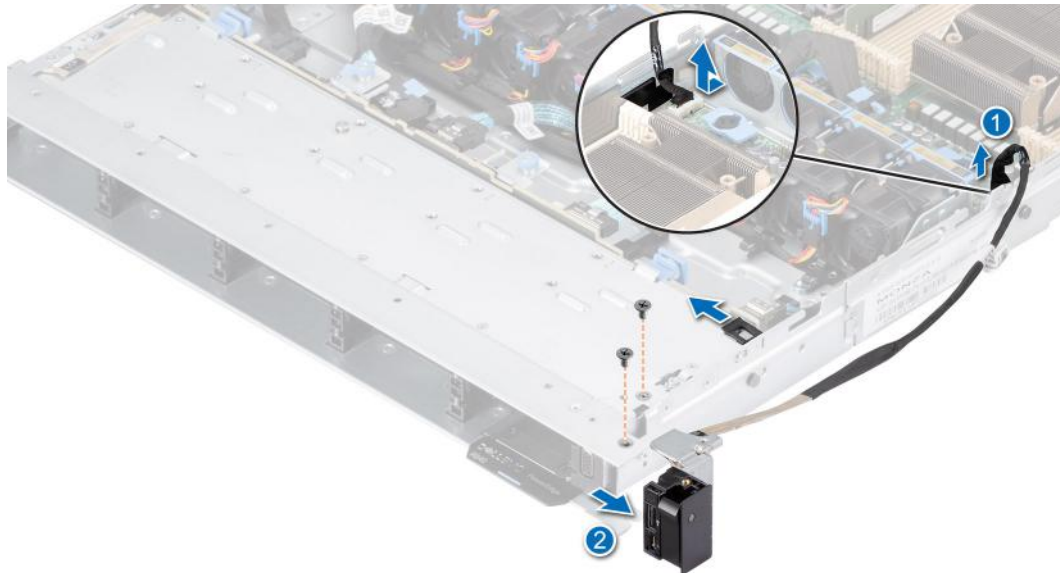

**Figure 130. Removing the right control panel**

#### Next steps

Replace the right control panel.

## Installing the right control panel

#### Prerequisites

1. Follow the safety guidelines listed in the [Safety instructions](#) on page 25.
2. Follow the procedure listed in [Before working inside your system](#) on page 26.
3. [Remove the front bezel.](#)
4. [Remove the backplane cover.](#)
5. [Remove the air shroud.](#)

#### Steps

1. Route the control panel cable through the latch, side wall of the system, and then slide the cable into the clip.

**(i) NOTE:** Route the cable properly to prevent the cable from being pinched or crimped.

2. Align and insert the right control panel in the slot on the system.
3. Connect the right control panel cable to the connector on the system board.
4. Using the Phillips #1 screwdriver, tighten the screws that secure the right control panel to the system.

**(i) NOTE:** The numbers on the image do not depict the exact steps. The numbers are for representation of sequence.



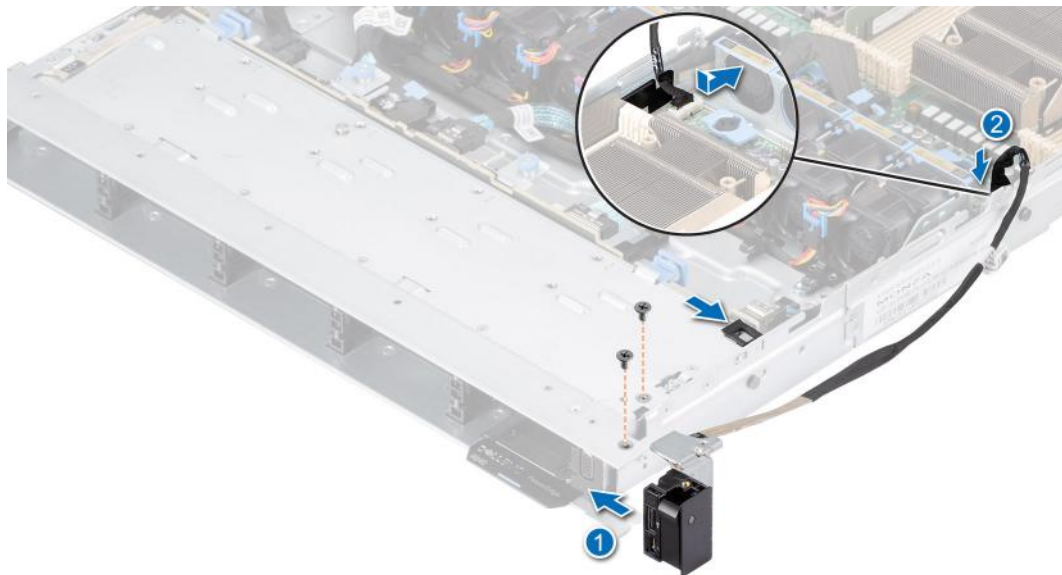

**Figure 131. Installing the right control panel**

**Next steps**

1. [Install the air shroud.](#)
2. [Install the backplane cover.](#)
3. [Install the front bezel.](#)
4. Follow the procedure listed in [After working inside your system](#) on page 26.

# Jumpers and connectors

This section provides essential and specific information about jumpers and switches. It also describes the connectors on the various boards in the system. Jumpers on the system board help to disable the system and reset the passwords. To install components and cables correctly, you must be able to identify the connectors on the system board.

## Topics:

- [System board connectors](#)
- [System board jumper settings](#)
- [Disabling a forgotten password](#)

## System board connectors

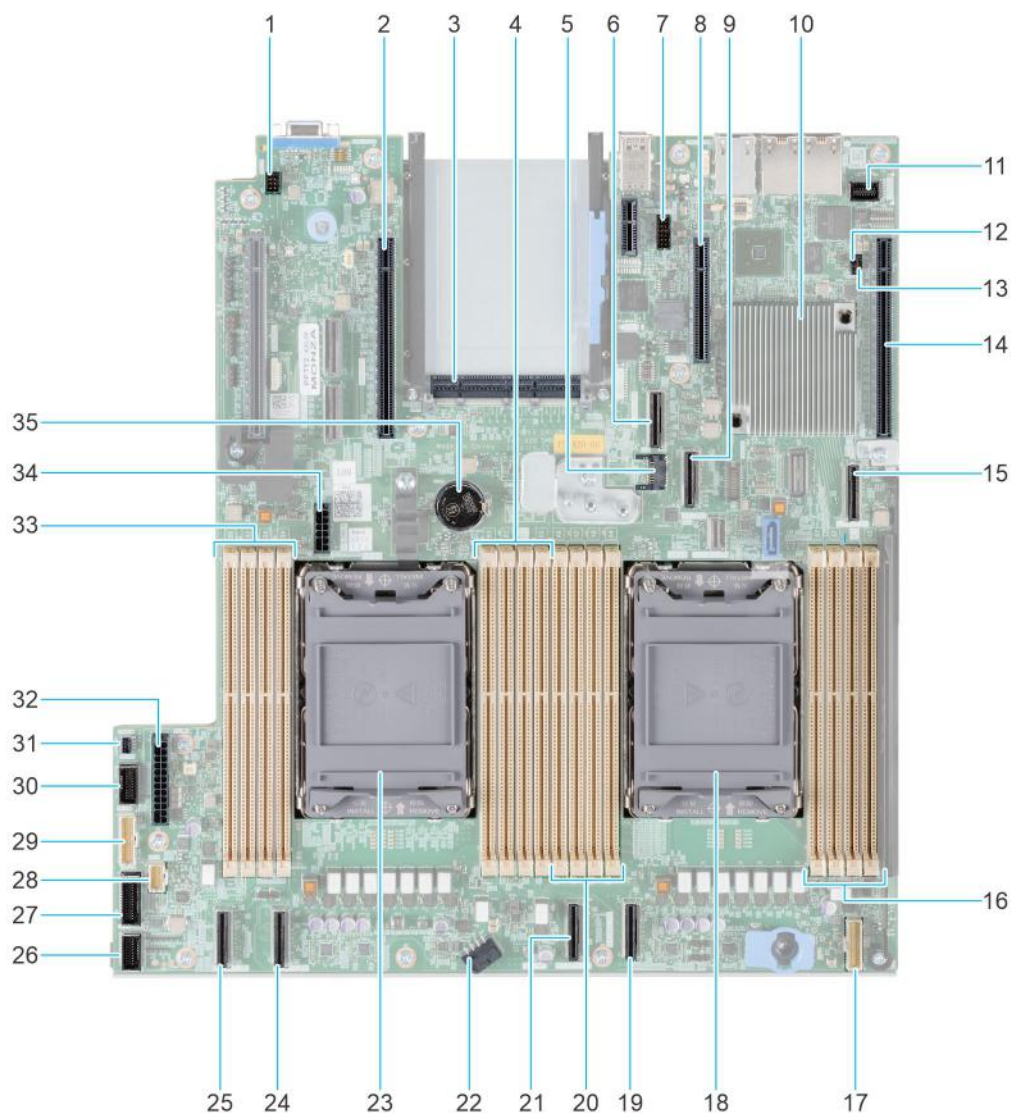

**Figure 132. System board jumpers and connectors**





1. System ID Connector
2. Riser 2 Connector (Processor 2) (2a/2b/2c)

- 3. OCP NIC 3.0 Connector
- 5. TPM Connector
- 7. Serial Port Connector
- 9. PCIe Connector 8 (SL8\_CPU1\_PB4)
- 11. Front VGA
- 13. NVRAM\_CLR(Jumpers)
- 15. SATA Connector S9 (SL9\_PCH\_SA1)
- 17. Right Control Panel
- 19. PCIe Connector 4 (SL4\_CPU1\_PA2)
- 21. PCIe Connector 3 (SL3\_CPU1\_PB2)
- 23. Processor 2
- 25. PCIe Connector 1(SL1\_CPU2\_PB1)
- 27. Fan Signal 2
- 29. PIB Signal 1
- 31. Intrusion Switch Connector
- 33. DIMMs for processor 2 Channels E, F, G, H
- 35. Coin cell battery
- 4. DIMMs for processor 2 Channels E, F, G, H
- 6. PCIe Connector 7 (SL7\_CPU1\_PA4)
- 8. BOSS Riser Slot (PCH)
- 10. PCH
- 12. PWRD\_EN (Jumpers)
- 14. Riser 1 Connector (Processor 1)
- 16. DIMMs for processor 1 Channels A, B, C, D
- 18. Processor 1
- 20. DIMMs for processor 1 Channels E, F, G, H
- 22. System Power Connector 2
- 24. PCIe Connector 2 (SL2\_CPU2\_PA1)
- 26. Fan Signal 1
- 28. Left Control Panel
- 30. PIB Signal 2
- 32. System Power Connector 1
- 34. Backplane Signal and Power 0

## System board jumper settings

For information about resetting the password jumper to disable a password, see the [Disabling a forgotten password](#) section.

**Table 37. System board jumper settings**

Jumper	Setting	Description
PWRD_EN	 (default)	The BIOS password feature is enabled.
		The BIOS password feature is disabled. The BIOS password is now disabled and you are not allowed to set a new password.
NVRAM_CLR	 (default)	The BIOS configuration settings are retained at system boot.
		The BIOS configuration settings are cleared at system boot.

**CAUTION:** Be careful when changing the BIOS settings. The BIOS interface is designed for advanced users. Any change in the setting could prevent your system from starting correctly and you might have potential loss of data.

## Disabling a forgotten password

The software security features of the system include a system password and a setup password. The password jumper enables or disables password features and clears any password(s) currently in use.

### Prerequisites

**CAUTION:** Many repairs may only be done by a certified service technician. You should only perform troubleshooting and simple repairs as authorized in your product documentation, or as directed by the online or telephone service and support team. Damage due to servicing that is not authorized by Dell is not covered by your warranty. Read and follow the safety instructions that are shipped with your product.

### Steps

1. Power off the system and all attached peripherals. Disconnect the system from the electrical outlet, and disconnect the peripherals.

2. Remove the system cover.
3. Move the jumper on the system board from pins 2 and 4 to pins 4 and 6.
4. Replace the system cover.

**i** **NOTE:** The existing passwords are not disabled (erased) until the system boots with the jumper on pins 4 and 6. However, before you assign a new system and/or setup password, you must move the jumper back to pins 2 and 4.

**i** **NOTE:** If you assign a new system and/or setup password with the jumper on pins 4 and 6, the system disables the new password(s) the next time it boots.

5. Reconnect the peripherals and connect the system to the electrical outlet, and then power on the system.
6. Power off the system.
7. Remove the system cover.
8. Move the jumper on the system board from pins 4 and 6 to pins 2 and 4.
9. Replace the system cover.
10. Reconnect the peripherals and connect the system to the electrical outlet, and then power on the system.
11. Assign a new system and/or setup password.

# System diagnostics and indicator codes

This section describes the diagnostic indicators on the system front panel that displays the system status during system startup.

## Topics:

- Status LED indicators
- System health and system ID indicator codes
- iDRAC Quick Sync 2 indicator codes
- iDRAC Direct LED indicator codes
- LCD panel
- NIC indicator codes
- Power supply unit indicator codes
- Drive indicator codes
- Using system diagnostics

## Status LED indicators



 **NOTE:** The indicators display solid amber if any error occurs.





Figure 133. Status LED indicators

Table 38. Status LED indicators and descriptions

Icon	Description	Condition	Corrective action
	Drive indicator	The indicator turns solid amber if there is a drive error.	<ul style="list-style-type: none"> <li>• Check the System Event Log to determine if the drive has an error.</li> <li>• Run the appropriate Online Diagnostics test. Restart the system and run embedded diagnostics (ePSA).</li> <li>• If the drives are configured in a RAID array, restart the system, and enter the host adapter configuration utility program.</li> </ul>
	Temperature indicator	The indicator turns solid amber if the system experiences a thermal error (for example, the ambient temperature is out of range or there is a fan failure).	<p>Ensure that none of the following conditions exist:</p> <ul style="list-style-type: none"> <li>• A cooling fan has been removed or has failed.</li> <li>• System cover, air shrouds, or back filler bracket has been removed.</li> <li>• Ambient temperature is too high.</li> <li>• External airflow is obstructed.</li> </ul> <p>If the problem persists, see the <a href="#">Getting help</a> section.</p>

**Table 38. Status LED indicators and descriptions (continued)**

Icon	Description	Condition	Corrective action
	Electrical indicator	The indicator turns solid amber if the system experiences an electrical error (for example, voltage out of range, or a failed power supply unit (PSU) or voltage regulator).	<p>Check the System Event Log or system messages for the specific issue. If it is due to a problem with the PSU, check the LED on the PSU. Reseat the PSU.</p> <p>If the problem persists, see the <a href="#">Getting help</a> section.</p>
	Memory indicator	The indicator turns solid amber if a memory error occurs.	<p>Check the System Event Log or system messages for the location of the failed memory. Reseat the memory module.</p> <p>If the problem persists, see the <a href="#">Getting help</a> section.</p>
	PCIe indicator	The indicator turns solid amber if a PCIe card experiences an error.	<p>Restart the system. Update any required drivers for the PCIe card. Reinstall the card.</p> <p>If the problem persists, see the <a href="#">Getting help</a> section.</p> <p><b>NOTE:</b> For more information about the supported PCIe cards, see the <a href="#">Expansion card installation guidelines</a> section.</p>

# System health and system ID indicator codes

The system health and system ID indicator is located on the left control panel of the system.



Figure 134. System health and system ID indicator

Table 39. System health and system ID indicator codes

System health and system ID indicator code	Condition
Solid blue	Indicates that the system is powered on, is healthy, and system ID mode is not active. Press the system health and system ID button to switch to system ID mode.
Blinking blue	Indicates that the system ID mode is active. Press the system health and system ID button to switch to system health mode.
Solid amber	Indicates that the system is in fail-safe mode. If the problem persists, see the <a href="#">Getting help</a> section.
Blinking amber	Indicates that the system is experiencing a fault. Check the System Event Log for specific error messages. For information about the event and error messages generated by the system firmware and agents that monitor system components, go to <a href="http://qrl.dell.com">qrl.dell.com</a> > <b>Look Up</b> > <b>Error Code</b> , type the error code, and then click <b>Look it up</b> .

## iDRAC Quick Sync 2 indicator codes

iDRAC Quick Sync 2 module (optional) is located on the left control panel of the system.



**Table 40. iDRAC Quick Sync 2 indicators and descriptions**

iDRAC Quick Sync 2 indicator code	Condition	Corrective action
Off (default state)	Indicates that the iDRAC Quick Sync 2 feature is powered off. Press the iDRAC Quick Sync 2 button to power on the iDRAC Quick Sync 2 feature.	If the LED fails to power on, reseal the left control panel flex cable and check. If the problem persists, see the <a href="#">Getting help</a> section.
Solid white	Indicates that iDRAC Quick Sync 2 is ready to communicate. Press the iDRAC Quick Sync 2 button to power off.	If the LED fails to power off, restart the system. If the problem persists, see the <a href="#">Getting help</a> section.
Blinks white rapidly	Indicates data transfer activity.	If the indicator continues to blink indefinitely, see the <a href="#">Getting help</a> section.
Blinks white slowly	Indicates that firmware update is in progress.	If the indicator continues to blink indefinitely, see the <a href="#">Getting help</a> section.
Blinks white five times rapidly and then powers off	Indicates that the iDRAC Quick Sync 2 feature is disabled.	Check if iDRAC Quick Sync 2 feature is configured to be disabled by iDRAC. If the problem persists, see the <a href="#">Getting help</a> section. <a href="http://www.dell.com/poweredge manuals">www.dell.com/poweredge manuals</a> or <i>Dell OpenManage Server Administrator User's Guide</i> at <a href="https://www.dell.com/openmanagemanuals">https://www.dell.com/openmanagemanuals</a> .
Solid amber	Indicates that the system is in fail-safe mode.	Restart the system. If the problem persists, see the <a href="#">Getting help</a> section.
Blinking amber	Indicates that the iDRAC Quick Sync 2 hardware is not responding properly.	Restart the system. If the problem persists, see the <a href="#">Getting help</a> section.

## iDRAC Direct LED indicator codes

The iDRAC Direct LED indicator lights up to indicate that the port is connected and is being used as a part of the iDRAC subsystem.

You can configure iDRAC Direct by using a USB to micro USB (type AB) cable, which you can connect to your laptop or tablet. Cable length should not exceed 3 feet (0.91 meters). Performance could be affected by cable quality. The following table describes iDRAC Direct activity when the iDRAC Direct port is active:

**Table 41. iDRAC Direct LED indicator codes**

iDRAC Direct LED indicator code	Condition
Solid green for two seconds	Indicates that the laptop or tablet is connected.
Blinking green (on for two seconds and off for two seconds)	Indicates that the laptop or tablet connected is recognized.
LED Indicator off	Indicates that the laptop or tablet is unplugged.

## LCD panel

The LCD panel provides system information, status, and error messages to indicate if the system is functioning correctly or requires attention. The LCD panel is used to configure or view the iDRAC IP address of the system. For information about the event and error messages generated by the system firmware and agents that monitor system components, go to [qrl.dell.com](http://qrl.dell.com) >

**Look Up > Error Code**, type the error code, and then click **Look it up**..



The LCD panel is available only on the optional front bezel. The optional front bezel is hot pluggable.

The status and conditions of the LCD panel are outlined here:

- The LCD backlight is white during normal operating conditions.
- If there is an issue, the LCD backlight turns amber and displays an error code followed by descriptive text.
  - ① **NOTE:** If the system is connected to a power source and an error is detected, the LCD turns amber regardless of whether the system is powered on or off.
- When the system powers off and there are no errors, the LCD enters the standby mode after five minutes of inactivity. Press any button on the LCD to power it on.
- If the LCD panel stops responding, remove the bezel and reinstall it.
  - If the problem persists, see [Getting help](#).
- The LCD backlight remains off if LCD messaging is powered off using the iDRAC utility, the LCD panel, or other tools.



Figure 135. LCD panel features



Table 42. LCD panel features

Item	Button or display	Description
1	Left	Moves the cursor back in one-step increments.
2	Select	Selects the menu item highlighted by the cursor.
3	Right	Moves the cursor forward in one-step increments.  During message scrolling: <ul style="list-style-type: none"> <li>• Press and hold the right button to increase scrolling speed.</li> <li>• Release the button to stop.</li> </ul> ① <b>NOTE:</b> The display stops scrolling when the button is released. After 45 seconds of inactivity, the display starts scrolling.
4	LCD display	Displays the system information, status, and error messages or iDRAC IP address.

## Viewing Home screen

The **Home** screen displays user-configurable information about the system. This screen is displayed during normal system operation when there are no status messages or errors. When the system turns off and there are no errors, LCD enters the standby mode after five minutes of inactivity. Press any button on the LCD to turn it on.

### Steps

1. To view the **Home** screen, press one of the three navigation buttons (Select, Left, or Right).
2. To navigate to the **Home** screen from another menu, complete the following steps:
  - a. Press and hold the navigation button till the up arrow  is displayed.
  - b. Navigate to the **Home** icon  using the up arrow .
  - c. Select the **Home** icon.
  - d. On the **Home** screen, press the **Select** button to enter the main menu.

## Setup menu

① **NOTE:** When you select an option in the Setup menu, you must confirm the option before proceeding to the next action.

**Table 43. Setup menu**

Option	Description
iDRAC	Select <b>DHCP</b> or <b>Static IP</b> to configure the network mode. If <b>Static IP</b> is selected, the available fields are <b>IP</b> , <b>Subnet (Sub)</b> , and <b>Gateway (Gtw)</b> . Select <b>Setup DNS</b> to enable DNS and to view domain addresses. Two separate DNS entries are available.
Set error	Select <b>SEL</b> to view LCD error messages in a format that matches the IPMI description in the SEL. This enables you to match an LCD message with an SEL entry. Select <b>Simple</b> to view LCD error messages in a simplified user-friendly description. For information about the event and error messages generated by the system firmware and agents that monitor system components, go to <a href="http://qrl.dell.com">qrl.dell.com</a> > <b>Look Up</b> > <b>Error Code</b> , type the error code, and then click <b>Look it up</b> .
Set home	Select the default information to be displayed on the <b>Home</b> screen. See <a href="#">View menu</a> section for the options and option items that can be set as the default on the <b>Home</b> screen.

## View menu

**NOTE:** When you select an option in the View menu, you must confirm the option before proceeding to the next action.

**Table 44. View menu**

Option	Description
iDRAC IP	Displays the <b>IPv4</b> or <b>IPv6</b> addresses for iDRAC9. Addresses include <b>DNS (Primary and Secondary)</b> , <b>Gateway, IP</b> , and <b>Subnet</b> (IPv6 does not have Subnet).
MAC	Displays the MAC addresses for <b>iDRAC</b> , <b>iSCSI</b> , or <b>Network</b> devices.
Name	Displays the name of the <b>Host</b> , <b>Model</b> , or <b>User String</b> for the system.
Number	Displays the <b>Asset tag</b> or the <b>Service tag</b> for the system.
Power	Displays the power output of the system in BTU/hr or Watts. The display format can be configured in the <b>Set home</b> submenu of the <b>Setup</b> menu.
Temperature	Displays the temperature of the system in Celsius or Fahrenheit. The display format can be configured in the <b>Set home</b> submenu of the <b>Setup</b> menu.

## NIC indicator codes

Each NIC on the back of the system has indicators that provide information about the activity and link status. The activity LED indicator indicates if data is flowing through the NIC, and the link LED indicator indicates the speed of the connected network.

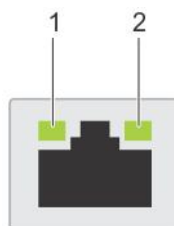

**Figure 136. NIC indicator codes**

1. Link LED indicator
2. Activity LED indicator

**Table 45. NIC indicator codes**

NIC indicator codes	Condition
Link and activity indicators are off.	Indicates that the NIC is not connected to the network.

**Table 45. NIC indicator codes (continued)**

NIC indicator codes	Condition
Link indicator is green, and activity indicator is blinking green.	Indicates that the NIC is connected to a valid network at its maximum port speed, and data is being sent or received.
Link indicator is amber, and activity indicator is blinking green.	Indicates that the NIC is connected to a valid network at less than its maximum port speed, and data is being sent or received.
Link indicator is green, and activity indicator is off.	Indicates that the NIC is connected to a valid network at its maximum port speed, and data is not being sent or received.
Link indicator is amber, and activity indicator is off.	Indicates that the NIC is connected to a valid network at less than its maximum port speed, and data is not being sent or received.
Link indicator is blinking green, and activity is off.	Indicates that the NIC identity is enabled through the NIC configuration utility.

## Power supply unit indicator codes

AC and DC power supply units (PSUs) have an illuminated translucent handle that serves as an indicator. The indicator shows if power is present or if a power fault has occurred.

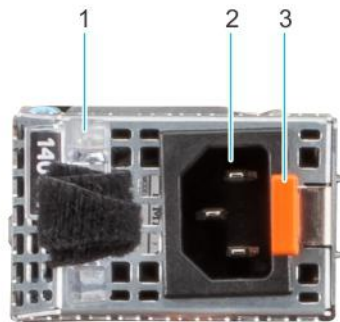

**Figure 137. AC PSU status indicator**

1. AC PSU handle
2. Socket
3. Release latch

**Table 46. AC PSU status indicator codes**

Power indicator codes	Condition
Green	Indicates that a valid power source is connected to the PSU and the PSU is operational.
Blinking amber	Indicates an issue with the PSU.
Not powered on	Indicates that the power is not connected to the PSU.
Blinking green	Indicates that the firmware of the PSU is being updated. <b>⚠ CAUTION: Do not disconnect the power cord or unplug the PSU when updating firmware. If firmware update is interrupted, the PSUs will not function.</b>
Blinking green and powers off	When hot-plugging a PSU, it blinks green five times at a rate of 4 Hz and powers off. This indicates a PSU mismatch due to efficiency, feature set, health status, or supported voltage. <b>⚠ CAUTION: If two PSUs are installed, both the PSUs must have the same type of label; for example, Extended Power Performance (EPP) label. Mixing PSUs from previous generations of PowerEdge servers is not supported, even if the PSUs have the</b>

**Table 46. AC PSU status indicator codes (continued)**

Power indicator codes	Condition
	<p>same power rating. This results in a PSU mismatch condition or failure to power on the system.</p> <p>△ <b>CAUTION:</b> If two PSUs are used, they must be of the same type and have the same maximum output power.</p> <p>△ <b>CAUTION:</b> When correcting a PSU mismatch, replace the PSU with the blinking indicator. Swapping the PSU to make a matched pair can result in an error condition and an unexpected system shutdown. To change from a high output configuration to a low output configuration or vice versa, you must power off the system.</p> <p>△ <b>CAUTION:</b> AC PSUs support both 240 V and 120 V input voltages with the exception of Titanium PSUs, which support only 240 V. When two identical PSUs receive different input voltages, they can output different wattages, and trigger a mismatch.</p>

**Table 47. DC PSU status indicator codes**

Power indicator codes	Condition
Green	Indicates that a valid power source is connected to the PSU, and the PSU is operational.
Blinking amber	Indicates an issue with the PSU.
Not powered on	Indicates that the power is not connected to the PSU.
Blinking green	<p>When hot-plugging a PSU, it blinks green five times at a rate of 4 Hz and powers off. This indicates a PSU mismatch due to efficiency, feature set, health status, or supported voltage.</p> <p>△ <b>CAUTION:</b> If two PSUs are installed, both the PSUs must have the same type of label; for example, Extended Power Performance (EPP) label. Mixing PSUs from previous generations of PowerEdge servers is not supported, even if the PSUs have the same power rating. This results in a PSU mismatch condition, or failure to power on the system.</p> <p>△ <b>CAUTION:</b> If two PSUs are used, they must be of the same type and have the same maximum output power.</p> <p>△ <b>CAUTION:</b> When correcting a PSU mismatch, replace the PSU with the blinking indicator. Swapping the PSU to make a matched pair can result in an error condition and an unexpected system shutdown. To change from a High Output configuration to a Low Output configuration or conversely, you must power off the system.</p> <p>△ <b>CAUTION:</b> Combining AC and DC PSUs is not supported.</p>

# Drive indicator codes

The LEDs on the drive carrier indicate the state of each drive. Each drive carrier has two LEDs: an activity LED (green) and a status LED (bicolor, green/amber). The activity LED blinks whenever the drive is accessed.



**Figure 138. Drive indicators**

- 1. Drive activity LED indicator
- 2. Drive status LED indicator
- 3. Drive capacity label

**NOTE:** If the drive is in the Advanced Host Controller Interface (AHCI) mode, the status LED indicator does not power on.

**NOTE:** Drive status indicator behavior is managed by Storage Spaces Direct. Not all drive status indicators may be used.

**Table 48. Drive indicator codes**

Drive status indicator code	Condition
Blinks green twice per second	Indicates that the drive is being identified or preparing for removal.
Off	Indicates that the drive is ready for removal. <b>NOTE:</b> The drive status indicator remains off until all drives are initialized after the system is powered on. Drives are not ready for removal during this time.
Blinks green, amber, and then powers off	Indicates that there is an unexpected drive failure.
Blinks amber four times per second	Indicates that the drive has failed.
Blinks green slowly	Indicates that the drive is rebuilding.
Solid green	Indicates that the drive is online.
Blinks green for three seconds, amber for three seconds, and then powers off after six seconds	Indicates that the rebuild has stopped.

## Using system diagnostics

If you experience an issue with the system, run the system diagnostics before contacting Dell for technical assistance. The purpose of running system diagnostics is to test the system hardware without using additional equipment or risking data loss. If you are unable to fix the issue yourself, service and support personnel can use the diagnostics results to help you solve the issue.

## Dell Embedded System Diagnostics

**NOTE:** The Dell Embedded System Diagnostics is also known as Enhanced Pre-boot System Assessment (ePSA) diagnostics.

The Embedded System Diagnostics provide a set of options for particular device groups or devices allowing you to:

- Run tests automatically or in an interactive mode
- Repeat tests

- Display or save test results
- Run thorough tests to introduce additional test options to provide extra information about the failed device(s)
- View status messages that inform you if tests are completed successfully
- View error messages that inform you of issues encountered during testing

## Running the Embedded System Diagnostics from the Dell Lifecycle Controller

### Steps

1. When the system is booting, press F10.
2. Select **Hardware Diagnostics** → **Run Hardware Diagnostics**.  
The **ePSA Pre-boot System Assessment** window is displayed, listing all devices detected in the system. The diagnostics start executing the tests on all the detected devices.

## Running the Embedded System Diagnostics from Boot Manager

Run the Embedded System Diagnostics (ePSA) if your system does not boot.

### Steps

1. When the system is booting, press F11.
2. Use the up arrow and down arrow keys to select **System Utilities** > **Launch Diagnostics**.
3. Alternatively, when the system is booting, press F10, select **Hardware Diagnostics** > **Run Hardware Diagnostics**.  
The **ePSA Pre-boot System Assessment** window is displayed, listing all devices detected in the system. The diagnostics starts executing the tests on all the detected devices.

## System diagnostic controls

**Table 49. System diagnostic controls**

Menu	Description
<b>Configuration</b>	Displays the configuration and status information of all detected devices.
<b>Results</b>	Displays the results of all tests that are run.
<b>System health</b>	Provides the current overview of the system performance.
<b>Event log</b>	Displays a time-stamped log of the results of all tests run on the system. This is displayed if at least one event description is recorded.

# Getting help

## Topics:

- [Recycling or End-of-Life service information](#)
- [Contacting Dell Technologies](#)
- [Accessing system information by using QRL](#)
- [Receiving automated support with SupportAssist](#)

## Recycling or End-of-Life service information

Take back and recycling services are offered for this product in certain countries. If you want to dispose of system components, visit [www.dell.com/recyclingworldwide](http://www.dell.com/recyclingworldwide) and select the relevant country.

## Contacting Dell Technologies

Dell provides online and telephone based support and service options. If you do not have an active internet connection, you can find Dell contact information on your purchase invoice, packing slip, bill or Dell product catalog. The availability of services varies depending on the country and product, and some services may not be available in your area. To contact Dell for sales, technical assistance, or customer service issues follow these steps:

### Steps

1. Go to [www.dell.com/support/home](http://www.dell.com/support/home).
2. Select your country from the drop-down menu on the lower right corner of the page.
3. For customized support:
  - a. Enter the system Service Tag in the **Enter a Service Tag, Serial Number, Service Request, Model, or Keyword** field.
  - b. Click **Search**.  
The support page that lists the various support categories is displayed.
4. For general support:
  - a. Select your product category.
  - b. Select your product segment.
  - c. Select your product.  
The support page that lists the various support categories is displayed.
5. For contact details of Dell Global Technical Support:
  - a. Click [Contact Technical Support](#).
  - b. The **Contact Technical Support** page is displayed with details to call, chat, or e-mail the Dell Global Technical Support team.

## Accessing system information by using QRL

You can use the Quick Resource Locator (QRL) located on the information tag in the front of the R650xs system, to access information about Dell EMC PowerEdge R650xs. There is also another QRL for accessing product information located on the back of the system cover.

### Prerequisites

Ensure that your smartphone or tablet has a QR code scanner installed.

The QRL includes the following information about your system:

- How-to videos
- Reference materials, including the Installation and Service Manual, LCD diagnostics, and mechanical overview
- The system service tag to quickly access the specific hardware configuration and warranty information
- A direct link to Dell to contact technical assistance and sales teams

### Steps

1. Go to [www.dell.com/qrl](http://www.dell.com/qrl), and navigate to your specific product or
2. Use your smart phone or tablet to scan the model-specific Quick Resource (QR) code on your system or in the Quick Resource Locator section.

## Quick Resource Locator for PowerEdge R650xs system



Figure 139. Quick Resource Locator for PowerEdge R650xs system

## Receiving automated support with SupportAssist

Dell EMC SupportAssist is an optional Dell EMC Services offering that automates technical support for your Dell EMC server, storage, and networking devices. By installing and setting up a SupportAssist application in your IT environment, you can receive the following benefits:

- Automated issue detection — SupportAssist monitors your Dell EMC devices and automatically detects hardware issues, both proactively and predictively.
- Automated case creation — When an issue is detected, SupportAssist automatically opens a support case with Dell EMC Technical Support.
- Automated diagnostic collection — SupportAssist automatically collects system state information from your devices and uploads it securely to Dell EMC. This information is used by Dell EMC Technical Support to troubleshoot the issue.
- Proactive contact — A Dell EMC Technical Support agent contacts you about the support case and helps you resolve the issue.

The available benefits vary depending on the Dell EMC Service entitlement purchased for your device. For more information about SupportAssist, go to [www.dell.com/supportassist](http://www.dell.com/supportassist).



## Documentation resources

This section provides information about the documentation resources for your system.

To view the document that is listed in the documentation resources table:

- From the Dell EMC support site:
  1. Click the documentation link that is provided in the Location column in the table.
  2. Click the required product or product version.
-  **NOTE:** To locate the model number, see the front of your system.
- 3. On the Product Support page, click **Documentation**.
- Using search engines:
  - Type the name and version of the document in the search box.

**Table 50. Additional documentation resources for your system**

Task	Document	Location
Setting up your system	<p>For more information about installing and securing the system into a rack, see the Rail Installation Guide included with your rail solution.</p> <p>For information about setting up your system, see the <i>Getting Started Guide</i> document that is shipped with your system.</p>	<a href="http://www.dell.com/poweredgemanuals">www.dell.com/poweredgemanuals</a>
Configuring your system	<p>For information about the iDRAC features, configuring and logging in to iDRAC, and managing your system remotely, see the Integrated Dell Remote Access Controller User's Guide.</p> <p>For information about understanding Remote Access Controller Admin (RACADM) subcommands and supported RACADM interfaces, see the RACADM CLI Guide for iDRAC.</p> <p>For information about Redfish and its protocol, supported schema, and Redfish Eventing implemented in iDRAC, see the Redfish API Guide.</p> <p>For information about iDRAC property database group and object descriptions, see the Attribute Registry Guide.</p> <p>For information about Intel QuickAssist Technology, see the Integrated Dell Remote Access Controller User's Guide.</p>	<a href="http://www.dell.com/poweredgemanuals">www.dell.com/poweredgemanuals</a>
	<p>For information about earlier versions of the iDRAC documents.</p> <p>To identify the version of iDRAC available on your system, on the iDRAC web interface, click <b>? &gt; About</b>.</p>	<a href="http://www.dell.com/idracmanuals">www.dell.com/idracmanuals</a>

**Table 50. Additional documentation resources for your system (continued)**

Task	Document	Location
	For information about installing the operating system, see the operating system documentation.	<a href="http://www.dell.com/operatingsystemmanuals">www.dell.com/operatingsystemmanuals</a>
	For information about updating drivers and firmware, see the Methods to download firmware and drivers section in this document.	<a href="http://www.dell.com/support/drivers">www.dell.com/support/drivers</a>
Managing your system	For information about systems management software offered by Dell, see the Dell OpenManage Systems Management Overview Guide.	<a href="http://www.dell.com/poweredgemanuals">www.dell.com/poweredgemanuals</a>
	For information about setting up, using, and troubleshooting OpenManage, see the Dell OpenManage Server Administrator User's Guide.	<a href="http://www.dell.com/openmanagemanuals">www.dell.com/openmanagemanuals</a> > OpenManage Server Administrator
	For information about installing and using Dell SupportAssist, see the Dell EMC SupportAssist Enterprise User's Guide.	<a href="https://www.dell.com/serviceabilitytools">https://www.dell.com/serviceabilitytools</a>
	For information about partner programs enterprise systems management, see the OpenManage Connections Enterprise Systems Management documents.	<a href="http://www.dell.com/openmanagemanuals">www.dell.com/openmanagemanuals</a>
Working with the Dell PowerEdge RAID controllers	For information about understanding the features of the Dell PowerEdge RAID controllers (PERC), Software RAID controllers, or BOSS card and deploying the cards, see the Storage controller documentation.	<a href="http://www.dell.com/storagecontrollermanuals">www.dell.com/storagecontrollermanuals</a>
Understanding event and error messages	For information about the event and error messages generated by the system firmware and agents that monitor system components, go to <a href="http://qrl.dell.com">qrl.dell.com</a> > <b>Look Up</b> > <b>Error Code</b> , type the error code, and then click <b>Look it up</b> .	<a href="http://www.dell.com/qrl">www.dell.com/qrl</a>
Troubleshooting your system	For information about identifying and troubleshooting the PowerEdge server issues, see the Server Troubleshooting Guide.	<a href="http://www.dell.com/poweredgemanuals">www.dell.com/poweredgemanuals</a>