

# Dell PowerEdge T350

## Technical Guide

## Notes, cautions, and warnings

 **NOTE:** A NOTE indicates important information that helps you make better use of your product.

 **CAUTION:** A CAUTION indicates either potential damage to hardware or loss of data and tells you how to avoid the problem.

 **WARNING:** A WARNING indicates a potential for property damage, personal injury, or death.

<b>Chapter 1: System overview</b> .....	<b>5</b>
Key workloads.....	5
New technologies.....	5
<b>Chapter 2: System features and generational comparison</b> .....	<b>7</b>
<b>Chapter 3: Chassis views and features</b> .....	<b>9</b>
Chassis views.....	9
Front view of the system.....	9
Rear view of the system.....	11
Inside the system.....	13
Quick Resource Locator.....	15
<b>Chapter 4: Processor</b> .....	<b>16</b>
Processor features .....	16
Supported processors.....	16
<b>Chapter 5: Memory subsystem</b> .....	<b>18</b>
Supported memory.....	18
Memory speed.....	18
<b>Chapter 6: Storage</b> .....	<b>19</b>
Storage controllers.....	19
Supported Drives.....	19
Internal storage configuration.....	20
External storage.....	20
<b>Chapter 7: Networking</b> .....	<b>21</b>
Overview.....	21
<b>Chapter 8: Expansion cards</b> .....	<b>22</b>
Expansion card installation guidelines.....	22
<b>Chapter 9: Power, thermal, and acoustics</b> .....	<b>24</b>
Power.....	24
Thermal.....	25
Acoustics.....	25
Acoustical performance.....	25
<b>Chapter 10: Supported operating systems</b> .....	<b>27</b>
<b>Chapter 11: Dell EMC OpenManage systems management</b> .....	<b>28</b>
Server and Chassis Managers.....	29

Dell EMC consoles.....	29
Automation Enablers.....	29
Integration with third-party consoles.....	29
Connections for third-party consoles.....	29
Dell EMC Update Utilities.....	29
Dell resources.....	29
<b>Chapter 12: Dell Technologies Services .....</b>	<b>31</b>
Dell EMC ProDeploy Enterprise Suite .....	31
Dell EMC ProDeploy Plus.....	32
Dell EMC ProDeploy.....	32
Basic Deployment.....	32
Dell EMC Server Configuration Services.....	32
Dell EMC Residency Services.....	32
Dell EMC Remote Consulting Services.....	32
Dell EMC Data Migration Service.....	32
Dell EMC ProSupport Enterprise Suite.....	32
Dell EMC ProSupport Plus for Enterprise.....	33
Dell EMC ProSupport for Enterprise.....	33
Dell EMC ProSupport One for Data Center.....	34
ProSupport for HPC.....	34
Support Technologies.....	35
Dell Technologies Education Services.....	36
Dell Technologies Consulting Services.....	36
Dell EMC Managed Services.....	36
<b>Chapter 13: Appendix A: Additional specifications.....</b>	<b>37</b>
Chassis dimension.....	37
Chassis weight.....	38
Video specifications.....	38
USB Ports.....	38
Power Supply Units.....	38
Environmental specifications.....	39
Thermal air restrictions.....	40
<b>Chapter 14: Appendix B. Standards compliance.....</b>	<b>41</b>
<b>Chapter 15: Appendix C Additional resources.....</b>	<b>42</b>

# System overview

The Dell™ PowerEdge™ T350 is Dell's latest single-socket, entry-level 4.5U scalable tower server that is purposely designed to serve general-purpose business applications for both Small and Medium Businesses (SMB) and Remote Office / Branch Office (ROBO).

The system features:

- One Intel® Xeon® E-2300 series processor with up to 8 cores per processor
- Four DDR4 DIMM slots, supports UDIMM 128 GB max, speeds up to 3200 MT/s
- Up to 8 x 3.5-inch SAS/SATA HDD/SSD drives
- Front access hot-plug BOSS -S2
- Internal Boot: IDSDM or internal USB board
- RAID: PERC 10.5 and PERC 11 SW and HW RAID
- Onboard LOM 1GbE x2
- PCI Express® (PCIe) 4.0 expansion slots
- iDRAC9 with Lifecycle controller; Express, Enterprise, Datacenter, and OME advanced feature
- Cabled AC or two redundant Hot-plug AC/DC power supply units

## Topics:

- [Key workloads](#)
- [New technologies](#)



## Key workloads

PowerEdge T350 is designed to deliver higher performance technologies in a management-friendly enclosure that includes:

- Collaboration
- File sharing
- Database
- Mail/messaging services
- Backup/recovery
- Web hosting
- Video surveillance

## New technologies

**Table 1. New technologies**

Technology	Detailed Description
Intel® Xeon® E-2300 series processor	Core count: Up to 8 cores per processor
3200 MT/s DDR4 Memory	<ul style="list-style-type: none"> <li>• 4 DDR4 DIMM slots, supports UDIMM 128 GB max, speeds up to 3200 MT/s</li> <li>•  <b>NOTE:</b> DIMM speed is limited to 2933 MT/s when mixing dual rank DIMMs with single rank or dual rank DIMMs in the same channel.</li> <li>•  <b>NOTE:</b> For Pentium processor, maximum memory supported is 2666 MT/s.</li> </ul>
Flex I/O	<ul style="list-style-type: none"> <li>• LOM board, 2x 1 GB with BCM5720 LAN controller</li> <li>• Rear I/O with 1 GB Dedicated Management Network Port, USB 3.0 x1, USB 2.0 x5, and VGA port</li> <li>• Serial port</li> </ul>

**Table 1. New technologies (continued)**

<b>Technology</b>	<b>Detailed Description</b>
Chipset (CHPST)	Intel C250 series
Dedicated PERC	PERC 10.5 and PERC 11 SW and HW RAID
iDRAC9 w/ Lifecycle Controller	The embedded systems management solution for Dell servers features hardware and firmware inventory and alerting, in-depth memory alerting, faster performance, a dedicated gigabit port and many more features.
Power supplies	<ul style="list-style-type: none"><li>• 450W Bronze 100-240 VAC, cabled</li><li>• 600W Platinum 100-240 VAC or 240 VDC, hot swap redundant</li><li>• 700 W Titanium 100-240 V AC or 240 HVDC redundant, cabled</li></ul>

## System features and generational comparison

The following table shows the comparison between the PowerEdge T350 with the PowerEdge T340:

**Table 2. Feature comparison**

Feature	PowerEdge T350	PowerEdge T340
Processor	Maximum one Intel® Xeon® E-2300 series processor with up to 8 cores, or Intel Pentium processors with up to 2 cores	Maximum one Intel® Xeon® E-2200 product family processor with up to 8 cores per processor  Maximum one Intel® Pentium® G5420 processor up to 2 cores per processor  Maximum one Intel® Core i3® 9100 processor up to 4 cores per processor  Maximum one Intel® Celeron® G4930 processor up to 2 cores per processor
Memory	<ul style="list-style-type: none"> <li>4 DDR4 DIMM slots, supports UDIMM 128 GB max, speeds up to 3200 MT/s</li> </ul> <p><b>i</b> <b>NOTE:</b> DIMM speed is limited to 2933 MT/s when mixing dual rank DIMMs with single rank or dual rank DIMMs in the same channel.</p> <p><b>i</b> <b>NOTE:</b> For Pentium processor, maximum memory supported is 2666 MT/s.</p>	<ul style="list-style-type: none"> <li>4 DDR4 DIMM slots, supports UDIMM 64 GB max, speeds up to 2666 MT/s</li> <li>Supports registered ECC DDR4 DIMMs only</li> </ul>
Storage Drives	<p>Front bays:</p> <ul style="list-style-type: none"> <li>Up to 8 x 3.5-inch SAS/SATA (HDD/SSD)</li> <li>Maximum capacity 160 TB on 8 HDD configuration</li> </ul> <p><b>i</b> <b>NOTE:</b> Supports 2.5-inch drive in 3.5-inch hybrid drive carrier.</p>	<p>Front bays:</p> <ul style="list-style-type: none"> <li>Up to 8 x 3.5-inch SAS/SATA (HDD), max 112 TB (Also supports up to 8 x 2.5-inch SAS/SATA (HDD) in 3.5-inch hybrid drive carrier)</li> </ul>
Storage Controllers	<p>Internal controllers: PERC H345, PERC H355, HBA355i, PERC H755</p> <p>External HBA (non-RAID): HBA355e</p> <p>Internal Boot: Boot Optimized Storage Subsystem (BOSS-S2): HWRAID 2 x M.2 SSDs</p> <p>Software RAID: S150</p>	<p>Internal controllers: PERC H330, H730p, HBA330</p> <p>External controllers: 12 Gbps SAS HBA</p> <p>Internal Boot: Boot Optimized Storage Subsystem (BOSS): 2 x M.2 240 GB (RAID 1 or No RAID) and 1 x M.2 240 GB (No RAID only)</p> <p>Software RAID: S140</p>
PCIe Slots	<p>4 PCIe slots:</p> <ul style="list-style-type: none"> <li>1 x16 Gen4 (x16 connector) full height, full length</li> <li>1 x4 Gen4 (x8 connector) full height, half length</li> <li>1 x4 Gen3 (x8 connector) full height, half length</li> <li>1 x1 Gen3 (x1 connector) full height, half length</li> </ul>	4 x PCIe Gen 3 slots

**Table 2. Feature comparison (continued)**

<b>Feature</b>	<b>PowerEdge T350</b>	<b>PowerEdge T340</b>
Embedded NIC (LOM)	2 x 1 GbE	2 x 1 GbE
Networking options (OCP 3.0)	NA	NA
Ports	<p>Front Ports</p> <ul style="list-style-type: none"> <li>• 1 x iDRAC Direct (Micro-AB USB) port</li> <li>• 1 x USB 3.0</li> </ul> <p>Rear Ports</p> <ul style="list-style-type: none"> <li>• 5 x USB 2.0</li> <li>• 1 x iDRAC ethernet port</li> <li>• 1 x USB 3.0</li> <li>• 1 x VGA</li> <li>• 1 x Serial</li> </ul> <p>Internal Ports</p> <ul style="list-style-type: none"> <li>• 1 x USB 3.0 (Optional)</li> </ul>	<p>Front Ports</p> <ul style="list-style-type: none"> <li>• 1 x Micro USB 2.0 (Dedicated iDRAC direct)</li> <li>• 1 x USB 3.0</li> </ul> <p>Rear Ports</p> <ul style="list-style-type: none"> <li>• 4 x USB 2.0</li> <li>• 2 x USB 3.0</li> <li>• 1 x VGA</li> </ul> <p>Internal Ports</p> <ul style="list-style-type: none"> <li>• 1 x USB 3.0</li> </ul>
Form Factor	4.5U	5U
Power Supplies	<ul style="list-style-type: none"> <li>• 450W Bronze 100-240 VAC, cabled</li> <li>• 600W Platinum 100-240 VAC or 240 VDC, hot swap redundant</li> <li>• 700 W Titanium 100-240 V AC or 240 HVDC redundant, cabled</li> </ul>	<ul style="list-style-type: none"> <li>• 495 W Platinum (Hot plug redundant)</li> <li>• 350 W Bronze (Cable)</li> </ul>
Embedded Management	<ul style="list-style-type: none"> <li>• iDRAC9</li> <li>• iDRAC Direct</li> <li>• iDRAC RESTful API with Redfish</li> <li>• iDRAC Service Module</li> </ul>	<ul style="list-style-type: none"> <li>• iDRAC9</li> <li>• iDRAC Direct</li> <li>• iDRAC RESTful API with Redfish</li> </ul>
Front IO	<ul style="list-style-type: none"> <li>• Power button w/LED x1</li> <li>• ID button w/LED x1</li> <li>• USB 3.0 x1</li> <li>• iDRAC MGMT USB x1</li> <li>• System Status LED x1</li> </ul>	<ul style="list-style-type: none"> <li>• Power button w/LED x1</li> <li>• ID button w/LED x1</li> <li>• USB 3.0 x1</li> <li>• iDRAC MGMT USB x1</li> <li>• System Status LED x1</li> </ul>
Availability	<ul style="list-style-type: none"> <li>• Hot-plug Drives</li> <li>• Hot-plug Redundant Power Supplies</li> <li>• Internal Dual SD Module (IDSDM)</li> </ul>	<ul style="list-style-type: none"> <li>• Hot-plug Drives</li> <li>• Hot-plug Redundant Power Supplies</li> <li>• Internal Dual SD Module (IDSDM)</li> </ul>



# Chassis views and features

## Topics:

- Chassis views

## Chassis views

### Front view of the system

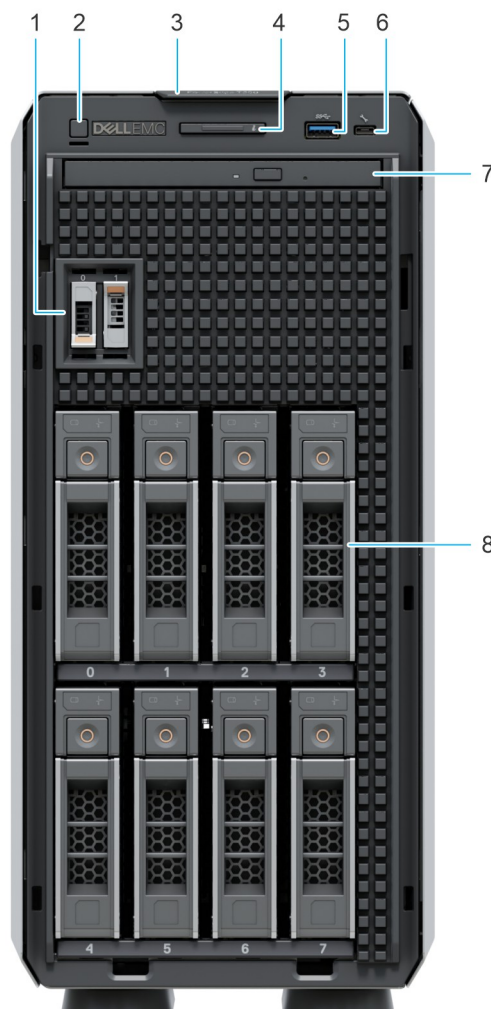
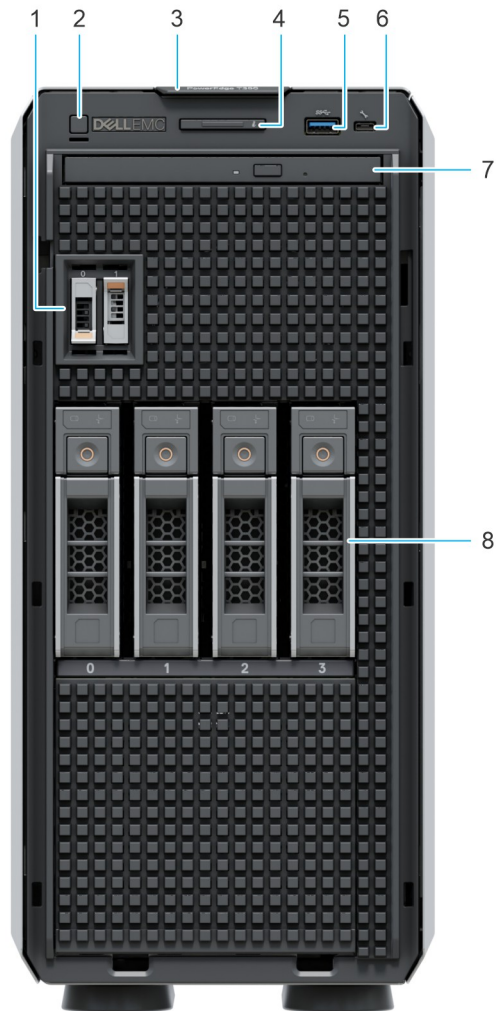

Figure 1. Front view of the 8 x 3.5-inch drive system

1. BOSS S2 module (optional)
2. Power button
3. Information tag
4. System health and ID indicator
5. USB 3.0 port
6. iDRAC Direct port (Micro-AB USB)
7. Optical drive (optional)
8. Drives (8)



**Figure 2. Front view of the 4 x 3.5-inch drive system**

1. BOSS S2 module (optional)
2. Power button
3. Information tag
4. System health and ID indicator
5. USB 3.0 port
6. iDRAC Direct port (Micro-AB USB)
7. Optical drive (optional)
8. Drives (4)

## Rear view of the system

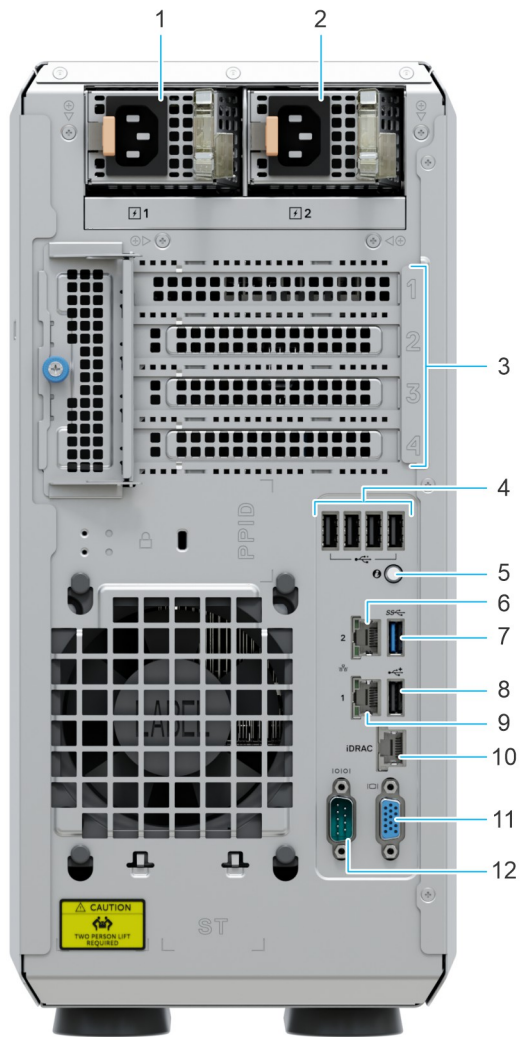

**Figure 3. Rear view of the system with redundant PSU**

1. Power supply unit (PSU 1)
2. Power supply unit (PSU 2)
3. PCIe expansion card slots (4)
4. USB 2.0 port (4)
5. System identification button
6. NIC port (1)
7. USB 3.0 port (1)
8. USB 2.0 port (1)
9. NIC port (2)
10. iDRAC ethernet port
11. VGA port
12. Serial port

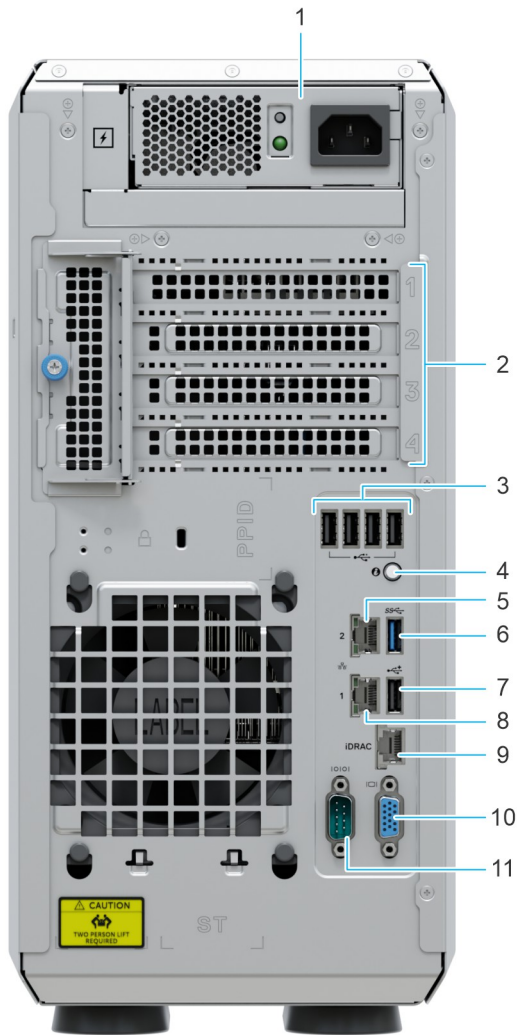

**Figure 4. Rear view of the system with cable PSU**

1. Cabled power supply unit
2. PCIe expansion card slots (4)
3. USB 2.0 port (4)
4. System identification button
5. NIC port (1)
6. USB 3.0 port (1)
7. USB 2.0 port (1)
8. NIC port (2)
9. iDRAC ethernet port
10. VGA port
11. Serial port

## Inside the system

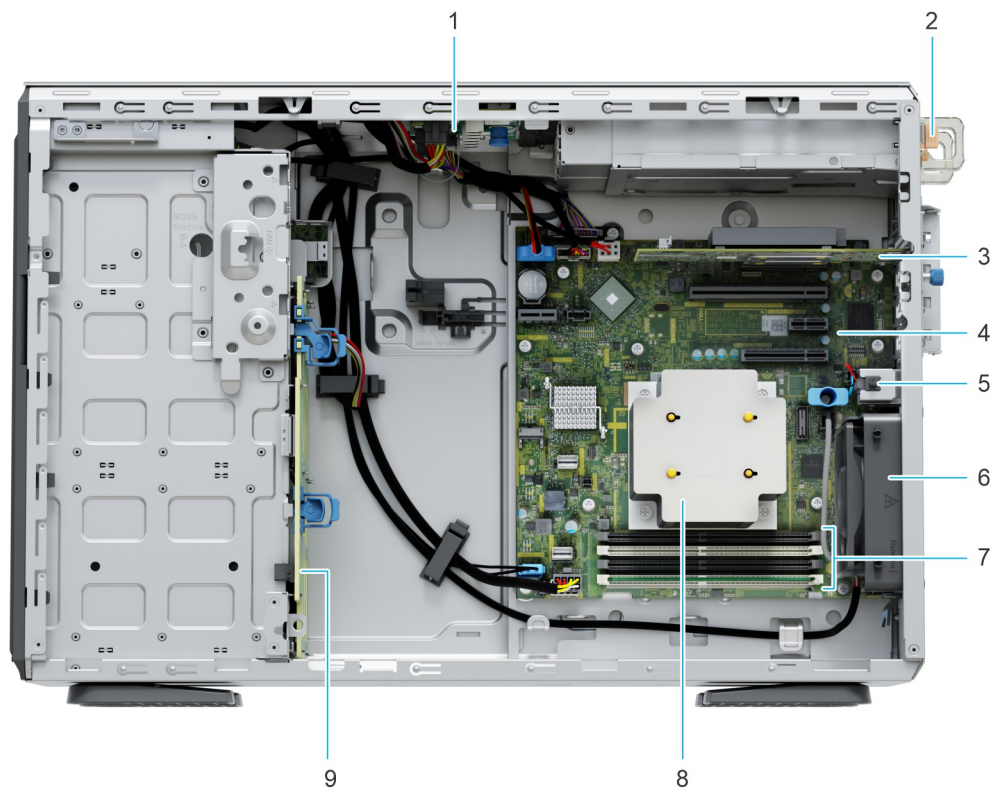

**Figure 5. Inside the system with redundant PSU**

- |                                |                 |
|--------------------------------|-----------------|
| 1. PIB (Power Interface Board) | 2. PSU          |
| 3. PCIe expansion card         | 4. System board |
| 5. Intrusion switch            | 6. Cooling fan  |
| 7. Memory module sockets       | 8. Heat sink    |
| 9. Backplane                   |                 |

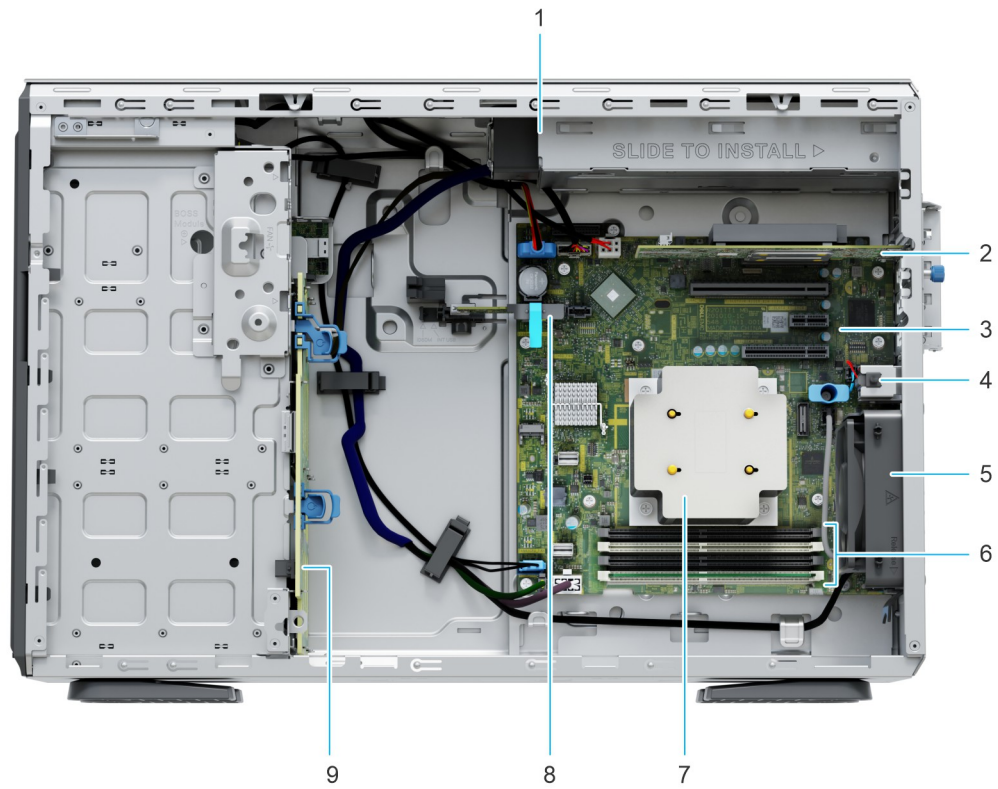

**Figure 6. Inside the system with cabled PSU**

- |                 |                                |
|-----------------|--------------------------------|
| 1. Cabled PSU   | 2. PCIe expansion card         |
| 3. System board | 4. Intrusion switch            |
| 5. Cooling fan  | 6. Memory module sockets       |
| 7. Heat sink    | 8. IDSDM / USB card (optional) |
| 9. Backplane    |                                |

## Quick Resource Locator



Figure 7. Quick Resource Locator for T350

# Processor



## Topics:

- [Processor features](#)
- [Supported processors](#)

## Processor features

The following lists the features and functions that are in the upcoming Intel® Xeon E-2300 series processor offering:

- As an entry level server - Small businesses require reliability and security to support their critical business and customer data needs
- As an edge device or appliance - Edge servers or appliances with energy efficiency and performance at entry level prices
- As a secure cloud server - Protect the most sensitive portions of a workload or service with hardware-enhanced security

## Supported processors

**Table 3. Processor BIN stack**

Processor	Clock Speed (GHz)	Cache (M)	Cores	Threads	Turbo	Memory Speed (MT/s)	Memory Capacity	TDP
E-2388G	3.2	16	8	16	Turbo	3200	128 GB	95 W
E-2378G	2.8	16	8	16	Turbo	3200	128 GB	80 W
E-2386G	3.5	12	6	12	Turbo	3200	128 GB	95 W
E-2378	2.6	16	8	16	Turbo	3200	128 GB	65 W
E-2374G	3.7	8	4	8	Turbo	3200	128 GB	80 W
E-2356G	3.2	12	6	12	Turbo	3200	128 GB	80 W
E-2336	2.9	12	6	12	Turbo	3200	128 GB	65 W
E-2334	3.4	8	4	8	Turbo	3200	128 GB	65 W
E-2324G	3.1	8	4	4	Turbo	3200	128 GB	65 W
E-2314	2.8	8	4	4	Turbo	3200	128 GB	65 W
G6505	4.2	4	2	4	No Turbo	2666	128 GB	58 W
G6405T	3.5	4	2	4	No Turbo	2666	128 GB	35 W



 **NOTE:** Graphics is not supported with E2300 series processors and cannot be enabled on Dell servers due to restriction in the chipset.

 **NOTE:** Hyper-Threading is enabled by default on all Intel Xeon E-2300 series processors.

# Memory subsystem

T350 supports up to 4 DIMM slots, with up to UDIMM 128 GB of memory and speeds of up to 3200 MT/s.

## Topics:

- [Supported memory](#)
- [Memory speed](#)

## Supported memory

The table below lists the memory technologies supported by the platform.

**Table 4. Supported memory technologies**

Feature	T350 (DDR4)
DIMM Type	UDIMM
Transfer Speed	2666 MT/s, 2933 MT/s, and 3200 MT/s
Voltage	1.2 V (DDR4)

The following table lists the supported DIMMs for the T350 at launch. For the latest information about supported DIMMs, see the Memory NDA Deck. For information about memory configuration, post RTS, see the Dell EMC PowerEdge T350 Installation and Service Manual at [www.dell.com/poweredgemanuals](http://www.dell.com/poweredgemanuals).

## Memory speed

The table below lists the performance details for T350 based on the quantity and type of DIMMs per memory channel.

**Table 5. DIMM performance details**

DIMM type	Rank	Capacity	DIMM rated voltage and speed	Operating speed for DIMMs per Channel (DPC)
UDIMM	1 R	8 GB / 16 GB	DDR4 (1.2 V), 3200 MT/s	3200 MT/s
	2 R	32 GB	DDR4 (1.2 V), 3200 MT/s	3200 MT/s

# Storage

## Topics:

- [Storage controllers](#)
- [Supported Drives](#)
- [Internal storage configuration](#)
- [External storage](#)

## Storage controllers

- PowerEdge Hardware RAID controllers (PERC) series 10, 11 are designed for:
  - Enhanced performance
  - Fault tolerance
  - Simplified management of RAID array drives
- PowerEdge controller series 10, 11 support older legacy SAS and SATA drive interfaces
- Dell S150 is software RAID solution for PowerEdge systems.

**Table 6. PERC Series controller offerings**

Performance Level	Controller and Description
Entry	S150 (SATA), SW RAID SATA
Value	H345, H355, HBA355 (Internal)
Premium Performance	H755
External Controllers	HBA355e

**NOTE:** For more information on the features of the Dell PowerEdge RAID controllers (PERC), Software RAID controllers, or BOSS card, and on deploying the cards, see the storage controller documentation at [www.dell.com/storagecontrollermanuals](http://www.dell.com/storagecontrollermanuals).

**NOTE:** From December 2021, H355 will replace H345 as the entry raid controller. H345 will be deprecated in January 2022.

## Supported Drives

The table that is shown below lists the internal drives that are supported by the T350.

**Table 7. Supported drives**

Form Factor	Type	Speed	Rotational Speed	Capacities
2.5-inch	SATA	6 GB	SSD	480 GB, 960 GB, 1.92 TB, 3.84 TB
2.5-inch	SAS / vSAS	12 GB	SSD	400 GB, 800 GB, 960 GB, 1.92 TB, 3.84 TB, 7.68 TB
2.5-inch	SAS	12 GB	10 K	600 GB, 1.2 TB, 2.4 TB
2.5-inch	SAS	12 GB	15 K	900 GB
3.5-inch	SAS	12 GB	7.2 K	2 TB, 4 TB, 8 TB, 12 TB, 16 TB, 20 TB

**Table 7. Supported drives (continued)**

Form Factor	Type	Speed	Rotational Speed	Capacities
3.5-inch	SATA	6 GB	7.2 K	2 TB, 4 TB, 8 TB, 12 TB, 16 TB, 20 TB
M.2	SATA	6 GB	SSD	240 GB, 480 GB

## Internal storage configuration

Please see the [Factory Configuration Matrix](#) on Sales Portal.

## External storage

T350 supports the external storage device types that are listed in the table below:

**Table 8. Support external storage devices**

Device Type	Description
External Tape	Supports connection to external USB tape products
NAS/IDM appliance software	Supports NAS software stack
JBOD	Supports connection to 12 Gb MD-Series JBODs

# Networking

## Topics:

- [Overview](#)

## Overview

PowerEdge offers a wide variety of options to get information moving to and from our servers. Industry best technologies are chosen, and systems management features are added by our partners to firmware to tie in with iDRAC. These adapters are rigorously validated for worry-free, fully supported use in Dell servers.

The [PowerEdge Server Adapter Matrix](#) posted to knowledge portal is the central repository for PowerEdge NIC, HBA and HCA information. The matrix covers:

- Part Numbers, Tied SKUs and Customer Kits
- Server Compatibility and Support
- Optics and Cable Support
- Systems Management
- Adapter Features
- Spec Sheet Links

This document is updated as changes happen, so be sure to bookmark it rather than downloading an offline copy to stay with the latest information.

 **NOTE:** This is a direct download link to an .XLSX and may not open in a tab as expected depending on your browser.

# Expansion cards

**NOTE:** When an expansion card is not supported or missing, the iDRAC and Lifecycle Controller logs an event. This does not prevent your system from booting. However, if a F1/F2 pause occurs with an error message, see *Troubleshooting expansion cards* section in the *Dell EMC PowerEdge Servers Troubleshooting Guide* at [www.dell.com/poweredgemanuals](http://www.dell.com/poweredgemanuals).

## Topics:

- Expansion card installation guidelines

## Expansion card installation guidelines

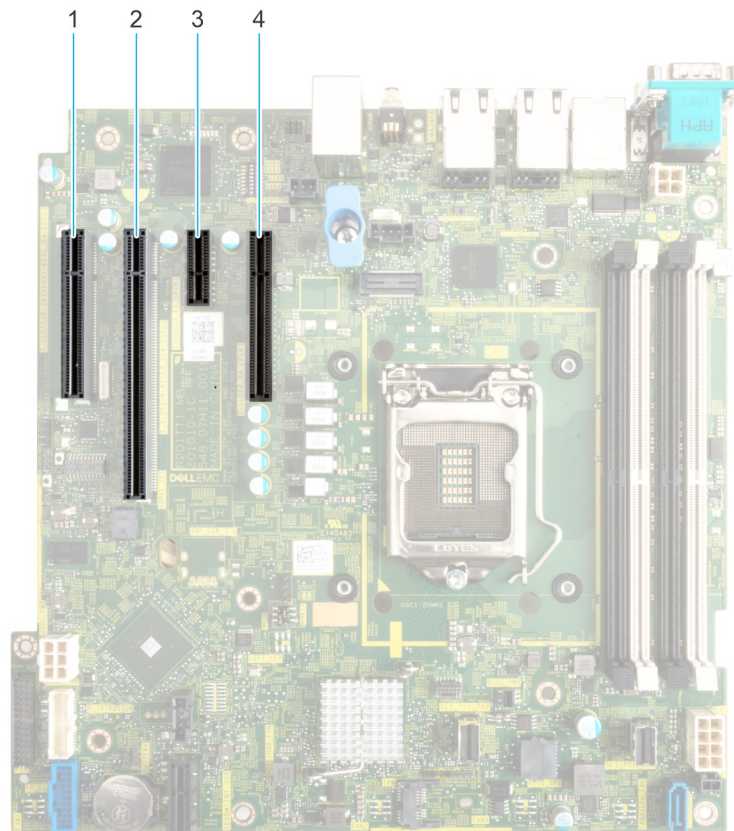

**Figure 8. Expansion card slot connectors**

- |           |           |
|-----------|-----------|
| 1. Slot 1 | 2. Slot 2 |
| 3. Slot 3 | 4. Slot 4 |

The following table describes the expansion card riser configurations:

**Table 9. Expansion card slots supported on the system board**

PCIe slot	Risers	Processor connection	PCIe slot height	PCIe slot length	PCIe slot width
Slot 1 (Gen4)	N/A	Processor 1	Full height	Half length	x4 link in x8 slot

**Table 9. Expansion card slots supported on the system board (continued)**

PCIe slot	Risers	Processor connection	PCIe slot height	PCIe slot length	PCIe slot width
Slot 2 (Gen4)	N/A	Processor 1	Full height	Full length	x16
Slot 3 (Gen3)	N/A	Platform Controller Hub	Full height	Half length	x1
Slot 4 (Gen3)	N/A	Platform Controller Hub	Full height	Half length	x4 link in x8 slot

**NOTE:** Slot 1 is disabled, when system is installed with Intel Pentium processor.

**NOTE:** The expansion-card slots are not hot-swappable.

The following table provides guidelines for installing expansion cards to ensure proper cooling and mechanical fit. The expansion cards with the highest priority should be installed first using the slot priority indicated. All the other expansion cards should be installed in the card priority and slot priority order.

**Table 10. Configuration : No Riser**

Card type	Slot priority	Maximum number of cards
Foxconn (APERC 11)	2	1
Foxconn (APERC HBA11)	2, 1	1
Foxconn (external adapter)	2, 1	2
Foxconn (APERC 10.15)	2	1
Broadcom (NIC: 1Gb)	2, 1, 4	3
Intel (NIC: 1Gb)	2, 1, 4	3
Intel Campbell Pond DP FH (NIC: 10Gb)	2	1
Intel Eagle Fountain DP FH (NIC: 10Gb)	2	1
BOSS S2 Module	Integrated slot	1

# Power, thermal, and acoustics

PowerEdge servers have an extensive collection of sensors that automatically track thermal activity, which helps regulate temperature thereby reducing server noise and power consumption. The table below lists the tools and technologies Dell offers to lower power consumption and increase energy efficiency.

## Topics:

- [Power](#)
- [Thermal](#)
- [Acoustics](#)

## Power

**Table 11. Power tools and technologies**

Feature	Description
Power Supply Units(PSU) portfolio	Dell's PSU portfolio includes intelligent features such as dynamically optimizing efficiency while maintaining availability and redundancy. Find additional information in the Power supply units section.
Tools for right sizing	Enterprise Infrastructure Planning Tool (EIPT) is a tool that can help you determine the most efficient configuration possible. With Dell's EIPT, you can calculate the power consumption of your hardware, power infrastructure, and storage at a given workload. Learn more at <a href="http://www.dell.com/calc">www.dell.com/calc</a> .
Industry Compliance	Dell's servers are compliant with all relevant industry certifications and guide lines, including 80 PLUS, Climate Savers and ENERGY STAR.
Power monitoring accuracy	PSU power monitoring improvements include: <ul style="list-style-type: none"> <li>• Dell's power monitoring accuracy is currently 1%, whereas the industry standard is 5%</li> <li>• More accurate reporting of power</li> <li>• Better performance under a power cap</li> </ul>
Power capping	Use Dell's systems management to set the power cap limit for your systems to limit the output of a PSU and reduce system power consumption. Dell is the first hardware vendor to leverage Intel Node Manager for circuit-breaker fast capping.
Systems Management	iDRAC Enterprise and Datacenter provides server-level management that monitors, reports and controls power consumption at the processor, memory and system level.  Dell OpenManage Power Center delivers group power management at the rack, row, and data center level for servers, power distribution units, and uninterruptible power supplies.
Active power management	Intel Node Manager is an embedded technology that provides individual server-level power reporting and power limiting functionality. Dell offers a complete power management solution comprised of Intel Node Manager accessed through Dell iDRAC9 Datacenter and OpenManage Power Center that allows policy-based management of power and thermal at the individual server, rack, and data center level. Hot spare reduces power consumption of redundant power supplies. Thermal control off a speed optimizes the thermal settings for your environment to reduce fan consumption and lower system power consumption.  Idle power enables Dell servers to run as efficiently when idle as when at full workload.
Fresh Air cooling	Refer to ASHRAE A3/A4 Thermal Restriction.



**Table 11. Power tools and technologies (continued)**

Feature	Description
Rack infrastructure	<p>Dell offers some of the industry's highest-efficiency power infrastructure solutions, including:</p> <ul style="list-style-type: none"> <li>• <a href="#">Power distribution units (PDUs)</a></li> <li>• <a href="#">Uninterruptible power supplies (UPSs)</a></li> <li>• <a href="#">Energy Smart containment rack enclosures</a></li> </ul> <p>Find additional information at: <a href="https://www.delltechnologies.com/en-us/servers/power-and-cooling.htm">https://www.delltechnologies.com/en-us/servers/power-and-cooling.htm</a>.</p>

## Thermal

PowerEdge servers have an extensive collection of sensors that automatically track thermal activity, which helps regulate temperature thereby reducing server noise and power consumption.

## Acoustics

### Acoustical performance

Dell EMC PowerEdge T350 is a tower server appropriate for office environment.

**Table 12. Acoustical configurations of T350**

Configuration	Entry	Volume	Feature rich
Processor	1x Intel Rocket Lake, 65 W	1x Intel Rocket Lake, 65 W	1x Intel Rocket Lake, 80 W
Processor Quantity	1	1	1
Memory	8 GB UDIMM	16 GB UDIMM	32 GB UDIMM
Memory Quantity	1	2	4
Storage	3.5-inch SATA 2-TB HDD	3.5-inch SATA 2-TB HDDs	3.5-inch SATA 4-TB HDDs
Storage Quantity	1	2	8
Backplane	4x 3.5-inch hot swap	8x 3.5-inch hot swap	8x 3.5-inch hot swap
Power Supply Unit	450 W (106 mm)	600 W (60 mm)	600 W (60 mm)
Power Supply Quantity	1	2	2
—	None (Chipset SATA)	PERC H345	2x 1 GbE NIC
Bezel	N/A	Yes	Yes
Other	N/A	ODD	ODD

**Table 13. Acoustical performance of T350 acoustical configurations**

Configuration		Entry	Volume	Feature rich
<b>Acoustical Performance: Idle/ Operating @ 25 °C Ambient</b>				
L <sub>wA,m</sub> (B)	Idle	4.6	4.6	4.6
	Operating	4.6	4.6	4.6
K <sub>v</sub> (B)	Idle	0.4	0.4	0.4
	Operating	0.4	0.4	0.4
L <sub>pA,m</sub> (dB)	Idle	31	31	31

**Table 13. Acoustical performance of T350 acoustical configurations (continued)**

Configuration	Entry	Volume	Feature rich
<b>Acoustical Performance: Idle/ Operating @ 25 °C Ambient</b>			
	Operating	31	31
Prominent tones	No prominent tones in Idle and Operating		
<b>Acoustical Performance: Idle @ 28 °C Ambient</b>			
$L_{wA,m}$ (B)	4.6	4.6	4.6
$K_v$ (B)	0.4	0.4	0.4
$L_{pA,m}$ (dB)	31	31	31
<b>Acoustical Performance: Max. Loading @ 35 °C Ambient</b>			
$L_{wA,m}$ (B)	4.6	4.6	5.2
$K_v$ (B)	0.4	0.4	0.4
$L_{pA,m}$ (dB)	31	31	40

$L_{wA,m}$ : The declared mean A-weighted sound power level (LwA) is calculated per section 5.2 of ISO 9296 (2017) with data collected using the methods described in ISO 7779 (2010). Data presented here may not be fully compliant with ISO 7779.

$L_{pA,m}$ : The declared mean A-weighted emission sound pressure level is at the bystander position per section 5.3 of ISO 9296 (2017) and measured using methods described in ISO 7779 (2010). The system is placed in a 24U rack enclosure, 25 cm above a reflective floor. Data presented here may not be fully compliant with ISO 7779.

Prominent tones: Criteria of D.6 and D.11 of ECMA-74 are followed to determine if discrete tones are prominent and to report them, if so.

Idle mode: The steady-state condition in which the server is energized but not operating any intended function.

Operating mode: The maximum of the steady state acoustical output at 50% of Processor TDP or active HDDs per C.9.3.2 in ECMA-74 .

## Supported operating systems

The PowerEdge T350 system supports the following operating systems:

- Canonical Ubuntu Server LTS
- VMware ESXi
- Microsoft Windows Server with Hyper-V
- SUSE Linux Enterprise Server
- Red Hat Enterprise Linux

For more information, go to [www.dell.com/ossupport](http://www.dell.com/ossupport).

# Dell EMC OpenManage systems management

## Dell EMC OpenManage Portfolio

Simplifying hardware management through ease of use and automation

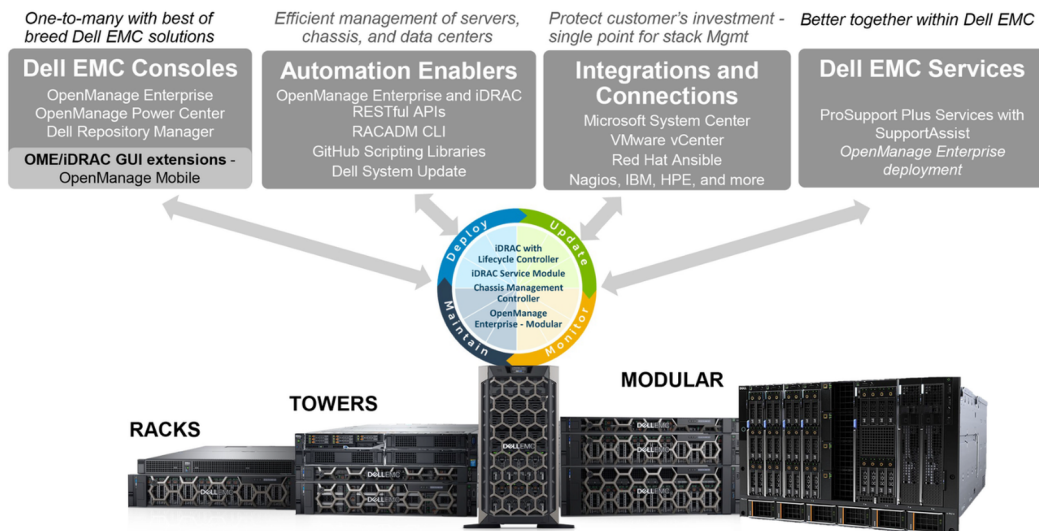

Figure 9. Dell EMC OpenManage Portfolio

Dell EMC delivers management solutions that help IT Administrators effectively deploy, update, monitor, and manage IT assets. OpenManage solutions and tools enable you to quickly respond to problems by helping them to manage Dell EMC servers effectively and efficiently; in physical, virtual, local, and remote environments, operating in-band, and out-of-band (agent-free). The OpenManage portfolio includes innovative embedded management tools such as the integrated Dell Remote Access Controller (iDRAC), Chassis Management Controller and Consoles like OpenManage Enterprise, OpenManage Power Manager plug in, and tools like Repository Manager.

Dell EMC has developed comprehensive systems management solutions based on open standards and has integrated with management consoles that can perform advanced management of Dell hardware. Dell EMC has connected or integrated the advanced management capabilities of Dell hardware into offerings from the industry's top systems management vendors and frameworks such as Ansible, thus making Dell EMC platforms easy to deploy, update, monitor, and manage.

The key tools for managing Dell EMC PowerEdge servers are iDRAC and the one-to-many OpenManage Enterprise console. OpenManage Enterprise helps the system administrators in complete lifecycle management of multiple generations of PowerEdge servers. Other tools such as Repository Manager, which enables simple yet comprehensive change management.

OpenManage tools integrate with systems management framework from other vendors such as VMware, Microsoft, Ansible, and ServiceNow. This enables you to use the skills of the IT staff to efficiently manage Dell EMC PowerEdge servers.

### Topics:

- [Server and Chassis Managers](#)
- [Dell EMC consoles](#)
- [Automation Enablers](#)
- [Integration with third-party consoles](#)
- [Connections for third-party consoles](#)
- [Dell EMC Update Utilities](#)
- [Dell resources](#)

## Server and Chassis Managers

- Integrated Dell Remote Access Controller (iDRAC)
- iDRAC Service Module (iSM)

## Dell EMC consoles

- Dell EMC OpenManage Enterprise
- Dell EMC Repository Manager (DRM)
- Dell EMC OpenManage Enterprise Power Manager plugin to OpenManage Enterprise
- Dell EMC OpenManage Mobile (OMM)

## Automation Enablers

- OpenManage Ansible Modules
- iDRAC RESTful APIs (Redfish)
- Standards-based APIs (Python, PowerShell)
- RACADM Command Line Interface (CLI)
- GitHub Scripting Libraries

## Integration with third-party consoles

- Dell EMC OpenManage Integrations with Microsoft System Center
- Dell EMC OpenManage Integration for VMware vCenter (OMIVV)
- Dell EMC OpenManage Ansible Modules
- Dell EMC OpenManage Integration with ServiceNow

## Connections for third-party consoles

- Micro Focus and other HPE tools
- OpenManage Connection for IBM Tivoli
- OpenManage Plug-in for Nagios Core and XI

## Dell EMC Update Utilities

- Dell System Update (DSU)
- Dell EMC Repository Manager (DRM)
- Dell EMC Update Packages (DUP)
- Dell EMC Server Update Utility (SUU)
- Dell EMC Platform Specific Bootable ISO (PSBI)

## Dell resources

For additional information about white papers, videos, blogs, forums, technical material, tools, usage examples, and other information, go to the OpenManage page at <https://www.dell.com/openmanagemanuals> or the following product pages:

**Table 14. Dell resources**

<b>Resource</b>	<b>Location</b>
Integrated Dell Remote Access Controller (iDRAC)	<a href="https://www.dell.com/idracmanuals">https://www.dell.com/idracmanuals</a>
iDRAC Service Module (iSM)	<a href="https://www.dell.com/support/kbdoc/000178050/">https://www.dell.com/support/kbdoc/000178050/</a>
OpenManage Ansible Modules	<a href="https://www.dell.com/support/kbdoc/000177308/">https://www.dell.com/support/kbdoc/000177308/</a>
OpenManage Essentials (OME)	<a href="https://www.dell.com/support/kbdoc/000175879/">https://www.dell.com/support/kbdoc/000175879/</a>
OpenManage Mobile (OMM)	<a href="https://www.dell.com/support/kbdoc/000176046">https://www.dell.com/support/kbdoc/000176046</a>
OpenManage Integration for VMware vCenter (OMIVV)	<a href="https://www.dell.com/support/kbdoc/000176981/">https://www.dell.com/support/kbdoc/000176981/</a>
OpenManage Integration for Microsoft System Center (OMIMSSC)	<a href="https://www.dell.com/support/kbdoc/000147399">https://www.dell.com/support/kbdoc/000147399</a>
Dell EMC Repository Manager (DRM)	<a href="https://www.dell.com/support/kbdoc/000177083">https://www.dell.com/support/kbdoc/000177083</a>
Dell EMC System Update (DSU)	<a href="https://www.dell.com/support/kbdoc/000130590">https://www.dell.com/support/kbdoc/000130590</a>
Dell EMC Platform Specific Bootable ISO (PSBI)	<a href="https://Dell.com/support/article/sln296511">Dell.com/support/article/sln296511</a>
Dell EMC Chassis Management Controller (CMC)	<a href="https://www.dell.com/support/article/sln311283">www.dell.com/support/article/sln311283</a>
OpenManage Connections for Partner Consoles	<a href="https://www.dell.com/support/kbdoc/000146912">https://www.dell.com/support/kbdoc/000146912</a>
OpenManage Enterprise Power Manager	<a href="https://www.dell.com/support/kbdoc/000176254">https://www.dell.com/support/kbdoc/000176254</a>
OpenManage Integration with ServiceNow (OMISNOW)	<a href="https://Dell.com/support/article/sln317784">Dell.com/support/article/sln317784</a>

 **NOTE:** Features may vary by server. Please refer to the product page on <https://www.dell.com/manuals> for details.

## Dell Technologies Services

Dell Technologies Services include a wide, customizable range of service choices to simplify the assessment, design, implementation, management and maintenance of IT environments and to help you transition from platform to platform. Depending on your current business requirements and the level of service right for you, we provide factory, on-site, remote, modular, and specialized services that fit your needs and budget. We'll help with a little or a lot—your choice—and provide access to our global resources.

For more information, see [DellEMC.com/Services](http://DellEMC.com/Services).

### Topics:

- [Dell EMC ProDeploy Enterprise Suite](#)
- [Dell EMC Remote Consulting Services](#)
- [Dell EMC Data Migration Service](#)
- [Dell EMC ProSupport Enterprise Suite](#)
- [Dell EMC ProSupport Plus for Enterprise](#)
- [Dell EMC ProSupport for Enterprise](#)
- [Dell EMC ProSupport One for Data Center](#)
- [ProSupport for HPC](#)
- [Support Technologies](#)
- [Dell Technologies Education Services](#)
- [Dell Technologies Consulting Services](#)
- [Dell EMC Managed Services](#)

## Dell EMC ProDeploy Enterprise Suite

ProDeploy Enterprise Suite gets your server out of the box and into optimized production—fast. Our elite deployment engineers with broad and deep experience utilizing best-in-class processes along with our established global scale can help you around the clock and around the globe. From simple to the most complex server installations and software integration, we take the guess work and risk out of deploying your new server technology.

		Basic Deployment	ProDeploy	ProDeploy Plus
Pre-deployment	Single point of contact for project management	-	●	In-region
	Site readiness review	-	●	●
	Implementation planning	-	●	●
	SAM engagement for ProSupport Plus entitled devices	-	-	●
Deployment	Deployment service hours	Business hours	24x7	24x7
	Remote guidance for hardware installation or Onsite hardware installation and packaging material removal	Onsite	Remote or Onsite	Onsite
	Install and configure system software	-	Remote	Onsite
	Install support software and connect with Dell Technologies	-	●	●
	Project documentation with knowledge transfer	-	●	●
	Post-deployment	Deployment verification	-	●
Configuration data transfer to Dell EMC technical support		-	●	●
30-days of post-deployment configuration assistance		-	-	●
Training credits for Dell EMC Education Services		-	-	●

Figure 10. ProDeploy Enterprise Suite capabilities

**NOTE:** Hardware installation not applicable on selected software products.

## Dell EMC ProDeploy Plus

From beginning to end, ProDeploy Plus provides the skill and scale needed to successfully execute demanding deployments in today's complex IT environments. Certified Dell EMC experts start with extensive environmental assessments and detailed migration planning and recommendations. Software installation includes set up of most versions of Dell EMC SupportAssist and OpenManage system management utilities. Post-deployment configuration assistance, testing, and product orientation services are also available.

## Dell EMC ProDeploy

ProDeploy provides full service installation and configuration of both server hardware and system software by certified deployment engineers including set up of leading operating systems and hypervisors as well as most versions of Dell EMC SupportAssist and OpenManage system management utilities. To prepare for the deployment, we conduct a site readiness review and implementation planning exercise. System testing, validation, and full project documentation with knowledge transfer complete the process.

## Basic Deployment

Basic Deployment delivers worry-free professional installation by experienced technicians who know Dell EMC servers inside and out.

## Dell EMC Server Configuration Services

With Dell EMC Rack Integration and other Dell EMC PowerEdge Server Configuration Services, you save time by receiving your systems racked, cabled, tested, and ready to integrate into the data center. Dell EMC staff pre-configure RAID, BIOS and iDRAC settings, install system images, and even install third-party hardware and software.

For more information, see [Server Configuration Services](#).

## Dell EMC Residency Services

Residency Services helps customers transition to new capabilities quickly with the assistance of on-site or remote Dell EMC experts whose priorities and time you control. Residency experts can provide post implementation management and knowledge transfer related to a new technology acquisition or day-to-day operational management of the IT infrastructure.

## Dell EMC Remote Consulting Services

When you are in the final stages of your PowerEdge server implementation, you can rely on Dell EMC Remote Consulting Services and our certified technical experts to help you optimize your configuration with best practices for your software, virtualization, server, storage, networking, and systems management.

## Dell EMC Data Migration Service

Protect your business and data with our single point of contact to manage your data migration project. Your project manager will work with our experienced team of experts to create a plan using industry-leading tools and proven processes based on global best practices to migrate your existing files and data so your business system get up and running quickly and smoothly.

## Dell EMC ProSupport Enterprise Suite

With the ProSupport Enterprise Suite, we help keep your IT systems running smoothly, so you can focus on running your business. We will help maintain peak performance and availability of your most essential workloads. ProSupport Enterprise Suite is a suite of support services that enable you to build the solution that is right for your organization.



Choose support models based on how you use technology and where you want to allocate resources. From the desktop to the data center, address everyday IT challenges, such as unplanned downtime, mission-critical needs, data and asset protection, support planning, resource allocation, software application management and more. Optimize IT resources by choosing the right support model.

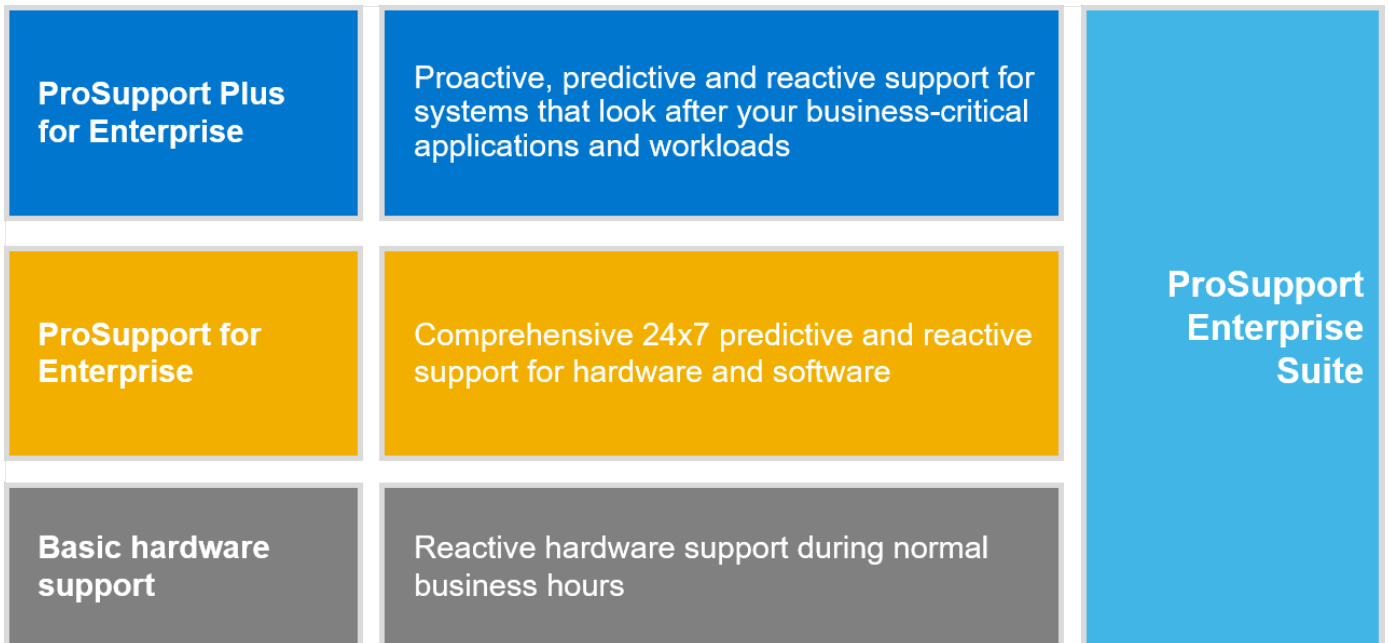

Figure 11. Dell EMC ProSupport Enterprise Suite

## Dell EMC ProSupport Plus for Enterprise

When you purchase your PowerEdge server, we recommend ProSupport Plus, our proactive and preventative support service for your business-critical systems. ProSupport Plus provides you with all the benefits of ProSupport, plus the following:

- An assigned Services Account Manager who knows your business and your environment
- Immediate advanced troubleshooting from an engineer who understands your PowerEdge server
- Personalized, preventive recommendations based on analysis of support trends and best practices from across the Dell Technologies infrastructure solutions customer base to reduce support issues and improve performance
- Predictive analysis for issue prevention and optimization enabled by SupportAssist
- Proactive monitoring, issue detection, notification, and automated case creation for accelerated issue resolution enabled by SupportAssist
- On-demand reporting and analytics-based recommendations enabled by SupportAssist and TechDirect

## Dell EMC ProSupport for Enterprise

Our ProSupport service offers highly trained experts around the clock and around the globe to address your IT needs. We help minimize disruptions and maximize availability of PowerEdge server workloads with:

- 24x7 support through phone, chat and online
- Predictive, automated tools and innovative technology
- A central point of accountability for all hardware and software issues
- Collaborative 3rd party support
- Hypervisor, operating system and application support
- Consistent experience regardless of where you are located or what language you speak
- Optional onsite parts and labor response options including next business day or four-hour mission critical

**i** **NOTE:** Subject to service offer country availability.

## Enterprise Support Services Feature Comparison

	Basic	ProSupport	ProSupport Plus
Remote technical support	9x5	24x7	24x7
Covered products	Hardware	Hardware Software	Hardware Software
Onsite hardware support	Next business day	Next business day or 4hr mission critical	Next business day or 4 hr mission critical
3 <sup>rd</sup> party collaborative assistance		●	●
Automated issue detection & proactive case creation		●	●
Self-service case initiation and management		●	●
Access to software updates		●	●
Priority access to specialized support experts			●
3 <sup>rd</sup> party software support			●
Assigned Services Account Manager			●
Personalized assessments and recommendations			●
Semiannual systems maintenance			●

Availability and terms of Dell Technologies services vary by region and by product. For more information, please view our Service Descriptions available on [Dell.com](http://Dell.com)

Figure 12. Dell EMC Enterprise Support model

## Dell EMC ProSupport One for Data Center

ProSupport One for Data Center offers flexible site-wide support for large and distributed data centers with more than 1,000 assets. This offering is built on standard ProSupport components that leverage our global scale but are tailored to your company's needs. While not for everyone, this service option offers a truly unique solution for Dell Technologies largest customers with the most complex environments.

- Team of assigned Services Account Managers with remote, on-site options
- Assigned ProSupport One technical and field engineers who are trained on your environment and configurations
- On-demand reporting and analytics-based recommendations enabled by SupportAssist and TechDirect
- Flexible on-site support and parts options that fit your operational model
- A tailored support plan and training for your operations staff

## ProSupport for HPC

The ProSupport for HPC provides solution-aware support including:

- Access to senior HPC experts
- Advanced HPC cluster assistance: performance, interoperability & configuration
- Enhanced HPC solution level end-to-end support
- Remote pre-support engagement with HPC Specialists during ProDeploy implementation

Learn more at [DellEMC.com/HPC-Services](http://DellEMC.com/HPC-Services).

# ProSupport Add-on for HPC

Delivering a true end-to-end support experience across your HPC environment

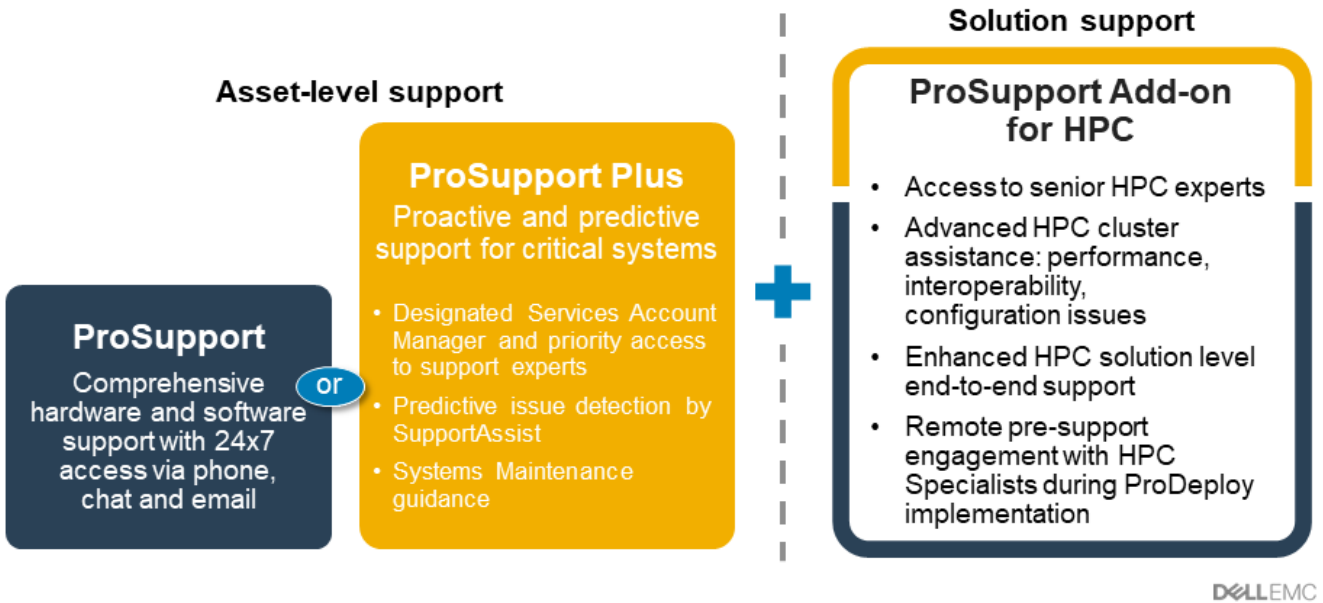

Figure 13. ProSupport for HPC

## Support Technologies

Powering your support experience with predictive, data-driven technologies.

### Dell EMC SupportAssist

The best time to solve a problem is before it happens. The automated proactive and predictive technology SupportAssist helps reduce steps and time to resolution, often detecting issues before they become a crisis. Benefits include:

- Value—SupportAssist is available to all customers at no additional charge
- Improve productivity—replace manual, high-effort routines with automated support
- Accelerate time to resolution—receive issue alerts, automatic case creation, and proactive contact from Dell EMC experts
- Gain insight and control—optimize enterprise devices with on-demand ProSupport Plus reporting in TechDirect, and get predictive issue detection before the problem starts

**NOTE:** SupportAssist is included with all support plans, but features vary based on service level agreement.

	Basic Hardware Warranty	ProSupport	ProSupport Plus
Automated issue detection and system state information collection	•	•	•
Proactive, automated case creation and notification		•	•
Predictive issue detection for failure prevention			•
Recommendation reporting available on-demand in TechDirect			•

Figure 14. SupportAssist model

Get started at [Dell.com/SupportAssist](https://Dell.com/SupportAssist)

## Dell EMC TechDirect

Boost IT team productivity when supporting Dell EMC systems. With over 1.4 million self-dispatches processed each year, TechDirect has proven its effectiveness as a support tool. You can:

- Self-dispatch replacement parts
- Request technical support
- Integrate APIs into your help desk

Or, access all your Dell EMC certification and authorization requirements. Train your staff on Dell EMC products, as TechDirect allows you to:

- Download study guides
- Schedule certification and authorization exams
- View transcripts of completed courses and exams

Register at [techdirect.dell](https://techdirect.dell).

## Dell Technologies Education Services

Build the IT skills required to influence the transformational outcomes of the business. Enable talent and empower teams with the right skills to lead and execute transformational strategy that drives competitive advantage. Leverage the training and certification required for real transformation.

Dell Technologies Education Services offers PowerEdge server training and certifications designed to help you achieve more from your hardware investment. The curriculum delivers the information and the practical, hands-on skills that you and your team need to confidently install, configure, manage, and troubleshoot your Dell EMC servers. To learn more or register for a class today, see [LearnDell.com/Server](https://LearnDell.com/Server).

## Dell Technologies Consulting Services

Our expert consultants help you transform faster, and quickly achieve business outcomes for the high value workloads Dell EMC PowerEdge systems can handle.

From strategy to full-scale implementation, Dell Technologies Consulting can help you determine how to execute your IT, workforce, or application transformation.

We use prescriptive approaches and proven methodologies combined with Dell Technologies' portfolio and partner ecosystem to help you achieve real business outcomes. From multi-cloud, applications, DevOps, and infrastructure transformations, to business resiliency, data center modernization, analytics, workforce collaboration, and user experiences—we're here to help.

## Dell EMC Managed Services

Reduce the cost, complexity, and risk of managing IT. Focus your resources on digital innovation and transformation while our experts help optimize your IT operations and investment with managed services backed by guaranteed service levels.

## Appendix A: Additional specifications

### Topics:

- Chassis dimension
- Chassis weight
- Video specifications
- USB Ports
- Power Supply Units
- Environmental specifications

### Chassis dimension

The T350 has the following dimensions:

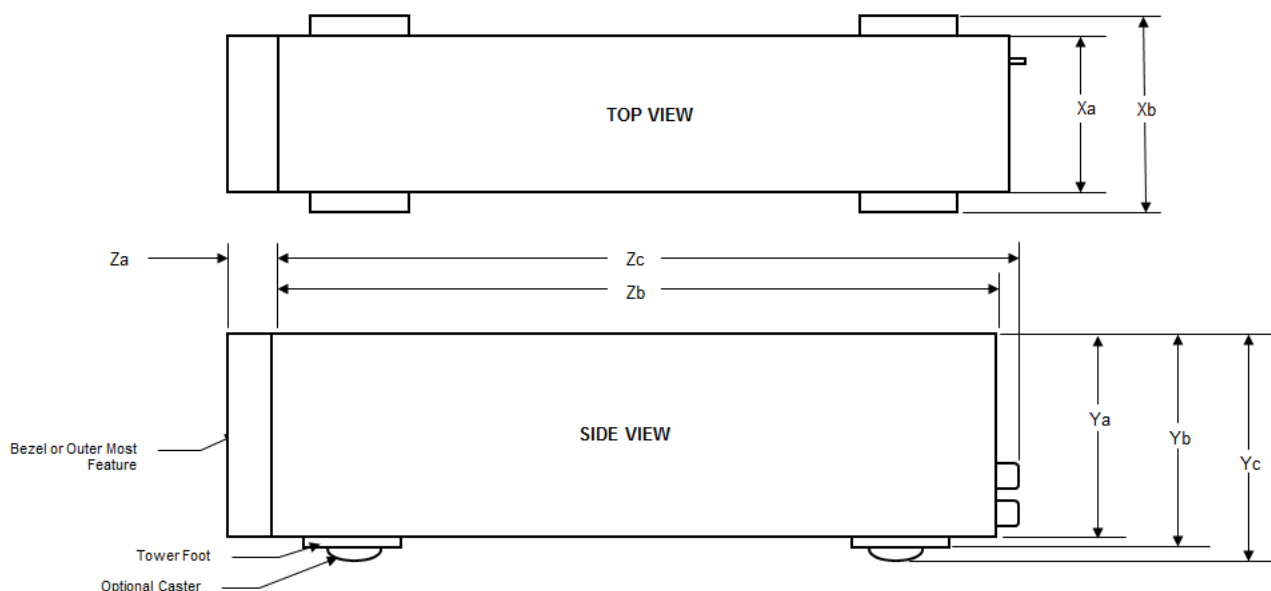

Figure 15. Chassis dimensions

Table 15. Chassis dimensions

Drives	Xa	Xb	Ya	Yb	Yc	Za	Zb	Zc
8 x 3.5-inch / 4 x 3.5-inch	175 mm (6.88 inches)	N/A	369.5 mm (14.54 inches)	382.5 mm (15.05 inches)	N/A	With bezel: 19 mm (0.74 inches)	560.5 mm (22.06 inches)	562.12 mm (22.13 inches)

# Chassis weight

**Table 16. PowerEdge T350 system weight**

System configuration	Maximum weight (with all drives/SSDs)
4 x 3.5-inch	19.54 kg (43.07 pound)
8 x 3.5-inch	25.34 kg (55.86 pound)

# Video specifications

The PowerEdge T350 system supports integrated Matrox G200 graphics controller with 16 MB of video frame buffer.

**Table 17. Supported video resolution options for the system**

Resolution	Refresh rate	Color depth (bits)
640 x 480	60, 72	8, 16, 24
800 x 600	60, 75, 85	8, 16, 24
1024 x 768	60, 75, 85	8, 16, 24
1152 x 864	60, 75, 85	8, 16, 24
1280 x 1024	60, 75	8, 16, 24

# USB Ports

**Table 18. PowerEdge T350 USB ports specifications**

Front		Rear		Internal	
USB port type	No. of ports	USB port type	No. of ports	USB port type	No. of ports
USB 3.0 - compliant port	One	USB 2.0 - compliant port	Five	Internal USB 3.0 - compliant port	One
iDRAC Direct port (Micro-AB USB 2.0-compliant port)	One	USB 3.0 - compliant port	One		

**NOTE:** The micro USB 2.0 compliant port can only be used as an iDRAC Direct or a management port.

# Power Supply Units

Energy Smart power supplies have intelligent features, such as the ability to dynamically optimize efficiency while maintaining availability and redundancy. Also featured are enhanced power-consumption reduction technologies, such as high-efficiency power conversion and advanced thermal-management techniques, and embedded power-management features, including high-accuracy power monitoring. The table below shows the power supply unit options that are available for the T350.

**Table 19. PowerEdge T350 PSU specifications**

PSU	Class	Heat dissipation (maximum)	Frequency	Voltage	AC		DC	Current
					High line 200 - 240 V	Low line 100 - 120 V		
450 W AC	Bronze	1871 BTU/hr	50/60 Hz	100–240 V AC, autoranging	450 W	450 W	N/A	6.5 - 3.5 A
600 W AC	Platinum	2250 BTU/hr	50/60 Hz	100–240 V AC, autoranging	600 W	600 W	N/A	7.1 - 3.6 A
600 W Mixed Mode HVDC	N/A	2250 BTU/hr	N/A	240 V DC	N/A	N/A	600 W	2.9 A
700 W AC	Titanium	2625 BTU/hr	50/60 Hz	100–240 V AC, autoranging	700 W	700 W	N/A	4.1 A
700 W Mixed Mode HVDC	Titanium	2625 BTU/hr	N/A	240 V DC	N/A	N/A	700 W	3.4 A

**NOTE:** This system is also designed to connect to the IT power systems with a phase-to-phase voltage not exceeding 240 V.

**NOTE:** Heat dissipation is calculated using the PSU wattage rating.

**NOTE:** When selecting or upgrading the system configuration, to ensure optimum power utilization, verify the system power consumption with the Enterprise Infrastructure Planning Tool available at [Dell.com/calc](http://Dell.com/calc).

## Environmental specifications

**NOTE:** For additional information about environmental certifications, refer to the Product Environmental Datasheet located with the Documentation > Regulatory Information on [www.dell.com/support/home](http://www.dell.com/support/home).

**Table 20. Operational climatic range category A2**

Temperature	Specifications
Allowable continuous operations	
Temperature ranges for altitudes <= 900 m (<= 2953 ft)	10–35°C (50–95°F) with no direct sunlight on the equipment
Humidity percent ranges (non-condensing at all times)	8% RH with -12°C minimum dew point to 80% RH with 21°C (69.8°F) maximum dew point
Operational altitude de-rating	Maximum temperature is reduced by 1°C/300 m (1.8°F/984 Ft) above 900 m (2953 Ft)

**Table 21. Operational climatic range category A4**

Temperature	Specifications
Allowable continuous operations	
Temperature ranges for altitudes <= 900 m (<= 2953 ft)	5–45°C (41–113°F) with no direct sunlight on the equipment
Humidity percent ranges (non-condensing at all times)	8% RH with -12°C minimum dew point to 90% RH with 24°C (75.2°F) maximum dew point

**Table 21. Operational climatic range category A4 (continued)**

Temperature	Specifications
Operational altitude de-rating	Maximum temperature is reduced by 1°C/125 m (33.8°F/410 Ft) above 900 m (2953 Ft)

**Table 22. Shared requirements across all categories**

Temperature	Specifications
Allowable continuous operations	
Maximum temperature gradient (applies to both operation and non-operation)	20°C in an hour* (36°F in an hour) and 5°C in 15 minutes (9°F in 15 minutes), 5°C in an hour* (9°F in an hour) for tape  <b>NOTE:</b> * - Per ASHRAE thermal guidelines for tape hardware these are not instantaneous rates of temperature change.
Non-operational temperature limits	-40 to 65°C (-40 to 149°F)
Non-operational humidity limits	5% to 95% RH with 27°C (80.6°F) maximum dew point
Maximum non-operational altitude	12,000 meters (39,370 ft)
Maximum operational altitude	3,048 meters (10,000 ft)

**Table 23. Maximum vibration specifications**

Maximum vibration	Specifications
Operating	0.21 G <sub>rms</sub> at 5 Hz to 500 Hz for 10 minutes (all x, y, and z axes)
Storage	1.88 G <sub>rms</sub> at 10 Hz to 500 Hz for 15 minutes (all six sides tested)

**Table 24. Maximum shock pulse specifications**

Maximum shock pulse	Specifications
Operating	Six consecutively executed shock pulses in the positive and negative x, y, and z axis of 6 G for up to 11 milliseconds
Storage	Six consecutively executed shock pulses in the positive and negative x, y, and z axis (one pulse on each side of the system) of 71 G for up to 2 milliseconds

## Thermal air restrictions

- Two PSUs are required in redundant mode, however PSU failure is not supported
- Non Dell qualified peripheral cards or peripheral cards greater than 25 W are not supported
- GPU is not supported
- The operating temperature is for a maximum altitude of 950 m for fresh air cooling
- Because of single fan in the system, cooling redundancy is not supported

 **NOTE:** DIMM blank is not required.



## Appendix B. Standards compliance

The system conforms to the following industry standards.

**Table 25. Industry standard documents**

Standard	URL for information and specifications
<b>ACPI</b> Advance Configuration and Power Interface Specification, v2.0c	<a href="https://uefi.org/specsandtesttools">https://uefi.org/specsandtesttools</a>
<b>Ethernet</b> IEEE 802.3-2005	<a href="https://standards.ieee.org/">https://standards.ieee.org/</a>
<b>HDG</b> Hardware Design Guide Version 3.0 for Microsoft Windows Server	<a href="https://microsoft.com/whdc/system/platform/pcdesign/desguide/serverdg.mspx">microsoft.com/whdc/system/platform/pcdesign/desguide/serverdg.mspx</a>
<b>IPMI</b> Intelligent Platform Management Interface, v2.0	<a href="https://intel.com/design/servers/ipmi">intel.com/design/servers/ipmi</a>
<b>DDR4 Memory</b> DDR4 SDRAM Specification	<a href="https://jedec.org/standards-documents/docs/jesd79-4.pdf">jedec.org/standards-documents/docs/jesd79-4.pdf</a>
<b>PCI Express</b> PCI Express Base Specification Rev. 2.0 and 3.0	<a href="https://pcisig.com/specifications/pciexpress">pcisig.com/specifications/pciexpress</a>
<b>PMBus</b> Power System Management Protocol Specification, v1.2	<a href="http://pmbus.org/Assets/PDFS/Public/PMBus_Specification_Part_I_Rev_1-1_20070205.pdf">http://pmbus.org/Assets/PDFS/Public/PMBus_Specification_Part_I_Rev_1-1_20070205.pdf</a>
<b>SAS</b> Serial Attached SCSI, v1.1	<a href="http://www.t10.org/">http://www.t10.org/</a>
<b>SATA</b> Serial ATA Rev. 2.6; SATA II, SATA 1.0a Extensions, Rev. 1.2	<a href="https://sata-io.org">sata-io.org</a>
<b>SMBIOS</b> System Management BIOS Reference Specification, v2.7	<a href="https://dmtf.org/standards/smbios">dmtf.org/standards/smbios</a>
<b>TPM</b> Trusted Platform Module Specification, v1.2 and v2.0	<a href="https://trustedcomputinggroup.org">trustedcomputinggroup.org</a>
<b>UEFI</b> Unified Extensible Firmware Interface Specification, v2.1	<a href="https://uefi.org/specifications">uefi.org/specifications</a>
<b>USB</b> Universal Serial Bus Specification, Rev. 2.7	<a href="https://usb.org/developers/docs">usb.org/developers/docs</a>

## Appendix C Additional resources

**Table 26. Additional resources**

Resource	Description of contents	Location
Installation and Service Manual	This manual, available in PDF format, provides the following information: <ul style="list-style-type: none"> <li>• Chassis features</li> <li>• System Setup program</li> <li>• System indicator codes</li> <li>• System BIOS</li> <li>• Remove and replace procedures</li> <li>• Diagnostics</li> <li>• Jumpers and connectors</li> </ul>	<a href="http://Dell.com/Support/Manuals">Dell.com/Support/Manuals</a>
Getting Started Guide	This guide ships with the system, and is also available in PDF format. This guide provides the following information: <ul style="list-style-type: none"> <li>• Initial setup steps</li> </ul>	<a href="http://Dell.com/Support/Manuals">Dell.com/Support/Manuals</a>
Rack Installation Guide	This document ships with the rack kits, and provides instructions for installing a server in a rack.	<a href="http://Dell.com/Support/Manuals">Dell.com/Support/Manuals</a>
System Information Label	The system information label documents the system board layout and system jumper settings. Text is minimized due to space limitations and translation considerations. The label size is standardized across platforms.	Inside the system chassis cover
Quick Resource Locator (QRL)	This code on the chassis can be scanned by a phone application to access additional information and resources for the server, including videos, reference materials, service tag information, and Dell EMC contact information.	Inside the system chassis cover
Enterprise Infrastructure Planning Tool (EIPT)	The Dell EMC online EIPT enables easier and more meaningful estimates to help you determine the most efficient configuration possible. Use EIPT to calculate the power consumption of your hardware, power infrastructure, and storage.	<a href="http://Dell.com/calc">Dell.com/calc</a>