



HP Z228 Workstation

Maintenance and Service Guide

Copyright Information

© Copyright 2015 Hewlett-Packard Development Company, L.P.

First Edition: April 2015

Part Number: 806122-001

Warranty

Hewlett-Packard Company shall not be liable for technical or editorial errors or omissions contained herein or for incidental or consequential damages in connection with the furnishing, performance, or use of this material. The information in this document is provided “as is” without warranty of any kind, including, but not limited to, the implied warranties of merchantability and fitness for a particular purpose, and is subject to change without notice. The warranties for HP products are set forth in the express limited warranty statements accompanying such products.

Nothing herein should be construed as constituting an additional warranty.

Not all features are available in all editions of Windows 8. This computer may require upgraded and/or separately purchased hardware, drivers and/or software to take full advantage of Windows 8 functionality. Go to <http://www.microsoft.com> for details.

Windows 7: This computer may require upgraded and/or separately purchased hardware and/or a DVD drive to install the Windows 7 software and take full advantage of Windows 7 functionality. Go to <http://www.microsoft.com> for details.

Trademark Credits

ENERGY STAR is a registered trademark owned by the U.S. Environmental Protection Agency (EPA).

Intel, Core, Pentium, and Xeon are trademarks are trademarks of Intel Corporation in the U.S. and other countries.

AMD is a trademark of Advanced Micro Devices, Inc.

NVIDIA® and NVIDIA Quadro® are trademarks and/or registered trademarks of NVIDIA Corporation in the U.S. and other countries.

Windows is a U.S. registered trademark of Microsoft Corporation.

Linux® is the registered trademark of Linus Torvalds in the U.S. and other countries.

Red Hat® is a registered trademark of Red Hat, Inc. in the United States and other countries.

About this guide

This guide provides service and maintenance information, technical details, and configuration guidance for your workstations.



IMPORTANT: Removal and replacement procedures are now available in videos on the HP website.

Go to <http://www.hp.com/go/sml>.

Guide topics

[Hardware overview on page 1](#)

[System management on page 9](#)

[Component replacement information and guidelines on page 36](#)

[Diagnostics and troubleshooting on page 51](#)

[Configuring password security and resetting CMOS on page 75](#)

[Linux technical notes on page 79](#)

[Configuring RAID devices on page 82](#)

[System board designators on page 87](#)



NOTE: View the *HP Workstation User Guide* for your workstation at http://www.hp.com/support/workstation_manuals.

Table of contents

1 Hardware overview	1
Workstation components	1
Front panel	1
Rear panel	2
Chassis components	3
System board components	4
System board architecture	5
Workstation specifications	6
Product specifications	7
Workstation weights and dimensions	7
Environmental specifications	7
Ensuring proper ventilation	8
2 System management	9
Power management and performance features	9
ERP compliance mode	9
Hyper-Threading Technology (HTT)	10
SATA Power Management	10
Intel Turbo Boost Technology	10
BIOS ROM	10
Computer Setup (f10) Utility	10
Using Computer Setup (f10) Utility	12
Computer Setup (f10) Utility—File	13
Computer Setup (f10) Utility—Storage	14
Computer Setup (f10) Utility—Security	16
Computer Setup—Power	19
Computer Setup—Advanced	20
Desktop management	23
Initial computer configuration and deployment	24
Installing a remote system	24
Copying a setup configuration to another computer	24
Updating and managing software	25
HP Client Management Solutions	25
Altiris Client Management Solutions	25
HP SoftPaq Download Manager	26
System Software Manager	26

ROM Flash	26
Remote ROM Flash	26
HPQFlash	26
FailSafe Boot Block	26
Recovering the computer by using FailSafe Boot Block recovery mode	27
Workstation security	27
Asset tracking	27
SATA hard drive security	28
DriveLock applications	28
Using DriveLock	29
Password security	30
Establishing a setup password using Computer Setup (f10) Utility	30
Establishing a power-on password using Computer Setup (f10) Utility	30
Entering a power-on password	31
Entering a setup password	31
Changing a power-on or setup password	32
Deleting a power-on or setup password	32
National keyboard delimiter characters	33
Clearing passwords	33
Chassis security	33
Smart Cover Sensor (optional)	33
Side access panel solenoid lock	34
Cable lock (optional)	34
Fault notification and recovery	34
ECC fault prediction	34
Thermal sensors	34
Programmable power button (Windows only)	34
Changing the power button configuration (Windows only)	35
3 Component replacement information and guidelines	36
Warnings and cautions	37
Service considerations	37
Tools and software requirements	37
Electrostatic discharge (ESD) information	38
Product recycling	39
Component replacement guidelines	40
Battery	40
Cable management	40
CPU (processor) and CPU heatsink	42
Expansion slots	43
Card configuration restrictions for power supplies	43

Choosing an expansion card slot	43
Slot identification and description	44
Installation sequence recommendations	45
Hard drives and optical disc drives	45
Handling hard drives	45
Removal and replacement tips	45
Drive installation and cabling scenarios	46
SATA cable connection guidelines	46
Memory	46
Supported DIMM configurations	46
BIOS errors and warnings	46
DIMM installation guidelines	47
DIMM installation order	47
Power supply	48
Power supply specifications	48
Power consumption and heat dissipation	49
Resetting the power supply	49
System board	49
System cabling	50
System cabling	50
4 Diagnostics and troubleshooting	51
Calling support	51
Locating ID labels	52
Locating warranty information	52
Diagnosis guidelines	52
Diagnosis at startup	52
Diagnosis during operation	53
Troubleshooting checklist	53
HP troubleshooting resources and tools	54
Online support	54
HP Support Center	54
HP Chat Support	54
Customer Advisories, Customer and Security Bulletins, and Customer Notices	54
Product Change Notifications	55
Helpful hints	55
At startup	55
During operation	55
Customer Self Repair	56
Troubleshooting scenarios and solutions	57
Solving minor problems	57

Solving hard drive problems	58
Solving display problems	59
Solving audio problems	61
Solving printer problems	62
Solving power supply problems	63
Testing power supply	63
Using HP PC Hardware Diagnostics (UEFI)	64
Downloading HP PC Hardware Diagnostics (UEFI) to a USB device	64
Diagnostic codes and errors	64
Diagnostic LED and audible (beep) codes	64
LED color definitions	68
POST error messages	68
5 Updating the workstation	73
Updating the workstation after first boot	73
Upgrading the BIOS	73
Determining the current BIOS version	73
Upgrading BIOS	73
Upgrading device drivers	74
6 Configuring password security and resetting CMOS	75
Preparing to configure passwords	75
Resetting the password jumper	76
Clearing and resetting the CMOS	77
Using the CMOS button to reset CMOS	77
Using Computer Setup (f10) Utility to reset CMOS	78
Appendix A Linux technical notes	79
System RAM	79
Audio	79
Network cards	80
Hyper-Threading Technology	80
NVIDIA Graphics Workstations	80
AMD Graphics Workstations	81
Appendix B Configuring RAID devices	82
RAID hard drive maximum and associated storage controller options	83
Supported RAID configurations	83
Configuring Intel SATA RAID	84
Configuring system BIOS	84

Configuring RAID with the Intel utility	85
Software RAID solution	85
Software RAID considerations	85
Performance considerations	86
Configuring software RAID	86
Appendix C System board designators	87
System board designators	87
Index	89





1 Hardware overview

Workstation components

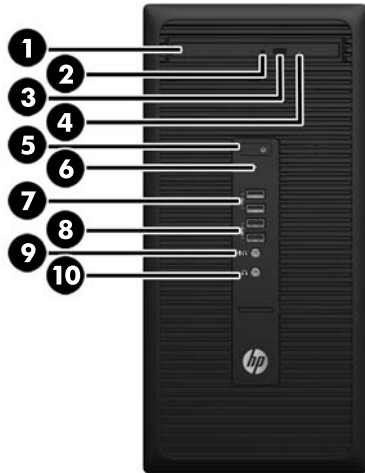
This section describes the workstation components.

Front panel









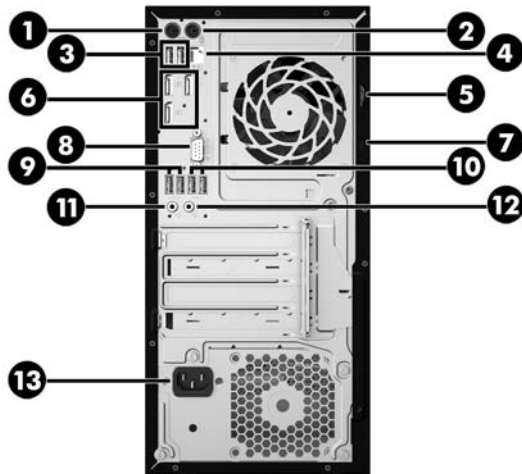



1	Optical drive	6	Hard drive activity light
2	Optical drive activity light	7	 USB 2.0 port (2)
3	Optical drive eject button	8	 USB 3.0 ports (2)
4	Optical drive emergency eject hole	9	 Microphone-Headphone connector*
5	 Power button	10	 Headphone connector

* Software selectable mode, default mode is microphone.

Rear panel



1		PS/2 keyboard connector	8		Serial port connector
2		PS/2 mouse connector	9		USB 3.0 ports (2)
3		USB 2.0 ports (2)	10		USB 2.0 ports (2)
4		RJ-45 Ethernet connector	11		Audio line-out connector
5		Padlock loop	12		Audio line-in connector
6		Dual-Mode DisplayPort (3)	13		Power cord connector
7		Cable lock slot			

NOTE: The labels for the rear panel connectors use industry-standard icons and colors.



NOTE: The DP ports are not supported when the system is configured with Intel Xeon E3-12x0 v3 processors. Also, if a discrete graphics card is installed these ports are disabled by default.



NOTE: Simultaneous usage of integrated Intel HD graphics and discrete graphics cards (in order to drive more than three displays) can be enabled using Computer (f10) Setup Utility. However, HP recommends using only discrete graphics cards to drive three or more displays.

Chassis components

The following figure shows the chassis components of a typical tower workstation layout. Drive configurations can vary.

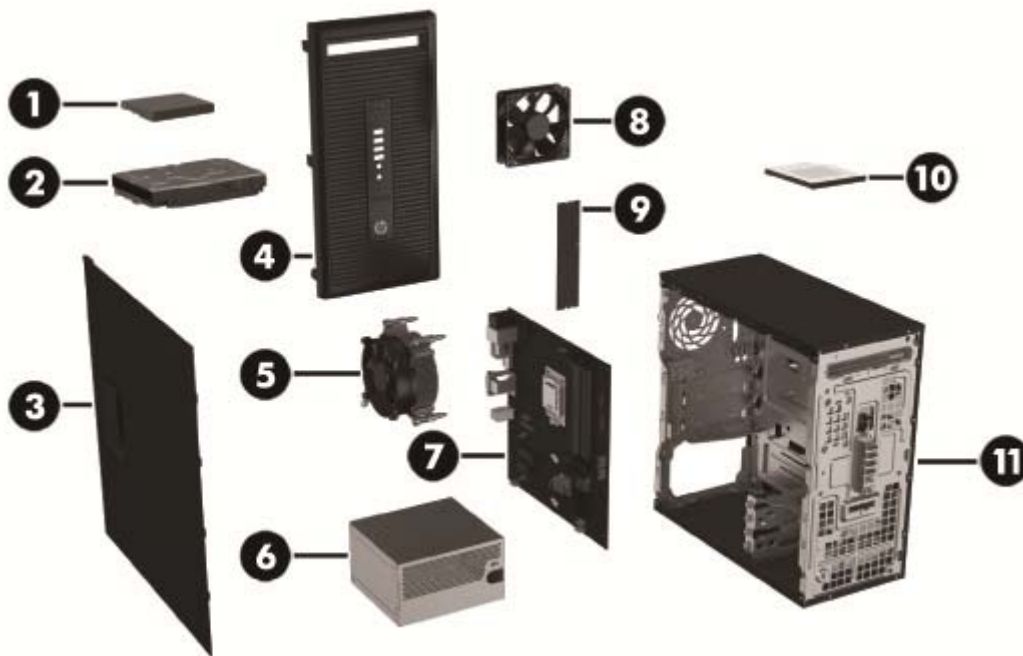

Item	Description	Item	Description
1	Solid-state drive (SSD)	7	System board
2	Hard drive (HDD)	8	System fan
3	Side access panel	9	Memory module
4	Front bezel	10	Slim optical drive
5	Heat sink fan	11	Chassis
6	Power supply		

System board components

The following illustration and table identify the system board components for the tower workstation.

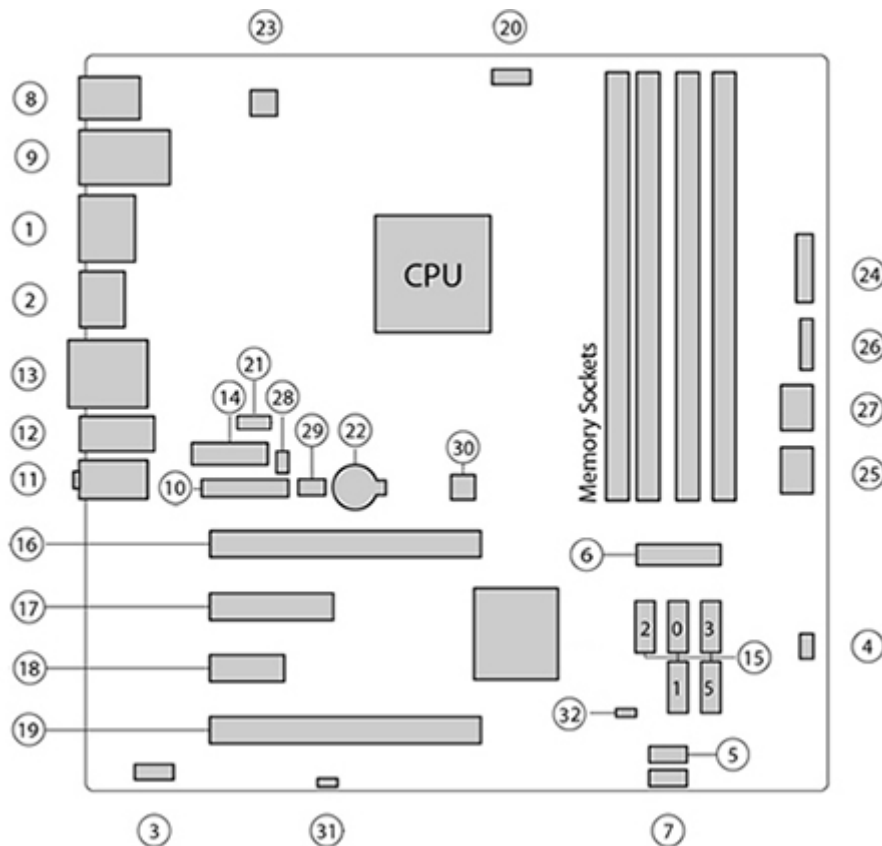

I/O		SATA		Power	
1	Dual-Mode DisplayPort	15	AHCI 6Gb/s	22	Battery
2	DisplayPort			23	Processor
3	Front audio			24	Front power button/LED
4	Front speaker	PCI/PCIe		25	Main power
5	Front USB 2.0	16	PCIe3 x16	26	Power COMM
6	Front USB 3.0	17	PCIe2 x4 (1)	27	SATA power
7	Internal USB 2.0	18	PCIe2 x1	Security	
8	Keyboard / mouse	19	PCIe2 x16 (4)	28	Chassis solenoid lock
9	Network / rear USB 2.0	NOTE: For related expansion card slot information, see Expansion slots on page 43		29	Hood sensor
10	Parallel (option)	Service			
11	Rear audio	Cooling		30	Clear CMOS button
12	Rear USB 2.0/3.0	20	Processor fan	31	ME/AMT flash override
13	Serial	21	Rear fan	32	Password jumper
14	Serial (option)				

System board architecture

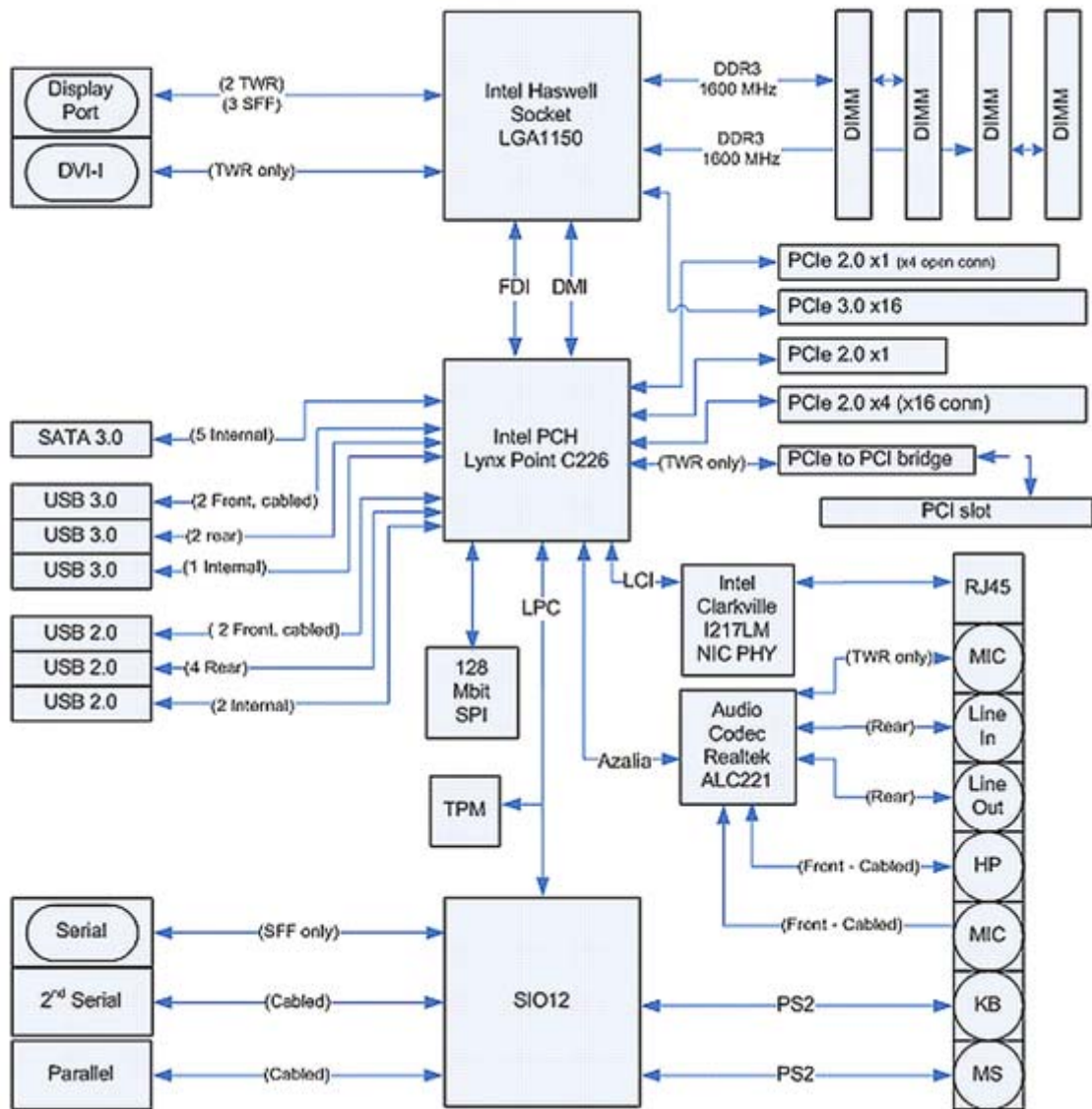

NOTE: The PCIe designators indicate the mechanical connector size and number of electrical PCIe lanes routed to an expansion slot. For example, x16(4) means that the expansion slot is mechanically a x16 length connector, with 4 PCIe lanes supported.

Workstation specifications

Processor technology	<p>Intel Series C226 chipset:</p> <ul style="list-style-type: none">• Support for the Intel Xeon Processor E3 v3 Family or third-generation Intel Core processors up to 95 W• Integrated 2-channel memory controller• Microarchitecture improvements• Integrated graphics (some models)• Advanced Vector Extensions (AVX) to increase floating point performance• Intel DMI2 interface connecting the processor to the I/O controller
Power supply	<ul style="list-style-type: none">• 280 W, 90% efficient, 80 PLUS Gold, compatible with ENERGY STAR Version 5.2 requirements• Supports European Union ERP Lot 6 tier2 power limit of less than 0.5 W in off mode
Memory technology	<ul style="list-style-type: none">• Dual in-line memory modules (DIMMs) based on DDR3 1600MHz technology• Supports error checking and correcting (ECC) and non-ECC DIMMs• Two direct-attach memory channels enable low-latency access and fast data transfer for improved performance• Up to 32 GB system memory (8 GB DIMMs)• 1600 MHz 4, 8 GB ECC unbuffered DIMM• 1600 MHz 4, 8 GB non ECC unbuffered DIMM
Graphics cards	<p>Supports:</p> <ul style="list-style-type: none">• PCIe Gen3 (PCIe3) bus speeds; can support dual PCIe Gen2 graphics cards in mechanical PCIe x16 slots• Multiple graphics cards, provided their total power usage is within 75 W• Up to two displays with integrated Intel HD graphics (depending on processor type)• Up to six 2D displays or four 3D displays <p>NOTE: Most supported Intel Core processors provide Intel HD Graphics 4400/4600; Intel Xeon processors with model designations that end in "----5" provide Intel HD Graphics P4600.</p> <p>NOTE: To drive more than three displays, use Computer Setup (f10) Utility to intermix integrated Intel HD graphics and discrete graphics cards.</p>
I/O technology	<ul style="list-style-type: none">• RAID configurations for SATA RAID levels 0, 1• Supports eSATA (3.0 Gbps) using an optional adapter• Six external and two internal USB 2.0 ports• Four external USB 3.0 ports• Serial headers that can be used with an optional PCI bulkhead connector

Product specifications

Workstation weights and dimensions

Weight	Standard configuration	7.0 kg (15.4 lb)
	Minimum configuration	6.8 kg (15.0 lb)
	Maximum configuration	7.4 kg (16.3 lb)
Chassis dimensions	Height	35.5 cm (14.0 in)
	Width	17.0 cm (6.7 in)
	Depth	35.8 cm (14.0 in)

Environmental specifications

Temperature	Operating: 5°C to 35°C (40°F to 95°F)
	Non-operating: -40°C to 60°C (-40°F to 140°F)
	NOTE: Derate by 1°C (1.8°F) for every 305 m (1,000 ft) altitude over 1,524 m (5,000 ft).
Humidity	Operating: 8% to 85% relative humidity, non-condensing
	Non-operating: 8% to 90% relative humidity, non-condensing
Altitude	Operating: 0 to 3,048 m (10,000 ft)
	Non-operating: 0 to 9,144 m (30,000 ft)
Shock	Operating: ½-sine: 40g, 2-3ms (~62 cm/s)
	Non-operating:
	<ul style="list-style-type: none">• ½-sine: 160 cm/s, 2-3ms (~105g)• square: 422 cm/s, 20g
	NOTE: Values represent individual shock events and do not indicate repetitive shock events.
Vibration	Operating Random: 0.5g (rms), 5-300 Hz, up to 0.0025g ² /Hz
	Non-Operating: random: 2.0g (rms), 5-500 Hz, up to 0.0150g ² /Hz
	NOTE: Values do not indicate continuous vibration.

Ensuring proper ventilation

Proper ventilation for the system is important for workstation operation. Follow these guidelines:

- Operate the workstation on a sturdy, level surface.
- Provide at least 15.24 cm (6 inches) of clearance at the front and back of the workstation. (Workstation models vary.)

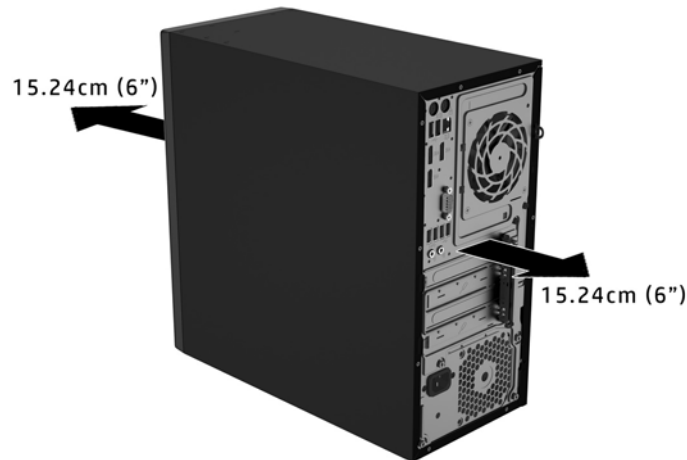

- Be sure that the ambient air temperature falls within the environmental specifications listed in this document.

 **NOTE:** The ambient upper limit of 35°C (95°F) is only good up to 1524 m (5000 ft) elevation. There is a 1°C (33.8°F) per 304.8 m (1000 ft) derating above 1524 m (5000 ft). So, at 3,048 m (10,000 ft), the upper ambient air temperature limit is 30°C (86°F).

- For cabinet installation, be sure that adequate cabinet ventilation and the ambient temperature within the cabinet does not exceed specified limits.
- Never restrict the incoming or outgoing airflow of the workstation by blocking any vents or air intakes, as shown in the following figure.

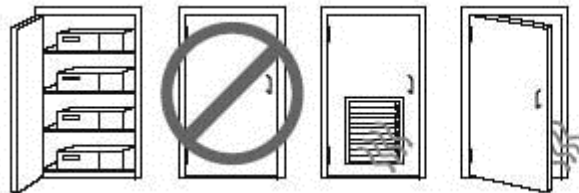

2 System management

This section describes the tools and utilities that provide system management for the workstation.

Topics

[Power management and performance features on page 9](#)

[BIOS ROM on page 10](#)

[Computer Setup \(f10\) Utility on page 10](#)

[Desktop management on page 23](#)

Power management and performance features

ERP compliance mode

This computer provides ERP compliance mode capability.

When enabled, the computer shuts down to the lowest possible power state. The computer must then be turned on with the power button. One of the effects is that "wake on LAN" is disabled.

When disabled, the computer powers down conventionally.

Enabling ERP compliance mode

1. Press **f10** during startup.
2. Using the arrow keys, select the **Power > Hardware Power Management > S5 Maximum Power Savings**, then select **Enable**.
3. Press **f10** to accept the change.
4. Select **File > Save Change and Exit**, and then press **enter** to accept the change.
5. If using Windows 8 or Windows 8.1, boot to Windows and search in the Start Menu for the setting **Change what the power buttons do**. Uncheck **Turn on fast startup (recommended)**. If the checkbox is not available, select **Change settings that are currently unavailable** at the top of the window.

Disabling ERP compliance mode

1. Press **f10** during startup.
 2. Using the arrow keys, select **Power > Hardware Power Management > S5 Maximum Power Savings**, then select **Disable**.
 3. Press **f10** to accept the change.
 4. Select **File > Save Change and Exit**, and then press **enter** to accept the change.
 5. If using Windows 8 or Windows 8.1, boot to Windows and search in the Start Menu for the setting **Change what the power buttons do**. Check **Turn on fast startup (recommended)**. If the checkbox is not available, select **Change settings that are currently unavailable** at the top of the window.
-

Hyper-Threading Technology (HTT)

This computer supports HTT, an Intel-proprietary technology that improves processor performance through parallelization of computations (doing multiple tasks at once).

The operating system treats an HTT-enabled processor as two virtual processors, and shares the workload between them when possible. This feature requires that the operating system support multiple processors and be specifically optimized for HTT.

Use Computer Setup (f10) Utility to enable HTT.

Go to <http://www.hp.com/go/quickspecs> to determine if your CPU supports HTT.

SATA Power Management

SATA Power Management enables or disables SATA bus and/or device power management.

Intel Turbo Boost Technology

Your workstation supports Intel® Turbo Boost Technology.

This feature enables the CPU to run at a higher than normal rate. When all CPU cores are not necessary for the workload, inactive cores are turned off and power is diverted to the active cores to increase their performance.

Turbo Boost is enabled and disabled with Computer Setup (f10) Utility.

Go to <http://www.hp.com/go/quickspecs> to determine if your CPU supports Turbo Boost.

BIOS ROM

The BIOS ROM is a collection of machine language applications stored as firmware in ROM. It includes functions such as Power-On Self-Test (POST), PCI device initialization, Plug and Play support, power management, and Computer Setup (f10) Utility.

Go to <http://www.hp.com/go/quickspecs> to review the latest BIOS ROM specifications.

Computer Setup (f10) Utility

Use Computer Setup (f10) Utility to do the following:

- Change factory default settings.
- Set the system date and time.
- Set, view, change, or verify the system configuration, including settings for processor, graphics, memory, audio, storage, communications, and input devices.
- Modify the boot order of bootable devices such as hard drives, optical drives, or USB flash media devices.
- Select Post Messages Enabled or Disabled to change the display status of Power-On Self-Test (POST) messages. Post Messages Disabled suppresses most POST messages, such as product name, and other non-error text messages. If a POST error occurs, the error is displayed regardless of the mode selected. To manually switch to Post Messages Enabled during POST, press any key (except **f1** through **f12**).
- Establish an Ownership Tag, the text of which is displayed each time the system is turned on or restarted.
- Enter the Asset Tag or property identification number assigned by the company to this computer.

- Enable the power-on password prompt during system restarts (warm boots) as well as during power-on.
- Establish a setup password that controls access to Computer Setup (f10) Utility and the settings described in this section.
- Secure integrated I/O functionality, including the serial or USB ports, audio, or embedded NIC, so that they cannot be used until they are unsecured.
- Enable or disable removable media boot ability.
- Solve system configuration errors detected but not automatically fixed during the Power-On Self-Test (POST).
- Replicate the system setup by saving system configuration information on a USB device and restoring it on one or more computers.
- Execute self-tests on a specified ATA hard drive (when supported by drive).
- Enable or disable DriveLock security (when supported by drive).

Using Computer Setup (f10) Utility

To start Computer Setup (f10) Utility, complete the following steps:

1. Turn on or restart the computer.
2. Repeatedly press **f10** when the monitor light turns green.



NOTE: If you do not press **f10** at the appropriate time, you must restart the computer and again repeatedly press **f10** when the monitor light turns green.

3. A choice of five headings appears in the Computer Setup (f10) Utility menu: File, Storage, Security, Power, and Advanced.
4. Use the arrow (left and right) keys to select the appropriate heading. Use the arrow (up and down) keys to select the option you want, then press **enter**. To return to the Computer Setup (f10) Utility menu, press **esc**.
5. To apply and save changes, select **File > Save Changes and Exit**.
 - If you have made changes that you do not want applied, select **Ignore Changes and Exit**.
 - To reset to factory settings or previously saved default settings (some models), select **Apply Defaults and Exit**. This option will restore the original factory system defaults.



NOTE: Not all settings shown in the following sections are available for all models



CAUTION: Do NOT turn the computer power OFF while the BIOS is saving Computer Setup (f10) Utility changes because the CMOS might become corrupted. It is safe to turn off the computer only after exiting Computer Setup (f10) Utility screen.

Heading	Table
File	Computer Setup (f10) Utility—File on page 13
Storage	Computer Setup (f10) Utility—Storage on page 14
Security	Computer Setup (f10) Utility—Security on page 16
Power	Computer Setup—Power on page 19
Advanced	Computer Setup—Advanced on page 20

Computer Setup (f10) Utility—File



NOTE: Support for specific Computer Setup (f10) Utility options might vary depending on the hardware configuration.

Option	Description
System Information	Lists: <ul style="list-style-type: none">• Product name• Manufacturer• SKU number• Processor type/speed/stepping• Memory Size (Channel A, Channel B) Installed memory size/speed, number of channels (single or dual) (if applicable)• Integrated MAC address for embedded, enabled NIC (if applicable)• Chassis serial number• Asset tracking number• System Board ID• System Board CT Number• System BIOS (includes family name, version, and date)• ME firmware version
About	Displays copyright notice.
Set Time and Date	Allows you to set system time and date.
Flash System ROM	Allows you to update the system ROM with a BIOS image file located on removable media.
Replicated Setup	Save to Removable Media Saves system configuration to a formatted USB flash media device. Restore from Removable Media Restores system configuration from a USB flash media device.
Default Setup	Save Current Settings as Default Saves the current system configuration settings as the default. Restore Factory Settings as Default Restores the factory system configuration settings as the default.
Apply Defaults and Exit	Applies the currently selected default settings and clears any established passwords.
Ignore Changes and Exit	Exits Computer Setup (f10) Utility without applying or saving any changes.
Save Changes and Exit	Saves changes to system configuration or default settings and exits Computer Setup (f10) Utility.

Computer Setup (f10) Utility—Storage

 **NOTE:** Support for specific Computer Setup (f10) Utility options may vary depending on the hardware configuration.

Option	Description
Device Configuration	<p>Lists all installed BIOS-controlled storage devices.</p> <p>When a device is selected, detailed information and options are displayed. The following options might be presented:</p> <ul style="list-style-type: none">• Hard Drive: Size, model, firmware version, serial number, connector color. <p>Translation mode (ATA disks only)</p> <p>Lets you select the translation mode to be used for the device. This enables the BIOS to access disks partitioned and formatted on other systems and may be necessary for users of older versions of UNIX (e.g., SCO UNIX version 3.2). Options are Automatic, Bit-Shift, LBA Assisted, User, and Off.</p> <p>Available only when the drive translation mode is set to User, allows you to specify the parameters (logical cylinders, heads, and sectors per track) used by the BIOS to translate disk I/O requests (from the operating system or an application) into terms the hard drive can accept. Logical cylinders may not exceed 1024. The number of heads may not exceed 256. The number of sectors per track may not exceed 63.</p> <p>CAUTION: Ordinarily, the translation mode selected automatically by the BIOS should not be changed. If the selected translation mode is not compatible with the translation mode that was active when the disk was partitioned and formatted, the data on the disk will be inaccessible.</p> <ul style="list-style-type: none">• CD-ROM: Model, firmware version, serial number, connector color (not included for USB CD-ROM).• SSD Life Used <p>NOTE: Displays for solid-state drives.</p> <ul style="list-style-type: none">• SMART (ATA disks only)• Diskette: Model and firmware version. <p>NOTE: Displays for USB diskette drives.</p> <ul style="list-style-type: none">• Default Values (ATA disks only) <p>See Translation Mode above for details.</p> <p>SATA Defaults</p>
Storage Options	<p>eSATA Port</p> <p>Allows you to set a SATA port as an eSATA port for use with an external drive. Default is enabled.</p> <p>This setting affects only the port with the black connector, labeled as eSATA on the system board. This port should have the eSATA back panel connector attached to use eSATA drives. For more information, see the eSATA white paper at www.hp.com.</p> <p>SATA Emulation</p> <p>Allows you to choose how the SATA controller and devices are accessed by the operating system. There are three supported options.</p> <p>CAUTION: SATA emulation changes may prevent access to existing hard drive data and degrade or corrupt established volumes.</p> <p>IDE—Is the most backward-compatible setting of the three options. Operating systems usually do not require additional driver support in IDE mode.</p> <p>RAID (default option)—Allows DOS and boot access to RAID volumes. Use this mode with the RAID device driver loaded in the operating system to take advantage of RAID features.</p>

AHCI—Allows operating systems with AHCI device drivers loaded to take advantage of more advanced features of the SATA controller.

NOTE: The RAID/AHCI device driver must be installed prior to attempting to boot from a RAID/AHCI volume. If you attempt to boot from a RAID/AHCI volume without the required device driver installed, the system will crash (blue screen). RAID volumes may become corrupted if they are booted to after disabling RAID.

Removable Media Boot

Enables/disables ability to boot the system from removable media. Default is enabled.

Max eSATA Speed

Allows you to choose 1.5 Gbps or 3.0 Gbps as the maximum eSATA speed. By default, the speed is limited to 1.5 Gbps for maximum reliability.

CAUTION: Consult your eSATA drive and cable manufacturer before enabling 3.0 Gbps speed. Some drive and cable combinations may not run reliably at 3.0 Gbps.

Boot Order

Allows you to:

- **UEFI Boot Sources:** Specify the order in which UEFI boot sources (such as a internal hard drive, USB hard drive, USB optical drive, or internal optical drive) are checked for a bootable operating system image. Each device on the list may be individually excluded from or included for consideration as a bootable operating system source.

UEFI boot sources always have precedence over legacy boot sources.

- **Legacy Boot Sources:** Specify the order in which legacy boot sources (such as a network interface card, internal hard drive, USB optical drive, or internal optical drive) are checked for a bootable operating system image. Each device on the list may be individually excluded from or included for consideration as a bootable operating system source.

Specify the order of attached hard drives. The first hard drive in the order will have priority in the boot sequence and will be recognized as drive C (if any devices are attached).

Shortcut to Temporarily Override Boot Order

To boot **one time** from a device other than the default device specified in Boot Order, restart the computer and press **esc** (to access the boot menu) and then **f9** (Boot Order), or press **f9** (bypassing the boot menu) when the monitor light turns green. After POST is completed, a list of bootable devices is displayed. Use the arrow keys to select the preferred bootable device and press **enter**. The computer then boots from the selected non-default device for this one time.

Computer Setup (f10) Utility—Security



NOTE: Support for specific Computer Setup (f10) Utility options may vary depending on the hardware configuration.

Option	Description
Setup Password	<p>Allows you to set and enable a setup (administrator) password.</p> <p>NOTE: If the setup password is set, you must enter it to change Computer Setup (f10) Utility options, flash the ROM, and make changes to certain plug and play settings under Windows.</p>
Power-On Password	<p>Allows you to set and enable a power-on password. The power-on password prompt appears after a power cycle or reboot. If the user does not enter the correct power-on password, the unit will not boot.</p>
<p>Password Options</p> <p>(This selection appears only if a power-on password or setup password is set.)</p>	<p>Allows you to enable/disable:</p> <ul style="list-style-type: none"> • Lock Legacy Resources (determines whether or not Windows Device Manager is allowed to change resource settings for serial and parallel ports). • Stringent security (enabling the stringent password disables the ability to reset the password by moving the jumper on the system board). Default is disabled. <p>CAUTION: If you enable the stringent security feature and you forget the setup password or the power-on password, the computer is inaccessible and can no longer be used.</p> <p>If you lose or forget the password, the system board must be replaced. This scenario is not covered under warranty.</p> <p>To prevent the computer from becoming permanently unusable, record your configured setup password or power-on password in a safe place away from your computer. Without these passwords, the computer cannot be unlocked.</p> <ul style="list-style-type: none"> • Setup Browse Mode (appears if a setup password is set) (allows viewing, but not changing, Computer Setup (f10) Utility Options without entering setup password). Default is enabled. • Password prompt on f9, f11, and f12 (requires setup password to use these boot functions). Default is enabled. • Network Server Mode. Default is disabled.
<p>Smart Cover</p> <p>(This selection appears only if a hood sensor is installed)</p>	<p>Allows you to:</p> <ul style="list-style-type: none"> • Lock/unlock the Cover Lock. • Set the Cover Removal Sensor to Disable/Notify User/Setup Password. <p>NOTE: <i>Notify User</i> alerts the user that the sensor has detected that the cover has been removed. <i>Setup Password</i> requires that the setup password be entered to boot the computer if the sensor detects that the cover has been removed.</p>
Device Security	<p>Allows you to set Device Available/Device Hidden (default is Device Available) for:</p> <ul style="list-style-type: none"> • Embedded security device • System audio • USB controller (varies by model) • Network controller <p>NOTE: You must disable AMT before trying to hide the network controller.</p> <ul style="list-style-type: none"> • Parallel port • SATA ports (varies by model)
USB Security	<p>Allows you to set Enabled/Disabled (default is Enabled) for:</p> <ul style="list-style-type: none"> • Front USB Ports

	<ul style="list-style-type: none"> • Rear USB Ports • Accessory USB Ports
Slot Security	Allows you to Enable/Disable Option ROM Download for each slot. Selective disabling of Option ROM downloads can help manage limited Option ROM space. Limit PCIe Frequency to Gen1, Gen2, Gen3. Runs slot at Gen1, Gen2, or Gen3 frequency.
Network Boot	Enables/disables the computer's ability to boot from an operating system installed on a network server. (Feature available on NIC models only; the network controller must be either a PCI expansion card or embedded on the system board.) Default is enabled.
System IDs	<p>Allows you to set:</p> <ul style="list-style-type: none"> • Asset tag (18-byte identifier), a property identification number assigned by the company to the computer. • Ownership tag (80-byte identifier) displayed during POST. • Universal Unique Identifier (UUID) number. The UUID can only be updated if the current chassis serial number is invalid. (These ID numbers are normally set in the factory and are used to uniquely identify the system.) • Keyboard locale setting for System ID entry.
Master Boot Record Security	<p>Enables/disables Master Boot Record (MBR) security.</p> <p>The MBR contains information needed to successfully boot from a disk and to access the data stored on the disk. Master Boot Record Security may prevent unintentional or malicious changes to the MBR, such as those caused by some viruses or by the incorrect use of certain disk utilities. It also allows you to recover the "last known good" MBR, should changes to the MBR be detected when the system is restarted.</p> <p>When MBR Security is enabled, the BIOS prevents any changes being made to the MBR of the current bootable disk while in MS-DOS or Windows Safe Mode.</p> <p>NOTE: Most operating systems control access to the MBR of the current bootable disk; the BIOS cannot prevent changes that may occur while the operating system is running.</p> <p>Restores the backup Master Boot Record to the current bootable disk. Default is disabled.</p> <p>Only appears if all of the following conditions are true:</p> <ul style="list-style-type: none"> • MBR security is enabled • A backup copy of the MBR has been previously saved • The current bootable disk is the same disk from which the backup copy was saved <p>CAUTION: Restoring a previously saved MBR after a disk utility or operating system has modified the MBR, may cause the data on the disk to become inaccessible. Only restore a previously saved MBR if you are confident that the current bootable disk MBR has been corrupted or infected with a virus.</p>
System Security (these options are hardware dependent)	<ul style="list-style-type: none"> • Data Execution Prevention—(Enable/Disable). Helps prevent operating system security breaches. Default is enabled. • SVM CPU Virtualization—(Enable/Disable). Controls the virtualization features of the processor. Changing this setting requires that you turn off the computer and then turn it back on. Default is disabled. • Virtualization Technology (VTx)—(Enable/Disable). Controls the virtualization features of the processor. Changing this setting requires that you turn off the computer and then turn it back on. Default is disabled. • Virtualization Technology Directed I/O (VTd)— (Enable/Disable). Controls virtualization DMA remapping features of the chipset. Changing this setting requires that you turn off the computer and then turn it back on. Default is disabled. • Trusted Execution Technology—(Enable/Disable). Controls the underlying processor and chipset features needed to support a virtual appliance. Changing this setting requires that you turn off the

computer and then turn it back on. Default is disabled. To enable this feature you must enable the following features:

- Embedded Security Device Support
- Virtualization Technology
- Virtualization Technology Directed I/O
- Embedded Security Device—(Enable/Disable). Permits activation and deactivation of the Embedded Security Device.

NOTE: To configure the Embedded Security Device, a setup password must be set.

- Reset to Factory Settings (Do not reset/Reset)—Resetting to factory defaults erases all security keys and leaves the device in a disabled state. Changing this setting requires that you restart the computer. Default is Do not reset.

CAUTION: The embedded security device is a critical component of many security schemes. Erasing the security keys will prevent access to data protected by the Embedded Security Device. Choosing Reset to Factory Settings may result in significant data loss.

- Measure boot variables/devices to PCR1—Typically, the computer measures the boot path and saves collected metrics to PCR5 (a register in the Embedded Security Device). Bitlocker tracks changes to any of these metrics and forces the user to re-authenticate if it detects any changes. Enabling this feature lets you set Bitlocker to ignore detected changes to boot path metrics, thereby avoiding re-authentication issues associated with USB keys inserted in a port. Default is enabled.

System Security (continued)

OS management of Embedded Security Device—(Enable/Disable). This option allows the user to limit OS control of the Embedded Security Device. Default is enabled. This option is automatically disabled if Trusted Execution Technology is enabled.

- Reset of Embedded Security Device through OS—(Enable/Disable). This option allows the user to limit the operating system ability to request a Reset to Factory Settings of the Embedded Security Device. Default is disabled.

NOTE: To enable this option, a Setup password must be set.

- No PPI provisioning (Windows 8 only)—This option lets you set Windows 8 to bypass the PPI (Physical Presence Interface) requirement and directly enable and take ownership of the TPM on first boot. You cannot change this setting after TPM is owned/initialized, unless the TPM is reset. Default is disabled for systems other than Windows 8, and enabled for Windows 8.
- Allow PPI policy to be changed by OS. Enabling this option allows the operating system to execute TPM operations without Physical Presence Interface. Default is disabled.

NOTE: To enable this option, a Setup password must be set.

DriveLock Security

Allows you to assign or modify a master or user password for hard drives. When this feature is enabled, the user is prompted to provide one of the DriveLock passwords during POST. If neither is successfully entered, the hard drive will remain inaccessible until one of the passwords is successfully provided during a subsequent cold-boot sequence.

NOTE: This selection will only appear when at least one drive that supports the DriveLock feature is attached to the system.

Secure Boot Configuration

- Legacy Support—Enable/Disable. Allows you to turn off all legacy support on the computer, including booting to DOS, running legacy graphics cards, booting to legacy devices, and so on. If set to disable, legacy boot options in **Storage > Boot Order** are not displayed. Default is enabled.
- Secure Boot—Enable/Disable. Allows you to make sure an operating system is legitimate before booting to it, making Windows resistant to malicious modification from preboot to full OS booting, preventing firmware attacks. UEFI and Windows Secure Boot only allow code signed by pre-approved digital certificates to run during the firmware and OS boot process. Default is disabled, except for Windows 8 systems which have this setting enabled. Secure Boot enabled also sets **Legacy Support** to disabled.
- Key Management—This option lets you manage the custom key settings.

- Clear Secure Boot Keys—Don't Clear/Clear. Allows you to delete any previously loaded custom boot keys. Default is Don't Clear.
- Key Ownership—HP Keys/Custom Keys. Selecting Custom Mode allows you to modify the contents of the secure boot signature databases and the platform key (PK) that verifies kernels during system start up, allowing you to use alternative operating systems. Selecting HP Keys causes the computer boot using the preloaded HP-specific boot keys. Default is HP Keys.
- Fast Boot—Enable/Disable. Fast boot disables the ability to interrupt boot, such as pressing **f** keys to access items before the operating system loads. Default is disabled.

NOTE: If Windows 8 detects a serious error, it will interrupt the boot process automatically and display advanced boot options.

From the Start screen, you can press **shift** and select **Restart** to boot to a device or troubleshoot your computer.

Computer Setup—Power



NOTE: Support for specific Computer Setup Power options might vary depending on the hardware configuration.

Option	Description
OS Power Management	<ul style="list-style-type: none"> • Runtime Power Management—Enable/Disable. Allows certain operating systems to reduce processor voltage and frequency when the current software load does not require the full capabilities of the processor. Default is enabled. • Idle Power Savings—Extended/Normal. Allows certain operating systems to decrease the processor's power consumption when the processor is idle. Default is extended. • ACPI S3 PS2 Mouse Wake Up—Enable/Disable: Enables or disables waking from S3 due to any PS2 mouse activity or a button click. • Unique Sleep State Blink Rates—Enable/Disable. This feature is designed to provide a visual indication of what sleep state the system is in. Each sleep state has a unique blink pattern. Default is disabled. <p>NOTE: For Windows 8 systems with Fast Boot support, a normal shutdown goes to the S4 state, not the S5 state.</p> <ul style="list-style-type: none"> ◦ S0 (On)—Solid green LED. ◦ S3 (Stand By)—3 blinks at 1Hz (50% duty cycle) followed by a pause of 2 seconds. (green LED)—Repeated cycles of 3 blinks and a pause. ◦ S4 (Hibernation)—4 blinks at 1Hz (50% duty cycle) followed by a pause of 2 seconds. (green LED)—Repeated cycles of 4 blinks and a pause. ◦ S5 (Soft Off)—LED is off.
Hardware Power Management	<ul style="list-style-type: none"> • SATA Power Management—Enables or disables SATA bus and/or device power management. Default is enabled. • S5 Maximum Power Savings—Turns off power to all nonessential hardware when system is off to meet EUP Lot 6 requirement of less than 0.5 Watt power usage. Default is disabled.
Thermal	<p>Fan idle mode—This bar graph controls the minimum permitted fan speed.</p> <p>NOTE: This setting only changes the minimum fan speed. The fans are still automatically controlled.</p>

Computer Setup—Advanced



NOTE: Support for specific Computer Setup options may vary depending on the hardware configuration.

Option	Heading
Power-On Options	<p>Allows you to set:</p> <ul style="list-style-type: none">• POST messages—(Enable/Disable). This feature causes the system to display POST error messages, which are error messages displayed on the monitor during the Power-On Self-Test if the BIOS encounters some kind of problem while starting the computer. A POST error message will display on screen only if the computer is capable of booting this far. If the POST detects an error before this point, a beep code is generated instead. Default is disabled.• Press the esc key for Startup Menu—(Enable/Disable). This feature controls the display of the text “Press the esc key for Startup Menu” during POST. Neither this text nor any other (for example, the Ownership Tag) is displayed on Windows 8 systems that have Fast Boot support.• Option ROM Prompt—(Enable/Disable). This feature causes the system to display a message before loading option ROMs. Default is enabled.• After Power Loss—(off/on/previous state). Default is Power off. Setting this option to:<ul style="list-style-type: none">◦ Power off—Causes the computer to remain powered off when power is restored.◦ Power on—Causes the computer to turn on automatically as soon as power is restored.◦ Previous state—Causes the computer to turn on automatically as soon as power is restored, if it was on when power was lost. <p>NOTE: If you turn off the computer using the switch on a power strip, you will not be able to use the suspend/sleep feature or the Remote Management features.</p> <ul style="list-style-type: none">• POST Delay (in seconds). This feature adds a user-specified delay to the POST process. This delay is sometimes needed for hard drives that spin up so slowly that they are not ready to boot by the time POST is finished. The POST delay also gives you more time to select f10 to enter Computer Setup (f10) Utility. Default is None.• Remote Wakeup Boot Source (remote server/local hard drive). Default is Local hard drive.• Factory Recovery Boot Support—(Enable/Disable). This feature enables the BIOS to redirect the boot to a recovery partition on the user hard drive, if one is present. Some versions of the recovery software honor the f11 key press even when this feature is disabled. Default is disabled.• Bypass f1 Prompt on Configuration Changes— (Enable/Disable). Allows you bypass the confirmation step after changes are made. Default is enabled.
BIOS Power-On	This feature enables you to specify a time for the computer to start automatically.
Onboard Devices	<p>Allows you to set resources for or disable Legacy devices.</p> <p>Select the Legacy device's IRQ, DMA, and I/O Range. The settings may not take effect for all operating systems. To hide a device from the operating system, see Security > Device Security.</p>
Bus Options	<p>Allows you to enable or disable:</p> <ul style="list-style-type: none">• PCI SERR# Generation—(Enable/Disable) Default is enabled.• PCI VGA Palette Snooping—(Enable/Disable) Sets the VGA palette snooping bit in PCI configuration space; only needed when more than one graphics controller is installed. Default is disabled.• PCI Latency Timer—Sets PCI Clock speed. (32/64/96/128/160/192/224/248). 128 PCI Clocks is the default.
Device Options	<p>Allows you to set:</p> <ul style="list-style-type: none">• Turbo Mode—(Enable/Disable). Allows you to enable and disable the Intel Turbo Mode feature, which allows one core of the system to run at a higher than standard frequency and power if other cores are idle. Default is enabled.

	<ul style="list-style-type: none"> • S5 Wake on LAN—(Enable or Disable) • Num Lock State at Power-On—(On or Off). Default is off. • IGD Memory—(32, 64, 128, 256, 512, 1024) Controls how much system RAM is reserved for use by the internal graphics device. The value you choose is allocated permanently to graphics and is unavailable to the operating system. For example, if you set this value to 512M on a system with 2 GB of RAM, the system always allocates 512 MB for graphics and the other 1.5 GB for use by the BIOS and operating system. • Integrated Video (Enable/Disable). Use this option to disable the integrated video controller when another video controller is present in the system. Default is enabled. • Internal Speaker (does not affect external speakers)—(Enable/Disable). Default is enabled. • USB EHCI Port Debug—(Enable/Disable) • Multi-Processor—(Enable/Disable). Use this option to disable multi-processor support under the OS. Default is enabled. • Hyper threading—(Enable/Disable). Use this option to disable processor hyper-threading.
Slot Settings	Lets you Enable/Disable Option ROM Download for each slot. Selective disabling of Option ROM downloads can help manage limited Option ROM space. Limit PCIe Frequency to Gen1, Gen2, Gen3. Runs slot at Gen1, Gen2, or Gen3 frequency.
VGA Configuration	Displayed only if there is an add-in video card in the system. Allows you to specify which VGA controller will be the “boot” or primary VGA controller.
Management Operations	Allows you to set: <ul style="list-style-type: none"> • AMT—(Enable/Disable). Allows you to enable or disable functions of the embedded Management Engine (ME) such as Active Management Technology (AMT). If set to disable, the Management Engine is set to a temporarily disabled state and will not provide functions beyond necessary system configuration. Default is enabled. • Unconfigure AMT/ME—(Enable/Disable). Allows you to unconfigure any provisioned management settings for AMT. The AMT settings are restored to factory defaults. This feature should be used with caution as AMT will not be able to provide any set AMT management functions once unconfigured. Default is disabled. • Hide Unconfigure ME Confirmation Prompt—(Enable/Disable). Allows you to set the system to not display the confirmation to unconfigure ME. • Watchdog Timer—(Enable/Disable). Allows you to set amount of time for an operating system and BIOS watchdog alert to be sent if the timers are not deactivated. BIOS watchdog is deactivated by BIOS and would indicate that a halt occurred during execution if the alert is sent to the management console. An operating system alert is deactivated by the operating system image and would indicate that a hang occurred during its initialization. Default is enabled.
Option ROM Launch Policy	<ul style="list-style-type: none"> • PXE Option ROMs—(Legacy, UEFI Only/Do Not Launch) • StorageOption ROMs—(Legacy, UEFI Only/Do Not Launch) • Video Options—(Legacy, UEFI Only)
Connected BIOS	<ul style="list-style-type: none"> • Connected BIOS—(Enable/Disable) • Use Proxy—(Enable/Disable)
Update BIOS via Network	<ul style="list-style-type: none"> • Update BIOS via Network—(Enable/Disable) • Update Source • Automatic BIOS Update Setting—(Enable/Disable)
Intel Ethernet Connection	<ul style="list-style-type: none"> • Port Configuration Menu <ul style="list-style-type: none"> ◦ UEFI Driver ◦ Adapter PBA

-
- Chip Type
 - PCI Device ID
 - PCI Bus:Device:Function
 - Link Status—(Enable/Disable)
 - Factory MAC Address
 - NIC Configuration
 - Link Speed
 - Wake on LAN—(Enable/Disable)
 - Blink LEDs—(Range 0–15 seconds)
-

Desktop management

This section summarizes capabilities, features, and key components of computer management.

Topics

[Initial computer configuration and deployment on page 24](#)

[Installing a remote system on page 24](#)

[Copying a setup configuration to another computer on page 24](#)

[Updating and managing software on page 25](#)

[HP Client Management Solutions on page 25](#)

[Altiris Client Management Solutions on page 25](#)

[HP SoftPaq Download Manager on page 26](#)

[System Software Manager on page 26](#)

[ROM Flash on page 26](#)

[FailSafe Boot Block on page 26](#)

[Workstation security on page 27](#)

[Fault notification and recovery on page 34](#)

[Programmable power button \(Windows only\) on page 34](#)



NOTE: Support for specific features described in this guide can vary by model and software version.

Initial computer configuration and deployment

The computer includes a preinstalled system software image. After a brief software unbundling process, the computer is ready to use.

If you prefer to replace the preinstalled software image with a customized set of system and application software, you can deploy a customized software image by:

- Installing additional software applications after unbundling the preinstalled software image
- Using a disk-cloning process to copy the contents from one hard drive to another

The HDD-based HP Recovery Manager ROM-based setup, and ACPI hardware provide further assistance with recovery of system software, configuration management and troubleshooting, and power management.

Support for specific features described in this guide can vary by model and software version.

The best deployment method depends on the information technology environment and processes.

Installing a remote system

Remote system installation enables starting and setting up the computer using software and configuration information on a network server. This feature is usually used for system setup and configuration and can be used to:

- Deploy a software image on new PCs
- Format a hard drive
- Install application software or drivers
- Update the operating system, application software, or drivers

To initiate a remote system installation, press **f12** when **f12=Network Service Boot** appears in the lower-right corner of the HP logo screen. Follow the on-screen instructions to continue the installation process. The default boot order is a BIOS configuration setting that can be changed to always attempt a network boot.

Copying a setup configuration to another computer

This section provides information about replicating the computer setup.

 **CAUTION:** Setup configuration is model-specific. File system corruption can result if source and target computers are not the same model.

To copy a setup configuration:

1. Select a setup configuration to copy, and then restart the computer.
2. As soon as you start or restart the computer, press and hold **f10** until you enter Computer Setup (f10) Utility. If necessary, press **enter** to bypass the title screen.

 **NOTE:** If you do not press **f10** at the appropriate time, you must restart the computer, and then press and hold **f10** again to access the utility.

If you are using a PS/2 keyboard, you might see a keyboard error message. Disregard it.

3. Select **File > Replicated Setup > Save to Removable Storage Device**. Follow the instructions on the screen to create the configuration file *cpqsetup.txt* and write it to a USB storage device.
4. Turn off the computer you are configuring and insert the removable USB media device containing the configuration file.

5. Turn on the computer you are configuring.
6. Press and hold the **f10** key until you enter Computer Setup (f10) Utility. If necessary, press **enter** to bypass the title screen.
7. Select **File > Replicated Setup > Restore from Removable Storage Device**, and then follow the instructions on the screen.
8. Restart the computer when the configuration is complete.

Updating and managing software

HP provides several tools for managing and updating software on desktops and computers:

- HP Client Manager Software
- Altiris Client Management Solutions
- HP SoftPaq Download Manager
- System Software Manager

HP Client Management Solutions

HP Client Management Solutions (CMS), available for download from <http://www.hp.com/go/easydeploy>, are standards-based solutions for managing and controlling computers in a networked environment.

HP Client Management Solutions offers these services:

- Detailed views of hardware inventory for asset management
- PC health-check monitoring and diagnostics
- Proactive notification of changes in the hardware environment
- Web-accessible reporting of business-critical details such as thermal warnings and memory alerts
- Remote updating of system software such as device drivers and ROM BIOS
- Remote changing of boot order
- Configuration of system BIOS settings

Altiris Client Management Solutions

Altiris and HP have partnered to provide comprehensive, tightly integrated systems management solutions to reduce the cost of owning HP client PCs.

The HP CMS is the foundation for additional Altiris Client Management Solutions that address the following topics.

- Inventory and asset management
- Deployment and migration
- Help desk and problem resolution
- Software and operations management

Go to http://www.hp.com/go/Altiris_Solutions for information about:

- How HP CMS works
- Which solutions are compatible with the operating system
- How to download a fully functional, 30-day evaluation version of Altiris solutions

HP SoftPaq Download Manager

HP SoftPaq Download Manager is a free, easy-to-use interface for locating and downloading software updates for the HP client PC models in your environment. By specifying your models, operating system, and language, you can quickly locate, sort, and select the softpaqs you need. For more information, go to <http://www.hp.com/go/sdm>.

System Software Manager

System Software Manager (SSM) is a utility available on Windows—based computers that enables you to update system-level software on multiple systems simultaneously. When executed on a PC client system, SSM detects hardware and software versions and then updates the software from a central repository, known as a *file store*. Driver versions supported by SSM are noted with a special icon on the software, the driver download website, and on the Support Software CD.

To download the utility or to obtain more information about SSM, see <http://www.hp.com/go/ssm>.

ROM Flash

BIOS settings are stored on a programmable flash ROM. By establishing a setup password in Computer Setup (f10) Utility, you can protect unauthorized users from modifying the BIOS settings.

To upgrade the BIOS, download the latest SoftPaq images from http://www.hp.com/support/workstation_swdrivers.

Remote ROM Flash

Remote ROM Flash allows system administrators to safely upgrade the ROM on remote HP computers from a centralized network management console, resulting in a consistent deployment of, and greater control over, HP PC ROM images over the network.

To use Remote ROM Flash, the computer must be powered on, or turned on using Remote Wakeup.

For more information about Remote ROM Flash and HPQFlash, see the HP Client Manager Software or System Software Manager sections at <http://www.hp.com/go/ssm>.

HPQFlash

The HPQFlash utility is used to locally update or restore the system ROM on PCs using a Windows operating system. For more information about HPQFlash, see <http://www.hp.com/go/ssm>, and enter the name of the computer.

FailSafe Boot Block

FailSafe Boot Block enables BIOS recovery in the unlikely event of a ROM flash failure. For example, if a power failure occurs during a ROM upgrade, Boot Block uses a flash-protected section of the ROM to verify a valid system ROM flash when power is restored to the computer.

If the system ROM is valid, the computer starts normally.

If the system ROM fails the validation check, FailSafe Boot Block provides enough support to start the computer from a BIOS image CD created from a SoftPaq. The BIOS image CD programs the system ROM with a valid image.

When Boot Block detects an invalid system ROM, the computer power LED blinks red eight times and the computer beeps eight times; then the computer pauses for two seconds. On some models, a Boot Block recovery mode message appears.

In preparation for system recovery, use the BIOS CD media file in the SoftPaq to create a BIOS image CD or USB key.

Recovering the computer by using FailSafe Boot Block recovery mode

To recover the computer after it enters Boot Block recovery mode:

1. Remove any media such as USB keys or disks in the optical disk drives.
2. Insert a BIOS image CD into the DVD drive or insert a USB BIOS image flash drive, such as an HP DriveKey, into a USB port.
3. Turn off the computer, and then turn it back on.

If no BIOS image CD or USB media is found, you are prompted to insert one and restart the computer.

If a setup password has been established, the caps lock light is illuminated and you are prompted for the password.

4. Enter the setup password.

If the computer starts from the CD or flash drive and successfully reprograms the ROM, three keyboard lights are illuminated and a rising-tone series of beeps signals successful recovery.

5. Remove the CD or flash drive and turn off the computer.
6. Restart the computer.

Workstation security

This section provides information about providing system security through asset tracking, password security, hard drive locking, and chassis locks.

Asset tracking

Asset tracking features provide asset tracking data that can be managed using HP Systems Insight Manager (HP SIM), HP Console Management Controller (CMC), or other systems-management applications.

Seamless, automatic integration between asset tracking features and these products enables you to choose the management tool that is best suited to the environment and to leverage investments in existing tools.

HP also offers several solutions for controlling access to valuable components and information:

- HP ProtectTools Embedded Security prevents unauthorized access to data, checks system integrity, and authenticates third-party users attempting system access.
- Security features such as ProtectTools and the Smart Cover Sensor (side access panel sensor) help prevent unauthorized access to the data and to the internal components of the computer.
- By disabling parallel, serial, or USB ports, or by disabling removable-media boot capability, you can protect valuable data assets.
- Memory Change and Side access panel sensor (Smart Cover Sensor) alerts can be forwarded to system management applications to deliver proactive notification of tampering with a computer's internal components.

ProtectTools, the Smart Cover Sensor, and the side access panel solenoid lock (Hood Lock) are available as options on select systems.

You can manage security settings as follows:

- Locally with Computer Setup (f10) Utility
- Remotely with HP CMS or HP System Software Manager (SSM), which enable the secure, consistent deployment and control of security settings from a simple command line utility

The following Computer Setup (f10) Utility features let you manage computer security.

Feature	Purpose
Removable Media Boot Control	Prevents booting from removable media drives
Serial, Parallel, USB, or Infrared Interface Control	Prevents transfer of data through the integrated serial, parallel, USB, or infrared interface
Power-On Password	Prevents use of the computer until the password is entered (applies to initial system startup and restarts)
Setup Password	Prevents reconfiguration of the computer (through the Setup utility) until the password is entered
Network Server Mode	Provides unique security features for computers used as servers

SATA hard drive security

HP computers include the HP DriveLock facility for SATA hard drives to prevent unauthorized access to data.

⚠ WARNING! Enabling DriveLock can render a SATA hard drive permanently inaccessible if the master password is lost or forgotten. No method exists to recover the password or access the data.

DriveLock has been implemented as an extension to Computer Setup (f10) Utility functions. It is only available when hard drives that support the ATA security command set are detected. On HP computers, it is not available when the SATA emulation mode is RAID+AHCI or RAID.

DriveLock is for HP customers for whom data security is a paramount concern. For such customers, the cost of a hard drive and the loss of the data stored on it is inconsequential when compared to the damage that could result from unauthorized access to its contents.

To balance this level of security with the need to address the issue of a forgotten password, the HP implementation of DriveLock employs a two-password security scheme. One password is intended to be set and used by a system administrator, while the other is typically set and used by the user.

No "back door" can be used to unlock the drive if both passwords are lost. Therefore, DriveLock is most safely used when the data contained on the hard drive is replicated on a corporate information system or is regularly backed up.

If both DriveLock passwords are lost, the hard drive is rendered unusable. For users who do not fit the previously defined customer profile, this might not be acceptable. For users who fit this profile, it might be a tolerable risk, given the nature of the data stored on the hard drive.

DriveLock applications

The most practical use of DriveLock is in a corporate environment. The system administrator would be responsible for configuring the hard drive, which involves setting the DriveLock master password and a temporary user password. If you forget the user password or if the equipment is passed on to another employee, the master password can be used to reset the user password and regain access to the hard drive.

HP recommends that corporate system administrators who enable DriveLock also establish a corporate policy for setting and maintaining master passwords. This should be done to prevent a situation where an

employee sets both DriveLock passwords before leaving the company. In such a scenario, the hard drive is unusable and requires replacement. Likewise, by not setting a master password, system administrators might find themselves locked out of a hard drive and unable to perform routine checks for unauthorized software, other asset control functions, and support.

For users with less stringent security requirements, HP does not recommend enabling DriveLock. Users in this category include personal users, or users who do not maintain sensitive data on their hard drives as a common practice. For these users, the potential loss of a hard drive resulting from forgetting both passwords is much greater than the value of the data DriveLock protects.

Access to Computer Setup (f10) Utility and DriveLock can be restricted through the setup password. By specifying a setup password and not giving it to users, system administrators can restrict users from enabling DriveLock.

Using DriveLock

When hard drives that support the ATA security command set are detected, DriveLock appears under the Security menu in the Computer Setup (f10) Utility menu. You are presented with options to set the master password and to enable DriveLock. You must provide a user password to enable DriveLock. Because the initial configuration of DriveLock is typically performed by a system administrator, a master password should be set first.

HP encourages system administrators to set a master password whether they plan to enable DriveLock or not. This gives the administrator the ability to modify DriveLock settings if the drive is locked in the future. After the master password is set, the system administrator can enable DriveLock or leave it disabled.

If a locked hard drive is present, POST requires a password to unlock the device. If a power-on password is set and it matches the device's user password, POST does not prompt the user to re-enter the password. Otherwise, the user is prompted to enter a DriveLock password.

For a cold start, use the master or user password. For a warm start, enter the same password used to unlock the drive during the preceding cold start.

Users have two attempts to enter a correct password. During cold start, if neither attempt succeeds, POST continues but the drive remains inaccessible. During a warm-start or restart from Windows, if neither attempt succeeds, POST halts and the user is instructed to cycle power.

Enabling DriveLock

To enable and set the DriveLock user password:

1. Turn on or restart the computer.
2. As soon as you turn on the computer, repeatedly press the **f10** key until you enter Computer Setup (f10) Utility.
If you do not press **f10** at the appropriate time, you must restart the computer, then repeatedly press **f10** again to access the utility.
3. Select **Security > DriveLock Security**.
4. For each DriveLock-capable drive, select a drive by pressing **f10** to accept.
5. Under Enable/Disable DriveLock options, select **Enable**, and then press **f10** to enable DriveLock for a specific drive.

 **NOTE:** To set the DriveLock master password, select **Master**.

 **CAUTION:** If you forget the DriveLock password, the drive is unusable.

6. Enter a new user password (1 to 32 characters long), and then press **f10** to accept.

7. Enter the password again in the Enter New Password Again field. If you forget this password, the drive is rendered permanently disabled.
8. Select **File > Save Changes and Exit**, and then press **enter** to accept the changes. After you press **enter**, the computer performs a cold start before invoking the DriveLock function.

When the computer starts, you are prompted to enter the DriveLock password for each DriveLock-capable drive for which you have set a password. You have two attempts to enter the password correctly. If the password is not entered correctly, the computer attempts to start anyway. However, the boot process most likely fails because data from a locked drive cannot be accessed.

In a single drive computer, if the drive has DriveLock enabled, the computer might not be able to boot to the operating system, and might try to boot from the network or from another storage device (depending on the boot ordering options). Regardless of the outcome of the start attempts, the drive-locked drive remains inaccessible without the DriveLock password.

In a two-drive computer that has a boot drive and a data drive, you can apply the DriveLock feature to the data drive only. In this case, the computer can always start, but the data drive is accessible only when the DriveLock password is entered.

When you start or restart the computer, you must enter DriveLock passwords. For example, if you boot to DOS and press **ctrl+alt+del**, you must enter the DriveLock password before the computer completes the next start cycle. This restart-start behavior is consistent with the DriveLock feature.

Password security

The power-on password prevents unauthorized use of the computer by requiring entry of a password to access applications or data when the computer is turned on or restarted. The setup password specifically prevents unauthorized access to Computer Setup (f10) Utility and can also be used as an override to the power-on password. When prompted for the power-on password, entering the setup password instead enables access to the computer.

You can establish a network-wide setup password to enable the system administrator to log in to all network systems to perform maintenance without needing to know the power-on password.

Establishing a setup password using Computer Setup (f10) Utility

Establishing a setup password through Computer Setup (f10) Utility prevents reconfiguration of the computer (through the use of Computer Setup (f10) Utility) until the password is entered.

To establish a setup password using Computer (f10) Setup menu:

1. Turn on or restart the computer.
2. As soon as the computer is turned on, press and hold **f10** until you enter Computer Setup (f10) Utility. Press **enter** to bypass the title screen, if necessary.

If you do not press **f10** at the appropriate time, you must restart the computer, and then press and hold **f10** again to access the utility.

If you are using a PS/2 keyboard, you might see a keyboard error message. Disregard it.

3. Select **Security > Setup Password** and then follow the onscreen instructions.
4. Before exiting, select **File > Save Changes and Exit**.

Establishing a power-on password using Computer Setup (f10) Utility

Establishing a power-on password through Computer Setup (f10) Utility prevents access to the computer when power is connected, unless the password is entered. When a power-on password is set, Computer

Setup (f10) Utility presents Password Options in the Security menu. The password options include Network Server Mode and Password Prompt on Warm Boot.

When Network Server Mode is disabled, you must enter the password when the computer is turned on, when the key icon appears on the monitor. When Password Prompt on Warm Boot is enabled, you must enter the password. The password must also be entered each time the computer is restarted. When Network Server Mode is enabled, the password prompt is not presented during POST, but an attached PS/2 keyboard remains locked until you enter the power-on password.

To enable Network Server Mode, you must set a power-on password under **Advanced > Password Options**. This option enables the computer to start without requiring the power-on password, but the keyboard and mouse are locked until you enter the password. The keyboard LEDs rotate constantly when the computer is in locked mode.

To establish a power-on password through the Computer Setup (f10) Utility menu:

1. Turn on or restart the computer.
2. As soon as the computer is turned on, press and hold **f10** until you enter Computer Setup (f10) Utility. Press **enter** to bypass the title screen, if necessary.

If you do not press **f10** at the appropriate time, you must restart the computer and then press and hold **f10** again to access the utility.

If you are using a PS/2 keyboard, you might see a keyboard error message. Disregard it.
3. Select **Security > Power-On Password** and then follow the onscreen instructions.
4. Before exiting, select **File > Save Changes and Exit**.

Entering a power-on password

To enter a power-on password:

1. Restart the computer.
2. When the key icon appears on the monitor, enter the current password, and then press **enter**.

Type carefully. For security reasons, the characters you enter do not appear on the screen.

If you enter the password incorrectly, a broken key icon appears. Try again. After three unsuccessful tries, you will enter the f10 setup screen with read-only permission. (See the Setup Browse Mode option under the Power-On options.)

Entering a setup password

If a setup password has been established on the computer, you will be prompted to enter it each time you run Computer Setup (f10) Utility.

To enter a setup password:

1. Restart the computer.
2. As soon as the computer is turned on, press and hold **f10** until you enter Computer Setup (f10) Utility. Press **enter** to bypass the title screen, if necessary.

If you do not press **f10** at the appropriate time, you must restart the computer and press and hold **f10** again to access the utility.

If you are using a PS/2 keyboard, you might see a keyboard error message. Disregard it.

3. When the key icon appears on the monitor, enter the setup password, and press **enter**.

Type carefully. For security reasons, the characters you enter do not appear on the screen.

If you enter the password incorrectly, a broken key icon appears. Try again. After three unsuccessful tries, you must restart the computer before you can continue.

Changing a power-on or setup password

To change a power-on or setup password:

1. Restart the computer.
2. To change the power-on password, go to step 4.
3. To change the setup password, as soon as the computer is turned on, press and hold **f10** until you enter Computer Setup (f10) Utility. Press **enter** to bypass the title screen, if necessary.

If you do not press **f10** at the appropriate time, you must restart the computer, and then press and hold the **f10** key again to access the utility.

If you are using a PS/2 keyboard, you might see a keyboard error message. Disregard it.

4. When the key icon appears, enter the current password, a slash (/) or alternative delimiter character, the new password, another slash (/) or alternative delimiter character, and the new password again as shown:

current password/new password/new password

For information about the alternative delimiter characters, see [National keyboard delimiter characters on page 33](#).

Type carefully. For security reasons, the characters you enter do not appear on the screen.

5. Press **enter**.

The new password takes effect the next time you turn on the computer.

The power-on and setup passwords can also be changed using the Security options in Computer Setup (f10) Utility.

Deleting a power-on or setup password

To delete a power-on or setup password:

1. Turn on or restart the computer.
2. Choose from the following:
 - To delete the power-on password, go to step 4.
 - To delete the setup password, as soon as the computer is turned on, press and hold **f10** until you enter Computer Setup (f10) Utility. Press **enter** to bypass the title screen, if necessary.

If you do not press **f10** at the appropriate time, you must restart the computer and then press and hold **f10** again to access the utility.

Use the appropriate operating system shutdown process.

3. When the key icon appears, enter the current password followed by a slash (/) or alternative delimiter character: *current password/*.

For information about the alternative delimiter characters see the following section.

4. Press **enter**.

National keyboard delimiter characters

Each keyboard meets country-specific requirements. The syntax and keys you use for changing or deleting passwords depend on the keyboard included with the computer.

Language	Delimiter	Language	Delimiter	Language	Delimiter
Arabic	/	Greek	-	Russian	/
Belgian	=	Hebrew	.	Slovakian	-
BHCSY*	-	Hungarian	-	Spanish	-
Brazilian	/	Italian	-	Swedish/Finnish	/
Chinese	/	Japanese	/	Swiss	-
Czech	-	Korean	/	Taiwanese	/
Danish	-	Latin American	-	Thai	/
French	!	Norwegian	-	Turkish	.
French Canadian	é	Polish	-	U.K. English	/
German	-	Portuguese	-	U.S. English	/

* Bosnia-Herzegovina, Croatia, Slovenia, and Yugoslavia

Clearing passwords

If you forget the password, you cannot access the computer.

For instructions about clearing passwords, see [Configuring password security and resetting CMOS on page 75](#).

Chassis security

Smart Cover Sensor (optional)

The optional Smart Cover Sensor is a combination of hardware and software technology that alerts you when the side panel of the computer is removed (provided the sensor has been configured in Computer Setup (f10) Utility).

Three levels of protection are available*:

Level	Setting	Description
Level 0	Disabled	Sensor* is disabled (default).
Level 1	Notify User	When the computer restarts, a message indicates that the computer has been opened or the access panel has been removed.
Level 2	Setup Password	When the computer restarts, a message indicates that the computer has been opened or the access panel has been removed. You must enter the setup password to continue.

* Smart Cover Sensor settings are changed using Computer Setup (f10) Utility.

Setting the protection level

To set the Smart Cover Sensor protection level:

1. Turn on or restart the computer.
2. During startup, press and hold the **f10** key until you enter Computer Setup (f10) Utility. Press **enter** to bypass the title screen, if necessary.



NOTE: If you do not press the **f10** key at the appropriate time, you must restart the computer, and then press and hold the **f10** key again to access Computer Setup (f10) Utility.

If you are using a PS/2 keyboard, you might see a keyboard error message. Disregard it.

3. Select **Security > Smart Cover > Cover Removal Sensor**, and follow the onscreen instructions.
4. Before exiting, select **File > Save Changes and Exit**.

Side access panel solenoid lock

The side access panel solenoid lock (available only on specific workstations) secures the side access panel to the chassis. The solenoid is controlled by a local or remote signal.

To lock the solenoid, set a password for the solenoid lock in Computer Setup (f10) Utility. To unlock the solenoid, remove the solenoid lock password in Computer Setup (f10) Utility.

The solenoid lock FailSafe Key (available from HP) is a device for manually disabling the solenoid lock. You will need the FailSafe Key in case of a forgotten password, power loss, or computer malfunction.

Cable lock (optional)

To prevent theft, you can attach a keyed cable lock to the rear chassis panel. This cable lock attaches to the chassis and secures it to the work area.

Fault notification and recovery

Fault notification and recovery features combine innovative hardware and software technology to prevent the loss of critical data and minimize unplanned downtime.

If the computer is connected to a network that is managed by HP CMS, the computer sends a fault notice to the network management application. With HP CMS, you can also remotely schedule diagnostics to run on managed PCs and create a summary report of failed tests.

ECC fault prediction

When the computer encounters an excessive number of error checking and correcting (ECC) memory errors, it displays a local alert message. This message contains information about the errant DIMM, enabling you to take action before you experience noncorrectable memory errors. ECC DIMMs are standard on this computer.

Thermal sensors

Several thermal sensors in the HP workstation regulate computer fans to maintain an acceptable, efficient chassis temperature.

Programmable power button (Windows only)

With ACPI (Advanced Configuration and Power Interface) enabled, you can customize the behavior of the power button so that rather than powering down, the workstation enters sleep mode (low power state), or hibernate mode (very low power state). This lets you go to standby without closing applications, and then return to the same operational state without any data loss.

Changing the power button configuration (Windows only)

Windows 7

1. Select **Start**, and then select **Control Panel > System and Security > Power Options**.
2. On the left side of the screen, select **Change What the Power Buttons Do**.
3. Select the desired options.

If you choose Sleep or Hibernate, you can press the power button to initiate standby, and then press it again to exit standby and return to your work. To completely turn off the workstation, select **Start > Shut Down**.

 **CAUTION:** To reduce the risk of data loss, do not use the power button to turn off the computer unless the system is not unresponsive.

 **NOTE:** If the computer is unresponsive, press and hold the power button for four seconds to completely turn off power to the computer.

Windows 8

1. Point to the upper-right or lower-right corner of the Start screen to display the charms.
2. In the Search field, type `control`.
3. On the left side of the screen select **Control Panel**, and then select **System and Security > Power Options**.
4. In Power Options Properties, select **Choose What the Power Button Does**.
5. Select the desired options.

3 Component replacement information and guidelines

This chapter provides warnings, cautions, information, and guidelines for removal and replacement procedures. It does not document the step-by-step procedures.



IMPORTANT: Removal and replacement procedures are now available in videos on the HP website.

Go to the HP Customer Self Repair Services Media Library at <http://www.hp.com/go/sml>.

This chapter includes these topics:

Topics





[Warnings and cautions on page 37](#)





[Service considerations on page 37](#)

[Product recycling on page 39](#)

[Component replacement guidelines on page 40](#)

Warnings and cautions

-
-  **WARNING!** These symbols on any surface or area of the equipment indicate the following:
-  Presence of a hot surface or hot component. If this surface is contacted, the potential for injury exists. To reduce the risk of injury from a hot component, let the surface cool before you touch it.
 -  Presence of an electric shock hazard. To reduce the risk of injury from electric shock, do not open any enclosed area marked with this symbol.
 -  To reduce the risk of personal injury, product must always be lifted by two persons.
-

-  **WARNING!** To reduce the risk of electric shock or damage to your equipment:
- Do not disable the power cord grounding plug. The grounding plug is an important safety feature.
 - Plug the power cord in a grounded (earthed) outlet that is easily accessible at all times.
 - Disconnect power from the equipment by unplugging the power cord from the electrical outlet.
-  **WARNING!** To reduce the risk of serious injury, read the *Safety & Comfort Guide*. It describes proper computer setup, posture, health, and work habits for computer users, and provides important electrical and mechanical safety information. This guide is located at <http://www.hp.com/ergo>.
-  **WARNING!** Do not use the front bezel as a handle or lifting point when lifting or moving the computer. Lifting the computer from the front bezel, or lifting it incorrectly, might cause the computer to fall, causing possible injury to you and damage to the computer. To properly and safely lift the computer, lift from the bottom of the computer.
-  **CAUTION:** Static electricity can damage the electronic components of the computer. To prevent damage to the computer, observe the following Electrostatic Discharge (ESD) precautions while servicing the computer:
- Before you begin, discharge yourself of static electricity by briefly touching a grounded metal object.
 - Work on a static-free mat.
 - Wear a static strap to make sure that any accumulated electrostatic charge is discharged from your body to the ground.
 - Create a common ground for the equipment you are working on by connecting the static-free mat, static strap, and peripheral units to that piece of equipment.
-

 **NOTE:** HP accessories are for use in HP Workstation products. They have been extensively tested for reliability and are manufactured to high quality standards.

Service considerations

Tools and software requirements

The tools necessary for computer component removal and installation are:

- Torx T-15 driver
- Flat blade and cross-tip screwdrivers
- Diagnostics software

Electrostatic discharge (ESD) information

Generating static Different activities generate different amounts of static electricity through electrostatic discharge (ESD). Static electricity increases as humidity decreases.

CAUTION: Static electricity in the amount of 700 volts might degrade a product.

Event	Relative humidity		
	55%	40%	10%
Walking across carpet	7,500 V	15,000 V	35,000 V
Walking across vinyl floor	3,000 V	5,000 V	12,000 V
Motions of bench worker	400V	800 V	6,000 V
Removing bubble pack from PCB	7,000 V	20,000 V	26,500 V
Packing PCBs in foam-lined box	5,000 V	11,000 V	21,000 V

Preventing ESD equipment damage Many electronic components are sensitive to ESD. Circuitry design and structure determine the degree of sensitivity. The following packaging and grounding precautions are necessary to prevent damage to electronic components and accessories:

- Transport products in static-safe containers such as tubes, bags, or boxes, to avoid hand contact.
- Protect electrostatic parts and assemblies with nonconductive or approved containers or packaging.
- Keep electrostatic-sensitive parts in their containers until they arrive at static-free stations.
- Place items on a grounded surface before removing them from containers.
- Before handling or touching a sensitive component or assembly, ground yourself by touching a grounded metal object.
- Avoid contact with pins, leads, or circuitry.
- Place reusable electrostatic-sensitive parts from assemblies in protective packaging or nonconductive foam.

Personal grounding methods and equipment Use the following items to help prevent ESD damage:

- **Wrist straps** — These are flexible straps with a maximum of one megohm \pm 10% resistance in the ground cords. To provide a proper ground, wear the strap against bare skin. The ground cord must be connected and fit snugly into the banana plug connector on the grounding mat or computer.
- **Heel straps, toe straps, and boot straps** — These can be used at standing computers and are compatible with most types of shoes or boots. On conductive floors or dissipative floor mats, use them on both feet with a maximum of one megohm \pm 10% resistance between the operator and ground.

Static shielding materials Static shielding materials provide the following levels of protection.

Method	Voltage
Antistatic plastic	1,500 V
Carbon-loaded plastic	7,500 V
Metalized laminate	15,000 V

- Grounding the work area to prevent static damage**
- Cover the work surface with approved static-dissipative material. Use a wrist strap connected to the work surface, and properly grounded tools and equipment.
 - Use static-dissipative mats, foot straps, or air ionizers to give added protection.
 - Disconnect power and input signals before inserting and removing connectors or test equipment.
 - Use fixtures made of static-safe materials when fixtures must directly contact dissipative surfaces.

	<ul style="list-style-type: none"> • Handle electrostatic-sensitive components, parts, and assemblies by the case or PCB laminate. Handle them only in static-free work areas. 	<ul style="list-style-type: none"> • Keep work area free of conductive materials, such as plastic assembly aids and Styrofoam. • Use field service tools (such as cutters, screwdrivers, and vacuums) that are non-conductive.
Recommended ESD prevention materials and equipment	<ul style="list-style-type: none"> • Antistatic tape • Antistatic smocks, aprons, and sleeve protectors • Non-conductive bins and other assembly or soldering aids • Non-conductive foam • Non-conductive tabletop computers with a ground cord of one megohm \pm 10% resistance • Static-dissipative table or floor mats with a hard-tie to ground • Field service kits 	<ul style="list-style-type: none"> • Static awareness labels • Wrist straps and footwear straps providing one megohm \pm 10% resistance • Material-handling packages • Non-conductive plastic bags • Non-conductive plastic tubes • Non-conductive tote boxes • Opaque shielding bags • Transparent metallized shielding bags • Transparent shielding tubes

Product recycling

HP encourages customers to recycle used electronic hardware, HP original print cartridges, and rechargeable batteries.

For information about recycling HP components or products, see <http://www.hp.com/go/recycle>.

Component replacement guidelines

This section provides information and guidelines for removal and replacement procedures. It does not document the step-by-step procedures.

 **IMPORTANT:** Removal and replacement procedures are now available in videos on the HP website.

Go to the HP Customer Self Repair Services Media Library at <http://www.hp.com/go/sml>. In Media Selection, choose the **Desktops & Workstations** product category and the **Personal Workstations** product family, then choose your platform

This chapter provides guidelines for removal and replacement procedures.

[Battery on page 40](#)

[Cable management on page 40](#)

[CPU \(processor\) and CPU heatsink on page 42](#)

[Expansion slots on page 43](#)

[Hard drives and optical disc drives on page 45](#)

[Memory on page 46](#)

[Power supply specifications on page 48](#)

[System board on page 49](#)

Battery

The battery that comes with the computer provides power to the real-time clock and has a minimum lifetime of about three years. Observe the following warning and caution when replacing the battery.

 **WARNING!** HP Z Series Workstations use lithium batteries. There is a risk of fire and chemical burn if the battery is handled improperly. Do not disassemble, crush, puncture, short external contacts, dispose of in water or fire, or expose battery to temperatures higher than 60°C (140°F).

 **CAUTION:** Before removing the battery, back up the CMOS settings in case they are lost when the battery is removed. Use Computer Setup (f10) Utility to back up the settings.

 **NOTE:** Do not dispose of batteries, battery packs, and accumulators with general household waste.

Cable management

Proper routing of the internal cables is critical to the operation of the workstation. Follow good cable management practices when removing and installing components.

- Handle cables with care to avoid damage.
- Apply only the tension required to seat or unseat cables during insertion or removal from the connector.
- When possible, handle cables by the connector or pull-strap.
- Route cables in such a way that they cannot be caught or snagged by parts being removed or replaced.
- Keep cables away from direct contact with major heat sources, such as the heatsink. (Some air flow guides have a cable guide that lets you route cables safely around the heatsink.)
- Do not jam cables on top of expansion cards or DIMMs. Circuit cards and DIMMs are not designed to take excessive pressure.

- Keep cables clear of movable or rotating parts (such as the power supply and drive cage) to prevent them from being cut or crimped when the component is lowered into its normal position.
- In all cases, avoid bending or twisting the cables. Do not bend any cable sharply. A sharp bend can break the internal wires.
- Never bend a SATA data cable tighter than a 30 mm (1.18 in) radius.
- Never crease a SATA data cable.
- Do not rely on components like the drive cage, power supply, or computer cover to push cables down into the chassis. Always position the cables to lay properly by themselves or in the cable guides and chassis areas designed for cable routing.

When removing the power supply power cable from the connector on the system board, always follow these steps:

1. Squeeze on the top of the retaining latch attached to the cable end of the connector.
2. Grasp the cable end of the connector and pull it straight out.

 **CAUTION:** Always pull the connector — NEVER pull on the cable. Pulling on the cable could damage the cable and result in a failed power supply.

CPU (processor) and CPU heatsink

⚠ CAUTION: Observe the following cautions when removing or replacing the heatsink.

- When removing the heatsink, loosen all screws a little at a time to make sure the CPU remains level. Do *not* fully loosen one screw, and then move on to the next.
- After you remove the CPU heatsink from the chassis, use alcohol and a soft cloth to clean the thermal compound residue from the CPU and the heatsink, allowing the alcohol on the CPU and CPU heatsink to dry completely.
- If you are reusing the original heatsink, apply thermal compound to the center of the CPU top surface.
- If you are using a new CPU heatsink, do not apply thermal compound to the CPU because the new heatsink already has thermal compound applied to the heatsink surface. Instead, remove the thermal compound protective liner from the bottom of the new heatsink.
- Do not overtighten the heatsink screws. Overtightening can strip the threads in the chassis.
- Do not fully tighten one screw and then move on to the next. Instead, tighten all screws a little at a time, ensuring that the CPU remains level.

CAUTION: Observe the following cautions when removing or replacing the CPU.

- If you are installing a second CPU, it must be of the same type as the first CPU.
 - Internal components might be powered even when the computer is off. To prevent damage, disconnect the computer power cord before you remove or install a component.
 - The CPU socket contacts and pads are extremely fragile. Do not touch the CPU socket contacts or the gold pads underneath the CPU. Use extreme care and handle the CPU only by the edges.
 - The CPU socket contacts are delicate and bend easily. To avoid bending the contacts, use extreme care when installing the CPU in the socket.
 - Installing a processor incorrectly can damage the system board. Contact an HP authorized reseller or service provider to install the processor. If you plan to install the processor yourself, view the entire remove and replace video before you begin.
 - Failure to follow the computer preparation instructions can result in an improperly installed processor, causing extensive computer damage.
-

Expansion slots

This section identifies and describes computer expansion card slots, and presents card configuration information.

Go to <http://www.hp.com/go/quickspecs> to learn which graphics cards are supported in the workstation, how much memory each graphics card includes, and graphics card power requirements.

Card configuration restrictions for power supplies

⚠ CAUTION: To prevent damage, the overall power consumption of the computer (including I/O cards, CPU, and memory) must not exceed the maximum rating of the computer power supply. For power supply information, see [Power supply specifications on page 48](#).

Choosing an expansion card slot

Whenever possible, use the following tips to help you select the proper slot for an expansion card:

- Use the PCIe x16 slot for the primary graphics card. If you do not use this slot for the graphics card, only cards certified as After Market Options are supported.
- Install a second graphics card in the other PCIe x16 slot.
- Install a card in a slot that most closely matches its interface technology:
 - Install a PCIe Gen1 x16 or a PCIe Gen1 x8 card in the PCIe Gen3 x16 slot.
 - Install a PCIe Gen1 x4 card in the PCIe Gen2 x4 slot.
 - Install a PCIe Gen1 x1 card in the PCIe Gen2 x1 slot.
 - Install a PCI card in the PCI slot.
 - Whenever possible, install a PCIe x1 card in an x1 slot.
- Leave as much space as possible between cards (especially graphics cards) to allow heat to dissipate more efficiently.
- For best operational efficiency, select a slot that:
 - Electrically matches the number of PCIe card lanes (for example, x1 in an x1 slot).
 - Has more lanes electrically.
 - Has fewer lanes, but is closer to your needs. For example, place an x16 card in an x4 slot, and an x4 card in an x1 slot.
- An x1 connector supports an x1 card only. While an x1 card can be inserted into a larger slot, this may limit potential future card placement.

Slot identification and description

Maximum power used by all slots must not exceed total system power and is subject to configuration limitations.

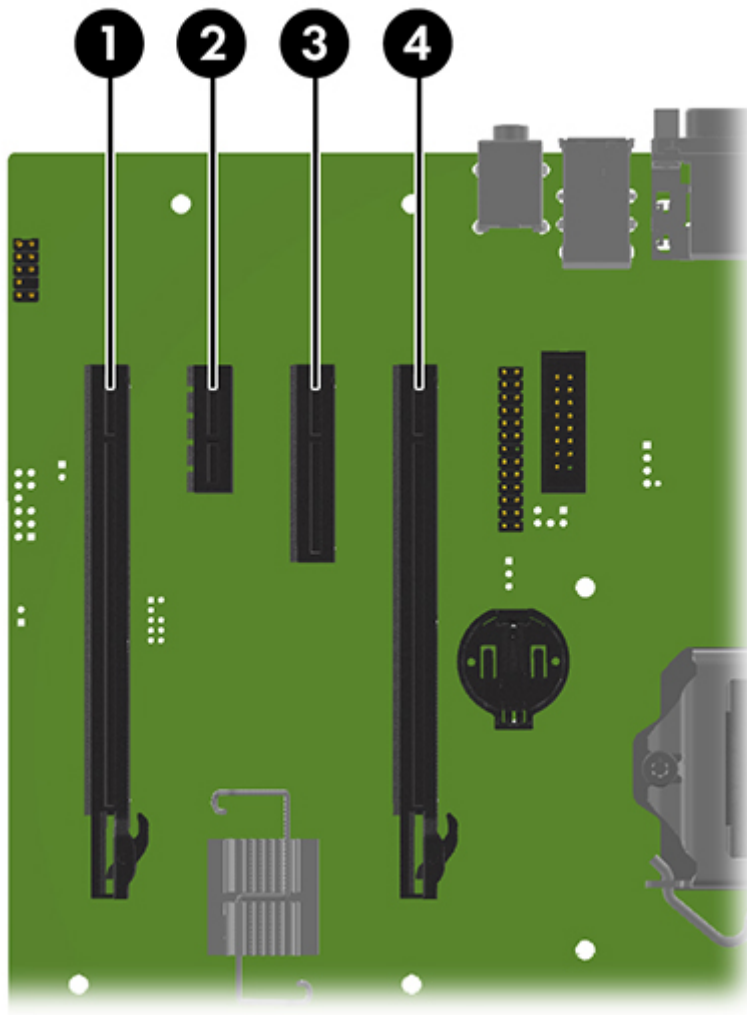

Slot	Type	Mechanical compatibility	Electrical compatibility
1	PCIe2x16(4)	x16	x4
2	PCIe2x1	x1	x1
3	PCIe2x4(1)	x4	x1
4	PCIe3x16	x16	x16

 **NOTE:** The PCIe designators indicate the mechanical connector size and number of electrical PCIe lanes routed to an expansion slot. For example, x16(4) means that the expansion slot is mechanically a x16 length connector, with 4 PCIe2 lanes supported.

Installation sequence recommendations

Load order	Card description	Slot 1	Slot 2	Slot 3	Slot 4
1	PCIe graphic card				Only
2	Second PCIe graphic card	Only			
3	PCIe audio card	1st	2nd		
4	PCIe NIC card	1st	2nd		
5	PCIe 1394 card	1st	2nd		
6	Second serial port kit	1st	2nd		
7	Parallel port kit	1st	2nd		
8	eSATA bulkhead kit	1st	2nd		3rd

NOTE: Slot sequenced from the board edge to the rear I/O aperture.

Hard drives and optical disc drives

Handling hard drives

 **CAUTION:** Take proper precautions when handling hard drives to prevent loss of work and damage to the computer or drive.

- Do not remove hard drives from the shipping package for storage. Keep hard drives in their protective packaging until they are mounted in the computer.
- Always shut down the operating system, turn off the power, and unplug the power cord. Never remove a drive while the computer is on or in standby mode.
- Before handling a drive, make sure you discharge static electricity. While handling a drive, avoid touching the connector.
- Handle a drive carefully. Do not drop it from any height.
- To prevent possible ESD damage when the drive is installed, connect the drive power cable before connecting the data cable. This discharges accumulated static electricity through the drive power cable to the computer chassis.
- Do not use excessive force when inserting a drive.
- Avoid exposing a hard drive to liquids, temperature extremes, or products that have magnetic fields such as monitors or speakers.
- If you must mail a drive, use a bubble-pack mailer or other protective packaging and label the package “Fragile: Handle With Care.”

Removal and replacement tips

- To verify the type, size, and capacity of the storage devices installed in the computer, run **Computer Setup (f10) Utility**.
- Adding a new drive may require that you make new connections from the drive to the system board. Note that:

- The primary Serial ATA (SATA) hard drive must be connected to the dark blue primary SATA connector on the system board labeled SATA0.
- Connect a secondary hard drive to SATA.
- Connect SATA optical drives to the black SATA2 connector.
- Connect an optional eSATA adapter cable to the black ESATA connector on the system board.
- Connect a media card reader USB cable to the USB connector on the system board labeled MEDIA. If the media card reader has a 1394 port, connect the 1394 cable to the 1394 PCI card.

Drive installation and cabling scenarios

This section presents cabling guidelines for the most common maximum storage configurations. If you add or remove drives, HP recommends you follow these guidelines for highest drive performance and efficient cable routing.

SATA cable connection guidelines

Configuration / PCA SATA connector	SATA 0	SATA 1	SATA 2	SATA 3	SATA 5
HDD x1 ODD x1	1st HDD		1st ODD		e-SATA
HDD x1 ODD x2	1st HDD		1st ODD	2nd ODD	e-SATA
HDD x2 ODD x1	1st HDD	2nd HDD	1st ODD		e-SATA
HDD x2 ODD x2	1st HDD	2nd HDD	1st ODD	2nd ODD	e-SATA
HDD x3 ODD x1	1st HDD	2nd HDD	3rd HDD	1st ODD	e-SATA
HDD x3 ODD x2	1st HDD	2nd HDD	3rd HDD	1st ODD	2nd ODD

Memory

Supported DIMM configurations



NOTE: Mirroring and DIMM sparing are not supported.

- Four DIMM slots
- Unbuffered ECC/nECC DIMMS only
- Maximum capacity: 32 GB

BIOS errors and warnings

The BIOS generates warnings/errors on invalid memory configurations:

- If the BIOS can find a valid memory configuration by disabling plugged-in memory, it does so and reports a warning during POST. the workstation can still be started. The warning will indicate the location of the failed DIMM on the system board.
- If there is no way for the BIOS to obtain a valid memory configuration by disabling plugged-in memory, the BIOS halts with a diagnostics 2006 code for memory error (five beeps and blinks).

DIMM installation guidelines

- Install only HP-approved DDR3 DIMMs

CAUTION: HP ships only DIMMs that are electrically and thermally compatible with this workstation. Because third-party DIMMs might not be electrically or thermally compatible, they are not supported by HP.

- Install only HP-approved DDR3 DIMMs. See <http://www.hp.com/go/quickspecs> to find DIMMs that are compatible with the workstation.
- Do not intermix DIMMs of different technologies. ECC Unbuffered DIMMs (UDIMMs), Registered DIMMs (RDIMMs), and Load Reduced DIMMs (LRDIMMs) are supported on your workstations. [Supported DIMM configurations on page 46](#) specifies which technologies are supported on each platform.

CAUTION: DIMMs and their sockets are keyed for proper installation. To prevent socket or DIMM damage, align these guides properly when installing DIMMs.

DIMM installation order

Install DIMMs in this order.

NOTE: If you install DIMMs of different sizes, load them in order of size, starting with largest and finishing with the smallest (largest in DIMM 1, smallest in last loaded DIMM).

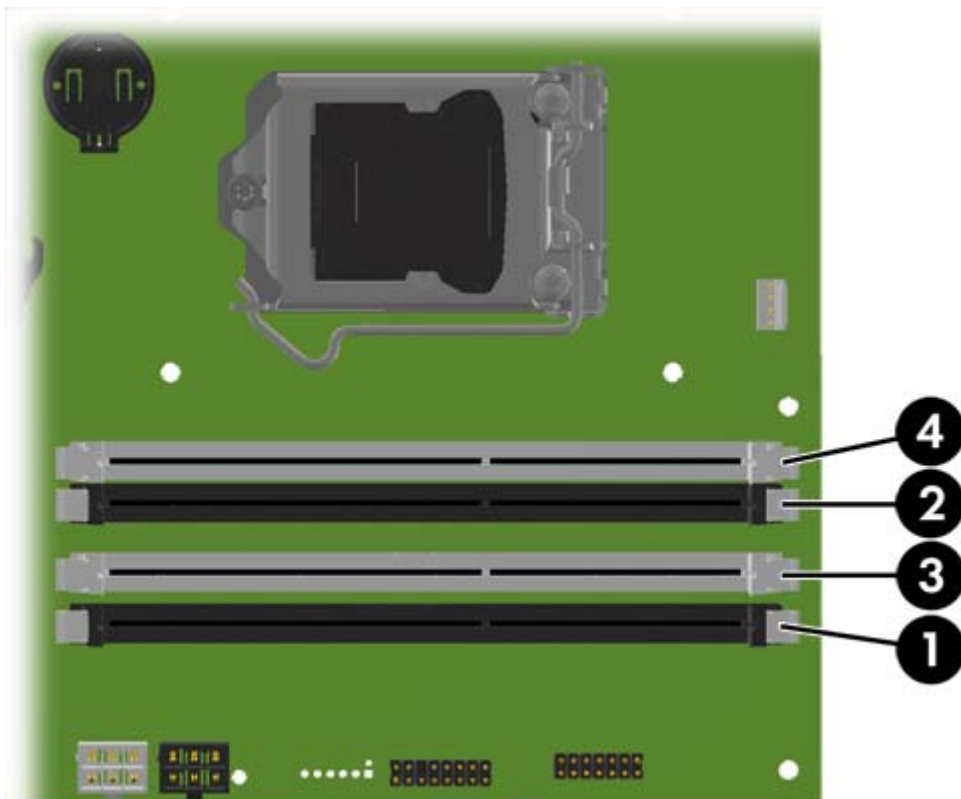

Power supply

Power supply specifications

All power supplies have these specifications:

- Wide-ranging, active Power Factor Correction (PFC)
- FEMP Standby Power compliant @115V (<1W in S5 – Power Off)
- Surge tolerant (withstands power surges up to 2000V)

	280 W
Power supply	90% efficient
Operating voltage range	90–264 VAC
Rated voltage range	100–240 VAC
Rated line frequency	50–60 Hz
Operating line frequency range	47–63 Hz
Rated input current	3.6A @ 100–240 VAC
Heat dissipation, typical (configuration and software dependent)	630.2 btu/hr (158.8 kcal/hr)
Heat dissipation, maximum (configuration and software dependent)	899.1 btu/hr (226.6 kcal/hr)
Power supply fan <i>All fans are variable speed</i>	One fan, 80mm x 25mm
Built-in Self Test LED	No
Power consumption in sleep mode	<4 W

Power consumption and heat dissipation

Power consumption and heat dissipation specifications are available for multiple configurations. To review available specifications, go to <http://www.hp.com/go/quickspecs>.

To reach zero power consumption, unplug the workstation from the power outlet or use a power strip with an on/off switch. For additional information about power-saving features, see the operating system installation instructions.

This product is in compliance with U.S. Executive Order 13221.

Resetting the power supply

If an overload triggers the power supply overload protection, power is immediately disconnected.

To reset the power supply:

1. Disconnect the power cord from the workstation.
2. Determine what caused the overload and fix the problem. For troubleshooting information, see [Diagnostics and troubleshooting on page 51](#).
3. Reconnect the power cord and restart the workstation.

When you turn off the workstation through the operating system, power consumption falls below what is considered low power consumption but does not reach zero. This low power consumption feature extends the life of the power supply.

System board

If you replace the system board:

- Make a note of the cable connections before disconnecting them from the system board.
- Follow good cable management practices. See [Cable management on page 40](#).

The following tables show system cabling for the workstations.

System cabling

System cabling

See [System board components on page 4](#) to determine the location of system board connectors.

Cable	To	Cable designator on system board
PSU cable	PCA (Main Power)	P1 (White)
PSU cable	PCA (PWR COMM)	P2 (White)
PSU cable	PCA (CPU Power)	P3 (White)
SATA power cable	PCA	P160 (Black)
SATA power cable	First hard drive (Bay 3)	P30 (Black)
SATA power cable	Second hard drive (Bay 2)	P20 (Black)
SATA power cable	First optical drive (Bay 1)	P12 (Black)
Speaker	PCA	P6 (White)
Cooler fan cable	PCA	P8 (White)
System fan cable	PCA	P11 (Brown)
Front audio cable	PCA	P23 (Blue)
Front LED/Power button cable	PCA	P5 (Black)
Front USB 2.0 cable	PCA	P24 (Yellow)
Front USB 3.0 cable	PCA	P26 (Blue)
Serial cable (optional)	PCA	P52 (Black)
Parallel cable (optional)	PCA	P126 (Black)
Hood sensor	PCA	P125 (White)
Chassis solenoid lock	PCA	P124 (Black)
SATA cable	First HDD	SATA0 (Blue)
SATA cable	Second HDD	SATA1 (Black)
SATA cable	First ODD	SATA2 (Black)
eSATA bracket cable (optional)	First external SATA device	SATA5 (Black)

4 Diagnostics and troubleshooting

This chapter describes the tools available for diagnosing and troubleshooting system issues.

Topics

[Calling support on page 51](#)

[Locating ID labels on page 52](#)

[Locating warranty information on page 52](#)

[Diagnosis guidelines on page 52](#)

[Troubleshooting checklist on page 53](#)

[Using HP PC Hardware Diagnostics \(UEFI\) on page 64](#)

[Diagnostic codes and errors on page 64](#)

Calling support

At times you might encounter an issue that requires support. When you call support:

- Have the computer readily accessible.
- Write down the computer serial numbers, product numbers, model names, and model numbers and have them in front of you.
- Note any applicable error messages.
- Note any add-on options.
- Note the operating system.
- Note any third-party hardware or software.
- Note the details of any blinking LEDs on the front of the computer (tower and desktop configurations) or on the side of the computer (all-in-one configurations).
- Note the applications you were using when you encountered the problem.

 **NOTE:** When calling in for service or support, you might be asked for the product number (example: PS988AV) of the computer. If the computer has a product number, it is generally located next to the 10-digit serial number of the computer.

 **NOTE:** On most models, the serial number and product number labels can be found on the top or side panel and at the rear of the computer (tower and desktop configurations) or on a pull-out card on the side of the display (all-in-one configurations).

For a listing of all worldwide support phone numbers, go to <http://www.hp.com/support>, select your region, and click **Connect with HP** in the upper-right corner.

Locating ID labels

To assist in troubleshooting, product, serial, and authentication numbers are available on each computer.

- All workstations have a serial number (unique for each workstation) and product number. Have these numbers available when you contact support.
- The Certificate of Authentication (COA) is used for systems with Windows 7 preinstalled.
- The Genuine Microsoft Label (GML) is used for systems with Windows 8 preinstalled.
- A service label shows the build ID and Feature Byte strings, which are needed for system board replacement.

In general, these labels can be found on the top, rear, or bottom of the chassis (tower and desktop configuration). Your computer might look different from the illustration.



Locating warranty information

To locate base warranty information, go to <http://www.hp.com/support/warranty-lookuptool>.

To locate an existing Care Pack, go to <http://www.hp.com/go/lookuptool>.

To extend a standard product warranty, go to <http://www.hp.com/hps/carepack>. HP Care Pack Services offer upgraded service levels to extend and expand a standard product warranty.

Diagnosis guidelines

If you encounter a problem with the computer, monitor, or software, the following sections provide a list of general suggestions that help you isolate and focus on the problem before taking further action.

Diagnosis at startup

- Verify that the computer and monitor are plugged into a working electrical outlet.
- Remove all CDs, or USB drive keys from your system before turning it on.
- Verify that the computer is turned on and the blue power light is blue (normal operation) and not red (error state).

- If you have installed an operating system other than the factory-installed operating system, check to be sure that it is supported on your system, go to <http://www.hp.com/go/quickspecs>.
- Verify that the monitor is turned on and the green monitor light is on. Note that not all monitors are equipped with LED lights to indicate their functionality.
- Turn up the brightness and contrast controls of the monitor if the monitor is dim.

Diagnosis during operation

- Look for blinking LEDs on the side of the computer. The blinking lights are error codes that will help you diagnose the problem. Refer to the [Diagnostic LED and audible \(beep\) codes on page 64](#) section of this document for information on interpreting diagnostic lights and audible codes.
- Check all cables for loose or incorrect connections.
- Wake the computer by pressing any key on the keyboard or the power button. If the system remains in suspend mode, shut down the system by pressing and holding the power button for at least four seconds, then press the power button again to restart the system. If the system does not shut down, unplug the power cord, wait a few seconds, then plug it in again. If it does not restart, press the power button to start the computer.
- Reconfigure the computer after installing a non-plug and play expansion board or other option.
- Be sure that all required device drivers have been installed. For example, if you have connected a printer, you must install a printer driver.
- If you are working on a network, plug another computer with a different cable into the network connection. There might be a problem with the network plug or cable.
- If you recently added new hardware, remove the hardware and verify if the computer functions properly.
- If you recently installed new software, uninstall the software and verify if the computer functions properly.
- If the screen is blank, plug the monitor into a different video port on the computer if one is available. Alternatively, replace the monitor with a monitor that you know is working properly.
- Upgrade the BIOS. A new release of the BIOS might have been released that supports new features or fixes your problem.
- Press the **caps lock** key. If the **caps lock** LED toggles on or off, the keyboard is operating correctly.

Troubleshooting checklist

Before running diagnostic utilities, make sure that the following conditions are met:

- The computer is connected to a working electrical outlet and powered on, and the power light is illuminated.
- The monitor (for tower or desktop configurations) is connected to a working electrical outlet and powered on, and the power light is illuminated.
- The monitor brightness and contrast are properly adjusted.
- The keyboard is operating correctly (press and hold any key and listen for a beep).
- All cables are properly connected.
- All necessary device drivers are installed.

- All external media (such as optical disks or USB drive keys) are removed before startup.
- The latest version of BIOS, drivers, and software are installed.

HP troubleshooting resources and tools

This section provides information to guide you in troubleshooting your system.

Online support

Online support resources include web-based troubleshooting tools, technical knowledge databases, driver and patch downloads, online communities, and product change notification services.

The following websites are also available to you:

- <http://www.hp.com>—Provides useful product information.
- http://www.hp.com/support/workstation_manuals—Provides the latest online documentation.
- <http://www.hp.com/go/workstationsupport>—Provides technical support information for workstations.
- <http://www8.hp.com/us/en/contact-hp/phone-assist.html>—Provides a listing of the worldwide technical support telephone numbers. Select your region.
- http://www.hp.com/support/workstation_swdrivers—Provides access to software and drivers for workstations.

HP Support Center

To help you troubleshoot problems yourself, HP provides the HP Support Center. The HP Support Center is a portal to an extensive selection of online tools. To access the HP Support Center, complete the following steps:

1. Go to <http://www.hp.com/support> and select your country.
2. Select **Troubleshooting** and your product.

HP Chat Support

HP Chat Support is a set of web-based support tools that automate and speed up the resolution of problems concerning desktop computing, tape storage, and printing.

HP Chat Support enables you to electronically submit a support ticket to HP over the web. When you submit a support ticket, HP Chat Support collects information about the workstation and passes it to an online support specialist. The collection of information might take up to 30 seconds, depending on the workstation configuration. When you submit a support ticket, you receive a confirmation message containing your case ID, the support hours for your location, and the estimated time of response.

For more information about HP Chat Support, go to <http://instantsupport.hp.com/>.



NOTE: This feature is not available for Linux.

Customer Advisories, Customer and Security Bulletins, and Customer Notices

To find advisories, bulletins, and notices:

1. Go to <http://www.hp.com/go/workstationsupport> and select your country.
2. Select **Drivers and Downloads** and your product.
3. In the left navigation pane under **Knowledge Base options**, select **Advisories, Bulletins & Notices**.

Product Change Notifications

Product Change Notifications (PCNs) are proactive notifications for product changes occurring within a 30- to 60-day window of the effective date of the change in the manufacturing process. PCNs give customers advance notice of changes to their product, such as an updated BIOS version that they might need to decide whether to download prior to the change taking place. To view a list of PCNs, go to the **Advisories, Bulletins & Notices** page for your product.

Helpful hints

If you encounter a problem with the workstation, monitor, or software, the following general suggestions might help you isolate and focus on the problem before taking further action.

At startup

- Verify that the workstation is plugged into a functional AC outlet.
- Remove all optical discs and USB flash drives before starting the workstation.
- Verify that the workstation is on and the power light is on.
- If you have installed an operating system other than the factory-installed operating system, confirm that it is supported on your system by going to <http://www.hp.com/go/quickspecs>.
- Verify that the internal display panel is lit.
- If the internal display panel is dim, turn up the brightness.
- If you have an external monitor:
 - Verify that the monitor is plugged into a functional AC outlet.
 - Verify that the monitor is on and the green monitor light is on.
 - If the monitor is dim, turn up the brightness and contrast controls.

During operation

- Beeps and blinking lights on the workstation are error codes that can help you diagnose problems. For more information on interpreting these codes, see [Diagnostic LED and audible \(beep\) codes on page 64](#).
- Press and hold any key. If the system beeps, your keyboard is operating correctly.
- Check all cables for loose or incorrect connections.
- Wake the workstation by pressing the power button or any key on the keyboard. If the system remains in suspend mode, shut down the system by pressing and holding the power button for at least four seconds. Then press the power button again to restart the system.

If the system does not shut down, unplug the power cord, wait a few seconds, and then plug it in again. If the system does not restart, press the power button.
- After installing a non-PnP expansion board or other option (such as a diskette drive), restart the workstation.
- Be sure that all required device drivers have been installed. For example, if you have connected a printer, you must install a printer driver.
- If you are working on a network, use another cable to plug your workstation into the network connection. If you still cannot connect, there might be a problem with the network plug.

- If you recently added new hardware, remove the hardware to see whether the workstation functions properly.
- If you recently installed new software, uninstall the software to see whether the workstation functions properly.
- If the internal display panel on an all-in-one workstation is blank, open the workstation and be sure that both ends of the cable between the system board and the internal display panel are connected. If you are using a graphics card, verify that the card is properly installed.
- Upgrade the BIOS. A new release of the BIOS might have been released that supports new features or fixes your problem.
- For more detailed information, see [Diagnostics and troubleshooting on page 51](#).

Customer Self Repair

Under the Customer Self Repair programs, you can order a replacement part and install the part without on-site HP technical assistance. Customer Self Repair might be required for some components. For more information, go to <http://www.hp.com/go/selfrepair> and select your product.



NOTE: Some components are not eligible for Customer Self Repair and must be returned to HP for service. Call support for further instructions before attempting to remove or repair these components.

Troubleshooting scenarios and solutions

This section presents troubleshooting scenarios and possible solutions for a Windows-based system.

Solving minor problems

Problem	Cause	Possible Solution
Workstation appears frozen and does not shut down when the power button is pressed.	Software control of the power switch is not functional.	<ol style="list-style-type: none"> 1. Press and hold the power button for at least four seconds until the computer shuts down. 2. Disconnect the electrical plug from the outlet. 3. Restart the computer.
Workstation seems to be frozen.	Program in use has stopped responding to commands.	<ol style="list-style-type: none"> 1. If possible, use the Windows Task Manager to isolate and terminate the offending process. 2. Attempt the normal Windows shutdown procedure. 3. Restart the computer using the power button.
Workstation date and time display is incorrect.	Real-time clock (RTC) battery might need replacement.	<ol style="list-style-type: none"> 1. Reset the date and time in the Control Panel. 2. Replace the RTC battery.
Workstation appears to pause periodically.	Network driver is loaded and no network connection is established.	Establish a network connection, or use Computer Setup (f10) Utility or Microsoft Windows Device Manager to disable the network controller.
Cursor does not move using the arrow keys on the keypad.	num lock is on.	Press num lock. The num lock key can be disabled or enabled in Computer Setup (f10) Utility.
Poor performance is experienced.	Processor is hot.	<ol style="list-style-type: none"> 1. Verify that airflow to the computer is not blocked. 2. Verify that chassis fans are connected and working properly. Some fans operate only when needed. 3. Verify that the processor heatsink is installed properly.
	Hard drive is full.	Transfer data from the hard drive to create more space on the hard drive.
Workstation powered off automatically and the Power LED flashes red 2 times (once every second), followed by a 2-second pause, and then two simultaneous beeps sounded.	<p>Processor thermal protection is activated.</p> <p>A fan might be blocked or not turning.</p> <p>OR</p> <p>The processor heatsink is not properly attached to the processor.</p>	<ol style="list-style-type: none"> 1. Verify that the computer air vents are not blocked. 2. Open the access panel and press the computer power button. 3. Verify that the system fan is running. 4. Verify that the processor heatsink fan spins. If the fan is not spinning, verify that the heatsink fan cable is plugged into the system board connector and that the heatsink is properly seated. 5. Replace the processor heatsink.
System does not turn on, and the LEDs on the front of the computer are not flashing.	System cannot power on.	<p>Press and hold the power button for less than four seconds. If the hard drive LED turns green:</p> <ol style="list-style-type: none"> 1. To find a faulty device, remove all devices one at a time: <ol style="list-style-type: none"> a. Disconnect AC power to the computer. b. Remove a device. c. Reconnect AC power and turn on the computer.

Problem	Cause	Possible Solution
		<ol style="list-style-type: none"> 2. Repeat this process until the faulty device is identified. Remove the graphics card last. Replace the faulty device. 3. If no faulty device is found, replace the system board. <p>OR</p> <ol style="list-style-type: none"> 1. Press and hold the power button for <i>less than</i> four seconds. If the hard drive LED does not illuminate: <ol style="list-style-type: none"> a. Verify that the computer is plugged into a working AC outlet. b. Verify that the power button harness is connected to the inline front panel I/O device assembly connector. 2. Verify that the power supply unit (PSU) cables are connected to the system board. 3. Verify power supply unit PSU functionality (Tower only): <ol style="list-style-type: none"> a. Disconnect the AC power. b. Unplug cables connected to the system board. c. Reconnect AC power <ul style="list-style-type: none"> • If the PSU fan spins, the PSU is good; replace the system board. • If the PSU fan does not spin or the LED does not illuminate, replace the PSU.

Solving hard drive problems

Problem	Cause	Solution
Hard drive error	Hard drive has bad sectors or has failed.	<p>Locate and block the usage of bad sectors. If necessary, reformat the hard drive.</p> <p>If the drive is detected by the UEFI, run F2 Diagnostics Drive Test.</p>
Disk transaction problem	The directory structure is bad, or there is a problem with a file.	<ol style="list-style-type: none"> 1. Open Windows Explorer and select a drive. 2. Right click on the drive and select Properties > Tools. 3. Under Error-checking, select Check Now.
Drive not found (identified)	Improper cable connection	On computers with discrete data and power cables, make sure that the data and power cables are securely connected to the hard drive. (See the <i>Hard drive</i> section of this guide for connection details.)
	Improperly seated hard drive	<p>On systems with blind-mate drive connections, check for connector damage on the drive and in the chassis.</p> <p>Reseat the hard drive and its carrier in the chassis to make sure that a proper connection. (See the <i>Hard drive</i> section of this guide for connection details.)</p>

Problem	Cause	Solution
	The system might not have automatically recognized a newly installed device.	<ol style="list-style-type: none"> 1. Run Computer Setup (f10) Utility. 2. If the system does not recognize the new device, verify that the device is listed in Computer Setup (f10) Utility. If it is listed, the probable cause is a driver problem. If it is not listed, the probable cause is a hardware problem. 3. If this drive is newly installed, enter Setup and try adding a POST delay under Advanced > Power-On.
	Drive responds slowly immediately after power-up.	Run Computer Setup (f10) Utility and increase the POST Delay in Advanced > Power-On Options
Non-system disk or NTLDR missing message	System is trying to start from nonbootable media.	Remove the optical disc or USB drive.
	System is trying to start from a damaged hard drive.	<ol style="list-style-type: none"> 1. Insert a bootable system optical disc or USB drive and restart the computer. 2. If the hard drive is still inaccessible and MBR Security is enabled, try restoring the previously saved MBR image by entering Setup and selecting Security > Restore Master Boot Record.
	System files missing or not properly installed.	<ol style="list-style-type: none"> 1. Insert a bootable system optical disc or USB drive and restart. 2. Verify that the hard drive is partitioned and formatted. 3. Install the system files for the appropriate operating system, if necessary.
	Hard drive boot disabled in Computer Setup.	Run Computer Setup (f10) Utility and enable the hard drive entry in the Storage > Boot Order list.
Workstation will not start.	Hard drive is damaged.	Replace the hard drive.

Solving display problems

These suggestions apply to monitors connected to desktop and tower configurations, and to external monitors connected to all-in-one configurations.

Problem	Cause	Solution
Blank screen (no video).	The cable connections are not correct.	Verify the cable connections from the monitor to the computer and to a working electrical outlet.
	The monitor is off.	Turn the monitor on (LED is on). You might need to refer to the monitor manual for an explanation of LED signals.
	Screen blanking utility installed or energy saver features enabled.	Press a key or the mouse button and, if set, enter your password.
	System ROM is bad; system is running in FailSafe Boot Block mode (indicated by 8 beeps).	Reflash the ROM using a SoftPaq.
	Fixed-sync monitor does not sync at the resolution specified.	Verify that the monitor can accept the same horizontal scan rate as the resolution specified.
	Computer is in Hibernate mode.	Press the power button to resume from Hibernate mode.

Problem	Cause	Solution
	Workstation monitor settings are not compatible with the monitor.	<ol style="list-style-type: none"> 1. When you see Press f8 in the bottom-right corner of the screen, restart the computer and press f8 during startup. 2. Using the keyboard arrow keys, select Enable VGA Mode, and then press enter. 3. For Windows, double-click the Display icon in the Control Panel and then select the Settings tab. 4. Use the sliding control to reset the resolution.
The display works properly during the POST but goes blank when the operating system starts.	The display settings in the operating system are incompatible with your graphics card and monitor.	<ol style="list-style-type: none"> 1. For Windows, restart your computer in VGA mode. 2. After the operating system starts, change the display settings to match those supported by your graphics card and monitor. 3. Refer to your operating system and graphics card documentation for information about changing display settings.
Power LED flashes red 6 times (once every second), followed by a two-second pause, and then the computer beeps 6 times.	Pre-video graphics error.	<p>For systems with a graphics card:</p> <ol style="list-style-type: none"> 1. Reseat the graphics card. 2. If the card requires external power, make sure the power cable is properly connected. 3. Replace the graphics card. 4. Replace the system board. <p>For systems with no graphics card installed, the CPU may have no integrated graphics capability.</p>
Monitor does not function when used with Energy Saver features.	Monitor without Energy Saver capabilities is being used with Energy Saver features enabled.	Disable the monitor Energy Saver feature.
Dim characters	The brightness and contrast controls are not set properly.	Adjust the monitor brightness and contrast controls.
	Cables are not properly connected.	Verify that the graphics cable is connected to the graphics card and the monitor.
Blurry video or requested resolution cannot be set.	If the graphics controller was upgraded, the correct video drivers might not be loaded.	Install the video drivers included in the upgrade kit, or download and install the latest drivers for your graphics card from http://welcome.hp.com/country/us/en/support.html .
	Monitor cannot display requested resolution.	Change the requested resolution.
The picture is broken up, rolls, jitters, or flashes.	The monitor connections might be faulty, or the monitor might be incorrectly adjusted.	<ol style="list-style-type: none"> 1. Be sure the monitor cable is securely connected to the computer. 2. In a multiple CRT monitor system, make sure that the monitors' electromagnetic fields are not interfering with each other. Move them apart if necessary. 3. Move fluorescent lights or fans that are too close to the CRT monitor.
	Monitor must be degaussed.	Degauss the monitor.
Vibrating or rattling noise coming from inside a CRT monitor when powered on.	Monitor degaussing coil has been activated.	None. It is normal for the degaussing coil to be activated when the monitor is turned on.

Problem	Cause	Solution
Clicking noise coming from inside a CRT monitor.	Electronic relays have been activated inside the monitor.	None. It is normal for some monitors to make a clicking noise when turned on and off, when going in and out of Standby mode, and when changing resolutions.
High pitched noise coming from inside a flat-panel monitor.	Brightness and contrast settings are too high.	Lower brightness and contrast settings.
Fuzzy focus; streaking, ghosting, or shadowing effects; horizontal scrolling lines; faint vertical bars; or unable to center the picture on the screen (flat-panel monitors using an analog VGA input connection only.)	Flat-panel monitor's internal digital conversion circuits might be unable to correctly interpret the output synchronization of the graphics card.	<ol style="list-style-type: none"> 1. Select the monitor's Auto-Adjustment option in the monitor's onscreen display menu. 2. Manually synchronize the Clock and Clock Phase onscreen display functions. 3. Download SoftPaq SP22333 to assist with the synchronization).
Some typed symbols do not appear correctly.	The font you are using does not support that symbol.	<p>Use the Character Map to locate and select the appropriate symbol.</p> <p>For Windows 7, select Start > All Programs > Accessories > System Tools > Character Map. You can copy the symbol from the Character Map into a document.</p> <p>For Windows 8, from the Start screen, type <code>character map</code>. The application appears under the Apps heading.</p>

Solving audio problems

Problem	Cause	Solution
Sound does not come out of the speaker or headphones.	Software volume control is turned down.	Double-click the Speaker icon on the taskbar, and then use the volume slider to adjust the volume.
	The external speakers are not turned on.	Turn on the external speakers.
	External speakers plugged into the wrong audio jack.	See your sound card documentation for proper speaker connection.
	Digital CD audio is not enabled.	<p>Enable digital CD audio:</p> <ol style="list-style-type: none"> 1. From the Control Panel, select System. 2. On the Hardware tab, select the Device Manager button. 3. Right-click the CD/DVD device and select Properties. 4. On the Properties tab, select Enable digital CD audio for this CD-ROM device.
	Headphones or devices connected to the line-out connector have muted the internal speaker.	Turn on and use headphones or external speakers, if connected, or disconnect headphones or external speakers.
Noise or no sound comes out of the speakers or headphones.	Volume is muted.	<ol style="list-style-type: none"> 1. From the Control Panel, select Sound, Speech and Audio Devices, and then select Sounds and Audio Devices. 2. Deselect the Mute checkbox.
	Computer is in Standby mode.	Press the power button to resume from Standby mode.

Problem	Cause	Solution
		<p>stereo-to-mono adapter to engage the auto sense feature, or use multimedia device properties to switch the audio signal from analog to digital.</p> <p>2. If the headphones have a mono jack, use the multimedia device properties to switch the system to analog out.</p> <p>NOTE: If you set digital as the Output Mode, the internal speaker and external analog speakers no longer output audio until you switch back to an auto sense or analog mode.</p> <p>If you set analog as the Output Mode, external digital speakers do not function until you change the output mode back to an auto-sense or digital mode.</p>
Sound occurs intermittently.	Processor resources are being used by other open applications.	Shut down all open processor-intensive applications.
Workstation appears to be locked up while recording audio.	The hard drive might be full.	<p>1. Before recording, be sure there is enough free space on the hard drive.</p> <p>2. Try recording the audio file in a compressed format.</p>

Solving printer problems

Problem	Cause	Solution
Printer does not print.	Printer is not turned on and online.	Turn the printer on and be sure it is online.
	The correct printer driver for the application is not installed.	<p>1. Install the correct printer driver for the application.</p> <p>2. Try printing using the MS-DOS command:</p> <p>DIR C:\> [printer port]</p> <p>Replace <i>printer port</i> with the address of the printer used. If the printer works, reload the printer driver.</p>
	If you are on a network, you might not have made a connection to the printer.	Make the proper network connection to the printer.
	Printer might have failed.	Run printer self-test.
Printer does not turn on.	The cables might not be connected properly.	

Solving power supply problems

This section presents power supply troubleshooting scenarios.

Testing power supply

Problem	Cause	Solution
PSU shuts down intermittently.	Power supply fault.	Replace the PSU.
Workstation powers off and the Power LED flashes red 2 times (once every second), followed by a two-second pause.	Processor thermal protection is activated. A fan might be blocked or not turning. OR The processor heatsink fan assembly is not properly attached to the processor.	<ol style="list-style-type: none"> 1. Make sure that the workstation air vents are not blocked. 2. Open the access panel and press the workstation power button. 3. Verify that the system fan is running. 4. Verify that the processor heatsink fan spins. If the heatsink fan is not spinning, verify that the fan cable is plugged into the system board connector. Verify that the fan is properly seated. 5. Replace the processor heatsink.
Power LED flashes red (once every 2 seconds).	Power failure (power supply is overloaded).	<ol style="list-style-type: none"> 1. Determine whether a device is causing the problem by performing the following: <ol style="list-style-type: none"> a. Disconnect AC power. b. Remove all attached devices. c. Turn on the workstation. If the system enters the POST, perform the following: <ol style="list-style-type: none"> a. Power off the workstation. b. Replace one device at a time and repeat this procedure until a failure occurs. c. Replace the device causing the failure. d. Continue adding devices one at a time to verify that all devices are functioning. 2. Verify power supply functionality (Tower only). <ol style="list-style-type: none"> a. Disconnect AC power. b. Unplug all system board power cables. c. Plug in AC power. <ul style="list-style-type: none"> • If the PSU fan spins and the LED is illuminated (see Testing power supply on page 63), the power supply is good. Replace the system board. • If the PSU fan does not spin or the LED does not illuminate (see Testing power supply on page 63), replace the power supply.

Using HP PC Hardware Diagnostics (UEFI)

HP PC Hardware Diagnostics is a Unified Extensible Firmware Interface (UEFI) that allows you to run diagnostic tests to determine whether the computer hardware is functioning properly. The tool runs outside the operating system so that it can isolate hardware failures from issues that may be caused by the operating system or other software components.

To start HP PC Hardware Diagnostics UEFI:

1. Turn on or restart the computer, quickly press **esc**, and then press **F2**.

The BIOS searches three places for the HP PC Hardware Diagnostics (UEFI) tools in the following order:

- a. Connected USB drive



NOTE: To download the HP PC Hardware Diagnostics (UEFI) tool to a USB drive, see [Downloading HP PC Hardware Diagnostics \(UEFI\) to a USB device on page 64](#).

- b. Hard drive

- c. BIOS

2. Click the type of diagnostic test you want to run, and then follow the on-screen instructions.



NOTE: If you need to stop a diagnostic test, press **Esc**.

Downloading HP PC Hardware Diagnostics (UEFI) to a USB device



NOTE: The HP PC Hardware Diagnostics (UEFI) download instructions are provided in English only.

1. Go to <http://www.hp.com>.
2. Point to **Support** located at the top of the page, and then click **Download Drivers**.
3. In the text box enter the product name, and then click **Go**.

-or-

Click **Find Now** to let HP automatically detect your product.

4. Select your computer model, and then select your operating system.
5. In the Diagnostic section, click **HP UEFI Support Environment**.

- or -

Click **Download**, and then select **Run**.

Diagnostic codes and errors

This section presents information about diagnostic LED codes, LED color definitions, and POST error messages to help you troubleshoot problems.

Diagnostic LED and audible (beep) codes

This section describes the front panel LED error and operation codes as well as the audible codes that might occur before or during the POST.

Activity	Possible cause	Recommended action
Blue Power LED* on. No beeps.	Computer on.	
Blue Power LED* blinks every two seconds.* No beeps.	Computer in Sleep mode (S3-Suspend to RAM). Select models only.	
Blue Power LED* is off.* No beeps.	Computer in Hibernate mode (S4-Suspend to disk) or system is off (S5).	N/A
Blue Power LED* blinks three times*, once per second.* No beeps.	Computer in Sleep mode (S3-Suspend to RAM). Select models only.	
Blue Power LED* blinks four times*, once per second.* No beeps.	Computer in Hibernate mode (S4-Suspend to disk).	
User-selectable for details.		
For the following LED activity and beeps, the beeps are heard through the chassis speaker. Blinks and beeps repeat for five cycles, after which, only the blinks continue to repeat.		
Red Power LED blinks two times, once every second, followed by a two-second pause. Two beeps.	<p>CPU thermal protection activated by either of the following methods:</p> <ul style="list-style-type: none"> • A fan might be blocked or not turning. • The heatsink and fan assembly is not properly attached to the CPU. 	<p>CAUTION: Internal components might be powered even when the computer is off. To prevent damage, disconnect the computer power cord before you remove a component.</p> <ol style="list-style-type: none"> 1. Make sure that the computer air vents are not blocked and the cooling fan is running. 2. Open the access panel, press power button, and verify that the CPU fan is spinning. If the CPU fan is not spinning, make sure the fan cable is plugged into the computer board header. Make sure the fan is fully and properly seated or installed. 3. If fan is plugged in and seated properly, but is not spinning, the problem might be in the CPU fan. Contact HP for assistance. 4. Verify that the fan assembly is properly attached. If problems persist, there might be a problem with the CPU heatsink. Contact HP for assistance.
Red Power LED blinks three times, once every second, followed by a two-second pause. Three beeps.	CPU not installed (not an indicator of bad CPU).	<ol style="list-style-type: none"> 1. Verify that the CPU is present. 2. Reseat the CPU.
Red Power LED blinks four times, once every second, followed by a two-second pause. Four beeps.	Power failure (power supply is overloaded).	<p>CAUTION: Internal components might be powered even when the computer is off. To prevent damage, disconnect the computer power cord before you remove a component.</p> <ol style="list-style-type: none"> 1. Open the access panel and make sure that all power connections are secure on the system board. 2. Check if a device is causing the problem by removing all attached devices (such as hard, diskette, or optical disk drives, and expansion cards.) Turn on the computer. If the system enters the POST, power off and replace one device at a time; repeat this procedure until failure occurs. Replace the device that is causing the failure. Continue adding devices one at a time to make sure that all devices are functioning properly.
Red Power LED blinks five times, once every second,	Pre-video memory error.	<p>CAUTION: Internal components might be powered even when the computer is off. To prevent damage, disconnect the computer power cord before you remove a component.</p>

Activity	Possible cause	Recommended action
followed by a two-second pause. Five beeps.		<ol style="list-style-type: none"> 1. Reseat DIMMs. 2. Replace DIMMs one at a time to isolate faulty module. 3. Replace third-party memory with HP memory. 4. The problem might be on the system board. Contact HP for assistance.
Red Power LED blinks six times, once every second, followed by a two-second pause. Six beeps.	Pre-video graphics error.	<p>CAUTION: Internal components might be powered even when the computer is off. To prevent damage, disconnect the computer power cord before you remove a component.</p> <ol style="list-style-type: none"> 1. Reseat the graphics card. 2. Verify the graphics auxiliary power cable is connected (if applicable). 3. Confirm the graphics card is in the appropriate slot (PCIe x16). 4. The problem might be on the graphics card. Contact HP for assistance.
Red Power LED blinks seven times, once every second, followed by a two-second pause. Seven beeps.	System board failure (ROM detected failure prior to video).	<ol style="list-style-type: none"> 1. Clear CMOS. <p>NOTE: Refer to the <i>Maintenance and Service Guide</i> for the computer model for detailed information on clearing CMOS.</p> 2. The problem might be on the system board. Contact HP for assistance.
Red Power LED blinks eight times, once every second, followed by a two-second pause. Eight beeps.	Invalid ROM based on bad checksum.	<p>CAUTION: Internal components might be powered even when the computer is off. To prevent damage, disconnect the computer power cord before you remove a component.</p> <ol style="list-style-type: none"> 1. Clear CMOS. <p>NOTE: Refer to the <i>Maintenance and Service Guide</i> for the computer model for detailed information on clearing CMOS.</p> 2. Upgrade the ROM using SoftPaq, either from the hard drive, CD, diskette, or USB removable device (for example, HP Drive Key). See ROM Flash on page 26. SoftPaq is a self-extracting executable, which contains instructions for its use, that enables you to upgrade the ROM. To download the Softpaq executable, go to http://www.hp.com/go/workstationsupport. 3. The problem might be on the system board. Contact HP for assistance.
Red Power LED blinks nine times, once every second, followed by a two-second pause. Nine beeps.	System powers on but does not start.	<ol style="list-style-type: none"> 1. The problem might be on the system board. Contact HP for assistance. 2. The problem might be in the CPU. Contact HP for assistance.
System does not power-on and LEDs are not blinking. No beeps.	System unable to turn on.	<p>CAUTION: Internal components might be powered even when the computer is off. To prevent damage, disconnect the computer power cord before you remove a component.</p> <p>To resolve the problem, choose one of the following options:</p> <p>Press and hold the power button for less than four seconds. If the hard drive LED turns green, then:</p> <ol style="list-style-type: none"> 1. Remove the expansion cards one at a time and try holding the power button again for less than four seconds. 2. The problem might be on the system board. Contact HP for assistance.

Activity	Possible cause	Recommended action
		<p>Press and hold the power button for less than four seconds. If the hard drive LED does not turn on green then:</p> <ol style="list-style-type: none"> 1. Check that unit is plugged into a working AC outlet. 2. Open the access panel and check that the power button harness is properly connected to the system board. 3. Check that all power supply cables are properly connected to the system board. 4. Check the power supply functionality. <ol style="list-style-type: none"> a. Disconnect the AC power. b. Unplug cables connected to system board. c. Plug in AC power. <ul style="list-style-type: none"> • If the power supply fan spins, the power supply is good; replace the system board. • If the power supply fan does not spin or the LED does not illuminate, replace the power supply.

* The BIOS option you select controls the blue LED function during these suspend modes.

LED color definitions

The following table describes what each LED light on the computer front panel signifies.

LED state	LED color	System status
Solid	Blue	System is on.
Flashing	Blue	System is in Standby.
Solid or flashing	Red	System has experienced an error. (See POST error messages on page 68.)
None	No light	System is in Hibernate, or is off.

POST error messages

The Power-On Self Test (POST) is a series of diagnostic tests that runs automatically when the computer is turned on.

Audible and visual messages occur before the operating system starts if the POST encounters a problem. POST checks the following items to make sure that the computer system is functioning properly:

- Keyboard
- DIMMs
- Diskette drives
- All mass storage devices
- CPUs
- Controllers
- Fans
- Temperature sensors
- Cables (front/rear panels, audio, and USB ports)

The table shown next describes the POST error messages.

Screen message	Probable cause	Recommended action
102—System Board Failure		Potential system board problem; contact HP Support.
110—Out of memory space for option ROMs	Option ROM for a device could not run because of memory constraints.	Run Computer Setup (f10) Utility to disable unneeded option ROMs, and to enable ACPI/USB Buffers at Top of Memory.
161—Real-Time Clock Power Loss		<ol style="list-style-type: none">1. Run Computer Setup (f10) Utility and set default settings.2. Replace the CMOS battery.3. Replace the system board.
162—Systems Options Error		<ol style="list-style-type: none">1. Run Computer Setup (f10) Utility and set default settings.2. Replace the CMOS battery.3. Replace the system board.

Screen message	Probable cause	Recommended action
163—Time and Date Not Set	<ul style="list-style-type: none"> Invalid time or date in configuration memory. RTC battery might need replacement. CMOS jumper might not be properly installed. 	<ol style="list-style-type: none"> Set the date and time from the Control Panel or in Computer Setup (f10) Utility (depending on the operating system). If the problem persists, replace the RTC battery.
164—Memory Size Error	Memory configuration is incorrect.	Confirm that the correct memory is installed in the system.
201—Memory Error	RAM failure.	<ol style="list-style-type: none"> Run Computer Setup (f10) Utility or the Windows utilities. Be sure that memory modules are installed correctly. Verify the memory module type. Remove and replace memory modules one at a time to isolate faulty modules. Replace faulty memory modules. If the error persists after replacing memory modules, replace the system board.
214—DIMM Configuration Warning	DIMMs are not installed correctly (not paired correctly).	See the service label on the computer access panel for the correct memory configurations, and reseal the DIMMs accordingly.
301—Keyboard Error	Keyboard failure.	<ol style="list-style-type: none"> Reconnect the keyboard with the computer powered off. Connect a keyboard directly to the computer (instead of through a switch box). Be sure that none of the keys are pressed. Replace the keyboard.
303—Keyboard Controller Error	I/O board keyboard controller is defective or is not set properly.	<ol style="list-style-type: none"> Reconnect the keyboard with the computer powered off. Connect a keyboard directly to the computer (instead of through a switch box). Replace the system board.
304—Keyboard or System Unit Error	Keyboard failure.	<ol style="list-style-type: none"> Reconnect the keyboard with the computer powered off. Connect a keyboard directly to the computer (instead of through a switch box). Be sure that none of the keys are pressed. Replace keyboard. Replace system board.
510—Splash Screen image corrupted	Splash Screen image has errors.	Update system BIOS/UEFI.
511—CPU Fan not detected	Fan is not connected or is defective.	<ol style="list-style-type: none"> Reseat the fan cable. Reseat the fan.

Screen message	Probable cause	Recommended action
		3. Replace the fan.
512—Rear chassis fan not detected	Fan missing, disconnected, or defective.	1. Reseat the fan cable. 2. Reseat the fan. 3. Replace the fan.
513—Front Chassis fan not detected	Front fan missing, disconnected, or defective.	1. Reseat the fan cable. 2. Reseat the fan. 3. Replace the fan.
514—Power supply wattage insufficient for hardware configuration	Computer configuration requires more power than the power supply can provide	Reduce the computer power consumption.
515—Power supply fan not detected	Power supply fan is disconnected or defective.	1. Reseat the power supply cables. 2. Replace the power supply.
517—Memory fan not detected	Memory fan missing, disconnected, or defective.	1. Reseat the fan cable. 2. Reseat the fan. 3. Replace the fan.
518—PCI fan not detected	PCI fan missing, disconnected, or defective.	1. Reseat the fan cable. 2. Reseat the fan. 3. Replace the fan.
519—Hard drive fan not detected	Hard drive fan missing, disconnected, or defective.	1. Reseat the fan cable. 2. Reseat the fan. 3. Replace the fan.
520—Memory fan (2) not detected	Memory fan (2) missing, disconnected, or defective.	1. Reseat the fan cable. 2. Reseat the fan. 3. Replace the fan.
521—Memory fan (3) not detected	Memory fan(3) missing, disconnected, or defective.	1. Reseat the fan cable. 2. Reseat the fan. 3. Replace the fan.
522—Memory fan (4) not detected	Memory fan(4) missing, disconnected, or defective.	1. Reseat the fan cable. 2. Reseat the fan. 3. Replace the fan.
523—CPU fan (2) not detected	CPU fan(2) missing, disconnected, or defective.	1. Reseat the fan cable. 2. Reseat the fan. 3. Replace the fan.
524—Rear chassis fan(2) not detected	Rear chassis fan(2) missing, disconnected, or defective.	1. Reseat the fan cable. 2. Reseat the fan. 3. Replace the fan.

Screen message	Probable cause	Recommended action
525—Front chassis fan(2) not detected	Front chassis fan(2) missing, disconnected, or defective.	<ol style="list-style-type: none"> 1. Reseat the fan cable. 2. Reseat the fan. 3. Replace the fan.
526—CPU Liquid Cooling pump not detected	Liquid cooling pump on CPU1 is not detected.	<ol style="list-style-type: none"> 1. Reseat the pump cable. 2. Replace the pump.
527—CPU Liquid Cooling pump (2) not detected	Liquid cooling pump on CPU2 is not detected.	<ol style="list-style-type: none"> 1. Reseat the pump cable. 2. Replace the pump.
528—CPU requires Liquid Cooling solution	Invalid system configuration.	<ol style="list-style-type: none"> 1. Remove incorrect processor and reinstall original processor. 2. Remove incorrect cooling solution and reinstall original liquid cooling solution.
529—Unsupported WiFi Device(s) Detected	An unsupported WiFi device has been installed into an internal slot.	Remove the unsupported device.
917—Front Audio Not Connected	Front Audio mechanism is missing or is not connected.	<ol style="list-style-type: none"> 1. Replace or reconnect the missing front audio mechanism to the system board. 2. Reseat or replace the missing mechanism cable.
918—Front USB Not Connected	Front USB mechanism is missing or is not connected.	<ol style="list-style-type: none"> 1. Replace or reconnect the missing Front USB mechanism to the system board. 2. Reseat or replace the missing mechanism cable.
921—Front USB Not Connected	Front USB mechanism is missing or is not connected.	<ol style="list-style-type: none"> 1. Replace or reconnect the missing Front USB mechanism to the system board. 2. Reseat or replace the missing mechanism cable.
922—Front USB 2 Not Connected	Front USB 2 mechanism is missing or is not connected.	<ol style="list-style-type: none"> 1. Replace or reconnect the missing Front USB 2 mechanism to the system board. 2. Reseat or replace the missing mechanism cable.
923—Fatal IRPP error.		Potential system problem; contact HP Support.
924—Fatal IIO error		Potential system problem; contact HP Support.
925—Fatal Misc. Error	A fatal miscellaneous chipset error is selected.	
927—Fatal error on DIMM in slot CPU X DIMM Y	Fatal multibit ECC error detected on the DIMM in the slot labeled DIMM Y (where Y is a number), as labeled on the system board.	Replace the DIMM in the identified slot.
928—Fatal error occurred in the designated slot.	Fatal error occurred in the designated slot.	Move the card to a different slot. If the problem persists, replace the card.
929—Fatal MCA Errorr	An MCA condition is detected on the system.	
939—Front USB 3.0 Not Connected	Front USB 3.0 mechanism is missing or is not connected.	<ol style="list-style-type: none"> 1. Replace or reconnect the missing Front USB 3.0 mechanism to the system board. 2. Reseat or replace the missing mechanism cable.
940—Front 1394 Not Connected	Front 1394 mechanism is missing or is not connected.	<ol style="list-style-type: none"> 1. Replace or reconnect the missing Front 1394 mechanism to the system board.

Screen message	Probable cause	Recommended action
941—PCIe Device(s) installed in slots 3 or 4 with a single CPU	Invalid system configuration.	<ol style="list-style-type: none"> 2. Reseat or replace the missing mechanism cable.
942—Memory Train Error	A DIMM or DIMMs did not train correctly.	<ol style="list-style-type: none"> 1. Move the PCIe device from PCIe slots 3 and/or 4 to other PCIe slots. 2. Add a second processor using appropriate HP accessory kit.
1801—Microcode Update Error	Unknown or unsupported processor stepping.	The microcode update failed. If the processor stepping is supported, contact HP Support.
1802—Processor Not Supported	The system board does not support the processor.	Replace the processor with a compatible one.

5 Updating the workstation

HP is constantly working on improving your total workstation experience. To ensure that the workstation leverages the latest enhancements, HP recommends that you install the latest BIOS, driver, and software updates on a regular basis.

Updating the workstation after first boot

After successfully booting the workstation for the first time, you should follow these guidelines to ensure that the workstation is up-to-date:

- Ensure that you have the latest system BIOS loaded. See [Upgrading the BIOS on page 73](#).
- Ensure that you have the latest drivers for your system. See [Upgrading device drivers on page 74](#).
- Become familiar with your available HP resources.
- Consider a subscription to Driver Alerts at <http://www.hp.com/go/subscriberschoice>.

Upgrading the BIOS

For optimum performance, determine the BIOS revision on the workstation, and upgrade it if necessary.

Determining the current BIOS version

To determine the current BIOS version:

1. Restart the computer, and then press **esc** while the company logo is displayed. The computer Startup Menu appears.
2. Press **f10** to enter Computer (f10) Setup Utility.
3. Select **File > System Information**. Note the workstation BIOS version and compare it with the BIOS versions that appear on the HP website.

 **NOTE:** For BIOS Menu settings in Computer (f10) Setup utility as well as procedures for upgrading the BIOS, see [BIOS ROM on page 10](#).

Upgrading BIOS

Updated versions of the BIOS may be available on the HP website. Most BIOS updates on the HP website are packaged in compressed files called SoftPaqs.

If the BIOS on the website is the same as the version on your system, no further action is required.

If the BIOS on the website is a version later than the one on your system, download the appropriate version for the workstation. Follow the instructions in the release notes to complete the installation.

Upgrading device drivers

If you install a peripheral device (such as a printer, display adapter, or network adapter), confirm you have the latest device drivers loaded. If you purchased your device through HP, visit the HP website to download the latest drivers for your device. These drivers have been tested to ensure the best compatibility between your device and your HP workstation.

If you did not purchase your device from HP, HP recommends visiting the HP website first to see if your device and its drivers have been tested for HP workstation compatibility. If no driver is available, visit the device manufacturer's website to download the latest drivers.

To upgrade device drivers:

1. Go to <http://www.hp.com/support> and select your country.
2. Select **Drivers and Downloads** and your product.
3. Select the driver language and operating system.
4. Follow the instructions to find the latest drivers available for the workstation.

If a needed driver is not found, see the website of the manufacturer of the peripheral device.

6 Configuring password security and resetting CMOS

This chapter describes how to configure password security and to reset CMOS.

- [Preparing to configure passwords on page 75](#)
- [Resetting the password jumper on page 76](#)
- [Clearing and resetting the CMOS on page 77](#)

Preparing to configure passwords

Computer Setup (f10) Utility enables you to create setup and power-on passwords.

There are three possibilities for setting passwords:

- Define a setup password only. You will need the password to enter Computer Setup (f10) Utility, but you will not need a password to start the workstation.
- Define a power-on password only. This password lets you start the workstation or enter the setup utility.
- Define both. In this case, the setup password lets you start the workstation and enter the setup utility. The power-on password starts the workstation but does not let you enter the setup utility.

After you create both passwords, you can use the setup password in place of the power-on password as an override to log into the computer (a useful feature for a network administrator).



NOTE: You can only clear the passwords with the password jumper. Clearing CMOS does not clear the passwords.



CAUTION: Before pressing the Clear CMOS button, back up your computer CMOS settings.

Pressing the Clear CMOS button resets CMOS values to factory defaults and erases customized information, including asset numbers and special settings.

To back up the CMOS settings, run Computer Setup (f10) Utility and select **Save to Diskette** from the File menu.

Resetting the password jumper

Use the following procedure to disable the power-on or setup password features and clear the power-on and setup passwords.

⚠ WARNING! To reduce the risk of personal injury from electrical shock and hot surfaces, be sure to disconnect the power cord from the wall outlet and allow the internal system components to cool before touching them.

⚠ CAUTION: When the computer is plugged in, the power supply has voltage applied to the system board, even when the computer is turned off. Failure to disconnect the power cord can result in damage to the system.

⚠ CAUTION: Static electricity can damage the electronic components of the computer or optional equipment. Before beginning these procedures, be sure that you are discharged of static electricity by briefly touching a grounded metal object.

1. Access the jumper:
 - a. Shut down the operating system, turn off the computer and external devices, and then disconnect the computer power cord and external devices from power outlets.
 - b. Disconnect any external devices.
 - c. Verify that the AC power cord is disconnected from the power outlet.
 - d. Open the workstation.
 - e. Locate the password header and jumper.

The password header is PSWD. The password jumper is green so it can be easily identified.
2. Remove the jumper from pins 1 and 2. Do not lose the jumper.
3. Restart the computer:
 - a. Close the workstation.
 - b. Reconnect the AC power cord to the power outlet.
 - c. Turn on the computer and wait for the workstation to display the HP splash screen.
4. Repeat step 1.
5. Replace the jumper on pins 1 and 2.
6. Repeat step 3, except press the **f10** key during startup to access Computer Setup (f10) Utility.
7. Use the setup utility to create new passwords.

Clearing and resetting the CMOS

This section describes the steps necessary to successfully clear and reset the CMOS. The CMOS of the computer stores password information and information about the computer configuration.

Using the CMOS button to reset CMOS

To clear CMOS using the Clear CMOS button, use the following procedure:

 **WARNING!** To reduce the risk of personal injury from electric shock and hot surfaces, disconnect the power cord from the wall outlet and allow the internal system components to cool before touching them.

 **CAUTION:** When the computer is plugged in, the power supply has voltage applied to the system board, even when the computer is powered off. Failure to disconnect the power cord can result in damage to the system.

Static electricity can damage the electronic components of the computer or optional equipment. Before beginning these procedures, be sure that you are discharged of static electricity by briefly touching a grounded metal object.

1. Back up your computer CMOS settings, run Computer Setup (f10) Utility, and select **File > Save to Disk**.

 **CAUTION:** Pressing the Clear CMOS button resets CMOS values to factory defaults and erases customized information, including asset numbers and special settings.

2. Shut down the operating system, power off the computer and external devices, and disconnect peripheral devices.
3. Disconnect the AC power cord from the power outlet.

 **NOTE:** The CMOS button does not clear CMOS if the power cord is connected.

4. Open the workstation.
5. Locate, press, and hold the CMOS button for five seconds.

For assistance locating the CMOS button and other system board components, see the system board layout in [Hardware overview on page 1](#).

6. Close the workstation, reconnect external devices, connect the power cord and turn on the workstation.
7. The system boots to an f1 prompt and displays a message that the date/time has changed and that system options have changed.
8. Press **f1**. The system shuts down for three seconds and then powers on again.
9. Use Computer Setup (f10) Utility to reset the date and time.

Using Computer Setup (f10) Utility to reset CMOS

1. Access the Computer Setup (f10) Utility menu.
2. When the Computer Setup Utility message appears in the lower-right corner of the screen, press **f10**, and then press **enter** to bypass the title screen, if necessary.

If you do not press **f10** while the message is displayed, you must restart the computer and try again.

3. From the Computer Setup (f10) Utility menu, select **File > Default Setup**.

This restores the settings that include boot sequence order and other factory settings. However, it does not force hardware rediscovery.

4. Choose **Restore Factory Settings as Default**, and then press **f10** to accept.
5. Select **File > Apply Defaults and Exit**, and then press **f10** to accept.
6. Reset the computer passwords and configuration information, such as the system date and time.



NOTE: This step does not clear the passwords.

A Linux technical notes

HP offers a variety of Linux solutions for HP workstation customers:

- HP offers an Ubuntu preload on some new Z Series Workstations.
- HP certifies and supports Ubuntu on HP workstations.
- HP certifies and supports Red Hat Enterprise Linux (RHEL) on HP workstations.
- HP certifies SUSE Linux Enterprise Desktop (SLED) on HP workstations.
- HP offers a SLED 11 preload on some older Z Series Workstations.

For Linux setup and restore procedures, see the user guide for your workstation at http://www.hp.com/support/workstation_manuals.

- [System RAM](#)
- [Audio](#)
- [Network cards](#)
- [Hyper-Threading Technology](#)
- [NVIDIA Graphics Workstations](#)
- [AMD Graphics Workstations](#)

 **NOTE:** After you set up the operating system, make sure that the latest BIOS, drivers, and software updates are installed.

 **CAUTION:** Do not add optional hardware or third-party devices to the workstation until the operating system is successfully installed. Adding hardware might cause errors and prevent the operating system from installing correctly.

System RAM

HP supports different amounts of total RAM in various HP workstations, based on the number of hardware DIMM slots and the capabilities of the system. The total memory supported for each configuration is listed in the *Hardware Support Matrix for HP Linux Workstations* at http://www.hp.com/support/linux_hardware_matrix.

Audio

All HP workstations come with built-in audio hardware. The audio hardware is supported by the *Advanced Linux Sound Architecture* (ALSA) drivers included with all modern Linux distributions.

The audio hardware provides basic playback and recording features. The ability to simultaneously play audio from multiple sources, such as applications and CDs, is provided in the ALSA driver that provides audio mixing. The performance of software audio mixing and playback is greatly improved in ALSA version 1.0.13 and later.

After the driver is installed, the optional NVIDIA and AMD graphics cards that are supported in HP workstations also provide audio functionality over HDMI. The signal can be passed through the DisplayPort connector to a monitor with audio capabilities. The vendor driver must be installed. Such a configuration

might present two audio hardware choices. If you do not hear sound through the speakers, one possible reason is that the graphics card (default) is selected for audio output instead of the DisplayPort. Check the audio settings (for example, **Sound** in gnome-control-center).

In some systems, embedded Intel HD graphics may also present a similar HDMI audio device that can be used through the DisplayPort interface. No proprietary driver is needed for this device, just a sufficiently recent kernel.

Network cards

All HP workstations include one or two integrated network interface controllers. Some support optional NICs. Most Linux distributions have drivers for these interfaces.

Hyper-Threading Technology

The Z Series Workstations support Hyper-Threading Technology (HTT), an Intel technology that improves processor performance by enabling the processor to simultaneously perform multiple tasks. The operating system treats an HTT-enabled processor as two virtual processors and shares the workload between them when possible. This feature can be used only if the operating system support multiple processors and is specifically optimized for HTT.

To enable HTT:

1. During startup, press **F10** to enter Computer Setup (F10) Utility.
2. Select **Advanced > Performance Options**.
3. Set **Intel Hyper-Threading Technology** to **Enable**, and then press **F10** to exit the menu.
4. Select **Main > Save Changes and Exit**.
5. Restart the system to enable HTT.



NOTE: On most recent Linux distributions (including RHEL 6, SLED 11, and updates to those streams), the kernel automatically detects that HTT is enabled and works correctly.

NVIDIA Graphics Workstations

Some workstation configurations come with NVIDIA Quadro graphics hardware. HP recommends the use of NVIDIA drivers for best results on Linux systems.

HP provides recommended versions of the drivers with RPM-compatible installers for RHEL and SLED distributions. These are available from the HP Installer Kit for Linux and from workstation driver repositories on hp.com. When HP installers are used, their contents and documentation links are located in the `/opt/hp/nvidia` folder.

When installing Linux on a workstation that contains an NVIDIA card, administrators should select a VESA-compatible driver to avoid the instability that is experienced with some open-source versions of the Nouveau and DRM drivers.

Open-source versions of Nouveau drivers and NVIDIA drivers cannot coexist in the same runtime environment because they use the same hardware resources. If administrators create their own Linux environments using NVIDIA drivers but choose not to use HP-packaged versions, HP recommends that they manually append the following boot loader parameters to properly suppress the Nouveau driver at runtime (grub example below):

```
kernel /vmlinuz ... rdblacklist=nouveau nouveau.modeset=0
```

This action is applied by HP installers but must be applied/restored under other circumstances.

To customize display characteristics and resolutions when the computer is using an NVIDIA driver, execute the following command:

```
/usr/bin/nvidia-settings
```

To create and manipulate the `/etc/X11/xorg.conf` file, execute:

```
/usr/bin/nvidia-xconfig
```

AMD Graphics Workstations

Some workstation configurations include AMD graphics hardware. HP recommends use of AMD graphics drivers for best results on Linux systems.

HP also provides recommended versions of AMD graphics drivers with RPM-compatible installers for RHEL and SLED distributions. These are available from the HP Installer Kit for Linux and workstation driver support packages on hp.com.

The open source RADEON and RADEONHD drivers can conflict with the AMD graphics drivers by claiming the hardware early in the boot process. The AMD driver installation process usually blacklists conflicting drivers and turns off kernel mode-setting in the initial RAM image.

Administrator customization of the display characteristics and many other aspects of an AMD graphics driver environment is available through the following command, which starts the Catalyst Control Center:

```
/usr/bin/amdcccle
```

Some settings for AMD graphics, including reconfiguration of the `/etc/X11/xorg.conf` file, can be accomplished through the many options provided by the following command:

```
/usr/bin/aticonfig
```

Information can be found in these directories after the driver is installed:

```
/opt/hp/ati
```

```
/usr/share/ati
```

```
/usr/share/doc/fglrx
```

If the automatic init script attempts to rebuild the kernel module, the name of the log file is `/var/log/fglrx-build.log`.

B Configuring RAID devices

This appendix explains how to configure RAID arrays on your workstation.

Topics

[RAID hard drive maximum and associated storage controller options on page 83](#)

[Supported RAID configurations on page 83](#)

[Configuring Intel SATA RAID on page 84](#)

[Software RAID solution on page 85](#)

For additional information about RAID configuration, go to http://www.hp.com/support/RAID_FAQs.

RAID hard drive maximum and associated storage controller options

This section lists the maximum number of hard drives supported on HP workstations according to RAID configuration and storage controller options.

 **NOTE:** This section applies to internal workstation configurations that do not use add-in cards and external enclosures.

Hard drives		Storage controllers
SATA		Onboard
8.5 mm (3.5 in)	6.3 mm (2.5 in)	RST
3	3	Yes

Supported RAID configurations

The following RAID configurations are supported:

RAID configuration details		
Configuration	Description	Controllers
RAID 0 Integrated striped disk array	<ul style="list-style-type: none"> Requires a minimum of two drives. Provides improved I/O performance. Provides no fault tolerance. Loses all data if any disk in the array fails. Increases disk performance. 	Intel with RST
RAID 1 Mirrored disk array	<ul style="list-style-type: none"> Supports a minimum of two drives. Provides 100% redundancy: all data from one drive is duplicated on a second drive. Recovers from a single-drive failure. Serves as a good entry-level redundant system. 	Intel with RST

Configuring Intel SATA RAID

This section describes how to use Intel® Rapid Storage Technology (RST) to set up and manage SATA RAID volumes.

 **NOTE:** These instructions apply to Windows-based systems. They also apply to Linux distributions that include the iscsi kernel driver support for the RSTe technology. This driver is included on recent releases of most upstream and enterprise distributions, and may be available for addition to some previous releases. If this driver is not available in the distribution, or is not applicable to the platform (e.g., the RST controller), the Software RAID solution is recommended.

You can create a SATA RAID array that contains up to the maximum number of internal SATA hard drives and eSATA drives (if you use an optional eSATA bulkhead cable) supported on your workstation.

The Intel SATA option ROM configuration utilities run when you select **RAID** for the SATA emulation mode.

Two or more hard drives must be attached to the controller for the option ROM to run.

Configuring system BIOS

To set up a RAID configuration, the emulation mode must be set to RAID in Computer Setup (f10) Utility. This is the default setting. If the mode has been changed, follow these steps to reinstate it.

1. During startup, press **esc** to select a language from the list, and then select Computer Setup (f10) Utility.
2. Under Computer Setup (f10) Utility, use the arrow keys to navigate and select options.
3. Select **Storage > Storage Options**, then press **enter**.
4. Select **SATA Emulation > RAID**, then press **f10** to accept the new settings.
5. Select **Advanced > Power-On Options**, then press **enter**.
6. Select **POST Messages > Enable**, and then press **f10** to accept the new settings.
7. Select **Advanced > Device Options**, then press **enter**.
8. Select **SATA RAID Option ROM Download**, then press **enter**.
9. Select **Enable**, then press **f10** to accept the new settings.
10. Select **File > Save Changes and Exit**, then press **enter**.
11. Press **enter** to accept the changes.

Configuring RAID with the Intel utility

Follow these steps to create RAID volumes.

1. Press `ctrl+i`, when prompted, to enter the Intel Rapid Storage Technology utility (RST). Use the arrow keys and the space bar to navigate and select options.



NOTE: If only one hard drive is attached, the utility does not open.

2. Select **Create RAID Volume**, and then press `enter`.
3. Type the a name for the RAID volume in the Name field, and then press `tab`.
4. Select a level in the RAID Level field, and then press `tab`.
5. If three or more hard drives are installed, complete the following steps:
 - a. Press `enter` to display the Select dialog box.
 - b. Select individual physical members of the volume.
 - c. Press `enter` to exit the Select dialog box and to return to the Create Volume Menu dialog box.
6. If appropriate, select a size in the Stripe Size field, and then press `tab`.
7. Enter the desired volume size in the Capacity field, and then press `tab`.
8. Press `enter` to initiate volume creation.
9. When the warning message appears, press `Y` to create the volume.
10. Select **6 > Exit**, then press `enter`.
11. Press `Y` to confirm the exit.

Software RAID solution

This section summarizes software RAID considerations that are specific to the Linux environment, and provides links to additional configuration resources.

Software RAID considerations

The Linux kernel software RAID driver (called *md*, for *multiple device*) offers integrated software RAID without the need for additional hardware disk controllers or kernel patches. Unlike most hardware RAID solutions, software RAID can be used with all types of disk technologies, including SATA, SCSI, and solid-state drives. This software solution requires only minimal setup of the disks themselves.

However, when compared to hardware-based RAID, software RAID has disadvantages in managing the disks, breaking up data as necessary, and managing parity data. The CPU must assume some extra loading: disk-intensive workloads result in roughly double the CPU overhead (for example, from 15% to 30%). For most applications, this overhead is easily handled by excess headroom in the processors. But for some applications where disk and CPU performance are very well balanced and already near bottleneck levels, this additional CPU overhead can become troublesome.

Hardware RAID offers advantages because of its large hardware cache and the capability for better scheduling of operations in parallel. However, software RAID offers more flexibility for disk and disk controller setup. Additionally, hardware RAID requires that a failed RAID controller must be replaced with an identical model to avoid data loss, whereas software RAID imposes no such requirements.

Some software RAID schemes offer data protection through mirroring (copying the data to multiple disks in case one disk fails) or parity data (checksums that allow error detection and limited rebuilding of data in case

of a failure). For all software RAID solutions on HP workstations, redundancy can be restored only after the system is shut down so that the failed drive can be replaced. This replacement requires only a minimum amount of work.

Performance considerations

Disk I/O bandwidth is typically limited by the system bus speeds, the disk controller, and the disks themselves. The balance of these hardware limitations, as affected by the software configuration, determines the location of the any bottleneck is in the system.

Several RAID levels offer improved performance relative to stand-alone disk performance. If disk throughput is restricted because of a single disk controller, RAID can probably do little to improve performance until another controller is added. Conversely, if raw disk performance is the bottleneck, a tuned software RAID solution can dramatically improve the throughput. The slower disk performance is, relative to the rest of the system, the better RAID performance will scale, because the slowest piece of the performance pipeline is being directly addressed by moving to RAID.

Configuring software RAID

See the following sites for additional information about configuring software RAID on Red Hat Enterprise Linux (RHEL) or SUSE Linux Enterprise Desktop (SLED):

- Red Hat Enterprise Linux 6—See the *Storage Administration Guide* at http://docs.redhat.com/docs/en-US/Red_Hat_Enterprise_Linux/6/html/Storage_Administration_Guide/index.html
- Red Hat Enterprise Linux 5—See the *Deployment Guide* at http://docs.redhat.com/docs/en-US/Red_Hat_Enterprise_Linux/5/html/Deployment_Guide/ch-raid.html.
- SLED 11—See the *Deployment Guide* at http://www.suse.com/documentation/sled11/book_sle_deployment/?page=/documentation/sled11/book_sle_deployment/data/book_sle_deployment.html.

C System board designators

System board designators

Designator	Silk screen	Component
E15	E15	Crisis recovery header/jumper
E49	PSWD	Clear password header/jumper
J9	J9 RJ/USB	LAN/DUAL USB
J10	J10 QUAD USB	Dual USB3.0/Dual USB2.0
J31	SLOT1 PCIe2 x4(1)	PCIe2 x4(1) connector
J33	SLOT3 PCIe2 x1	PCIe2 x1 connector
J34	SLOT5 PCI 32/33	PCI 32/33 connector
J41	SLOT2 PCIe3 x16	PCIe3 x16 connector
J53	DISPLAY PORT	DisplayPort connector
J64	DP	Dual-Mode DisplayPort connector
J65	DVI	DVI-I connector
J68	J68 PS2	Stacked keyboard/mouse connector
J78	IN/OUT	Audio line in stacked over audio line out
J86	J86	Slot2 PCIe x16 retention clip
MTG1-MTG8	N/A	Mounting holes
P1	P1	Power supply connector, 6-pin (white)
P2	PWRCMD	Power command, 6-pin (white)
P5	P5	Power button/HDD LED/Power LED switch/Side access panel sensor/Temperature header
P6	SPKR	Speaker
P8	CPU FAN	CPU fan header
P9	P9	Front fan header
P11	CHF Fan	Rear system fan
P23	P23 FRONT AUD	Front audio header
P24	P24 FRONT USB	Front panel USB header
P52	COM	Serial port header
P60-P63	SATA0-SATA3	SATA connectors
P64	SATA5	eSATA connector
P124	P124 HOOD LOCK	Side access panel solenoid lock header

Designator	Silk screen	Component
P126	PAR	Parallel port header
P152	MEDIA2	USB 3.0 Media card reader
SW50	SW50 CMOS	Clear CMOS switch/push button
XBT1	XBT1 BAT	Battery holder
XMM1 - XMM4	XMM1 - XMM4 DIMM1 - DIMM4	Memory slots
XU1	XU1	Primary CPU socket

Index

B

BIOS

- determining version 73
- upgrading 73

BIOS ROM 10

C

Cable management 40

Chat Support 54

CMOS 75

- clearing and resetting 77

components 1

- front panel 1
- rear panel 2

Configuring RAID devices 82

- maximum hard drives allowed 83

SATA RAID 84

customer

- advisories 54
- bulletins 54
- notices 54
- self repair 56

D

Desktop management 23

- Altiris Client Management Solutions 25

FailSafe Boot Block ROM 26

- Fault notification and recovery 34

HP Client Manager Software 25

- HP SoftPaq Download Manager 26

HPQFlash 26

- Initial configuration 24

- programmable power button 34

Remote ROM Flash 26

- Remote system install 24

ROM Flash 26

- System Software Manager 26

- Updating software 25

- Workstation security 27

device drivers, upgrading 74

Diagnostic codes and errors 64

- LED and beep codes 64
- LED colors 68
- POST errors 68

Diagnostics 51

Diagnostics and troubleshooting

- Diagnosis guidelines 52
- Locating ID labels 52
- Locating warranty info 52

DIMM configurations, supported 46

DIMM installation order 47

E

environmental specifications 7

Expansion card slot identification 44

F

front panel components 1

H

helpful hints 55

HP Chat Support 54

HP PC Hardware Diagnostics (UEFI)

- downloading 64
- using 64

HP Support Center 54

M

Memory

- DIMM installation guidelines 47

O

online support 54

Operating system setup 79

operation 55

P

Password configuration 75

Password jumper

- resetting 76

Power supply

- Expansion card configuration restrictions 43
- power consumption 49

resetting 49

- specifications 48

product

- specifications 7

Product features

- ERP compliance mode 9
- Hyper-threading 10
- Physical characteristics 6
- SATA Power Management 10
- System board architecture 5
- Turbo Boost 10

Product overview 1

R

rear panel components 2

Replacing components

Battery 40

cable management 40

Component locations 4

CPU (processor) and CPU

heatsink 42

expansion slots 43

guidelines 40

hard drive 45

information and guidelines 36

Memory 46

power supply 48

Service considerations 37

warnings and cautions 36

S

security bulletins 54

self repair 56

specifications, product 7

startup 55

support

- online 54

Support Center 54

System board designators 87

System management 9

T

Troubleshooting 51

troubleshooting resources and

- tools 54

U

updates

workstation 73

workstation after first boot 73

upgrade

BIOS 73

device drivers 74

W

Workstation setup

Ensuring proper ventilation 8