

SUPER  [®]

X9DRFF-iG+
X9DRFF-iTG+
X9DRFF-7G+
X9DRFF-7TG+

USER'S MANUAL

Revision 1.0b

The information in this User's Manual has been carefully reviewed and is believed to be accurate. The vendor assumes no responsibility for any inaccuracies that may be contained in this document, and makes no commitment to update or to keep current the information in this manual, or to notify any person or organization of the updates. **Please Note: For the most up-to-date version of this manual, please see our Website at www.supermicro.com.**

Super Micro Computer, Inc. ("Supermicro") reserves the right to make changes to the product described in this manual at any time and without notice. This product, including software and documentation, is the property of Supermicro and/or its licensors, and is supplied only under a license. Any use or reproduction of this product is not allowed, except as expressly permitted by the terms of said license.

IN NO EVENT WILL SUPER MICRO COMPUTER, INC. BE LIABLE FOR DIRECT, INDIRECT, SPECIAL, INCIDENTAL, SPECULATIVE OR CONSEQUENTIAL DAMAGES ARISING FROM THE USE OR INABILITY TO USE THIS PRODUCT OR DOCUMENTATION, EVEN IF ADVISED OF THE POSSIBILITY OF SUCH DAMAGES. IN PARTICULAR, SUPER MICRO COMPUTER, INC. SHALL NOT HAVE LIABILITY FOR ANY HARDWARE, SOFTWARE, OR DATA STORED OR USED WITH THE PRODUCT, INCLUDING THE COSTS OF REPAIRING, REPLACING, INTEGRATING, INSTALLING OR RECOVERING SUCH HARDWARE, SOFTWARE, OR DATA.

Any disputes arising between the manufacturer and the customer shall be governed by the laws of Santa Clara County in the State of California, USA. The State of California, County of Santa Clara shall be the exclusive venue for the resolution of any such disputes. Supermicro's total liability for all claims will not exceed the price paid for the hardware product.

FCC Statement: This equipment has been tested and found to comply with the limits for a Class A digital device pursuant to Part 15 of the FCC Rules. These limits are designed to provide reasonable protection against harmful interference when the equipment is operated in a commercial environment. This equipment generates, uses, and can radiate radio frequency energy and, if not installed and used in accordance with the manufacturer's instruction manual, may cause harmful interference with radio communications. Operation of this equipment in a residential area is likely to cause harmful interference, in which case you will be required to correct the interference at your own expense.

California Best Management Practices Regulations for Perchlorate Materials: This Perchlorate warning applies only to products containing CR (Manganese Dioxide) Lithium coin cells. "Perchlorate Material-special handling may apply. See www.dtsc.ca.gov/hazardouswaste/perchlorate".

WARNING: Handling of lead solder materials used in this product may expose you to lead, a chemical known to the State of California to cause birth defects and other reproductive harm.

Manual Revision 1.0b

Release Date: October 30, 2013

Unless you request and receive written permission from Super Micro Computer, Inc., you may not copy any part of this document.

Information in this document is subject to change without notice. Other products and companies referred to herein are trademarks or registered trademarks of their respective companies or mark holders.

Copyright © 2013 by Super Micro Computer, Inc.
All rights reserved.

Printed in the United States of America

Preface

This manual is written for system integrators, PC technicians and knowledgeable PC users. It provides information for the installation and use of the X9DRFF-iG+/iTG+/7G+/7TG+ motherboard.

About This Motherboard

The Super X9DRFF-iG+/iTG+/7G+/7TG+ motherboard supports dual Intel E5-2600 (v2) Series Processors (Socket R LGA 2011) that offer QPI (Intel QuickPath Interface) Technology (V.1.1), providing point-to-point connection with a transfer speed of up to 8.0 TG/s. With the C602 chipset built in, the X9DRFF-iG+/iTG+/7G+/7TG+ motherboard supports Intel® Intelligent Power Node Manager (NM), Management Engine (ME) Technology, Digital Media Interface (DMI), PCI-E Gen. 3.0 and up to 1866 MHz DDR3 memory. This motherboard is ideal for SMCi Fat Twin server platforms. Please refer to our Website (<http://www.supermicro.com>) for GPU and memory support updates.

Manual Organization

Chapter 1 describes the features, specifications and performance of the motherboard. It also provides detailed information about Intel C602 chipset.

Chapter 2 provides hardware installation instructions. Read this chapter when installing the processor, memory modules and other hardware components into the system. If you encounter any problems, see **Chapter 3**, which describes troubleshooting procedures for video, memory, and system setup stored in the CMOS.

Chapter 4 includes an introduction to the BIOS, and provides detailed instructions on how to run the CMOS Setup utility.

Appendix A provides BIOS Error Beep Codes.

Appendix B lists Software Installation Instructions.

Conventions Used in the Manual

Pay special attention to the following symbols for proper system installation and to prevent damage to the system or injury to yourself:

Warning: Important information given to ensure proper system installation or to prevent damage to the components



Note: Additional information given to differentiate between various models or provides information for correct system setup.

Contacting Supermicro

Headquarters

Address: Super Micro Computer, Inc.
980 Rock Ave.
San Jose, CA 95131 U.S.A.

Tel: +1 (408) 503-8000

Fax: +1 (408) 503-8008

Email: marketing@supermicro.com (General Information)
support@supermicro.com (Technical Support)

Web Site: www.supermicro.com

Europe

Address: Super Micro Computer B.V.
Het Sterrenbeeld 28, 5215 ML
's-Hertogenbosch, The Netherlands

Tel: +31 (0) 73-6400390

Fax: +31 (0) 73-6416525

Email: sales@supermicro.nl (General Information)
support@supermicro.nl (Technical Support)
rma@supermicro.nl (Customer Support)

Asia-Pacific

Address: Super Micro Computer, Inc.
3F, No. 150, Jian 1st Rd.
Zhonghe Dist., New Taipei City 23511
Taiwan (R.O.C)

Tel: +886-(2) 8226-3990

Fax: +886-(2) 8226-3992

Web Site: www.supermicro.com.tw

Technical Support:

Email: support@supermicro.com.tw

Tel: +886-(2)-8226-3990

Table of Contents

Preface

Chapter 1 Overview

1-1	Overview	1-1
1-2	Processor and Chipset Overview.....	1-11
1-3	Special Features	1-12
1-4	PC Health Monitoring.....	1-12
1-5	ACPI Features.....	1-13
1-6	Power Supply	1-13
1-7	Super I/O.....	1-14
1-8	Advanced Power Management.....	1-14
	Intel® Intelligent Power Node Manager (IPNM)	1-14
	Management Engine (ME).....	1-14
1-9	Overview of the Nuvoton WPCM450 Controller	1-15
	WPCM450R DDR2 Memory Interface	1-15
	WPCM450R PCI System Interface.....	1-15
	Other Features Supported by the WPCM BMC Controller.....	1-15

Chapter 2 Installation

2-1	Standardized Warning Statements	2-1
	Battery Handling.....	2-1
	Product Disposal	2-3
2-2	Static-Sensitive Devices.....	2-4
	Precautions	2-4
	Unpacking	2-4
2-3	Processor and Heatsink Installation.....	2-5
	Installing the LGA2011 Processor	2-5
	Installing a Passive CPU Heatsink	2-9
	Removing the Heatsink.....	2-10
2-4	Installing and Removing the Memory Modules.....	2-11
	Installing & Removing DIMMs.....	2-11
	Removing Memory Modules	2-11
2-5	Motherboard Installation.....	2-16
	Tools Needed	2-16
	Location of Mounting Holes	2-16
	Installing the Motherboard	2-17
2-6	Control Panel Connectors and I/O Ports	2-18
	Front Panel Connectors and I/O Ports	2-18

Front Panel I/O Port Locations and Definitions	2-18
Universal Serial Bus (USB).....	2-19
Video Connection.....	2-19
Ethernet Ports	2-20
Power Button/Unit Identifier Switch.....	2-21
2-7 Connecting Cables.....	2-22
Fan Headers.....	2-23
IPMB.....	2-24
SATA Device Power Connector.....	2-24
T-SGPIO 1/2 & 6-SGPIO 1/2 Headers.....	2-25
Power SMB (I ² C) Connector	2-25
Power Switch.....	2-26
Unit Identification Switch/LED	2-26
2-8 Jumper Settings	2-27
Explanation of Jumpers	2-27
GLAN Enable/Disable	2-27
CMOS Clear	2-28
Watch Dog Enable/Disable	2-28
VGA Enable.....	2-29
BMC Enable	2-29
Management Engine (ME) Recovery	2-30
Manufacture Mode Select	2-30
SAS Enable (For X9DRFF-7G+/7TG+).....	2-31
2-9 Onboard LED Indicators	2-32
GLAN LEDs.....	2-32
IPMI Dedicated LAN LEDs.....	2-32
HDD Activity LED	2-33
BMC Heartbeat LED	2-33
SAS Heartbeat LED	2-34
Failure LED	2-34
UID LED	2-35
2-10 SATA/SAS Connections	2-36
SATA/SAS Ports.....	2-36
Chapter 3 Troubleshooting	
3-1 Troubleshooting Procedures	3-1
3-2 Technical Support Procedures	3-4
3-3 Battery Removal and Installation	3-5

3-4	Frequently Asked Questions	3-6
3-5	Returning Merchandise for Service.....	3-7

Chapter 4 BIOS

4-1	Introduction.....	4-1
4-2	Main Setup.....	4-2
4-3	Advanced Setup Configurations.....	4-4
4-4	Event Logs	4-23
4-5	IPMI.....	4-25
4-6	Boot.....	4-27
4-7	Security.....	4-28
4-8	Save & Exit	4-29

Appendix A BIOS Error Beep Codes

Appendix B Software Installation Instructions

B-1	Installing Software Programs	B-1
B-2	Configuring SuperDoctor® III.....	B-2

Chapter 1

Overview

1-1 Overview

Checklist

Congratulations on purchasing your computer motherboard from an acknowledged leader in the industry. Supermicro boards are designed with the utmost attention to detail to provide you with the highest standards in quality and performance.

This motherboard was designed to be used in an SMC-proprietary system as a part of an integrated system platform.



Note: For your system to work properly, please follow the links below to download all necessary drivers/utilities and the user's manual for your motherboard.

SMCI product manuals: <http://www.supermicro.com/support/manuals/>

Product Drivers and utilities: <ftp://ftp.supermicro.com/>

If you have any questions, please contact our support team at support@supermicro.com.

SUPER Motherboard Image

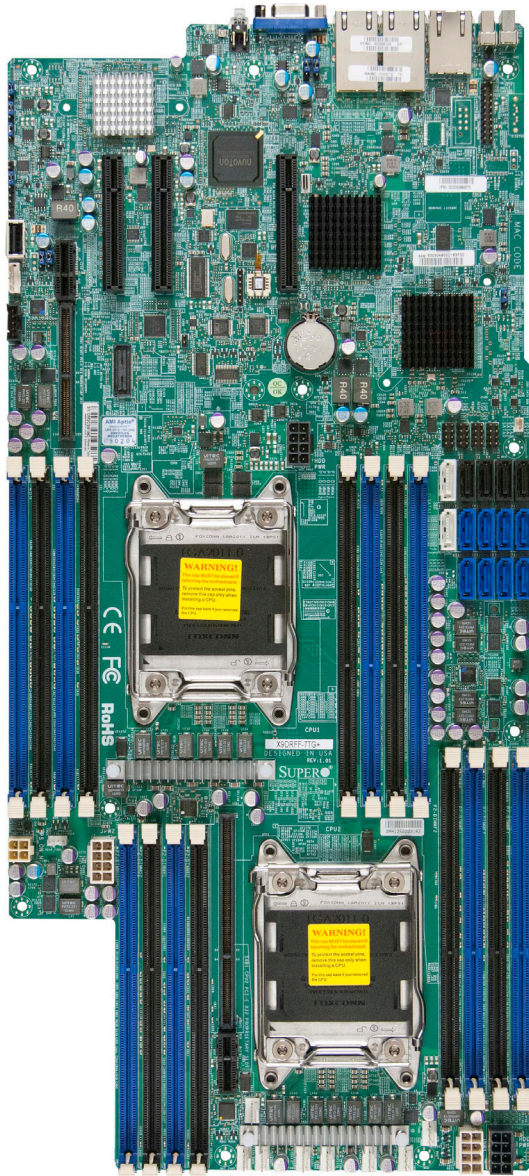

 **Note:** All graphics shown in this manual were based upon the latest PCB Revision available at the time of publishing of the manual. The motherboard you've received may or may not look exactly the same as the graphics shown in this manual.

Motherboard Layout

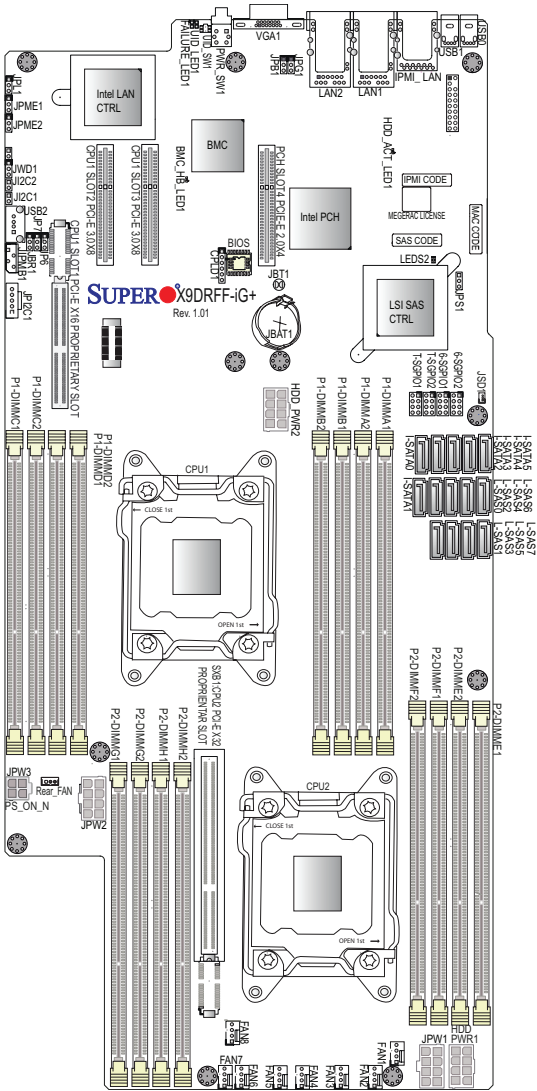

 **Note 1:** For the latest CPU/Memory updates, please refer to our Website at <http://www.supermicro.com/products/motherboard/> for details.

Note 2: Changing BMC log-in information is recommended during initial system power-on. The default username is ADMIN and password is ADMIN. For BMC best practices, please refer to: http://www.supermicro.com/products/nfo/files/IPMI/Best_Practices_BMC_Security.pdf

X9DRFF-iG+/iTG+/7G+/7TG+ Quick Reference

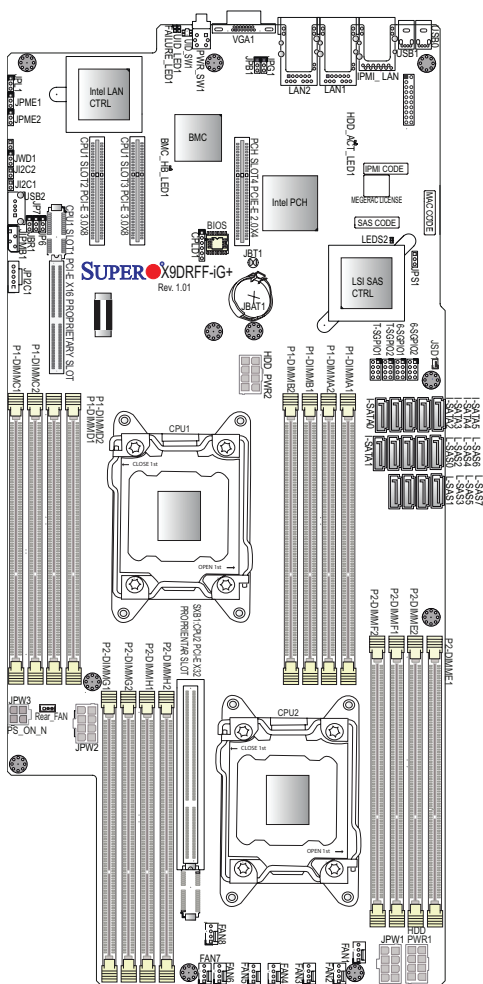

 **Notes:**

- See Chapter 2 for detailed information on jumpers, I/O ports and JF1 front panel connections.
- "■" indicates the location of "Pin 1".
- Jumpers/LED Indicators not indicated are for testing only.
- Use only the correct type of onboard CMOS battery as specified by the manufacturer. Do not install the onboard battery upside down to avoid possible explosion.

X9DRFF-iG+/iTG+/7G+/7TG+ Jumpers

Jumper	Description	Default Setting
JBT1	Clear CMOS	See Chapter 2
JI ² C1/JI ² C2	SMB to PCI-E Slots	Open (Disabled)
JPB1	BMC Enable	Pins 1-2 (Enabled)
JPG1	VGA Enable	Pins 1-2 (Enabled)
JPL1	LAN1/LAN2 Enable	Pins 1-2 (Enabled)
JPME1	Management Engine (ME) Recovery Mode	Pins 1-2 (Normal)
JPME2	Management Engine (ME) Manufacture Mode	Pins 1-2 (Normal)
JPS1	SAS Enable (7G+/7TG+ Only)	Pins 1-2 (Enabled)
JWD1	Watch Dog Timer Enable	Pins 1-2 (Reset)

X9DRFF-iG+/iTG+/7G+/7TG+ Connectors

Connectors	Description
FAN1-FAN8, Rear_FAN1	CPU/System/Cooling Fan Headers
HDD_PWR1/HDD_PWR2	8-pin Power Supply Connectors for HDD Device Use
JBAT1	Onboard CMOS Battery (See Chpt. 3 for Battery Disposal)
JIPMB1	4-pin External BMC I ² C Header (for an IPMI Card)
JI ² C1	Power Supply SMBbus I ² C Header
JPW1/JPW2	8-pin Power Connectors
JPW3	4-pin Power Connector (PS_ON_N)
JSD1	SATA Device Power Connector
JTPM1	TPM (Trusted Platform Module)/Port 80 Connector
LAN1/LAN2	G-bit Ethernet LAN Ports 1/2 (X9DRFF-iG+/7G+), 10 G_bit LAN Ports 1/2 (X9DRFF-iTG+/7TG+)
(IPMI) LAN	IPMI LAN
PWR_SW1	Power Switch (Button)
(I-)SATA 0/1	SATA 3.0 Connectors 0/1 from Intel AHCI
(I-) SATA 2-5	SATA 2.0 Connectors 2/3/4/5 from Intel AHCI
(L)-SAS 0-7	SAS Connectors 0-7 from LSI 2308 SAS Controller (X9DRFF-7G+/7TG+ Only)
6-SGPIO 1/2	Serial_Link General Purpose I/O Headers for SAS connections (X9DRFF-7G+/7TG+)
T-SGPIO 1/2	Serial_Link General Purpose I/O Headers 1/2 for Intel SATA connections
(CPU1) Slot1	PCI-Exp. 3.0 x16 SMC-Proprietary Slot



(CPU1) Slot2/Slot3	PCI-Exp. 3.0 x8 Slots
SXB1 (CPU2) PCI-E x32 Slot	PCI-Exp. 3.0 x32 SMC-Proprietary Slot
UID_SW1	UID (Unit Identifier) Switch (SW1)
USB0/USB1	Front Panel USB 0/ USB1 Ports
(J)USB2	Internal USB 2 Port
VGA1	Front Panel VGA Port

X9DRFF-iG+/iTG+/7G+/7TG+ LED Indicators

LED	Description	State	Status
BMC_HB_LED1	BMC Heartbeat LED	Green: Blinking	BMC Normal
HDD_ACT LED1	HDD Activity LED	Green: Blinking	HDD Active
Failure_LED1	Failure LED	On/Blinking	On: Power Failure; Blinking: Fan Failure
LEDS2	SAS Heartbeat LED	Green	SAS Normal
UID_LED1	UID LED	Blue: On	Unit Identified

 **Note:** To provide adequate power supply to the motherboard, be sure to use SMC-proprietary power supply to connect 8-pin power connectors (JPW1/JPW2), and 4-pin power connectors (JPW3). SMC-proprietary backplanes or adaptor cards may be required to ensure adequate power supply to your system. Refer to the server user's manual that came with your system for instructions on power supply recommendations.

Motherboard Features

CPU	<ul style="list-style-type: none"> Dual Intel® E5-2600(v2) Series Processors (Socket R LGA 2011); each processor supports four full-width Intel QuickPath Interconnect (QPI) links (with support of up to 25.6 GT/s per QPI link and with Data Transfer Rate of up to 8.0 GT/s per direction). <p> Note: For Intel E5-2600(v2) processor support, BIOS version 3.0 or above is required.</p>
Memory	<ul style="list-style-type: none"> Integrated memory controller supports up to 1 TB of Load Reduced (LRDIMM), 512 GB of Registered (RDIMM) or 128 GB of Unbuffered (UDIMM) ECC/ Non-ECC DDR3 800/1066/1333/1600/1866 MHz 240-pin 4-channel memory modules in 16 DIMM slots. <p> Note 1: 1866 MHz memory speed is dependent on Intel E5-2600v2 CPUs.</p> <p>Note 2: For an updated memory support list, please refer to the Tested Memory List on the motherboard specification webpage.</p>
Chipset	<ul style="list-style-type: none"> Intel® C602 Chipset
Expansion Slot	<ul style="list-style-type: none"> One (1) PCI-E 3.0 x32 (SMC-Proprietary) slot (SXB1 CPU2 3.0 x32 Slot) One (1) PCI-E 3.0 x16 (SMC-Proprietary) slot (CPU1 Slot 1) Two (2) PCI-E 3.0 x8 slots (CPU1 Slot 2/Slot 3), One (1) PCI-E 2.0 x4 slot (PCH Slot 4)
Graphics	<ul style="list-style-type: none"> Nuvoton WPCM450R G200 Graphics Controller
Network	<ul style="list-style-type: none"> Intel X540 dual-channel 10G Base-T (T) Ethernet controller for LAN 1/LAN 2 ports (X9DRFF-iTG+/7TG+ only), Intel i350 dual-channel Gigabit (10/100/1000 Mb/s) Ethernet controller for LAN 1/LAN 2 ports (for X9DRFF-iG+/7G+)
	<ul style="list-style-type: none"> Nuvoton WPCM450R Base-Board Controller (BMC) supports IPMI_LAN 2.0

I/O Devices	SATA Connections	
	<ul style="list-style-type: none"> SATA Ports 	Two (2) SATA 3.0 (I-SATA 0/1), Four (4) SATA 2.0 Ports from Intel AHCI (I-SATA 2-5),
	SAS Ports (X9DRFF-7G+/7TG+ Only)	
	<ul style="list-style-type: none"> SAS Ports 	Eight (8) SAS 2.0 Ports from LSI 2308 SAS Controller
	<ul style="list-style-type: none"> RAID 	RAID 0, 1, 10
	Integrated IPMI 2.0	
	<ul style="list-style-type: none"> IPMI 2.0 supported by the WPCM450R BMC 	
	Super I/O	
<ul style="list-style-type: none"> Winbond Super I/O 83527HG 		
Peripheral Devices	USB Devices	
	<ul style="list-style-type: none"> Two (2) USB ports on the front I/O panel (USB 0/1), One (1) Type A USB connector (JUSB 2) 	
BIOS	<ul style="list-style-type: none"> 16 MB SPI AMI BIOS[®] SM Flash BIOS 	
	<ul style="list-style-type: none"> APM 1.2, DMI 2.3, PCI 2.3, ACPI 1.0/2.0/3.0/4.0, USB Keyboard, Plug & Play (PnP) and SMBIOS 2.5 	
Power Config.	<ul style="list-style-type: none"> ACPI/ACPM Power Management 	
	<ul style="list-style-type: none"> Main switch override mechanism 	
	<ul style="list-style-type: none"> Intel[®] Intelligent Power Node Manager (NM) Management Engine (ME) 	
	 (Note: Special power supply required. See the note on Page 1-14)	
	<ul style="list-style-type: none"> Keyboard Wake-up from Soft-Off 	
	<ul style="list-style-type: none"> Power-on mode for AC power recovery 	
PC Health Monitoring	CPU Monitoring	
	<ul style="list-style-type: none"> Onboard voltage monitors for 3.3V, +3.3VSB, 5V, +5VSB, +12V/-12V, VBAT, HT, memory voltages, CPU core voltages, chipset voltages. 	
	<ul style="list-style-type: none"> CPU 5+1-Phase switching voltage regulator 	
	<ul style="list-style-type: none"> CPU/System overheat LED and control 	
	<ul style="list-style-type: none"> CPU Thermal Design Power (TDP): supports up to 130W (See Note 1 next page) 	
	<ul style="list-style-type: none"> CPU Thermal Trip support 	
	<ul style="list-style-type: none"> Thermal Monitor 2 (TM2) support 	

	<table border="1"> <thead> <tr> <th colspan="2">Fan Control</th> </tr> </thead> <tbody> <tr> <td></td> <td> <ul style="list-style-type: none"> Fan status monitoring with firmware 4-pin (Pulse Width Modulation) fan speed control </td> </tr> <tr> <td></td> <td> <ul style="list-style-type: none"> Low noise fan speed control </td> </tr> </tbody> </table>	Fan Control			<ul style="list-style-type: none"> Fan status monitoring with firmware 4-pin (Pulse Width Modulation) fan speed control 		<ul style="list-style-type: none"> Low noise fan speed control
Fan Control							
	<ul style="list-style-type: none"> Fan status monitoring with firmware 4-pin (Pulse Width Modulation) fan speed control 						
	<ul style="list-style-type: none"> Low noise fan speed control 						
System Management	<ul style="list-style-type: none"> PECI (Platform Environment Configuration Interface) 2.0 support System resource alert via SuperDoctor® III SuperDoctor® III, Watch Dog, NMI 						
Dimensions	<ul style="list-style-type: none"> 18.72" (L) x 8.54" (W) (475.49 mm x 216.92 mm) 						



Note 1: CPU Maximum Thermal Design Power (TDP) is subject to chassis and heatsink cooling restrictions. For proper thermal management, please check the chassis and heatsink specifications for proper CPU TDP sizing.

Note 2: For IPMI Configuration Instructions, please refer to the Embedded IPMI Configuration User's Guide available @ <http://www.supermicro.com/support/manuals/>.

Note 3: Changing BMC log-in information is recommended during initial system power-on. The default username is ADMIN and password is ADMIN. For BMC best practices, please refer to: http://www.supermicro.com/products/nfo/files/IPMI/Best_Practices_BMC_Security.pdf

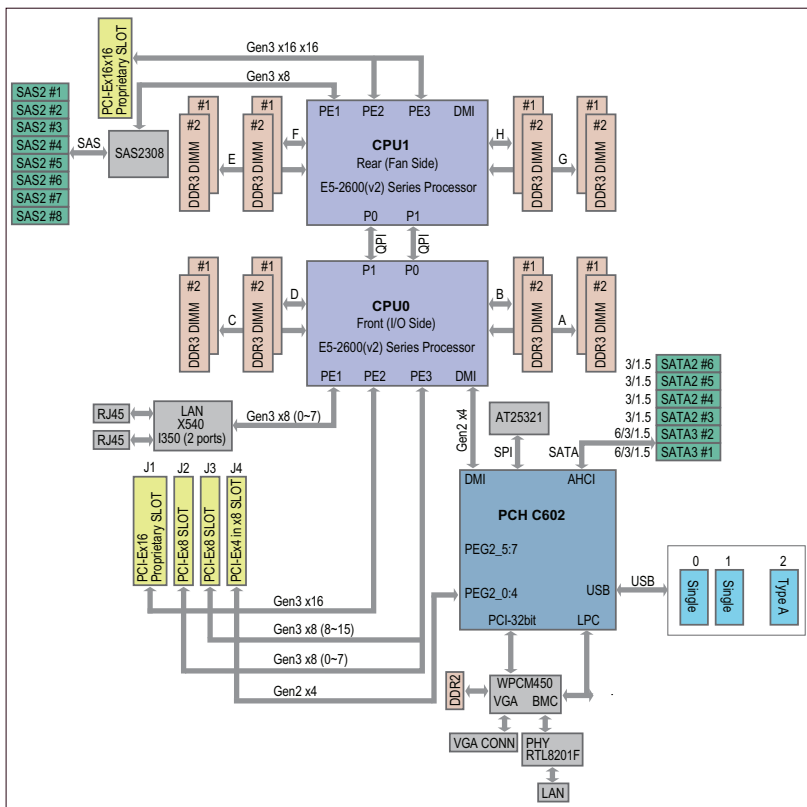

System Block Diagram

 **Note:** This is a general block diagram and may not exactly represent the features on your motherboard. See the Motherboard Features pages for the actual specifications of each motherboard.

1-2 Processor and Chipset Overview

Built upon the functionality and the capability of Intel E5-2600(v2) Series Processors (Socket R LGA 2011) and the C602 chipset, the X9DRFF-iG+/iTG+/7G+/7TG+ motherboard provides the performance and feature sets required for dual-processor-based 4U Fat Twin server platforms.

With support of Intel QuickPath interconnect (QPI) Technology, the X9DRFF-iG+/iTG+/7G+/7TG+ offers point-to-point serial interconnect interface with a transfer speed of up to 8.0 GT/s, providing superb system performance.

The C602 chipset provides extensive IO support, including the following functions and capabilities:

- PCI-E 2.0 and 3.0 support
- ACPI Power Management Logic Support, Rev. 3.0b
- Intel® Intelligent Power Node Management (NM) (Special PS cables required)
- Management Engine (ME)
- Intel Rapid Storage Technology supported
- Intel Virtualization Technology for Directed I/O (Intel VT-d) supported
- Intel Trusted Execution Technology supported
- Serial Peripheral Interface (SPI) Supported
- Intel Anti-Theft Technology (Intel AT) supported
- Digital Media Interface (DMI) supported
- Advanced Host Controller Interface (AHCI) supported
- Compatibility Modules (DMA Controller, Timer/Counters, Interrupt Controller) supported



Note: For Intel E5-2600(v2) processor support, BIOS version 3.0 or above is required.

1-3 Special Features

Recovery from AC Power Loss

The Basic I/O System (BIOS) provides a setting that determines how the system will respond when AC power is lost and then restored to the system. You can choose for the system to remain powered off (in which case you must press the power switch to turn it back on), or for it to automatically return to the power-on state. See the Advanced BIOS Setup section for this setting. The default setting is **Last State**.

1-4 PC Health Monitoring

This section describes the features of PC health monitoring of the motherboard. This motherboard has an onboard System_Hardware_Monitor chip that supports PC health monitoring. An onboard voltage monitor will scan the following onboard voltages continuously: Onboard voltage monitors for 3.3V, +3.3VSB, 5V, +5VSB, +12V/-12V, VBAT, HT, memory voltages, chipset voltages and CPU core voltages . Once a voltage becomes unstable, a warning is given, or an error message is sent to the screen. The user can adjust the voltage thresholds to define the sensitivity of the voltage monitor.

Environmental Temperature Control

A thermal control sensor monitors the CPU temperatures in real time and will turn on the thermal control fans whenever the CPU temperature exceeds a user-defined threshold. The overheat circuitry runs independently from the CPU. Once it detects that the CPU temperature is too high, it will automatically turn on the thermal fan control to prevent the CPU from overheating. The onboard chassis thermal circuitry can monitor the overall system temperature and alert the user when the chassis temperature is too high.



Note: To avoid possible system overheating, please be sure to provide adequate airflow to your system.

System Resource Alert

This feature is available when used with SuperDoctor[®] III in the Windows OS environment or used with SuperDoctor II in Linux. SuperDoctor is used to notify the user of certain system events. For example, you can configure SuperDoctor to provide you with warnings when the system temperature, CPU temperatures, voltages, and fan speeds go beyond a predefined range.

1-5 ACPI Features

ACPI stands for Advanced Configuration and Power Interface. The ACPI specification defines a flexible and abstract hardware interface that provides a standard way to integrate power management features throughout a PC system, including its hardware, operating system and application software. This enables the system to automatically turn on and off peripherals such as CD-ROMs, network cards, hard disk drives and printers.

In addition to operating_system-directed power management, ACPI also provides a generic system event mechanism for Plug and Play, and an operating system-independent interface for configuration control. ACPI leverages the Plug and Play BIOS data structures while providing a processor_architecture-independent implementation that is compatible with Windows 7, Windows 8, and Windows 2008 Operating Systems.

Slow Blinking LED for Suspend-State Indicator

When the CPU goes into a suspend state, the chassis power LED will start blinking to indicate that the CPU is in the suspend mode. When the user presses any key, the CPU will "wake up," and the LED will automatically stop blinking and remain on.

1-6 Power Supply

As with all computer products, a stable power source is necessary for proper and reliable operation. It is even more important for processors that have high CPU clock rates.

The X9DRFF-iG+/iTG+/7G+/7TG+ motherboard supports two 8-pin and one 4-pin power supplies. Although most power supplies generally meet the specifications required by the CPU, some are inadequate. All these power connections are required for Fat Twin use only.



Note: To ensure adequate power to the system, SMC-proprietary power backplanes or adaptors may be required. Refer to the server user's manual that came with your system for detailed instructions on power supply recommendations.

1-7 Super I/O

The Super I/O provides functions that comply with ACPI (Advanced Configuration and Power Interface), which includes support of legacy and ACPI power management through an SMI or SCI function pin. It also features auto power management to reduce power consumption.



Note 1: For more information on IPMI configuration, please refer to the IPMI User's Guide posted on our website at <http://www.supermicro.com/support/manuals/>.

Note 2: The term "IPMI controller" and the term "BMC controller" can be used interchangeably in this section.

1-8 Advanced Power Management

The new advanced power management features supported by this motherboard include IPNM and ME. Please note that you will need to do the following to use these two new features:

- Use a power supply that supports PMBus 1.1 or 1.2.
- Install the NMView software in your system. NMView is optional and can be purchased from Supermicro.

Intel[®] Intelligent Power Node Manager (IPNM)

The Intel[®] Intelligent Power Node Manager (IPNM) provides your system with real-time thermal control and power management for maximum energy efficiency. Although IPNM is supported by the BMC (Baseboard Management Controller), your system must also have IPNM-compatible Management Engine (ME) firmware installed in your system for IPNM support.



Note: Support for IPNM Specification Version 1.5 or Vision 2.0 depends on the power supply used in the system.

Management Engine (ME)

The Management Engine, which is an ARC controller embedded in the PCH, provides Server Platform Services (SPS) to your system. The services provided by SPS are different from those provided by the ME on client platforms.

1-9 Overview of the Nuvoton WPCM450 Controller



Note: The term "IPMI controller" and the term "BMC controller" can be used interchangeably in this section.

The Nuvoton WPCM450R Controller, a Baseboard Management Controller (BMC), supports 2D/VGA-compatible Graphic Cores with PCI interface, creating multi-media virtualization via Keyboard/Video/Mouse Redirection (KVMR). The WPCM450R Controller is ideal for remote system management.

The WPCM450R Controller interfaces with the host system via PCI connections to communicate with the graphics cores. It supports USB 2.0 and 1.1 for remote keyboard/mouse/virtual media emulation. It also provides LPC interface support to control Super IO functions. The WPCM450R Controller is connected to the network via an external Ethernet PHY module or shared NCSI connections.

The WPCM450R communicates with onboard components via six SMBus interfaces, PECE (Platform Environment Control Interface) buses, and General Purpose I/O ports.

WPCM450R DDR2 Memory Interface

The WPCM450R supports a 16-bit DDR2 memory module with a speed of up to 220 MHz. For best signal integrity, the WPCM450R provides point-to-point connection.

WPCM450R PCI System Interface

The WPCM450R provides 32-bit, 33 MHz 3.3V PCI interface, which is compliant with the PCI Local Bus Specification Rev. 2.3. The PCI system interface connects to the onboard PCI Bridge used by the graphics controller.

Other Features Supported by the WPCM BMC Controller

The WPCM450R supports the following features:

- IPMI 2.0
- Serial over LAN
- KVM over LAN
- LAN Alerting-SNMP Trap
- Event Log
- X-Bus parallel interface for I/O expansion

- Multiple ADC inputs, Analog and Digital Video outputs
- SPI Flash Host BIOS and firmware bootstrap program supported
- Reduced Media Independent Interface (RMII)
- OS (Operating System) Independency
- Provides remote Hardware Health Monitoring via IPMI. Key features
- Provides Network Management Security via remote access/console redirection.
- Supports the following Management tools: IPMIView, CLI (Command Line Interface)
- RMCP+ protocol supported



Note 1: For more information on IPMI configuration, please refer to the IPMI User's Guide posted on our website at <http://www.supermicro.com/support/manuals/>.

Note 2: The term "IPMI controller" and the term "BMC controller" can be used interchangeably in this section.

Chapter 2

Installation

2-1 Standardized Warning Statements

The following statements are industry-standard warnings, provided to warn the user of situations which have the potential for bodily injury. Should you have questions or experience difficulty, contact Supermicro's Technical Support department for assistance. Only certified technicians should attempt to install or configure components.

Read this section in its entirety before installing or configuring components in the Supermicro chassis.

Battery Handling



Warning!

There is a danger of explosion if the battery is replaced incorrectly. Replace the battery only with the same or equivalent type recommended by the manufacturer. Dispose of used batteries according to the manufacturer's instructions

電池の取り扱い

電池交換が正しく行われなかった場合、破裂の危険性があります。交換する電池はメーカーが推奨する型、または同等のものを使用下さい。使用済電池は製造元の指示に従って処分して下さい。

警告

電池更換不當會有爆炸危險。請只使用同類電池或製造商推薦的功能相當的電池更換原有電池。請按製造商的說明處理廢舊電池。

警告

電池更換不當會有爆炸危險。請使用製造商建議之相同或功能相當的電池更換原有電池。請按照製造商的說明指示處理廢棄舊電池。

Warnung

Bei Einsetzen einer falschen Batterie besteht Explosionsgefahr. Ersetzen Sie die Batterie nur durch den gleichen oder vom Hersteller empfohlenen Batterietyp. Entsorgen Sie die benutzten Batterien nach den Anweisungen des Herstellers.

Attention

Danger d'explosion si la pile n'est pas remplacée correctement. Ne la remplacer que par une pile de type semblable ou équivalent, recommandée par le fabricant. Jeter les piles usagées conformément aux instructions du fabricant.

¡Advertencia!

Existe peligro de explosión si la batería se reemplaza de manera incorrecta. Reemplazar la batería exclusivamente con el mismo tipo o el equivalente recomendado por el fabricante. Desechar las baterías gastadas según las instrucciones del fabricante.

אזהרה!

קיימת סכנת פיצוץ של הסוללה במידה והוחלפה בדרך לא תקינה. יש להחליף את הסוללה בסוג התואם מחברת יצרן מומלצת.

סילוק הסוללות המושמשות יש לבצע לפי הוראות היצרן.

هناك خطر من انفجار في حالة استبدال البطارية بطريقة غير صحيحة فعليك استبدال البطارية فقط بنفس النوع أو ما يعادلها كما أوصت به الشركة المصنعة تخلص من البطاريات المستعملة وفقا لتعليمات الشركة الصانعة

경고!

배터리가 올바르게 교체되지 않으면 폭발의 위험이 있습니다. 기존 배터리와 동일하거나 제조사에서 권장하는 동등한 종류의 배터리로만 교체해야 합니다. 제조사의 안내에 따라 사용된 배터리를 처리하여 주십시오.

Waarschuwing

Er is ontploffingsgevaar indien de batterij verkeerd vervangen wordt. Vervang de batterij slechts met hetzelfde of een equivalent type die door de fabrikant aanbevolen wordt. Gebruikte batterijen dienen overeenkomstig fabrieksvorschriften afgevoerd te worden.

Product Disposal



Warning!

Ultimate disposal of this product should be handled according to all national laws and regulations.

製品の廃棄

この製品を廃棄処分する場合、国の関係する全ての法律・条例に従い処理する必要があります。

警告

本产品的废弃处理应根据所有国家的法律和规章进行。

警告

本產品的廢棄處理應根據所有國家的法律和規章進行。

Warnung

Die Entsorgung dieses Produkts sollte gemäß allen Bestimmungen und Gesetzen des Landes erfolgen.

¡Advertencia!

Al deshacerse por completo de este producto debe seguir todas las leyes y reglamentos nacionales.

Attention

La mise au rebut ou le recyclage de ce produit sont généralement soumis à des lois et/ou directives de respect de l'environnement. Renseignez-vous auprès de l'organisme compétent.

סילוק המוצר

אזהרה!

סילוק סופי של מוצר זה חייב להיות בהתאם להנחיות וחוקי המדינה.

عند التخلص النهائي من هذا المنتج ينبغي التعامل معه وفقا لجميع القوانين واللوائح الوطنية

경고!

이 제품은 해당 국가의 관련 법규 및 규정에 따라 폐기되어야 합니다.

Waarschuwing

De uiteindelijke verwijdering van dit product dient te geschieden in overeenstemming met alle nationale wetten en reglementen.

2-2 Static-Sensitive Devices

Electrostatic Discharge (ESD) can damage electronic components. To avoid damaging your system board, it is important to handle it very carefully. The following measures are generally sufficient to protect your equipment from ESD.

Precautions

- Use a grounded wrist strap designed to prevent static discharge.
- Touch a grounded metal object before removing the board from the antistatic bag.
- Handle the board by its edges only; do not touch its components, peripheral chips, memory modules or gold contacts.
- When handling chips or modules, avoid touching their pins.
- Put the motherboard and peripherals back into their antistatic bags when not in use.
- For grounding purposes, make sure that your system chassis provides excellent conductivity between the power supply, the case, the mounting fasteners and the motherboard.

Unpacking

The motherboard is shipped in antistatic packaging to avoid static damage. When unpacking the board, make sure that the person handling it is static protected.

2-3 Processor and Heatsink Installation

Warning: When handling the processor package, avoid placing direct pressure on the label area.

 **Notes:**

- Always connect the power cord last, and always remove it before adding, removing or changing any hardware components. Make sure that you install the processor into the CPU socket before you install the CPU heatsink.
- If you buy a CPU separately, make sure that you use an Intel-certified multi-directional heatsink only.
- Make sure to install the system board into the chassis before you install the CPU heatsink.
- When receiving a server board without a processor pre-installed, make sure that the plastic CPU socket cap is in place and none of the socket pins are bent; otherwise, contact your retailer immediately.
- Refer to the Supermicro website for updates on CPU support.

Installing the LGA2011 Processor

1. There are two load levers on the LGA2011 socket. To open the socket cover, first press and release the load lever labeled 'Open 1st'.

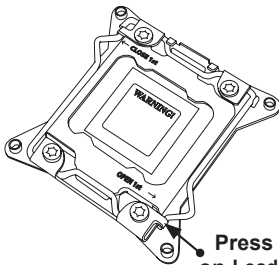
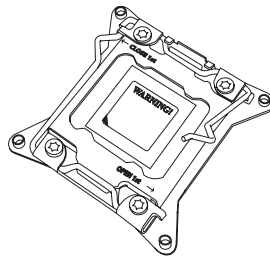
1**2**

Press down
on Load Lever
labeled 'Open 1st'.

2. Press the second load lever labeled 'Close 1st' to release the load plate that covers the CPU socket from its locking position.

1

Press down on Load the
Lever labeled 'Close 1st'

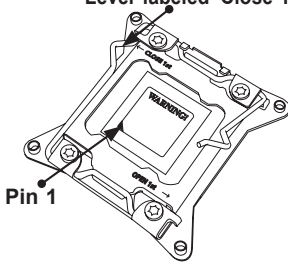

2

Pull lever away from
the socket

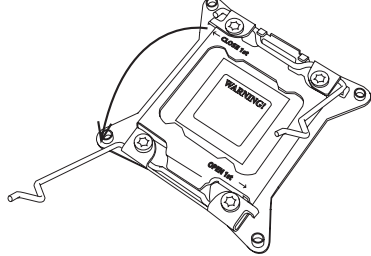

3. With the lever labeled 'Close 1st' fully retracted, gently push down on the 'Open 1st' lever to open the load plate. Lift the load plate to open it completely.

1

Gently push
down to pop the
load plate open.

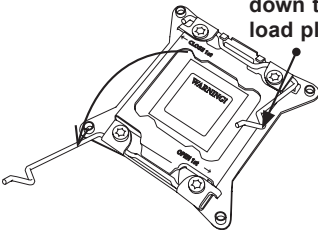

2

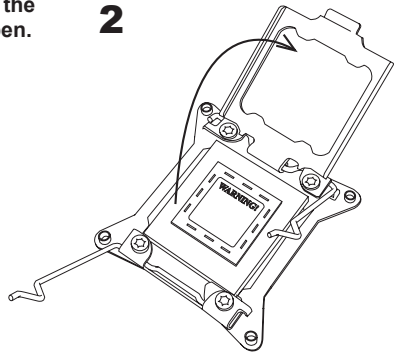

1. Using your thumb and the index finger, remove the 'WARNING' plastic cap from the socket.

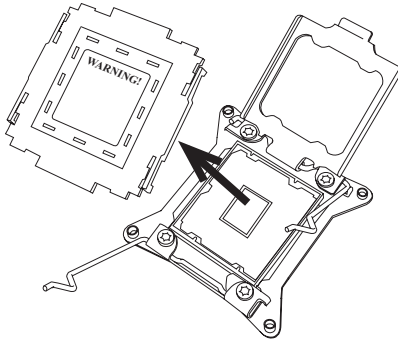

2. Use your thumb and index finger to hold the CPU on its edges. Align the CPU keys, which are semi-circle cutouts, against the socket keys.

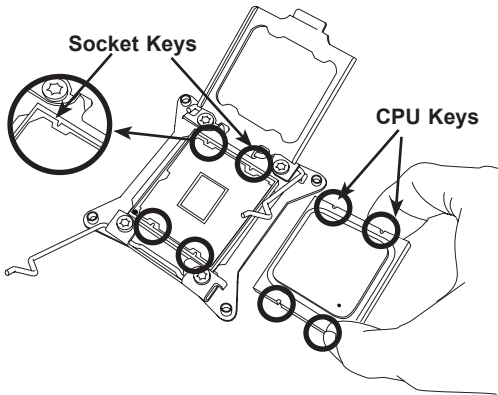

3. Once they are aligned, carefully lower the CPU straight down into the socket. (Do not drop the CPU on the socket. Do not move the CPU horizontally or vertically. Do not rub the CPU against the surface or against any pins of the socket to avoid damaging the CPU or the socket.)

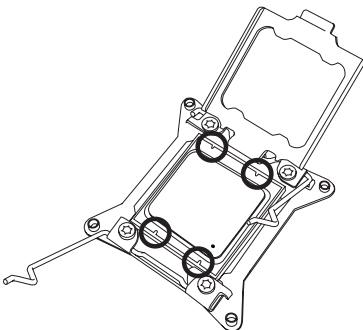

Warning: You can only install the CPU inside the socket in one direction. Make sure that it is properly inserted into the CPU socket before closing the load plate. If it doesn't close properly, do not force it as it may damage your CPU. Instead, open the load plate again and double-check that the CPU is aligned properly.

4. With the CPU inside the socket, inspect the four corners of the CPU to make sure that the CPU is properly installed.
5. Close the load plate with the CPU inside the socket. Lock the lever labeled 'Close 1st' first, then lock the lever labeled 'Open 1st' second. Use your thumb to gently push the load levers down to the lever locks.

1

Gently close
the load plate.

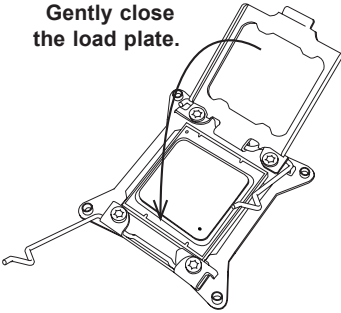

2

Push down and lock the
level labeled 'Close 1st'.

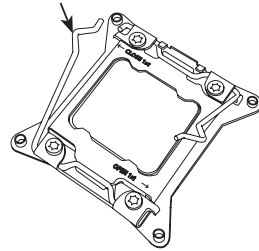

3

Lever Lock

Push down and
lock the lever
labeled 'Open 1st'

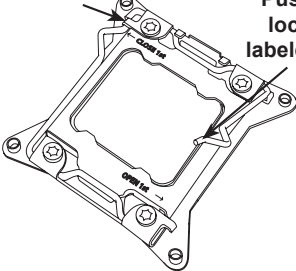

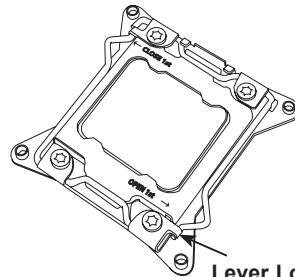

4

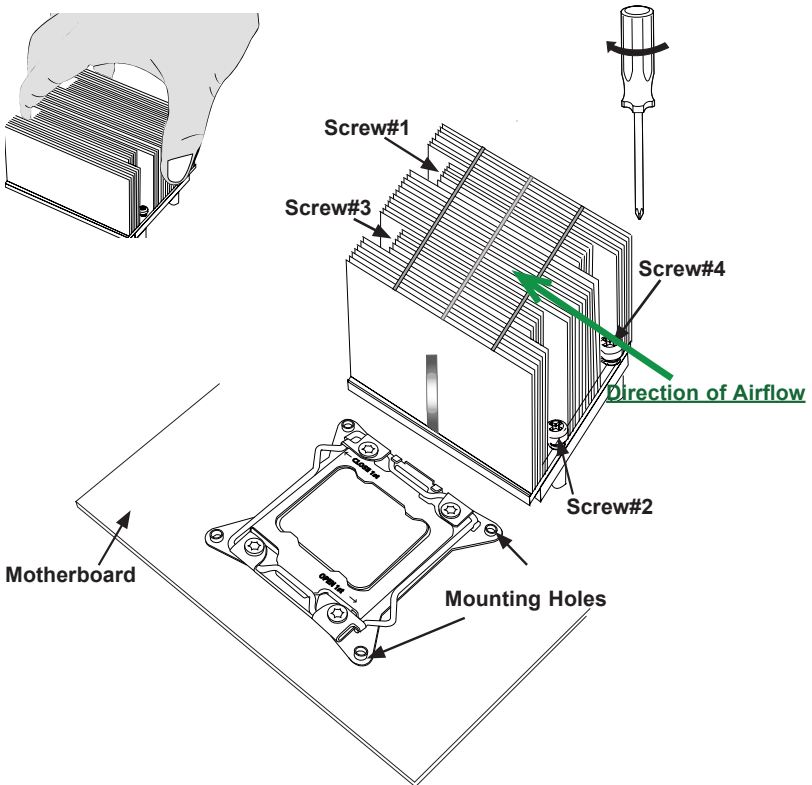

Installing a Passive CPU Heatsink

1. Do not apply any thermal grease to the heatsink or the CPU die -- the required amount has already been applied.
2. Place the heatsink on top of the CPU so that the four mounting holes are aligned with those on the Motherboard's and the Heatsink Bracket underneath.
3. Screw in two diagonal screws (i.e., the #1 and the #2 screws) until just snug (-do not over-tighten the screws to avoid possible damage to the CPU.)
4. Finish the installation by fully tightening all four screws.



 **Notes:** 1. For optimized airflow, please follow your chassis airflow direction to install the correct CPU heatsink direction. 2. Graphic drawings included in this manual are for reference only. They might look different from the components installed in your system.

Removing the Heatsink

Warning: We do not recommend that the CPU or the heatsink be removed. However, if you do need to uninstall the heatsink, please follow the instructions below to avoid damaging the CPU or the CPU socket.

1. Unscrew the heatsink screws from the motherboard in the sequence as shown in the illustration below.
2. Gently wriggle the heatsink to loosen it from the CPU. (Do not use excessive force when wriggling the heatsink!)
3. Once the CPU is loosened from the heatsink, remove the CPU from the CPU socket.
4. Remove the used thermal grease and clean the surface of the CPU and the heatsink, Reapply the proper amount of thermal grease on the surface before reinstalling the CPU and the heatsink.

Loosen screws in sequence as shown.

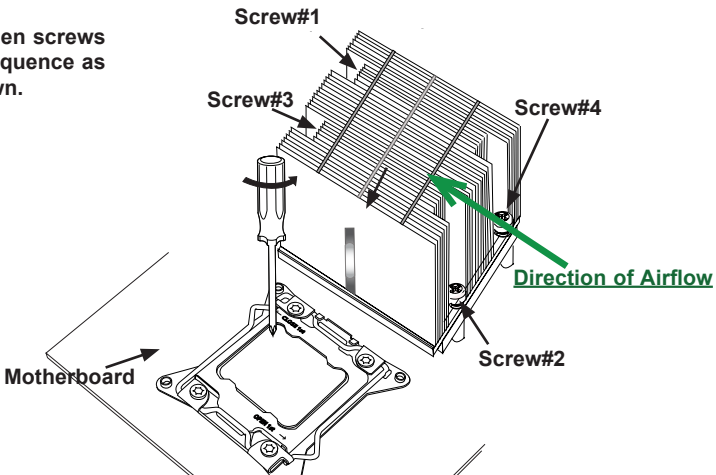

⚠ Do not reuse thermal grease!

2-4 Installing and Removing the Memory Modules

 **Note:** Check Supermicro's Website for recommended memory modules.

CAUTION

Exercise extreme care when installing or removing DIMM modules to prevent any possible damage.

Installing & Removing DIMMs

1. Insert the desired number of DIMMs into the memory slots, starting with P1-DIMMA1. (For best performance, please use the memory modules of the same type and speed in the same bank.)
2. Push the release tabs outwards on both ends of the DIMM slot to unlock it.

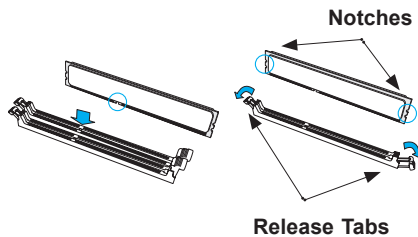
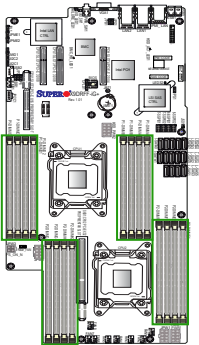

3. Align the key of the DIMM module with the receptive point on the DIMM slot.
4. Align the notches on both ends of the module against the receptive points on the ends of the slot.
5. Use two thumbs together to press the notches on both ends of the module straight down into the slot until the module snaps into place.
6. Press the release tabs to the locking positions to secure the DIMM module into the slot.

Press both notches straight down into the memory slot at the same time.

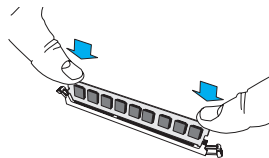

Removing Memory Modules

Press both notches at the ends of a DIMM module to unlock it. Once it is loosened from the memory slot, remove the DIMM module from the motherboard.

Memory Support for the X9DRFF-iG+/iTG+/7G+/7TG+ Motherboard

The X9DRFF-iG+/iTG+/7G+/7TG+ motherboard supports up to 1 TB of Load Reduced (LRDIMM), 512 GB of Registered (RDIMM) or 128 GB of Unbuffered (UDIMM) ECC/Non-ECC DDR3 800/1066/1333/1600/1866 MHz 240-pin 4-channel memory modules in 16 DIMM slots. Please refer to our website at <http://www.supermicro.com/products/motherboard>.

Processor & Memory Module Population Configuration

For memory to work properly, follow the tables below for memory installation.

Processors and their Corresponding Memory Modules								
CPU#	Corresponding DIMM Modules							
CPU 1	P1-DIMMA1	P1-DIMMB1	P1-DIMMC1	P1-DIMMD1	P1-DIMMA2	P1-DIMMB2	P1-DIMMC2	P1-DIMMD2
CPU2	P2-DIMME1	P2-DIMMF1	P2-DIMMG1	P2-DIMMH1	P2-DIMME2	P2-DIMM F2	P2-DIMMG2	P2-DIMMH2

Processor and Memory Module Population for Optimal Performance	
Number of CPUs+DIMMs	CPU and Memory Population Configuration Table (For memory to work properly, please follow the instructions below.)
1 CPU & 2 DIMMs	CPU1 P1-DIMMA1/P1-DIMMB1
1 CPU & 4 DIMMs	CPU1 P1-DIMMA1/P1-DIMMB1, P1-DIMMC1/P1-DIMMD1
1 CPU & 5-8 DIMMs	CPU1 P1-DIMMA1/P1-DIMMB1, P1-DIMMC1/P1-DIMMD1 + Any memory pairs in P1-DIMMA2/P1-DIMMB2/P1-DIMMC2/P1-DIMMD2 slots
2 CPUs & 4 DIMMs	CPU1 + CPU2 P1-DIMMA1/P1-DIMMB1, P2-DIMME1/P2-DIMMF1
2 CPUs & 6 DIMMs	CPU1 + CPU2 P1-DIMMA1/P1-DIMMB1/P1-DIMMC1/P1-DIMMD1, P2-DIMME1/P2-DIMMF1
2 CPUs & 8 DIMMs	CPU1 + CPU2 P1-DIMMA1/P1-DIMMB1/P1-DIMMC1/P1-DIMMD1, P2-DIMME1/P2-DIMMF1/P2-DIMMG1/P2-DIMMH1
2 CPUs & 10-16 DIMMs	CPU1/CPU2 P1-DIMMA1/P1-DIMMB1/P1-DIMMC1/P1-DIMMD1, P2-DIMME1/P2-DIMMF1/P2-DIMMG1/P2-DIMMH1 + Any memory pairs in P1, P2 DIMM slots
2 CPUs & 16 DIMMs	CPU1/CPU2 P1-DIMMA1/P1-DIMMB1/P1-DIMMC1/P1-DIMMD1, P2-DIMME1/P2-DIMMF1/P2-DIMMG1/P2-DIMMH1, P1-DIMMA2/P1-DIMMB2/P1-DIMMC2/P1-DIMMD2, P2-DIMME2/P2-DIMMF2/P2-DIMMG2/P2-DIMMH2



Notes: 1866 MHz memory speed is dependent on Intel E5-2600v2 CPUs. For Intel E5-2600(v2) processor support, BIOS version 3.0 or above is required.

Populating UDIMM (ECC/Non-ECC) Memory Modules

Intel E5-2600(v2) Series Processor UDIMM Memory Support											
Ranks Per DIMM & Data Width	Memory Capacity Per DIMM (See the Note below)			Speed (MT/s) and Voltage Validated by Slot per Channel (SPC) and DIMM Per Channel (DPC)							
				2 Slots Per Channel				3 Slots Per Channel			
	1DPC		2DPC		1DPC		2DPC				
	1.35V	1.5V	1.35V	1.5V	1.35V	1.5V	1.35V	1.5V	1.35V	1.5V	
SRx8 Non-ECC	1GB	2GB	4GB	NA	1066, 1333, 1600, 1866	NA	1066, 1333, 1600	N/A	1066, 1333, 1600, 1866	N/A	1066, 1333, 1600
DRx8 Non-ECC	2GB	4GB	8GB	NA	1066, 1333, 1600, 1866	NA	1066, 1333, 1600	N/A	1066, 1333, 1600, 1866	N/A	1066, 1333, 1600
SRx16 Non-ECC	512MB	1GB	2GB	NA	1066, 1333, 1600, 1866	NA	1066, 1333, 1600	N/A	1066, 1333, 1600, 1866	N/A	1066, 1333, 1600
SRx8 ECC	1GB	2GB	4GB	1066, 1333	1066, 1333, 1600, 1866	1066, 1333	1066, 1333, 1600	1066, 1333	1066, 1333, 1600, 1866	1066, 1333	1066, 1333, 1600
DRx8 ECC	2GB	4GB	8GB	1066, 1333	1066, 1333, 1600, 1866	1066, 1333	1066, 1333, 1600	1066, 1333	1066, 1333, 1600, 1866	1066, 1333	1066, 1333, 1600

Note: For detailed information on memory support and updates, please refer to the SMC Recommended Memory List posted on our website at <http://www.supermicro.com/support/resources/mem.cfm>.

Populating RDIMM (ECC) Memory Modules

Intel E5-2600(v2) Series Processor RDIMM Memory Support													
Ranks Per DIMM & Data Width	Memory Capacity Per DIMM (See the Note Below)			Speed (MT/s) and Voltage Validated by Slot per Channel (SPC) and DIMM Per Channel (DPC)									
				2 Slots Per Channel				3 Slots Per Channel					
	1DPC		2DPC		1 DPC		2DPC		3DPC				
	1.35V	1.5V	1.35V	1.5V	1.35V	1.5V	1.35V	1.5V	1.35V	1.5V			
SRx8	1GB	2GB	4GB	1066, 1333	1066, 1333, 1600, 1866	1066, 1333	1066, 1333, 1600	1066, 1333	1066, 1333, 1600, 1866	1066, 1333, 1600	800	800, 1066	
DRx8	2GB	4GB	8GB	1066, 1333	1066, 1333, 1600, 1866	1066, 1333	1066, 1333, 1600	1066, 1333	1066, 1333, 1600, 1866	1066, 1333, 1600	800	800, 1066	
SRx4	2GB	4GB	8GB	1066, 1333	1066, 1333, 1600, 1866	1066, 1333	1066, 1600	1066, 1333	1066, 1333, 1600, 1866	1066, 1333, 1600	800	800, 1066	
DRx4	4GB	8GB	16GB	1066, 1333	1066, 1333, 1600, 1866	1066, 1333	1066, 1600	1066, 1333	1066, 1333, 1600, 1866	1066, 1333, 1600	800	800, 1066	
QRx4	8GB	16GB	32GB	800	800, 1066	800	800	800	800, 1066	800	800	N/A	N/A
QRx8	4GB	8GB	16GB	800	800, 1066	800	800	800	800, 1066	800	800	N/A	N/A

Note: For detailed information on memory support and updates, please refer to the SMC Recommended Memory List posted on our website at <http://www.supermicro.com/support/resources/mem.cfm>.

Populating UDIMM (ECC/Non-ECC) Memory Modules

Intel E5-2600 Series Processor UDIMM Memory Support											
Ranks Per DIMM & Data Width	Memory Capacity Per DIMM (See the Note below)			Speed (MT/s) and Voltage Validated by Slot per Channel (SPC) and DIMM Per Channel (DPC)							
				2 Slots Per Channel				3 Slots Per Channel			
	1DPC		2DPC		1DPC		2DPC				
	1.35V	1.5V	1.35V	1.5V	1.35V	1.5V	1.35V	1.5V			
SRx8 Non-ECC	1GB	2GB	4GB	NA	1066, 1333	NA	1066, 1333	N/A	1066, 1333,	N/A	1066, 1333
DRx8 Non-ECC	2GB	4GB	8GB	NA	1066, 1333	NA	1066, 1333	N/A	1066, 1333,	N/A	1066, 1333
SRx16 Non-ECC	512MB	1GB	2GB	NA	1066, 1333	NA	1066, 1333	N/A	1066, 1333	N/A	1066, 1333
SRx8 ECC	1GB	2GB	4GB	1066, 1333	1066, 1333	1066	1066, 1333	1066	1066, 1333,	1066, 1333	1066, 1333
DRx8 ECC	2GB	4GB	8GB	1066, 1333	1066, 1333	1066	1066, 1333	1066	1066, 1333,	1066, 1333	1066, 1333

Note: For detailed information on memory support and updates, please refer to the SMC Recommended Memory List posted on our website at <http://www.supermicro.com/support/resources/mem.cfm>.

Populating RDIMM (ECC) Memory Modules

Intel E5-2600 Series Processor RDIMM Memory Support													
Ranks Per DIMM & Data Width	Memory Capacity Per DIMM (See the Note Below)			Speed (MT/s) and Voltage Validated by Slot per Channel (SPC) and DIMM Per Channel (DPC)									
				2 Slots Per Channel				3 Slots Per Channel					
	1DPC		2DPC		1 DPC		2DPC		3DPC				
	1.35V	1.5V	1.35V	1.5V	1.35V	1.5V	1.35V	1.5V	1.35V	1.5V	1.35V	1.5v	
SRx8	1GB	2GB	4GB	1066, 1333	1066, 1333, 1600	1066, 1333	1066, 1333, 1600	1066, 1333	1066, 1333, 1600	1066, 1333	1066, 1333, 1600	N/A	800, 1066
DRx8	2GB	4GB	8GB	1066, 1333	1066, 1333, 1600	1066, 1333	1066, 1333, 1600	1066, 1333	1066, 1333, 1600	1066, 1333	1066, 1333, 1600	N/A	800, 1066
SRx4	2GB	4GB	8GB	1066, 1333	1066, 1333, 1600	1066, 1333	1066, 1333, 1600	1066, 1333	1066, 1333, 1600	1066, 1333	1066, 1333, 1600	N/A	800, 1066
DRx4	4GB	8GB	16GB	1066, 1333	1066, 1333, 1600	1066, 1333	1066, 1333, 1600	1066, 1333	1066, 1333, 1600	1066, 1333	1066, 1333, 1600	N/A	800, 1066
QRx4	8GB	16GB	32GB	800	1066	800	800	800	1066	800	800	N/A	N/A
QRx8	4GB	8GB	16GB	800	1066	800	800	800	1066	800	800	N/A	N/A

Note: For detailed information on memory support and updates, please refer to the SMC Recommended Memory List posted on our website at <http://www.supermicro.com/support/resources/mem.cfm>.

Populating LRDIMM (ECC) Memory Modules

Intel E5-2600(v2) Series Processor LRDIMM Memory Support												
Ranks Per DIMM & Data Width	Memory Capacity Per DIMM (See the Note Below)		Speed (MT/s) and Voltage Validated by Slot per Channel (SPC) and DIMM Per Channel (DPC)									
			2 Slots Per Channel				3 Slots Per Channel					
			1DPC		2DPC		1DPC		2DPC		3DPC	
			1.35V	1.5V	1.35V	1.5V	1.35V	1.5V	1.35V	1.5V	1.35V	1.5V
QRx4 (DDP)	16GB	32GB	1066, 1333, 1600	1066, 1333, 1600, 1866	1066, 1333, 1600	1066, 1333, 1600	1066, 1333, 1600	1066, 1333, 1600	1066, 1333, 1600	1066, 1333, 1600	1066	1066
8Rx4 (QDP)	32GB	64GB	1066	1066	1066	1066	1066	1066	1066	1066	1066	1066

Note: For detailed information on memory support and updates, please refer to the SMC Recommended Memory List posted on our website at <http://www.supermicro.com/support/resources/mem.cfm>.

Intel E5-2600 Series Processor LRDIMM Memory Support												
Ranks Per DIMM & Data Width	Memory Capacity Per DIMM (See the Note Below)		Speed (MT/s) and Voltage Validated by Slot per Channel (SPC) and DIMM Per Channel (DPC)									
			2 Slots Per Channel				3 Slots Per Channel					
			1DPC		2DPC		1DPC		2DPC		3DPC	
			1.35V	1.5V	1.35V	1.5V	1.35V	1.5V	1.35V	1.5V	1.35V	1.5V
QRx4 (DDP)	16GB	32GB	1066	1066, 1333	1066	1066, 1333	1066	1066, 1333	1066	1066, 1333	1066	1066
QRx8 (QDP)	8GB	16GB	1066	1066, 1333	1066	1066, 1333	1066	1066	1066	1066	1066	1066

Note: For detailed information on memory support and updates, please refer to the SMC Recommended Memory List posted on our website at <http://www.supermicro.com/support/resources/mem.cfm>.

Other Important Notes and Restrictions

- For the memory modules to work properly, please install DIMM modules of the same type, same speed and same operating frequency on the motherboard. Mixing of RDIMMs, UDIMMs or LRDIMMs is not allowed. Do not install both ECC and Non-ECC memory modules on the same motherboard.
- Using DDR3 DIMMs with different operating frequencies is not allowed. All channels in a system will run at the lowest common frequency.

2-5 Motherboard Installation

All motherboards have standard mounting holes to fit different types of chassis. Make sure that the locations of all the mounting holes for both motherboard and chassis match. Although a chassis may have both plastic and metal mounting fasteners, metal ones are highly recommended because they ground the motherboard to the chassis. Make sure that the metal standoffs click in or are screwed in tightly. Then use a screwdriver to secure the motherboard onto the motherboard tray.

Tools Needed

- Phillips Screwdriver
- Pan head screws (10 pieces)
- Standoffs (10 pieces, if needed)

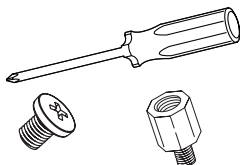

Location of Mounting Holes

There are ten (10) mounting holes on this motherboard indicated by the arrows.

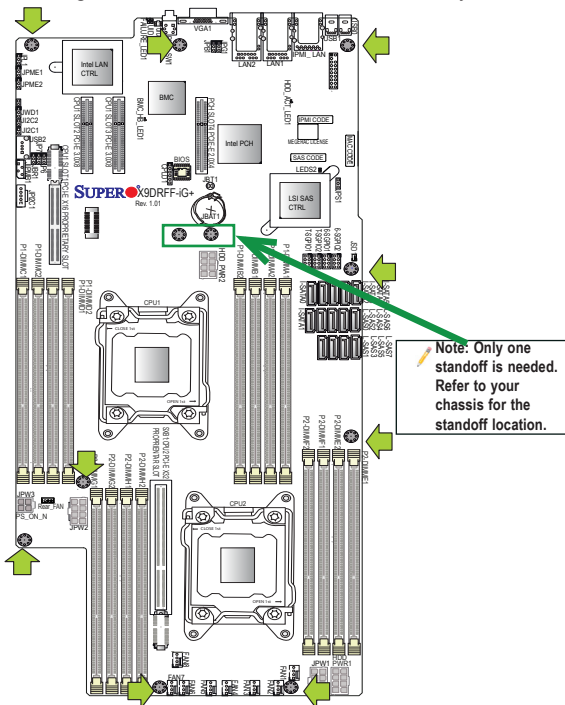

Caution: 1) To avoid damaging the motherboard and its components, please do not use a force greater than 8 lb/inch on each mounting screw during motherboard installation. 2) Some components are very close to the mounting holes. Please take precautionary measures to prevent damage to these components when installing the motherboard to the chassis.

Installing the Motherboard

1. Install the I/O shield into the chassis.
2. Locate the mounting holes on the motherboard.
3. Locate the matching mounting holes on the chassis. Align the mounting holes on the motherboard against the mounting holes on the chassis.
4. Install standoffs in the chassis as needed.

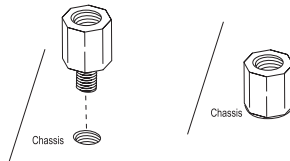

5. Install the motherboard into the chassis carefully to avoid damaging motherboard components.
6. Using the Phillips screwdriver, insert a Pan head #6 screw into a mounting hole on the motherboard and its matching mounting hole on the chassis.

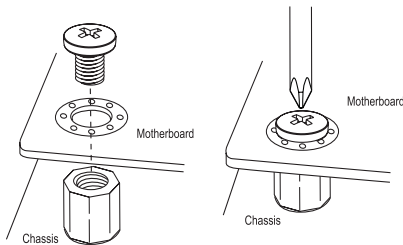

7. Repeat Step 5 to insert #6 screws into all mounting holes.
8. Make sure that the motherboard is securely placed in the chassis.

 **Note:** Images displayed are for illustration only. Your chassis or components might look different from those shown in this manual.

2-6 Control Panel Connectors and I/O Ports

The I/O ports are color coded in conformance with the PC 99 specification. See the picture below for the colors and locations of the various I/O ports.

Front Panel Connectors and I/O Ports

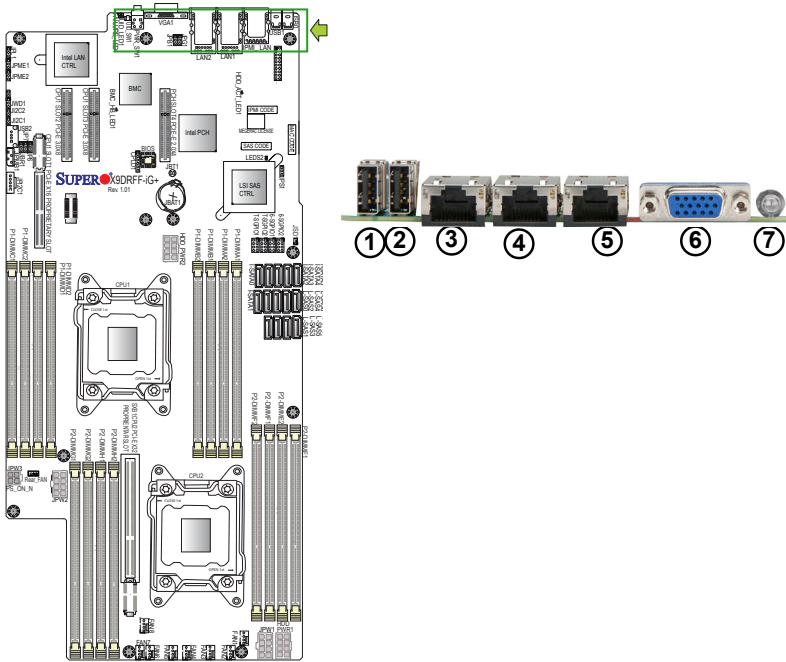

Front Panel I/O Port Locations and Definitions

X9DRFF-iG+/iTG+/7G+/7TG+ I/O Front Panel
1. Front Panel USB Port 1
2. Front Panel USB Port 2
3. IPMI LAN
4. 10-Gigabit LAN 1 (for X9DRFF-iTG+/-7TG+), 1-Gigabit LAN 1 (X9DRFF-iG+/-7G+)
5. 10-Gigabit LAN 2 (X9DRFF-iTG+/-7TG+), 1-Gigabit LAN 2 (X9DRFF-iG+/-7G+)
6. VGA
7. Power Switch (Button)

Universal Serial Bus (USB)

Two Universal Serial Bus ports (USB0, USB1), located on the I/O front panel, provide front-accessible USB support. In addition, a Type A USB connector (JUSB2), located next to the 4-pin JIPMB1 connector, also provides front-accessible USB support.

Front Panel USB 0/1 & Type A USB 2 Pin Definitions	
Pin#	Definition
1	+5V
2	PO-
3	PO+
4	Ground

Video Connection

A Video (VGA) port is located next to the LAN Port 2 on the I/O front panel. Refer to the layout below for the location.

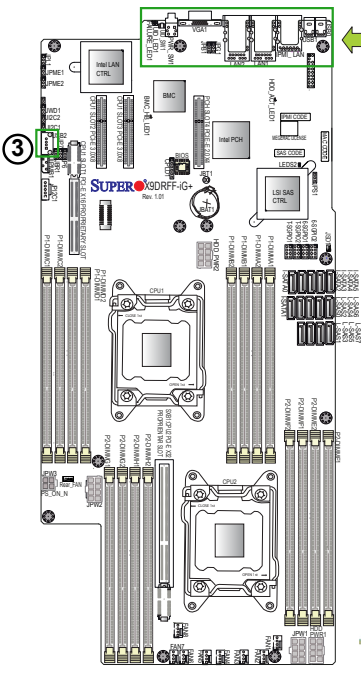

1. USB0
2. USB1
3. USB2
4. VGA

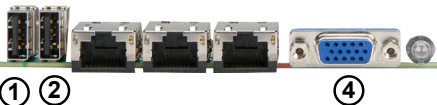

Ethernet Ports

Two Ethernet ports (LAN1, LAN2) are located on the I/O front panel. These Ethernet ports support 10G LAN connections on the X9DRFF-iTG+/7TG+, and 1G LAN connections on the X9DRFF-iG+/7G+. In addition, an IPMI LAN port is also located on the front panel. All these ports accept RJ45 cables. Please refer to the LED Indicator Section for LAN LED information.

LAN Ports Pin Definition			
Pin#	Definition		
1	P2V5SB	10	SGND
2	TD0+	11	Act LED
3	TD0-	12	P3V3SB
4	TD1+	13	Link 100 LED (Yellow, +3V3SB)
5	TD1-	14	Link 1000 LED (Yellow, +3V3SB)
6	TD2+	15	Ground
7	TD2-	16	Ground
8	TD3+	17	Ground
9	TD3-	18	Ground

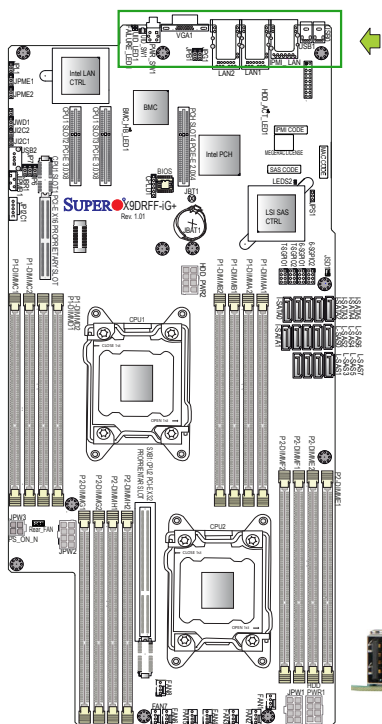

1. IPMI LAN
2. LAN1(10G LAN: X9DRFF-iTG+/7TG+, GLAN: X9DRFF-iG+/7G+)
3. LAN2 (10G LAN: X9DRFF-iTG+/7TG+, GLAN: X9DRFF-iG+/7G+)

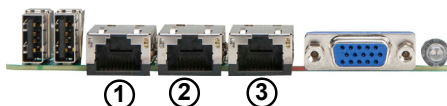

Power Button/Unit Identifier Switch

A Unit Identifier switch (SW1) and a UID LED Indicator are located on the motherboard. In addition, a power button (PWR_SW1) is located next to the UID switch on the front panel. When you press the UID switch, the UID LED Indicator will be turned on. Press the UID switch again to turn off the UID LED. The UID Indicator provides easy identification of a system unit that may be in need of service.

 **Note:** UID can also be triggered via IPMI on the motherboard. For more information on IPMI, please refer to the IPMI User's Guide posted on our website @ <http://www.supermicro.com>.

UID Switch	
Pin#	Definition
1	Ground
2	Ground
3	Button In
4	Ground

UID LED Status		
Color/State	OS	Status
Blue: On	Windows OS	Unit Identified
Blue: Blinking	Linux OS	Unit Identified

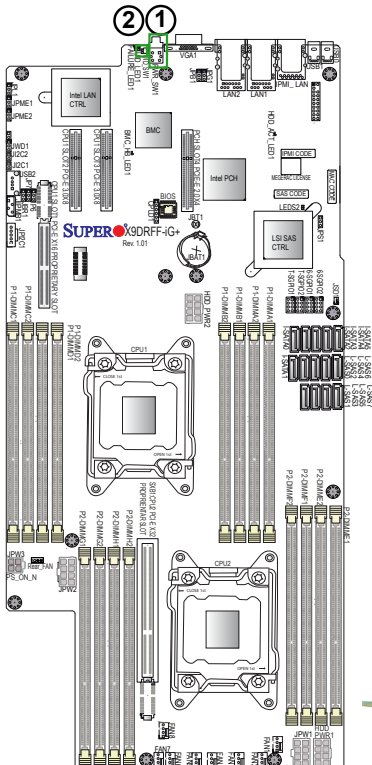

1. Power Button

2. UID Switch/UID LED (UID_LED1)

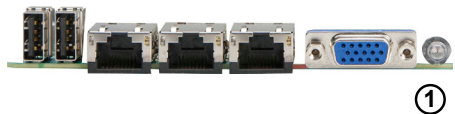

2-7 Connecting Cables

Two 8-pin power connectors (JPW1/JPW2) and a 4-pin power connector (JPW3) are located on the motherboard. In addition, two 8-pin power connectors (HDD_PWR1/2) are also located onboard to provide power supply from the motherboard to the HDD backplane for HDD device use. Do not use these connectors for other purposes. All power connectors mentioned above meet the SSI EPS 12V specification. See the tables on the right for pin definitions.

12V 8-pin PWR Pin Definitions	
Pins	Definition
1-4	Ground
5-8	+12V

12V 4-pin PWR Pin Definitions	
Pins	Definition
1	Ground
2	Ground
3	5V SB
4	PS_ON_N

HDD PWR Pin Definitions	
Pins	Definition
1-4	Ground
5-6	+12V
7-8	+5V

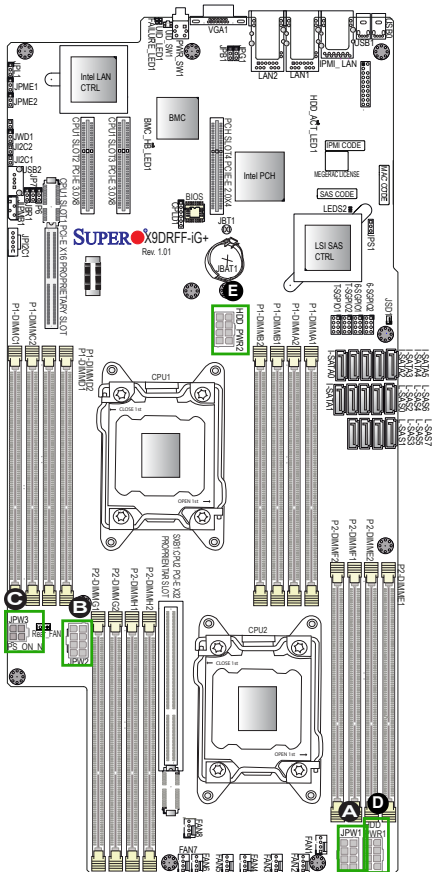

- (Required)
- A. [JPW1 \(8-pin Power Connector\)](#)
 - B. [JPW2 \(8-pin Power Connector\)](#)
 - C. [JPW3 \(4-pin Power Connector\)](#)
 - D. [HDD_PWR1 \(8-pin\)](#)
 - E. [HDD_PWR2 \(8-pin\)](#)

Fan Headers

This motherboard has eight 4-pin (FAN1~FAN8), and one 3-pin (Rear_FAN1) system/CPU/cooling fan headers on the motherboard. The 4-pin fan headers are backward compatible with the traditional 3-pin fans. However, fan speed control is only available on 4-pin fans via IPMI firmware management. See the table on the right for pin definitions.

Fan Header Pin Definitions	
Pin#	Definition
1	Ground
2	+12V
3	Tachometer
4	PWR Modulation (Available for 4-pin fans only)

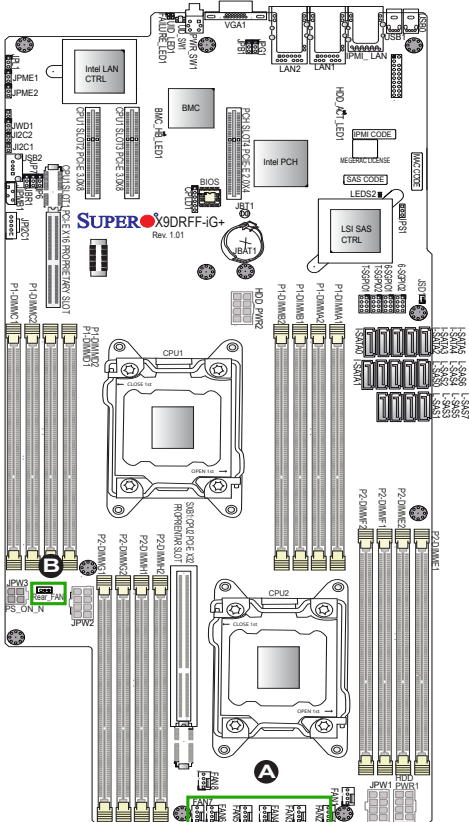

A. FAN1-FAN8

B. Rear_FAN 1

IPMB

A System Management Bus header for IPMI 2.0 is located at JIPMB1. Connect the appropriate cable here to use the IPMB I²C connection on your system.

IPMB Header Pin Definitions	
Pin#	Definition
1	Data
2	Ground
3	Clock
4	No Connection

SATA Device Power Connector

A power connector for SATA DOM (Disk_On_Module) devices is located at JSD1. Connect an appropriate cable here to provide power support for your SATA DOM devices.

DOM PWR Pin Definitions	
Pin#	Definition
1	+5V
2	Ground
3	Ground

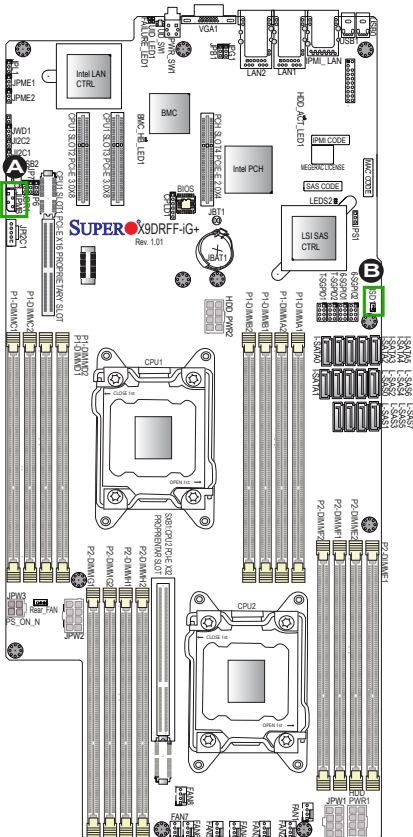

A. IPMB

B. DOM PWR

T-SGPIO 1/2 & 6-SGPIO 1/2 Headers

Four SGPIO (Serial-Link General Purpose Input/Output) headers (T-SGPIO 1/2 & 6-SGPIO 1/2) are located on the motherboard. These headers support onboard Serial_Link interface connections.



Note: T-SGPIO 1/2 support onboard SATA connections. 6-SGPIO 1/2 support SAS interface on the X9DRFF-7G+/7TG+.

T-SGPIO/6-SGPIO Pin Definitions			
Pin#	Definition	Pin	Definition
2	NC	1	NC
4	Ground	3	Data
6	Load	5	Ground
8	Clock	7	NC

Note: NC= No Connection

Power SMB (I²C) Connector

Power System Management Bus (I²C) Connector (JPI²C1) monitors power supply, fan and system temperatures. See the table on the right for pin definitions.

PWR SMB Pin Definitions	
Pin#	Definition
1	Clock
2	Data
3	PWR Fail
4	Ground
5	+3.3V

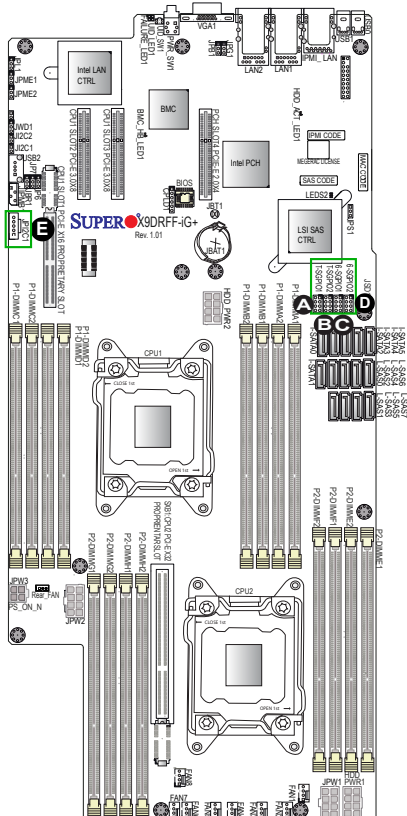

A. T-SGPIO1

B. T-SGPIO 2

C. 6-SGPIO 1

D. 6-SGPIO 2

E. JPI²C1

Power Switch

A Power switch is located next to the UID switch on the motherboard. Refer to the layout below for the location.

Unit Identification Switch/LED

A Unit Identifier switch (UID) and a UID LED indicator (UID_LED1) are located next to the power switch on the front panel. When the user pushes the UID switch, the UID LED (UID_LED1) will be turned on. Push the UID switch again to turn off the LED indicator. The UID switch provides easy identification of a system unit that may be in need of service. See the tables on the right for more information.

UID Switch (UID) Pin Definitions	
Pin#	Definition
1	Ground
2	Ground
3	Button In
4	Ground

A. PWR Switch

B. UID SW/LED

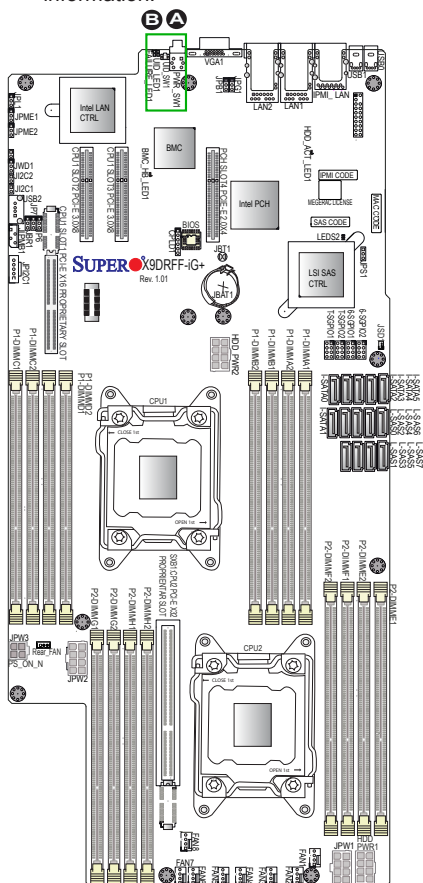

2-8 Jumper Settings

Explanation of Jumpers

To modify the operation of the motherboard, jumpers can be used to choose between optional settings. Jumpers create shorts between two pins to change the function of the connector. Pin 1 is identified with a square solder pad on the printed circuit board. See the motherboard layout pages for jumper locations.

 **Note:** On two-pin jumpers, "Closed" means the jumper is on and "Open" means the jumper is off the pins.

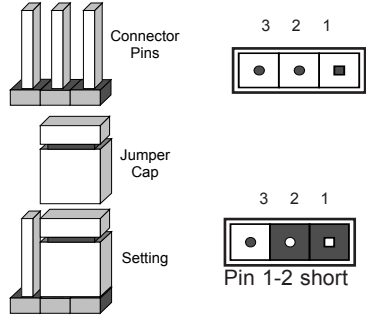

GLAN Enable/Disable

JPL1 enables or disables LAN Port1/LAN Port2 on the motherboard. See the table on the right for jumper settings. The default setting is Enabled.

LAN Enable Jumper Settings	
Jumper Setting Definition	
1-2	Enabled (default)
2-3	Disabled

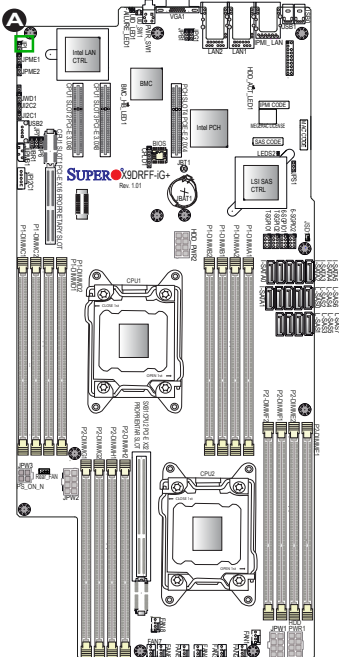

A. LAN1/2 Enable

CMOS Clear

JBT1 is used to clear CMOS. Instead of pins, this "jumper" consists of contact pads to prevent accidental clearing of CMOS. To clear CMOS, use a metal object such as a small screwdriver to touch both pads at the same time to short the connection. Always remove the AC power cord from the system before clearing CMOS. ⌚

 **Note 1:** For an ATX power supply, you must completely shut down the system, remove the AC power cord, and then short JBT1 to clear CMOS.

Note 2: Be sure to remove the onboard CMOS Battery before you short JBT1 to clear CMOS.

Note 3: Clearing CMOS will also clear all passwords.

Watch Dog Enable/Disable

Watch Dog (JWD1) is a system monitor that will reboot the system when a software application hangs. Close pins 1-2 to reset the system if an application hangs. Close pins 2-3 to generate a non-maskable interrupt signal for the application that hangs. See the table on the right for jumper settings. Watch Dog must also be enabled in the BIOS.

Watch Dog Jumper Settings	
Jumper Setting	Definition
Pins 1-2	Reset (default)
Pins 2-3	NMI
Open	Disabled

A. Clear CMOS

B. Watch Dog Enable

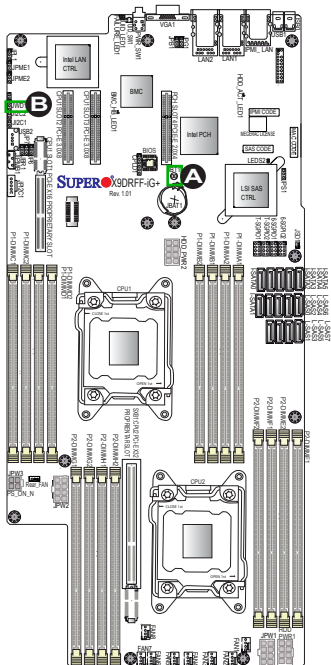

VGA Enable

Jumper JPG1 allows the user to enable onboard VGA support. The default setting is on Pins 1-2 to enable VGA support. See the table on the right for jumper settings.

VGA Enable Jumper Settings	
Jumper Setting	Definition
1-2	Enabled (Default)
2-3	Disabled

BMC Enable

Jumper JPB1 allows you to enable the embedded BMC (Baseboard Management Controller) to provide IPMI 2.0 support on the motherboard. See the table on the right for jumper settings.

BMC Enable Jumper Settings	
Jumper Setting	Definition
Pins 1-2	BMC Enable
Pins 2-3	Normal (Default)

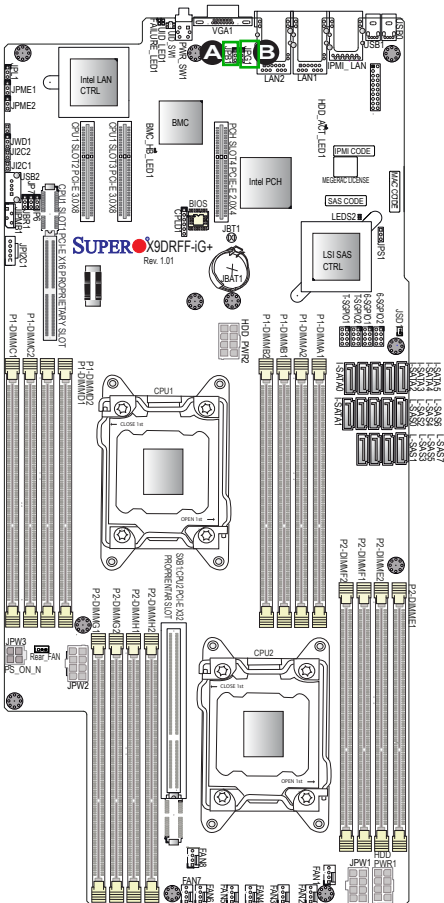

A. VGA Enabled

B. BMC Enabled

Management Engine (ME) Recovery

Use Jumper JPME1 to select ME Firmware Recovery mode, which will limit resource allocation for essential system operation only in order to maintain normal power operation and management. In the single operation mode, online upgrade will be available via Recovery mode. See the table on the right for jumper settings.

ME Recovery Jumper Settings	
Jumper Setting	Definition
1-2	Normal (Default)
2-3	ME Recovery

Manufacture Mode Select

Close Pin 2 and Pin 3 of Jumper JPME2 to bypass SPI flash security and force the system to operate in the Manufacture Mode, allowing the user to flash the system firmware from a host server for system setting modifications. See the table on the right for jumper settings.

ME Mode Select Jumper Settings	
Jumper Setting	Definition
1-2	Normal (Default)
2-3	Manufacture Mode

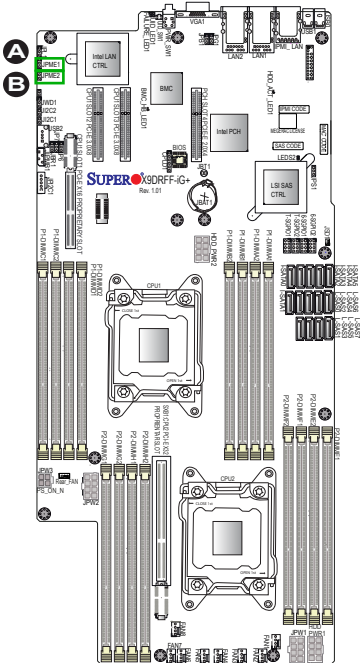

A. JPME1

B. JPME2

I²C Bus to PCI-Exp. Slots

Jumpers JI²C1 and JI²C2 allow you to connect the System Management Bus (I²C) to PCI-Express slots. The default setting is Open to disable the connection.

I ² C to PCI-Exp Jumper Settings	
Jumper Setting	Definition
Closed	Enabled
Open	Disabled (Default)

SAS Enable (For X9DRFF-7G+/7TG+)

Use Jumper JPS1 to enable onboard SAS support to enhance system performance. The default setting is enabled.

SAS Support Enable Jumper Settings	
Jumper Setting	Definition
Pins 1/2	SAS Enabled (Default)
Pins 2/3	SAS Disabled

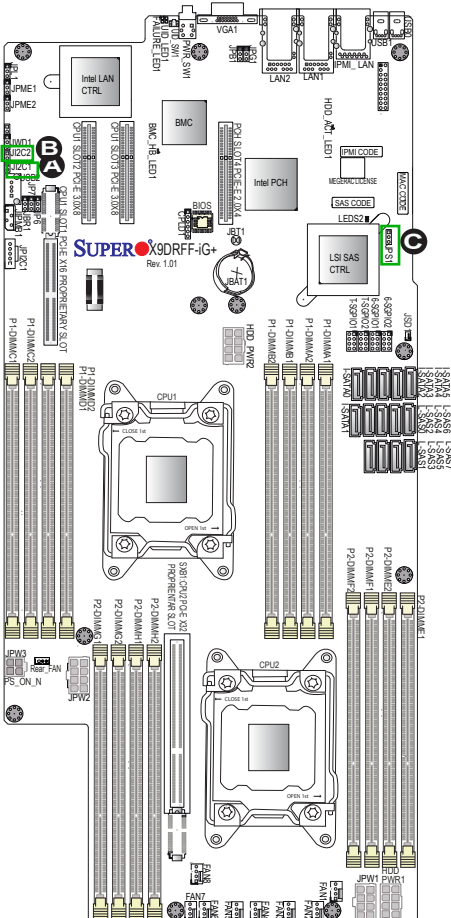

A. JI²C1

B. JI²C2

C. SAS Enable

2-9 Onboard LED Indicators

GLAN LEDs

There are two LAN ports (LAN1/2) on the motherboard. Each Ethernet LAN port has two LEDs. The Yellow LED on the right indicates connection and activity. The Link LED on the left side may be green, amber or off to indicate the speed of the connection. See the table on the right for more information.



Front View (when facing the front side of the chassis)

GLAN/TLAN Indicator (Right) LED Settings		
Color	Status	Definition
Off	No Connections	
Yellow	Flashing	Active

IPMI Dedicated LAN LEDs

In addition to LAN Ports 1/2, an IPMI Dedicated LAN is also located on the I/O front panel. The amber LED on the right indicates connection and activity.

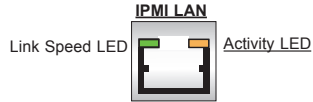

IPMI LAN Link Speed LED (Left) & Connection Activity LED (Right)		
LED	Color/State	Definition
Off	Off	No Connection
Activity	Amber: Blinking	Active
Speed	Green: Solid	100 Mbps

- A. LAN1/2 LEDs
- B. IPMI LAN LEDs

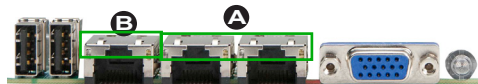
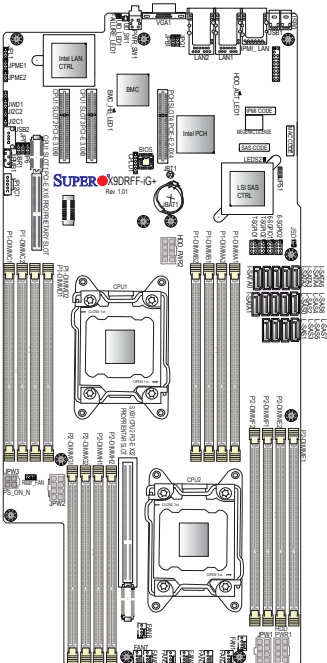

HDD Activity LED

An HDD Activity LED is located at HDD_ACT LED1 on the motherboard. When the HDD LED is blinking, an HDD device is active. See the table on the right for more information.

HDD Activity LED Status	
Color or State	Definition
Green: Blinking	HDD: Active
Off	HDD Disabled, or Failed

BMC Heartbeat LED

A BMC Heartbeat LED is located at BMC_HB_LED1 on the motherboard. When this LED indicator is blinking, BMC is normal. See the table on the right for more information.

BMC Heartbeat LED Status	
Color or State	Definition
Green	BMC: Normal
Off	BMC Disabled, or Failed

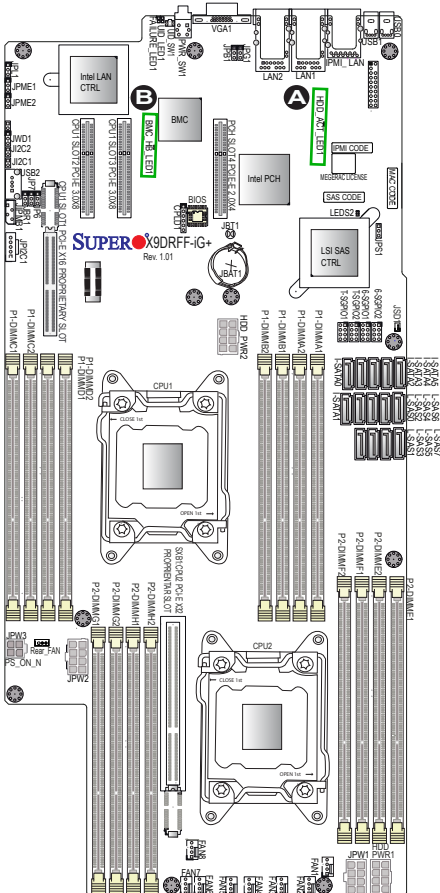

A. HDD_ACT LED1

B. BMC_HB_LED1

SAS Heartbeat LED

A SAS Heartbeat LED is located at LEDS2 on the motherboard. When LEDS2 is blinking, SAS is working properly.

SAS Heartbeat LED Status	
Color/State	Definition
Green: Blinking	SAS: Normal
Off or Red	SAS: Disabled or Failed

Failure LED

A Failure LED is located at Failure_LED1 on the motherboard. When Failure_LED1 is on, power failure has occurred. When it is blinking, it indicates a fan failure. See the table on the right for more information.

Failure LED Status	
State	Definition
On	PWR Failure
Blinking	Fan Failure

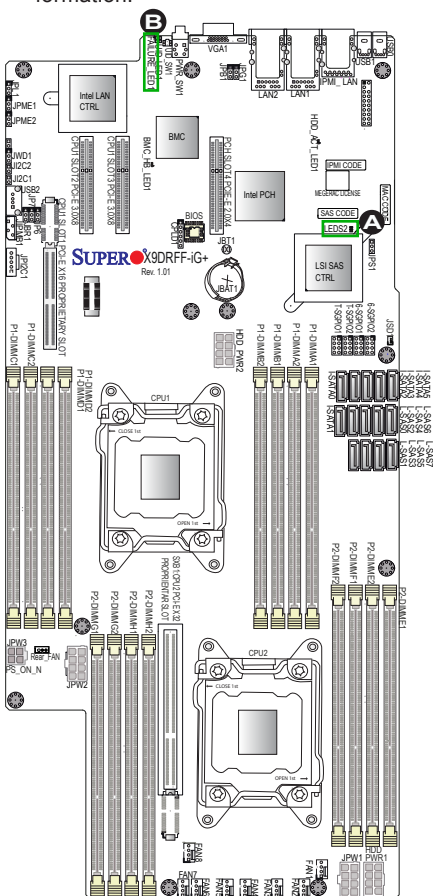

A. SAS Heartbeat LED

B. Failure LED

UID LED

The Unit Identifier (UID) LED is located at UID_LED1 on the motherboard. When this LED is on, the unit that might be in need of service is identified. See the table on the right for more information.

UID LED Status	
Color/State	Definition
Blue: On	Unit Identified

 **Note:** For information on the UID switch, refer to page 2-21.

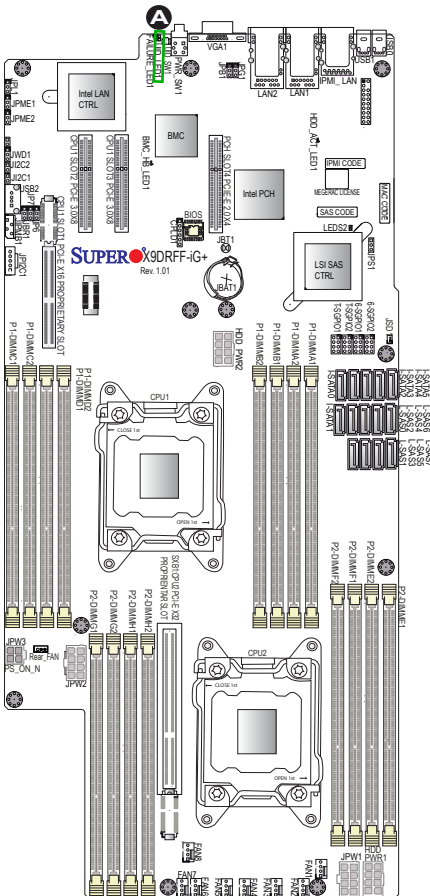

A. UID LED

2-10 SATA/SAS Connections

SATA/SAS Ports

Six Serial_ATA ports are located on the motherboard. I-SATA Ports 0/1 support SATA 3.0. I-SATA Ports 2-5 support SATA 2.0. In addition, eight SAS ports (L-SAS 0-7), supported by the LSI SAS 2308 Controller are also located on the X9DRFF-7G+/7TG+. See the table on the right for pin definitions.



Note: For more information on SATA HostRAID configuration, please refer to the Intel SATA and LSI SAS HostRAID User's Guides posted on our website @ <http://www.supermicro.com>.

SATA/SAS Pin Definitions	
Pin#	Definition
1	Ground
2	TX_P
3	TX_N
4	Ground
5	RX_N
6	RX_P
7	Ground

- A. I-SATA0 (SATA 3.0)
- B. I-SATA1 (SATA 3.0)
- C. I-SATA2-5 (SATA 2.0)
- D. L-SAS0-7 (X9DRFF-7G+/7TG+)

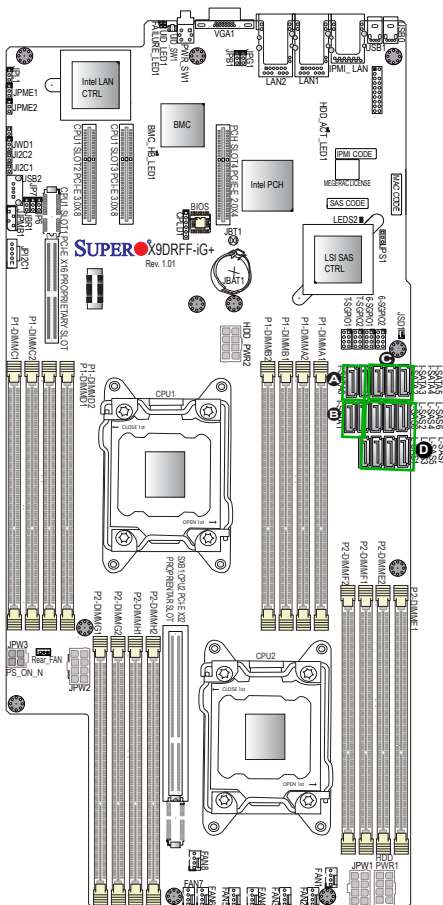

Chapter 3

Troubleshooting

3-1 Troubleshooting Procedures

Use the following procedures to troubleshoot your system. If you have followed all of the procedures below and still need assistance, refer to the 'Technical Support Procedures' and/or 'Returning Merchandise for Service' section(s) in this chapter.



Note: Always disconnect the power cord before adding, changing or installing any hardware components.

Before Power On

1. Make sure that there are no short circuits between the motherboard and chassis.
2. Disconnect all ribbon/wire cables from the motherboard, including those for the keyboard and mouse.
3. Remove all add-on cards.
4. Install CPU 1 first (making sure it is fully seated) and connect the front panel connectors to the motherboard.

No Power

1. Make sure that no short circuits between the motherboard and the chassis.
2. Make sure that the ATX power connectors are properly connected
3. Check that the 115V/230V switch on the power supply is properly set, if available.
4. Turn the power switch on and off to test the system, if applicable.
5. The battery on your motherboard may be old. Check to verify that it still supplies ~3VDC. If it does not, replace it with a new one.

Losing the System's Setup Configuration

1. Make sure that you are using a high quality power supply. A poor quality power supply may cause the system to lose the CMOS setup information. Refer to Section 2-7 for details on recommended power supplies.
2. The battery on your motherboard may be old. Check to verify that it still supplies ~3VDC. If it does not, replace it with a new one.
3. If the above steps do not fix the Setup Configuration problem, contact your vendor for repairs.

When the System Becomes Unstable

A. The system becomes unstable during or after the OS installation

The system becomes unstable during or after the OS installation, check the following:

1. CPU/BIOS support: Make sure that your CPU is supported, and you have the latest BIOS installed in your system.
2. Memory support: Make sure that the memory modules are supported by testing the modules using memtest86 or a similar utility.



Note: Refer to the product page on our website <http://www.supermicro.com> for memory and CPU support and updates.

3. HDD support: Make sure that all hard disk drives (HDDs) work properly. Replace the bad HDDs with good ones.
4. System cooling: Check system cooling to make sure that all heatsink fans, and CPU/system fans, etc., work properly. Check Hardware Monitoring settings in the BIOS to make sure that the CPU and System temperatures are within the normal range. Also check the front panel Overheat LED, and make sure that the Overheat LED is not on.
5. Adequate power supply: Make sure that the power supply provides adequate power to the system. Make sure that all power connectors are connected. Please refer to our website for more information on minimum power requirement.
6. Proper software support: Make sure that the correct drivers are used.

B. The system becomes unstable before or during the OS installation

When the system becomes unstable before or during OS installation, check the following:

1. Source of installation: Make sure that the devices used for installation are working properly, including boot devices such as CD/DVD disc, CD/DVD-ROM.
2. Cable connection: Check to make sure that all cables are connected and working properly.
3. Using minimum configuration for troubleshooting: Remove all unnecessary components (starting with add-on cards first), and use minimum configuration (with a CPU and one memory module installed) to identify the trouble areas. Refer to the steps listed in Section A above for proper troubleshooting procedures.
4. Identifying bad components by isolating them: If necessary, remove a component in question from the chassis, and test it in isolation to make sure that it works properly. Replace a bad component with a good one.
5. Check and change one component at a time instead of changing several items at the same time. This will help isolate and identify the problem.
6. To find out if a component is good, swap this component with a new one to see if the system will work properly. If so, then the old component is bad. You can also install the component in question in another system. If the new system works, the component is good and the old system has problems.

3-2 Technical Support Procedures

Before contacting Technical Support, please take the following steps. Also, please note that as a motherboard manufacturer, Supermicro also sells motherboards through its channels, so it is best to first check with your distributor or reseller for troubleshooting services. They should know of any possible problem(s) with the specific system configuration that was sold to you.

1. Please go through the 'Troubleshooting Procedures' and 'Frequently Asked Question' (FAQ) sections in this chapter or see the FAQs on our website (<http://www.supermicro.com/>) before contacting Technical Support.
2. BIOS upgrades can be downloaded from our website (<http://www.supermicro.com>).
3. If you still cannot resolve the problem, include the following information when contacting Supermicro for technical support:
 - Motherboard model and PCB revision number
 - BIOS release date/version (This can be seen on the initial display when your system first boots up.)
 - System configuration
 - An example of a Technical Support form is on our website at (<http://www.supermicro.com>).
 - Distributors: For immediate assistance, please have your account number ready when placing a call to our technical support department. We can be reached by e-mail at support@supermicro.com.

3-3 Battery Removal and Installation

Battery Removal

To remove the onboard battery, follow the steps below:

1. Power off your system and unplug your power cable.
2. Locate the onboard battery as shown below.
3. Using a tool such as a pen or a small screwdriver, push the battery lock outwards to unlock it. Once unlocked, the battery will pop out from the holder.
4. Remove the battery.

Proper Battery Disposal

Warning: Please handle used batteries carefully. Do not damage the battery in any way; a damaged battery may release hazardous materials into the environment. Do not discard a used battery in the garbage or a public landfill. Please comply with the regulations set up by your local hazardous waste management agency to dispose of your used battery properly.

Battery Installation

1. To install an onboard battery, follow the steps 1 & 2 above and continue below.
2. Identify the battery's polarity. The positive (+) side should be facing up.
3. Insert the battery into the battery holder and push it down until you hear a click to ensure that the battery is securely locked.

Warning: When replacing a battery, be sure to only replace it with the same type.

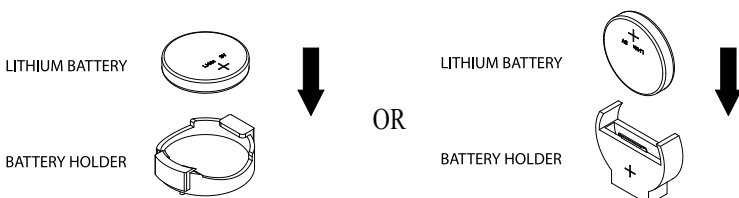

3-4 Frequently Asked Questions

Question: What are the various types of memory that my motherboard can support?

Answer: The motherboard supports Registered (RDIMM)/Load Reduced (LRDIMM) ECC or Unbuffered (UDIMM) ECC/Non-ECC DDR3 modules. To enhance memory performance, do not mix memory modules of different speeds, types, and sizes. Please follow all memory installation instructions given on Section 2-4 in Chapter 2.

Question: How do I update my BIOS?

It is recommended that you **do not** upgrade your BIOS if you are not experiencing any problems with your system. Updated BIOS files are located on our website at <http://www.supermicro.com>. Please check our BIOS warning message and the information on how to update your BIOS on our website. Select your motherboard model and download the BIOS file to your computer. Also, check the current BIOS revision to make sure that it is newer than your BIOS before downloading. You can choose from the zip file and the .exe file. If you choose the zip BIOS file, please unzip the BIOS file onto a bootable USB device. Run the batch file using the format AMI.bat filename.rom from your bootable USB device to flash the BIOS.

Warning: Do not shut down or reset the system while updating the BIOS to prevent possible system boot failure!



Note: The SPI BIOS chip used on this motherboard cannot be removed. Send your motherboard back to our RMA Department at Supermicro for repair. For BIOS Recovery instructions, please refer to the AMI BIOS Recovery Instructions posted at <http://www.supermicro.com>.

Question: How do I handle the used battery?

Answer: Please handle used batteries carefully. Do not damage the battery in any way; a damaged battery may release hazardous materials into the environment. Do not discard a used battery in the garbage or a public landfill. Please comply with the regulations set up by your local hazardous waste management agency to dispose of your used battery properly. Refer to Section 3-3.

3-5 Returning Merchandise for Service

A receipt or copy of your invoice marked with the date of purchase is required before any warranty service will be rendered. You can obtain service by calling your vendor for a Returned Merchandise Authorization (RMA) number. When returning the motherboard to the manufacturer, the RMA number should be prominently displayed on the outside of the shipping carton, and the shipping package is mailed prepaid or hand-carried. Shipping and handling charges will be applied for all orders that must be mailed when service is complete. For faster service, you can also request a RMA authorization online (<http://www.supermicro.com/RmaForm/>).

This warranty only covers normal consumer use and does not cover damages incurred in shipping or from failure due to the alternation, misuse, abuse or improper maintenance of products.

During the warranty period, contact your distributor first for any product problems.

Notes

Chapter 4

BIOS

4-1 Introduction

This chapter describes the AMI BIOS Setup utility for the X9DRFF-iG+/iTG+/7G+/7TG+. It also provides the instructions on how to navigate the AMI BIOS Setup utility screens. The AMI ROM BIOS is stored in a Flash EEPROM and can be easily updated.

Starting BIOS Setup Utility

To enter the AMI BIOS Setup utility screens, press the key while the system is booting up.

 **Note:** In most cases, the key is used to invoke the AMI BIOS setup screen. There are a few cases when other keys are used, such as <F3>, <F4>, etc.

Each main BIOS menu option is described in this manual. The Main BIOS setup menu screen has two main frames. The left frame displays all the options that can be configured. Grayed-out options cannot be configured. Options in blue can be configured by the user. The right frame displays the key legend. Above the key legend is an area reserved for informational text related to the option currently selected in the left frame.

 **Note:** The AMI BIOS has default informational messages built in. The manufacturer retains the option to include, omit, or change any of these informational messages.

The AMI BIOS Setup utility uses a key-based navigation system called "hot keys." Most of the AMI BIOS setup utility "hot keys" can be used at any time during setup navigation. These keys include <F3>, <F4>, <Enter>, <ESC>, arrow keys, etc.

 **Note 1:** In this section, options printed in **Bold** are default settings.

Note 2: <F3> is used to load optimal default settings. <F4> is used to save the settings and exit the setup utility.

How To Change the Configuration Data

The configuration data that determines the system parameters may be changed by entering the AMI BIOS Setup utility. This Setup utility can be accessed by pressing <Delete> at the appropriate time during system boot.

 **Note:** For AMI UEFI BIOS Recovery, please refer to the UEFI BIOS Recovery User Guide posted @<http://www.supermicro.com/support/manuals/>.

Starting the Setup Utility

Normally, the only visible Power-On Self-Test (POST) routine is the memory test. As the memory is being tested, press the <Delete> key to enter the main menu of the AMI BIOS Setup utility. From the main menu, you can access the other setup screens. An AMI BIOS identification string is displayed at the left bottom corner of the screen below the copyright message.

Warning: Do not upgrade the BIOS unless your system has a BIOS-related issue. Flashing the wrong BIOS can cause irreparable damage to the system. In no event shall the manufacturer be liable for direct, indirect, special, incidental, or consequential damage arising from a BIOS update. If you have to update the BIOS, do not shut down or reset the system while the BIOS is being updated to avoid possible boot failure.

4-2 Main Setup

When you first enter the AMI BIOS Setup utility, you will enter the Main setup screen. You can always return to the Main setup screen by selecting the Main tab on the top of the screen. The Main BIOS Setup screen is shown below.

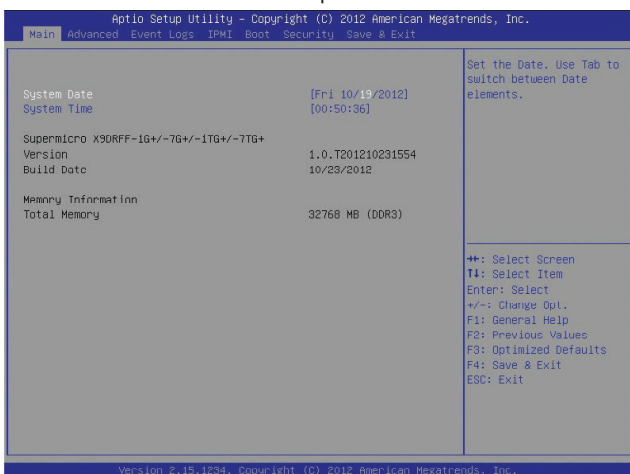

The AMI BIOS main menu displays the following information:

System Date

This item displays the system date in Day MM/DD/YY format (e.g. Sat 10/20/2012).

System Time

This item displays the system time in HH:MM:SS format (e.g. 15:32:52).

Supermicro X9DRFF-iG+/iTG+/7G+/7TG+**Version**

This item displays the SMC version of the BIOS ROM used in this system.

Build Date

This item displays the date that the BIOS ROM was built.

Memory Information**Total Memory**

This displays the amount of memory available in the system.

4-3 Advanced Setup Configurations

Use the arrow keys to select the Advanced Setup submenu and press <Enter> to access the following items.

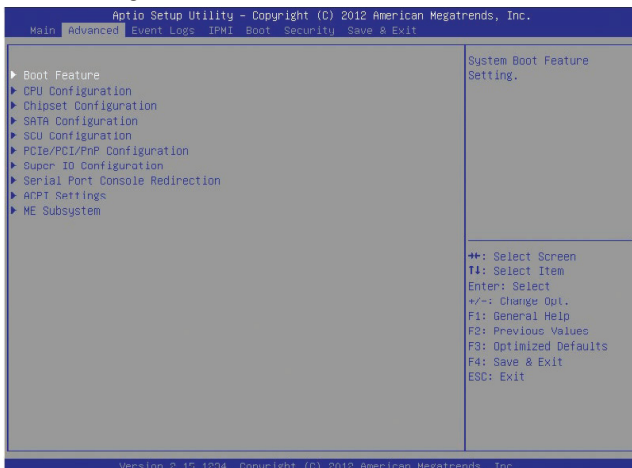

Boot Feature

Quiet Boot

Use this item to select bootup screen display between POST messages and the OEM logo. Select Disabled to display the POST messages. Select Enabled to display the OEM logo instead of the normal POST messages. The options are **Enabled** and Disabled.

AddOn ROM Display Mode

Use this item to set the AddOn Option ROM display mode. Select Keep Current to use the current Option ROM display mode. Select Force BIOS to use the Option ROM display mode set by the system BIOS. The options are **Force BIOS** and Keep Current.

Bootup Num-Lock

Use this feature to set the Power-on state for the Num Lock key on the keyboard. The options are Off and **On**.

Wait For 'F1' If Error

Select Enabled to force the system to wait until the 'F1' key is pressed if an error occurs. The options are Disabled and **Enabled**.

Interrupt 19 Capture

Interrupt 19 is the software interrupt that handles the boot disk function. When this item is set to Enabled, the ROM BIOS of the host adaptors will "capture" Interrupt 19 at bootup and allow the drives that are attached to these host adaptors to function as bootable disks. If this item is set to Disabled, the ROM BIOS of the host adaptors will not capture Interrupt 19, and the drives attached to these adaptors will not function as bootable devices. The options are **Enabled** and Disabled.

Re-try Boot

When the feature is set to Enabled, the BIOS will continuously retry to boot from the selected boot type. The options are **Disabled**, Legacy Boot, and EFI Boot.

Power Configuration

Watch Dog Function

If enabled, the Watch Dog timer will set the system to automatically reboot when a non-recoverable error occurs, and this error lasts for more than five minutes. The options are Enabled and **Disabled**.

Power Button Function

If this feature is set to Instant Off, the system will power off immediately as soon as the user presses the power button. If this feature is set to 4 Seconds Override, the system will power off when the user presses the power button for 4 seconds or longer. The options are **Instant Off** and 4 Seconds Override.

Restore on AC Power Loss

Use this feature to set the power state after a power outage. Select Stay Off for the system power to remain off after a power loss. Select Power On for the system power to be turned on after a power loss. Select Last State to allow the system to resume its last state before a power loss. The options are Power On, Stay Off, and **Last State**.

CPU Configuration

This submenu displays CPU information as detected by the BIOS. It also allows the user to configure CPU settings.

►Socket 1 CPU Information, Socket 2 CPU Information

This submenu displays the following information on the CPUs installed in Socket 1 and Socket 2.

- Type of CPU
- CPU Signature
- Microcode Patch
- CPU Stepping
- Maximum CPU Speed
- Minimum CPU Speed
- Processor Cores
- Intel HT (Hyper-Threading) Technology
- Intel VT-x Technology
- Intel SMX Technology
- L1 Data Cache
- L1 Code Cache
- L2 Cache
- L3 Cache

CPU Speed

This item displays the speed of the CPU installed in the Socket specified.

64-bit

This item indicates if 64-bit technology is supported by the CPU installed in the Socket selected.

Clock Spread Spectrum

Select Enable to enable Clock Spectrum support, which will allow the BIOS to monitor and attempt to reduce Electromagnetic Interference level caused by the components whenever needed. The options are **Disabled** and Enabled.

RTID (Record Types IDs)

This feature displays the total number of Record Type IDs for local and remote pools. The options are **Optimal** and Alternate.

Hyper-threading

Select Enabled to support Intel Hyper-threading Technology to enhance CPU performance. The options are **Enabled** and Disabled.

Active Processor Cores

Set to Enabled to use the processor's second core and above. (Please refer to Intel's website for more information.) The options are **All**, 1, 2, 4, and 6.

Limit CPUID Maximum

Use this feature to set the maximum CPU ID value. Enable this function to boot legacy operating systems that do not support processors with extended CPUID functions. The options are Enabled and **Disabled** (for the Windows OS).

Execute Disable Bit (Available if supported by the OS & the CPU)

Select Enabled to enable the Execute Disable Bit which will allow the processor to designate areas in the system memory where an application code can execute and where it cannot, thus preventing a worm or a virus from flooding illegal codes to overwhelm the processor or damage the system during an attack. The default is **Enabled**. (Refer to Intel and Microsoft Web sites for more information.)

Intel® AES-NI

Select Enable to use the Intel Advanced Encryption Standard (AES) New Instructions (NI) to ensure data security. The options are **Enabled** and Disabled.

MLC Streamer Prefetcher (Available when supported by the CPU)

If set to Enabled, the MLC (Mid-Level Cache) streamer prefetcher will prefetch streams of data and instructions from the main memory to the L2 cache in the CPU to improve CPU performance. The options are Disabled and **Enabled**.

MLC Spatial Prefetcher (Available when supported by the CPU)

If this feature is set to Disabled, the MLC spatial prefetcher will prefetch the cache line for 64 bytes. If this feature is set to Enabled, the MLC spatial prefetcher will prefetch both cache lines for 128 bytes as comprised. The options are Disabled and **Enabled**.

DCU Streamer Prefetcher (Available when supported by the CPU)

If this item is set to Enabled, the Data Cache Unit (DCU) streamer prefetcher will prefetch L1 data to speed up data accessing and processing to enhance CPU performance. The options are Disabled and **Enabled**.

DCU IP Prefetcher

Select Enabled for DCU (Data Cache Unit) IP Prefetcher support, which will prefetch IP addresses to improve network connectivity and system performance. The options are **Enabled** and Disabled.

Intel® Virtualization Technology (Available when supported by the CPU)

Select Enabled for Intel Virtualization Technology support, which will allow one platform to run multiple operating systems and applications in independent partitions, creating multiple "virtual" systems in one physical computer. The options are **Enabled** and Disabled.



Note: If there is any change to this setting, you will need to power off and restart the system for the change to take effect. Please refer to Intel's website for detailed information.)

► CPU Power Management Configuration

This submenu allows the user to configure the following CPU Power Management settings.

Power Technology

Select Energy Efficiency to support power-saving mode. Select Custom to customize system power settings. Select Disabled to disable power-saving settings. The options are Disabled, **Energy Efficient**, and Custom. If the option is set to Custom, the following items will display:

EIST (Available when Power Technology is set to Custom)

EIST (Enhanced Intel SpeedStep Technology) allows the system to automatically adjust processor voltage and core frequency to reduce power consumption and heat dissipation. The options are Disabled and **Enabled**.

C1E Support (Available when Power Technology is set to Custom)

Select Enabled to enable Enhanced C1 Power State to boost system performance. The options are **Enabled** and Disabled.

CPU C3 Report (Available when Power Technology is set to Custom)

Select Enabled to allow the BIOS to report the CPU C3 State (ACPI C2) to the operating system. During the CPU C3 State, the CPU clock generator is turned off. The options are Enabled and **Disabled**.

CPU C6 Report (Available when Power Technology is set to Custom)

Select Enabled to allow the BIOS to report the CPU C6 State (ACPI C3) to the operating system. During the CPU C6 State, the power to all cache is turned off. The options are **Enabled** and Disabled.

CPU C7 Report (Available when Power Technology is set to Custom)

Select Enabled to allow the BIOS to report the CPU C7 State (ACPI C3) to the operating system. CPU C7 State is a processor-specific low C-State. The options are **Enabled** and Disabled.

Package C-State limit (Available when Power Technology is set to Custom)

Use this feature to set the limit on the C-State package register. The options are C0, C2, **C6**, and No Limit.

Energy Performance Bias

Use this feature to select an appropriate fan setting to maximize system performance (with maximum cooling) or to maximize energy efficiency with maximum power saving). The fan speeds are controlled by firmware management via IPMI 2.0. The options are Performance, **Balanced Performance**, Balanced Energy, and Energy Efficient.

Factory Long Duration Power Limit

This item displays the power limit (in watts) set by the manufacturer during which long duration power is maintained.

Long Duration Power Limit

This item displays the power limit (in watts) set by the user during which long duration power is maintained. The default setting is **0**.

Factory Long Duration Maintained

This item displays the period of time (in seconds) set by the manufacturer during which long duration power is maintained.

Long Duration Maintained

This item displays the period of time (in seconds) during which long duration power is maintained. The default setting is **0**.

Recommended Short Duration Power Limit

This item displays the short duration power settings (in watts) recommended by the manufacturer.

Short Duration Power Limit

This item displays the time period during which short duration power (in watts) is maintained. The default setting is **0**.

► Chipset Configuration

► North Bridge

This feature allows the user to configure the settings for the Intel North Bridge.

► Integrated IO Configuration

Intel® VT-d

Select **Enabled** to enable Intel Virtualization Technology support for Direct I/O VT-d by reporting the I/O device assignments to the VMM (Virtual Machine Monitor) through the DMAR ACPI tables. This feature offers fully-protected I/O -resource sharing across Intel platforms, providing greater reliability, security and availability in networking and data-sharing. The options are **Enabled** and **Disabled**.

Aging Timer Rollover

Use this feature to configure Aging Timer Rollover settings. Select **Default** to allow the BIOS to configure Aging Timer Rollover settings. The options are **Default**, **Disabled**, **32us**, **128 us** and **512 us**.

Intel® I/OAT

Select **Enabled** to enable Intel I/OAT (I/O Acceleration Technology), which significantly reduces CPU overhead by leveraging CPU architectural demands, freeing up the system resource for other tasks. The options are **Disabled** and **Enabled**.

DCA Support

Select **Enabled** to use Intel's DCA (Direct Cache Access) Technology to improve data transfer efficiency. The default setting is **Enabled**.

MMCFG BASE

This feature determines the lowest base address that can be assigned to PCI devices. The lower the address, the less system memory is available (for 32-bit OS). The higher the address, the less resources are allocated to PCI devices. The options are **0x80000000**, **0xA0000000**, and **0xC0000000**.

IIO 1 PCIe Port Bifurcation Control

This submenu configures the following IO PCIe Port Bifurcation Control settings for the PCIe ports. It also determines how the available PCI-Express lanes are distributed between the PCI-Exp. Root ports.

CPU 1 Slot J1 PCI-E 3.0 x16 Link Speed

Select GEN1 to enable PCI-Exp Generation 1 support for Slot J1. Select GEN2 to enable PCI-Exp Generation 2 support for Slot J1. Select GEN3 to enable PCI-Exp Generation 3 support for Slot J1. The options are GEN1, GEN2, and **GEN3**.

CPU 1 Slot J2 PCI-E 3.0 x8 Link Speed

Select GEN1 to enable PCI-Exp Generation 1 support for Slot J2. Select GEN2 to enable PCI-Exp Generation 2 support for Slot J2. Select GEN3 to enable PCI-Exp Generation 3 support for Slot J2. The options are GEN1, GEN2, and **GEN3**.

CPU 1 Slot J3 PCI-E 3.0 x8 Link Speed

Select GEN1 to enable PCI-Exp Generation 1 support for Slot J3. Select GEN2 to enable PCI-Exp Generation 2 support for Slot J3. Select GEN3 to enable PCI-Exp Generation 3 support for Slot J3. The options are GEN1, GEN2, and **GEN3**.

IIO 2 PCIe Port Bifurcation Control

This submenu configures the following IO PCIe Port Bifurcation Control settings for the PCIe ports. It also determines how the available PCI-Express lanes are distributed between the PCI-Exp. Root Ports.

CPU 2 Slot SXB1A PCI-E 3.0 x16 Link Speed

Select GEN1 to enable PCI-Exp Generation 1 support for Slot SXB1A. Select GEN2 to enable PCI-Exp Generation 2 support for Slot SXB1A. Select GEN3 to enable PCI-Exp Generation 3 support for Slot SXB1A. The options are GEN1, GEN2, and **GEN3**.

CPU 2 Slot SXB1B PCI-E 3.0 x16 Link Speed

Select GEN1 to enable PCI-Exp Generation 1 support for Slot SXB1B. Select GEN2 to enable PCI-Exp Generation 2 support for Slot SXB1B. Select GEN3 to enable PCI-Exp Generation 3 support for Slot SXB1B. The options are GEN1, GEN2, and **GEN3**.

►QPI Configuration

Current QPI Link Speed

This item displays the current speed of the QPI Link.

Current QPI Link Frequency

This item displays the frequency of the QPI Link.

Isoc

Select Enabled to enable Isochronous support to meet QoS (Quality of Service) requirements. This feature is especially important for virtualization technology. The options are Enabled and **Disabled**.

QPI (Quick Path Interconnect) Link Speed Mode

Use this feature to select data transfer speed for QPI Link connections. The options are **Fast** and Slow.

QPI Link Frequency Select

Use this feature to select the desired QPI frequency. The options are **Auto**, 6.4 GT/s, 7.2 GT/s, and 8.0 GT/s.

►DIMM Configuration

This section displays the following DIMM information.

Current Memory Mode

This item displays the current memory mode.

Current Memory Speed

This item displays the current memory speed.

Mirroring

This item displays if memory mirroring is supported by the motherboard. Memory mirroring creates a duplicate copy of the data stored in the memory to enhance data security.

Sparing

This item displays if memory sparing is supported by the motherboard. Memory sparing enhances system performance.

►DIMM Information

The submenu displays the status of a DIMM module detected by the BIOS.

CPU Socket 1 DIMM Information/CPU Socket 2 DIMM Information

Memory Mode

When Independent is selected, all DIMMs are available to the operating system. When Mirroring is selected, the motherboard maintains two identical copies of all

data in memory for data backup. When Lockstep is selected, the motherboard uses two areas of memory to run the same set of operations in parallel. The options are **Independent**, Mirroring, and Lockstep.

DRAM RAPL Mode

RAPL (Running Average Power Limit) provides mechanisms to enforce power consumption limits on supported processors. The options are DRAM RAPL MODE0, **DRAM RAPL MODE1**, and Disabled.

DDR Speed

Use this feature to force a DDR3 memory module to run at a frequency other than what is specified by the manufacturer. The options are **Auto**, Force DDR3-800, Force DDR3-1066, Force DDR3-1333, Force DDR3-1600 and Force SPD.

Channel Interleaving

This feature selects from the different channel interleaving methods. The options are **Auto**, 1 Way, 2 Way, 3, Way, and 4 Way.

Rank Interleaving

This feature allows the user to select a rank memory interleaving method. The options are **Auto**, 1 Way, 2 Way, 4, Way, and 8 Way.

Patrol Scrub

Patrol Scrubbing is a process that allows the CPU to correct correctable memory errors detected on a memory module and send the correction to the requestor (the original source). When this item is set to Enabled, the IO hub will read and write back one cache line every 16K cycles if there is no delay caused by internal processing. By using this method, roughly 64 GB of memory behind the IO hub will be scrubbed every day. The options are **Enabled** and Disabled.

Demand Scrub

Demand Scrubbing is a process that allows the CPU to correct correctable memory errors found on a memory module. When the CPU or I/O issues a demand-read command, and the read data from memory turns out to be a correctable error, the error is corrected and sent to the requestor (the original source). Memory is updated as well. Select Enabled to use Demand Scrubbing for ECC memory correction. The options are Enabled and **Disabled**.

Data Scrambling

Select Enabled to enable data scrambling to ensure data security and integrity. The options are Disabled and **Enabled**.

Device Tagging

Select Enabled to support device tagging. The options are **Disabled** and Enabled.

Thermal Throttling

Throttling improves CPU reliability and reduces power consumption via automatic voltage control during processor idle states. The options are Disabled and **CLTT** (Closed Loop Thermal Throttling).

► South Bridge Configuration

This feature displays PCH information and allows the user to configure PCH settings.

PCH Information

The following PCH information will be displayed.

- Name: This item displays the name of the PCH chip.
- Stepping: This item displays the PCH stepping.
- USB Devices: This item displays the USB devices detected by the BIOS.

All USB Devices

Select Enabled to enable all USB ports/devices. The options are Disabled and **Enabled**.

EHCI Controller 1/EHCI Controller 2 (Available when All USB Devices is set to Enabled)

Select Enabled to enable EHCI (Enhanced Host Controller Interface) Controller 1 or Controller 2. The options are Disabled and **Enabled**.

Legacy USB Support (Available when USB Functions is not Disabled)

Select Enabled to support legacy USB devices. Select Auto to disable legacy support if USB devices are not present. Select Disabled to have USB devices available for EFI (Extensive Firmware Interface) applications only. The settings are Disabled, **Enabled** and Auto.

Port 60/64 Emulation

Select Enabled to enable I/O port 60h/64h emulation support for the legacy USB keyboard so that it can be fully supported by the operating systems that does not recognize a USB device. The options are Disabled and **Enabled**.

EHCI Hand-Off

This item is for operating systems that do not support Enhanced Host Controller Interface (EHCI) hand-off. When this feature is enabled, EHCI ownership will be changed by the EHCI driver. The options are **Disabled** and Enabled.

► SATA Configuration

When this submenu is selected, the AMI BIOS automatically detects the presence of IDE or SATA devices and displays the following items.

SATA Port0~SATA Port5: The AMI BIOS displays the status of each SATA port as detected by the BIOS.

SATA Mode

Use this feature to configure SATA mode for a selected SATA port. The options are Disabled, IDE Mode, **AHCI Mode** and RAID Mode. The following are displayed depending on your selection:

IDE Mode

The following items are displayed when IDE Mode is selected:

Serial-ATA (SATA) Controller 0~1

Use this feature to activate or deactivate the SATA controller, and set the compatibility mode. The options are Disabled, Enhanced, and Compatible. The default for SATA Controller 0 is **Compatible**. The default of SATA Controller 1 is **Enhanced**.

AHCI Mode

The following items are displayed when the AHCI Mode is selected.

Aggressive Link Power Management

When Enabled, the SATA AHCI controller manages the power usage of the components installed on the SATA link. The controller will put the link in a low power mode during extended periods of I/O inactivity, and will return the link to an active state when I/O activity resumes. The options are **Enabled** and Disabled.

Port 0~5 Hot Plug

Select Enabled to enable hot-plug support for a particular port, which will allow the user to change a hardware component or device without shutting down the system. The options are **Enabled** and Disabled.

Port 0~5 Staggered Spin-Up

Select Enabled to enable Staggered Spin-up support to prevent excessive power consumption caused by multiple HDDs spinning-up simultaneously. The options are Enabled and **Disabled**.

RAID Mode

The following items are displayed when RAID Mode is selected:

SATA RAID Option ROM/UEFI Driver

Use this feature to enable the onboard SATA Option ROM or EFI driver. The options are Enabled and Disabled.

Port 0~5 Hot Plug

Select Enabled to enable hot-plug support for the particular port. The options are Disabled and **Enabled**.

► PCIe/PCI/PnP Configuration

Launch Storage Add-on Card OpROM Priority

Use this feature to select the Option ROM you want to use to boot the system when there are multiple Option ROMs available in the system. The options are UEFI only and **Legacy only**.

PCI Latency Timer

Use this feature to set the latency timer of each PCI device installed on a PCI bus. Select 64 to set the PCI latency to 64 PCI clock cycles. The options are 32, **64**, 96, 128, 160, 192, 224 and 248.

PERR# Generation

Select Enabled to allow a PCI device to generate a PERR number for a PCI Bus Signal Error Event. The options are Enabled and **Disabled**.

SERR# Generation

Select Enabled to allow a PCI device to generate an SERR number for a PCI Bus Signal Error Event. The options are Enabled and **Disabled**.

Maximum Payload

Select Auto to allow the system BIOS to automatically set the maximum payload value for a PCI-E device to enhance system performance. The options are **Auto**, 128 Bytes and 256 Bytes, 512 Bytes, 1024 Bytes, 2048 Bytes, and 4096 Bytes.

Maximum Read Request

Select Auto to allow the system BIOS to automatically set the maximum Read Request size for a PCI-E device to enhance system performance. The options are **Auto**, 128 Bytes, 256 Bytes, 512 Bytes, 1024 Bytes, 2048 Bytes, and 4096 Bytes.

ASPM Support

Use this feature to set the Active State Power Management (ASPM) level for a PCI-E device. Select Auto to allow the system BIOS to automatically set the ASPM level for the system. Select Disabled to disable ASPM support. The options are **Disabled**, and Auto.

Warning: Enabling ASPM support may cause some PCI-E devices to fail!

Above 4G Decoding (Available if the system supports 64-bit PCI decoding)

Select Enabled to decode a PCI device that supports 64-bit in the space above 4G Address. The options are Enabled and **Disabled**.

CPU1 Slot J1 PCI-E 3.0 x16 OPROM

Select Enabled to enable Option ROM support to boot the computer using a device installed on the slot specified above. The options are **Enabled** and Disabled.

CPU1 Slot J2/Slot J3 PCI-E 3.0 x8 OPROM

Select Enabled to enable Option ROM support to boot the computer using a device installed on the slot specified above. The options are **Enabled** and Disabled.

PCH Slot J4 PCI-E 2.0 x4 OPROM

Select Enabled to enable Option ROM support to boot the computer using a device installed on the slot specified above. The options are **Enabled** and Disabled.

CPU2 Slot SXB1A/Slot SXB1B PCI-E 3.0 x16 OPROM

Select Enabled to enable Option ROM support to boot the computer using a device installed on the slot specified above. The options are **Enabled** and Disabled.

Onboard LAN Option ROM Select

Select iSCSI to use the iSCSI Option ROM to boot the computer using a network device. Select PXE (Preboot Execution Environment) to use an PXE Option ROM to boot the computer using a network device. The options are **PXE**, iSCSI and FCoE.

Load Onboard LAN1 Option ROM/Load Onboard LAN2 Option ROM

Select Enabled to enable the onboard LAN1 or LAN2 Option ROM. This is to boot the computer using a network device. The default setting for LAN1 Option ROM is **Enabled**, and for LAN2 Option ROM is **Disabled**.

Load Onboard SAS OPROM

Select Enabled for onboard SAS Option ROM support. This is to boot the computer using a SAS device. The options are Disabled and **Enabled**.

VGA Priority

This feature allows the user to select the graphics adapter to be used as the primary boot device. The options are **Onboard**, and Offboard.

Network Stack

Select Enabled enable PXE (Preboot Execution Environment) or UEFI (Unified Extensible Firmware Interface) for network stack support. The options are Enabled and **Disabled**.

IPv4 PXE Support (Available when Network Stack is set to Enabled)

Set this item to Enabled to activate IPv4 PXE Support. The options are **Enabled** and Disabled.

IPv6 PXE Support (Available when Network Stack is set to Enabled)

Set this item to Enabled to activate IPv6 PXE Support. The options are Enabled and **Disabled**.

► Serial Port Console Redirection

COM 1/SOL

These two submenus allow the user to configure the following Console Redirection settings for a COM port specified by the user.

COM1/SOL (Serial Over LAN) Console Redirection

Select Enabled to use COM1 or SOL (Serial_Over_LAN) port selected by the user for Console Redirection. The options are Enabled and Disabled. The default setting for COM1 is **Disabled**, and for SOL is **Enabled**.

► Console Redirection Settings

Use this feature to specify how the host computer will communicate with the client computer, which is the remote computer used by the user.

Terminal Type

This feature allows the user to select the target terminal emulation type for Console Redirection. Select VT100 to use the ASCII Character set. Select VT100+ to add color and function key support. Select ANSI to use the Extended ASCII Char-

acter Set. Select VT-UTF8 to use UTF8 encoding to map Unicode characters into one or more bytes. The options are ANSI, VT100, **VT100+**, and VT-UTF8.

Bits Per second

Use this feature to set the transmission speed for a serial port used in Console Redirection. Make sure that the same speed is used in the host computer and the client computer. A lower transmission speed may be required for long and busy lines. The options are 9600, 19200, 38400, 57600 and **115200** (bits per second).

Data Bits

Use this feature to set the data transmission size for Console Redirection. The options are 7 Bits and **8 Bits**.

Parity

A parity bit can be sent along with regular data bits to detect data transmission errors. Select Even if the parity bit is set to 0, and the number of 1's in data bits is even. Select Odd if the parity bit is set to 0, and the number of 1's in data bits is odd. Select None if you do not want to send a parity bit with your data bits in transmission. Select Mark to add a mark as a parity bit to be sent along with the data bits. Select Space to add a Space as a parity bit to be sent with your data bits. The options are **None**, Even, Odd, Mark and Space.

Stop Bits

A stop bit indicates the end of a serial data packet. Select 1 Stop Bit for standard serial data communication. Select 2 Stop Bits if slower devices are used. The options are **1** and 2.

Flow Control

Use this feature to set the flow control for Console Redirection to prevent data loss caused by buffer overflow. Send a "Stop" signal to stop sending data when the receiving buffer is full. Send a "Start" signal to start sending data when the receiving buffer is empty. The options are **None** and Hardware RTS/CTS.

VT-UTF8 Combo Key Support

Select Enabled to enable VT-UTF8 Combination Key support for ANSI/VT100 terminals. The options are **Enabled** and Disabled.

Recorder Mode

Select Enabled to capture the data displayed on a terminal and send it as text messages to a remote server. The options are **Disabled** and Enabled.

Resolution 100x31

Select Enabled for extended-terminal resolution support. The options are Disabled and **Enabled**.

Legacy OS Redirection Resolution

Use this feature to select the number of rows and columns used in Console Redirection for legacy OS support. The options are 80x24 and **80x25**.

Putty KeyPad

This feature selects Function Keys and KeyPad settings for Putty, which is a terminal emulator designed for the Windows OS. The options are **VT100**, LINUX, XTERMR6, SCO, ESCN, and VT400.

Redirection After BIOS Post

Use this feature to enable or disable Legacy Console Redirection after BIOS POST (Power On Self Test). When this feature is set to Bootloader, Legacy Console Redirection is disabled before booting the OS. When this feature is set to Always Enable, Legacy Console Redirection remains enabled during OS bootup. The options are **Always Enable** and Bootloader.

Serial Port for Out-of-Band Management/Windows Emergency Management Services (EMS)

The submenu allows the user to configure Console Redirection settings to support Out-of-Band Serial Port management.

EMS Console Redirection

Select Enabled to select a COM Port for Console Redirection. The options are Enabled and **Disabled**.

►Console Redirection Settings (for EMS)

This feature allows the user to specify how the host computer will exchange data with the client computer, which is the remote computer used by the user.

Out-of-Band Management Port

The feature selects a serial port used by the Microsoft Windows Emergency Management Services (EMS) to communicate with a remote server. The options are **COM1** and SOL.

Terminal Type

Use this feature to select the target terminal emulation type for Console Redirection. Select VT100 to use the ASCII character set. Select VT100+ to add color

and function key support. Select ANSI to use the extended ASCII character set. Select VT-UTF8 to use UTF8 encoding to map Unicode characters into one or more bytes. The options are ANSI, VT100, **VT100+**, and VT-UTF8.

Bits Per Second

This item sets the transmission speed for a serial port used in Console Redirection. Make sure that the same speed is used in the host computer and the client computer. A lower transmission speed may be required for long and busy lines. The options are 9600, 19200, 57600, and **115200** (bits per second).

Flow Control

Use this feature to set the flow control for Console Redirection to prevent data loss caused by buffer overflow. Send a Stop signal to stop sending data when the receiving buffer is full. Send a Start signal to start sending data when the receiving buffer is empty. The options are **None**, Hardware RTS/CTS, and Software Xon/Xoff.

Data Bits, Parity, Stop Bits

The setting for each of these items is displayed.

► ACPI Settings

Use this feature to configure Advanced Configuration and Power Interface (ACPI) power management settings for your system.

ACPI Sleep State

Use this feature to select the ACPI State when the system is in sleep mode. Select S1 (CPU Stop Clock) to erase all CPU caches and stop executing instructions. In this setting, power to the CPU(s) and RAM is maintained, but RAM is refreshed. Select Suspend Disabled to use power-reduced mode. Power will only be supplied to limited components (such as RAMs) to maintain the most critical functions of the system. The options are **S1 (CPU Stop Clock)**, and Suspend Disabled.

NUMA (NON-Uniform Memory Access)

Select Enabled to enable the Non-Uniform Memory Access ACPI support. The options are **Enabled** and Disabled.

High Precision Event Timer

Select Enabled to activate the High Precision Event Timer (HPET) that produces periodic interrupts at a much higher frequency than a Real-time Clock (RTC) does in synchronizing multimedia streams, providing smooth playback, reducing the dependency on other timestamp calculation devices, such as an x86 RDTSC Instruc-

tion embedded in the CPU. The High Performance Event Timer is used to replace the 8254 Programmable Interval Timer. The options are **Enabled** and Disabled.

► **Trusted Computing (Available when a TPM device is detected by the BIOS)**

Configuration

TPM Support

When this feature is set to Enabled, and the onboard TPM is also set to Enabled, you can use TPM support to improve data integrity and network security for your system. The options are **Enabled** and Disabled.

TPM State

Select Enabled to enable TPM security settings to improve data integrity and network security. The options are Disabled and **Enabled**.

Pending Operation

Use this item to schedule an operation for the security device. The options are **None**, Enable Take Ownership, Disable Take Ownership, and TPM Clear.

Note: Upon system reset, the computer will reboot in order to execute the pending operation and change the state of the security device.

Current Status Information: This item displays current TPM status.

TPM Enable Status

This item indicates if TPM is currently enabled or disabled.

TPM Active Status

This item indicates if TPM is currently active or not.

TPM Owner Status

This item displays the status of TPM Ownership.

► **ME Subsystem**

Intel ME Subsystem Configuration

This feature displays information on the Intel Management Engine subsystem:

- ME BIOS Interface Version

- ME Version

4-4 Event Logs

This submenu allows the user to configure Event Log settings.

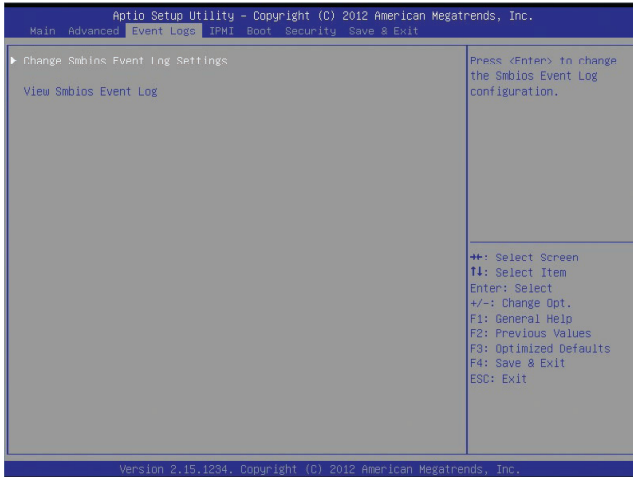

► Change SMBIOS Event Log Settings

This feature allows the user to configure SMBIOS Event settings.

Enabling/Disabling Options

SMBIOS Event Log

Select Enabled to enable SMBIOS (System Management BIOS) event logging during system boot. The options are **Enabled** and Disabled.

Runtime Error Logging Support

Select Enabled to support runtime error logging. The options are **Enabled** and Disabled.

Memory Correctable Error Threshold

Use this feature to enter the threshold value for correctable memory errors. The default setting is **10**.

PCI Error Logging Support

Select Enabled to support error event logging for PCI slots. The options are Enabled and **Disabled**.

Erasing Settings

Erase Event Log

Select Enabled to erase the SMBIOS (System Management BIOS) Event Log, which is completed before an event logging is initialized upon system reboot. The options are **No**, Yes, next reset, and Yes, every reset.

When Log is Full

Select Erase Immediately to immediately erase SMBIOS error event logs that exceed the limit when the SMBIOS event log is full. Select Do Nothing for the system to do nothing when the SMBIOS event log is full. The options are **Do Nothing** and Erase Immediately.

SMBIOS Event Log Standard Settings

Log System Boot Event

Select Enabled to log system boot events. The options are **Disabled** and Enabled.

MECI (Multiple Event Count Increment)

Enter the increment value for the multiple event counter. Enter a number between 1 to 255. The default setting is 1.

METW (Multiple Event Count Time Window)

This item allows the user to decide how long (in minutes) should the multiple event counter wait before generating a new event log. Enter a number between 0 to 99. The default setting is **60**.

View SMBIOS Event Log

This item displays SMBIOS event log.

4-5 IPMI

Use this feature to configure Intelligent Platform Management Interface (IPMI) settings.

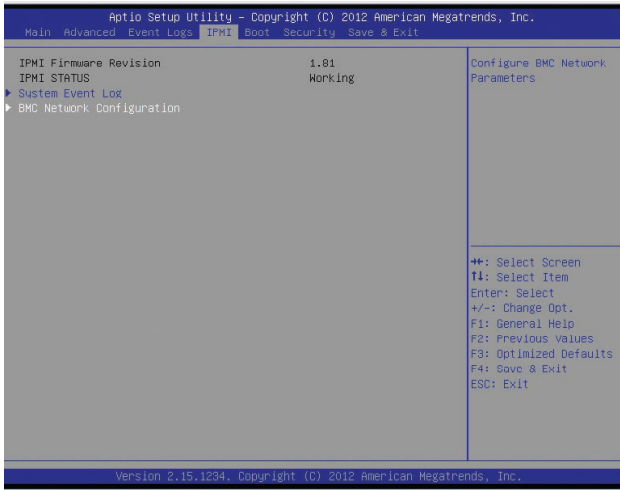

IPMI Firmware Revision

This item indicates the IPMI firmware revision used in your system.

IPMI Status

This item indicates the status of the IPMI firmware installed in your system.

► System Event Log

Enabling/Disabling Options

SEL Components

Select Enabled for all system event logging at bootup. The options are **Enabled** and Disabled.

Erasing Settings

Erase SEL

Select Yes, On next reset to erase all system event logs upon next system reboot.
 Select Yes, On every reset to erase all system event logs upon each system reboot.
 Select No to keep all system event logs after each system reboot. The options are **No**, Yes, On next reset, and Yes, On every reset.

When SEL is Full

This feature allows the user to decide what the BIOS should do when the system event log is full. Select Erase Immediately to erase all events in the log when the system event log is full. The options are **Do Nothing** and Erase Immediately.

►BMC Network Configuration

LAN Channel 1: This feature is used to configure the settings for LAN1 Port.

IPMI LAN Selection: This item displays the current IPMI Selection setting.

IPMI Network Line Status: This item displays the status of the current IPMI network connection line.

Update IPMI LAN Configuration

This feature allows the BIOS to implement any IP/MAC address changes at the next system boot. If the option is set to Yes, any changes made to the settings below will take effect at the next system reboot. The options are **No** and Yes.

Configuration Address Source

Use this feature to select the source of the IP address for this computer. If Static is selected, you will need to know the IP address of this computer and enter it to the system manually in the field. If DHCP is selected, the BIOS will search for a DHCP (Dynamic Host Configuration Protocol) server in the network that it is attached to and request the next available IP address for this computer. The options for are **DHCP** and Static. The following items are assigned IP addresses automatically if DHCP is selected, or can be configured manually if Static is selected.

Station IP Address

This item displays the Station IP address for this computer. This should be in decimal and in dotted quad form (i.e., 192.168.10.253).

Subnet Mask

This item displays the sub-network that this computer belongs to. The value of each three-digit number separated by dots should not exceed 255.

Station MAC Address

This item displays the Station MAC address for this computer. Mac addresses are 6 two-digit hexadecimal numbers.

Gateway IP Address

This item displays the Gateway IP address for this computer. This should be in decimal and in dotted quad form (i.e., 192.168.10.253).

4-6 Boot

This submenu allows the user to configure the following boot settings for the system.

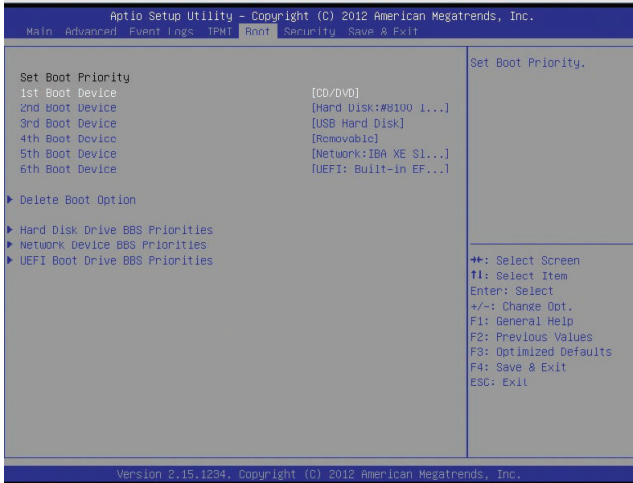

Set Boot Priority

1st Boot Device, 2nd Boot Device, 3rd Boot Device, etc.

Use these items to specify the sequence of boot device priority.

► Delete Boot Option

Use this feature to select a boot device to delete from the boot priority list.

Delete Boot Option

Use this feature to select a boot device to delete.

► Hard Disk Drive BBS Priorities

This item is used to select the boot device priority sequence from available hard drives.

► Network Device BBS Priorities

This item is used to select the boot device priority sequence from available network devices.

► UEFI Boot Drive BBS Priorities

This item is used to select the boot device priority sequence from available UEFI devices.

4-7 Security

This menu is used to configure the following security settings for the system.

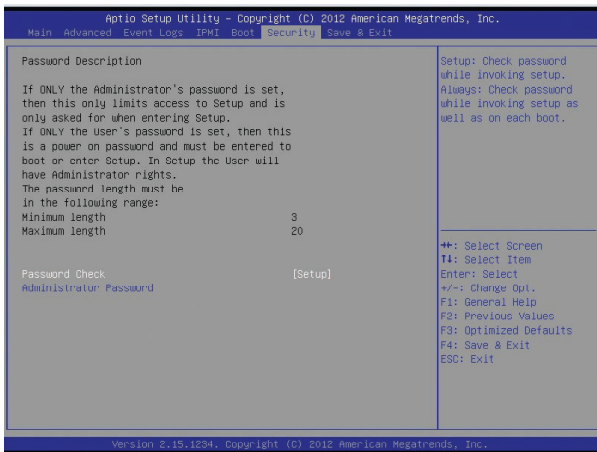

Password Check

This feature determines when a password entry is required. If Setup is selected, the user is required to enter a password upon entering the BIOS setup utility. If Always is selected, the user is required to enter a password upon entering the BIOS setup utility and upon each system boot. The options are **Setup** and Always.

Administrator Password

Use this item to set the Administrator Password which is required to enter the BIOS setup utility. The length of the password should be from 3 characters to 20 characters long.

4-8 Save & Exit

This submenu allows the user to configure the Save and Exit settings for the system.

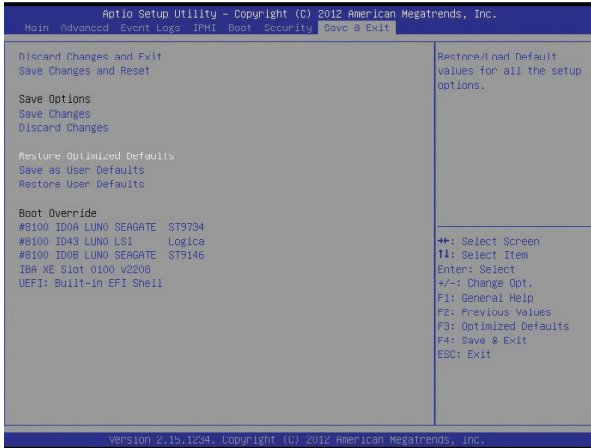

Discard Changes and Exit

Select this option to quit the BIOS Setup without making any permanent changes to the system configuration, and reboot the computer. Select Discard Changes and Exit, and press <Enter>. When the dialog box appears, asking you if you want to exit the BIOS setup without saving, select **Yes** to quit BIOS without saving the changes, or select No to quit the BIOS and save changes.

Save Changes and Reset

When you have completed the system configuration changes, select this option to save the changes and reboot the computer so that the new system configuration settings can take effect. Select Save Changes and Exit, and press <Enter>. When the dialog box appears, asking you if you want to exit the BIOS setup without saving, select **Yes** to quit BIOS without saving the changes, or select No to quit the BIOS and save changes.

Save Options

Save Changes

Select this option and press <Enter> to save all changes you've done so far and return to the AMI BIOS utility. When the dialog box appears, asking you if you want to save configuration, select **Yes** to save the changes, or select No to return to the BIOS without making changes.

Discard Changes

Select this feature and press <Enter> to discard all the changes and return to the BIOS setup. When the dialog box appears, asking you if you want to load previous values, select **Yes** to load the values previous saved, or select No to keep the changes you've made so far.

Restore Optimized Defaults

Select this feature and press <Enter> to load the optimized default settings that will help optimize system performance. When the dialog box appears, asking you if you want to load optimized defaults, select **Yes** to load the optimized default settings, or select No to abandon optimized defaults.

Save as User Defaults

Select this feature and press <Enter> to save the current settings as the user's defaults. When the dialog box appears, asking you if you want to save values as user's defaults, click **Yes** to save the current values as user's default settings, or click No to keep the defaults previously saved as the user's defaults.

Restore User Defaults

Select this feature and press <Enter> to load the user's defaults previously saved in the system. When the dialog box appears, asking you if you want to restore user's defaults, select **Yes** to restore the user's defaults previously saved in the system, or select No to abandon the user's defaults that were previously saved.

Boot Override

Use this item to override the boot device priority sequence as listed in the Boot submenu, and select one of the devices listed below to boot the system instead. This is a one-time override.

#8100 ID0A LUN0 SEAGAGE ST9734,

#8100 ID43 LUN0 LSI LSI Logica,

#8100 ID0B LUN0 SEAGAGE ST9146,

IBA XE Slot 0100 v2208,

UEFI Built-in EFI Shell

Appendix A

BIOS Error Beep Codes

BIOS Error Beep Codes are not available for this motherboard.

Notes

Appendix B

Software Installation Instructions

B-1 Installing Software Programs

The Supermicro ftp site contains drivers and utilities for your system at <ftp://ftp.supermicro.com>. Some of these must be installed, such as the chipset driver.

After accessing the ftp site, go into the CDR_Images directory and locate the ISO file for your motherboard. Download this file to create a CD/DVD of the drivers and utilities it contains. (You may also use a utility to extract the ISO file if preferred.)

Another option is to go to the Supermicro Website at <http://www.supermicro.com/products/>. Find the product page for your motherboard here, where you may download individual drivers and utilities.

After creating a CD/DVD with the ISO files, insert the disk into the CD/DVD drive on your system and the display shown below should appear.

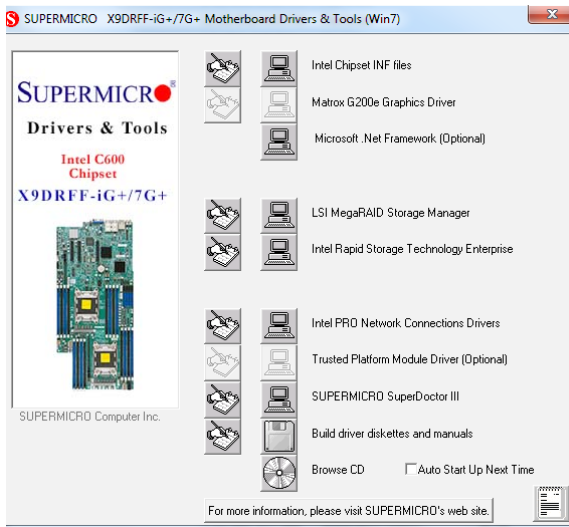

Driver/Tool Installation Display Screen

 **Note 1:** Click the icons showing a hand writing on paper to view the readme files for each item. Click the computer icons to the right of these items to install each item (from top to the bottom) one at a time. **After installing each item, you must re-boot the system before moving on to the next item on the list.** The bottom icon with a CD on it allows you to view the entire contents.

 **Note 2:** When making a storage driver diskette by booting into a Driver CD, please set the SATA Configuration to "Compatible Mode" and configure SATA as IDE in the BIOS Setup. After making the driver diskette, be sure to change the SATA settings back to your original settings.

 **Note 3:** Changing BMC log-in information is recommended during initial system power-on. The default username is ADMIN and password is ADMIN. For BMC best practices, please refer to: http://www.supermicro.com/products/info/files/IPMI/Best_Practices_BMC_Security.pdf

B-2 Configuring SuperDoctor III

The SuperDoctor[®] III program is a web-based management tool that supports remote management capability. It includes Remote and Local Management tools. The local management is called SD III Client. The SuperDoctor III program allows you to monitor the environment and operations of your system. SuperDoctor III displays crucial system information such as CPU temperature, system voltages and fan status. See the figures below for examples of the SuperDoctor III interface.

 **Note:** The default User Name and Password for SuperDoctor III is ADMIN / ADMIN.

 **Note:** When SuperDoctor III is first installed, it adopts the temperature threshold settings that have been set in BIOS. Any subsequent changes to these thresholds must be made within SuperDoctor III, as the SuperDoctor III settings override the BIOS settings. To set the BIOS temperature threshold settings again, you would first need to uninstall SuperDoctor III.

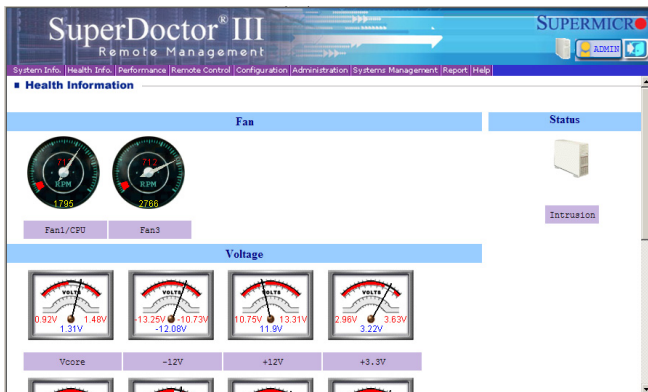

SuperDoctor[®] III Interface Display Screen (Health Information)



SuperDoctor® III Interface Display Screen (Remote Control)

 **Note:** SD III Software Revision 1.0 can be downloaded from our Web Site at: ftp://ftp.supermicro.com/utility/Super_Doctor_III/. You can also download the SDIII User's Guide at: <http://www.supermicro.com/PRODUCT/Manuals/SDIII/UserGuide.pdf>. For Linux, we will recommend using SuperDoctor II.

Notes

(Disclaimer Continued)

The products sold by Supermicro are not intended for and will not be used in life support systems, medical equipment, nuclear facilities or systems, aircraft, aircraft devices, aircraft/emergency communication devices or other critical systems whose failure to perform be reasonably expected to result in significant injury or loss of life or catastrophic property damage. Accordingly, Supermicro disclaims any and all liability, and should buyer use or sell such products for use in such ultra-hazardous applications, it does so entirely at its own risk. Furthermore, buyer agrees to fully indemnify, defend and hold Supermicro harmless for and against any and all claims, demands, actions, litigation, and proceedings of any kind arising out of or related to such ultra-hazardous use or sale.