

SUPER  [®]

**X9DRFF
X9DRFF-7**

USER'S MANUAL

Revision 1.0

The information in this User's Manual has been carefully reviewed and is believed to be accurate. The vendor assumes no responsibility for any inaccuracies that may be contained in this document, and makes no commitment to update or to keep current the information in this manual, or to notify any person or organization of the updates. **Please Note: For the most up-to-date version of this manual, please see our Website at www.supermicro.com.**

Super Micro Computer, Inc. ("Supermicro") reserves the right to make changes to the product described in this manual at any time and without notice. This product, including software and documentation, is the property of Supermicro and/or its licensors, and is supplied only under a license. Any use or reproduction of this product is not allowed, except as expressly permitted by the terms of said license.

IN NO EVENT WILL SUPER MICRO COMPUTER, INC. BE LIABLE FOR DIRECT, INDIRECT, SPECIAL, INCIDENTAL, SPECULATIVE OR CONSEQUENTIAL DAMAGES ARISING FROM THE USE OR INABILITY TO USE THIS PRODUCT OR DOCUMENTATION, EVEN IF ADVISED OF THE POSSIBILITY OF SUCH DAMAGES. IN PARTICULAR, SUPER MICRO COMPUTER, INC. SHALL NOT HAVE LIABILITY FOR ANY HARDWARE, SOFTWARE, OR DATA STORED OR USED WITH THE PRODUCT, INCLUDING THE COSTS OF REPAIRING, REPLACING, INTEGRATING, INSTALLING OR RECOVERING SUCH HARDWARE, SOFTWARE, OR DATA.

Any disputes arising between the manufacturer and the customer shall be governed by the laws of Santa Clara County in the State of California, USA. The State of California, County of Santa Clara shall be the exclusive venue for the resolution of any such disputes. Supermicro's total liability for all claims will not exceed the price paid for the hardware product.

FCC Statement: This equipment has been tested and found to comply with the limits for a Class A digital device pursuant to Part 15 of the FCC Rules. These limits are designed to provide reasonable protection against harmful interference when the equipment is operated in a commercial environment. This equipment generates, uses, and can radiate radio frequency energy and, if not installed and used in accordance with the manufacturer's instruction manual, may cause harmful interference with radio communications. Operation of this equipment in a residential area is likely to cause harmful interference, in which case you will be required to correct the interference at your own expense.

California Best Management Practices Regulations for Perchlorate Materials: This Perchlorate warning applies only to products containing CR (Manganese Dioxide) Lithium coin cells. "Perchlorate Material-special handling may apply. See www.dtsc.ca.gov/hazardouswaste/perchlorate".

WARNING: Handling of lead solder materials used in this product may expose you to lead, a chemical known to the State of California to cause birth defects and other reproductive harm.

Manual Revision 1.0

Release Date: Nov. 2, 2012

Unless you request and receive written permission from Super Micro Computer, Inc., you may not copy any part of this document.

Information in this document is subject to change without notice. Other products and companies referred to herein are trademarks or registered trademarks of their respective companies or mark holders.

Copyright © 2012 by Super Micro Computer, Inc.
All rights reserved.

Printed in the United States of America

Preface

This manual is written for system integrators, PC technicians and knowledgeable PC users. It provides information for the installation and use of the X9DRFF/X9DRFF-7 motherboard.

About This Motherboard

The Super X9DRFF/X9DRFF-7 motherboard supports dual Intel E5-2600 Series (Socket R) processors that offer QPI (Intel QuickPath Interface) Technology (V.1.1), providing point-to-point connection with a transfer speed of up to 8.0 TG/s. With the C602-J chipset built in, the X9DRFF/X9DRFF-7 motherboard supports Intel® Intelligent Power Node Manager (NM), Manageability Engine (ME) Technology, Digital Media Interface (DMI), PCI-E Gen. 3.0 and 1600 MHz DDR3 memory. This motherboard is ideal for 4U Fat Twin server platforms. Please refer to our Website (<http://www.supermicro.com>) for CPU and memory support updates.

Manual Organization

Chapter 1 describes the features, specifications and performance of the motherboard, and provides detailed information about the Intel C602-J chipset.

Chapter 2 provides hardware installation instructions. Read this chapter when installing the processor, memory modules and other hardware components into the system. If you encounter any problems, see **Chapter 3**, which describes troubleshooting procedures for video, memory, and system setup stored in the CMOS.

Chapter 4 includes an introduction to the BIOS, and provides detailed information on running the CMOS Setup utility.

Appendix A provides BIOS Error Beep Codes.

Appendix B lists Software Installation Instructions.

Conventions Used in the Manual

Pay special attention to the following symbols for proper system installation and to prevent damage to the system or injury to yourself:

Warning: Important information given to ensure proper system installation or to prevent damage to the components or injury to yourself



Note: Additional information given to differentiate between various models or provides information for correct system setup.

Contacting Supermicro

Headquarters

Address: Super Micro Computer, Inc.
980 Rock Ave.
San Jose, CA 95131 U.S.A.

Tel: +1 (408) 503-8000

Fax: +1 (408) 503-8008

Email: marketing@supermicro.com (General Information)
support@supermicro.com (Technical Support)

Website: www.supermicro.com

Europe

Address: Super Micro Computer B.V.
Het Sterrenbeeld 28, 5215 ML
's-Hertogenbosch, The Netherlands

Tel: +31 (0) 73-6400390

Fax: +31 (0) 73-6416525

Email: sales@supermicro.nl (General Information)
support@supermicro.nl (Technical Support)
rma@supermicro.nl (Customer Support)

Asia-Pacific

Address: Super Micro Computer, Inc.
4F, No. 232-1, Liancheng Rd.
Chung-Ho 235, Taipei County
Taiwan, R.O.C.

Tel: +886-(2) 8226-3990

Fax: +886-(2) 8226-3991

Website: www.supermicro.com.tw

Email: support@supermicro.com.tw (Technical Support)

Tel: +886-(2) 8226-5990 (Technical Support)

Table of Contents

Preface

Chapter 1 Overview

1-1	Overview	1-1
1-2	Processor and Chipset Overview.....	1-11
1-3	Special Features	1-12
1-4	PC Health Monitoring.....	1-12
1-5	ACPI Features.....	1-13
1-6	Power Supply	1-13
1-7	Super I/O.....	1-14
1-8	Advanced Power Management.....	1-14
	Intel® Intelligent Power Node Manager (IPNM)	1-14
	Manageability Engine (ME).....	1-14
1-9	Overview of the Nuvoton WPCM450 Controller	1-15
	WPCM450R DDR2 Memory Interface	1-15
	WPCM450R PCI System Interface.....	1-15
	Other Features Supported by the WPCM BMC Controller.....	1-15

Chapter 2 Installation

2-1	Standardized Warning Statements	2-1
2-2	Static-Sensitive Devices.....	2-4
2-3	Processor and Heatsink Installation.....	2-5
2-4	Installing and Removing the Memory Modules.....	2-11
	Installing & Removing DIMMs.....	2-11
	Removing Memory Modules	2-11
2-5	Motherboard Installation.....	2-15
	Tools Needed	2-15
	Location of Mounting Holes	2-15
	Installing the Motherboard	2-16
2-6	Control Panel Connectors and I/O Ports	2-17
	Control Panel I/O Connectors and Ports	2-17
	Control Panel I/O Port Locations and Definitions	2-17
	Universal Serial Bus (USB).....	2-18
	Video Connection	2-18
	Ethernet Ports	2-19
	Serial Port.....	2-19
	Power Switch/LED Indicator.....	2-20
	Unit Identifier Button/LED Indicator.....	2-20
2-7	Connecting Cables.....	2-21

	Standby Power	2-21
	Fan Headers.....	2-22
	TPM Header/Port 80	2-22
	IPMB.....	2-23
	SATA Device Power Connector.....	2-23
	T-SGPIO1/2 & 6-SGPIO1 Headers	2-24
	Power Connector Header for Failed System LED Header	2-24
	Internal Speaker	2-25
	Onboard CMOS Battery	2-25
2-8	Jumper Settings	2-26
	Explanation of Jumpers	2-26
	GLAN Enable/Disable	2-26
	CMOS Clear	2-27
	Watch Dog Enable/Disable	2-27
	VGA Enable.....	2-28
	BMC Enable	2-28
	SAS Enable (X9DRFF-7 Only).....	2-29
	Failed System LED Enable	2-30
2-9	Onboard LED Indicators	2-31
	GLAN LEDs.....	2-31
	IPMI Dedicated LAN LEDs.....	2-31
	SAS Activity LED (X9DRFF-7 Only).....	2-32
	SAS Heartbeat LED (X9DRFF-7 Only).....	2-32
	PWR Fail/Fan Fail/OH (Overheat) LED	2-33
	Failed System LED (via IPMI)	2-33
	BMC Activity LED	2-34
2-10	SATA/SAS Connections	2-35
	SATA/SAS Ports (SAS: For X9DRFF-7 Only).....	2-35
Chapter 3 Troubleshooting		
3-1	Troubleshooting Procedures	3-1
	Before Power On	3-1
	No Power	3-1
	Losing the System's Setup Configuration.....	3-2
	When the System Becomes Unstable	3-2
3-2	Technical Support Procedures	3-3
3-3	Battery Removal and Installation	3-5
	Battery Removal.....	3-5
	Proper Battery Disposal.....	3-5

Battery Installation.....	3-5
3-4 Frequently Asked Questions.....	3-6
3-5 Returning Merchandise for Service.....	3-7

Chapter 4 BIOS

4-1 Introduction.....	4-1
Starting BIOS Setup Utility.....	4-1
How To Change the Configuration Data.....	4-2
Starting the Setup Utility.....	4-2
4-2 Main Setup.....	4-2
4-3 Advanced Setup Configurations.....	4-4
4-4 Event Logs.....	4-25
4-5 IPMI.....	4-27
4-6 Boot.....	4-29
4-7 Security.....	4-30
4-8 Save & Exit.....	4-31

Appendix A BIOS Error Beep Codes

A-1 BIOS Error Beep Codes.....	A-1
--------------------------------	-----

Appendix B Software Installation Instructions

B-1 Installing Software Programs.....	B-1
B-2 Configuring SuperDoctor III (For Window OS Only).....	B-2

Chapter 1

Overview

1-1 Overview

Checklist

Congratulations on purchasing your computer motherboard from an acknowledged leader in the industry. Supermicro boards are designed with the utmost attention to detail to provide you with the highest standards in quality and performance.

This motherboard was designed to be used in an SMC-proprietary system as a part of an integrated system platform.



Note: For your system to work properly, please follow the links below to download all necessary drivers/utilities and the user's manual for your motherboard.

- SMCI product manuals: <http://www.supermicro.com/support/manuals/>
- Product Drivers and utilities: <ftp://ftp.supermicro.com/>

If you have any questions, please contact our support team at support@supermicro.com.

Warning: For safety considerations, please refer to the complete list of safety warnings posted on the Supermicro website at http://www.supermicro.com/about/policies/safety_information.cfm.

SUPER Motherboard Image

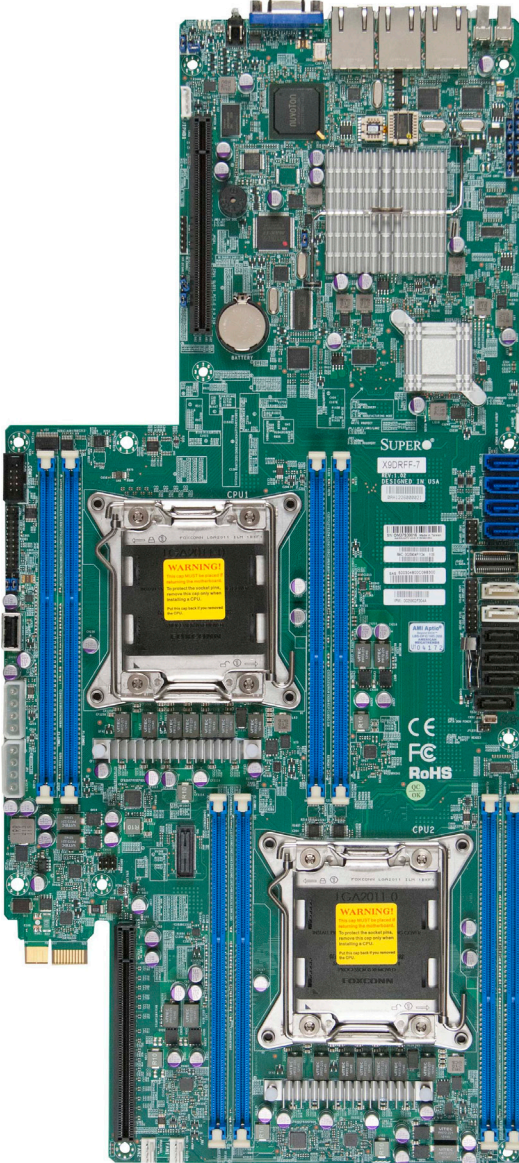

 **Note:** All graphics shown in this manual were based upon the latest PCB Revision available at the time of publishing of the manual. The motherboard you've received may or may not look exactly the same as the graphics shown in this manual.

Motherboard Layout

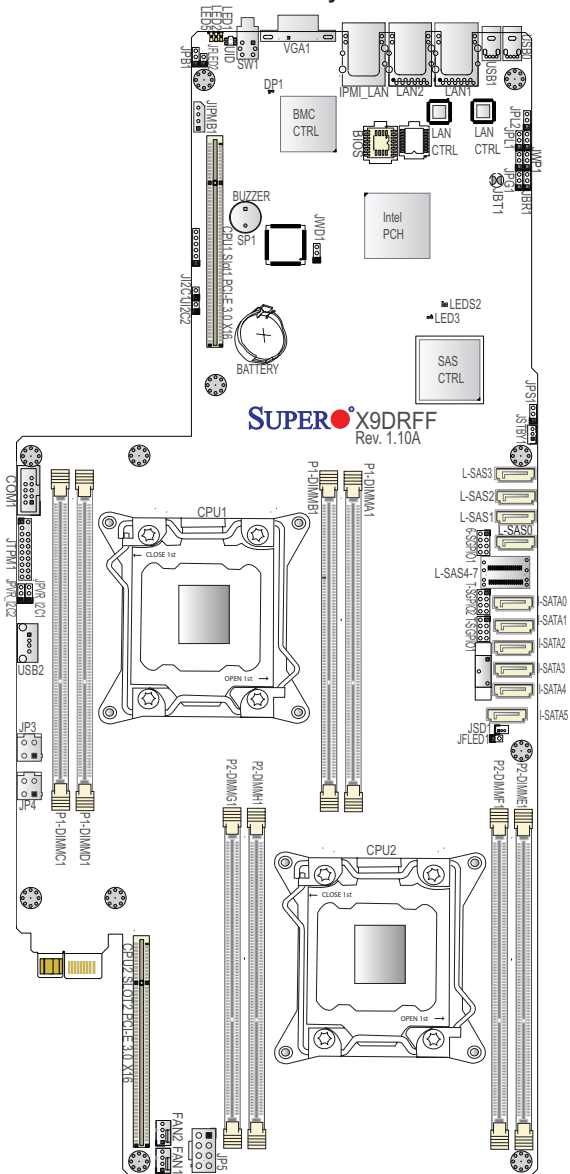

 **Note:** For the latest CPU/Memory updates, please refer to our Website at <http://www.supermicro.com/products/motherboard/> for details.

X9DRFF(-7) Quick Reference

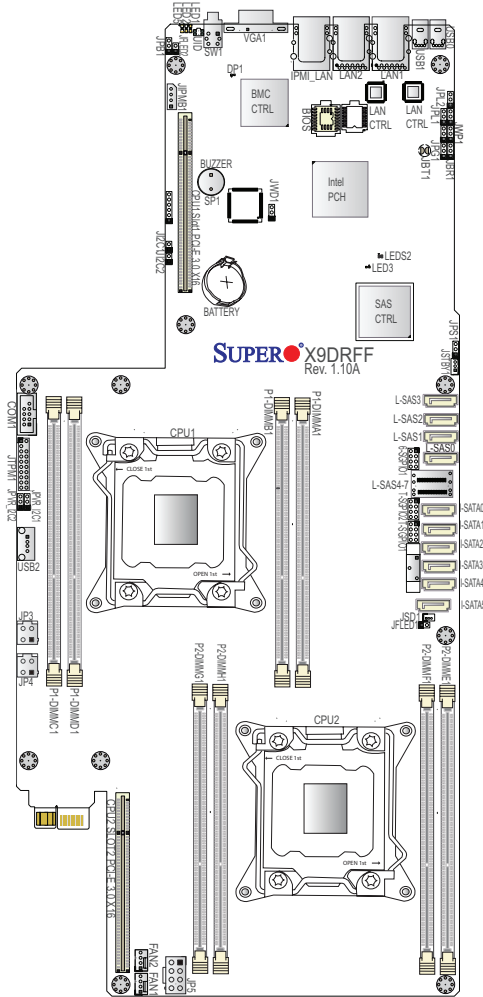

Notes:

- See Chapter 2 for detailed information on jumpers, I/O ports and JF1 front panel connections.
- "■" indicates the location of "Pin 1".
- Jumpers/LED Indicators not indicated are for testing only.
- Use only the correct type of onboard CMOS battery as specified by the manufacturer. Do not install the onboard battery upside down to avoid possible explosion.

X9DRFF(-7) Jumpers

Jumper	Description	Default Setting
JBT1	Clear CMOS	See Chapter
JFLED2	Failed System LED Enable	Closed (Disabled)
JI ² C1/JI ² C2	SMB to PCI-E Slots	Open (Disabled)
JPB1	BMC Enable	Pins 1-2 (Enabled)
JPG1	VGA Enable	Pins 1-2 (Enabled)
JPL1/JPL2	LAN1/LAN2 Enable	Pins 1-2 (Enabled)
JPS1 (X9DRFF-7 Only)	SAS Enable	Pins 1-2 (Enabled)
JWD1	Watch Dog Timer Enable	Pins 1-2 (Reset)

X9DRFF(-7) Connectors

Connectors	Description
Battery	Onboard Battery (See Chpt. 3 for Used Battery Disposal)
COM1	Serial (COM) Port
FAN1/FAN2	CPU/System (4-Pin) Fan Headers
JFLED1	Power Connector Header for Failed System LED
JIPMB1	4-pin External BMC I ² C Header (for an IPMI Card)
JP3/JP4	4-pin Power Connectors
JP5	8-pin Power Connector
JSD1	SATA Device Power Connector
JSTBYI	Standby Power Connector
JTPM1	TPM (Trusted Platform Module)/Port 80
LAN1/LAN2	G-bit Ethernet LAN Ports 1/2
(IPMI) LAN	IPMI LAN
(I-)SATA 0/1	SATA 3.0 Connectors 0/1 from Intel AHCI
(I-) SATA 2-5	SATA 2.0 Connectors 2/3/4/5 from Intel AHCI
(L-) SAS 0-3 (X9DRFF-7 Only)	SAS Connectors 0/1/2/3 from LSI 2308 SAS Controller
(L-) SAS 4-7 (X9DRFF-7 Only)	SAS Connections 4-7 from LSI 2308 SAS Controller
6-SGPIO 1 (X9DRFF-7 Only)	Serial_Link General Purpose I/O Header for LSI SAS connection support
T-SGPIO 1/2	Serial_Link General Purpose I/O (SATA SGPIO) Headers 1/2 for Intel SATA connection support
SP1	Internal Speaker/Buzzer
(CPU1) Slot1/(CPU2) Slot2	PCI-Exp. 3.0 x16 Slots

SWI	Power Switch/LED Indicator (SW1)
UID	Unit Identifier Button (JUIDB1)
USB0/USB1	Control Panel USB 0/ USB1 Ports
USB2	Front Panel USB 2 Port
VGA1	(Control Panel) VGA Port

X9DRFF(-7) LED Indicators

LED	Description	State	Status
DP1	BMC Activity LED	Green: Blinking	BMC Active
LED1	UID LED	Blue: On	Unit Identified
LED2	Power Fail/Fan Fail/OH LED	Red: On or Blinking	On: Overheat, Fast Blinking: Fan Failure, Slow Blinking: Power Failure
LED3	SAS Activity LED (X9DRFF-7 Only)	Green: Blinking	SAS: Active
LED5	Failed System LED (via IPMI Firmware)	Red: Blinking	Unit Identified
LEDS2	SAS Heartbeat LED	Green Red	SAS: Normal, SAS: Failed



Note:

To provide adequate power supply to the motherboard, be sure to connect the 8-pin power connector (JP5) and the 4-pin power connectors (JP3/JP4) to the power supply. Failure to do so might void the manufacturer warranty on your power supply and motherboard.

Motherboard Features

CPU	<ul style="list-style-type: none"> Dual Intel® E5-2600 Series (Socket R) processors; each processor supports four full-width Intel Quick-Path Interconnect (QPI) links (with support of up to 25.6 GT/s per QPI link and with Data Transfer Rate of up to 8.0 GT/s per direction) 	
Memory	<ul style="list-style-type: none"> Integrated memory controller supports up to 256 GB of Registered (RDIMM)/Load Reduced (LRDIMM) ECC or up to 64 GB of Unbuffered (UDIMM) ECC/Non-ECC 800/1066/1333/1600 MHz 4-channel (per CPU) DDR3 memory in 8 DIMM slots. <p> Note: For the latest CPU/memory updates, please refer to our website at http://www.supermicro.com/products/motherboard.</p>	
Chipset	<ul style="list-style-type: none"> Intel® C602-J Chipset 	
Expansion Slot	<ul style="list-style-type: none"> Two (2) PCI-E 3.0 x16 slots (CPU1 Slot 1/ CPU2 Slot 2) 	
Graphics	<ul style="list-style-type: none"> Nuvoton WPCM450R BMC Video Controller 	
Network	<ul style="list-style-type: none"> Two Intel 82574L Gigabit (10/100/1000 Mb/s) Ethernet controllers for LAN 1/LAN 2 ports. 	
	<ul style="list-style-type: none"> Nuvoton WPCM450R Base-board Controller (BMC) supports IPMI_LAN 2.0 	
I/O Devices	SATA Connections	
	<ul style="list-style-type: none"> S A T A Ports 	Two (2) SATA 3.0 (I-SATA 0/1) Four (4) SATA 2.0 Ports from PCH (I-SATA 2-5)
	SAS/SATA Ports (SAS: For X9DRFF-7 Only)	
		<ul style="list-style-type: none"> Four (4)SATA 3.0/SAS 2.0 connections: L-SAS 0-3 One (1) SAS connector for SAS Connections 4-7

	<ul style="list-style-type: none"> RAID 	<ul style="list-style-type: none"> SATA RAID 0, 1, 5, 10 (Windows) SATA RAID 0, 1, 10 (Linux) SAS RAID 0, 1, 10 (X9DRFF-7 Only)
	Integrated IPMI 2.0	
	<ul style="list-style-type: none"> IPMI 2.0 supported by the WPCM450R BMC 	
	Serial (COM) Port	
	<ul style="list-style-type: none"> One (1) Fast UART 16550 Connection: 9-pin RS-232 port 	
	Super I/O	
	<ul style="list-style-type: none"> Winbond Super I/O 83527 	
Peripheral Devices	USB Devices	
	<ul style="list-style-type: none"> Two (2) USB ports on the rear I/O panel (USB 0/1), One (1) USB port for front panel access (USB 2) 	
BIOS	<ul style="list-style-type: none"> 16 MB SPI AMI BIOS® SM Flash BIOS 	
	<ul style="list-style-type: none"> APM 1.2, DMI 2.3, PCI 2.3, ACPI 1.0/2.0/3.0/4.0, USB Keyboard, Plug & Play (PnP) and SMBIOS 2.5 	
Power Config.	<ul style="list-style-type: none"> ACPI/ACPM Power Management 	
	<ul style="list-style-type: none"> Main switch override mechanism 	
	<ul style="list-style-type: none"> Intel® Intelligent Power Node Manager (NM) Manageability Engine (ME) 	
	<ul style="list-style-type: none">  (Note: Special Cable required) 	
	<ul style="list-style-type: none"> Keyboard Wake-up from Soft-Off Power-on mode for AC power recovery 	
PC Health Monitoring	CPU Monitoring	
	<ul style="list-style-type: none"> Onboard voltage monitors for 1.8V, 3.3V, +3.3VSB, 5V, +5VSB, +12V/-12V, VBAT, HT, memory voltages, chipset voltages. 	
	<ul style="list-style-type: none"> CPU 5+1-Phase switching voltage regulator 	
	<ul style="list-style-type: none"> CPU/System overheat LED and control 	
	<ul style="list-style-type: none"> CPU Thermal Design Power (TDP): support up to 130W (See Note 1 next page) 	
	<ul style="list-style-type: none"> CPU Thermal Trip support Thermal Monitor 2 (TM2) support 	

	<table border="1"> <thead> <tr> <th colspan="2">Fan Control</th> </tr> </thead> <tbody> <tr> <td></td> <td> <ul style="list-style-type: none"> Fan status monitoring with firmware 4-pin (Pulse Width Modulation) fan speed control </td> </tr> <tr> <td></td> <td> <ul style="list-style-type: none"> Low noise fan speed control </td> </tr> </tbody> </table>	Fan Control			<ul style="list-style-type: none"> Fan status monitoring with firmware 4-pin (Pulse Width Modulation) fan speed control 		<ul style="list-style-type: none"> Low noise fan speed control
Fan Control							
	<ul style="list-style-type: none"> Fan status monitoring with firmware 4-pin (Pulse Width Modulation) fan speed control 						
	<ul style="list-style-type: none"> Low noise fan speed control 						
System Management	<ul style="list-style-type: none"> PECI (Platform Environment Configuration Interface) 2.0 support System resource alert via SuperDoctor III SuperDoctor III, Watch Dog, NMI Chassis Intrusion Header and Detection 						
Dimensions	<ul style="list-style-type: none"> 19.92" (L) x 8.54" (W) (505.97 mm x 216.92 mm) 						

 **Note 1:** CPU Maximum Thermal Design Power (TDP) is subject to chassis and heatsink cooling restrictions. For proper thermal management, please check the chassis and heatsink specifications for proper CPU TDP sizing.

Note 2: For IPMI Configuration Instructions, please refer to the Embedded IPMI Configuration User's Guide available @ <http://www.supermicro.com/support/manuals/>.

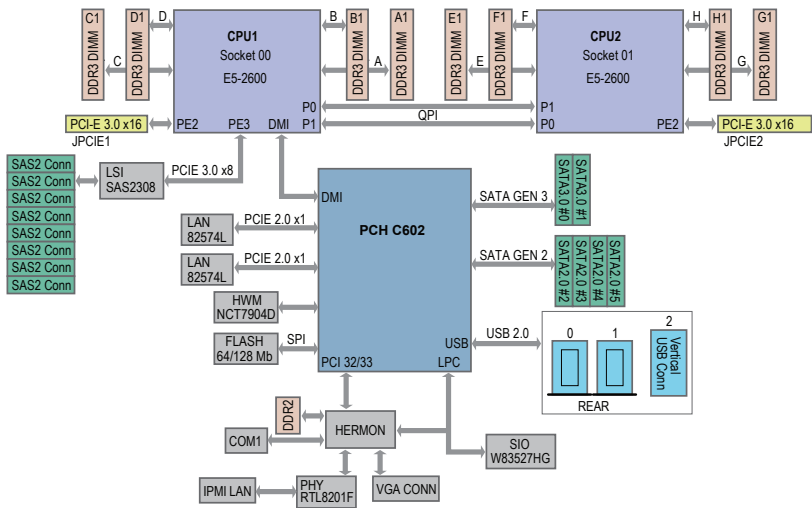

System Block Diagram

 **Note:** This is a general block diagram and may not exactly represent the features on your motherboard. See the Motherboard Features pages for the actual specifications of each motherboard.

1-2 Processor and Chipset Overview

Built upon the functionality and the capability of Intel E5-2600 Series (Socket R) processors and the C602-J chipset, the X9DRFF(-7) motherboard provides the performance and feature sets required for dual_processor-based 4U Fat Twin server platforms.

With support of Intel QuickPath interconnect (QPI) Technology, the X9DRFF(-7) offers point-to-point serial interconnect interface with a transfer speed of up to 8.0 GT/s, providing superb system performance.

The C602-J chipset provides extensive IO support, including the following functions and capabilities:

- PCI-E 2.0 and 3.0 support
- ACPI Power Management Logic Support, Rev. 3.0b
- Intel® Intelligent Power Node Management (NM) (Special PS cable required)
- Manageability Engine (ME)
- Intel Rapid Storage Technology supported
- Intel Virtualization Technology for Directed I/O (Intel VT-d) supported
- Intel Trusted Execution Technology supported
- Serial Peripheral Interface (SPI) Supported
- Intel Anti-Theft Technology (Intel AT) supported
- Digital Media Interface (DMI) supported
- Advanced Host Controller Interface (AHCI) supported
- Compatibility Modules (DMA Controller, Timer/Counters, Interrupt Controller) supported

1-3 Special Features

Recovery from AC Power Loss

The Basic I/O System (BIOS) provides a setting that determines how the system will respond when AC power is lost and then restored to the system. You can choose for the system to remain powered off (in which case you must press the power switch to turn it back on), or for it to automatically return to the power-on state. See the Advanced BIOS Setup section for this setting. The default setting is **Last State**.

1-4 PC Health Monitoring

This section describes the features of PC health monitoring of the motherboard. This motherboard has an onboard System_Hardware_Monitor chip that supports PC health monitoring. An onboard voltage monitor will scan the following onboard voltages continuously: Onboard voltage monitors for 1.8V, 3.3V, +3.3VSB, 5V, +5VSB, +12V/-12V, VBAT, HT, memory voltages, chipset voltages. . Once a voltage becomes unstable, a warning is given, or an error message is sent to the screen. The user can adjust the voltage thresholds to define the sensitivity of the voltage monitor.

Fan Status Monitor with Firmware Control

The PC health monitoring chip can check the RPM status of a cooling fan. The onboard CPU and chassis fans are controlled via IPMI interface.

Environmental Temperature Control

A thermal control sensor monitors the CPU temperature in real time and will turn on the thermal control fan whenever the CPU temperature exceeds a user-defined threshold. The overheat circuitry runs independently from the CPU. Once it detects that the CPU temperature is too high, it will automatically turn on the thermal fan control to prevent the CPU from overheating. The onboard chassis thermal circuitry can monitor the overall system temperature and alert the user when the chassis temperature is too high.



Note: To avoid possible system overheating, please be sure to provide adequate airflow to your system.

System Resource Alert

This feature is available when used with SuperDoctor III in the Windows OS environment or used with SuperDoctor II in Linux. SuperDoctor is used to notify the user of certain system events. For example, you can configure SuperDoctor

to provide you with warnings when the system temperature, CPU temperatures, voltages, and fan speeds go beyond a predefined range.

1-5 ACPI Features

ACPI stands for Advanced Configuration and Power Interface. The ACPI specification defines a flexible and abstract hardware interface that provides a standard way to integrate power management features throughout a PC system, including its hardware, operating system and application software. This enables the system to automatically turn on and off peripherals such as CD-ROMs, network cards, hard disk drives and printers.

In addition to operating_system-directed power management, ACPI also provides a generic system event mechanism for Plug and Play, and an operating system-independent interface for configuration control. ACPI leverages the Plug and Play BIOS data structures, while providing a processor architecture-independent implementation that is compatible with Windows 7, Windows 8, and Windows 2008 Operating Systems.

Slow Blinking LED for Suspend-State Indicator

When the CPU goes into a suspend state, the chassis power LED will start blinking to indicate that the CPU is in suspend mode. When the user presses any key, the CPU will "wake up," and the LED will automatically stop blinking and remain on.

1-6 Power Supply

As with all computer products, a stable power source is necessary for proper and reliable operation. It is even more important for processors that have high CPU clock rates.

The X9DRFF-7 motherboard supports SMCi-Proprietary Fat Twin power supply. Although most power supplies generally meet the specifications required by the CPU, some are inadequate. All these power connections are required to ensure adequate power supply to the system. Your power supply must also supply 1.5A for the Ethernet ports. Additionally, in areas where noisy power transmission is present, you may choose to install a line filter to shield the computer from noise. It is recommended that you also install a power surge protector to help avoid problems caused by power surges.

 **Note:** To provide adequate power supply to the motherboard, be sure to connect the 8-pin PWR (JP5) and the 4-pin PWR connectors (JP3/JP4) to the power supply. Failure to do so might void the manufacturer warranty on your power supply and motherboard. It is strongly recommended

that you use a high quality power supply that meets ATX power supply Specification 2.02 or above.

1-7 Super I/O

The Super I/O provides functions that comply with ACPI (Advanced Configuration and Power Interface), which includes support of legacy and ACPI power management through an SMI or SCI function pin. It also features auto power management to reduce power consumption.



Note 1: For more information on IPMI configuration, please refer to the IPMI User's Guide posted on our website at <http://www.supermicro.com/support/manuals/>.

Note 2: The term "IPMI controller" and the term "BMC controller" can be used interchangeably in this section.

1-8 Advanced Power Management

The new advanced power management features supported by this motherboard include IPNM and ME. Please note that you will need to do following to use these two new features:

- Use a power supply that supports PMBus 1.1 or 1.2.
- Install the NMView software in your system. NMView is optional and can be purchased from Supermicro.

Intel[®] Intelligent Power Node Manager (IPNM)

The Intel[®] Intelligent Power Node Manager (IPNM) provides your system with real-time thermal control and power management for maximum energy efficiency. Although IPNM is supported by the BMC (Baseboard Management Controller), your system must also have IPNM-compatible Manageability Engine (ME) firmware installed in your system for IPNM support.



Note: Support for IPNM Specification Version 1.5 or Vision 2.0 depends on the power supply used in the system.

Manageability Engine (ME)

The Manageability Engine, which is an ARC controller embedded in the PCH, provides Server Platform Services (SPS) to your system. The services provided by SPS are different from those provided by the ME on client platforms.

1-9 Overview of the Nuvoton WPCM450 Controller



Note: The term "IPMI controller" and the term "BMC controller" can be used interchangeably in this section.

The Nuvoton WPCM450R Controller, a Baseboard Management Controller (BMC), supports 2D/VGA-compatible Graphic Cores with PCI interface, creating multi-media virtualization via Keyboard/Video/Mouse Redirection (KVMR). The WPCM450R Controller is ideal for remote system management.

The WPCM450R Controller interfaces with the host system via PCI connections to communicate with the graphics cores. It supports USB 2.0 and 1.1 for remote keyboard/mouse/virtual media emulation. It also provides LPC interface support to control Super IO functions. The WPCM450R Controller is connected to the network via an external Ethernet PHY module or shared NCSI connections.

The WPCM450R communicates with onboard components via six SMBus interfaces, PECE (Platform Environment Control Interface) buses, and General Purpose I/O ports.

WPCM450R DDR2 Memory Interface

The WPCM450R supports a 16-bit DDR2 memory module with a speed of up to 220 MHz. For best signal integrity, the WPCM450R provides point-to-point connection.

WPCM450R PCI System Interface

The WPCM450R provides 32-bit, 33 MHz 3.3V PCI interface, which is compliant with the PCI Local Bus Specification Rev. 2.3. The PCI system interface connects to the onboard PCI Bridge used by the graphics controller.

Other Features Supported by the WPCM BMC Controller

The WPCM450R supports the following features:

- IPMI 2.0
- Serial over LAN
- KVM over LAN
- LAN Alerting-SNMP Trap
- Event Log
- X-Bus parallel interface for I/O expansion

- Multiple ADC inputs, Analog and Digital Video outputs
- SPI Flash Host BIOS and firmware bootstrap program supported
- Reduced Media Independent Interface (RMII)
- OS (Operating System) Independency
- Provides remote Hardware Health Monitoring via IPMI. Key features
- Provides Network Management Security via remote access/console redirection.
- Supports the following Management tools: IPMIView, CLI (Command Line Interface)
- RMCP+ protocol supported



Note 1: For more information on IPMI configuration, please refer to the IPMI User's Guide posted on our website at <http://www.supermicro.com/support/manuals/>.

Note 2: The term "IPMI controller" and the term "BMC controller" can be used interchangeably in this section.

Chapter 2

Installation

2-1 Standardized Warning Statements

The following statements are industry-standard warnings provided to warn the user of situations when potential bodily injury may occur. Should you have questions or experience difficulty, contact Supermicro's Technical Support department for assistance. Only certified technicians should attempt to install or configure components.

Read this section in its entirety before installing or configuring components in the system.

Battery Handling



Warning! There is a danger of explosion if the battery is replaced incorrectly. Replace the battery only with the same or equivalent type recommended by the manufacturer. Dispose of used batteries according to the manufacturer's instructions. (Refer to Chapter 3 for more information on used battery disposal.)

警告

電池交換が正しく行われなかった場合、破裂の危険性があります。
交換する電池はメーカーが推奨する型、または同等のものを使用下さい。
使用済電池は製造元の指示に従って処分して下さい。

警告

電池更換不当会有爆炸危险，请只用同类电池或制造商推荐的功能相当的电池更换原有电池，请按制造商的说明处理废旧电池。

Warnung

Bei Einsetzen einer falschen Batterie besteht Explosionsgefahr. Ersetzen Sie die Batterie nur durch den gleichen oder vom Hersteller empfohlenen Batterietyp. Entsorgen Sie die benutzten Batterien nach den Anweisungen des Herstellers.

¡Advertencia!

Existe peligro de explosión si la batería se reemplaza de manera incorrecta. Reemplazar la batería exclusivamente con el mismo tipo o el equivalente recomendado por el fabricante. Desechar las baterías gastadas según las instrucciones del fabricante.

Attention

Danger d'explosion si la pile n'est pas remplacée correctement. Ne la remplacer que par une pile de type semblable ou équivalent, recommandée par le fabricant. Jeter les piles usagées conformément aux instructions du fabricant.

תקנת הצהרות אזהרה

הצהרות הבאות הן אזהרות על פי תקני התעשייה, על מנת להזהיר את המשתמש מפני חבלה פיזית אפשרית. במידה ויש שאלות או היתקלות בבעיה כלשהי, יש ליצור קשר עם מחלקת תמיכה טכנית של סופרמיקרו. טכנאים מוסמכים בלבד רשאים להתקין או להגדיר את הרכיבים.

יש לקרוא את הנספח במלואו לפני התקנת או הגדרת הרכיבים במארזי סופרמיקרו.

تعليمات

كيلي عفا حيا حص ريغ ققيرطب ةيراطبلا لادبتسا ةلاح يف راجفنا نم رطخ كانه ةيراطبلا لادبتسا

ةعنصل ةكرشلا هب تصوا امك اهلداعي ام وا عونلا س فنب طقف

ةعنصل ةكرشلا تاميلعتل اقفو ةلمعتسمل تاي راطبلا نم صلخت

주의

건전지가 부정확하게 대체되는 경우에 폭발의 위험이 있다. 제조자에 의해 추천된 동일한 것 또는 동등한 유형으로서만 건전지를 교환하십시오. 제조자 지시에 따라 사용한 건전지를 처분하십시오

Waarschuwing

Er is ontploffingsgevaar indien de batterij verkeerd vervangen wordt. Vervang de batterij slechts met hetzelfde of een equivalent type die door de fabrikant aanbevolen wordt. Gebruikte batterijen dienen overeenkomstig fabrieksvoorschriften afgevoerd te worden.

Product Disposal



Warning! Ultimate disposal of this product should be handled according to all national laws and regulations.

警告

本产品的废弃处理应根据所有国家的法律和规章进行。

警告

この製品を廃棄処分する際は、各国の法律および規制に従って取り扱ってください。

Warnung

Die Entsorgung dieses Produkts sollte gemäß allen Bestimmungen und Gesetzen des Landes erfolgen.

¡Advertencia!

Al deshacerse por completo de este producto debe seguir todas las leyes y reglamentos nacionales.

Attention

La mise au rebut ou le recyclage de ce produit sont généralement soumis à des lois et/ou directives de respect de l'environnement. Renseignez-vous auprès de l'organisme compétent.

אזהרה!

קיימת סכנת פיצוץ של הסוללה במידה והוחלפה בדרך לא תקינה. יש להחליף את הסוללה בסוג התואם מחברת יצרן מומלצת.

סילוק הסוללות המשומשות יש לבצע לפי הוראות היצרן.

تحذير

نبي ن اوقلا عي مجل اقفو ه عم لم اعل ا يغبني جتنملا اذه نم يئاهنلا صلختلا دن ع ةين طول ا حئ اوللاو

주의

해당 국가의 관련 법규 및 규정에 따라 이 장치를 폐기해야 합니다.

Waarschuwing

De uiteindelijke verwijdering van dit product dient te geschieden in overeenstemming met alle nationale wetten en reglementen.

2-2 Static-Sensitive Devices

Electrostatic Discharge (ESD) can damage electronic components. To avoid damaging your system board, it is important to handle it very carefully. The following measures are generally sufficient to protect your equipment from ESD.

Precautions

- Use a grounded wrist strap designed to prevent static discharge.
- Touch a grounded metal object before removing the board from the antistatic bag.
- Handle the board by its edges only; do not touch its components, peripheral chips, memory modules or gold contacts.
- When handling chips or modules, avoid touching their pins.
- Put the motherboard and peripherals back into their antistatic bags when not in use.
- For grounding purposes, make sure that your system chassis provides excellent conductivity between the power supply, the case, the mounting fasteners and the motherboard.

Unpacking

The motherboard is shipped in antistatic packaging to avoid static damage. When unpacking the board, make sure that the person handling it is static protected.

2-3 Processor and Heatsink Installation

Warning: When handling the processor package, avoid placing direct pressure on the label area.

 **Notes:**

Always connect the power cord last, and always remove it before adding, removing or changing any hardware components. Make sure that you install the processor into the CPU socket before you install the CPU heatsink.

If you buy a CPU separately, make sure that you use an Intel-certified multi-directional heatsink only.

Make sure to install the system board into the chassis before you install the CPU heatsink.

When receiving a server board without a processor pre-installed, make sure that the plastic CPU socket cap is in place and none of the socket pins are bent; otherwise, contact your retailer immediately.

Refer to the Supermicro website for updates on CPU support.

Installing the LGA2011 Processor

1. There are two load levers on the LGA2011 socket. To open the socket cover, first press and release the load lever labeled 'Open 1st'.

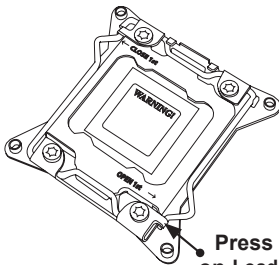
1

Press down
on Load Lever
labeled 'Open 1st'.

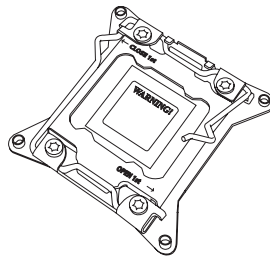
2

2. Press the second load lever labeled 'Close 1st' to release the load plate that covers the CPU socket from its locking position.

1

Press down on Load the Lever labeled 'Close 1st'

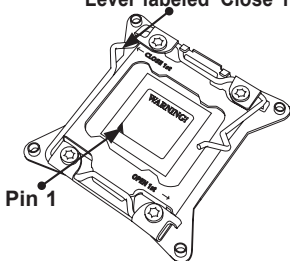

2

Pull lever away from the socket

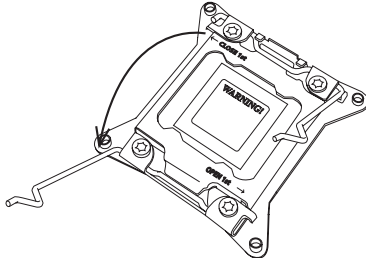

3. With the lever labeled 'Close 1st' fully retracted, gently push down on the 'Open 1st' lever to open the load plate. Lift the load plate to open it completely.

1

Gently push down to pop the load plate open.

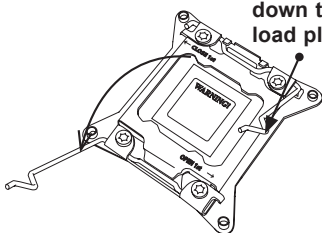

2

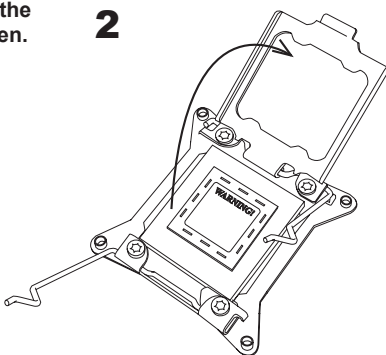

1. Using your thumb and the index finger, remove the 'WARNING' plastic cap from the socket.

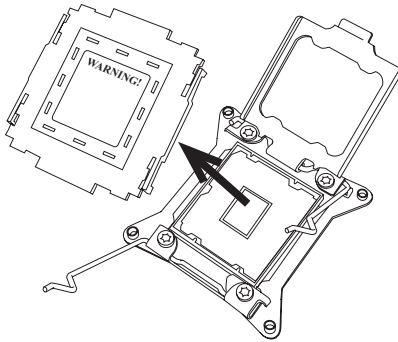

2. Use your thumb and index finger to hold the CPU on its edges. Align the CPU keys, which are semi-circle cutouts, against the socket keys.

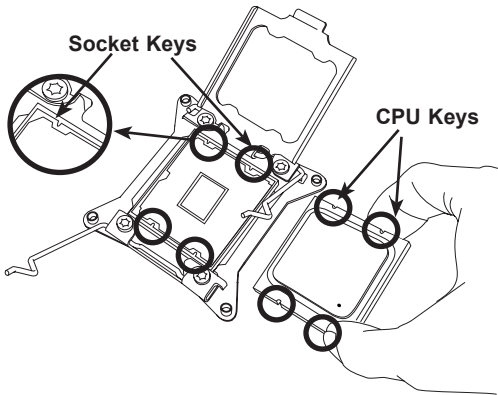

3. Once they are aligned, carefully lower the CPU straight down into the socket. (Do not drop the CPU on the socket. Do not move the CPU horizontally or vertically. Do not rub the CPU against the surface or against any pins of the socket to avoid damaging the CPU or the socket.)

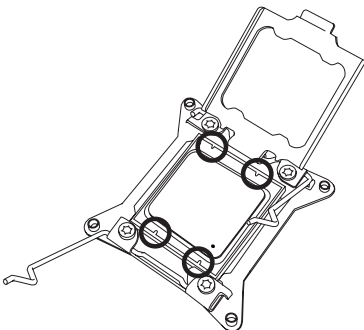

Warning: You can only install the CPU inside the socket in one direction. Make sure that it is properly inserted into the CPU socket before closing the load plate. If it doesn't close properly, do not force it as it may damage your CPU. Instead, open the load plate again and double-check that the CPU is aligned properly.

4. With the CPU inside the socket, inspect the four corners of the CPU to make sure that the CPU is properly installed.
5. Close the load plate with the CPU inside the socket. Lock the lever labeled 'Close 1st' first, then lock the lever labeled 'Open 1st' second. Use your thumb to gently push the load levers down to the lever locks.

1

Gently close the load plate.

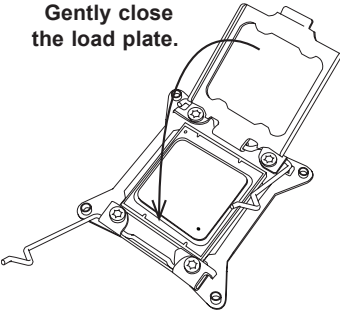

2

Push down and lock the level labeled 'Close 1st'.

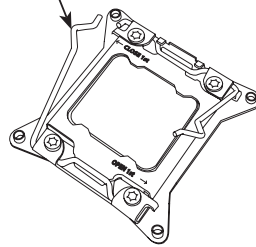

3

Lever Lock

Push down and lock the lever labeled 'Open 1st'

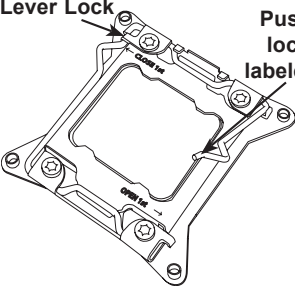

4

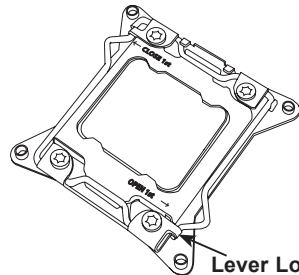

Installing a Passive CPU Heatsink

1. Do not apply any thermal grease to the heatsink or the CPU die -- the required amount has already been applied.
2. Place the heatsink on top of the CPU so that the four mounting holes are aligned with those on the Motherboard's and the Heatsink Bracket underneath.
3. Screw in two diagonal screws (i.e., the #1 and the #2 screws) until just snug (-do not over-tighten the screws to avoid possible damage to the CPU.)
4. Finish the installation by fully tightening all four screws.

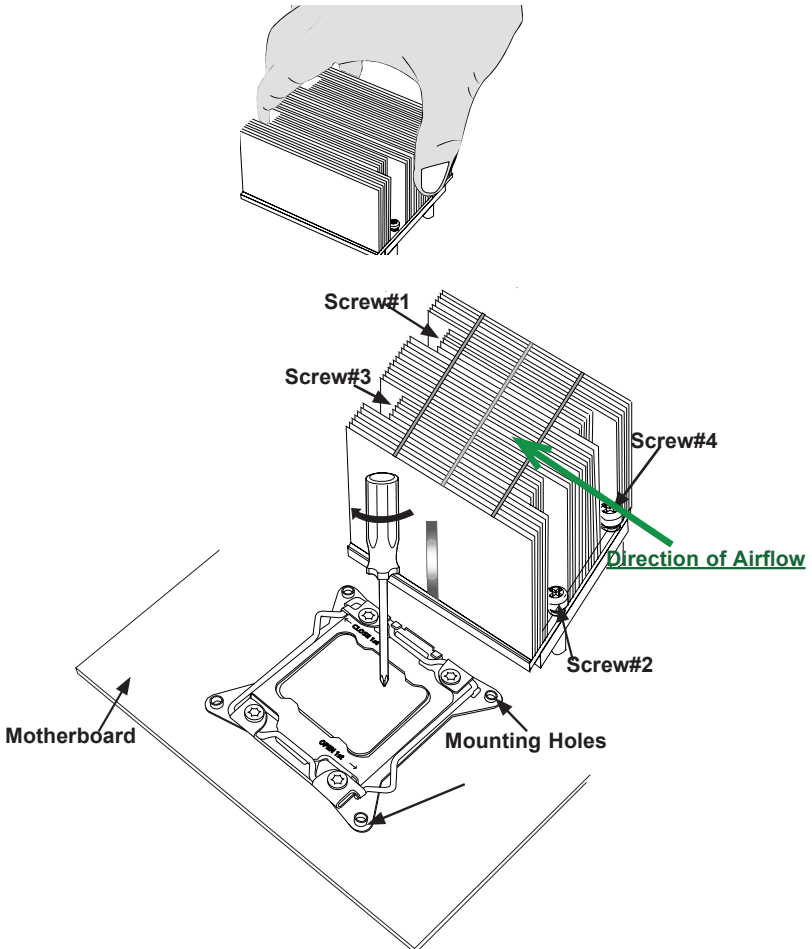

Removing the Heatsink

Warning: We do not recommend that the CPU or the heatsink be removed. However, if you do need to uninstall the heatsink, please follow the instructions below to avoid damaging the CPU or the CPU socket.

1. Unscrew the heatsink screws from the motherboard in the sequence as shown in the illustration below.
2. Gently wriggle the heatsink to loosen it from the CPU. (Do not use excessive force when wriggling the heatsink!)
3. Once the CPU is loosened from the heatsink, remove the CPU from the CPU socket.
4. Remove the used thermal grease and clean the surface of the CPU and the heatsink, Reapply the proper amount of thermal grease on the surface before reinstalling the CPU and the heatsink.

Loosen screws
in sequence as
shown.

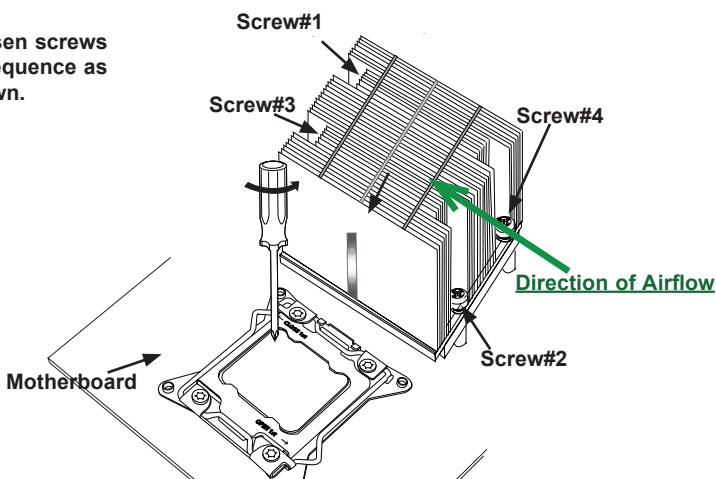

⚠ Do not reuse thermal grease!

2-4 Installing and Removing the Memory Modules

Note: Check Supermicro's Website for recommended memory modules.

CAUTION

Exercise extreme care when installing or removing DIMM modules to prevent any possible damage.

Installing & Removing DIMMs

1. Insert the desired number of DIMMs into the memory slots, starting with P1-DIMM #1A. (For best performance, please use the memory modules of the same type and speed in the same bank.)
2. Push the release tabs outwards on both ends of the DIMM slot to unlock it.

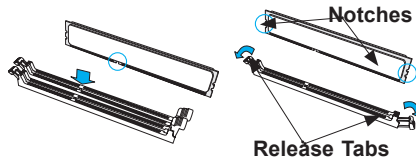
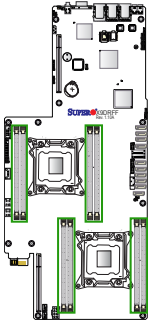

3. Align the key of the DIMM module with the receptive point on the memory slot.
4. Align the notches on both ends of the module against the receptive points on the ends of the slot.
5. Use two thumbs together to press the notches on both ends of the module straight down into the slot until the module snaps into place.
6. Press the release tabs to the locking positions to secure the DIMM module into the slot.

Press both notches straight down into the memory slot at the same time.

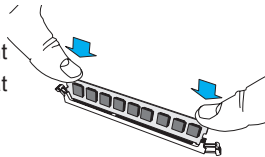

Removing Memory Modules

Press both notches at the ends of a DIMM module to unlock it. Once it is loosened, remove the DIMM module from the motherboard.

Memory Support for the X9DRFF(-7) Motherboard

The X9DRFF(-7) Motherboard supports up to 256 GB of 240-pin Registered (RDIMM)/Load Reduced (LRDIMM) ECC or up to 64 GB of Unbuffered (UDIMM) ECC/Non-ECC DDR3 800/1066/1333/1600 MHz memory in 4-channel (per CPU) 8 DIMM slots.

Note: For the latest CPU/memory updates, please refer to our website at <http://www.supermicro.com/products/motherboard>.

Processor & Memory Module Population Configuration

For memory to work properly, follow the tables below for memory installation.

Processors and their Corresponding Memory Modules				
CPU#	Corresponding DIMM Modules			
CPU 1	P1-A1	P1-B1	P1-C1	P1-D1
CPU2	P2-E1	P2-F1	P2-G1	P2-H1

Processor and Memory Module Population	
Number of CPUs+DIMMs	CPU and Memory Population Configuration Table (For memory to work properly, please install DIMMs in the sequence as specified)
1 CPU & 2 DIMMs	CPU1 P1-A1/P1-B1
1 CPU & 4 DIMMs	CPU1 P1-A1/P1-B1, P1-C1/P1-D1
2 CPUs & 4 DIMMs	CPU1 + CPU2 P1-A1/P1-B1, P2-E1/P2-F1
2 CPUs & 6 DIMMs	CPU1 + CPU2 P1-A1/P1-B1/P1-C1/P1-D1, P2-E1/P2-F1
2 CPUs & 8 DIMMs	CPU1 + CPU2 P1-A1/P1-B1/P1-C1/P1-D1, P2-E1/P2-F1/P2-G1/P2-H1

Installing UDIMM (ECC/Non-ECC) Memory

Intel E5-2600 Series Processor UDIMM Memory Support					
Ranks Per DIMM & Data Width	Memory Capacity Per DIMM (See the Note below)			Speed (MT/s) and Voltage Validated by Slot per Channel (SPC) and DIMM Per Channel (DPC)	
				1.35V	1.5V
SRx8 Non-ECC	1GB	2GB	4GB	NA	1066, 1333, 1600
DRx8 Non-ECC	2GB	4GB	8GB	NA	1066, 1333, 1600
SRx16 Non-ECC	512MB	1GB	2GB	NA	1066, 1333, 1600
SRx8 ECC	1GB	2GB	4GB	1066, 1333	1066, 1333, 1600
DRx8 ECC	2GB	4GB	8GB	1066, 1333	1066, 1333, 1600

Note: For detailed information on memory support and updates, please refer to the SMC Recommended Memory List posted on our website at <http://www.supermicro.com/support/resources/mem.cfm>.

Installing RDIMM (ECC) Memory

Intel E5-2600 Series Processor RDIMM Memory Support					
Ranks Per DIMM & Data Width	Memory Capacity Per DIMM (See the Note Below)			Speed (MT/s) and Voltage Validated by Slot per Channel (SPC) and DIMM Per Channel (DPC)	
				1DPC	
				1.35V	1.5V
SRx8	1GB	2GB	4GB	1066, 1333	1066, 1333, 1600
DRx8	2GB	4GB	8GB	1066, 1333	1066, 1333, 1600
SRx4	2GB	4GB	8GB	1066, 1333	1066, 1333, 1600
DRx4	4GB	8GB	16GB	1066, 1333	1066, 1333, 1600
QRx4	8GB	16GB	32GB	800	1066
QRx8	4GB	8GB	16GB	800	1066

Note: For detailed information on memory support and updates, please refer to the SMC Recommended Memory List posted on our website at <http://www.supermicro.com/support/resources/mem.cfm>.

Intel E5-2600 Series Processor LRDIMM Memory Support				
Ranks Per DIMM & Data Width (See the Note Below)	Memory Capacity Per DIMM		Speed (MT/s) and Voltage Validated by Slot per Channel (SPC) and DIMM Per Channel (DPC)	
			1.35V	1.5V
QRx4 (DDP)	16GB	32GB	1066, 1333	1066, 1333
QRx8 (P)	8GB	16GB	1066, 1333	1066,1333
Note: For detailed information on memory support and updates, please refer to the SMC Recommended Memory List posted on our website at http://www.supermicro.com/support/resources/mem.cfm .				

Other Important Notes and Restrictions

- For the memory modules to work properly, please install DIMM modules of the same type, same speed and same operating frequency on the motherboard. Mixing of RDIMMs, UDIMMs or LRDIMMs is not allowed. Do not install both ECC and Non-ECC memory modules on the same motherboard.
- Using DDR3 DIMMs with different operating frequencies is not allowed. All channels in a system will run at the lowest common frequency.

2-5 Motherboard Installation

All motherboards have standard mounting holes to fit different types of chassis. Make sure that the locations of all the mounting holes for both motherboard and chassis match. Although a chassis may have both plastic and metal mounting fasteners, metal ones are highly recommended because they ground the motherboard to the chassis. Make sure that the metal standoffs click in or are screwed in tightly. Then use a screwdriver to secure the motherboard onto the motherboard tray.

Tools Needed

- Phillips Screwdriver
- Pan head screws (11 pieces)
- Standoffs (11 pieces, if needed)

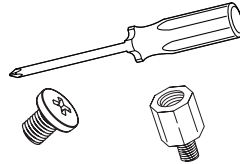

Location of Mounting Holes

There are eleven (11) mounting holes on this motherboard indicated by the arrows.

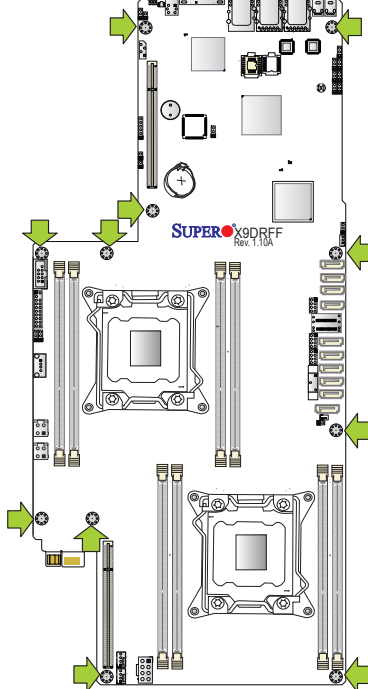

Warning: 1) To avoid damaging the motherboard and its components, please do not use a force greater than 8 lb/inch on each mounting screw during motherboard installation. 2) Some components are very close to the mounting holes. Please take precautionary measures to prevent damage to these components when installing the motherboard to the chassis.

Installing the Motherboard

1. Install the I/O shield into the chassis.

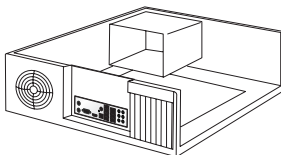

2. Locate the mounting holes on the motherboard.
3. Locate the matching mounting holes on the chassis. Align the mounting holes on the motherboard against the mounting holes on the chassis.
4. Install standoffs in the chassis as needed.

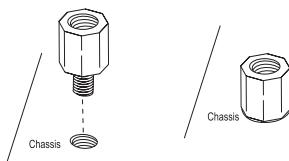

5. Install the motherboard into the chassis carefully to avoid damaging motherboard components.
6. Using the Phillips screwdriver, insert a Pan head #6 screw into a mounting hole on the motherboard and its matching mounting hole on the chassis.

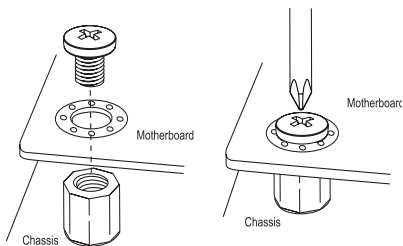

7. Repeat Step 5 to insert #6 screws into all mounting holes.
8. Make sure that the motherboard is securely placed in the chassis.

 **Note:** Images displayed are is for illustration only. Your chassis or components might look different from those shown in this manual.

2-6 Control Panel Connectors and I/O Ports

The I/O ports are color coded in conformance with the PC 99 specification. See the picture below for the colors and locations of the various I/O ports.

Control Panel I/O Connectors and Ports

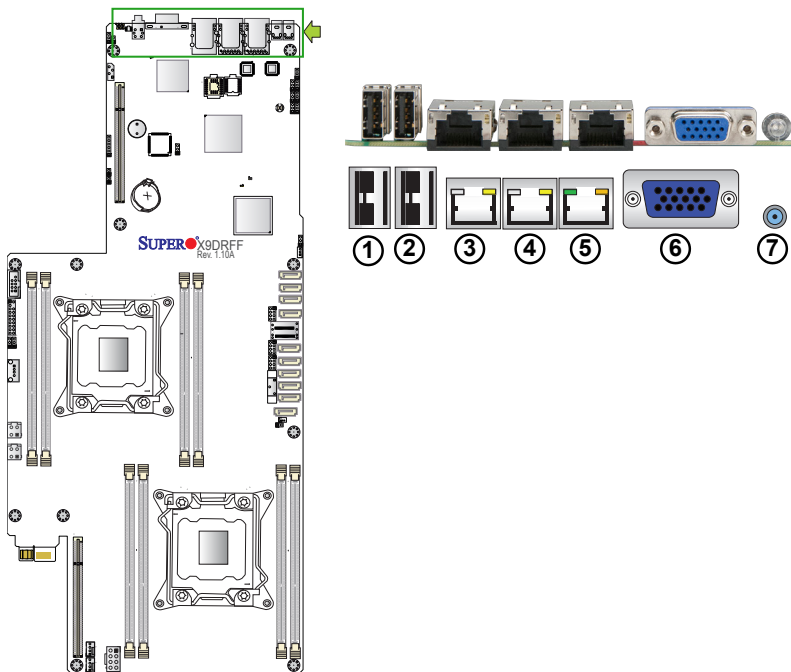

Control Panel I/O Port Locations and Definitions

Control Panel I/O Ports
1. Control Panel USB Port 1
2. Control Panel USB Port 2
3. Gigabit LAN 1
4. Gigabit LAN 2
5. IPMI LAN
6. VGA
7. Power Switch/LED Indicator

Universal Serial Bus (USB)

Two Universal Serial Bus ports (USB0, USB1), located on the I/O Control Panel, provides rear USB support. In addition, USB2, located next to the 4-pin power connectors (JP3/JP4), provides front USB support. (USB Cables are not included). See the tables on the right for pin definitions.

Control Panel USB 0/1 & FP USB 2 Pin Definitions	
Pin#	Definition
1	+5V
2	PO-
3	PO+
4	Ground

Video Connection

A Video (VGA) port is located next to the IPMI LAN port on the I/O Control Panel. Refer to the board layout below for the location.

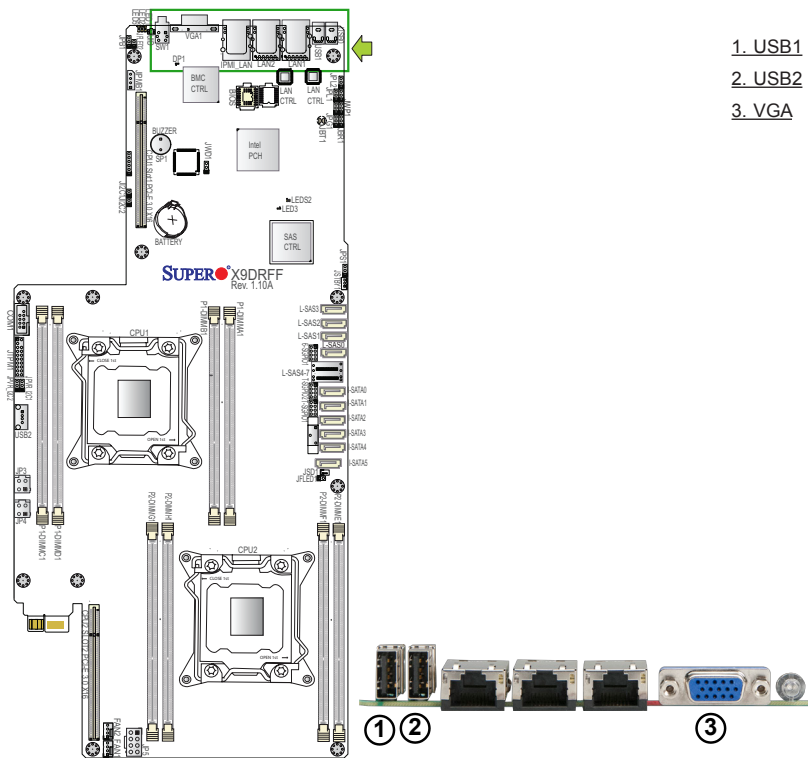

- 1. USB1
- 2. USB2
- 3. VGA

Ethernet Ports

Two Gigabit Ethernet ports (LAN1, LAN2) are located on the I/O Control Panel on the motherboard. In addition, an IPMI LAN is also on the Control Panel. All these ports accept RJ45 type cables. Please refer to the

LAN Ports Pin Definition			
Pin#	Definition		
1	P2V5SB	10	SGND
2	TD0+	11	Act LED
3	TD0-	12	P3V3SB
4	TD1+	13	Link 100 LED (Yellow, +3V3SB)
5	TD1-	14	Link 1000 LED (Yellow, +3V3SB)
6	TD2+	15	Ground
7	TD2-	16	Ground
8	TD3+	17	Ground
9	TD3-	18	Ground

Serial Port

A serial port (COM1) is located next to the P1-DIMMC1 memory slot on the motherboard. This connection provides serial connection support. See the table on the right for pin definitions.

Serial Port (COM1) Pin Definitions			
Pin #	Definition	Pin #	Definition
1	DCD	6	DSR
2	RXD	7	RTS
3	TXD	8	CTS
4	DTR	9	RI
5	Ground	10	N/A

1. LAN1
2. LAN2
3. IPMI LAN
4. COM1

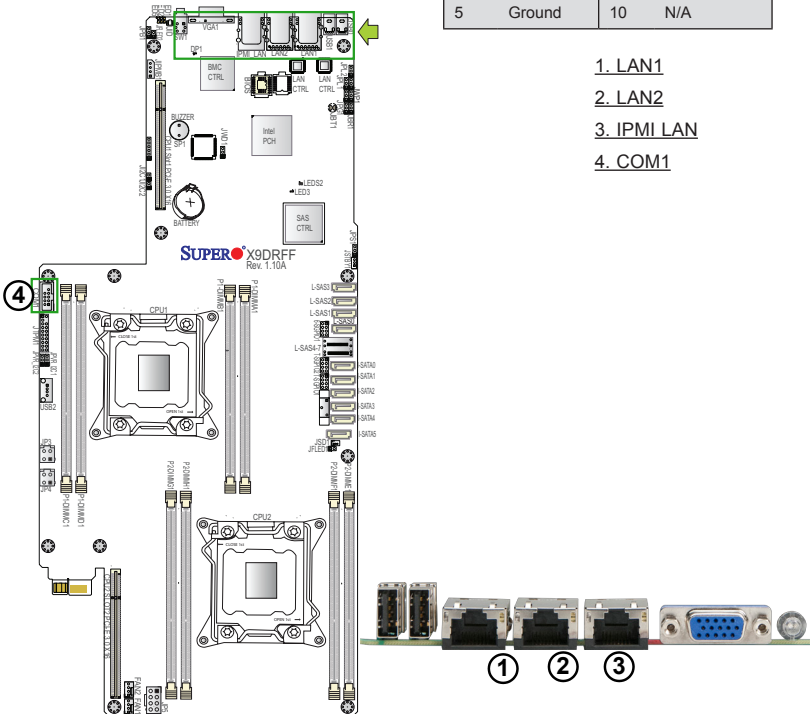

Power Switch/LED Indicator

An integrated power switch/LED indicator is located at SW1 on the motherboard. Press the switch to turn on or turn off onboard power supply. See the table on the right for pin definitions.

Power Switch/LED	
Pin#	Definition
1	Ground
2	Ground
3	Button In
4	Ground

Unit Identifier Button/LED Indicator

A Unit Identifier button (JUIDB1) and a LED indicator are located on the motherboard. The UID button is located next to the Power Switch/LED (SW1). Next to the UID button (JUIDB1) is the UID LED indicator (LED1). When you use a pointed tool to press the UID button (JUIDB1), the UID LED (LED1) indicator will be turned on. Press the UID button again to turn it off. Both UID button (JUIDB1) and UID LED indicator (LED1) are used to identify a unit that may be in need of service.

 **Note:** UID can also be triggered via IPMI on the motherboard. For more information on IPMI, please refer to the IPMI User's Guide posted on our Website @<http://www.supermicro.com>.

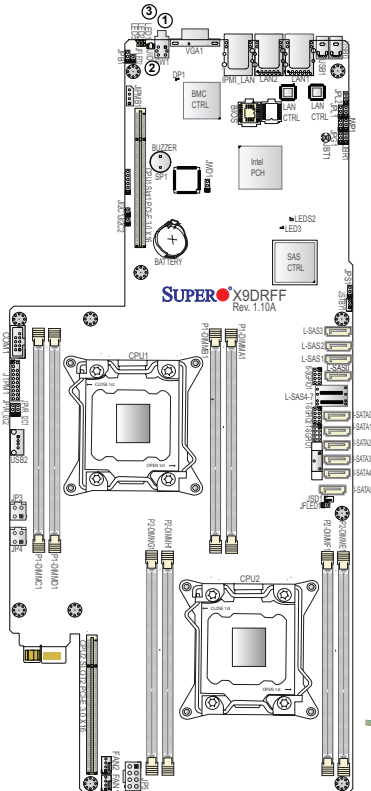

UID LED Status		
Color/State	OS	Status
Blue: On	Windows OS	Unit Identified
Blue: Blinking	Linux OS	Unit Identified

1. Power Switch (SW1)
2. UID Button (JUIDB1)
3. LED1



2-7 Connecting Cables

An 8-pin power connector (JP5) and two 4-pin power connectors (JP3/JP4) are located on the motherboard. These power connectors meet the SSI EPS 12V specification. To provide adequate power to your system, connect these power connectors to your power supply. See the table on the right for pin definitions.

Standby Power

The Standby Power header is located at JSTBY1 on the motherboard. See the layout below for the location.

12V 8-pin PWR Pin Definitions		12V 4-pin PWR Pin Definitions	
Pins	Definition	Pins	Definition
1-4	Ground	1/2	Ground
5-8	+12V	3/4	+12V

Required

Standby Power Pin Definitions	
Pin#	Definition
1	+5V Standby
2	Ground
3	Wake-up

A. JP5 (8-pin Power Connector)

B. JP3 (4-pin Power Connector)

C. JP4 (4-pin Power Connector)

D. Standby Power Header

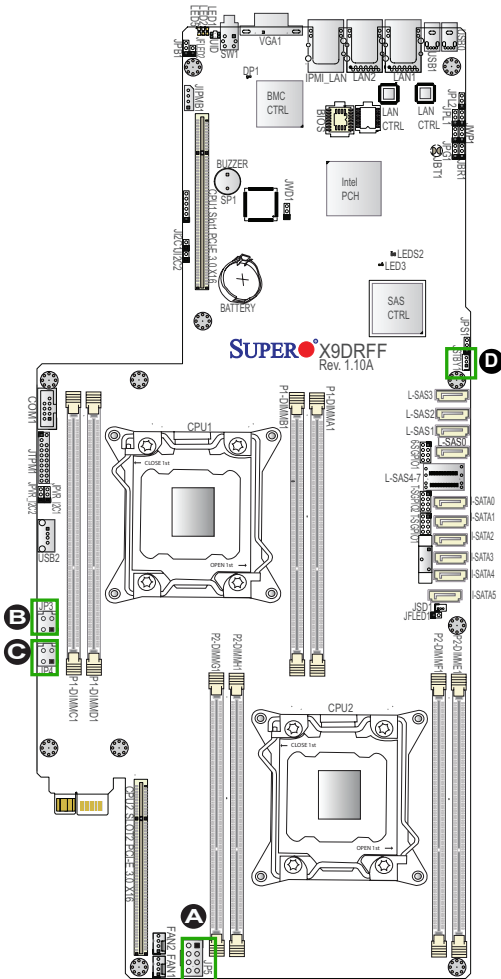

Fan Headers

This motherboard has two system/CPU fan headers (Fan1/Fan2) on the motherboard. These 4-pin fan headers are backward compatible with the traditional 3-pin fans. The fan speeds are controlled via firmware management via IPMI interface. See the table on the right for pin definitions.

Fan Header Pin Definitions	
Pin#	Definition
1	Ground
2	+12V
3	Tachometer
4	PWR Modulation (Available for 4-pin fans only)

TPM Header/Port 80

A Trusted Platform Module/Port 80 header is located at JTPM1 to provide TPM support and Port 80 connection. Use this header to enhance system performance and data security. See the table on the right for pin definitions.

TPM/Port 80 Header Pin Definitions			
Pin #	Definition	Pin #	Definition
1	LCLK	2	GND
3	LFRAME#	4	<(KEY)>
5	LRESET#	6	+5V (X)
7	LAD 3	8	LAD 2
9	+3.3V	10	LAD1
11	LAD0	12	GND
13	SMB_CLK4	14	SMB_DAT4
15	+3V_DUAL	16	SERIRQ
17	GND	18	CLKRUN# (X)
19	LPCPD#	20	LDRQ# (X)

A. Fan 1

B. Fan 2

C. TPM/Port 80

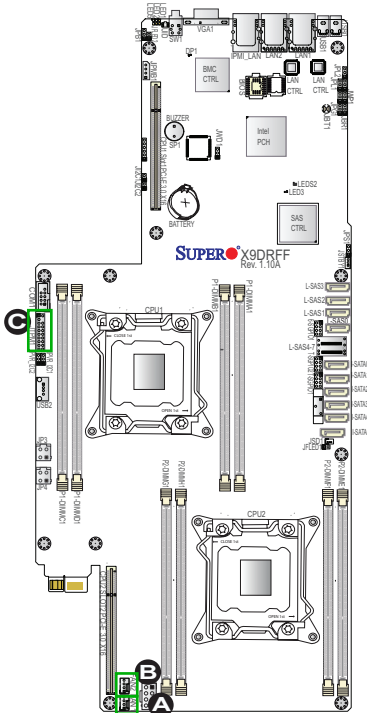

IPMB

A System Management Bus header for IPMI 2.0 is located at JIPMB1. Connect the appropriate cable here to use the IPMB I²C connection on your system.

IPMB Header Pin Definitions	
Pin#	Definition
1	Data
2	Ground
3	Clock
4	No Connection

SATA Device Power Connector

A power connector for SATA DOM (Disk_On_Module) devices is located at JSD1. Connect an appropriate cable here to provide power support for your SATA DOM devices.

DOM PWR Pin Definitions	
Pin#	Definition
1	+5V
2	Ground
3	Ground

- A. IPMB
B. DOM PWR

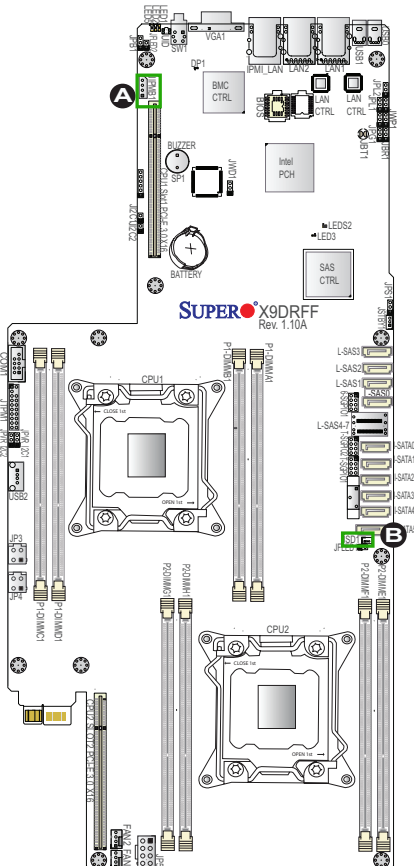

T-SGPIO1/2 & 6-SGPIO1 Headers

Two SGPIO (Serial-Link General Purpose Input/Output) headers are located on the motherboard. In addition, a 6-SGPIO1 is located on X9DRFF-7 motherboard. These headers support onboard Serial_Link interface connections.

 **Note:** T-SGPIO 1/2 support onboard SATA connections. 6-SGPIO1 supports SAS interface for X9DRFF-7.

T-SGPIO/6-SGPIO Pin Definitions			
Pin#	Definition	Pin	Definition
2	NC	1	NC
4	Ground	3	Data
6	Load	5	Ground
8	Clock	7	NC

Note: NC= No Connection

Power Connector Header for Failed System LED Header

A power connector for the Failed System LED is located at JFLED1. Connect an appropriate cable here to provide power from an external battery to the Failed System LED used to identify a failed system. See the table on the right for pin definitions.

PWR Connector for Failed System LED Pin Definitions	
Pin#	Definition
1	+3V Input
2	Ground

- A. T-SGPIO1
- B. T-SGPIO2
- C. 6-SGPIO1 (for X9DRFF-7 only)
- D. PWR Connector to Failed System LED

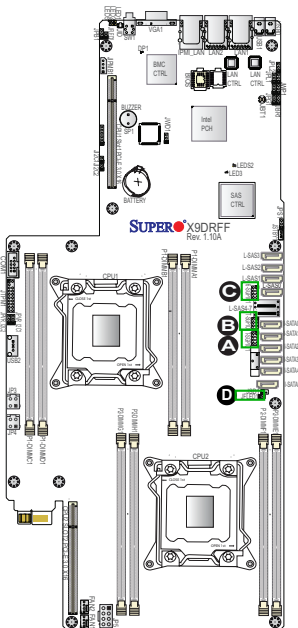

2-8 Jumper Settings

Explanation of Jumpers

To modify the operation of the motherboard, jumpers can be used to choose between optional settings. Jumpers create shorts between two pins to change the function of the connector. Pin 1 is identified with a square solder pad on the printed circuit board. See the motherboard layout pages for jumper locations.

 **Note:** On two pin jumpers, "Closed" means the jumper is on and "Open" means the jumper is off the pins.

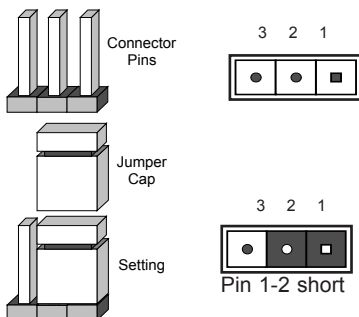

GLAN Enable/Disable

JPL1/JPL2 enable or disable the LAN Port1/LAN Port2 on the motherboard. See the table on the right for jumper settings. The default setting is Enabled.

LAN Enable Jumper Settings	
Jumper Setting	Definition
1-2	Enabled (default)
2-3	Disabled

- A. GLAN1 Enable
- B. GLAN2 Enable

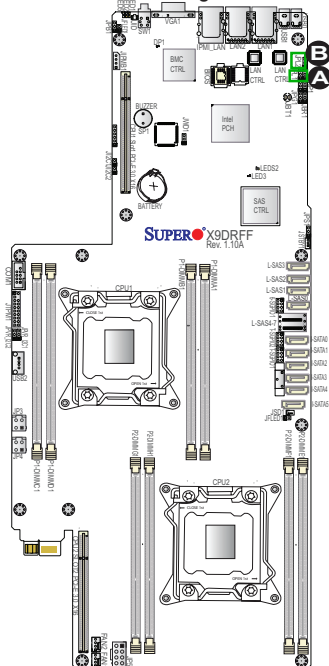

CMOS Clear

JBT1 is used to clear CMOS. Instead of pins, this "jumper" consists of contact pads to prevent accidental clearing of CMOS. To clear CMOS, use a metal object such as a small screwdriver to touch both pads at the same time to short the connection. Always remove the AC power cord from the system before clearing CMOS. ⌚

 **Note 1.** For an ATX power supply, you must completely shut down the system, remove the AC power cord, and then short JBT1 to clear CMOS.

Note 2. Be sure to remove the onboard CMOS Battery before you short JBT1 to clear CMOS.

Note 3. Clearing CMOS will also clear all passwords.

Watch Dog Enable/Disable

Watch Dog (JWD1) is a system monitor that will reboot the system when a software application hangs. Close Pins 1-2 to reset the system if an application hangs. Close Pins 2-3 to generate a non-maskable interrupt signal for the application that hangs. See the table on the right for jumper settings. Watch Dog must also be enabled in the BIOS.

Watch Dog Jumper Settings	
Jumper Setting	Definition
Pins 1-2	Reset (default)
Pins 2-3	NMI
Open	Disabled

A. Clear CMOS

B. Watch Dog Enable

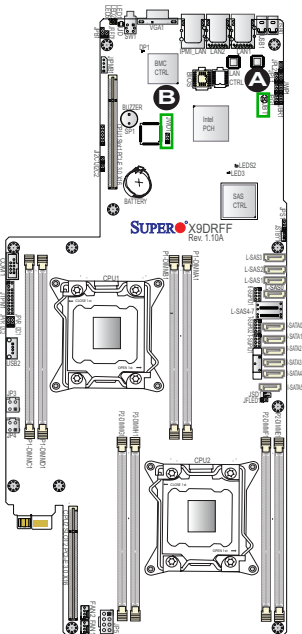

VGA Enable

Jumper JPG1 allows the user to enable the onboard VGA connector. The default setting is 1-2 to enable the connection. See the table on the right for jumper settings.

VGA Enable Jumper Settings	
Jumper Setting	Definition
1-2	Enabled (Default)
2-3	Disabled

BMC Enable

Jumper JPB1 allows you to enable the embedded BMC (Baseboard Management) Controller to provide IPMI 2.0/ KVM support on the motherboard. See the table on the right for jumper settings.

BMC Enable Jumper Settings	
Jumper Setting	Definition
Pins 1-2	BMC Enable
Pins 2-3	Normal (Default)

A. VGA Enabled
B. BMC Enabled

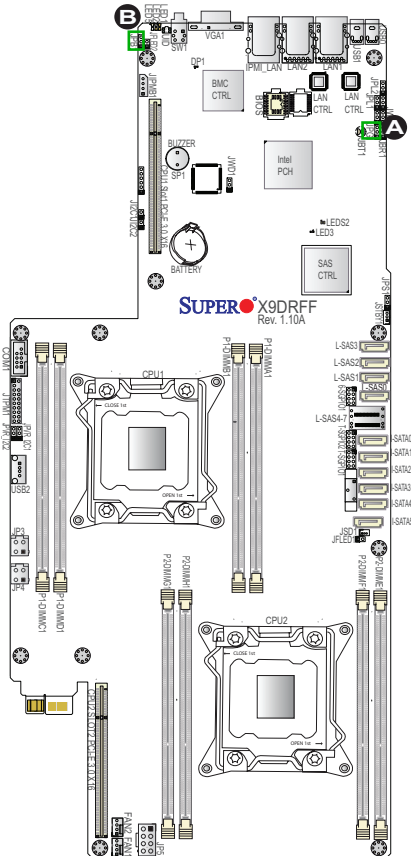

I²C Bus to PCI-Exp. Slots

Jumpers JI²C1 and JI²C2 allow you to connect the System Management Bus (I²C) to PCI-Express slots. The default setting is Open to disable the connection. See the table on the right for jumper settings.

I ² C to PCI-Exp Jumper Settings	
Jumper Setting	Definition
Closed	Enabled
Open	Disabled (Default)

SAS Enable (X9DRFF-7 Only)

JPS1 allows the user to enable SAS support to enhance system performance. See the table on the right for jumper settings. The default setting is enabled.

SAS Support Enable Jumper Settings	
Jumper Setting	Definition
Pins 1/2	SAS Enabled (Default)
Pins 2/3	SAS Disabled

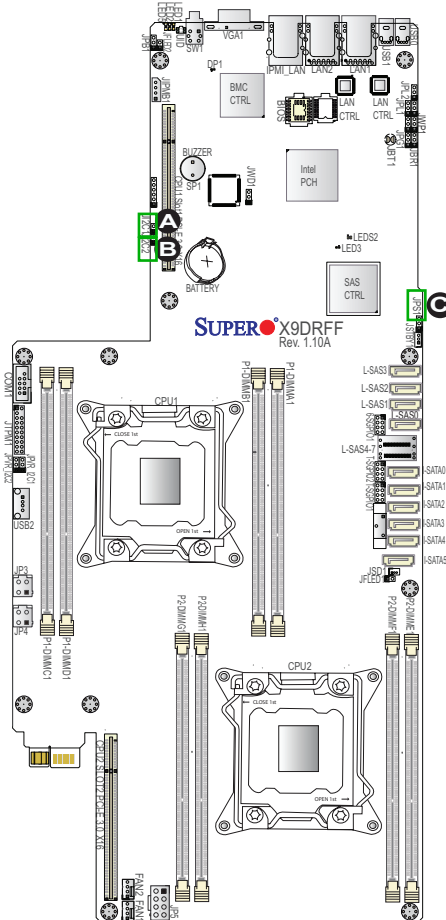

- A. JI²C1
- B. JI²C2
- C. SAS Enable

Failed System LED Enable

Use the jumper JFLED2 to enable Failed System LED to indicate a system that has failed. See the table on the right for jumper settings. The default setting is Closed to disable the jumper.

Failed System LED Enable Jumper Settings	
Jumper Setting	Definition
Open	Enabled
Closed	Disabled (Default)

A. Failed System LED Enable

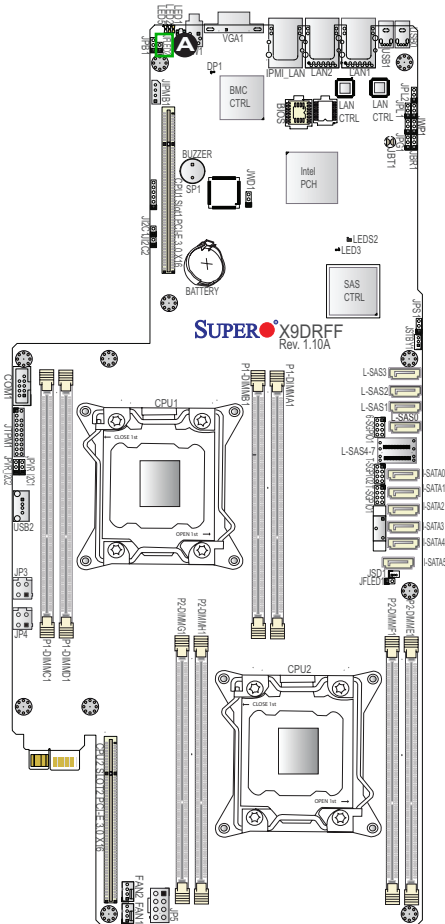

2-9 Onboard LED Indicators

GLAN LEDs

There are two GLAN ports (JLAN1/2) on the motherboard. Each Ethernet LAN port has two LEDs. The Yellow LED on the right indicates connection and activity. The Link LED on the left side may be green, amber or off to indicate the speed of the connection. See the tables at right for more information.



Rear View (when facing the rear side of the chassis)

GLAN Activity Indicator (Right) LED Settings		
Color	Status	Definition
Off	No Connections	
Yellow	Flashing	Active

GLAN Link LED Settings (Left)	
LED Color	Definition
Off	No Connection, 10 Mbps
Green	100 Mbps
Amber	1 Gbps

IPMI Dedicated LAN LEDs

In addition to GLAN 1/2, an IPMI Dedicated LAN is also located on the I/O Control Panel. The amber LED on the right indicates connection and activity, while the green LED on the left indicates the speed of the connection. See the tables at right for more information.

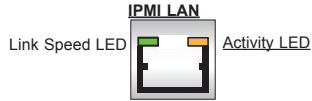

IPMI LAN Link Speed LED (Left) & Connection Activity LED (Right)		
LED	Color/State	Definition
Off	Off	No Connection
Activity	Amber: Blinking	Active
Speed	Green: Solid	100 Mbps

- A. LAN1/2 LEDs
- B. IPMI LAN LEDs

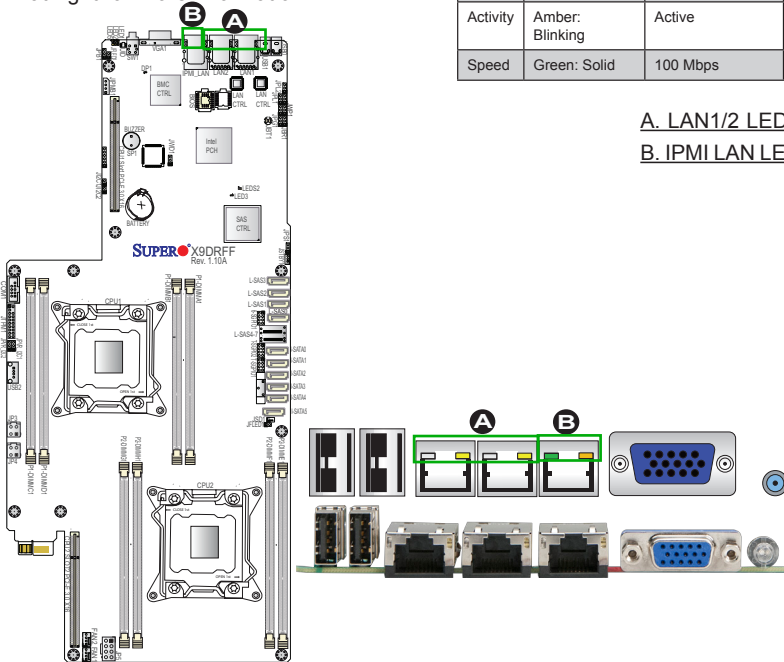

SAS Activity LED (X9DRFF-7 Only)

A SAS Activity LED is located at LED3 on the motherboard. When LED3 is blinking, SAS is active and working properly. See the table at right for more information.

SAS Activity LED Status	
Color/State	Definition
Green: Blinking	SAS: Active

SAS Heartbeat LED (X9DRFF-7 Only)

A SAS Heartbeat LED is located at LED2 on the motherboard. When LED2 is green, SAS is working properly. When LED2 turns red, it indicates SAS failure. See the table at right for more information.

SAS Heartbeat LED Status	
Color/State	Definition
Green	SAS: Normal
Red	SAS: Failed

- A. SAS Activity LED
- B. SAS Heartbeat LED

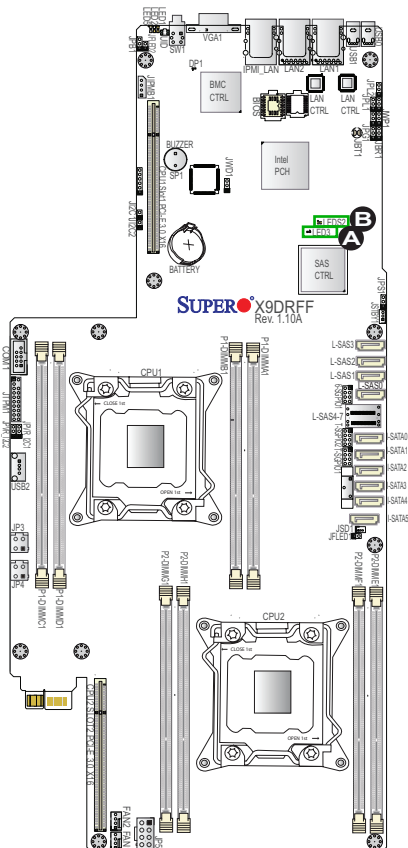

PWR Fail/Fan Fail/OH (Overheat) LED

Connect an LED cable to LED2 to use the Power Fail/Fan Fail/Overheat LED. When LED2 is on, possible system overheating, fan failure or power failure has occurred. Take immediate actions to correct the problem to ensure proper system operation.

PWR Fail/Fan Fail/OH LED LED Settings	
Color/State	Definition
Red	OH/Fan Fail/PWR Fail (Solid On: Overheat, Fast Blinking: Fan Fail Slow Blinking: PWR Fail)
Off	System: Normal

Failed System LED (via IPMI)

A Failed System LED is located at LED5 on the motherboard. When this LED is blinking, the system has been shut down due to a possible system failure. Take actions to correct the problem to ensure proper system operation. See the table at right for more information. Also refer to Page 1-6 for details on LED indicators.

Failed System LED (via IPMI) LED Settings	
Color/State	Definition
Red: Blinking	System: shut down due to a system failure

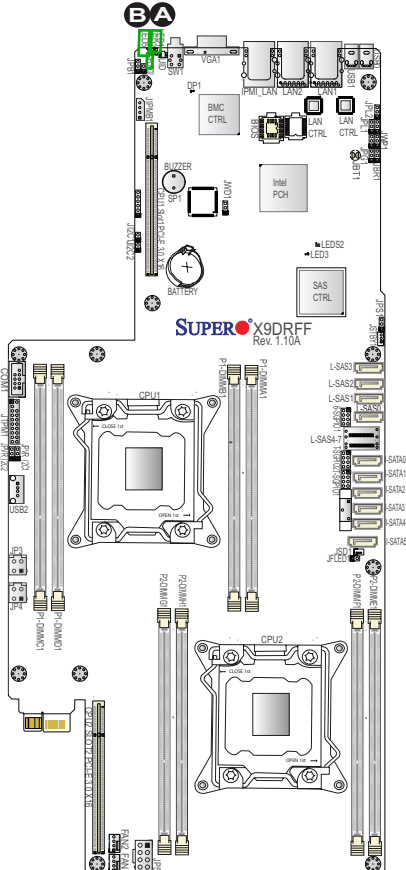

A. PWR Fail/Fan Fail/OH LED

B. Failed System LED (via IPMI)

BMC Activity LED

A BMC Activity LED is located at DP1 on the motherboard. When DP1 is blinking, BMC is active. See the table at right for more information.

BMC Activity LED Status	
Color or State	Definition
Green: Blinking	BMC: Active
Off	BMC Disabled, or Failed

Note: For information on LED1, please refer to Page 2-20.

A. BMC LED

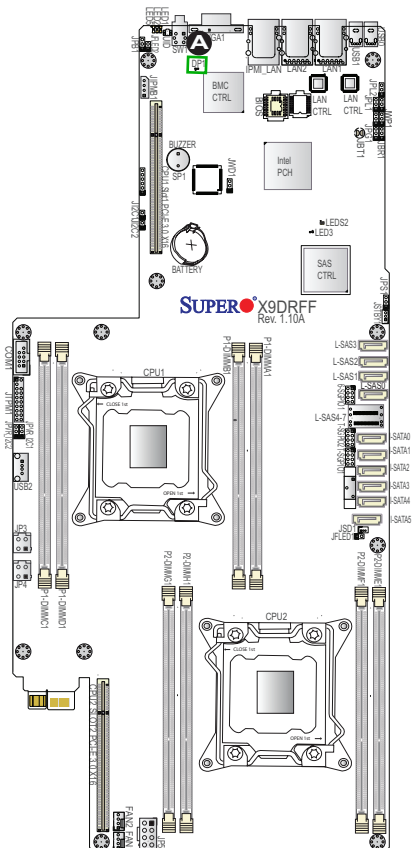

2-10 SATA/SAS Connections

SATA/SAS Ports (SAS: For X9DRFF-7 Only)

There are ten Serial_ATA ports on the motherboard. I-SATA ports 0/1 support SATA 3.0. I-SATA ports 2-5 supports SATA 2.0 connections. In addition, L-SAS 0-3 also supports SATA 2.0. L-SAS 0-3 can also be used for SAS connections on the X9DRFF-7. A SAS connector (L-SAS 4-7) provides SAS support on the X9DRFF-7 as well. See the table on the right for pin definitions.



Note: For more information on SATA or SAS-RAID configuration, please refer to the Intel SATA HostRAID or LSI MegaRAID User's Guide posted on our Website @ <http://www.supermicro.com>.

SATA/SAS Pin Definitions	
Pin#	Definition
1	Ground
2	TX_P
3	TX_N
4	Ground
5	RX_N
6	RX_P
7	Ground

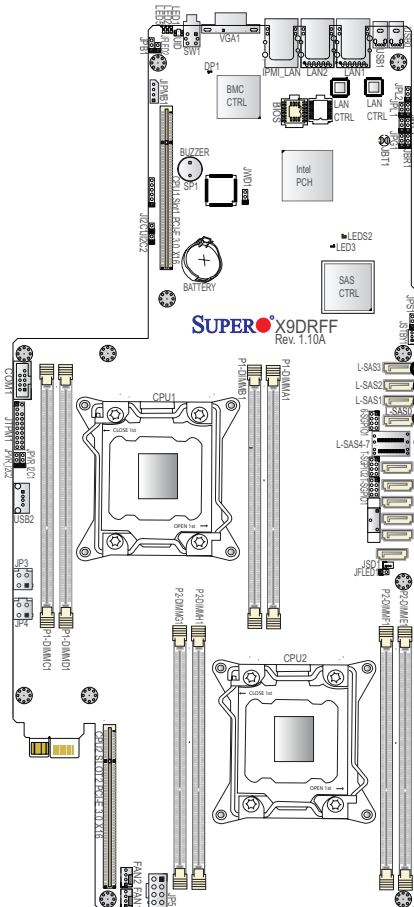

- A. I-SATA0 (SATA 3.0)
- B. I-SATA1 (SATA 3.0)
- C. I-SATA2 (SATA 2.0)
- D. I-SATA3 (SATA 2.0)
- E. I-SATA4 (SATA 2.0)
- F. I-SATA5 (SATA 2.0)
- G. L-SAS3 (also supports SATA 2.0)
- H L-SAS2 (also supports SATA 2.0)
- I. L-SAS1 (also supports SATA 2.0)
- J. L-SAS0 (also supports SATA 2.0)
- K. L - S A S 4 - 7 (X9DRFF-7 Only)

Notes

Chapter 3

Troubleshooting

3-1 Troubleshooting Procedures

Use the following procedures to troubleshoot your system. If you have followed all of the procedures below and still need assistance, refer to the 'Technical Support Procedures' and/or 'Returning Merchandise for Service' section(s) in this chapter. Note: Always disconnect the power cord before adding, changing or installing any hardware components.

Before Power On

1. Make sure that there are no short circuits between the motherboard and chassis.
2. Disconnect all ribbon/wire cables from the motherboard, including those for the keyboard and mouse.
3. Remove all add-on cards.
4. Install CPU 1 first (making sure it is fully seated) and connect the front panel connectors to the motherboard.

No Power

1. Make sure that no short circuits between the motherboard and the chassis.
2. Make sure that the ATX power connectors are properly connected
3. Check that the 115V/230V switch on the power supply is properly set, if available.
4. Turn the power switch on and off to test the system, if applicable.
5. The battery on your motherboard may be old. Check to verify that it still supplies ~3VDC. If it does not, replace it with a new one.

Losing the System's Setup Configuration

1. Make sure that you are using a high quality power supply. A poor quality power supply may cause the system to lose the CMOS setup information. Refer to Section 2-6 for details on recommended power supplies.
2. The battery on your motherboard may be old. Check to verify that it still supplies ~3VDC. If it does not, replace it with a new one.
3. If the above steps do not fix the Setup Configuration problem, contact your vendor for repairs.

When the System Becomes Unstable

A. The system becomes unstable during or after the OS installation

The system becomes unstable during or after the OS installation, check the following:

1. CPU/BIOS support: Make sure that your CPU is supported, and you have the latest BIOS installed in your system.
2. Memory support: Make sure that the memory modules are supported by testing the modules using memtest86 or a similar utility.

 **Note:** Refer to the product page on our website <http://www.supermicro.com> for memory and CPU support and updates.

3. HDD support: Make sure that all hard disk drives (HDDs) work properly. Replace the bad HDDs with good ones.
4. System cooling: Check system cooling to make sure that all heatsink fans, and CPU/system fans, etc., work properly. Check Hardware Monitoring settings in the BIOS to make sure that the CPU and System temperatures are within the normal range. Also check the front panel Overheat LED, and make sure that the Overheat LED is not on.
5. Adequate power supply: Make sure that the power supply provides adequate power to the system. Make sure that all power connectors are connected. Please refer to our website for more information on minimum power requirement.
6. Proper software support: Make sure that the correct drivers are used.

B. The system becomes unstable before or during the OS installation

When the system becomes unstable before or during OS installation, check the following:

1. Source of installation: Make sure that the devices used for installation are working properly, including boot devices such as CD/DVD disc, CD/DVD-ROM.
2. Cable connection: Check to make sure that all cables are connected and working properly.
3. Using minimum configuration for troubleshooting: Remove all unnecessary components (starting with add-on cards first), and use minimum configuration (with a CPU and a memory module installed) to identify the trouble areas. Refer to the steps listed in Section A above for proper troubleshooting procedures.
4. Identifying bad components by isolating them: If necessary, remove a component in question from the chassis, and test it in isolation to make sure that it works properly. Replace a bad component with a good one.
5. Check and change one component at a time instead of changing several items at the same time. This will help isolate and identify the problem.
6. To find out if a component is good, swap this component with a new one to see if the system will work properly. If so, then the old component is bad. You can also install the component in question in another system. If the new system works, the component is good and the old system has problems.

3-2 Technical Support Procedures

Before contacting Technical Support, please take the following steps. Also, please note that as a motherboard manufacturer, Supermicro also sells motherboards through its channels, so it is best to first check with your distributor or reseller for troubleshooting services. They should know of any possible problem(s) with the specific system configuration that was sold to you.

1. Please go through the 'Troubleshooting Procedures' and 'Frequently Asked Question' (FAQ) sections in this chapter or see the FAQs on our website (<http://www.supermicro.com/>) before contacting Technical Support.
2. BIOS upgrades can be downloaded from our website (<http://www.supermicro.com>).

3. If you still cannot resolve the problem, include the following information when contacting Supermicro for technical support:
 - Motherboard model and PCB revision number
 - BIOS release date/version (This can be seen on the initial display when your system first boots up.)
 - System configuration
4. An example of a Technical Support form is on our website at (<http://www.supermicro.com>).
- Distributors: For immediate assistance, please have your account number ready when placing a call to our technical support department. We can be reached by e-mail at support@supermicro.com.

3-3 Battery Removal and Installation

Battery Removal

To remove the onboard battery, follow the steps below:

1. Power off your system and unplug your power cable.
2. Locate the onboard battery as shown below.
3. Using a tool such as a pen or a small screwdriver, push the battery lock outwards to unlock it. Once unlocked, the battery will pop out from the holder.
4. Remove the battery.

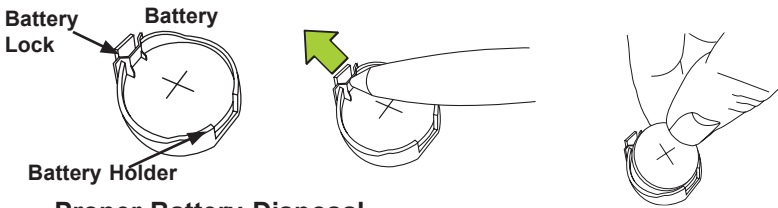

Proper Battery Disposal

Warning! Please handle used batteries carefully. Do not damage the battery in any way; a damaged battery may release hazardous materials into the environment. Do not discard a used battery in the garbage or a public landfill. Please comply with the regulations set up by your local hazardous waste management agency to dispose of your used battery properly.

Battery Installation

1. To install an onboard battery, follow the steps 1 & 2 above and continue below:
2. Identify the battery's polarity. The positive (+) side should be facing up.
3. Insert the battery into the battery holder and push it down until you hear a click to ensure that the battery is securely locked.

Warning: When replacing a battery, be sure to only replace it with the same type.

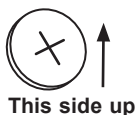

3-4 Frequently Asked Questions

Question: What are the various types of memory that my motherboard can support?

Answer: The motherboard supports Registered (RDIMM)/Load Reduced (LRDIMM) ECC or Unbuffered (UDIMM) ECC/Non-ECC DDR3 modules. To enhance memory performance, do not mix memory modules of different speeds and sizes. Please follow all memory installation instructions given on Section 2-4 in Chapter 2.

Question: How do I update my BIOS?

It is recommended that you **do not** upgrade your BIOS if you are not experiencing any problems with your system. Updated BIOS files are located on our website at <http://www.supermicro.com>. Please check our BIOS warning message and the information on how to update your BIOS on our website. Select your motherboard model and download the BIOS file to your computer. Also, check the current BIOS revision to make sure that it is newer than your BIOS before downloading. You can choose from the zip file and the .exe file. If you choose the zip BIOS file, please unzip the BIOS file onto a bootable USB device. Run the batch file using the format AMI.bat filename.rom from your bootable USB device to flash the BIOS. Then, your system will automatically reboot.

Warning: Do not shut down or reset the system while updating the BIOS to prevent possible system boot failure!



Note: The SPI BIOS chip used on this motherboard cannot be removed. Send your motherboard back to our RMA Department at Supermicro for repair. For BIOS Recovery instructions, please refer to the AMI BIOS Recovery Instructions posted at <http://www.supermicro.com>.

Question: What's on the CD that came with my motherboard?

Answer: The supplied compact disc has quite a few drivers and programs that will greatly enhance your system. We recommend that you review the CD and install the applications you need. Applications on the CD include chipset drivers for the Windows OS, security and audio drivers.

Question: How do I handle the used battery?

Answer: Please handle used batteries carefully. Do not damage the battery in any way; a damaged battery may release hazardous materials into the environment. Do not discard a used battery in the garbage or a public landfill. Please comply with the regulations set up by your local hazardous waste management agency to dispose of your used battery properly. Refer to Section 3-3.

3-5 Returning Merchandise for Service

A receipt or copy of your invoice marked with the date of purchase is required before any warranty service will be rendered. You can obtain service by calling your vendor for a Returned Merchandise Authorization (RMA) number. When returning the motherboard to the manufacturer, the RMA number should be prominently displayed on the outside of the shipping carton, and the shipping package is mailed prepaid or hand-carried. Shipping and handling charges will be applied for all orders that must be mailed when service is complete. For faster service, You can also request a RMA authorization online (<http://www.supermicro.com>).

This warranty only covers normal consumer use and does not cover damages incurred in shipping or from failure due to the alternation, misuse, abuse or improper maintenance of products.

During the warranty period, contact your distributor first for any product problems.

Notes

Chapter 4

BIOS

4-1 Introduction

This chapter describes the AMI BIOS Setup utility for the X9DRFF(-7). It also provides the instructions on how to navigate the AMI BIOS Setup utility screens. The AMI ROM BIOS is stored in a Flash EEPROM and can be easily updated.

Starting BIOS Setup Utility

To enter the AMI BIOS Setup utility screens, press the key while the system is booting up.

 **Note:** In most cases, the key is used to invoke the AMI BIOS setup screen. There are a few cases when other keys are used, such as <F3>, <F4>, etc.

Each main BIOS menu option is described in this manual. The Main BIOS setup menu screen has two main frames. The left frame displays all the options that can be configured. Grayed-out options cannot be configured. Options in blue can be configured by the user. The right frame displays the key legend. Above the key legend is an area reserved for informational text related to the option currently selected in the left frame.

 **Note:** The AMI BIOS has default informational messages built in. The manufacturer retains the option to include, omit, or change any of these informational messages.

The AMI BIOS Setup utility uses a key-based navigation system called "hot keys." Most of the AMI BIOS setup utility "hot keys" can be used at any time during setup navigation. These keys include <F3>, <F4>, <Enter>, <ESC>, arrow keys, etc.

 **Note 1:** In this section, options printed in **Bold** are default settings.

Note 2: <F3> is used to load optimal default settings. <F4> is used to save the settings and exit the setup utility.

How To Change the Configuration Data

The configuration data that determines the system parameters may be changed by entering the AMI BIOS Setup utility. This Setup utility can be accessed by pressing <Delete> at the appropriate time during system boot.

 **Note:** For AMI UEFI BIOS Recovery, please refer to the UEFI BIOS Recovery User Guide posted @<http://www.supermicro.com/support/manuals/>.

Starting the Setup Utility

Normally, the only visible Power-On Self-Test (POST) routine is the memory test. As the memory is being tested, press the <Delete> key to enter the main menu of the AMI BIOS Setup utility. From the main menu, you can access the other setup screens. An AMI BIOS identification string is displayed at the left bottom corner of the screen below the copyright message.

Warning! Do not upgrade the BIOS unless your system has a BIOS-related issue. Flashing the wrong BIOS can cause irreparable damage to the system. In no event shall the manufacturer be liable for direct, indirect, special, incidental, or consequential damage arising from a BIOS update. If you have to update the BIOS, do not shut down or reset the system while the BIOS is being updated to avoid possible boot failure.

4-2 Main Setup

When you first enter the AMI BIOS Setup utility, you will enter the Main setup screen. You can always return to the Main setup screen by selecting the Main tab on the top of the screen. The Main BIOS Setup screen is shown below.

The AMI BIOS main menu displays the following information:

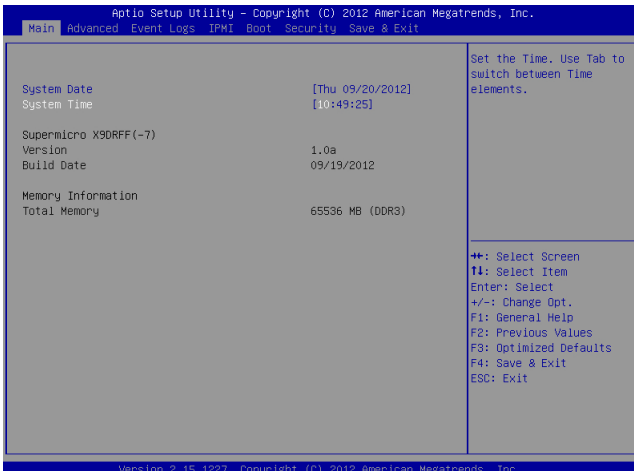

System Date

This item displays the system date in Day MM/DD/YY format (e.g. Wed 10/12/2012).

System Time

This item displays the system time in HH:MM:SS format (e.g. 15:32:52).

Supermicro X9DRFF (-7)

Version

This item displays the SMC version of the BIOS ROM used in this system.

Build Date

This item displays the date that the BIOS ROM was built.

Memory Information

Total Memory

This displays the amount of memory that is available in the system.

4-3 Advanced Setup Configurations

Use the arrow keys to select Advanced Setup and press <Enter> to access the following submenu items.

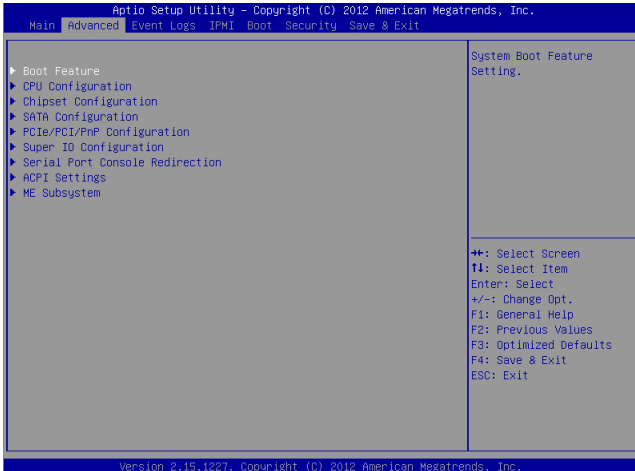

► Boot Feature

Quiet Boot

This feature allows the user to select bootup screen display between POST messages and the OEM logo. Select Disabled to display the POST messages. Select Enabled to display the OEM logo instead of the normal POST messages. The options are **Enabled** and Disabled.

AddOn ROM Display Mode

Use this item to set the display mode for the Option ROM. Select Keep Current to use the current AddOn ROM Display setting. Select Force BIOS to use the Option ROM display mode set by the system BIOS. The options are **Force BIOS** and Keep Current.

Bootup Num-Lock

Use this feature to set the Power-on state for the Num Lock key. The options are Off and **On**.

Wait For 'F1' If Error

Select Enabled to force the system to wait until the 'F1' key is pressed if an error occurs. The options are Disabled and **Enabled**.

Interrupt 19 Capture

Interrupt 19 is the software interrupt that handles the boot disk function. When this item is set to Enabled, the ROM BIOS of the host adaptors will "capture" Interrupt 19 at bootup and allow the drives that are attached to these host adaptors to function as bootable disks. If this item is set to Disabled, the ROM BIOS of the host adaptors will not capture Interrupt 19, and the drives attached to these adaptors will not function as bootable devices. The options are **Enabled** and Disabled.

Re-try Boot

When set to Enabled, the BIOS will continuously retry to boot from the selected boot type. The options are **Disabled**, Legacy Boot, and EFI Boot.

Power Configuration

Watch Dog Function

If enabled, the Watch Dog timer will allow the system to automatically reboot when a non-recoverable error occurs that lasts for more than five minutes. The options are Enabled and **Disabled**.

Power Button Function

If this feature is set to Instant Off, the system will power off immediately as soon as the user presses the power button. If this feature is set to 4 Seconds Override, the system will power off when the user presses the power button for 4 seconds or longer. The options are **Instant Off** and 4 Seconds Override.

Restore on AC Power Loss

Use this feature to set the power state after a power outage. Select Stay Off for the system power to remain off after a power loss. Select Power On for the system power to be turned on after a power loss. Select Last State to allow the system to resume its last state before a power loss. The options are Power On, Stay Off, and **Last State**.

CPU Configuration

This submenu displays the information of the CPU as detected by the BIOS. It also allows the user to configure CPU settings.

► Socket 1 CPU Information, Socket 2 CPU Information

This submenu displays the following information regarding the CPUs installed in Socket 1 and Socket 2.

- Type of CPU
- CPU Signature
- Microcode Patch
- CPU Stepping
- Maximum CPU Speed
- Minimum CPU Speed
- Processor Cores
- Intel HT (Hyper-Threading) Technology
- Intel VT-x Technology
- Intel SMX Technology
- L1 Data Cache
- L1 Code Cache
- L2 Cache
- L3 Cache

CPU Speed

This item displays the speed of the CPU installed in the Socket selected.

64-bit

This item indicates if 64-bit technology is supported by the CPU installed in the Socket selected.

Clock Spread Spectrum

Select Enable to enable Clock Spectrum support, which will allow the BIOS to monitor and attempt to reduce the level of Electromagnetic Interference caused by the components whenever needed. The options are **Disabled** and Enabled.

RTID (Record Types IDs)

This feature displays the total number of Record Type IDs for local and remote pools. The options are **Optimal** and Alternate.

Hyper-threading

Select Enabled to support Intel Hyper-threading Technology to enhance CPU performance. The options are **Enabled** and Disabled.

Active Processor Cores

Set to Enabled to use a processor's second core and above. (Please refer to Intel's website for more information.) The options are **All**, 1, 2, 4, and 6.

Limit CPUID Maximum

This feature allows the user to set the maximum CPU ID value. Enable this function to boot the legacy operating systems that cannot support processors with extended CPUID functions. The options are Enabled and **Disabled** (for the Windows OS).

Execute-Disable Bit (Available if supported by the OS & the CPU)

Select Enabled to enable the Execute Disable Bit which will allow the processor to designate areas in the system memory where an application code can execute and where it cannot, thus preventing a worm or a virus from flooding illegal codes to overwhelm the processor or damage the system during an attack. The default is **Enabled**. (Refer to Intel and Microsoft Web sites for more information.)

Intel® AES-NI

Select Enable to use the Intel Advanced Encryption Standard (AES) New Instructions (NI) to ensure data security. The options are **Enabled** and Disabled.

MLC Streamer Prefetcher (Available when supported by the CPU)

If set to Enabled, the MLC (mid-level cache) streamer prefetcher will prefetch streams of data and instructions from the main memory to the L2 cache to improve CPU performance. The options are Disabled and **Enabled**.

MLC Spatial Prefetcher (Available when supported by the CPU)

If this feature is set to Disabled, The CPU prefetches the cache line for 64 bytes. If this feature is set to Enabled the CPU fetches both cache lines for 128 bytes as comprised. The options are Disabled and **Enabled**.

DCU Streamer Prefetcher (Available when supported by the CPU)

Select Enabled to support Data Cache Unit (DCU) prefetch of L1 data to speed up data accessing and processing in the DCU to enhance CPU performance. The options are Disabled and **Enabled**.

DCU IP Prefetcher

Select Enabled for DCU (Data Cache Unit) IP Prefetcher support, which will prefetch IP addresses to improve network connectivity and system performance. The options are **Enabled** and Disabled.

Intel® Virtualization Technology (Available when supported by the CPU)

Select Enabled to support Intel Virtualization Technology, which will allow one platform to run multiple operating systems and applications in independent partitions, creating multiple "virtual" systems in one physical computer. The options are **Enabled** and Disabled.

 **Note:** If there is any change to this setting, you will need to power off and restart the system for the change to take effect. Please refer to Intel's website for detailed information.)

▶ CPU Power Management Configuration

This submenu allows the user to configure the following CPU Power Management settings.

Power Technology

Select Energy Efficiency to support power-saving mode. Select Custom to customize system power settings. Select Disabled to disable power-saving settings. The options are Disabled, **Energy Efficient**, and Custom. If the option is set to Custom, the following items will display:

EIST (Available when Power Technology is set to Custom)

EIST (Enhanced Intel SpeedStep Technology) allows the system to automatically adjust processor voltage and core frequency to reduce power consumption and heat dissipation. The options are Disabled and **Enabled**.

Turbo Mode (Available when Power Technology is set to Custom and EIST is enabled)

This feature allows processor cores to run faster than marked frequency in specific conditions. The options are Disabled and **Enabled**.

C1E Support (Available when Power Technology is set to Custom)

Select Enabled to enable Enhanced C1 Power State to boost system performance. The options are **Enabled** and Disabled.

CPU C3 Report (Available when Power Technology is set to Custom)

Select Enabled to allow the BIOS to report the CPU C3 State (ACPI C2) to the operating system. During the CPU C3 State, the CPU clock generator is turned off. The options are Enabled and **Disabled**.

CPU C6 Report (Available when Power Technology is set to Custom)

Select Enabled to allow the BIOS to report the CPU C6 State (ACPI C3) to the operating system. During the CPU C6 State, the power to all cache is turned off. The options are **Enabled** and Disabled.

CPU C7 Report (Available when Power Technology is set to Custom)

Select Enabled to allow the BIOS to report the CPU C7 State (ACPI C3) to the operating system. CPU C7 State is a processor-specific low C-State. The options are **Enabled** and Disabled.

Package C-State limit (Available when Power Technology is set to Custom)

This feature allows the user to set the limit on the C-State package register. The options are C0, C2, **C6**, and No Limit.

Energy Performance Bias

Use this feature to select an appropriate fan setting to achieve maximum system performance (with maximum cooling) or maximum energy efficiency with maximum power saving). The fan speeds are controlled by the firmware management via IPMI 2.0. The options are Performance, **Balanced Performance**, Balanced Energy, and Energy Efficient.

Factory Long Duration Power Limit

This item displays the power limit (in watts) set by the manufacturer during which long duration power is maintained.

Long Duration Power Limit

This item displays the power limit (in watts) set by the user during which long duration power is maintained. The default setting is **0**.

Factory Long Duration Maintained

This item displays the period of time (in seconds) set by the manufacturer during which long duration power is maintained.

Long Duration Maintained

This item displays the period of time (in seconds) during which long duration power is maintained. The default setting is **0**.

Recommended Short Duration Power Limit

This item displays the short duration power settings (in watts) recommended by the manufacturer.

Short Duration Power Limit

This item displays the time period during which short duration power (in watts) is maintained. The default setting is **0**.

► Chipset Configuration

► North Bridge

This feature allows the user to configure the settings for the Intel North Bridge.

► Integrated IO Configuration

Intel® VT-d

Select Enabled to enable Intel Virtualization Technology support for Direct I/O VT-d by reporting the I/O device assignments to the VMM (Virtual Machine Monitor) through the DMAR ACPI Tables. This feature offers fully-protected I/O resource sharing across Intel platforms, providing greater reliability, security and availability in networking and data-sharing. The options are **Enabled** and Disabled.

Intel® I/OAT

Select Enabled to enable Intel I/OAT (I/O Acceleration Technology), which significantly reduces CPU overhead by leveraging CPU architectural improvements and freeing the system resource for other tasks. The options are Disabled and **Enabled**.

DCA Support

When set to Enabled, this feature uses Intel's DCA (Direct Cache Access) Technology to improve data transfer efficiency. The default setting is **Enabled**.

MMCFG BASE

This feature determines the lowest base address that can be assigned to PCI devices. The lower the address, the less system memory is available (for 32-bit

OS). The higher the address, the less resources are allocated to PCI devices. The options are **0x80000000**, 0xA0000000, and 0xC0000000.

IIO 1 PCIe Port Bifurcation Control

This submenu configures the following IO PCIe Port Bifurcation Control settings for the PCIe ports to determine how the available PCI-Express lanes will be distributed between the PCI-Exp. Root Ports.

CPU 1 Slot1 PCI-E 3.0 x16 Link Speed

Select GEN1 to enable PCI-Exp Generation 1 support for Slot 1. Select GEN2 to enable PCI-Exp Generation 2 support for Slot 1. Select GEN3 to enable PCI-Exp Generation 3 support for Slot 1. The options are GEN1, GEN2, and **GEN3**.

IIO 2 PCIe Port Bifurcation Control

This submenu configures the following IO PCIe Port Bifurcation Control settings for the PCIe ports to determine how the available PCI-Express lanes will be distributed between the PCI-Exp. Root Ports.

CPU 2 Slot2 PCI-E 3.0 x16 Link Speed

Select GEN1 to enable PCI-Exp Generation 1 support for Slot 1. Select GEN2 to enable PCI-Exp Generation 2 support for Slot 1. Select GEN3 to enable PCI-Exp Generation 3 support for Slot 1. The options are GEN1, GEN2, and **GEN3**.

►QPI Configuration

Current QPI Link Speed

This item displays the current status of the QPI Link.

Current QPI Link Frequency

This item displays the frequency of the QPI Link.

Isoc

Select Enabled to enable Isochronous support to meet QoS (Quality of Service) requirements. This feature is especially important for virtualization technology. The options are Enabled and **Disabled**.

QPI (Quick Path Interconnect) Link Speed Mode

Use this feature to select data transfer speed for QPI Link connections. The options are **Fast** and Slow.

QPI Link Frequency Select

Use this feature to select the desired QPI frequency. The options are **Auto**, 6.4 GT/s, 7.2 GT/s, and 8.0 GT/s.

► DIMM Configuration

This section displays the following DIMM information.

Current Memory Mode

This item displays the current memory mode.

Current Memory Speed

This item displays the current memory speed.

Mirroring

This item displays if memory mirroring is supported by the motherboard. Memory mirroring creates a duplicate copy of the data stored in the memory to enhance data security.

Sparing

This item displays if memory sparing is supported by the motherboard. Memory sparing enhances system performance.

► DIMM Information

The status of the memory modules is displayed as detected by the BIOS.

Memory Mode

When Independent is selected, all DIMMs are available to the operating system. When Mirroring is selected, the motherboard maintains two identical copies of all data in memory for data backup. When Lockstep is selected, the motherboard uses two areas of memory to run the same set of operations in parallel. The options are **Independent**, Mirroring, and Lockstep.

DRAM RAPL Mode

RAPL (Running Average Power Limit) provides mechanisms to enforce power consumption limits on supported processors. The options are DRAM RAPL MODE0, **DRAM RAPL MODE1**, and Disabled.

DDR Speed

Use this feature to force a DDR3 memory module to run at a frequency other than what is specified by the manufacturer. The options are **Auto**, Force DDR3-800, Force DDR3-1066, Force DDR3-1333, Force DDR3-1600 and Force SPD.

Channel Interleaving

This feature selects from the different channel interleaving methods. The options are **Auto**, 1 Way, 2 Way, 3, Way, and 4 Way.

Rank Interleaving

This feature allows the user to select a rank memory interleaving method. The options are **Auto**, 1 Way, 2 Way, 4, Way, and 8 Way.

Patrol Scrub

Patrol Scrubbing is a process that allows the CPU to correct correctable memory errors detected on a memory module and send the correction to the requestor (the original source). When this item is set to Enabled, the IO hub will read and write back one cache line every 16K cycles, if there is no delay caused by internal processing. By using this method, roughly 64 GB of memory behind the IO hub will be scrubbed every day. The options are **Enabled** and Disabled.

Demand Scrub

Demand Scrubbing is a process that allows the CPU to correct correctable memory errors found on a memory module. When the CPU or I/O issues a demand-read command, and the read data from memory turns out to be a correctable error, the error is corrected and sent to the requestor (the original source). Memory is updated as well. Select Enabled to use Demand Scrubbing for ECC memory correction. The options are Enabled and **Disabled**.

Data Scrambling

Select Enabled to enable data scrambling to ensure data security and integrity. The options are Disabled and **Enabled**.

Device Tagging

Select Enabled to support device tagging. The options are **Disabled** and Enabled.

Thermal Throttling

Throttling improves reliability and reduces power consumption in the processor via automatic voltage control during processor idle states. The options are Disabled and **CLTT** (Closed Loop Thermal Throttling).

► South Bridge Configuration

This feature allows the user to configure the settings for the Intel PCH chip.

PCH Information

This feature displays the following PCH information.

Name: This item displays the name of the PCH chip.

Stepping: This item displays the PCH stepping.

USB Devices: This item displays the USB devices detected by the BIOS.

All USB Devices

This feature enables all USB ports/devices. The options are Disabled and **Enabled**.

EHCI Controller 1, EHCI Controller 2 (Available when All USB Devices is set to Enabled)

Select Enabled to enable EHCI (Enhanced Host Controller Interface) Controller 1 or Controller 2. The options are Disabled and **Enabled**.

Legacy USB Support (Available when USB Functions is not Disabled)

Select Enabled to support legacy USB devices. Select Auto to disable legacy support if USB devices are not present. Select Disabled to have USB devices available for EFI (Extensive Firmware Interface) applications only. The settings are Disabled, **Enabled** and Auto.

Port 60/64 Emulation

Select Enabled to enable I/O port 60h/64h emulation support for the legacy USB keyboard so that it can be fully supported by the operating systems that does not recognize a USB device. The options are Disabled and **Enabled**.

EHCI Hand-Off

This item is for operating systems that do not support Enhanced Host Controller Interface (EHCI) hand-off. When enabled, EHCI ownership change will be claimed by the EHCI driver. The options are **Disabled** and Enabled.

► SATA Configuration

When this submenu is selected, the AMI BIOS automatically detects the presence of IDE or SATA devices and displays the following items.

SATA Port0~SATA Port5: The AMI BIOS displays the status of each SATA port as detected by the BIOS.

SATA Mode

Use this feature to configure SATA mode for a selected SATA port. The options are Disabled, IDE Mode, **AHCI Mode** and RAID Mode. The following are displayed depending on your selection:

IDE Mode

The following items are displayed when IDE Mode is selected:

Serial-ATA (SATA) Controller 0~1

Use this feature to activate or deactivate the SATA controller, and set the compatibility mode. The options are Disabled, Enhanced, and Compatible. The default for SATA Controller 0 is **Compatible**. The default of SATA Controller 1 is **Enhanced**.

AHCI Mode

The following items are displayed when the AHCI Mode is selected.

Aggressive Link Power Management

When Enabled, the SATA AHCI controller manages the power usage of the SATA link. The controller will put the link in a low power mode during extended periods of I/O inactivity, and will return the link to an active state when I/O activity resumes. The options are **Enabled** and Disabled.

Port 0~5 Hot Plug

Select Enabled to enable hot-plug support for a particular port, which will allow the user to change a hardware component or device without shutting down the system. The options are **Enabled** and Disabled.

Staggered Spin Up

Select Enabled to enable Staggered Spin-up support to prevent excessive power consumption caused by multiple HDDs spinning-up simultaneously. The options are Enabled and **Disabled**.

RAID Mode

The following items are displayed when RAID Mode is selected:

SATA RAID Option ROM/UEFI Driver

Use this feature to enable the onboard SATA Option ROM or EFI driver. The options are Enabled and Disabled.

Port 0~5 Hot Plug

Select Enabled to enable hot-plug support for the particular port. The options are Disabled and **Enabled**.

► PCIe/PCI/PnP Configuration

Launch Storage Add-on Card OpROM Priority

Use this feature to select the Option ROM to boot the system when there are multiple Option ROMs available in the system. The options are UEFI only and **Legacy only**.

PCI Latency Timer

Use this feature to set the latency Timer of each PCI device installed on a PCI bus. Select 64 to set the PCI latency to 64 PCI clock cycles. The options are 32, **64**, 96, 128, 160, 192, 224 and 248.

PERR# Generation

Select Enabled to allow a PCI device to generate a PERR number for a PCI Bus Signal Error Event. The options are Enabled and **Disabled**.

SERR# Generation

Select Enabled to allow a PCI device to generate an SERR number for a PCI Bus Signal Error Event. The options are Enabled and **Disabled**.

Maximum Payload

Select Auto to allow the system BIOS to automatically set the maximum payload value for a PCI-E device to enhance system performance. The options are **Auto**, 128 Bytes and 256 Bytes, 512 Bytes, 1024 Bytes, 2048 Bytes, and 4096 Bytes.

Maximum Read Request

Select Auto to allow the system BIOS to automatically set the maximum Read Request size for a PCI-E device to enhance system performance. The options are **Auto**, 128 Bytes, 256 Bytes, 512 Bytes, 1024 Bytes, 2048 Bytes, and 4096 Bytes.

ASPM Support

This feature allows the user to set the Active State Power Management (ASPM) level for a PCI-E device. Select Auto to allow the system BIOS to automatically set the ASPM level for the system. Select Disabled to disable ASPM support. The options are **Disabled**, and Auto.

Warning: Enabling ASPM support may cause some PCI-E devices to fail!

Above 4G Decoding (Available if the system supports 64-bit PCI decoding)

Select Enabled to decode a PCI device that supports 64-bit in the space above 4G Address. The options are Enabled and **Disabled**.

CPU1 Slot 1 PCI-E 3.0 x16 OPROM

Select Enabled to enable Option ROM support to boot the computer using a device installed on the slot specified above. The options are **Enabled** and Disabled.

CPU2 Slot 2 PCI-E 3.0 x16 OPROM

Select Enabled to enable Option ROM support to boot the computer using a device installed on the slot specified above. The options are **Enabled** and Disabled.

Onboard LAN Option ROM Select

Select iSCSI to use the iSCSI Option ROM to boot the computer using a network device. Select PXE (Preboot Execution Environment) to use an PXE Option ROM to boot the computer using a network device. The options are iSCSI and **PXE**.

Load Onboard LAN1 Option ROM, Load Onboard LAN2 Option ROM

Select Enabled to enable the onboard LAN1/LAN2 Option ROM. This is to boot the computer using a network device. The default setting for LAN1 Option ROM is **Enabled**, and the default setting for LAN2 Option ROM is **Disabled**.

Load Onboard SAS OPROM

Select Enabled to enable the onboard SAS Option ROM. This is to boot the computer using a SAS device. The options are Disabled and **Enabled**.

VGA Priority

This feature allows the user to select the graphics adapter to be used as the primary boot device. The options are **Onboard**, and Offboard.

Network Stack

Select Enabled enable PXE (Preboot Execution Environment) or UEFI (Unified Extensible Firmware Interface) for network stack support. The options are Enabled and **Disabled**.

IPv4 PXE Support (Available when Network Stack is set to Enabled)

Set this item to Enabled to activate IPv4 PXE Support. The options are **Enabled** and Disabled.

IPv6 PXE Support (Available when Network Stack is set to Enabled)

Set this item to Enabled to activate IPv6 PXE Support. The options are Enabled and **Disabled**.

► Super IO Configuration

Super IO Chip: This item displays the Super IO chip used in the motherboard.

► COM1 Configuration

Serial Port

Select Enabled to enable a serial port specified by the user. The options are **Enabled** and Disabled.

Device Settings

This item displays the settings of Serial Port 1.

Change Settings

This option specifies the base I/O port address and the Interrupt Request address of Serial Port 1. Select Disabled to prevent the serial port from accessing any system resources. When this option is set to Disabled, the serial port becomes unavailable. The options are **Auto**, IO=3F8h; IRQ=4, IO=3F8h; IRQ=3, IO=2F8h; IRQ=3, IO=3E8h; IRQ=5, IO=2E8h; IRQ=7, IO=3F8h; IRQ=3, 4, 5, 6, 7, 10, 11, 12; IO=2F8h; IRQ=3, 4, 5, 6, 7, 10, 11, 12; IO=3E8h; IRQ=3, 4, 5, 6, 7, 10, 11, 12; IO=2E8h; IRQ=3, 4, 5, 6, 7, 10, 11, 12;

Device Mode

Use this feature to select the desired mode for a serial port specified. The options are **Normal** and High Speed.

► SOL Configuration

SOL Serial Port

Select Enabled to enable a serial port specified by the user. The options are **Enabled** and Disabled.

Device Settings

This item displays the settings of Serial Port 2.

SOL Change Settings

This option specifies the base I/O port address and the Interrupt Request address of Serial Port 2. Select Disabled to prevent the serial port from accessing any system resources. When this option is set to Disabled, the serial port becomes unavailable. The options are **Auto**, IO=3F8h; IRQ=4, IO=3F8h; IRQ=3, IO=2F8h;

IRQ=3, IO=3E8h; IRQ=5, IO=2E8h; IRQ=7, IO=3F8h; IRQ=3, 4, 5, 6, 7, 10, 11, 12; IO=2F8h; IRQ=3, 4, 5, 6, 7, 10, 11, 12; IO=3E8h; IRQ=3, 4, 5, 6, 7, 10, 11, 12; IO=2E8h; IRQ=3, 4, 5, 6, 7, 10, 11, 12;

SOL Device Mode

Use this feature to select the desired mode for a serial port specified. The options are **Normal** and High Speed.

► Serial Port Console Redirection

COM 1, SOL

These two submenus allow the user to configure the following Console Redirection settings for a COM Port specified by the user.

COM1, SOL Console Redirection

Select Enabled to use a COM Port selected by the user for Console Redirection. The options are Enabled and Disabled. The default setting for COM1 is **Disabled**, and for SOL is **Enabled**.

► Console Redirection Settings

This feature allows the user to specify how the host computer will exchange data with the client computer, which is the remote computer used by the user.

Terminal Type

This feature allows the user to select the target terminal emulation type for Console Redirection. Select VT100 to use the ASCII Character set. Select VT100+ to add color and function key support. Select ANSI to use the Extended ASCII Character Set. Select VT-UTF8 to use UTF8 encoding to map Unicode characters into one or more bytes. The options are ANSI, VT100, **VT100+**, and VT-UTF8.

Bits Per second

Use this feature to set the transmission speed for a serial port used in Console Redirection. Make sure that the same speed is used in the host computer and the client computer. A lower transmission speed may be required for long and busy lines. The options are 9600, 19200, 38400, 57600 and **115200** (bits per second).

Data Bits

Use this feature to set the data transmission size for Console Redirection. The options are 7 Bits and **8 Bits**.

Parity

A parity bit can be sent along with regular data bits to detect data transmission errors. Select Even if the parity bit is set to 0, and the number of 1's in data bits is even. Select Odd if the parity bit is set to 0, and the number of 1's in data bits is odd. Select None if you do not want to send a parity bit with your data bits in transmission. Select Mark to add a mark as a parity bit to be sent along with the data bits. Select Space to add a Space as a parity bit to be sent with your data bits. The options are **None**, Even, Odd, Mark and Space.

Stop Bits

A stop bit indicates the end of a serial data packet. Select 1 Stop Bit for standard serial data communication. Select 2 Stop Bits if slower devices are used. The options are **1** and 2.

Flow Control

This feature allows the user to set the flow control for Console Redirection to prevent data loss caused by buffer overflow. Send a "Stop" signal to stop sending data when the receiving buffer is full. Send a "Start" signal to start sending data when the receiving buffer is empty. The options are **None** and Hardware RTS/CTS.

VT-UTF8 Combo Key Support

Select Enabled to enable VT-UTF8 Combination Key support for ANSI/VT100 terminals. The options are **Enabled** and Disabled.

Recorder Mode

Select Enabled to capture the data displayed on a terminal and send it as text messages to a remote server. The options are **Disabled** and Enabled.

Resolution 100x31

Select Enabled for extended-terminal resolution support. The options are Disabled and **Enabled**.

Legacy OS Redirection Resolution

Use this feature to select the number of rows and columns used in Console Redirection for legacy OS support. The options are 80x24 and **80x25**.

Putty KeyPad

This feature selects Function Keys and KeyPad settings for Putty, which is a terminal emulator designed for the Windows OS. The options are **VT100**, LINUX, XTERMR6, SCO, ESCN, and VT400.

Redirection After BIOS Post

Use this feature to enable or disable legacy console redirection after BIOS POST. When set to Bootloader, legacy console redirection is disabled before booting the OS. When set to Always Enable, legacy console redirection remains enabled when booting the OS. The options are **Always Enable** and Bootloader.

Serial Port for Out-of-Band Management/Windows Emergency Management Services (EMS)

The submenu allows the user to configure Console Redirection settings to support Out-of-Band Serial Port management.

EMS Console Redirection

Select Enabled to use a COM Port selected by the user for Console Redirection. The options are Enabled and **Disabled**.

► Console Redirection Settings (for EMS)

This feature allows the user to specify how the host computer will exchange data with the client computer, which is the remote computer used by the user.

Out-of-Band Management Port

The feature selects a serial port used by the Microsoft Windows Emergency Management Services (EMS) to communicate with a remote server. The options are **COM1** and SOL.

Terminal Type

This feature allows the user to select the target terminal emulation type for Console Redirection. Select VT100 to use the ASCII character set. Select VT100+ to add color and function key support. Select ANSI to use the extended ASCII character set. Select VT-UTF8 to use UTF8 encoding to map Unicode characters into one or more bytes. The options are ANSI, VT100, **VT100+**, and VT-UTF8.

Bits Per Second

This item sets the transmission speed for a serial port used in Console Redirection. Make sure that the same speed is used in the host computer and the client computer. A lower transmission speed may be required for long and busy lines. The options are 9600, 19200, 57600, and **115200** (bits per second).

Flow Control

This feature allows the user to set the flow control for Console Redirection to prevent data loss caused by buffer overflow. Send a "Stop" signal to stop sending data when the receiving buffer is full. Send a "Start" signal to start sending data when the receiving buffer is empty. The options are **None**, Hardware RTS/CTS, and Software Xon/Xoff.

Data Bits, Parity, Stop Bits

The setting for each of these items is displayed.

► ACPI Settings

Use this feature to configure Advanced Configuration and Power Interface (ACPI) power management settings for your system.

ACPI Sleep State

Use this feature to select the ACPI State when the system is in sleep mode. Select S1 (CPU Stop Clock) to erase all CPU caches and stop executing instructions. Power to the CPU(s) and RAM is maintained, but RAM is refreshed. Select Suspend Disabled to use power-reduced mode. Power will only be supplied to limited components (such as RAMs) to maintain the most critical functions of the system. The options are **S1 (CPU Stop Clock)**, and Suspend Disabled.

NUMA (NON-Uniform Memory Access)

This feature enables the Non-Uniform Memory Access ACPI support. The options are **Enabled** and Disabled.

High Precision Event Timer

Select Enabled to activate the High Precision Event Timer (HPET) that produces periodic interrupts at a much higher frequency than a Real-time Clock (RTC) does in synchronizing multimedia streams, providing smooth playback, reducing the dependency on other timestamp calculation devices, such as an x86 RDTSC Instruction embedded in the CPU. The High Performance Event Timer is used to replace the 8254 Programmable Interval Timer. The options are **Enabled** and Disabled.

► Trusted Computing (Available when a TPM device is detected by the BIOS)

Configuration

TPM Support

Select Enabled on this item and enable the TPM jumper on the motherboard to enable TPM support to improve data integrity and network security. The options are **Enabled** and Disabled.

TPM State

Select Enabled to enable TPM security settings to improve data integrity and network security. The options are Disabled and **Enabled**.

Pending Operation

Use this item to schedule an operation for the security device. The options are **None**, Enable Take Ownership, Disable Take Ownership, and TPM Clear.



Note: During restart, the computer will reboot in order to execute the pending operation and change the state of the security device.

Current Status Information: This item displays the information regarding the current TPM status.

TPM Enable Status

This item displays the status of TPM Support to indicate if TPM is currently enabled or disabled.

TPM Active Status

This item displays the status of TPM Support to indicate if TPM is currently active or deactivated.

TPM Owner Status

This item displays the status of TPM Ownership.

► Intel TXT (LT-SX) Configuration

Intel TXT (LT-SX) Hardware Support

This feature indicates if the following hardware components support the Intel Trusted Execution Technology.

CPU: TXT (Trusted Execution Technology) Feature

Chipset: TXT (Trusted Execution Technology) Feature

Intel TXT (LT-SX) Configuration

This feature displays the following TXT configuration setting.

TXT (LT-SX) Support: This item indicates if the Intel TXT support is enabled or disabled. The default setting is **Disabled**.



Note: Be sure to format your TPM module before enabling TXT (LT-SX) support for this feature to work properly.

Intel TXT (LT-SX) Dependencies

For Trusted Execution Technology to work properly in the system, be sure to enable the features displayed below.

VT-d Support: Intel Virtualization Technology with Direct I/O support

VT Support: Intel Virtualization Technology support

TPM Support: Trusted Platform support

TPM State: Trusted Platform state

► ME Subsystem

This feature displays the following ME Subsystem Configuration settings.

- **ME BIOS Interface Version**
- **ME Version**

4-4 Event Logs

Use this feature to configure Event Log settings.

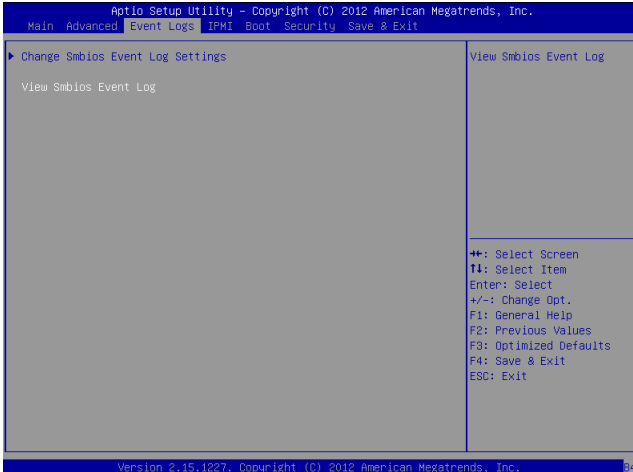

► Change SMBIOS Event Log Settings

This feature allows the user to configure SMBIOS Event settings.

Enabling/Disabling Options

SMBIOS Event Log

Select Enabled to enable SMBIOS (System Management BIOS) Event Logging during system boot. The options are **Enabled** and Disabled.

Runtime Error Logging Support

Select Enabled to support Runtime Error Logging. The options are **Enabled** and Disabled.

Memory Correctable Error Threshold

This feature allows the user to enter the threshold value for correctable memory errors. The default setting is **10**.

PCI Error Logging Support

Select Enabled to support error event logging for PCI slots. The options are Enabled and **Disabled**.

Erasing Settings

Erase Event Log

Select Enabled to erase the SMBIOS (System Management BIOS) Event Log, which is completed before an event logging is initialized upon system reboot. The options are **No**, Yes, next reset, and Yes, every reset.

When Log is Full

Select Erase Immediately to immediately erase SMBIOS error event logs that exceed the limit when the SMBIOS event log is full. Select Do Nothing for the system to do nothing when the SMBIOS event log is full. The options are **Do Nothing** and Erase Immediately.

SMBIOS Event Log Standard Settings

Log System Boot Event

Select Enabled to log system boot events. The options are **Disabled** and Enabled.

MECI (Multiple Event Count Increment)

Enter the increment value for the multiple event counter. Enter a number between 1 to 255. The default setting is **1**.

METW (Multiple Event Count Time Window)

This item allows the user to decide how long (in minutes) should the multiple event counter wait before generating a new event log. Enter a number between 0 to 99. The default setting is **60**.

View SMBIOS Event Log

This item allows the user to view the event in the SMBIOS event log. Select this item and press <Enter> to view the status of an event in the log.

Date/Time/Error Code/Severity

4-5 IPMI

Use this feature to configure Intelligent Platform Management Interface (IPMI) settings.

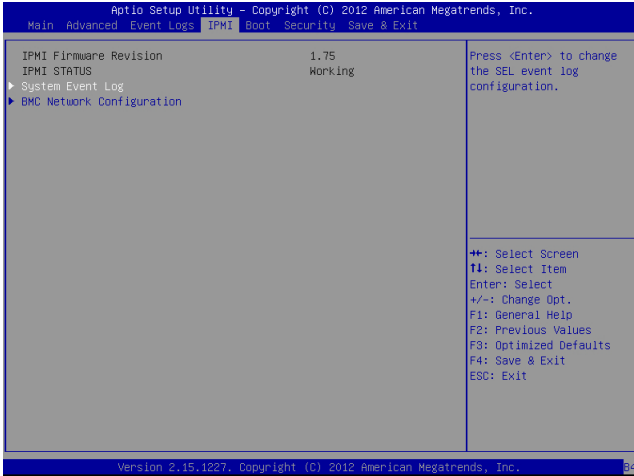

IPMI Firmware Revision

This item indicates the IPMI firmware revision used in your system.

IPMI Status

This item indicates the status of the IPMI firmware installed in your system.

► System Event Log

Enabling/Disabling Options

SEL Components

Select Enabled for all system event logging at bootup. The options are **Enabled** and Disabled.

Erasing Settings

Erase SEL

Select Yes, On next reset to erase all system event logs upon next system reboot.
 Select Yes, On every reset to erase all system event logs upon each system reboot.
 Select No to keep all system event logs after each system reboot. The options are **No**, Yes, On next reset, and Yes, On every reset.

When SEL is Full

This feature allows the user to decide what the BIOS should do when the system event log is full. Select Erase Immediately to erase all events in the log when the system event log is full. The options are **Do Nothing** and Erase Immediately.

►BMC Network Configuration

LAN Channel 1: This feature allows the user to configure the settings for the LAN1 Port.

Update IPMI LAN Configuration

This feature allows the BIOS to implement any IP/MAC address changes at the next system boot. If the option is set to Yes, any changes made to the settings below will take effect when the system is rebooted. The options are **No** and Yes.

Configuration Address Source

This feature allows the user to select the source of the IP address for this computer. If Static is selected, you will need to know the IP address of this computer and enter it to the system manually in the field. If DHCP is selected, the BIOS will search for a DHCP (Dynamic Host Configuration Protocol) server in the network that it is attached to and request the next available IP address for this computer. The options for are **DHCP** and Static. The following items are assigned IP addresses automatically if DHCP is selected, or can be configured manually if Static is selected.

Station IP Address

This item displays the Station IP address for this computer. This should be in decimal and in dotted quad form (i.e., 192.168.10.253).

Subnet Mask

This item displays the sub-network that this computer belongs to. The value of each three-digit number separated by dots should not exceed 255.

Station MAC Address

This item displays the Station MAC address for this computer. Mac addresses are 6 two-digit hexadecimal numbers.

Gateway IP Address

This item displays the Gateway IP address for this computer. This should be in decimal and in dotted quad form (i.e., 192.168.10.253).

4-6 Boot

This submenu allows the user to configure the following boot settings for the system.

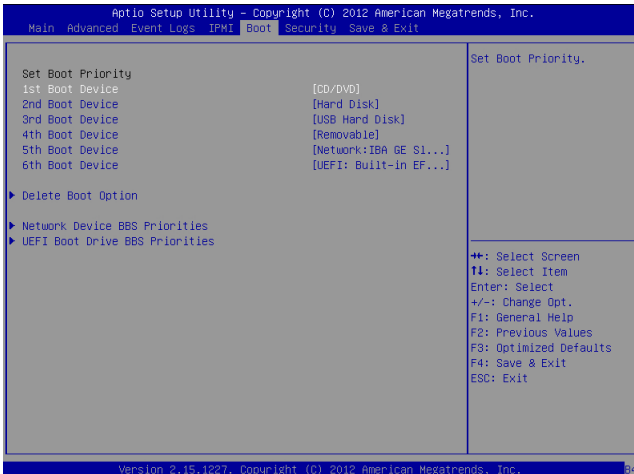

Set Boot Priority

1st Boot Device, 2nd Boot Device, 3rd Boot Device, etc.

Use these items to specify the sequence of boot device priority.

► Delete Boot Option

This feature allows the user to select a boot device to delete from the boot priority list.

Delete Boot Option

Select the desired boot device to delete.

Network Devices, USB Device BBS Priorities, Hard Disk Drives

The above options appear when detected by the BIOS. Use these options to set the order of the legacy network, USB, and Hard Disk Drive devices detected.

4-7 Security

This menu allows the user to configure the following security settings for the system.

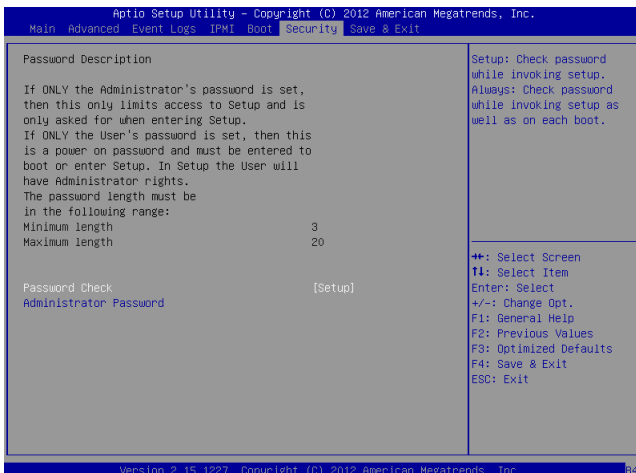

Password Check

Use this feature to determine when a password entry is required. Select Setup to require the password only when entering setup. Select Always to require the password when entering setup and on each boot. The options are **Setup** and **Always**.

Administrator Password

Use this feature to set the Administrator Password which is required to enter the BIOS setup utility. The length of the password should be from 3 characters to 20 characters long.

4-8 Save & Exit

This submenu allows the user to configure the Save and Exit settings for the system.



Discard Changes and Exit

Select this option to quit the BIOS Setup without making any permanent changes to the system configuration, and reboot the computer. Select Discard Changes and Exit, and press <Enter>. When the dialog box appears, asking you if you want to exit the BIOS setup without saving, select **Yes** to quit BIOS without saving the changes, or select No to quit the BIOS and save changes.

Save Changes and Reset

When you have completed the system configuration changes, select this option to save the changes and reboot the computer so that the new system configuration settings can take effect. Select Save Changes and Exit, and press <Enter>. When the dialog box appears, asking you if you want to exit the BIOS setup without saving, select **Yes** to quit BIOS without saving the changes, or select No to quit the BIOS and save changes.

Save Options

Save Changes

Select this option and press <Enter> to save all changes you've done so far and return to the AMI BIOS utility Program. When the dialog box appears, asking you if you want to save configuration, select **Yes** to save the changes, or select No to return to the BIOS without making changes.

Discard Changes

Select this feature and press <Enter> to discard all the changes and return to the BIOS setup. When the dialog box appears, asking you if you want to load previous values, select **Yes** to load the values previous saved, or select No to keep the changes you've made so far.

Restore Optimized Defaults

Select this feature and press <Enter> to load the optimized default settings that help optimize system performance. When the dialog box appears, asking you if you want to load optimized defaults, select **Yes** to load the optimized default settings, or select No to abandon optimized defaults.

Save as User Defaults

Select this feature and press <Enter> to save the current settings as the user's defaults. When the dialog box appears, asking you if you want to save values as user's defaults, click **Yes** to save the current values as user's default settings, or click No to keep the defaults previously saved as the user's defaults.

Restore User Defaults

Select this feature and press <Enter> to load the user's defaults previously saved in the system. When the dialog box appears, asking you if you want to restore user's defaults, select **Yes** to restore the user's defaults previously saved in the system, or select No to abandon the user's defaults that were previously saved.

Boot Override

This feature allows the user to override the Boot Option Priorities setting in the Boot menu, and instead immediately boot the system with one of the listed devices. This is a one-time override.

Appendix A

BIOS Error Beep Codes

During the POST (Power-On Self-Test) routines, which are performed at each system boot, errors may occur.

Non-fatal errors are those which, in most cases, allow the system to continue to boot. The error messages normally appear on the screen.

Fatal errors will not allow the system to continue with bootup procedure. If a fatal error occurs, you should consult with your system manufacturer for possible repairs.

These fatal errors are usually communicated through a series of audible beeps. The numbers on the fatal error list correspond to the number of beeps for the corresponding error.

A-1 BIOS Error Beep Codes

BIOS Error Beep Codes		
Beep Code/LED	Error Message	Description
1 beep	Refresh	Circuits have been reset. (Ready to power up)
5 short beeps + 1 long beep	Memory error	No memory detected in the system
8 beeps	Display memory read/write error	Video adapter missing or with faulty memory
OH LED On	System OH	System Overheat

Notes

Appendix B

Software Installation Instructions

B-1 Installing Software Programs

After you've installed the operating system, a screen as shown below will appear. You are ready to install software programs and drivers that have not yet been installed. To install these programs, click the icons to the right of these items.

 **Note:** To install the Windows OS, please refer to the instructions posted on our Website at <http://www.supermicro.com/support/manuals/>.

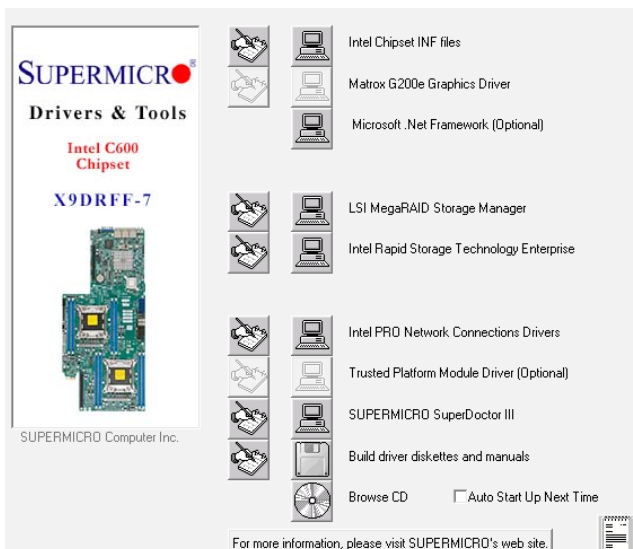

Driver/Tool Installation Display Screen

 **Note 1.** Click the icons showing a hand writing on the paper to view the readme files for each item. Click a computer icon to the right of an item to install an item (from top to the bottom) one at a time. After installing each item, you must reboot the system before proceeding with the next item on the list. The bottom icon with a CD on it allows you to view the entire contents of the CD.

Note 2. When making a storage driver diskette by booting into a Driver CD, please set the SATA Configuration to "Compatible Mode" and configure SATA as IDE in the BIOS Setup. After making the driver diskette, be sure to change the SATA settings back to your original settings.

B-2 Configuring SuperDoctor III (For Window OS Only)

The SuperDoctor III program is a Web-based management tool that supports remote management capability. It includes Remote and Local Management tools. The local management is called the SD III Client. The SuperDoctor III program included on the CDROM that came with your motherboard allows you to monitor the environment and operations of your system. SuperDoctor III displays crucial system information such as CPU temperature, system voltages and fan status. See the Figure below for a display of the SuperDoctor III interface.



Note: 1 The default user name and password are ADMIN.

Note 2: In the Windows OS environment, the SuperDoctor III settings take precedence over the BIOS settings. When first installed, SuperDoctor III adopts the temperature threshold settings previously set in BIOS. Any subsequent changes to these thresholds must be made within SuperDoctor, since the SD III settings override the BIOS settings. For the Windows OS to adopt the BIOS temperature threshold settings, please change the SDIII settings to be the same as those set in BIOS.

SuperDoctor III Interface Display Screen-I (Health Information)

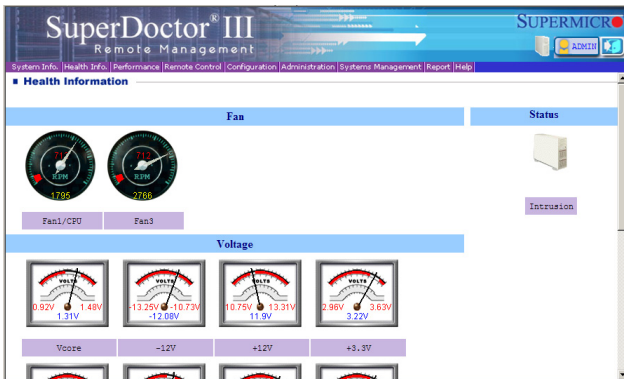

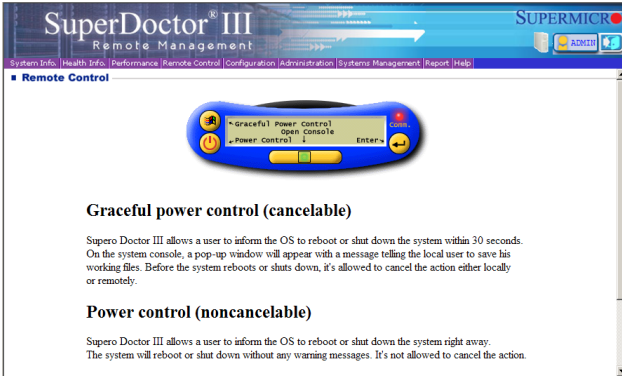
SuperDoctor III Interface Display Screen-II (Remote Control)

The SDIII utility and the user guide can be downloaded from our website at: <http://www.supermicro.com/products/accessories/software/SuperDoctorIII.cfm>. For Linux, we will still recommend that you use SuperDoctor II.

Notes

(Disclaimer Continued)

The products sold by Supermicro are not intended for and will not be used in life support systems, medical equipment, nuclear facilities or systems, aircraft, aircraft devices, aircraft/emergency communication devices or other critical systems whose failure to perform be reasonably expected to result in significant injury or loss of life or catastrophic property damage. Accordingly, Supermicro disclaims any and all liability, and should buyer use or sell such products for use in such ultra-hazardous applications, it does so entirely at its own risk. Furthermore, buyer agrees to fully indemnify, defend and hold Supermicro harmless for and against any and all claims, demands, actions, litigation, and proceedings of any kind arising out of or related to such ultra-hazardous use or sale.