

**SUPER**  <sup>®</sup>

X9DRD-EF  
X9DRD-7LN4F-JBOD  
X9DRD-7LN4F

**USER'S MANUAL**

Revision 1.1b

---

The information in this User's Manual has been carefully reviewed and is believed to be accurate. The vendor assumes no responsibility for any inaccuracies that may be contained in this document, and makes no commitment to update or to keep current the information in this manual, or to notify any person or organization of the updates. **Please Note: For the most up-to-date version of this manual, please see our website at [www.supermicro.com](http://www.supermicro.com).**

Super Micro Computer, Inc. ("Supermicro") reserves the right to make changes to the product described in this manual at any time and without notice. This product, including software and documentation, is the property of Supermicro and/or its licensors, and is supplied only under a license. Any use or reproduction of this product is not allowed, except as expressly permitted by the terms of said license.

IN NO EVENT WILL SUPER MICRO COMPUTER, INC. BE LIABLE FOR DIRECT, INDIRECT, SPECIAL, INCIDENTAL, SPECULATIVE OR CONSEQUENTIAL DAMAGES ARISING FROM THE USE OR INABILITY TO USE THIS PRODUCT OR DOCUMENTATION, EVEN IF ADVISED OF THE POSSIBILITY OF SUCH DAMAGES. IN PARTICULAR, SUPER MICRO COMPUTER, INC. SHALL NOT HAVE LIABILITY FOR ANY HARDWARE, SOFTWARE, OR DATA STORED OR USED WITH THE PRODUCT, INCLUDING THE COSTS OF REPAIRING, REPLACING, INTEGRATING, INSTALLING OR RECOVERING SUCH HARDWARE, SOFTWARE, OR DATA.

---

Any disputes arising between the manufacturer and the customer shall be governed by the laws of Santa Clara County in the State of California, USA. The State of California, County of Santa Clara shall be the exclusive venue for the resolution of any such disputes. Supermicro's total liability for all claims will not exceed the price paid for the hardware product.

---

FCC Statement: This equipment has been tested and found to comply with the limits for a Class A digital device pursuant to Part 15 of the FCC Rules. These limits are designed to provide reasonable protection against harmful interference when the equipment is operated in a commercial environment. This equipment generates, uses, and can radiate radio frequency energy and, if not installed and used in accordance with the manufacturer's instruction manual, may cause harmful interference with radio communications. Operation of this equipment in a residential area is likely to cause harmful interference, in which case you will be required to correct the interference at your own expense.

---

California Best Management Practices Regulations for Perchlorate Materials: This Perchlorate warning applies only to products containing CR (Manganese Dioxide) Lithium coin cells. "Perchlorate Material-special handling may apply. See [www.dtsc.ca.gov/hazardouswaste/perchlorate](http://www.dtsc.ca.gov/hazardouswaste/perchlorate)".

**WARNING:** Handling of lead solder materials used in this product may expose you to lead, a chemical known to the State of California to cause birth defects and other reproductive harm.

---

Manual Revision 1.1b

Release Date: November 5, 2013

Unless you request and receive written permission from Super Micro Computer, Inc., you may not copy any part of this document.

Information in this document is subject to change without notice. Other products and companies referred to herein are trademarks or registered trademarks of their respective companies or mark holders.

Copyright © 2013 by Super Micro Computer, Inc.  
All rights reserved.

**Printed in the United States of America**

## Preface

This manual is written for system integrators, PC technicians and knowledgeable PC users. It provides information for the installation and use of the X9DRD-EF/X9DRD-7LN4F-JBOD/X9DRD-7LN4F motherboard.

### About This Motherboard

The Super X9DRD-EF/7LN4F-JBOD/7LN4F motherboard supports dual Intel E5-2600(v2) Series Processors (Socket R LGA 2011) that offer QPI (Intel QuickPath Interface) Technology (V.1.1), providing point-to-point connection with a transfer speed of up to 8.0 TG/s. With the C602J built in, the X9DRD-EF/7LN4F-JBOD/7LN4F motherboard supports Intel® Management Engine (ME), Rapid Storage Technology, Digital Media Interface (DMI), PCI-E Gen. 3.0 and up to 1866 MHz DDR3 memory. This motherboard is ideal for high-end server platforms. Please refer to our website (<http://www.supermicro.com>) for CPU and memory support updates.

### Manual Organization

**Chapter 1** describes the features, specifications and performance of the motherboard. It also provides detailed information about the Intel C602J chipset.

**Chapter 2** provides hardware installation instructions. Read this chapter when installing the processor, memory modules and other hardware components into the system. If you encounter any problems, see **Chapter 3**, which describes troubleshooting procedures for video, memory, and system setup stored in CMOS.

**Chapter 4** includes an introduction to BIOS, and provides detailed information on running the CMOS Setup utility.

**Appendix A** provides BIOS Error Beep Codes.

**Appendix B** lists Software Installation Instructions.

## Conventions Used in the Manual

Pay special attention to the following symbols for proper system installation and to prevent damage to the system or injury to yourself.

**Warning:** Important information given to ensure proper system installation or to prevent damage to the components or injury to yourself;



**Note:** Additional information given to differentiate among various models or provides information for correct system setup.



## Contacting Supermicro

### Headquarters

Address: Super Micro Computer, Inc.  
980 Rock Ave.  
San Jose, CA 95131 U.S.A.

Tel: +1 (408) 503-8000

Fax: +1 (408) 503-8008

Email: [marketing@supermicro.com](mailto:marketing@supermicro.com) (General Information)  
[support@supermicro.com](mailto:support@supermicro.com) (Technical Support)

Web Site: [www.supermicro.com](http://www.supermicro.com)

### Europe

Address: Super Micro Computer B.V.  
Het Sterrenbeeld 28, 5215 ML  
's-Hertogenbosch, The Netherlands

Tel: +31 (0) 73-6400390

Fax: +31 (0) 73-6416525

Email: [sales@supermicro.nl](mailto:sales@supermicro.nl) (General Information)  
[support@supermicro.nl](mailto:support@supermicro.nl) (Technical Support)  
[rma@supermicro.nl](mailto:rma@supermicro.nl) (Customer Support)

### Asia-Pacific

Address: Super Micro Computer, Inc.  
3F, No. 150, Jian 1st Rd.  
Zhonghe Dist., New Taipei City 23511  
Taiwan (R.O.C)

Tel: +886-(2) 8226-3990

Fax: +886-(2) 8226-3992

Web Site: [www.supermicro.com.tw](http://www.supermicro.com.tw)

Technical Support:

Email: [support@supermicro.com.tw](mailto:support@supermicro.com.tw)

Tel: +886-(2)-8226-3990

# Table of Contents

## **Preface**

### **Chapter 1 Overview**

1-1	Overview .....	1-1
1-2	Processor and Chipset Overview.....	1-11
1-3	Special Features .....	1-12
1-4	PC Health Monitoring.....	1-12
1-5	ACPI Features.....	1-13
1-6	Power Supply .....	1-13
1-7	Super I/O.....	1-14
1-8	Advanced Power Management.....	1-14
	Intel® Intelligent Power Node Manager (IPNM) .....	1-14
	Management Engine (ME).....	1-15
1-9	Overview of the Nuvoton WPCM450 Controller .....	1-15
	Other Features Supported by the WPCM BMC Controller.....	1-15

### **Chapter 2 Installation**

2-1	Standardized Warning Statements .....	2-1
	Battery Handling.....	2-1
	Product Disposal .....	2-3
2-2	Static-Sensitive Devices.....	2-4
	Precautions .....	2-4
	Unpacking .....	2-4
2-3	Processor and Heatsink Installation.....	2-5
	Installing the LGA2011 Processor .....	2-5
	Installing a Passive CPU Heatsink .....	2-9
	Removing the Heatsink.....	2-10
2-4	Installing and Removing the Memory Modules.....	2-11
	Installing & Removing DIMMs.....	2-11
	Removing Memory Modules .....	2-11
2-5	Motherboard Installation.....	2-16
	Tools Needed .....	2-16
	Location of Mounting Holes .....	2-16
	Installing the Motherboard .....	2-17
2-6	Control Panel Connectors and I/O Ports.....	2-18
	Back Panel Connectors and I/O Ports.....	2-18
	Back Panel I/O Port Locations and Definitions .....	2-18
	Serial Ports.....	2-19

---

	Video Connection .....	2-19
	Universal Serial Bus (USB).....	2-20
	Ethernet Ports .....	2-21
	Unit Identifier Switch/UID LED Indicators .....	2-22
	Front Control Panel.....	2-23
	Front Control Panel Pin Definitions.....	2-24
	NMI Button .....	2-24
	Power LED .....	2-24
	HDD LED.....	2-25
	NIC1/NIC2 LED Indicators .....	2-25
	Overheat (OH)/Fan Fail/PWR Fail/UID LED.....	2-26
	Power Fail LED .....	2-26
	Reset Button .....	2-27
	Power Button .....	2-27
2-7	Connecting Cables.....	2-28
	Power Connectors .....	2-28
	Fan Headers.....	2-29
	Chassis Intrusion .....	2-29
	Internal Speaker.....	2-30
	Power LED/Speaker.....	2-30
	TPM Header/Port 80 .....	2-31
	Overheat LED/Fan Fail .....	2-31
	Power SMB (I <sup>2</sup> C) Connector .....	2-32
	IPMB.....	2-32
	T-SGPIO 1/2 Headers .....	2-33
	DOM Power Connector .....	2-33
	Standby Power Header .....	2-34
	LAN3/LAN4 LED Indicators.....	2-34
2-8	Jumper Settings .....	2-35
	Explanation of Jumpers .....	2-35
	GLAN Enable/Disable .....	2-35
	CMOS Clear .....	2-36
	Watch Dog Enable/Disable .....	2-36
	VGA Enable.....	2-37
	BMC Enable .....	2-37
	Management Engine (ME) Recovery .....	2-38
	Manufacture Mode Select .....	2-38
	I <sup>2</sup> C Bus to PCI-Exp. Slots .....	2-39

---

2-9	Onboard LED Indicators .....	2-40
	GLAN LEDs .....	2-40
	IPMI Dedicated LAN LEDs.....	2-40
	Onboard Power LED .....	2-41
	BMC Heartbeat LED .....	2-41
	Unit Identification Switch/LED .....	2-42
2-10	SATA/SAS Connections .....	2-43
	Serial ATA Ports.....	2-43
	SAS2 Ports .....	2-43

**Chapter 3 Troubleshooting**

3-1	Troubleshooting Procedures .....	3-1
3-2	Technical Support Procedures .....	3-5
3-3	Battery Removal and Installation .....	3-6
3-4	Frequently Asked Questions .....	3-7
3-5	Returning Merchandise for Service.....	3-8

**Chapter 4 BIOS**

4-1	Introduction.....	4-1
4-2	Main Setup .....	4-2
4-3	Advanced Setup Configurations.....	4-4
4-4	Event Logs .....	4-25
4-5	IPMI.....	4-27
4-6	Boot.....	4-29
4-7	Security.....	4-30
4-8	Save & Exit .....	4-31

**Appendix A BIOS Error Beep Codes**

A-1	BIOS Error Beep Codes .....	A-1
-----	-----------------------------	-----

**Appendix B Software Installation Instructions**

B-1	Installing Software Programs .....	B-1
B-2	Configuring SuperDoctor <sup>®</sup> III .....	B-2

# Chapter 1

## Overview

### 1-1 Overview

#### Checklist

Congratulations on purchasing your computer motherboard from an acknowledged leader in the industry. Supermicro boards are designed with the utmost attention to detail to provide you with the highest standards in quality and performance.

Please check that the following items have all been included with your motherboard. If anything listed here is damaged or missing, contact your retailer.

The following items are included in the retail box.

- One (1) Supermicro Mainboard
- Two (2) Serial ATA cables (CBL-0044Lx2) (X9DRD-7LN4F-JBOD/7LN4F series)
- Two (2) I-Pass to 4 Serial ATA (50-cm) cables (CBL-097L-02) (X9DRD-7LN4F-JBOD/7LN4F series)
- Six (6) Serial ATA cables (CBL-0044L) (X9DRD-EF series)
- One (1) I/O Shield (MCP-260-00042-0N)
- One (1) Quick Reference Guide (MNL-1318-QRG) (X9DRD-7LN4F series)
- One (1) Quick Reference Guide (MNL-1412-QRG) (X9DRD-EF series)



**Note:** For your system to work properly, please follow the links below to download all necessary drivers/utilities and the user's manual for your motherboard.

SMCI product manuals: <http://www.supermicro.com/support/manuals/>

Product Drivers and utilities: <ftp://ftp.supermicro.com/>

If you have any questions, please contact our support team at [support@supermicro.com](mailto:support@supermicro.com).

SUPER<sup>®</sup> Motherboard Image

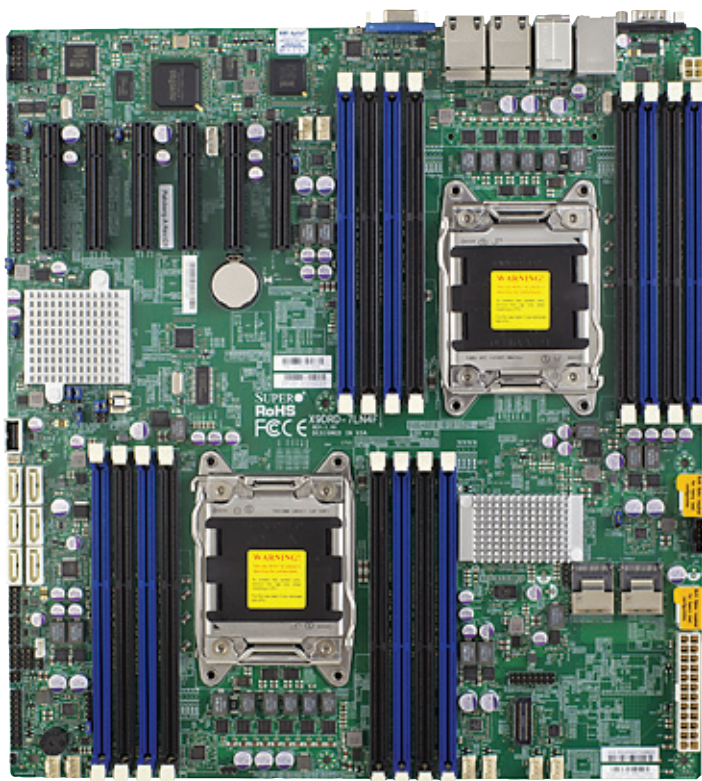

 **Note:** All graphics shown in this manual were based upon the latest PCB Revision available at the time of publishing of the manual. The motherboard you've received may or may not look exactly the same as the graphics shown in this manual.

## X9DRD-7LN4F-JBOD/7LN4F Motherboard Layout

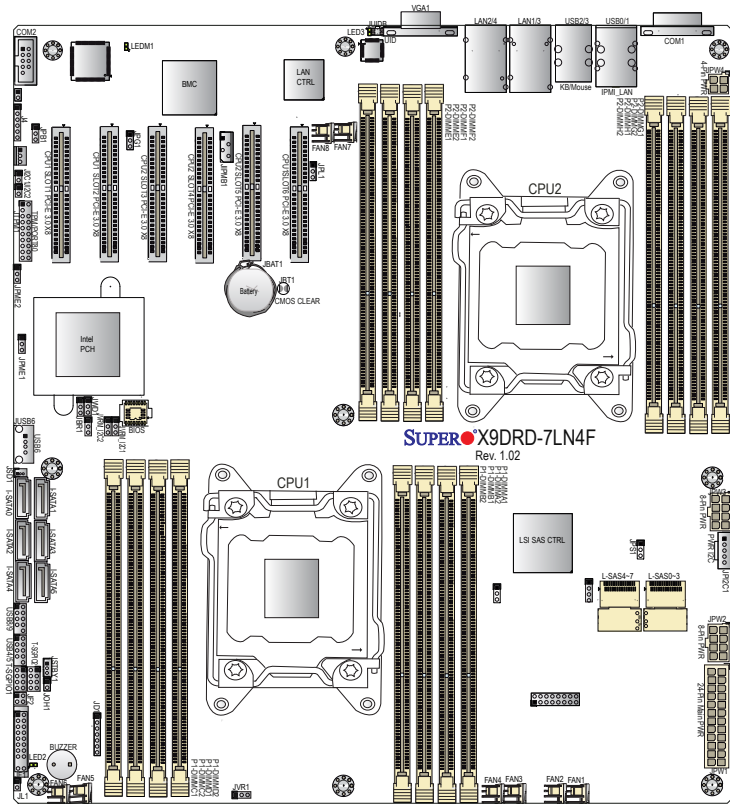

 **Note 1:** For the latest CPU/Memory updates, please refer to our website at <http://www.supermicro.com/products/motherboard/> for details.

**Note 2:** Changing BMC log-in information is recommended during initial system power-on. The default username is ADMIN and password is ADMIN. For BMC best practices, please refer to: [http://www.supermicro.com/products/info/files/IPMI/Best\\_Practices\\_BMC\\_Security.pdf](http://www.supermicro.com/products/info/files/IPMI/Best_Practices_BMC_Security.pdf)

**Note 3:** SAS ports are only available on X9DRD-7LN4F-JBOD/7LN4F.

X9DRD-7LN4F-JBOD/-7LN4F Quick Reference

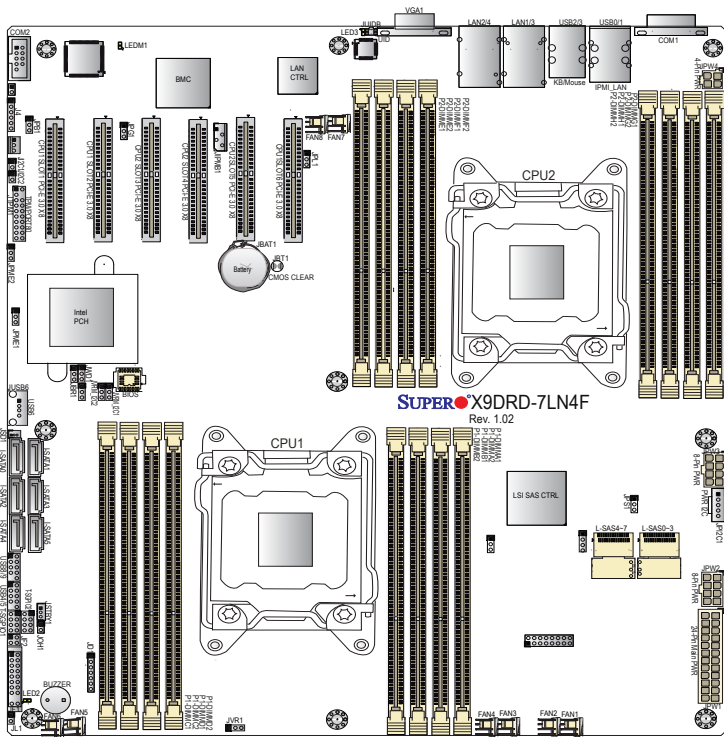

 **Notes:**

- See Chapter 2 for detailed information on jumpers, I/O ports and JF1 front panel connections. "■" indicates the location of "Pin 1".
- Jumpers/LED Indicators not indicated are for testing only. Also, components that are not documented in this manual are reserved for internal use only.
- Use only the correct type of onboard CMOS battery as specified by the manufacturer. Do not install the onboard battery upside down to avoid possible explosion.
- X9DRD-7LN4F supports SAS Firmware IR mode; X9DRD-7LN4F-JBOD supports SAS Firmware IT Mode.
- PCI-E slots support Low-Profile MD2 form factor for devices/add-on cards that are shorter than 167.64mm or 6.59" (in) in length only.
- SAS ports are only available on X9DRD-7LN4F-JBOD/7LN4F.



**X9DRD-EF/7LN4F-JBOD/-7LN4F Jumpers**

<b>Jumper</b>	<b>Description</b>	<b>Default Setting</b>
JBT1	Clear CMOS	See Chapter 2
JI <sup>2</sup> C1/JI <sup>2</sup> C2	SMB to PCI-E Slots	Off (Disabled)
JPB1	BMC Enabled	Pins 1-2 (Enabled)
JPG1	VGA Enabled	Pins 1-2 (Enabled)
JPL1	GLAN1/GLAN2 Enable	Pins 1-2 (Enabled)
JPME1	Management Engine (ME) Recovery Mode Enable	Pins 1-2 (Normal)
JPME2	Management Engine (ME) Manufacture Mode	Pins 1-2 (Normal)
JPS1 (X9DRD-7LN4F- JBOD/7LN4F)	SAS Enabled	Pins 1-2 (Enabled)
JWD1	Watch Dog Timer Enable	Pins 1-2 (Reset)

**X9DRD-7LN4F-JBOD/-7LN4F Connectors**

<b>Connectors</b>	<b>Description</b>
COM1/COM2	Backplane COM Port1/Front Accessible COM2 Header
FAN1~8	CPU/System Fan Headers
JBAT1	Onboard Battery (See Chpt. 3 for Used Bat- tery Disposal)
JD1	Speaker/Power LED Indicator
JF1	Front Panel Control Header
JF2 (X9DRD-7LN4F- JBOD/7LN4F)	LAN3 (NIC3)/LAN4 (NIC4) LED Indicators (LAN3/4: X9DRD-7LN4F-JBOD/7LN4F))
JIPMB1	4-pin External BMC I <sup>2</sup> C Header (for an IPMI Card)
JL1	Chassis Intrusion
JOH1	Overheat LED Indicator
JPI <sup>2</sup> C1	Power Supply SMBbus I <sup>2</sup> C Header
JPW1	24-Pin ATX Main Power Connector (Warning on Pg. 1-6.)
JPW2/3	12V 8-Pin Power Connectors (See Warning on Pg. 1-6.)
JPW4	12V 4-Pin Power Connectors (See Warning on Pg. 1-6.)

 **Note:** X9DRD-7LN4F supports SAS Firmware IR mode, and X9DRD-7LN4F-JBOD uses SAS Firmware IT Mode.





JSD1	SATA DOM (Device on Module) Power Connector
JSTBY1	+5V Standby Power Header
JTPM1	TPM (Trusted Platform Module)/Port 80
JUID	UID (Unit Identification) Switch
LAN1/3, LAN2/4 (LAN3/4: X9DRD-7LN4F-JBOD/7LN4F)	Gigabit Ethernet Ports 1/2, 3/4
(IPMI) LAN	IPMI_Dedicated LAN
(I)SATA1~6	Intel SATA Connectors 1~6 from the Intel PCH
(L)SAS0~3, 4~7 (X9DRD-7LN4F-JBOD/7LN4F)	Serial_Link SCSI Attached 2.0 Connectors 0~3, 4~7 from the LSI SAS 2308 Controller
SP1	Onboard Buzzer (Internal Speaker)
(CPU1)Slots1/2/6, (CPU2) Slot3/4/5	PCI-Express 3.0 x8 Slots (See Note Below)
(T-)SGPIO 1/2	Serial ATA (SATA) General Purpose I/O Header
(BP) USB 0/1, 2/3	Back Panel USB 0/1, 2/3
(FP) USB 4/5, USB 8/9	Front Panel Accessible USB Connections (4/5, 8/9)
(FP) USB 6	Type A USB Embedded Drive Connector
VGA	Backpanel VGA Port

#### X9DRD-EF/7LN4F-JBOD/7LN4F LED Indicators

LED	Description	State	Status
LED2	Standby PWR LED	Green: On	Standby PWR On
LED3	Rear UID LED	Blue: On	Unit Identified
LEDM1	BMC Heartbeat LED	Green: Blinking	BMC Normal

**Warning:** To avoid damaging your motherboard and components, please use a power supply that supports a 24-pin, two 8-pin and one 4-pin power connectors. Be sure to connect the 24-pin and the 8-pin power connectors to your power supply for adequate power delivery to your system. The 4-pin power connector is optional; however, Supermicro recommends that this connector also be plugged in for optimal power delivery.

## Motherboard Features

<p><b>CPU</b></p>	<ul style="list-style-type: none"> <li>Dual Intel® E5-2600(v2) Series Processors (Socket R LGA 2011); each processor supports two full-width Intel QuickPath Interconnect (QPI) links (with support of up to 25.6 GT/s per QPI link and with Data Transfer Rate of up to 8.0 GT/s per direction).</li> </ul> <p> <b>Note:</b> For Intel E5-2600(v2) processor support, BIOS version 3.0 or above is required.</p>					
<p><b>Memory</b></p>	<ul style="list-style-type: none"> <li>Integrated memory controller supports up to 1 TB of Load Reduced (LRDIMM), 512 GB of Registered (RDIMM) or 128 GB of Unbuffered (UDIMM) ECC/Non-ECC DDR3 800/1066/1333/1600/1866 MHz 240-pin 4-channel memory modules in 16 DIMM slots.</li> </ul> <p> <b>Note 1:</b> 1866 MHz memory speed is dependent on Intel E5-2600v2 CPUs.</p> <p><b>Note 2:</b> For the latest memory updates, please refer to the Tested Memory List posted on our website (<a href="http://www.supermicro.com/products/motherboard">http://www.supermicro.com/products/motherboard</a>).</p>					
	<ul style="list-style-type: none"> <li>Virtualization: VT-x, VT-d, and VT-c</li> </ul>					
<p><b>Chipset</b></p>	<ul style="list-style-type: none"> <li>Intel® C602J Chipset</li> </ul>					
<p><b>Expansion Slots</b></p>	<ul style="list-style-type: none"> <li>Six (6) PCI Express 3.0 x8 slots (CPU1 Slot1/Slot2/Slot6 and CPU2 Slot3/Slot4/Slot5),</li> </ul>					
<p><b>Graphics</b></p>	<ul style="list-style-type: none"> <li>Nuvoton BMC Video Controller (Matrox G200eW)</li> </ul>					
<p><b>Network</b></p>	<ul style="list-style-type: none"> <li>One Intel I350 Gigabit (10/100/1000 Mb/s) Ethernet Quad Port Controller for LAN ports 1/2, 3/4 (LAN ports 3/4: X9DRD-7LN4F).</li> <li>Nuvoton WPCM450 Base-board Controller (BMC) supports IPMI_LAN 2.0</li> </ul>					
<p><b>I/O Devices</b></p>	<p style="text-align: center;"><b>Serial_Link Connections</b></p> <table border="1" data-bbox="323 1219 933 1487"> <tr> <td data-bbox="323 1219 526 1295"> <ul style="list-style-type: none"> <li>SATA Ports</li> </ul> </td> <td data-bbox="530 1219 933 1295">           Two (2) SATA 3.0 Ports (I-SATA0/1)            Four (4) SATA 2.0 Ports (I-SATA2~5)         </td> </tr> <tr> <td data-bbox="323 1302 526 1487"> <ul style="list-style-type: none"> <li>SAS Connectors</li> </ul> </td> <td data-bbox="530 1302 933 1487">           Eight SAS 2.0 Connections (SAS 0~3, 4~7) from LSI 2308 SAS Controller.   <b>Note:</b> X9DRD-7LN4F supports SAS Firmware IR mode; X9DRD-7LN4F-JBOD supports SAS Firmware IT Mode.         </td> </tr> </table>		<ul style="list-style-type: none"> <li>SATA Ports</li> </ul>	Two (2) SATA 3.0 Ports (I-SATA0/1) Four (4) SATA 2.0 Ports (I-SATA2~5)	<ul style="list-style-type: none"> <li>SAS Connectors</li> </ul>	Eight SAS 2.0 Connections (SAS 0~3, 4~7) from LSI 2308 SAS Controller.  <b>Note:</b> X9DRD-7LN4F supports SAS Firmware IR mode; X9DRD-7LN4F-JBOD supports SAS Firmware IT Mode.
<ul style="list-style-type: none"> <li>SATA Ports</li> </ul>	Two (2) SATA 3.0 Ports (I-SATA0/1) Four (4) SATA 2.0 Ports (I-SATA2~5)					
<ul style="list-style-type: none"> <li>SAS Connectors</li> </ul>	Eight SAS 2.0 Connections (SAS 0~3, 4~7) from LSI 2308 SAS Controller.  <b>Note:</b> X9DRD-7LN4F supports SAS Firmware IR mode; X9DRD-7LN4F-JBOD supports SAS Firmware IT Mode.					

	<ul style="list-style-type: none"> <li>RAID                             <ul style="list-style-type: none"> <li>SATA RAID 0, 1, 5, 10 (Windows, Linux),</li> <li>SAS RAID 0, 1, 10 (X9DRD-7LN4F Only)</li> </ul> </li> </ul>
	<b>Integrated IPMI 2.0</b>
	<ul style="list-style-type: none"> <li>IPMI 2.0 supported by the WPCM450 BMC</li> </ul>
	<b>Serial (COM) Port</b>
	<ul style="list-style-type: none"> <li>Two (2) Fast UART 16550 Connection: 9-pin RS-232 port</li> </ul>
	<b>Super I/O</b>
	<ul style="list-style-type: none"> <li>Nuvoton 83527HG</li> </ul>
<b>Peripheral Devices</b>	<b>USB Devices</b>
	<ul style="list-style-type: none"> <li>Four (4) USB ports on the rear I/O panel (USB 0/1, USB 2/3),</li> <li>Four (4) USB connections for front access (USB 4/5, USB 8/9),</li> </ul>
	<ul style="list-style-type: none"> <li>One (1) Type A USB connection for front access (USB 6)</li> </ul>
<b>BIOS</b>	<ul style="list-style-type: none"> <li>16 MB SPI AMI BIOS<sup>®</sup> SM Flash BIOS</li> </ul>
	<ul style="list-style-type: none"> <li>APM 1.2, PCI 2.3, ACPI 1.0/2.0/3.0/4.0, USB Keyboard, Plug &amp; Play (PnP) and SMBIOS 2.7.1</li> </ul>
<b>Power Config.</b>	<ul style="list-style-type: none"> <li>ACPI/APM Power Management</li> </ul>
	<ul style="list-style-type: none"> <li>Main switch override mechanism</li> </ul>
	<ul style="list-style-type: none"> <li>Power-on mode for AC power recovery</li> <li>Intel<sup>®</sup> Intelligent Power Node Manager (NM) (Available when the NMView utility is installed in the system)</li> <li>Management Engine (ME)</li> </ul>
<b>PC Health Monitoring</b>	<b>CPU Monitoring</b>
	<ul style="list-style-type: none"> <li>Onboard voltage monitors for CPU Cores, +3.3V, 3.3VSB, +5V, +12V, -12V, VBT, and Memory Voltages</li> </ul>
	<ul style="list-style-type: none"> <li>CPU 5-Phase switching voltage regulator</li> </ul>
	<ul style="list-style-type: none"> <li>CPU/System overheat LED and control</li> </ul>
	<ul style="list-style-type: none"> <li>CPU Thermal Trip support</li> </ul>
	<ul style="list-style-type: none"> <li>Thermal Monitor 2 (TM2) support</li> </ul>
	<b>Fan Control</b>
	<ul style="list-style-type: none"> <li>Fan status monitoring with firmware fan speed control via IPMI</li> </ul>
	<ul style="list-style-type: none"> <li>Low noise fan speed control</li> </ul>

<b>System Management</b>	<ul style="list-style-type: none"> <li>• PECI (Platform Environment Configuration Interface) 2.0 support</li> </ul>
	<ul style="list-style-type: none"> <li>• UID (Unit Identification)/Remote UID</li> </ul>
	<ul style="list-style-type: none"> <li>• System resource alert via SuperDoctor® III</li> </ul>
	<ul style="list-style-type: none"> <li>• SuperDoctor® III, Watch Dog, NMI</li> </ul>
	<ul style="list-style-type: none"> <li>• Chassis Intrusion Header and Detection</li> </ul>
<b>Dimensions</b>	<ul style="list-style-type: none"> <li>• 13.00" (L) x 12.00" (W) (330.20 mm x 340.80 mm)</li> </ul>

 **Note 1:** For IPMI Configuration Instructions, please refer to the Embedded IPMI Configuration User's Guide available @ <http://www.supermicro.com/support/manuals/>.

**Note 2:** Changing BMC log-in information is recommended during initial system power-on. The default username is ADMIN and password is ADMIN. For BMC best practices, please refer to: [http://www.supermicro.com/products/nfo/files/IPMI/Best\\_Practices\\_BMC\\_Security.pdf](http://www.supermicro.com/products/nfo/files/IPMI/Best_Practices_BMC_Security.pdf)



## 1-2 Processor and Chipset Overview

Built upon the functionality and the capability of Intel E5-2600(v2) Series Processors (Socket R LGA 2011) and the C602J chipset, the X9DRD-EF/7LN4F-JBOD/-7LN4F motherboard provides the performance and feature sets required for dual processor-based HPC/Cluster/Database servers.

With support of Intel QuickPath interconnect (QPI) Technology, the X9DRD-EF/7LN4F-JBOD/-7LN4F offers point-to-point serial interconnect interface with a transfer speed of up to 8.0 GT/s, providing superb system performance.

The C602J chipset provides extensive IO support, including the following functions and capabilities:

- ACPI Power Management Logic Support, Rev. 4.0
- USB host interface with support of up to 9 connections
- Intel Rapid Storage Technology supported
- Intel Virtualization Technology for Directed I/O (Intel VT-d) supported
- Intel Trusted Execution Technology supported
- Serial Peripheral Interface (SPI) Supported
- Digital Media Interface (DMI) supported
- Advanced Host Controller Interface (AHCI) supported



**Note:** For Intel E5-2600(v2) processor support, BIOS version 3.0 or above is required.

## 1-3 Special Features

### Recovery from AC Power Loss

The Basic I/O System (BIOS) provides a setting that determines how the system will respond when AC power is lost and then restored to the system. You can choose for the system to remain powered off (in which case you must press the power switch to turn it back on), or for it to automatically return to the power-on state. See the Advanced BIOS Setup section for this setting. The default setting is **Last State**.

## 1-4 PC Health Monitoring

This section describes the features of PC health monitoring of the motherboard. This motherboard has an onboard System\_Hardware\_Monitor chip that supports PC health monitoring. An onboard voltage monitor will scan voltages and power usage continuously. Once a voltage becomes unstable, a warning is given, or an error message is sent to the screen. The user can adjust the voltage thresholds to define the sensitivity of the voltage monitor.

### Environmental Temperature Control

A thermal control sensor monitors the CPU temperature in real time and will turn on the thermal control fan whenever the CPU temperature exceeds a user-defined threshold. The thermal management runs independently from the CPU. Once it detects that the CPU temperature is too high, it will automatically turn on the thermal fan control to prevent the CPU from overheating. The onboard chassis thermal circuitry can monitor the overall system temperature and alert the user when the chassis temperature is too high.



**Note:** To avoid possible system overheating, please be sure to provide adequate airflow to your system.

### System Resource Alert

This feature is available when used with SuperDoctor<sup>®</sup> III in the Windows OS environment or used with SuperDoctor II in Linux. SuperDoctor is used to notify the user of certain system events. For example, you can configure SuperDoctor to provide you with warnings when the system temperature, CPU temperatures, voltages, and fan speeds go beyond a predefined range.



## 1-5 ACPI Features

ACPI stands for Advanced Configuration and Power Interface. The ACPI specification defines a flexible and abstract hardware interface that provides a standard way to integrate power management features throughout a PC system, including its hardware, operating system and application software. This enables the system to automatically turn on and off peripherals such as CD-ROMs, network cards, hard disk drives and printers.

In addition to operating system-directed power management, ACPI also provides a generic system event mechanism for Plug and Play, and an operating system-independent interface for configuration control. ACPI leverages the Plug and Play BIOS data structures, while providing a processor architecture-independent implementation that is compatible with Windows 7, Windows Vista and Windows 2008 Operating Systems.

### Slow Blinking LED for Suspend-State Indicator

When the CPU goes into a suspend state, the chassis power LED will start blinking to indicate that the CPU is in suspend mode. When the user presses any key, the CPU will "wake up," and the LED will automatically stop blinking and remain on.

## 1-6 Power Supply

As with all computer products, a stable power source is necessary for proper and reliable operation. It is even more important for processors that have high CPU clock rates.

The X9DRD-7LN4F-JBOD/7LN4F motherboard accommodates 24-pin ATX power supplies. Although most power supplies generally meet the specifications required by the CPU, some are inadequate. In addition, two 12V 8-pin, and the 4-pin power connections are also required to ensure adequate power supply to the system. Your power supply must also supply 1.5A for the Ethernet ports.

**Warning:** To avoid damaging your motherboard and components, please use a power supply that supports a 24-pin, two 8-pin and one 4-pin power connectors. Be sure to connect the 24-pin and the 8-pin power connectors to your power supply for adequate power delivery to your system. The 4-pin power connector is optional; however, Supermicro recommends that this connector also be plugged in for optimal power delivery.

It is strongly recommended that you use a high quality power supply that meets ATX power supply Specification 2.02 or above. It must also be SSI compliant. (For more information, please refer to the website at <http://www.ssiforum.org/>). Additionally, in

areas where noisy power transmission is present, you may choose to install a line filter to shield the computer from noise. It is recommended that you also install a power surge protector to help avoid problems caused by power surges.

## 1-7 Super I/O

The Super I/O supports two high-speed, 16550 compatible serial communication ports (UARTs). Each UART includes a 16-byte send/receive FIFO, a programmable baud rate generator, complete modem control capability, and a processor interrupt system. Both UARTs provide legacy speed with baud rate of up to 115.2 Kbps as well as an advanced speed with baud rates of 250 K, 500 K, or 1 Mb/s, which support higher speed modems.

The Super I/O provides functions that comply with ACPI (Advanced Configuration and Power Interface), which includes support of legacy and ACPI power management through an SMI or SCI function pin. It also features auto power management to reduce power consumption.

## 1-8 Advanced Power Management

The new advanced power management features supported by this motherboard include IPNM and ME. Please note that you will need to do the following to use these two new features:

- Use a power supply that supports PMBus 1.1 or 1.2.
- Install the NMView software in your system. NMView is optional and can be purchased from Supermicro.

### Intel<sup>®</sup> Intelligent Power Node Manager (IPNM)

The Intel<sup>®</sup> Intelligent Power Node Manager (IPNM) provides your system with real-time thermal control and power management for maximum energy efficiency. Although IPNM is supported by the BMC (Baseboard Management Controller), your system must also have IPNM-compatible Management Engine (ME) firmware installed in your system for IPNM support.



**Note:** Support for IPNM Specification Version 1.5 or Vision 2.0 depends on the power supply used in the system.

## Management Engine (ME)

The Management Engine, which is an ARC controller embedded in the PCH, provides Server Platform Services (SPS) to your system. The services provided by SPS are different from those provided by the ME on client platforms.

### 1-9 Overview of the Nuvoton WPCM450 Controller

The Nuvoton WPCM450 Controller, a Baseboard Management Controller (BMC), supports 2D/VGA-compatible Graphic Cores with PCI interface, creating multi-media virtualization via Keyboard/Video/Mouse Redirection (KVMR). The WPCM450 Controller is ideal for remote system management.

The WPCM450 Controller interfaces with the host system via PCI connections to communicate with the graphics cores. It supports USB 2.0 and 1.1 for remote keyboard/mouse/virtual media emulation. It also provides LPC interface support to control Super IO functions. The WPCM450 Controller is connected to the network via an external Ethernet PHY module or shared NCSI connections.

The WPCM450 communicates with onboard components via six SMBus interfaces, PECCI (Platform Environment Control Interface) buses, and General Purpose I/O ports.

#### Other Features Supported by the WPCM BMC Controller

The WPCM450 supports the following features:

- IPMI 2.0
- Serial over LAN
- KVM over LAN
- LAN Alerting-SNMP Trap
- Event Log
- X-Bus parallel interface for I/O expansion
- Multiple ADC inputs, Analog and Digital Video outputs
- SPI Flash Host BIOS and firmware bootstrap program supported
- Reduced Media Independent Interface (RMII)
- OS (Operating System) Independency

- Provides remote Hardware Health Monitoring via IPMI. Key features
- Provides Network Management Security via remote access/console redirection.
- Supports the following Management tools: IPMIView, CLI (Command Line Interface)
- RMCP+ protocol supported



**Note 1:** For more information on IPMI configuration, please refer to the IPMI User's Guide posted on our website at <http://www.supermicro.com/support/manuals/>.

**Note 2:** The term "IPMI controller" and the term "BMC controller" can be used interchangeably in this section.

---

## Chapter 2

### Installation

#### 2-1 Standardized Warning Statements

The following statements are industry-standard warnings, provided to warn the user of situations which have the potential for bodily injury. Should you have questions or experience difficulty, contact Supermicro's Technical Support department for assistance. Only certified technicians should attempt to install or configure components.

Read this section in its entirety before installing or configuring components in the Supermicro chassis.

#### Battery Handling



##### Warning!

There is a danger of explosion if the battery is replaced incorrectly. Replace the battery only with the same or equivalent type recommended by the manufacturer. Dispose of used batteries according to the manufacturer's instructions

##### 電池の取り扱い

電池交換が正しく行われなかった場合、破裂の危険性があります。交換する電池はメーカーが推奨する型、または同等のものを使用下さい。使用済電池は製造元の指示に従って処分して下さい。

##### 警告

電池更換不當會有爆炸危險。請只使用同類電池或製造商推薦的功能相當的電池更換原有電池。請按製造商的說明處理廢舊電池。

##### 警告

電池更換不當會有爆炸危險。請使用製造商建議之相同或功能相當的電池更換原有電池。請按照製造商的說明指示處理廢棄舊電池。

##### Warnung

Bei Einsetzen einer falschen Batterie besteht Explosionsgefahr. Ersetzen Sie die Batterie nur durch den gleichen oder vom Hersteller empfohlenen Batterietyp. Entsorgen Sie die benutzten Batterien nach den Anweisungen des Herstellers.

Attention

Danger d'explosion si la pile n'est pas remplacée correctement. Ne la remplacer que par une pile de type semblable ou équivalent, recommandée par le fabricant. Jeter les piles usagées conformément aux instructions du fabricant.

¡Advertencia!

Existe peligro de explosión si la batería se reemplaza de manera incorrecta. Reemplazar la batería exclusivamente con el mismo tipo o el equivalente recomendado por el fabricante. Desechar las baterías gastadas según las instrucciones del fabricante.

**אזהרה!**

קיימת סכנת פיצוץ של הסוללה במידה והוחלפה בדרך לא תקינה. יש להחליף את הסוללה בסוג התואם מחברת יצרן מומלצת.

סילוק הסוללות המושמשות יש לבצע לפי הוראות היצרן.

هناك خطر من انفجار في حالة استبدال البطارية بطريقة غير صحيحة فعليك استبدال البطارية فقط بنفس النوع أو ما يعادلها كما أوصت به الشركة المصنعة تخلص من البطاريات المستعملة وفقا لتعليمات الشركة الصانعة

경고!

배터리가 올바르게 교체되지 않으면 폭발의 위험이 있습니다. 기존 배터리와 동일하거나 제조사에서 권장하는 동등한 종류의 배터리로만 교체해야 합니다. 제조사의 안내에 따라 사용된 배터리를 처리하여 주십시오.

Waarschuwing

Er is ontploffingsgevaar indien de batterij verkeerd vervangen wordt. Vervang de batterij slechts met hetzelfde of een equivalent type die door de fabrikant aanbevolen wordt. Gebruikte batterijen dienen overeenkomstig fabrieksvoorschriften afgevoerd te worden.

## Product Disposal



### Warning!

Ultimate disposal of this product should be handled according to all national laws and regulations.

### 製品の廃棄

この製品を廃棄処分する場合、国の関係する全ての法律・条例に従い処理する必要があります。

### 警告

本产品的废弃处理应根据所有国家的法律和规章进行。

### 警告

本產品的廢棄處理應根據所有國家的法律和規章進行。

### Warnung

Die Entsorgung dieses Produkts sollte gemäß allen Bestimmungen und Gesetzen des Landes erfolgen.

### ¡Advertencia!

Al deshacerse por completo de este producto debe seguir todas las leyes y reglamentos nacionales.

### Attention

La mise au rebut ou le recyclage de ce produit sont généralement soumis à des lois et/ou directives de respect de l'environnement. Renseignez-vous auprès de l'organisme compétent.

## סילוק המוצר

### אזהרה!

סילוק סופי של מוצר זה חייב להיות בהתאם להנחיות וחוקי המדינה.

عند التخلص النهائي من هذا المنتج ينبغي التعامل معه وفقا لجميع القوانين واللوائح الوطنية

#### Waarschuwing

De uiteindelijke verwijdering van dit product dient te geschieden in overeenstemming met alle nationale wetten en reglementen.

## 2-2 Static-Sensitive Devices

Electrostatic Discharge (ESD) can damage electronic components. To avoid damaging your system board, it is important to handle it very carefully. The following measures are generally sufficient to protect your equipment from ESD.

### Precautions

- Use a grounded wrist strap designed to prevent static discharge.
- Touch a grounded metal object before removing the board from the antistatic bag.
- Handle the board by its edges only; do not touch its components, peripheral chips, memory modules or gold contacts.
- When handling chips or modules, avoid touching their pins.
- Put the motherboard and peripherals back into their antistatic bags when not in use.
- For grounding purposes, make sure that your system chassis provides excellent conductivity between the power supply, the case, the mounting fasteners and the motherboard.

### Unpacking

The motherboard is shipped in antistatic packaging to avoid static damage. When unpacking the board, make sure that the person handling it is static protected.



## 2-3 Processor and Heatsink Installation

**Warning:** When handling the processor package, avoid placing direct pressure on the label area.

 **Notes:**

- Always connect the power cord last, and always remove it before adding, removing or changing any hardware components. Make sure that you install the processor into the CPU socket before you install the CPU heatsink.
- If you buy a CPU separately, make sure that you use an Intel-certified multi-directional heatsink only.
- Make sure to install the motherboard into the chassis before you install the CPU heatsink.
- When receiving a motherboard without a processor pre-installed, make sure that the plastic CPU socket cap is in place and none of the socket pins are bent; otherwise, contact your retailer immediately.
- Refer to the Supermicro website for updates on CPU support.

### Installing the LGA2011 Processor

1. There are two load levers on the LGA2011 socket. To open the socket cover, first press and release the load lever labeled 'Open 1st'.

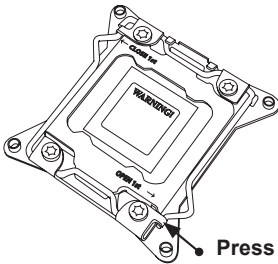
**1**

Press down  
on Load Lever  
labeled 'Open 1st'.

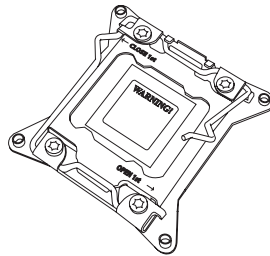
**2**

2. Press the second load lever labeled 'Close 1st' to release the load plate that covers the CPU socket from its locking position.

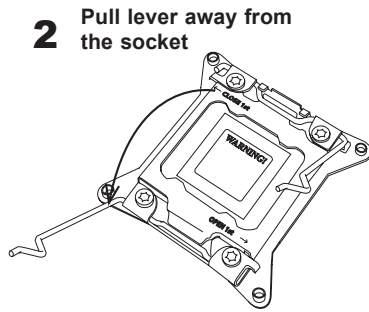
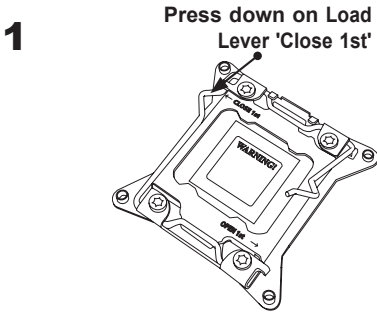

3. With the lever labeled 'Close 1st' fully retracted, gently push down on the lever labelled 'Open 1st' to open the load plate. Lift the load plate to open it completely.

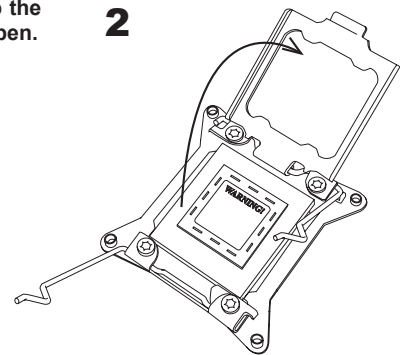
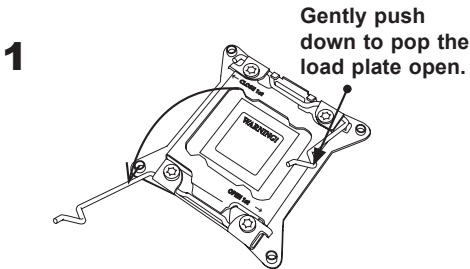

1. Use your thumb, and index fingers to loosen the lever and open the load plate.

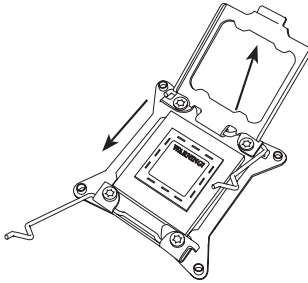

2. Using your thumb and index finger, hold the CPU on its edges. Align the CPU keys, which are semi-circle cutouts, against the socket keys.

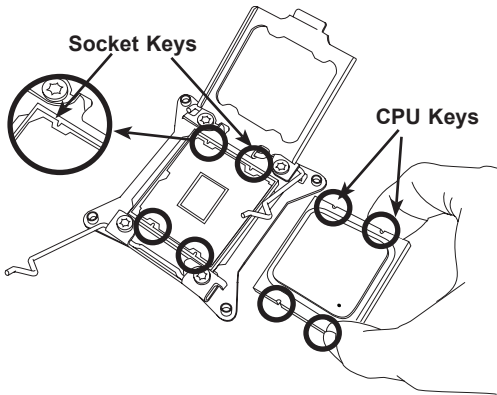

3. Once they are aligned, carefully lower the CPU straight down into the socket. (Do not drop the CPU on the socket. Do not move the CPU horizontally or vertically. Do not rub the CPU against the surface or against any pins of the socket to avoid damaging the CPU or the socket.)

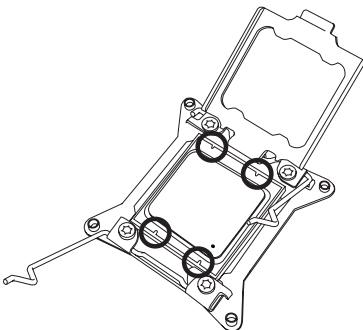

**Warning:** You can only install the CPU inside the socket in one direction. Make sure that it is properly inserted into the CPU socket before closing the load plate. If it doesn't close properly, do not force it as it may damage your CPU. Instead, open the load plate again to make sure that the CPU is aligned properly.

4. With the CPU inside the socket, inspect the four corners of the CPU to make sure that the CPU is properly installed.
5. Close the load plate with the CPU inside the socket. Lock the lever labelled 'Close 1st' first, then lock the lever labelled 'Open 1st' second. Using your thumb gently push the load levers down to the lever locks.

**1** Gently close the load plate.

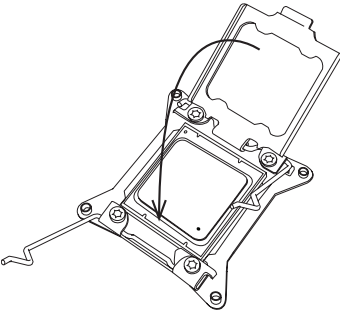

**2** Push down and lock the lever labelled 'Close 1st'.

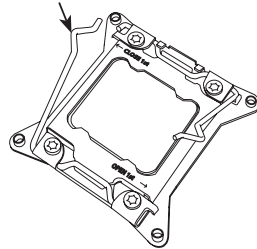

**3** Push down and lock the lever labelled 'Open 1st'.

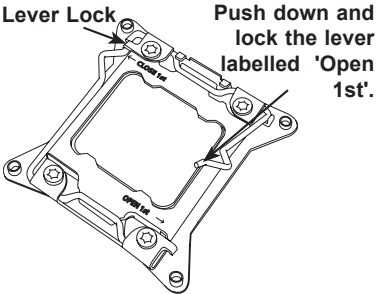

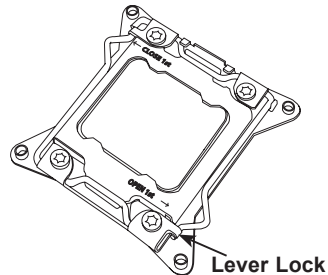

**4**

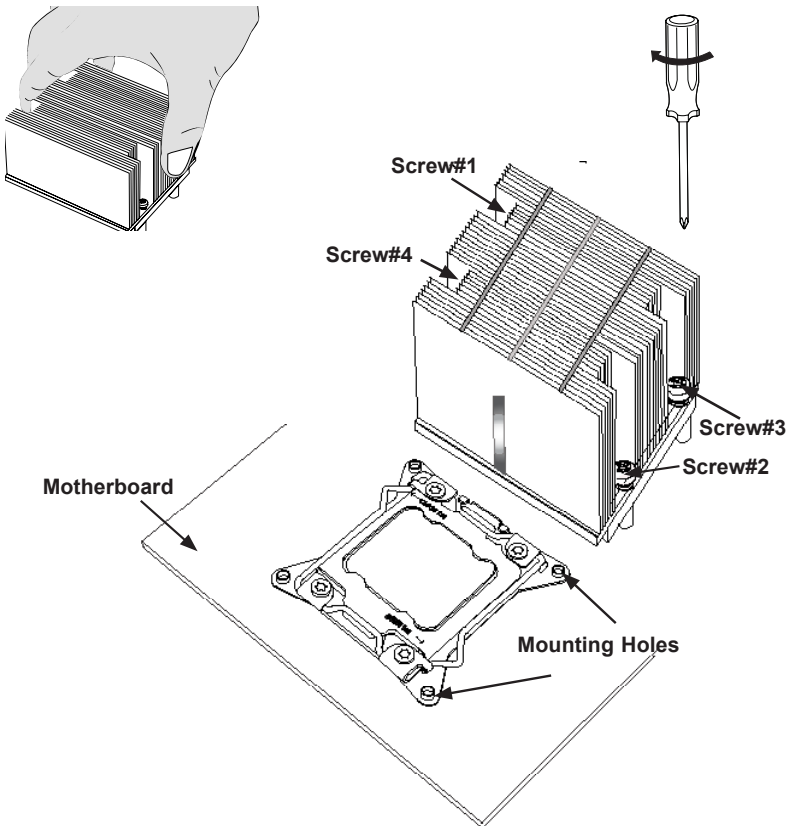

## Installing a Passive CPU Heatsink

1. Do not apply any thermal grease to the heatsink or the CPU die -- the required amount has already been applied.
2. Place the heatsink on top of the CPU so that the four mounting holes are aligned with those on the Motherboard's and the Heatsink Bracket underneath.
3. Screw in two diagonal screws (i.e., the #1 and the #2 screws) until just snug (-do not over-tighten the screws to avoid possible damage to the CPU.)
4. Finish the installation by fully tightening all four screws.



 **Notes:** 1. For optimized airflow, please follow your chassis airflow direction to install the correct CPU heatsink direction. 2. Graphic drawings included in this manual are for reference only. They might look different from the components installed in your system.

## Removing the Heatsink

**Warning:** We do not recommend that the CPU or the heatsink be removed. However, if you do need to uninstall the heatsink, please follow the instructions below to uninstall the heatsink to prevent damage done to the CPU or the CPU socket.

1. Unscrew the heatsink screws from the motherboard in the sequence as shown in the illustration below.
2. Gently wriggle the heatsink to loosen it from the CPU. (Do not use excessive force when wriggling the heatsink!)
3. Once the CPU is loosened, remove the CPU from the CPU socket.
4. Remove the used thermal grease and clean the surface of the CPU and the heatsink, Reapply the proper amount of thermal grease on the surface before reinstalling the CPU and the heatsink. (Do not reuse old thermal grease.)

Loosen screws  
in sequence as  
shown.

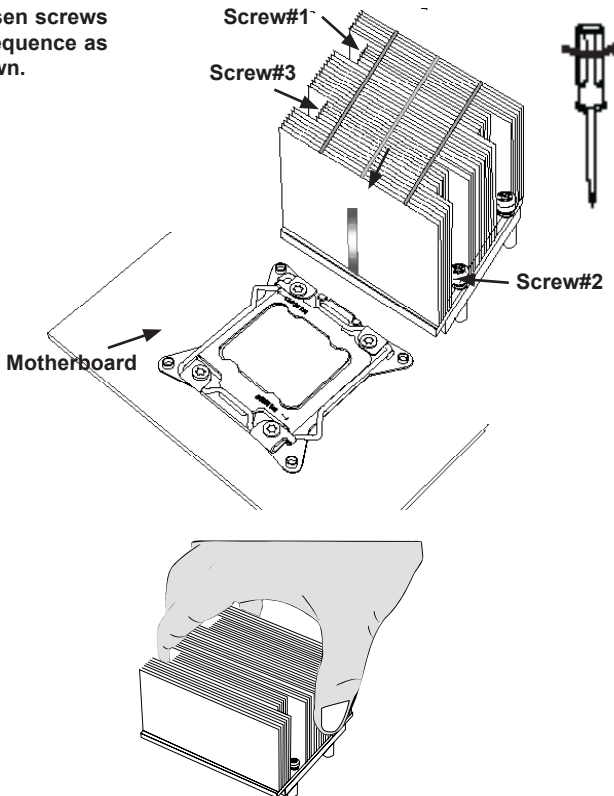

**⚠ Do not reuse thermal grease!**

## 2-4 Installing and Removing the Memory Modules

 **Note:** Check Supermicro's website for recommended memory modules.

### CAUTION

Exercise extreme care when installing or removing DIMM modules to prevent any possible damage.

### Installing & Removing DIMMs

1. Insert the desired number of DIMMs into the memory slots, starting with P1-DIMMA1.
2. Push the release tabs outwards on both ends of the DIMM slot to unlock it.

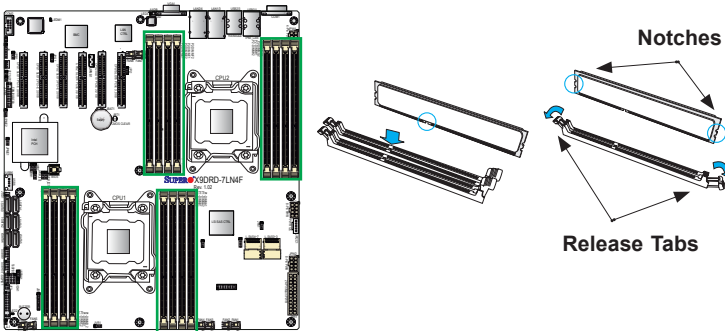

3. Align the key of the DIMM module with the receptive point on the memory slot.
4. Align the notches on both ends of the module against the receptive points on the ends of the slot.
5. Use two thumbs together to press the notches on both ends of the module straight down into the slot until the module snaps into place.
6. Press the release tabs to the locking positions to secure the DIMM module into the slot.

Press both notches straight down into the memory slot at the same time.

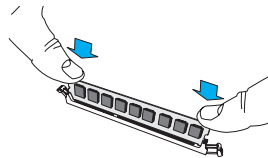

### Removing Memory Modules

Press both notches on the ends of the DIMM module to unlock it. Once it is loosened, once it is loosened, remove it from the memory slot.

## Memory Support for the X9DRD-EF/7LN4F-JBOD/7LN4F/ Motherboard

The X9DRD-EF/7LN4F-JBOD/7LN4F motherboard supports up to 1 TB of Load Reduced (LRDIMM), 512 GB of Registered (RDIMM) or 128 GB of Unbuffered (UDIMM) ECC/Non-ECC DDR3 800/1066/1333/1600/1866 MHz 240-pin 4-channel memory modules in 16 DIMM slots.

 **Note:** For the latest memory updates, please refer to the Tested Memory List posted on our website (<http://www.supermicro.com/products/motherboard>).

### Processor & Memory Module Population Configuration

For memory to work properly, follow the tables below for memory installation.

Processors and their Corresponding Memory Modules								
CPU#	Corresponding DIMM Modules							
CPU 1	P1- DIMMA1	P1- DIMMB1	P1- DIMMC1	P1- DIMMD1	P1- DIMMA2	P1- DIMMB2	P1- DIMMC2	P1- DIMMD2
CPU2	P2- DIMME1	P2- DIMMF1	P2- DIMMG1	P2- DIMMH1	P2- DIMME2	P2- DIMM F2	P2- DIMMG2	P2- DIMMH2

Processor and Memory Module Population for Optimal Performance	
Number of CPUs+DIMMs	CPU and Memory Population Configuration Table (For memory to work properly, please follow the instructions below.)
1 CPU & 2 DIMMs	CPU1 P1-DIMMA1/P1-DIMMB1
1 CPU & 4 DIMMs	CPU1 P1-DIMMA1/P1-DIMMB1, P1-DIMMC1/P1-DIMMD1
1 CPU & 5-8 DIMMs	CPU1 P1-DIMMA1/P1-DIMMB1, P1-DIMMC1/P1-DIMMD1 + Any memory pairs in P1-DIMMA2/P1-DIMMB2/P1-DIMMC2/P1-DIMMD2 slots
2 CPUs & 4 DIMMs	CPU1 + CPU2 P1-DIMMA1/P1-DIMMB1, P2-DIMME1/P2-DIMMF1
2 CPUs & 6 DIMMs	CPU1 + CPU2 P1-DIMMA1/P1-DIMMB1/P1-DIMMC1/P1-DIMMD1, P2-DIMME1/P2-DIMMF1
2 CPUs & 8 DIMMs	CPU1 + CPU2 P1-DIMMA1/P1-DIMMB1/P1-DIMMC1/P1-DIMMD1, P2-DIMME1/P2-DIMMF1/P2-DIMMG1/P2-DIMMH1
2 CPUs & 10-16 DIMMs	CPU1/CPU2 P1-DIMMA1/P1-DIMMB1/P1-DIMMC1/P1-DIMMD1, P2-DIMME1/P2-DIMMF1/P2-DIMMG1/P2-DIMMH1 + Any memory pairs in P1, P2 DIMM slots
2 CPUs & 16 DIMMs	CPU1/CPU2 P1-DIMMA1/P1-DIMMB1/P1-DIMMC1/P1-DIMMD1, P2-DIMME1/P2-DIMMF1/P2-DIMMG1/P2-DIMMH1, P1-DIMMA2/P1-DIMMB2/P1-DIMMC2/P1-DIMMD2, P2-DIMME2/P2-DIMMF2/P2-DIMMG2/P2-DIMMH2

 **Notes:** 1866 MHz memory speed is dependent on Intel E5-2600v2 CPUs. For Intel E5-2600(v2) processor support, BIOS version 3.0 or above is required.



### Populating UDIMM (ECC/Non-ECC) Memory Modules

<b>Intel E5-2600(v2) Series Processor UDIMM Memory Support</b>											
Ranks Per DIMM & Data Width	Memory Capacity Per DIMM (See the Note below)			Speed (MT/s) and Voltage Validated by Slot per Channel (SPC) and DIMM Per Channel (DPC)							
				2 Slots Per Channel				3 Slots Per Channel			
	1DPC		2DPC		1DPC		2DPC				
	1.35V	1.5V	1.35V	1.5V	1.35V	1.5V	1.35V	1.5V			
<b>SRx8 Non-ECC</b>	1GB	2GB	4GB	NA	1066, 1333, 1600, 1866	NA	1066, 1333, 1600	N/A	1066, 1333, 1600, 1866	N/A	1066, 1333, 1600
<b>DRx8 Non-ECC</b>	2GB	4GB	8GB	NA	1066, 1333, 1600, 1866	NA	1066, 1333, 1600	N/A	1066, 1333, 1600, 1866	N/A	1066, 1333, 1600
<b>SRx16 Non-ECC</b>	512MB	1GB	2GB	NA	1066, 1333, 1600, 1866	NA	1066, 1333, 1600	N/A	1066, 1333, 1600, 1866	N/A	1066, 1333, 1600
<b>SRx8 ECC</b>	1GB	2GB	4GB	1066, 1333	1066, 1333, 1600, 1866	1066, 1333	1066, 1333, 1600	1066, 1333	1066, 1333, 1600, 1866	1066, 1333	1066, 1333, 1600
<b>DRx8 ECC</b>	2GB	4GB	8GB	1066, 1333	1066, 1333, 1600, 1866	1066, 1333	1066, 1333, 1600	1066, 1333	1066, 1333, 1600, 1866	1066, 1333	1066, 1333, 1600

**Note:** For detailed information on memory support and updates, please refer to the SMC Recommended Memory List posted on our website at <http://www.supermicro.com/support/resources/mem.cfm>.

### Populating RDIMM (ECC) Memory Modules

<b>Intel E5-2600(v2) Series Processor RDIMM Memory Support</b>											
Ranks Per DIMM & Data Width	Memory Capacity Per DIMM (See the Note Below)			Speed (MT/s) and Voltage Validated by Slot per Channel (SPC) and DIMM Per Channel (DPC)							
				2 Slots Per Channel				3 Slots Per Channel			
	1DPC		2DPC		1 DPC		2DPC		3DPC		
	1.35V	1.5V	1.35V	1.5V	1.35V	1.5V	1.35V	1.5V	1.35V	1.5V	
<b>SRx8</b>	1GB	2GB	4GB	1066, 1333	1066, 1333, 1600, 1866	1066, 1333	1066, 1333, 1600	1066, 1333	1066, 1333, 1600, 1866	1066, 1333, 1600	800, 1066
<b>DRx8</b>	2GB	4GB	8GB	1066, 1333	1066, 1333, 1600, 1866	1066, 1333	1066, 1333, 1600	1066, 1333	1066, 1333, 1600, 1866	1066, 1333, 1600	800, 1066
<b>SRx4</b>	2GB	4GB	8GB	1066, 1333	1066, 1333, 1600, 1866	1066, 1333	1066, 1600	1066, 1333	1066, 1333, 1600, 1866	1066, 1333, 1600	800, 1066
<b>DRx4</b>	4GB	8GB	16GB	1066, 1333	1066, 1333, 1600, 1866	1066, 1333	1066, 1600	1066, 1333	1066, 1333, 1600, 1866	1066, 1333, 1600	800, 1066
<b>QRx4</b>	8GB	16GB	32GB	800, 1066	800, 1066	800, 1066	800, 1066	800, 1066	800, 1066	800, 1066	N/A, N/A
<b>QRx8</b>	4GB	8GB	16GB	800, 1066	800, 1066	800, 1066	800, 1066	800, 1066	800, 1066	800, 1066	N/A, N/A

**Note:** For detailed information on memory support and updates, please refer to the SMC Recommended Memory List posted on our website at <http://www.supermicro.com/support/resources/mem.cfm>.

*Populating UDIMM (ECC/Non-ECC) Memory Modules*

Intel E5-2600 Series Processor UDIMM Memory Support											
Ranks Per DIMM & Data Width	Memory Capacity Per DIMM  (See the Note below)			Speed (MT/s) and Voltage Validated by Slot per Channel (SPC) and DIMM Per Channel (DPC)							
				2 Slots Per Channel				3 Slots Per Channel			
	1DPC		2DPC		1DPC		2DPC				
	1.35V	1.5V	1.35V	1.5V	1.35V	1.5V	1.35V	1.5V			
SRx8 Non-ECC	1GB	2GB	4GB	NA	1066, 1333	NA	1066, 1333	N/A	1066, 1333,	N/A	1066, 1333
DRx8 Non-ECC	2GB	4GB	8GB	NA	1066, 1333	NA	1066, 1333	N/A	1066, 1333,	N/A	1066, 1333
SRx16 Non-ECC	512MB	1GB	2GB	NA	1066, 1333	NA	1066, 1333	N/A	1066, 1333	N/A	1066, 1333
SRx8 ECC	1GB	2GB	4GB	1066, 1333	1066, 1333	1066	1066, 1333	1066	1066, 1333,	1066, 1333	1066, 1333
DRx8 ECC	2GB	4GB	8GB	1066, 1333	1066, 1333	1066	1066, 1333	1066	1066, 1333,	1066, 1333	1066, 1333

**Note:** For detailed information on memory support and updates, please refer to the SMC Recommended Memory List posted on our website at <http://www.supermicro.com/support/resources/mem.cfm>.

*Populating RDIMM (ECC) Memory Modules*

Intel E5-2600 Series Processor RDIMM Memory Support													
Ranks Per DIMM & Data Width	Memory Capacity Per DIMM  (See the Note Below)			Speed (MT/s) and Voltage Validated by Slot per Channel (SPC) and DIMM Per Channel (DPC)									
				2 Slots Per Channel				3 Slots Per Channel					
	1DPC		2DPC		1 DPC		2DPC		3DPC				
	1.35V	1.5V	1.35V	1.5V	1.35V	1.5V	1.35V	1.5V	1.35V	1.5V	1.35V	1.5V	
SRx8	1GB	2GB	4GB	1066, 1333	1066, 1333, 1600	1066, 1333	1066, 1333, 1600	1066, 1333	1066, 1333, 1600	1066, 1333	1066, 1333, 1600	N/A	800, 1066
DRx8	2GB	4GB	8GB	1066, 1333	1066, 1333, 1600	1066, 1333	1066, 1333, 1600	1066, 1333	1066, 1333, 1600	1066, 1333	1066, 1333, 1600	N/A	800, 1066
SRx4	2GB	4GB	8GB	1066, 1333	1066, 1333, 1600	1066, 1333	1066, 1333, 1600	1066, 1333	1066, 1333, 1600	1066, 1333	1066, 1333, 1600	N/A	800, 1066
DRx4	4GB	8GB	16GB	1066, 1333	1066, 1333, 1600	1066, 1333	1066, 1333, 1600	1066, 1333	1066, 1333, 1600	1066, 1333	1066, 1333, 1600	N/A	800, 1066
QRx4	8GB	16GB	32GB	800	1066	800	800	800	1066	800	800	N/A	N/A
QRx8	4GB	8GB	16GB	800	1066	800	800	800	1066	800	800	N/A	N/A

**Note:** For detailed information on memory support and updates, please refer to the SMC Recommended Memory List posted on our website at <http://www.supermicro.com/support/resources/mem.cfm>.

### Populating LRDIMM (ECC) Memory Modules

Intel E5-2600(v2) Series Processor LRDIMM Memory Support												
Ranks Per DIMM & Data Width	Memory Capacity Per DIMM (See the Note Below)		Speed (MT/s) and Voltage Validated by Slot per Channel (SPC) and DIMM Per Channel (DPC)									
			2 Slots Per Channel				3 Slots Per Channel					
			1DPC		2DPC		1DPC		2DPC		3DPC	
			1.35V	1.5V	1.35V	1.5V	1.35V	1.5V	1.35V	1.5V	1.35V	1.5V
QRx4 (DDP)	16GB	32GB	1066, 1333, 1600	1066, 1333, 1600, 1866	1066, 1333, 1600	1066, 1333, 1600	1066, 1333, 1600	1066, 1333, 1600, 1866	1066, 1333, 1600	1066, 1333, 1600	1066	1066
8Rx4 (QDP)	32GB	64GB	1066	1066	1066	1066	1066	1066	1066	1066	1066	1066

**Note:** For detailed information on memory support and updates, please refer to the SMC Recommended Memory List posted on our website at <http://www.supermicro.com/support/resources/mem.cfm>.

Intel E5-2600 Series Processor LRDIMM Memory Support												
Ranks Per DIMM & Data Width	Memory Capacity Per DIMM (See the Note Below)		Speed (MT/s) and Voltage Validated by Slot per Channel (SPC) and DIMM Per Channel (DPC)									
			2 Slots Per Channel				3 Slots Per Channel					
			1DPC		2DPC		1DPC		2DPC		3DPC	
			1.35V	1.5V	1.35V	1.5V	1.35V	1.5V	1.35V	1.5V	1.35V	1.5V
QRx4 (DDP)	16GB	32GB	1066	1066, 1333	1066	1066, 1333	1066	1066, 1333	1066	1066, 1333	1066	1066
QRx8 (QDP)	8GB	16GB	1066	1066, 1333	1066	1066, 1333	1066	1066	1066	1066	1066	1066

**Note:** For detailed information on memory support and updates, please refer to the SMC Recommended Memory List posted on our website at <http://www.supermicro.com/support/resources/mem.cfm>.



#### Other Important Notes and Restrictions

- For the memory modules to work properly, please install DIMM modules of the same type, same speed and same operating frequency on the motherboard. Mixing of RDIMMs, UDIMMs or LRDIMMs is not allowed. Do not install both ECC and Non-ECC memory modules on the same motherboard.
- Using DDR3 DIMMs with different operating frequencies is not allowed. All channels in a system will run at the lowest common frequency.

## 2-5 Motherboard Installation

All motherboards have standard mounting holes to fit different types of chassis. Make sure that the locations of all the mounting holes for both motherboard and chassis match. Although a chassis may have both plastic and metal mounting fasteners, metal ones are highly recommended because they ground the motherboard to the chassis. Make sure that the metal standoffs click in or are screwed in tightly. Then use a screwdriver to secure the motherboard onto the motherboard tray.

### Tools Needed

- Phillips Screwdriver
- Pan head screws (9 pieces)
- Standoffs (9 pieces, if needed)

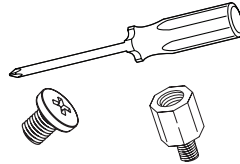

### Location of Mounting Holes

There are nine (9) mounting holes on this motherboard. See the layout on the right.

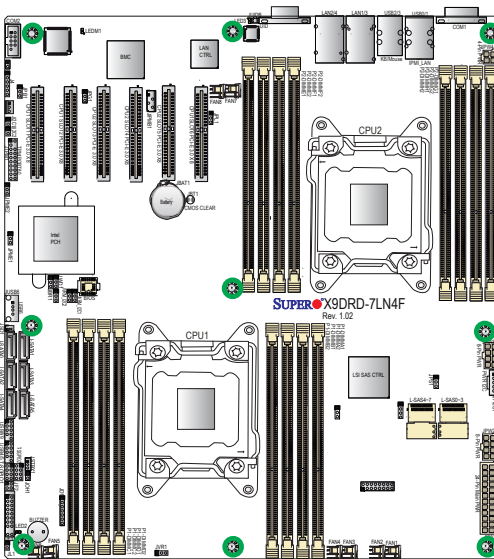

**Warning:** 1) To avoid damaging the motherboard and its components, please do not use a force greater than 8 lb/inch on each mounting screw during motherboard installation. 2) Some components are very close to the mounting holes. Please take precautionary measures to prevent damage to these components when installing the motherboard to the chassis.

## Installing the Motherboard

1. Install the I/O shield into the chassis.

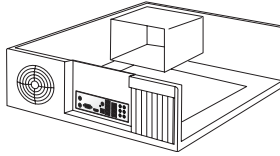

2. Locate the mounting holes on the motherboard.
3. Locate the matching mounting holes on the chassis. Align the mounting holes on the motherboard against the mounting holes on the chassis.
4. Install standoffs in the chassis as needed.

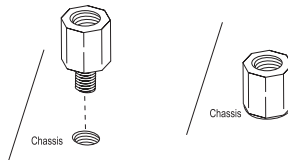

5. Install the motherboard into the chassis carefully to avoid damaging motherboard components.
6. Using the Phillips screwdriver, insert a Pan head #6 screw into a mounting hole on the motherboard and its matching mounting hole on the chassis.

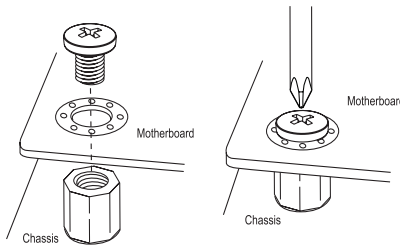

7. Repeat Step 5 to insert #6 screws into all mounting holes.
8. Make sure that the motherboard is securely placed in the chassis.

 **Note:** Images displayed are for illustration only. Your chassis or components might look different from those shown in this manual.

## 2-6 Control Panel Connectors and I/O Ports

The I/O ports are color coded in conformance with the PC 99 specification. See the picture below for the colors and locations of the various I/O ports.

### Back Panel Connectors and I/O Ports

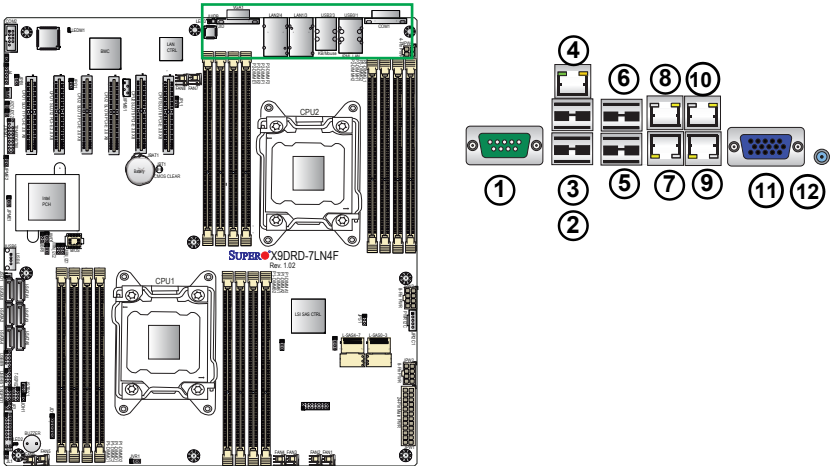

### Back Panel I/O Port Locations and Definitions

1. COM Port 1 (Turquoise)
2. Back Panel USB Port 0
3. Back Panel USB Port 1
4. IPMI_Dedicated LAN
5. Back Panel USB Port 2
6. Back Panel USB Port 3
7. Gigabit LAN 1
8. Gigabit LAN 3
9. Gigabit LAN 2
10. Gigabit LAN 4
11. Back Panel VGA (Blue)
12. UID Switch

## Serial Ports

Two COM connections (COM1 & COM2) are located on the motherboard. COM1 is located on the Backplane I/O panel. COM2, located close to CPU1 Slot1, provides front access support. See the table on the right for pin definitions.

Serial COM) Ports Pin Definitions			
Pin #	Definition	Pin #	Definition
1	DCD	6	DSR
2	RXD	7	RTS
3	TXD	8	CTS
4	DTR	9	RI
5	Ground	10	N/A

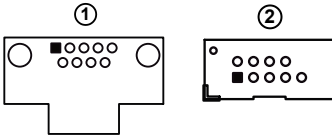

## Video Connection

A Video (VGA) port is located next to LAN3/4 on the I/O backplane. Refer to the board layout below for the location.

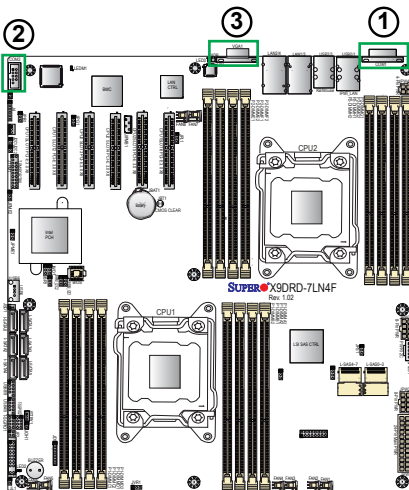

1. COM1
2. COM2
3. VGA



### Universal Serial Bus (USB)

Four Universal Serial Bus ports (USB 0/1, USB 2/3) are located on the I/O back panel. In addition, three USB headers, located close to the IO Hub, provides four front-accessible USB connections (USB 4/5, USB 8/9). One Type A connector (USB6) also supports front panel USB connection. (Cables are not included). See the tables on the right for pin definitions.

Backplane USB (0/1, 2/3) Pin Definitions	
Pin#	Definition
1	+5V
2	PO-
3	PO+
4	Ground
5	NA

FP USB (4/5, 8/9, USB 6) Pin Definitions			
USB 4, 8, 6, Pin # Definition		USB 5, 9 Pin # Definition	
1	+5V	1	+5V
2	PO-	2	PO-
3	PO+	3	PO+
4	Ground	4	Ground
5	NC	5	Key

(NC= No connection)

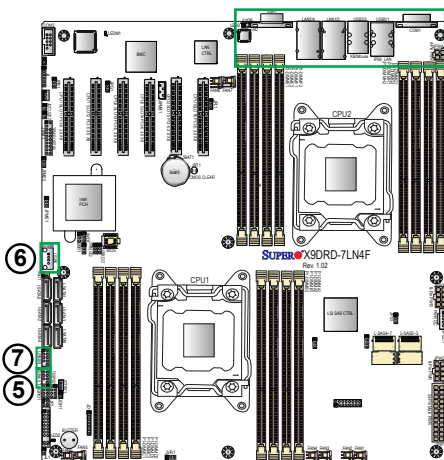

1. Backplane USB 0
2. BP USB 1
3. BP USB 2
4. BP USB 3
5. FP USB 4/5
6. FP USB 8/9
7. FP USB 6

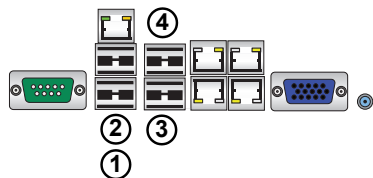



## Ethernet Ports

Four Gigabit Ethernet ports (LAN1/2, LAN3/4) are located on the I/O backplane on the motherboard. In addition, an IPMI\_Dedicated LAN is located above USB 0/1 ports on the backplane to provide KVM support for IPMI 2.0. All these ports accept RJ45 type cables. Please refer to the LED Indicator Section for LAN LED information.

 **Note:** LAN3/4 are available only on the X9DRD-7LN4F-JBOD/7LN4F.

LAN Ports Pin Definition			
Pin#	Definition		
1	P2V5SB	10	SGND
2	TD0+	11	Act LED
3	TD0-	12	P3V3SB
4	TD1+	13	Link 100 LED (Yellow, +3V3SB)
5	TD1-	14	Link 1000 LED (Yellow, +3V3SB)
6	TD2+	15	Ground
7	TD2-	16	Ground
8	TD3+	17	Ground
9	TD3-	18	Ground

(NC: No Connection)

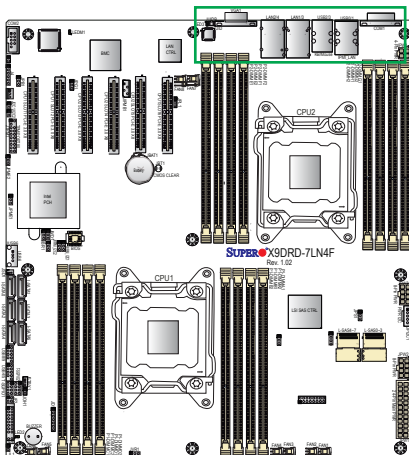

1. GLAN1
2. GLAN3
3. GLAN2
4. GLAN4
5. IPMI\_LAN

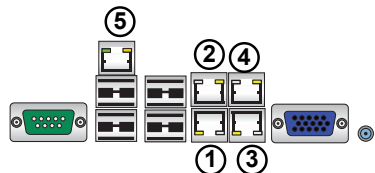

### Unit Identifier Switch/UID LED Indicators

A Unit Identifier (UID) Switch and two LED Indicators are located on the motherboard. The UID Switch is located next to the VGA port on the backplane. The Rear UID LED (LED3) is located next to the UID Switch. The Front Panel UID LED is located at pins 7/8 of the Front Control Panel at JF1. Connect a cable to pin 8 on JF1 for Front Panel UID LED indication. When you press the UID switch, both Rear UID LED and Front Panel UID LED Indicators will be turned on. Press the UID switch again to turn off both LED Indicators. These UID Indicators provide easy identification of a system unit that may be in need of service.

 **Note:** UID can also be triggered via IPMI on the motherboard. For more information on IPMI, please refer to the IPMI User's Guide posted on our website @ <http://www.supermicro.com>.

UID Switch	
Pin#	Definition
1	Ground
2	Ground
3	Button In
4	Ground

UID LED (LED3) Status	
Color/State	Status
Blue: On	Unit Identified

1. UID Switch
2. Rear UID LED (LED3)
3. Front UID LED

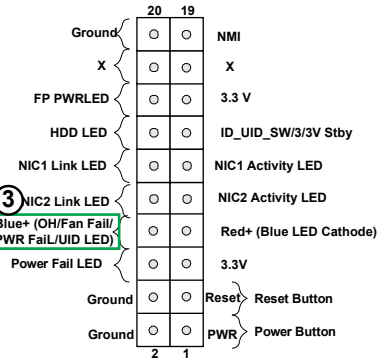
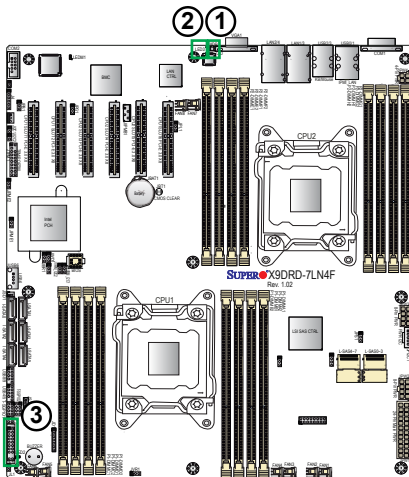

## Front Control Panel

JF1 contains header pins for various buttons and indicators that are normally located on a control panel at the front of the chassis. These connectors are designed specifically for use with Supermicro's server chassis. See the figure below for the descriptions of the various control panel buttons and LED indicators. Refer to the following section for descriptions and pin definitions.

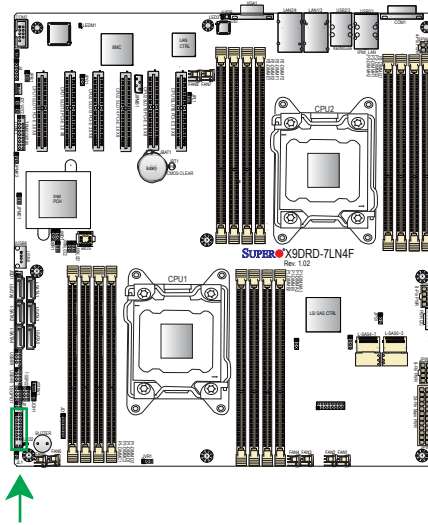

JF1 Header Pins

	20	19	
Ground	○	○	NMI
X	○	○	X
FP PWRLED	○	○	3.3 V
HDD LED	○	○	ID_UID_SW/3/3V Stby
NIC1 Link LED	○	○	NIC1 Activity LED
NIC2 Link LED	○	○	NIC2 Activity LED
Blue+ (OH/Fan Fail/ PWR Fail/UID LED)	○	○	Red+ (Blue LED Cathode)
Power Fail LED	○	○	3.3V
Ground	○	○	Reset } Reset Button
Ground	○	○	PWR } Power Button
	2	1	

## Front Control Panel Pin Definitions

### NMI Button

The non-maskable interrupt button header is located on pins 19 and 20 of JF1. Refer to the table on the right for pin definitions.

NMI Button Pin Definitions (JF1)	
Pin#	Definition
19	Control
20	Ground

### Power LED

The Power LED connection is located on pins 15 and 16 of JF1. Refer to the table on the right for pin definitions.

Power LED Pin Definitions (JF1)	
Pin#	Definition
15	3.3V
16	PWR LED

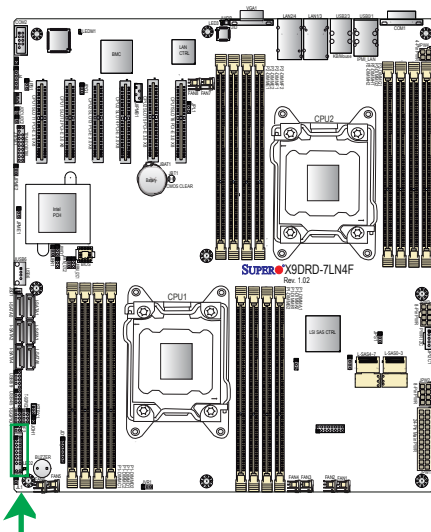

A. NMI

B. PWR LED

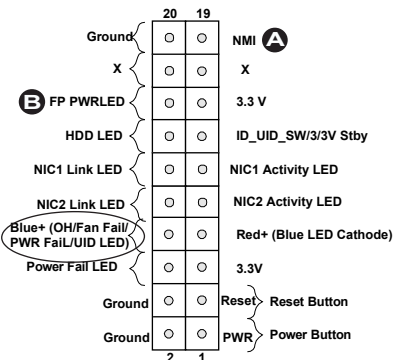

## HDD LED

The HDD LED connection is located on pins 13 and 14 of JF1. Attach a cable here to indicate HDD activity. See the table on the right for pin definitions.

HDD LED Pin Definitions (JF1)	
Pin#	Definition
13	3.3V Standby
14	HD Active

## NIC1/NIC2 LED Indicators

The NIC (Network Interface Controller) LED connection for GLAN port 1 is located on pins 11 and 12 of JF1, and the LED connection for GLAN Port 2 is on Pins 9 and 10. Attach the NIC LED cables here to display network activity. Refer to the table on the right for pin definitions.

GLAN1/2 LED Pin Definitions (JF1)	
Pin#	Definition
9	Vcc
10	NIC 2 LED
11	Vcc
12	NIC 1 LED

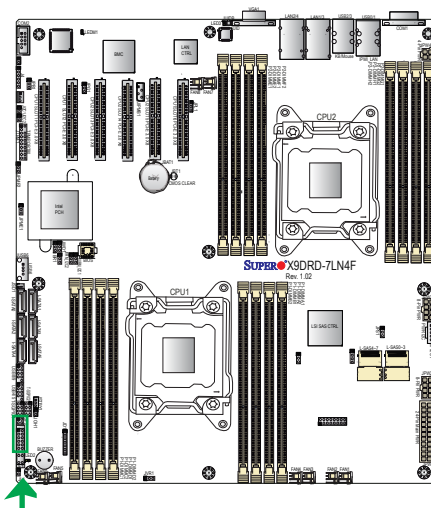

A. HDD LED

B. NIC1 LED

C. NIC2 LED

Ground	20	19	NMI
X	○	○	X
FP PWRLD	○	○	3.3 V
<b>A</b> HDD LED	○	○	ID_UID_SW/3/3V Stby
<b>B</b> NIC1 Link LED	○	○	NIC1 Activity LED
<b>C</b> NIC2 Link LED	○	○	NIC2 Activity LED
Blue+ (OH/Fan Fail/ PWR Fail/UID LED)	○	○	Red+ (Blue LED Cathode)
Power Fail LED	○	○	3.3V
Ground	○	○	Reset} Reset Button
Ground	○	○	PWR} Power Button
	2	1	

### Overheat (OH)/Fan Fail/PWR Fail/UID LED

Connect an LED cable to pins 7 and 8 of Front Control Panel to use the Overheat/Fan Fail/Power Fail and UID LED connections. The Red LED on pin 7 provides warnings of overheat, fan failure or power failure. The Blue LED on pin 8 works as the front panel UID LED indicator. The Red LED takes precedence over the Blue LED by default. Refer to the table on the right for pin definitions.

OH/Fan Fail/ PWR Fail/Blue_UID LED Pin Definitions (JF1)	
Pin#	Definition
7	Red_LED-Cathode/OH/Fan Fail/Power Fail5.5V.SB
8	Blue_UID LED

OH/Fan Fail/PWR Fail LED Status (Red LED)	
State	Definition
Off	Normal
On	Overheat
Flashing	Fan Fail

### Power Fail LED

The Power Fail LED connection is located on pins 5 and 6 of JF1. Refer to the table on the right for pin definitions.

PWR Fail LED Pin Definitions (JF1)	
Pin#	Definition
5	3.3V
6	PWR Supply Fail

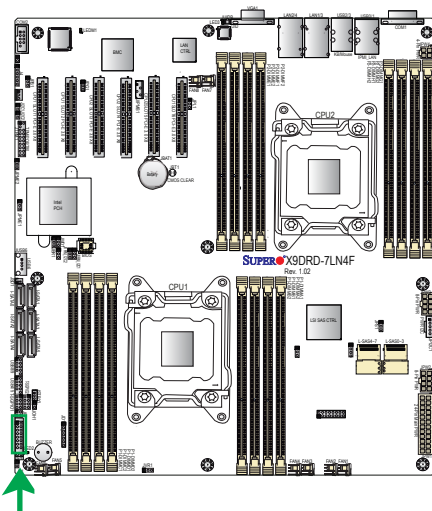

- A. OH/Fail/PWR Fail LED
- B. PWR Supply Fail

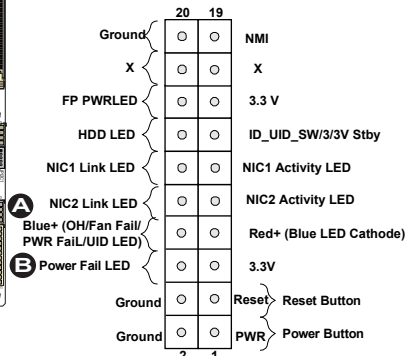

## Reset Button

The Reset Button connection is located on pins 3 and 4 of JF1. Attach it to a hardware reset switch on the computer case. Refer to the table on the right for pin definitions.

Reset Button Pin Definitions (JF1)	
Pin#	Definition
3	Reset
4	Ground

## Power Button

The Power Button connection is located on pins 1 and 2 of JF1. Momentarily contacting both pins will power on/off the system. This button can also be configured to function as a suspend button (with a setting in the BIOS - See Chapter 4). To turn off the power when the system is in suspend mode, press the button for 4 seconds or longer. Refer to the table on the right for pin definitions.

Power Button Pin Definitions (JF1)	
Pin#	Definition
1	Signal
2	Ground

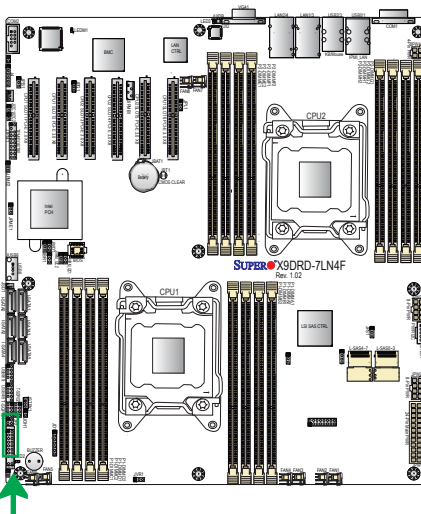

### A. Reset Button

### B. PWR Button

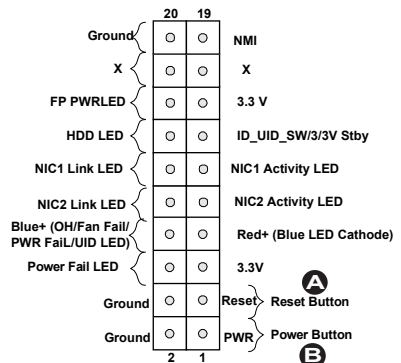

## 2-7 Connecting Cables

### Power Connectors

A 24-pin main power supply connector(JPW1), two 8-pin CPU power connectors (JPW2/3) and a 4-pin power connector (JPW4) are located on the motherboard. These power connectors meet the SSI EPS 12V specification and must be connected to your power supply to provide adequate power to the system. See the table on the right for pin definitions.

**Warning:** To avoid damaging your motherboard and components, please use a power supply that supports a 24-pin, two 8-pin and one 4-pin power connectors. Be sure to connect the 24-pin and the 8-pin power connectors to your power supply for adequate power delivery to your system. The 4-pin power connector is optional; however, Supermicro recommends that this connector also be plugged in for optimal power delivery.

ATX Power 24-pin Connector Pin Definitions			
Pin#	Definition	Pin #	Definition
13	+3.3V	1	+3.3V
14	-12V	2	+3.3V
15	COM	3	COM
16	PS_ON	4	+5V
17	COM	5	COM
18	COM	6	+5V
19	COM	7	COM
20	Res (NC)	8	PWR_OK
21	+5V	9	5VSB
22	+5V	10	+12V
23	+5V	11	+12V
24	COM	12	+3.3V

12V 8-pin PWR Connector Pin Definitions	
Pins	Definition
1 through 4	Ground
5 through 8	+12V

(Required)

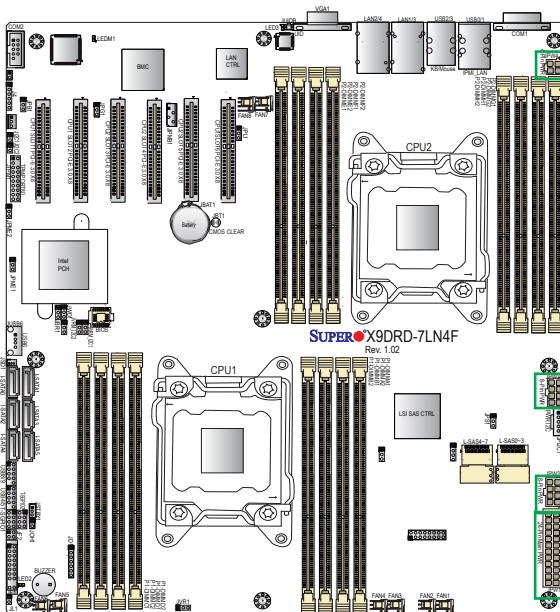

- A. JPW1: 24-pin ATX PWR (Req'd)
- B. JPW2: 8-pin Processor PWR (Req'd)
- C. JPW3: 8-pin Processor PWR (Req'd)
- D. JPW4: 4-pin Processor PWR (Req'd)
- E. JPW5: 4-pin Processor PWR (Req'd)



## Fan Headers

This motherboard has eight system/CPU fan headers (Fan 1~Fan 8) on the motherboard. All these 4-pin fans headers are backward compatible with the traditional 3-pin fans. However, fan speed control is available for 4-pin fans only. The fan speeds are controlled by Thermal Management via IPMI interface. (See Chapter 5 for more details.) See the table on the right for pin definitions.

Fan Header Pin Definitions	
Pin#	Definition
1	Ground
2	+12V
3	Tachometer
4	PWR Modulation

## Chassis Intrusion

A Chassis Intrusion header is located at JL1 on the motherboard. Attach an appropriate cable from the chassis to inform you of a chassis intrusion when the chassis is opened.

Chassis Intrusion Pin Definitions	
Pin#	Definition
1	Intrusion Input
2	Ground

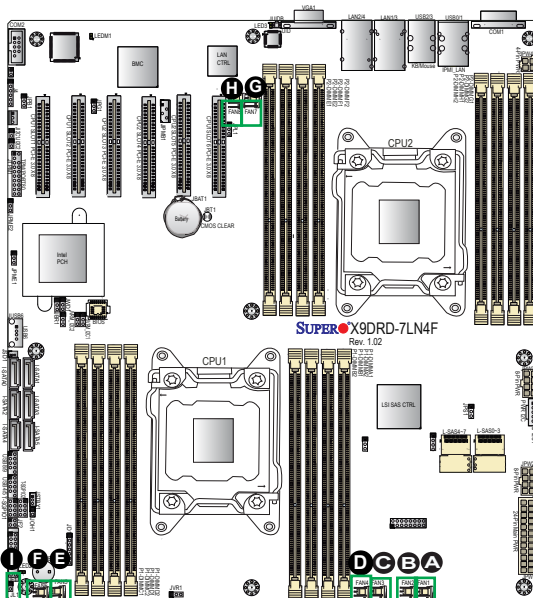

- A. Fan 1
- B. Fan 2
- C. Fan 3
- D. Fan 4
- E. Fan 5
- F. Fan 6
- G. Fan 7
- H. Fan 8
- I. Chassis Intrusion

### Internal Speaker

The Internal Speaker, located at SP1, can be used to provide audible indications for various beep codes. See the table on the right for pin definitions. Refer to the layout below for the locations of the Internal Buzzer (SP1).

Internal Buzzer (SP1) Pin Definition		
Pin#	Definitions	
Pin 1	Pos. (+)	Beep In
Pin 2	Neg. (-)	Alarm Speaker

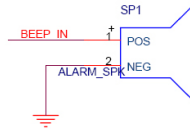

### Power LED/Speaker

On JD1 header, pins 1-3 are used for power LED indication, and pins 4-7 are for the speaker. See the tables on the right for pin definitions. Please note that the speaker connector pins (4-7) are used with an external speaker. If you wish to use the on-board speaker, you should close pins 6-7 with a jumper.

PWR LED Connector Pin Definitions	
Pin Setting	Definition
Pin 1	Anode (+)
Pin2	Cathode (-)
Pin3	NA

Speaker Connector Pin Settings	
Pin Setting	Definition
Pins 4-7	External Speaker
Pins 6-7	Internal Speaker

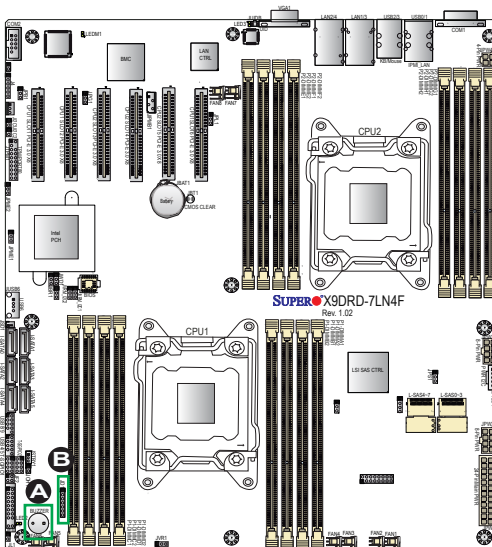

A. Internal Speaker (Buzzer)

B. PWR LED/Speaker

### TPM Header/Port 80

A Trusted Platform Module/Port 80 header is located at JTPM1 to provide TPM support and Port 80 connection. Use this header to enhance system performance and data security. See the table on the right for pin definitions.

TPM/Port 80 Header Pin Definitions			
Pin #	Definition	Pin #	Definition
1	LCLK	2	GND
3	LFRAME#	4	<(KEY)>
5	LRESET#	6	+5V (X)
7	LAD 3	8	LAD 2
9	+3.3V	10	LAD1
11	LAD0	12	GND
13	SMB_CLK4	14	SMB_DAT4
15	+3V_DUAL	16	SERIRQ
17	GND	18	CLKRUN# (X)
19	LPCPD#	20	LDRQ# (X)

### Overheat LED/Fan Fail

The JOH1 header is used to connect an LED indicator to provide warnings of chassis overheating and fan failure. This LED will blink when a fan failure occurs. Refer to the tables on right for pin definitions.

Overheat LED Pin Definitions	
Pin#	Definition
1	5vDC
2	OH Active

OH/Fan Fail LED Status	
State	Message
Solid	Overheat
Blinking	Fan Fail

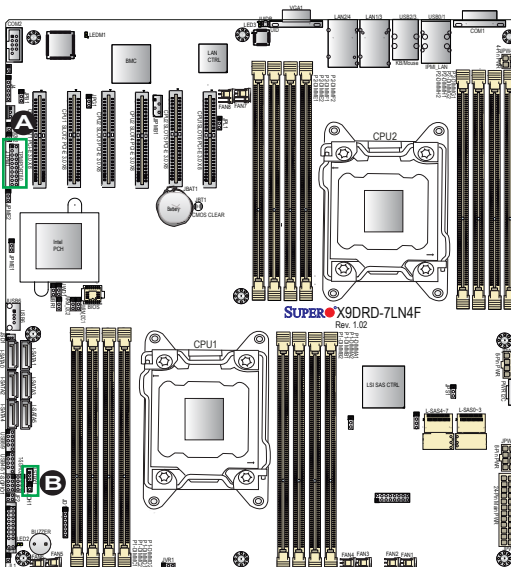

A. TPM/Port 80 Header

B. JOH1

**Power SMB (I<sup>2</sup>C) Connector**

Power System Management Bus (I<sup>2</sup>C) Connector (JPI<sup>2</sup>C1) monitors power supply, fan and system temperatures. See the table on the right for pin definitions.

PWR SMB Pin Definitions	
Pin#	Definition
1	Clock
2	Data
3	PWR Fail
4	Ground
5	+3.3V

**IPMB**

A System Management Bus header for IPMI 2.0 is located at JIPMB1. Connect the appropriate cable here to use the IPMB I<sup>2</sup>C connection on your system.

IPMB Header Pin Definitions	
Pin#	Definition
1	Data
2	Ground
3	Clock
4	No Connection

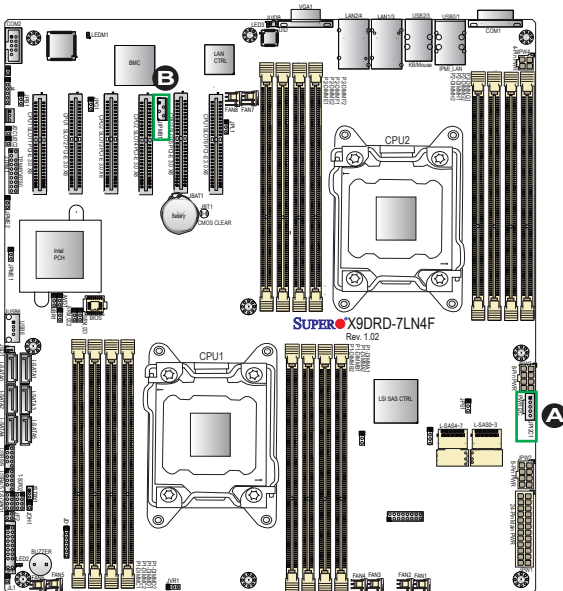

A. JPI<sup>2</sup>C1

B. JIPMB1

### T-SGPIO 1/2 Headers

Two SGPIO (Serial Link General Purpose Input/Output) headers are located on the motherboard. T-SGPIO 1/2 provide onboard SATA support on the motherboard. See the table on the right for pin definitions.

T-SGPIO 1/2 Pin Definitions			
Pin#	Definition	Pin	Definition
1	NC	2	NC
3	Ground	4	Data
5	Load	6	Ground
7	Clock	8	NC

**Note:** NC= No Connection

### DOM Power Connector

A power connector for SATA DOM (Disk\_On\_Module) devices is located at JSD1. Connect an appropriate cable here to provide power support for your Serial Link DOM devices.

DOM PWR Pin Definitions	
Pin#	Definition
1	+5V
2	Ground
3	Ground

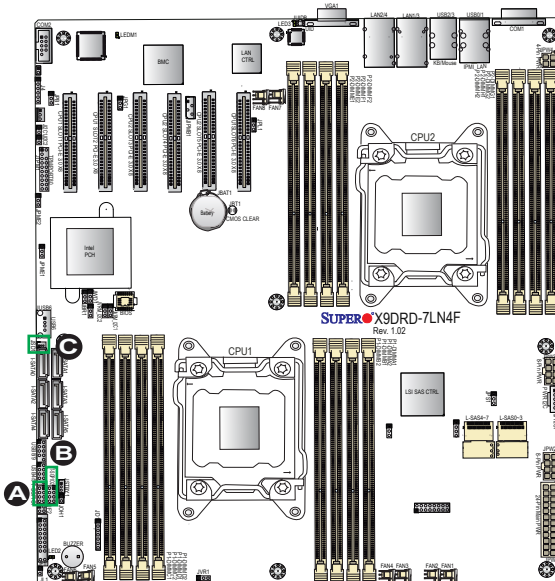

A. T-SGPIO1

B. T-SGPIO2

C. DOM PWR

### Standby Power Header

The +5V Standby Power header is located at JSTBY1 on the motherboard. See the table on the right for pin definitions. (You must also have a card with a Standby Power connector and a cable to use this feature.)

Standby PWR Pin Definitions	
Pin#	Definition
1	+5V Standby
2	Ground
3	Wake-up

### LAN3/LAN4 LED Indicators

The NIC (Network Interface Controller) LED connections for LAN Port 3 are located on pins 3 and 4 of JF2, and the LED connections for LAN Port 4 is on pins 1 and 2 of JF2. Attach NIC LED cables here to display network activities. Refer to the table on the right for pin definitions.

LAN Ports 3/4 LED Indicators (JF2) Pin Definitions			
Pin#	Definition	Pin	Definition
1	LAN4 Activity	2	LAN4 Link
3	LAN3 Activity	4	LAN3 Link

 **Note:** The NIC LED connections for LAN Ports 1/2 are located on JF1. See Page 2-25 for details.

A. Standby PWR

B. LAN3/LAN4 LED (X9DRD-7LN4F-JBOD/7LN4F)

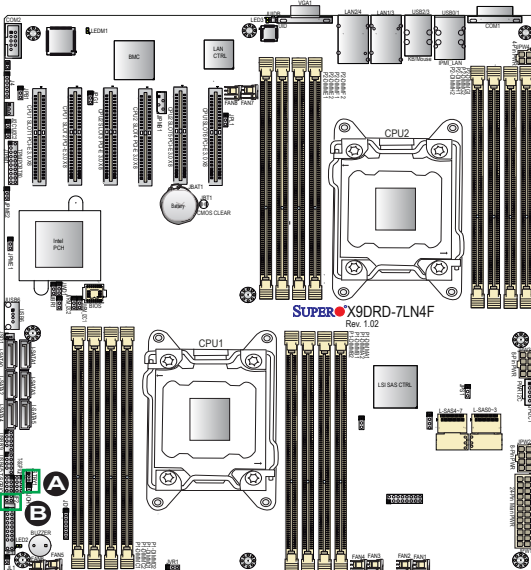

## 2-8 Jumper Settings

### Explanation of Jumpers

To modify the operation of the motherboard, jumpers can be used to choose between optional settings. Jumpers create shorts between two pins to change the function of the connector. Pin 1 is identified with a square solder pad on the printed circuit board. See the motherboard layout pages for jumper locations.

 **Note:** On two-pin jumpers, "Closed" means the jumper is on and "Open" means the jumper is off the pins.

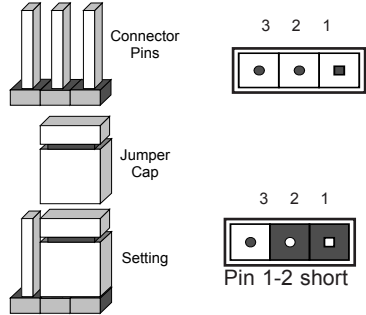

### GLAN Enable/Disable

JPL1 enables or disables the GLAN Ports 1/2 and GLAN Ports 3/4 on the motherboard. See the table on the right for jumper settings. The default setting is Enabled.

#### GLAN Enable Jumper Settings

GLAN Enable Jumper Settings	
Jumper Setting	Definition
1-2	Enabled (default)
2-3	Disabled

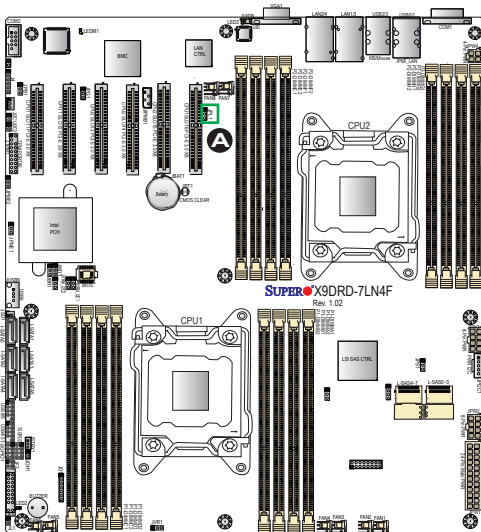

#### A. GLAN Ports Enable

### CMOS Clear

JBT1 is used to clear CMOS. Instead of pins, this "jumper" consists of contact pads to prevent accidental clearing of CMOS. To clear CMOS, use a metal object such as a small screwdriver to touch both pads at the same time to short the connection. Always remove the AC power cord from the system before clearing CMOS. ⌚

 **Note 1:** For an ATX power supply, you must completely shut down the system, remove the AC power cord, and then short JBT1 to clear CMOS.

**Note 2:** Be sure to remove the onboard CMOS Battery before you short JBT1 to clear CMOS.

**Note 3:** Clearing CMOS will also clear all passwords.

### Watch Dog Enable/Disable

Watch Dog (JWD1) is a system monitor that will reboot the system when a software application hangs. Close pins 1-2 to reset the system if an application hangs. Close pins 2-3 to generate a non-maskable interrupt signal for the application that hangs. See the table on the right for jumper settings. Watch Dog must also be enabled in the BIOS.

Watch Dog Jumper Settings	
Jumper Setting	Definition
Pins 1-2	Reset (default)
Pins 2-3	NMI
Open	Disabled

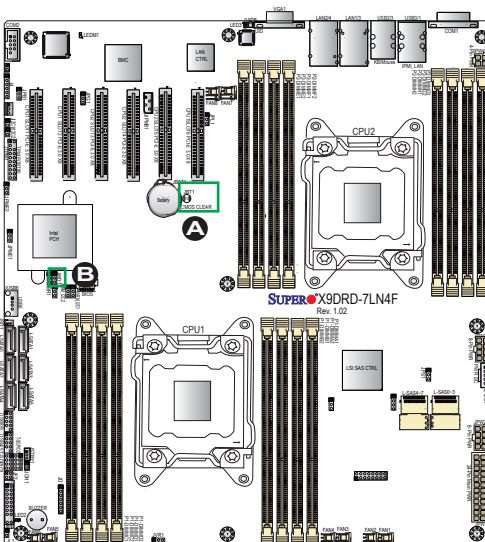

A. Clear CMOS

B. Watch Dog Enable



## VGA Enable

Jumper JPG1 allows the user to enable the onboard VGA connector. The default setting is 1-2 to enable the connection. See the table on the right for jumper settings.

VGA Enable Jumper Settings	
Jumper Setting	Definition
1-2	Enabled (Default)
2-3	Disabled

## BMC Enable

Jumper JPB1 allows you to enable the embedded WPCM 450 BMC (Baseboard Management) Controller to provide IPMI 2.0/KVM support on the motherboard. See the table on the right for jumper settings.

BMC Enable Jumper Settings	
Jumper Setting	Definition
Pins 1-2	BMC Enable (Default)
Pins 2-3	Normal

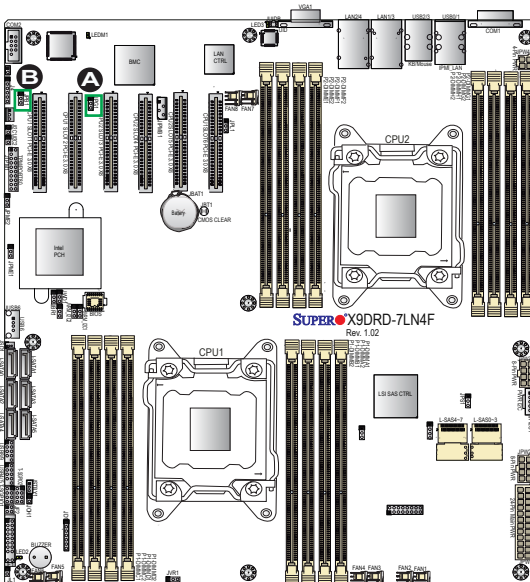

A. VGA Enabled

B. BMC Enabled

### Management Engine (ME) Recovery

Use Jumper JPME1 to select ME Firmware Recovery mode, which will limit resource allocation for essential system operation only in order to maintain normal power operation and management. In the single operation mode, online upgrade will be available via Recovery mode. See the table on the right for jumper settings.

ME Recovery Jumper Settings	
Jumper Setting	Definition
1-2	Normal (Default)
2-3	ME Recovery

### Manufacture Mode Select

Close pins 2 and 3 of Jumper JPME2 to bypass SPI flash security and force the system to operate in the Manufacture Mode, allowing the user to flash the system firmware from a host server for system setting modifications. See the table on the right for jumper settings.

ME Mode Select Jumper Settings	
Jumper Setting	Definition
1-2	Normal (Default)
2-3	Manufacture Mode

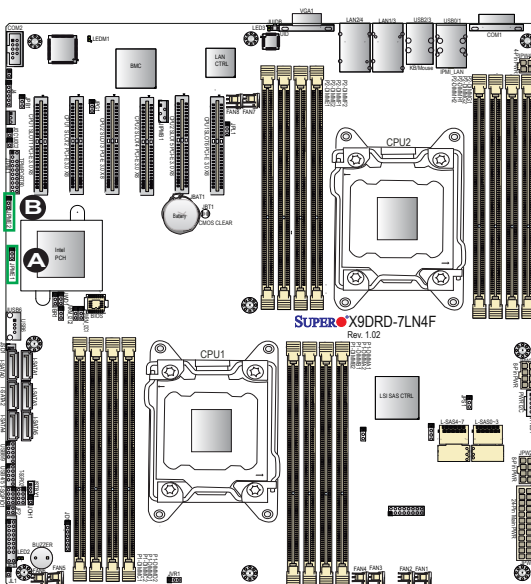

A. JPME1

B. JPME2

## I<sup>2</sup>C Bus to PCI-Exp. Slots

Use Jumpers JI<sup>2</sup>C1 and JI<sup>2</sup>C2 to connect the System Management Bus (I<sup>2</sup>C) to PCI-Express slots in order to improve PCI slot performance. These two jumpers are to be set at the same time. The default setting is Closed to enable the connections. See the table on the right for jumper settings.

I <sup>2</sup> C to PCI-E slots Jumper Settings	
Jumper Setting	Definition
Closed	Enabled (Default)
Open	Disabled

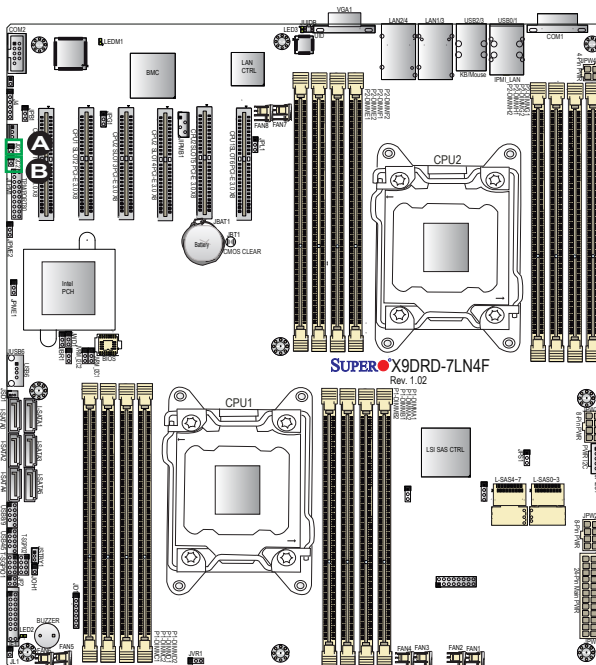

A. JI<sup>2</sup>C1

B. JI<sup>2</sup>C2

## 2-9 Onboard LED Indicators

### GLAN LEDs

The Gigabit LAN ports are located on the IO Backplane on the motherboard. Each Ethernet LAN port has two LEDs. The Yellow LED indicates activity. The Link LED may be green, amber or off to indicate the speed of the connection. See the tables on the right for more information.

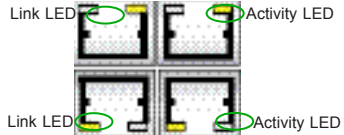

**Rear View** (when facing the rear side of the chassis)

GLAN Activity Indicator (Left) LED Settings		
Color	Status	Definition
Yellow	Flashing	Active

GLAN Link Indicator LED Settings	
LED Color	Definition
Off	No Connection or 10 Mbps
Green	100 Mbps
Amber	1 Gbps

### IPMI Dedicated LAN LEDs

In addition to LAN 1/LAN 2, an IPMI Dedicated LAN is also located on the I/O Backplane of the motherboard. The amber LED on the right indicates activity, while the green LED on the left indicates the speed of the connection. See the table on the right for more information.

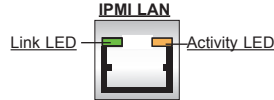

IPMI LAN Link LED (Left) & Activity LED (Right)		
	Color/State	Definition
Link (Left)	Green: Solid	100 Mbps
Activity (Right)	Amber: Blinking	Active

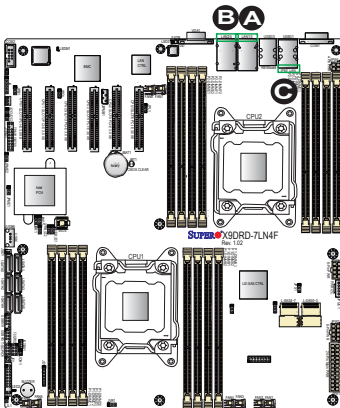

A. LAN1/2 LEDs

B. LAN3/4 LEDs (X9DRD-7LN4F-JBOD/7LN4F)

C. IPMI LAN LEDs

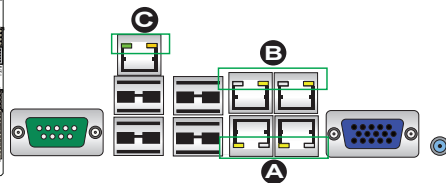

## Onboard Power LED

An Onboard Power LED is located at LED2 on the motherboard. When this LED is on, the system is on. Be sure to turn off the system and unplug the power cord before removing or installing components. See the table on the right for more information.

Onboard PWR LED Indicator LED States	
LED Color	Definition
Off	System Off (PWR cable not connected)
Green	System On
Green: Flashing Quickly	ACPI S1 State

## BMC Heartbeat LED

A BMC Heartbeat LED is located at LEDM1 on the motherboard. When LEDM1 is blinking, BMC functions normally. See the table on the right for more information.

BMC Heartbeat LED States	
Color/State	Definition
Green: Blinking	BMC: Normal

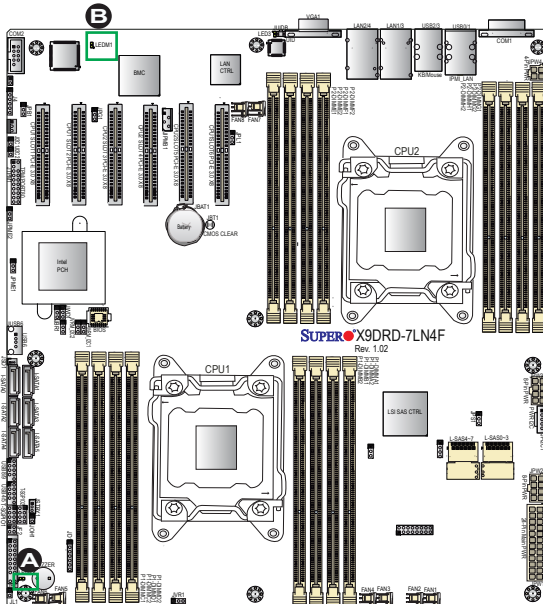

A. PWR LED

B. BMC LED

**Unit Identification Switch/LED**

A Unit Identifier switch (UID) and a rear UID LED indicator (LED3) are located next to LAN ports on the back of the chassis. When the user pushes the rear UID switch, the rear UID LED (LED3) will be turned on. Push the UID switch again to turn off the LED indicator. The UID switch provides easy identification of a system unit that may be in need of service. See the tables on the right for more information. For more information on the UID switch and LED indications, refer to page 2-18.

UID LED Status		
Color/State	OS	Status
Blue: On	Windows OS	Unit Identified
Blue: Blinking	Linux OS	Unit Identified

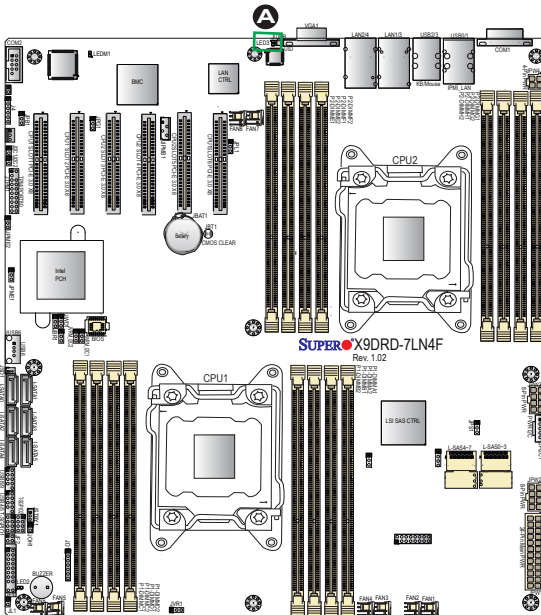

A. UID LED

## 2-10 SATA/SAS Connections

### Serial ATA Ports

There are six Serial ATA Ports (I-SATA1~I-SATA6) located on the motherboard, including four SATA2 ports and two SATA3 ports. These ports provide serial-link signal connections, which are faster than the connections of Parallel ATA. See the table on the right for pin definitions.

### SAS2 Ports (X9DRD-7LN4F-JBOD/7LN4F)

Eight Serial\_Attached\_SCSI Ports (SAS0~3, 4~7) located on the motherboard to provide serial link connections. These ports are supported by the LSI SAS2 2308 Controller. See the table on the right for pin definitions.

SATA/SAS Pin Definitions	
Pin#	Definition
1	Ground
2	TX_P
3	TX_N
4	Ground
5	RX_N
6	RX_P
7	Ground

 **Note:** For more information on SATA HostRAID configuration, please refer to the Intel SATA HostRAID User's Guide posted on our website @ <http://www.supermicro.com>.

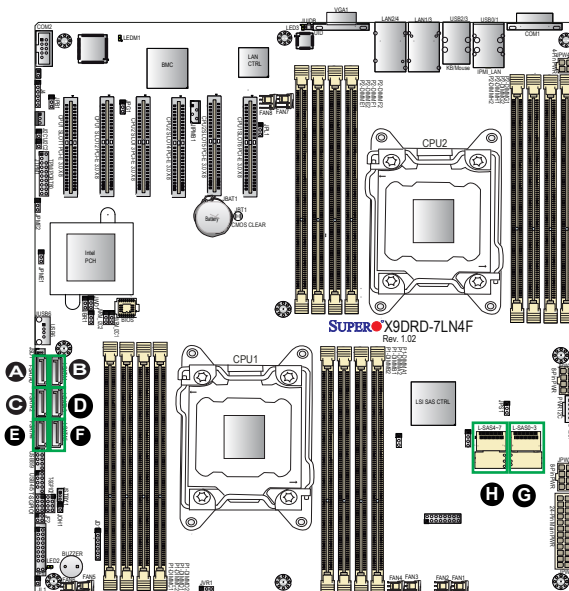

- A. I-SATA1
- B. I-SATA2
- C. I-SATA3
- D. I-SATA4
- E. I-SATA5
- F. I-SATA6
- G. SAS 0~3
- H. SAS 4~7

## Notes



## Chapter 3

# Troubleshooting

### 3-1 Troubleshooting Procedures

Use the following procedures to troubleshoot your system. If you have followed all of the procedures below and still need assistance, refer to the 'Technical Support Procedures' and/or 'Returning Merchandise for Service' section(s) in this chapter. Note: Always disconnect the power cord before adding, changing or installing any hardware components.

#### **Before Power On**

1. Make sure that there are no short circuits between the motherboard and chassis.
2. Disconnect all ribbon/wire cables from the motherboard, including those for the keyboard and mouse.
3. Remove all add-on cards.
4. Install CPU 1 first (making sure it is fully seated) and connect the front panel connectors to the motherboard.

#### **No Power**

1. Make sure that there are no short circuits between the motherboard and the chassis.
2. Make sure that the ATX power connectors are properly connected
3. Check that the 115V/230V switch on the power supply is properly set, if available.
4. Turn the power switch on and off to test the system, if applicable.
5. The battery on your motherboard may be old. Check to verify that it still supplies ~3VDC. If it does not, replace it with a new one.

## No Video

1. If the power is on, but you have no video, remove all the add-on cards and cables.
2. Use the speaker to determine if any beep codes exist. Refer to Appendix A for details on beep codes.

## System Boot Failure

If the system does not display POST or does not respond after the power is turned on, check the following:

1. Check for any error beep from the motherboard speaker.
  - If there is no error beep, try to turn on the system without DIMM modules installed. If there is still no error beep, try to turn on the system again with only one processor installed in CPU Socket#1. If there is still no error beep, replace the motherboard.
  - If there are error beeps, clear the CMOS settings by unplugging the power cord and contracting both pads on the CMOS Clear Jumper (JBT1). (Refer to Section 2-8 in Chapter 2.)
2. Remove all components from the motherboard, especially the DIMM modules. Make sure that system power is on, and memory error beeps are activated.
3. Turn on the system with only one DIMM module installed. If the system boots, check for bad DIMM modules or slots by following the Memory Errors Troubleshooting procedure in this Chapter.

## Losing the System's Setup Configuration

1. Make sure that you are using a high quality power supply. A poor quality power supply may cause the system to lose the CMOS setup information. Refer to Section 2-7 for details on recommended power supplies.
2. The battery on your motherboard may be old. Check to verify that it still supplies ~3VDC. If it does not, replace it with a new one.
3. If the above steps do not fix the Setup Configuration problem, contact your vendor for repairs.

## Memory Errors

When a No-Memory Beep Code is issued by the system, check the following:

1. Make sure that the memory modules are compatible with the system and that the DIMM modules are properly and fully installed. (For memory compatibility, refer to the Memory Compatibility Chart posted on our website @ <http://www.supermicro.com>.)
2. Check if different speeds of DIMMs have been installed. It is strongly recommended that you use the same RAM speed for all DIMMs in the system.
3. Make sure that you are using the correct type of Registered (RDIMM)/Reduced Load (LRDIMM) ECC or Unbuffered (UDIMM) ECC/Non-ECC DDR3 modules recommended by the manufacturer.
4. Check for bad DIMM modules or slots by swapping a single module among all memory slots and check the results.
5. Make sure that all memory modules are fully seated in their slots. Follow the instructions given in Section 2-4 in Chapter 2.
6. Please follow the instructions given in the DIMM Population Tables listed in Section 2-4 to install your memory modules.

## When the System Becomes Unstable

### **A. *The system becomes unstable during or after OS installation***

When the system becomes unstable during or after OS installation, check the following:

1. CPU/BIOS support: Make sure that your CPU is supported, and you have the latest BIOS installed in your system.
2. Memory support: Make sure that the memory modules are supported by testing the modules using memtest86 or a similar utility.



**Note:** Refer to the product page on our website <http://www.supermicro.com> for memory and CPU support and updates.

3. HDD support: Make sure that all hard disk drives (HDDs) work properly. Replace the bad HDDs with good ones.
4. System cooling: Check system cooling to make sure that all heatsink fans, and CPU/system fans, etc., work properly. Check Hardware Monitoring set-

tings in the BIOS to make sure that the CPU and System temperatures are within the normal range. Also check the front panel Overheat LED, and make sure that the Overheat LED is not on.

5. Adequate power supply: Make sure that the power supply provides adequate power to the system. Make sure that all power connectors are connected. Please refer to our website for more information on minimum power requirement.
6. Proper software support: Make sure that the correct drivers are used.

***B. The system becomes unstable before or during OS installation***

When the system becomes unstable before or during OS installation, check the following:

1. Source of installation: Make sure that the devices used for installation are working properly, including boot devices such as CD/DVD disc, CD/DVD-ROM.
2. Cable connection: Check to make sure that all cables are connected and working properly.
3. Using minimum configuration for troubleshooting: Remove all unnecessary components (starting with add-on cards first), and use minimum configuration (with a CPU and a memory module installed) to identify the trouble areas. Refer to the steps listed in Section A above for proper troubleshooting procedures.
4. Identifying bad components by isolating them: If necessary, remove a component in question from the chassis, and test it in isolation to make sure that it works properly. Replace a bad component with a good one.
5. Check and change one component at a time instead of changing several items at the same time. This will help isolate and identify the problem.
6. To find out if a component is good, swap this component with a new one to see if the system will work properly. If so, then the old component is bad. You can also install the component in question in another system. If the new system works, the component is good and the old system has problems.

## 3-2 Technical Support Procedures

Before contacting Technical Support, please take the following steps. Also, please note that as a motherboard manufacturer, Supermicro also sells motherboards through its channels, so it is best to first check with your distributor or reseller for troubleshooting services. They should know of any possible problem(s) with the specific system configuration that was sold to you.

1. Please go through the 'Troubleshooting Procedures' and 'Frequently Asked Question' (FAQ) sections in this chapter or see the FAQs on our website (<http://www.supermicro.com/>) before contacting Technical Support.
  2. BIOS upgrades can be downloaded from our website (<http://www.supermicro.com>).
  3. If you still cannot resolve the problem, include the following information when contacting Supermicro for technical support:
    - Motherboard model and PCB revision number
    - BIOS release date/version (This can be seen on the initial display when your system first boots up.)
    - System configuration
  4. An example of a Technical Support form is on our website at (<http://www.supermicro.com>).
- Distributors: For immediate assistance, please have your account number ready when placing a call to our technical support department. We can be reached by e-mail at [support@supermicro.com](mailto:support@supermicro.com).

## 3-3 Battery Removal and Installation

### Battery Removal

To remove the onboard battery, follow the steps below:

1. Power off your system and unplug your power cable.
2. Locate the onboard battery as shown below.
3. Using a tool such as a pen or a small screwdriver, push the battery lock outwards to unlock it. Once unlocked, the battery will pop out from the holder.
4. Remove the battery.

### Proper Battery Disposal

**Warning:** Please handle used batteries carefully. Do not damage the battery in any way; a damaged battery may release hazardous materials into the environment. Do not discard a used battery in the garbage or a public landfill. Please comply with the regulations set up by your local hazardous waste management agency to dispose of your used battery properly.

### Battery Installation

1. To install an onboard battery, follow the steps 1 & 2 above and continue below:
2. Identify the battery's polarity. The positive (+) side should be facing up.
3. Insert the battery into the battery holder and push it down until you hear a click to ensure that the battery is securely locked.

**Warning:** When replacing a battery, be sure to only replace it with the same type.

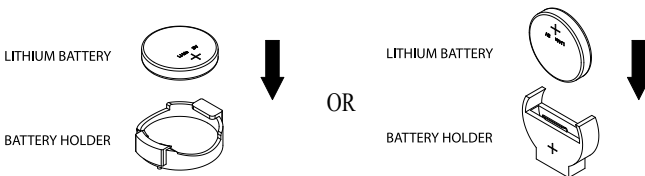

---

## 3-4 Frequently Asked Questions

**Question: What are the various types of memory that my motherboard can support?**

**Answer:** The motherboard supports Registered (RDIMM)/Load Reduced (LRDIMM) ECC or Unbuffered (UDIMM) ECC/Non-ECC DDR3 modules. To enhance memory performance, do not mix memory modules of different speeds and sizes. Please follow all memory installation instructions given on Section 2-4 in Chapter 2.

**Question: How do I update my BIOS?**

It is recommended that you **do not** upgrade your BIOS if you are not experiencing any problems with your system. Updated BIOS files are located on our website at <http://www.supermicro.com>. Please check our BIOS warning message and the information on how to update your BIOS on our website. Select your motherboard model and download the BIOS file to your computer. Also, check the current BIOS revision to make sure that it is newer than your BIOS before downloading. You can choose from the zip file and the .exe file. If you choose the zip BIOS file, please unzip the BIOS file onto a bootable USB device. Run the batch file using the format AMI.bat filename.rom from your bootable USB device to flash the BIOS. Then, your system will automatically reboot.

**Warning:** Do not shut down or reset the system while updating the BIOS to prevent possible system boot failure!



**Note:** The SPI BIOS chip used on this motherboard cannot be removed. Send your motherboard back to our RMA Department at Supermicro for repair. For BIOS Recovery instructions, please refer to the AMI BIOS Recovery Instructions posted at <http://www.supermicro.com>.

**Question: How do I handle the used battery?**

**Answer:** Please handle used batteries carefully. Do not damage the battery in any way; a damaged battery may release hazardous materials into the environment. Do not discard a used battery in the garbage or a public landfill. Please comply with the regulations set up by your local hazardous waste management agency to dispose of your used battery properly. (Refer to Section 3-3 on Page 3-6.)

### 3-5 Returning Merchandise for Service

A receipt or copy of your invoice marked with the date of purchase is required before any warranty service will be rendered. You can obtain service by calling your vendor for a Returned Merchandise Authorization (RMA) number. When returning the motherboard to the manufacturer, the RMA number should be prominently displayed on the outside of the shipping carton, and the shipping package is mailed prepaid or hand-carried. Shipping and handling charges will be applied for all orders that must be mailed when service is complete. For faster service, you can also request a RMA authorization online (<http://www.supermicro.com/RmaForm/>).

This warranty only covers normal consumer use and does not cover damages incurred in shipping or from failure due to the alternation, misuse, abuse or improper maintenance of products.

During the warranty period, contact your distributor first for any product problems.



## Chapter 4

# BIOS

### 4-1 Introduction

This chapter describes the AMI BIOS Setup utility for the X9DRD-EF/7LN4F-JBOD/7LN4F. It also provides the instructions on how to navigate the AMI BIOS Setup utility screens. The AMI ROM BIOS is stored in a Flash EEPROM and can be easily updated.

#### Starting BIOS Setup Utility

To enter the AMI BIOS Setup utility screens, press the <Del> key while the system is booting up.

 **Note:** In most cases, the <Del> key is used to invoke the AMI BIOS setup screen. There are a few cases when other keys are used, such as <F3>, <F4>, etc.

Each main BIOS menu option is described in this manual. The Main BIOS setup menu screen has two main frames. The left frame displays all the options that can be configured. Grayed-out options cannot be configured. Options in blue can be configured by the user. The right frame displays the key legend. Above the key legend is an area reserved for informational text. When an option is selected in the left frame, it is highlighted in white. Often informational text will accompany it.

 **Note:** The AMI BIOS has default informational messages built in. The manufacturer retains the option to include, omit, or change any of these informational messages.

The AMI BIOS Setup utility uses a key-based navigation system called "hot keys." Most of the AMI BIOS setup utility "hot keys" can be used at any time during setup navigation. These keys include <F3>, <F4>, <Enter>, <ESC>, arrow keys, etc.

 **Note 1:** Options printed in **Bold** are default settings.

**Note 2:** <F3> is used to load optimal default settings. <F4> is used to save the settings and exit the setup utility.

## How To Change the Configuration Data

The configuration data that determines the system parameters may be changed by entering the AMI BIOS Setup utility. This Setup utility can be accessed by pressing <Delete> at the appropriate time during system boot.

 **Note:** For AMI UEFI BIOS Recovery, please refer to the UEFI BIOS Recovery User Guide posted @ <http://www.supermicro.com/support/manuals/>.

## Starting the Setup Utility

Normally, the only visible Power-On Self-Test (POST) routine is the memory test. As the memory is being tested, press the <Delete> key to enter the main menu of the AMI BIOS Setup utility. From the main menu, you can access the other setup screens. An AMI BIOS identification string is displayed at the left bottom corner of the screen below the copyright message.

**Warning:** Do not upgrade the BIOS unless your system has a BIOS-related issue. Flashing the wrong BIOS can cause irreparable damage to the system. In no event shall the manufacturer be liable for direct, indirect, special, incidental, or consequential damage arising from a BIOS update. If you have to update the BIOS, do not shut down or reset the system while the BIOS is being updated to avoid possible boot failure.

## 4-2 Main Setup

When you first enter the AMI BIOS Setup utility, you will enter the Main setup screen. You can always return to the Main setup screen by selecting the Main tab on the top of the screen. The Main BIOS Setup screen is shown below.

The AMI BIOS Main menu displays the following information:

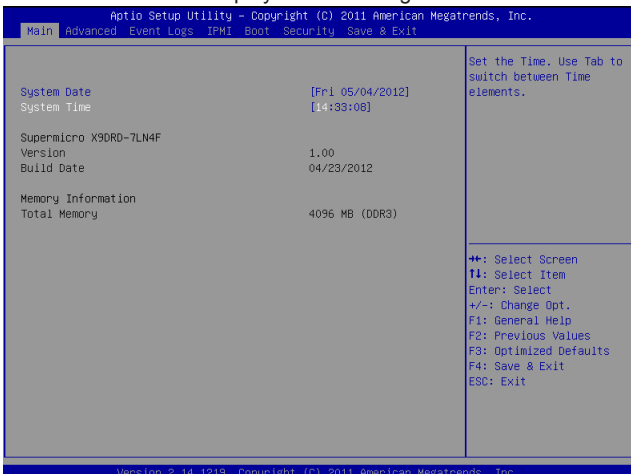

**System Date/System Time**

Use this option to change the system time and date. Highlight *System Time* or *System Date* using the arrow keys. Enter new values through the keyboard and press <Enter>. Press the <Tab> key to move between fields. The date must be entered in Day MM/DD/YY format. The time is entered in HH:MM:SS format. (**Note:** The time is in the 24-hour format. For example, 5:30 P.M. appears as 17:30:00.).

**Supermicro X9DRD-7LN4F series****Version**

This item displays the SMC version of the BIOS ROM used in this system.

**Build Date**

This item displays the date that the BIOS Setup utility was built.

**Memory Information****Total Memory**

This displays the amount of memory that is available in the system.

## 4-3 Advanced Setup Configurations

Select the Advanced tab to access the following submenu items.

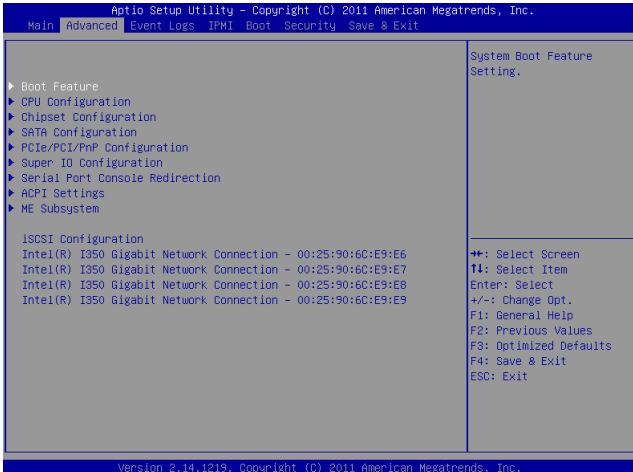

### ► Boot Feature

#### Quiet Boot

This feature allows the user to select bootup screen display between POST messages and the OEM logo. Select Disabled to display the POST messages. Select Enabled to display the OEM logo instead of the normal POST messages. The options are **Enabled** and Disabled.

#### AddOn ROM Display Mode

Use this item to set the display mode for the Option ROM. Select Keep Current to use the current AddOn ROM Display setting. Select Force BIOS to use the Option ROM display mode set by the system BIOS. The options are Keep Current and **Force BIOS**.

#### Bootup Num-Lock

Use this feature to set the Power-on state for the Numlock key. The options are Off and **On**.

#### Wait For 'F1' If Error

Select Enabled to force the system to wait until the 'F1' key is pressed if an error occurs. The options are Disabled and **Enabled**.

#### Interrupt 19 Capture

Interrupt 19 is the software interrupt that handles the boot disk function. When this item is set to Enabled, the ROM BIOS of the host adaptors will "capture" Interrupt 19

at bootup and allow the drives that are attached to these host adaptors to function as bootable disks. If this item is set to Disabled, the ROM BIOS of the host adaptors will not capture Interrupt 19, and the drives attached to these adaptors will not function as bootable devices. The options are **Enabled** and Disabled.

## Power Configuration

### Watch Dog Function

If enabled, the Watch Dog timer will allow the system to automatically reboot when a non-recoverable error occurs that lasts for more than five minutes. The options are Enabled and **Disabled**.

### Power Button Function

If this feature is set to Instant Off, the system will power off immediately as soon as the user presses the power button. If this feature is set to 4 Seconds Override, the system will power off when the user presses the power button for 4 seconds or longer. The options are **Instant Off** and 4 Seconds Override.

### Restore on AC Power Loss

Use this feature to set the power state after a power outage. Select Stay Off for the system power to remain off after a power loss. Select Power On for the system power to be turned on after a power loss. Select Last State to allow the system to resume its last state before a power loss. The options are Stay Off, Power On, and **Last State**.

## ► CPU Configuration

This submenu displays the information of the CPU as detected by the BIOS. It also allows the user to configure CPU settings.

### ► Socket 1 CPU Information/Socket 2 CPU Information

This submenu displays the following information regarding the CPUs installed in Socket 1/ Socket 2.

- Type of CPU
- CPU Signature
- Microcode Patch
- CPU Stepping
- Maximum / Minimum CPU Speed

- Processor Cores
- Intel HT (Hyper-Threading) Technology
- Intel VT-x Technology
- Intel SMX Technology
- L1 Data Cache / L1 Code Cache
- L2 Cache
- L3 Cache

### **CPU Speed**

This item displays the speed of the CPU installed in Socket 1/Socket 2.

### **64-bit**

This item indicates if the CPU installed in Socket 1 or Socket 2 supports 64-bit technology.

### **Clock Spread Spectrum**

Select Enable to enable Clock Spread Spectrum support, which will allow the BIOS to monitor and attempt to reduce the level of Electromagnetic Interference caused by the components whenever needed. The options are **Disabled** and Enabled.

### **RTID (Record Types IDs)**

This feature displays the total number of Record Type IDs for local and remote pools. The options are **Optimal** and Alternate.

### **Hyper-threading**

Select Enabled to support Intel Hyper-threading Technology to enhance CPU performance. The options are **Enabled** and Disabled.

### **Active Processor Cores**

Set to Enabled to use a processor's second core and above. (Please refer to Intel's website for more information.) The options are **All**, 1, 2, 4, and 6.

### **Limit CPUID Maximum**

This feature allows the user to set the maximum CPU ID value. Enable this function to boot the legacy operating systems that cannot support processors with extended CPUID functions. The options are Enabled and **Disabled** (for the Windows OS).

**Execute-Disable Bit (Available if supported by the OS & the CPU)**

Select Enabled to enable the Execute Disable Bit which will allow the processor to designate areas in the system memory where an application code can execute and where it cannot, thus preventing a worm or a virus from flooding illegal codes to overwhelm the processor or damage the system during an attack. The default is **Enabled**. (Refer to Intel and Microsoft Web sites for more information.)

**Intel® AES-NI**

Select Enable to use the Intel Advanced Encryption Standard (AES) New Instructions (NI) to ensure data security. The options are **Enabled** and Disabled.

**MLC Streamer Prefetcher (Available when supported by the CPU)**

If set to Enabled, the MLC (mid-level cache) streamer prefetcher will prefetch streams of data and instructions from the main memory to the L2 cache to improve CPU performance. The options are Disabled and **Enabled**.

**MLC Spatial Prefetch (Available when supported by the CPU)**

If this feature is set to Disabled, The CPU prefetches the cache line for 64 bytes. If this feature is set to Enabled the CPU fetches both cache lines for 128 bytes as comprised. The options are Disabled and **Enabled**.

**DCU Streamer Prefetcher (Available when supported by the CPU)**

Select Enabled to support Data Cache Unit (DCU) prefetch of L1 data to speed up data accessing and processing in the DCU to enhance CPU performance. The options are Disabled and **Enabled**.

**DCU IP Prefetcher**

Select Enabled for DCU (Data Cache Unit) IP Prefetcher support, which will prefetch IP addresses to improve network connectivity and system performance. The options are **Enabled** and Disabled.

**Intel® Virtualization Technology (Available when supported by the CPU)**

Select Enabled to support Intel Virtualization Technology, which will allow one platform to run multiple operating systems and applications in independent partitions, creating multiple "virtual" systems in one physical computer. The options are **Enabled** and Disabled.



**Note:** If there is any change to this setting, you will need to power off and restart the system for the change to take effect. Please refer to Intel's website for detailed information.)

## ► CPU Power Management Configuration

This submenu allows the user to configure the following CPU Power Management settings.

### Power Technology

Select Energy Efficiency to support power-saving mode. Select Custom to customize system power settings. Select Disabled to disable power-saving settings. The options are Disabled, **Energy Efficient**, and Custom. If the option is set to Custom, the following items will display:

#### **EIST (Available when Power Technology is set to Custom)**

EIST (Enhanced Intel SpeedStep Technology) allows the system to automatically adjust processor voltage and core frequency to reduce power consumption and heat dissipation. The options are Disabled (GV3 Disabled), and **Enabled (GV3 Enabled)**. (**Note:** GV3 is Intel Speedstep support used on older platforms. Please refer to Intel's website for detailed information.)

#### **Turbo Mode (Available when Power Technology is set to Custom)**

Select Enabled to use the Turbo Mode to boost system performance. The options are **Enabled** and Disabled.

#### **C1E Support (Available when Power Technology is set to Custom)**

Select Enabled to enable Enhanced C1 Power State to boost system performance. The options are **Enabled** and Disabled.

#### **PU C3 Report (Available when Power Technology is set to Custom)**

Select Enabled to allow the BIOS to report the CPU C3 State (ACPI C2) to the operating system. During the CPU C3 State, the CPU clock generator is turned off. The options are Enabled and **Disabled**.

#### **CPU C6 Report (Available when Power Technology is set to Custom)**

Select Enabled to allow the BIOS to report the CPU C6 State (ACPI C3) to the operating system. During the CPU C6 State, the power to all cache is turned off. The options are **Enabled** and Disabled.

#### **CPU C7 Report (Available when Power Technology is set to Custom)**

Select Enabled to allow the BIOS to report the CPU C7 State (ACPI C3) to the operating system. CPU C7 State is a processor-specific low C-State. The options are **Enabled** and Disabled.



**Package C-State limit (Available when Power Technology is set to Custom)**

This feature allows the user to set the limit on the C-State package register. The options are C0, C2, **C6**, and No Limit.

**Energy/Performance Bias**

Use this feature to select an appropriate fan setting to achieve maximum system performance (with maximum cooling) or maximum energy efficiency with maximum power saving). The fan speeds are controlled by the firmware management via IPMI 2.0. The options are Performance, **Balanced Performance**, Balanced Energy, and Energy Efficient.

**Factory Long Duration Power Limit**

This item displays the power limit (in watts) set by the manufacturer during which long duration power is maintained.

**Long Duration Power Limit**

This item displays the power limit (in watts) set by the user during which long duration power is maintained. The default setting is 0.

**Factory Long Duration Maintained**

This item displays the period of time (in seconds) set by the manufacturer during which long duration power is maintained.

**Long Duration Maintained**

This item displays the period of time (in seconds) during which long duration power is maintained. The default setting is 0.

**Recommended Short Duration Power**

This item displays the short duration power settings (in watts) recommended by the manufacturer.

**Short Duration Power Limit**

During Turbo Mode, the system may exceed the processors default power setting and exceed the Short Duration Power limit. By increasing this value, the processor can provide better performance for short duration. This item displays the time period during which short duration power is maintained. The default setting is 0.

## ► Chipset Configuration

### ► North Bridge

This feature allows the user to configure the settings for the Intel North Bridge.

### ► Integrated IO Configuration

#### Intel® VT-d

Select Enabled to enable Intel Virtualization Technology support for Direct I/O VT-d by reporting the I/O device assignments to the VMM (Virtual Machine Monitor) through the DMAR ACPI Tables. This feature offers fully-protected I/O resource sharing across Intel platforms, providing greater reliability, security and availability in networking and data-sharing. The options are **Enabled** and Disabled.

#### Intel® I/OAT

Select Enabled to enable Intel I/OAT (I/O Acceleration Technology), which significantly reduces CPU overhead by leveraging CPU architectural improvements and freeing the system resource for other tasks. The options are Disabled and **Enabled**.

#### DCA Support

When set to Enabled, this feature uses Intel's DCA (Direct Cache Access) Technology to improve data transfer efficiency. The options are **Enabled** and Disabled.

#### IIO 1 PCIe Port Bifurcation Control

This submenu configures the following IO PCIe Port Bifurcation Control settings for IIO 1 PCIe ports to determine how the available PCI-Express lanes to be distributed between the PCI-Exp. Root Ports.

#### **CPU1 Slot1 PCI-E 3.0 x8 Link Speed/ CPU1 Slot2 PCI-E 3.0 x8 Link Speed/ CPU1 Slot6 PCI-E 3.0 x8 Link Speed/CPU2 Slot3 PCI-E 3.0 x8 Link Speed/CPU2 Slot4 PCI-E 3.0 x8 Link Speed/CPU2 Slot5 PCI-E 3.0 x8 Link Speed**

Select GEN1 for the device installed on the slot specified to support PCI-Exp Generation 1. Select GEN2 for the device installed on the slot specified to support PCI-Exp Generation 2. Select GEN3 for the device installed on the slot specified to support PCI-Exp Generation 3. The options are GEN1, GEN2, and **GEN3**.

---

## IIO 2 PCIe Port Bifurcation Control

This submenu configures the following IO PCIe Port Bifurcation Control settings for IIO 2 PCIe ports to determine how the available PCI-Express lanes to be distributed between the PCI-Exp. Root ports.

### ►QPI Configuration

#### Current QPI Link

This item displays the current status of the QPI Link.

#### Current QPI Frequency

This item displays the frequency of the QPI Link.

#### Isoc

Select Enabled to enable Isochronous support to meet QoS (Quality of Service) requirements. This feature is especially important for virtualization technology. The options are Enabled and **Disabled**.

#### QPI (Quick Path Interconnect) Link Speed Mode

Use this feature to select data transfer speed for QPI Link connections. The options are Slow and **Fast**.

#### QPI Link Frequency Select

Use this feature to select the desired QPI frequency. The options are **Auto**, 6.4 GT/s, 7.2 GT/s, and 8.0 GT/s.

### ►DIMM Configuration

This section displays the following DIMM information.

#### Current Memory Mode

This item displays the current memory mode.

#### Current Memory Speed

This item displays the current memory speed.

#### Mirroring (Available when supported by the motherboard)

Memory mirroring creates a duplicate copy of the data stored in the memory to enhance data security.

#### Sparing (Available when supported by the motherboard)

Memory sparing enhances system reliability, availability, and serviceability.

## ► DIMM Information

### CPU Socket 1 DIMM Information, CPU Socket 2 DIMM Information

The status of the memory modules detected by the BIOS will be displayed as detected by the BIOS.

### Memory Mode

When Independent is selected, all DIMMs are available to the operating system. When Mirroring is selected, the motherboard maintains two identical copies of all data in memory for data backup. When Lock Step is selected, the motherboard uses two areas of memory to run the same set of operations in parallel. The options are **Independent**, Mirroring, and Lock Step.

### DRAM RAPL Mode

RAPL (Running Average Power Limit) provides mechanisms to enforce power consumption limits on supported processors. The options are Disabled, DRAM RAPL MODE0, and **DRAM RAPL MODE1**.

### DDR Speed

Use this feature to force a DDR3 memory module to run at a frequency other than what is specified in the specification. The options are Force DDR3-800, Force DDR3-1066, Force DDR3-1333, Force DDR3-1600 and Force SPD, and **Auto**.

### Channel Interleaving

This feature selects from the different channel interleaving methods. The options are **Auto**, 1 Way, 2 Way, 3, Way, and 4 Way.

### Rank Interleaving

This feature allows the user to select a rank memory interleaving method. The options are **Auto**, 1 Way, 2 Way, 4, Way, and 8 Way.

### Patrol Scrub

Patrol Scrubbing is a process that allows the CPU to correct correctable memory errors detected on a memory module and send the correction to the requestor (the original source). When this item is set to Enabled, the IO hub will read and write back one cache line every 16K cycles, if there is no delay caused by internal processing. By using this method, roughly 64 GB of memory behind the IO hub will be scrubbed every day. The options are **Enabled** and Disabled.

### Demand Scrub

Demand Scrubbing is a process that allows the CPU to correct correctable memory errors found on a memory module. When the CPU or I/O issues a demand-read command, and the read data from memory turns out to be a

correctable error, the error is corrected and sent to the requestor (the original source). Memory is updated as well. Select Enabled to use Demand Scrubbing for ECC memory correction. The options are Enabled and **Disabled**.

#### **Data Scrambling**

Select Enabled to enable data scrambling to ensure data security and integrity. The options are Disabled and **Enabled**.

#### **Device Tagging**

Select Enabled to support device tagging. The options are **Disabled** and Enabled.

#### **Thermal Throttling**

Throttling improves reliability and reduces power consumption in the processor via automatic voltage control during processor idle states. The options are Disabled and **CLTT** (Closed Loop Thermal Throttling).

### **► South Bridge Configuration**

This feature allows the user to configure the settings for the Intel PCH chip.

#### **PCH Information**

This feature displays the following PCH information.

**Name:** This item displays the name of the PCH chip.

**Stepping:** This item displays the status of the PCH stepping.

**USB Devices:** This item displays the USB devices detected by the BIOS.

#### **All USB Devices**

This feature enables all USB ports/devices. The options are Disabled and **Enabled**. (If set to Enabled, EHCI Controller 1 and Controller 2 will appear.)

#### **EHCI Controller 1/EHCI Controller 2 (Available when All USB Devices is set to Enabled)**

Select Enabled to enable EHCI (Enhanced Host Controller Interface) Controller 1 or Controller 2. The options are Disabled and **Enabled**.

#### **Legacy USB Support (Available when USB Functions is not Disabled)**

Select Enabled to support legacy USB devices. Select Auto to disable legacy support if USB devices are not present. Select Disabled to have USB devices available for EFI (Extensive Firmware Interface) applications only. The settings are **Enabled**, Disabled, and Auto.

### Port 60/64 Emulation

Select Enabled to enable I/O port 60h/64h emulation support for the legacy USB keyboard so that it can be fully supported by the operating systems that does not recognize a USB device. The options are Disabled and **Enabled**.

### EHCI Hand-Off

This item is for operating systems that do not support Enhanced Host Controller Interface (EHCI) hand-off. When enabled, EHCI ownership change will be claimed by the EHCI driver. The options are **Disabled** and Enabled.

## ► SATA Configuration

When this submenu is selected, the AMI BIOS automatically detects the presence of IDE or SATA devices and displays the following items.

**SATA Port0~SATA Port5:** The AMI BIOS displays the status of each SATA port as detected by the BIOS.

### SATA Mode

Use this feature to configure SATA mode for a selected SATA port. The options are Disabled, IDE Mode, **AHCI Mode** and RAID Mode. The following are displayed depending on your selection:

#### IDE Mode

The following items are displayed when IDE Mode is selected:

#### **Serial-ATA (SATA) Controller 0~1**

Use this feature to activate or deactivate the SATA controller, and set the compatibility mode. The options for SATA Controller 0 are Disabled, Enhanced, and **Compatible**. The options for SATA Controller 1 are Disabled and **Enhanced**.

#### AHCI Mode

The following items are displayed when the AHCI Mode is selected.

#### **Aggressive Link Power Management**

When Enabled, the SATA AHCI controller manages the power usage of the SATA link. The controller will put the link in a low power mode during extended periods of I/O inactivity, and will return the link to an active state when I/O activity resumes. The options are **Enabled** and Disabled.

**Port 0~5 Hot Plug**

Select Enabled to enable hot-plug support for a particular port, which will allow the user to change a hardware component or device without shutting down the system. The options are **Enabled** and Disabled.

**Staggered Spin Up**

Select Enabled to enable Staggered Spin-up support to prevent excessive power consumption caused by multiple HDDs spinning-up simultaneously. The options are Enabled and **Disabled**.

**RAID Mode**

The following items are displayed when RAID Mode is selected:

**SATA RAID Option ROM**

Use this feature to determine which SATA RAID device the system will boot from. The options are **Legacy** and EFI.

**Port 0~5 Hot Plug**

Select Enabled to enable hot-plug support for the particular port. The options are **Enabled** and Disabled.

**►PCIe/PCI/PnP Configuration****PCI ROM Priority**

Use this feature to select the Option ROM to boot the system when there are multiple Option ROMs available in the system. The options are **Legacy ROM** and EFI Compatible ROM.

**PCI Latency Timer**

Use this feature to set the latency Timer of each PCI device installed on a PCI bus. Select 64 to set the PCI latency to 64 PCI clock cycles. The options are 32, **64**, 96, 128, 160, 192, 224 and 248.

**Above 4G Decoding (Available if the system supports 64-bit PCI decoding)**

Select Enabled to decode a PCI device that supports 64-bit in the space above 4G Address. The options are Enabled and **Disabled**.

**PERR# Generation**

Select Enabled to allow a PCI device to generate a PERR number for a PCI Bus Signal Error Event. The options are Enabled and **Disabled**.

### **SERR# Generation**

Select Enabled to allow a PCI device to generate an SERR number for a PCI Bus Signal Error Event. The options are Enabled and **Disabled**.

### **Maximum Payload**

Select Auto to allow the system BIOS to automatically set the maximum payload value for a PCI-E device to enhance system performance. The options are **Auto**, 128 Bytes and 256 Bytes.

### **Maximum Read Request**

Select Auto to allow the system BIOS to automatically set the maximum Read Request size for a PCI-E device to enhance system performance. The options are **Auto**, 128 Bytes, 256 Bytes, 512 Bytes, 1024 Bytes, 2048 Bytes, and 4096 Bytes.

### **ASPM Support**

This feature allows the user to set the Active State Power Management (ASPM) level for a PCI-E device. Select Force L0s to force all PCI-E links to operate at L0s state. Select Auto to allow the system BIOS to automatically set the ASPM level for the system. Select Disabled to disable ASPM support. The options are **Disabled**, Force L0s, and Auto.

**Warning:** Enabling ASPM support may cause some PCI-E devices to fail.

### **CPU1 Slot 1 PCI-E 3.0 x8 OPROM, CPU1 Slot 2 PCI-E 3.0 x8 OPROM, CPU2 Slot 3 PCI-E 3.0 x8 OPROM, CPU2 Slot 4 PCI-E 3.0 x8 OPROM, CPU2 Slot 5 PCI-E 3.0 x8 OPROM, CPU1 Slot 6 PCI-E 3.0 x 8 OPROM**

Select Enabled to enable Option ROM support to boot the computer using a device installed on the slot specified above. The options are **Enabled** and Disabled.

### **Onboard LAN Option ROM Select**

Select iSCSI to use the iSCSI Option ROM to boot the computer using a network device. Select PXE (Preboot Execution Environment) to use an PXE Option ROM to boot the computer using a network device. The options are **PXE** and iSCSI.

### **Load Onboard LAN1~LAN4 Option ROM**

Select Enabled to enable the onboard LAN1 Option ROM~LAN4 Option ROM. This is to boot the computer using a network device. The default setting for LAN1 Option ROM is **Enabled**, and the default setting for LAN2~LAN4 Option ROM is **Disabled**.

### **Load Onboard SAS Option ROM**

Select Enabled to use the onboard SAS Option ROM to boot the computer using a SAS device. The options are **Enabled** and Disabled.



### VGA Priority

This feature allows the user to select the graphics adapter to be used as the primary boot device. The options are **Onboard**, and **Offboard**.

### Network Stack

Select Enabled enable PXE (Preboot Execution Environment) or UEFI (Unified Extensible Firmware Interface) for network stack support. The options are **Enabled** and **Disabled**.

## ► Super IO Configuration

**Super IO Chip:** This item displays the Super IO chip used in the motherboard.

## ► Serial Port 1 Configuration

### Serial Port

Select Enabled to enable serial port 1. The options are **Enabled** and **Disabled**.

### Device Settings

This item displays the settings of Serial Port 1.

### Change Settings

This option specifies the base I/O port address and the Interrupt Request address of Serial Port 1. Select Disabled to prevent the serial port from accessing any system resources. When this option is set to Disabled, the serial port becomes unavailable. The options are **Auto**, IO=3F8h; IRQ=4; IO=3F8h; IRQ=3, 4, 5, 6, 7, 9, 10, 11, 12; IO=2F8h; IRQ=3, 4, 5, 6, 7, 9, 10, 11, 12; IO=3E8h; IRQ=3, 4, 5, 6, 7, 9, 10, 11, 12; IO=2E8h, and IRQ=3, 4, 5, 6, 7, 9, 10, 11, 12.

### Device Mode

Use this feature to select the desired mode for a serial port specified. The options are **Normal** and **High Speed**.

## ► Serial Port 2 Configuration

### Serial Port

Select Enabled to enable serial port 2. The options are **Enabled** and **Disabled**.

### Device Settings

This item displays the settings of Serial Port 2.

### Change Settings

This option specifies the base I/O port address and the Interrupt Request address of Serial Port 2. Select Disabled to prevent the serial port from accessing any system resources. When this option is set to Disabled, the serial port becomes unavailable. The options are **Auto**, IO=3F8h; IRQ=4; IO=3F8h; IRQ=3, 4, 5, 6, 7, 9, 10, 11, 12; IO=2F8h; IRQ=3, 4, 5, 6, 7, 9, 10, 11, 12; IO=3E8h; IRQ=3, 4, 5, 6, 7, 9, 10, 11, 12; and IO=2E8h, and IRQ=3, 4, 5, 6, 7, 9, 10, 11, 12.

### Device Mode

Use this feature to select the desired mode for a serial port specified. The options are **Normal** and High Speed.

### Serial Port 2 Attribute

Use this feature to select the attribute for this serial port. The options are **SOL** (Serial Over LAN), and COM.

## ► Serial Port Console Redirection

### COM1, COM2/SOL

These two submenus allow the user to configure the following Console Redirection settings for a COM Port specified by the user.

### Console Redirection

Select Enabled to use a COM Port selected by the user for Console Redirection. The options are Enabled and Disabled. The default setting for COM1 is **Disabled**, and for COM2/SOL is **Enabled**.

## ► Console Redirection Settings

This feature allows the user to specify how the host computer will exchange data with the client computer, which is the remote computer used by the user.

### Terminal Type

This feature allows the user to select the target terminal emulation type for Console Redirection. Select VT100 to use the ASCII Character set. Select VT100+ to add color and function key support. Select ANSI to use the Extended ASCII Character Set. Select VT-UTF8 to use UTF8 encoding to map Unicode characters into one or more bytes. The options are VT100, **VT100+**, VT-UTF8, and ANSI.

### Bits Per second

Use this feature to set the transmission speed for a serial port used in Console Redirection. Make sure that the same speed is used in the host computer and the

client computer. A lower transmission speed may be required for long and busy lines. The options are 9600, 19200, 38400, 57600 and **115200** (bits per second).

### **Data Bits**

Use this feature to set the data transmission size for Console Redirection. The options are 7 Bits and **8 Bits**.

### **Parity**

A parity bit can be sent along with regular data bits to detect data transmission errors. Select Even if the parity bit is set to 0, and the number of 1's in data bits is even. Select Odd if the parity bit is set to 0, and the number of 1's in data bits is odd. Select None if you do not want to send a parity bit with your data bits in transmission. Select Mark to add a mark as a parity bit to be sent along with the data bits. Select Space to add a Space as a parity bit to be sent with your data bits. The options are **None**, Even, Odd, Mark and Space.

### **Stop Bits**

A stop bit indicates the end of a serial data packet. Select 1 Stop Bit for standard serial data communication. Select 2 Stop Bits if slower devices are used. The options are **1** and 2.

### **Flow Control**

This feature allows the user to set the flow control for Console Redirection to prevent data loss caused by buffer overflow. Send a "Stop" signal to stop sending data when the receiving buffer is full. Send a "Start" signal to start sending data when the receiving buffer is empty. The options are **None** and Hardware RTS/CTS.

### **VT-UTF8 Combo Key Support**

Select Enabled to enable VT-UTF8 Combination Key support for ANSI/VT100 terminals. The options are **Enabled** and Disabled.

### **Recorder Mode**

Select Enabled to capture the data displayed on a terminal and send it as text messages to a remote server. The options are **Disabled** and Enabled.

### **Resolution 100x31**

Select Enabled for extended-terminal resolution support. The options are Disabled and **Enabled**.

### **Legacy OS Redirection Resolution**

Use this feature to select the number of rows and columns used in Console Redirection for legacy OS support. The options are 80x24 and **80x25**.

---

### Putty KeyPad

This feature selects Function Keys and KeyPad settings for Putty, which is a terminal emulator designed for the Windows OS. The options are **VT100**, LINUX, XTERMR6, SC0, ESCN, and VT400.

### Serial Port for Out-of-Band Management/Windows Emergency Management Services (EMS)

The submenu allows the user to configure Console Redirection settings to support Out-of-Band Serial Port management.

#### Console Redirection (for EMS)

Select Enabled to use a COM Port selected by the user for Console Redirection. The options are Enabled and **Disabled**.

### ▶ Console Redirection Settings (for EMS)

This feature allows the user to specify how the host computer will exchange data with the client computer, which is the remote computer used by the user.

#### Out-of-Band Management Port

The feature selects a serial port used by the Microsoft Windows Emergency Management Services (EMS) to communicate with a remote server. The options are **COM1** and COM2/SOL.

#### Terminal Type

This feature allows the user to select the target terminal emulation type for Console Redirection. Select VT100 to use the ASCII character set. Select VT100+ to add color and function key support. Select ANSI to use the extended ASCII character set. Select VT-UTF8 to use UTF8 encoding to map Unicode characters into one or more bytes. The options are ANSI, VT100, **VT100+**, and VT-UTF8.

#### Bits Per Second

This item sets the transmission speed for a serial port used in Console Redirection. Make sure that the same speed is used in the host computer and the client computer. A lower transmission speed may be required for long and busy lines. The options are 9600, 19200, 57600, and **115200** (bits per second).

#### Flow Control

This feature allows the user to set the flow control for Console Redirection to prevent data loss caused by buffer overflow. Send a "Stop" signal to stop sending data when the receiving buffer is full. Send a "Start" signal to start sending data when the receiving buffer is empty. The options are **None**, Hardware RTS/CTS, and Software Xon/Xoff.

### **Data Bits, Parity, Stop Bits**

The status of these features is displayed.

## **►ACPI Settings**

Use this feature to configure Advanced Configuration and Power Interface (ACPI) power management settings for your system.

### **ACPI Sleep State**

Use this feature to select the ACPI State when the system is in sleep mode. Select S1 (CPU\_Stop\_Clock) to erase all CPU caches and stop executing instructions. Power to the CPU(s) and RAM is maintained, but RAM is refreshed. Select Suspend Disabled to use power-reduced mode. Power will only be supplied to limited components (such as RAMs) to maintain the most critical functions of the system. The options are Suspend Disabled and **S1 (CPU\_Stop\_Clock)**.

### **NUMA (NON-Uniform Memory Access)**

This feature enables the Non-Uniform Memory Access ACPI support. The options are **Enabled** and Disabled.

### **High Precision Event Timer**

Select Enabled to activate the High Precision Event Timer (HPET) that produces periodic interrupts at a much higher frequency than a Real-time Clock (RTC) does in synchronizing multimedia streams, providing smooth playback, reducing the dependency on other timestamp calculation devices, such as an x86 RDTSC Instruction embedded in the CPU. The High Performance Event Timer is used to replace the 8254 Programmable Interval Timer. The options are **Enabled** and Disabled.

## **►Trusted Computing (Available when a TPM device is detected by the BIOS)**

### **Configuration**

#### **TPM Support**

Select Enabled on this item and enable the TPM jumper on the motherboard to enable TPM support to improve data integrity and network security. The options are **Enabled** and Disabled.

#### **TPM State**

Select Enabled to enable TPM security settings to improve data integrity and network security. The options are Disabled and **Enabled**.

### Pending Operation

Use this item to schedule an operation for the security device. The options are **None**, Enable Take Ownership, Disable Take Ownership, and TPM Clear.

 **Note:** During restart, the computer will reboot in order to execute the pending operation and change the state of the security device.

**Current Status Information:** This item displays the information regarding the current TPM status.

#### TPM Enable Status

This item displays the status of TPM Support to indicate if TPM is currently enabled or disabled.

#### TPM Active Status

This item displays the status of TPM Support to indicate if TPM is currently active or deactivated.

#### TPM Owner Status

This item displays the status of TPM Ownership.

## ► Intel TXT (LT-SX) Configuration

### Intel TXT (LT-SX) Hardware Support

This feature indicates if the following hardware components support the Intel Trusted Execution Technology.

**CPU:** TXT (Trusted Execution Technology) Feature

**Chipset:** TXT (Trusted Execution Technology) Feature

### Intel TXT (LT-SX) Configuration

This feature displays the following TXT configuration setting.

**TXT (LT-SX) Support:** This item indicates if the Intel TXT support is enabled or disabled. The default setting is **Disabled**.

### Intel TXT (LT-SX) Dependencies

This feature displays the features that need to be enabled for the Intel Trusted Execution Technology to work properly in the system.

**VT-d Support:** Intel Virtualization Technology with Direct I/O support

**VT Support:** Intel Virtualization Technology support

**TPM Support:** Trusted Platform support

**TPM State:** Trusted Platform state

## ► ME Subsystem

This feature displays the following ME Subsystem Configuration settings.

- **ME BIOS Interface Version**
- **ME Version**

**iSCSI Configuration:** This item displays iSCSI configuration information:

### **iSCSI Initiator Name**

This item displays the name of the iSCSI Initiator, which is a unique name used in the world. The name must use IQN format. The following actions can also be performed:

- Add an Attempt
- Delete Attempts
  - Commit/Discard Changes and Exit
- Change Attempt Order
  - Commit/Discard Changes and Exit

**Intel® Ethernet Controller I350 Gigabit Network Connection:** These items display the following information on the Intel I350 Gigabit network connections.

## ► NIC Configuration

### **Link Speed**

Use this feature to change the link speed and duplex for the current port. The options are **AutoNeg**, 10Mbps Half, 10Mbps Full, 100Mbps Half, and 100Mbps full.

### **Wake on LAN**

Select enabled to wake the system with a magic packet. The options are **Enabled** and Disabled.

### **Blink LEDs**

This feature allows the user to specify the duration for LEDs to blink. The range is from 0 ~ 15 seconds. The default setting is **0**.

### **PORT CONFIGURATION INFORMATION**

This section displays the following port information:

- UEFI Driver
- Adapter PBA
- Chip Type
- PCI Device ID
- PCI Bus:Device:Function
- Link Status
- Factory MAC Address / Alternate MAC Address



## 4-4 Event Logs

Select the Event Logs tab to access the following submenu items.

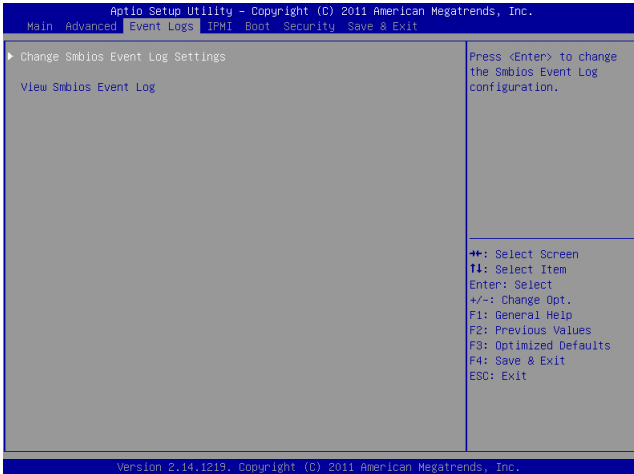

### ► Change SMBIOS Event Log Settings

This feature allows the user to configure SMBIOS Event settings.

#### Enabling/Disabling Options

##### SMBIOS Event Log

Select Enabled to enable SMBIOS (System Management BIOS) Event Logging during system boot. The options are **Enabled** and Disabled.

##### Runtime Error Logging Support

Select Enabled to support Runtime Error Logging. The options are **Enabled** and Disabled.

##### Memory Correctable Error Threshold

This feature allows the user to enter the threshold value for correctable memory errors. The default setting is **10**.

##### PCI Error Logging Support

Select Enabled to support error event logging for PCI slots. The options are Enabled and **Disabled**.

## Erasing Settings

### Erase Event Log

Select Enabled to erase the SMBIOS (System Management BIOS) Event Log, which is completed before a event logging is initialized upon system reboot. The options are **No**, Yes, Next reset, and Yes, Every reset.

### When Log is Full

Select Erase Immediately to immediately erase SMBIOS error event logs that exceed the limit when the SMBIOS event log is full. Select Do Nothing for the system to do nothing when the SMBIOS event log is full. The options are **Do Nothing** and Erase Immediately.

## SMBIOS Event Log Standard Settings

### Log System Boot Event

Select Enabled to log system boot events. The options are **Disabled** and Enabled.

### MECI (Multiple Event Count Increment)

Enter the increment value for the multiple event counter. Enter a number from 1 to 255. The default setting is **1**.

### METW (Multiple Event Count Time Window)

This item allows the user to decide how long (in minutes) should the multiple event counter wait before generating a new event log. Enter a number from 0 to 99. The default setting is **60**.

### View SMBIOS Event Log

This item allows the user to view the event in the SMBIOS event log. Select this item and press <Enter> to view the status of an event in the log.

Date/Time/Error Code/Severity

## 4-5 IPMI

Select the IPMI (Intelligent Platform Management Interface) tab to access the following submenu items.



### IPMI Firmware Revision

This item indicates the IPMI firmware revision used in your system.

### IPMI Status

This item indicates the status of the IPMI firmware installed in your system.

## ► System Event Log

### Enabling/Disabling Options

#### SEL Components

Select Enabled for all system event logging at bootup. The options are **Enabled** and Disabled.

#### Erasing Settings

##### Erase SEL

Select Yes, On next reset to erase all system event logs upon next system reboot.  
 Select Yes, On every reset to erase all system event logs upon each system reboot.  
 Select No to keep all system event logs after each system reboot. The options are **No**, Yes, On next reset, and Yes, On every reset.

### When SEL is Full

This feature allows the user to decide what the BIOS should do when the system event log is full. Select Erase Immediately to erase all events in the log when the system event log is full. The options are **Do Nothing** and Erase Immediately.

### Custom EFI Logging Options

#### Log EFI Status Codes

Select Enabled to log EFI (Extensible Firmware Interface) Status Codes, Error Codes or Progress Codes. The options are **Enabled** and Disabled.



**Note:** After making changes on a setting, be sure to reboot the system for the changes to take effect.

## ►BMC Network Configuration

**LAN Channel 1:** This feature allows the user to configure the settings for LAN1 Port.

#### Update IPMI LAN Configuration

This feature allows the BIOS to implement any IP/MAC address changes at the next system boot. If the option is set to Yes, any changes made to the settings below will take effect when the system is rebooted. The options are **No** and Yes.

#### Configuration Address Source

This feature allows the user to select the source of the IP address for this computer. If Static is selected, you will need to know the IP address of this computer and enter it to the system manually in the field. If DHCP is selected, the BIOS will search for a DHCP (Dynamic Host Configuration Protocol) server in the network that is attached to and request the next available IP address for this computer. The options are **DHCP** and Static. The following items are assigned IP addresses automatically if DHCP is selected, or can be configured manually if Static is selected.

#### Station IP Address

This item displays the Station IP address for this computer. This should be in decimal and in dotted quad form (i.e., 192.168.10.253).

#### Subnet Mask

This item displays the sub-network that this computer belongs to. The value of each three-digit number separated by dots should not exceed 255.

#### Station MAC Address

This item displays the Station MAC address for this computer. Mac addresses are 6 two-digit hexadecimal numbers.

## Gateway IP Address

This item displays the Gateway IP address for this computer. This should be in decimal and in dotted quad form (i.e., 192.168.10.253).

## 4-6 Boot

This submenu allows the user to configure the following boot settings for the system.



### Boot Option Priorities

#### Boot Option #1, Boot Option #2, Boot Option #3, etc.

Use this feature to specify the sequence of boot device priority.

#### Network Devices, Hard Disk Drives

Use these options to set the order of the legacy network and hard drive devices detected by the motherboard.

#### ► Delete Boot Option

This feature allows the user to select a EFI boot device to delete from the boot priority list.

#### Delete Boot Option

Select the desired boot device to delete.

## 4-7 Security

This menu allows the user to configure the following security settings for the system.

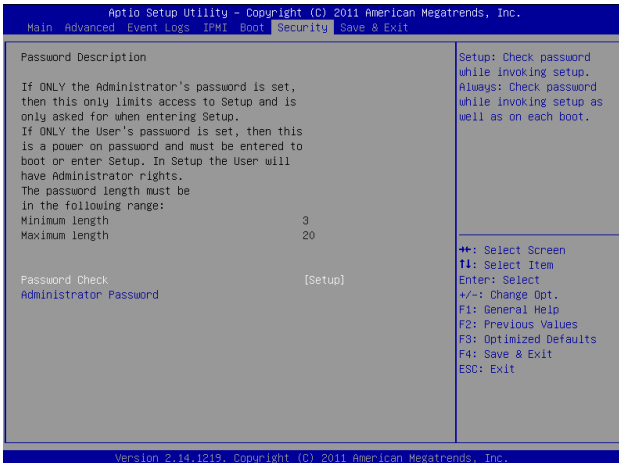

### Password Check

Use this feature to determine when a password entry is required. Select Setup to require the password only when entering setup. Select Always to require the password when entering setup and on each boot. The options are **Setup** and **Always**.

### Administrator Password

Use this feature to set the Administrator Password which is required to enter the BIOS setup utility. The length of the password should be from 3 to 20 characters long.

## 4-8 Save & Exit

This submenu allows the user to configure the Save and Exit settings for the system.

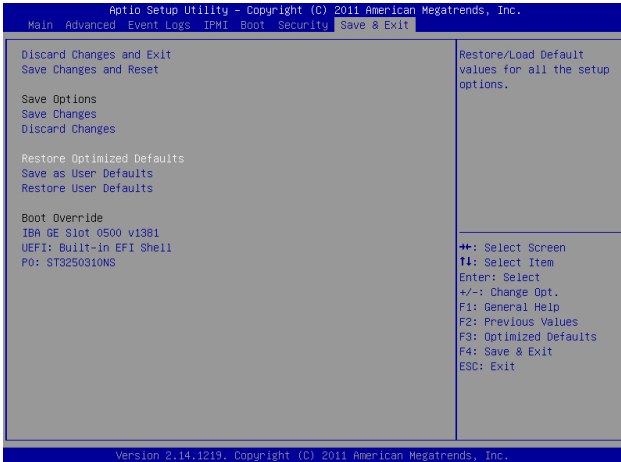

### Discard Changes and Exit

Select this option to quit the BIOS Setup without making any permanent changes to the system configuration, and reboot the computer. Select Discard Changes and Exit, and press <Enter>. When the dialog box appears, asking you if you want to exit the BIOS setup without saving, select **Yes** to quit BIOS without saving the changes, or select No to quit the BIOS and save changes.

### Save Changes and Reset

When you have completed the system configuration changes, select this option to save the changes and reboot the computer so that the new system configuration settings can take effect. Select Save Changes and Exit, and press <Enter>. When the dialog box appears, asking you if you want to exit the BIOS setup without saving, select **Yes** to quit BIOS without saving the changes, or select No to quit the BIOS and save changes.

### Save Options

#### Save Changes

Select this option and press <Enter> to save all changes you've done so far and return to the AMI BIOS utility Program. When the dialog box appears, asking you if you want to save configuration, select **Yes** to save the changes, or select No to return to the BIOS without making changes.

### **Discard Changes**

Select this feature and press <Enter> to discard all the changes and return to the BIOS setup. When the dialog box appears, asking you if you want to load previous values, select **Yes** to load the values previous saved, or select No to keep the changes you've made so far.

### **Restore Optimized Defaults**

Select this feature and press <Enter> to load the optimized default settings that help optimize system performance. When the dialog box appears, asking you if you want to load optimized defaults, select **Yes** to load the optimized default settings, or select No to abandon optimized defaults.

### **Save as User Defaults**

Select this feature and press <Enter> to save the current settings as the user's defaults. When the dialog box appears, asking you if you want to save values as user's defaults, select **Yes** to save the current values as user's default settings, or select No to keep the defaults previously saved as the user's defaults.

### **Restore User Defaults**

Select this feature and press <Enter> to load the user's defaults previously saved in the system. When the dialog box appears, asking you if you want to restore user's defaults, select **Yes** to restore the user's defaults previously saved in the system, or select No to abandon the user's defaults that were previously saved.

### **Boot Override**

This feature allows the user to override the Boot Option Priorities setting in the Boot menu, and instead boot the system with one of the listed devices. This is a one-time override.



## Appendix A

### BIOS Error Beep Codes

During the POST (Power-On Self-Test) routines, which are performed at each system boot, errors may occur.

**Non-fatal errors** are those which, in most cases, allow the system to continue to boot. The error messages normally appear on the screen.

**Fatal errors** will not allow the system to continue with bootup procedure. If a fatal error occurs, you should consult with your system manufacturer for possible repairs.

These fatal errors are usually communicated through a series of audible beeps. The numbers on the fatal error list correspond to the number of beeps for the corresponding error.

#### A-1 BIOS Error Beep Codes

BIOS Error Beep Codes		
Beep Code/LED	Error Message	Description
1 beep	Refresh	Ready to boot
5 short beeps + 1 long beep	Memory error	No memory detected in the system
5 beeps	No Con-In or No Con-Out devices	Con-In: USB or PS/2 keyboard, PCI or Serial Console Redirection, IPMI KVM or SOL  Con-Out: Video Controller, PCI or Serial Console Redirection, IPMI SOL
1 beep per device	Refresh	1 beep for each USB device
X9 IPMI Error Codes		
1 Continuous Beep	System OH	System Overheat

## Notes

## Appendix B

### Software Installation Instructions

#### B-1 Installing Software Programs

The Supermicro ftp site contains drivers and utilities for your system at <ftp://ftp.supermicro.com>. Some of these must be installed, such as the chipset driver.

After accessing the ftp site, go into the CDR\_Images directory and locate the ISO file for your motherboard. Download this file to create a CD/DVD of the drivers and utilities it contains. (You may also use a utility to extract the ISO file if preferred.)

Another option is to go to the Supermicro Website at <http://www.supermicro.com/products/>. Find the product page for your motherboard here, where you may download individual drivers and utilities.

After creating a CD/DVD with the ISO files, insert the disk into the CD/DVD drive on your system and the display shown below should appear.

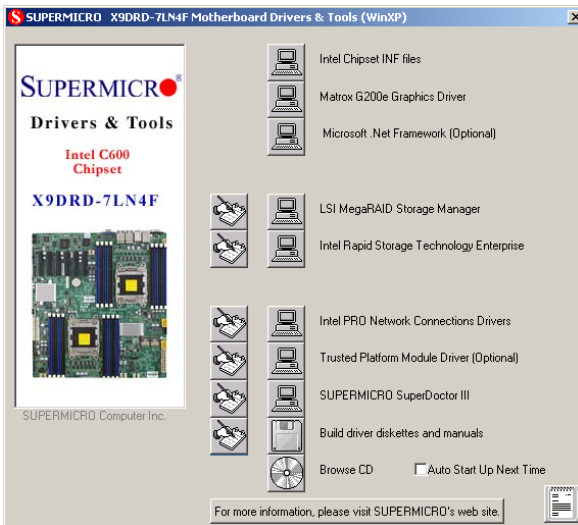

#### Driver/Tool Installation Display Screen

 **Note 1:** Click the icons showing a hand writing on paper to view the readme files for each item. Click the computer icons to the right of these items to install each item (from top to the bottom) one at a time. **After installing each item, you must re-boot the system before moving on to the next item on the list.** The bottom icon with a CD on it allows you to view the entire contents.

 **Note 2:** When making a storage driver diskette by booting into a Driver CD, please set the SATA Configuration to "Compatible Mode" and configure SATA as IDE in the BIOS Setup. After making the driver diskette, be sure to change the SATA settings back to your original settings.

 **Note 3:** Changing BMC log-in information is recommended during initial system power-on. The default username is ADMIN and password is ADMIN. For BMC best practices, please refer to: [http://www.supermicro.com/products/nfo/files/IPMI/Best\\_Practices\\_BMC\\_Security.pdf](http://www.supermicro.com/products/nfo/files/IPMI/Best_Practices_BMC_Security.pdf)

## B-2 Configuring SuperDoctor III

The SuperDoctor<sup>®</sup> III program is a web-based management tool that supports remote management capability. It includes Remote and Local Management tools. The local management is called SD III Client. The SuperDoctor III program allows you to monitor the environment and operations of your system. SuperDoctor III displays crucial system information such as CPU temperature, system voltages and fan status. See the figures below for examples of the SuperDoctor III interface.

 **Note:** The default User Name and Password for SuperDoctor III is ADMIN / ADMIN.

 **Note:** When SuperDoctor III is first installed, it adopts the temperature threshold settings that have been set in BIOS. Any subsequent changes to these thresholds must be made within SuperDoctor III, as the SuperDoctor III settings override the BIOS settings. To set the BIOS temperature threshold settings again, you would first need to uninstall SuperDoctor III.

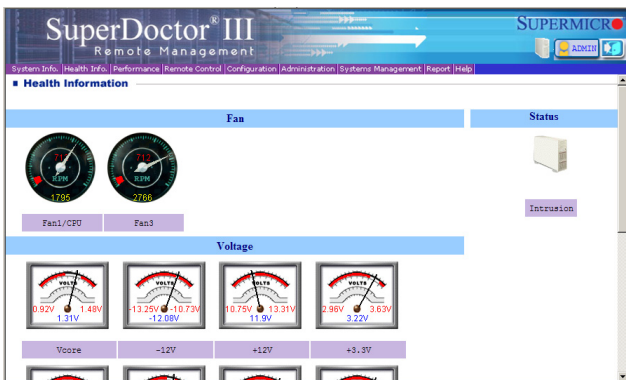

SuperDoctor<sup>®</sup> III Interface Display Screen-I (Health Information)

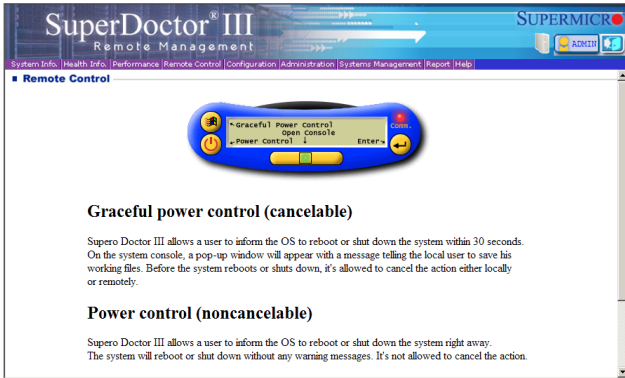

### SuperDoctor® III Interface Display Screen-II (Remote Control)

 **Note:** SD III Software Revision 1.0 can be downloaded from our Web Site at: [ftp://ftp.supermicro.com/utility/Super\\_Doctor\\_III/](ftp://ftp.supermicro.com/utility/Super_Doctor_III/). You can also download the SDIII User's Guide at: <http://www.supermicro.com/PRODUCT/Manuals/SDIII/UserGuide.pdf>. For Linux, we will recommend using SuperDoctor II.

## Notes

(Disclaimer Continued)

The products sold by Supermicro are not intended for and will not be used in life support systems, medical equipment, nuclear facilities or systems, aircraft, aircraft devices, aircraft/emergency communication devices or other critical systems whose failure to perform be reasonably expected to result in significant injury or loss of life or catastrophic property damage. Accordingly, Supermicro disclaims any and all liability, and should buyer use or sell such products for use in such ultra-hazardous applications, it does so entirely at its own risk. Furthermore, buyer agrees to fully indemnify, defend and hold Supermicro harmless for and against any and all claims, demands, actions, litigation, and proceedings of any kind arising out of or related to such ultra-hazardous use or sale.