

Dell PowerEdge R330 Owner's Manual

Regulatory Model: E34S Series
Regulatory Type: E34S001



Notes, cautions, and warnings

 **NOTE:** A NOTE indicates important information that helps you make better use of your computer.

 **CAUTION:** A CAUTION indicates either potential damage to hardware or loss of data and tells you how to avoid the problem.

 **WARNING:** A WARNING indicates a potential for property damage, personal injury, or death.

Copyright © 2015 Dell Inc. All rights reserved. This product is protected by U.S. and international copyright and intellectual property laws. Dell™ and the Dell logo are trademarks of Dell Inc. in the United States and/or other jurisdictions. All other marks and names mentioned herein may be trademarks of their respective companies.

2015 - 09

Rev. A00

Contents

| | |
|--|-----------|
| 1 About your system..... | 9 |
| Supported configurations on PowerEdge R330 systems..... | 9 |
| Front panel features and indicators..... | 9 |
| LCD panel features..... | 14 |
| Diagnostic indicators..... | 14 |
| Hot swappable hard drive indicator codes..... | 16 |
| Back panel features and indicators..... | 17 |
| NIC indicator codes..... | 18 |
| Indicator codes for redundant power supply unit..... | 19 |
| Documentation matrix..... | 20 |
| Accessing system information by using QRL..... | 21 |
| 2 Performing initial system configuration | 23 |
| Setting up your system..... | 23 |
| Setting up and configuring the iDRAC IP address | 23 |
| Logging in to iDRAC..... | 24 |
| Methods of installing the operating system..... | 24 |
| Managing your system remotely..... | 24 |
| Downloading drivers and firmware..... | 24 |
| 3 Pre-operating system management applications..... | 26 |
| Navigation keys..... | 26 |
| About System Setup..... | 27 |
| Entering System Setup..... | 27 |
| System Setup Main Menu..... | 27 |
| System BIOS screen details..... | 27 |
| System Information screen details..... | 28 |
| Memory Settings screen details..... | 29 |
| Processor Settings screen details..... | 29 |
| SATA Settings screen details..... | 30 |
| Boot Settings screen details..... | 32 |
| Network Settings screen details..... | 33 |
| Integrated Devices screen details..... | 33 |
| Serial Communication screen details..... | 34 |
| System Profile Settings screen details..... | 35 |
| System Security Settings screen details..... | 36 |
| Miscellaneous Settings screen details..... | 38 |
| About Boot Manager..... | 39 |

| | |
|--|----|
| Entering Boot Manager..... | 39 |
| Boot Manager main menu..... | 39 |
| About Dell Lifecycle Controller..... | 39 |
| Changing the boot order..... | 39 |
| Choosing the system boot mode..... | 40 |
| Creating a system and setup password..... | 40 |
| Using your system password to secure your system..... | 41 |
| Deleting or changing system password and setup password..... | 41 |
| Operating with a setup password enabled..... | 42 |
| Embedded system management..... | 42 |
| iDRAC Settings utility..... | 42 |
| Entering the iDRAC settings utility..... | 42 |
| Changing the thermal settings..... | 43 |

4 Installing and removing system components.....44

| | |
|---|----|
| Safety instructions..... | 44 |
| Before working inside your system..... | 44 |
| After working inside your system..... | 44 |
| Recommended tools..... | 45 |
| Front bezel (optional)..... | 45 |
| Installing the optional front bezel..... | 45 |
| Removing the optional front bezel..... | 46 |
| System cover..... | 46 |
| Removing the system cover..... | 46 |
| Installing the system cover..... | 47 |
| Inside the system..... | 48 |
| Intrusion switch..... | 51 |
| Removing the intrusion switch..... | 51 |
| Installing the intrusion switch..... | 52 |
| Cooling shroud..... | 52 |
| Removing the cooling shroud..... | 52 |
| Installing the cooling shroud..... | 53 |
| System memory..... | 54 |
| General memory module installation guidelines..... | 55 |
| Sample memory configurations..... | 55 |
| Removing a memory module..... | 56 |
| Installing a memory module..... | 57 |
| Hard drives..... | 59 |
| Supported hard drive configurations | 60 |
| Removing a 2.5-inch hot swappable hard drive blank..... | 60 |
| Installing a 2.5-inch hot swappable hard drive blank..... | 61 |
| Removing a 3.5-inch hot swappable hard drive carrier blank..... | 62 |

| | |
|--|----|
| Installing a 3.5-inch hot swappable hard drive carrier blank..... | 62 |
| Removing a 3.5-inch cabled hard drive carrier..... | 63 |
| Removing a cabled hard drive from a hard drive carrier..... | 64 |
| Installing a cabled hard drive into a hard drive carrier..... | 65 |
| Installing a 3.5-inch cabled hard drive carrier..... | 66 |
| Removing a hot swappable hard drive carrier..... | 67 |
| Installing a hot swappable hard drive carrier..... | 68 |
| Removing the optional 1.8-inch solid state drives..... | 69 |
| Installing the optional 1.8-inch solid state drives..... | 70 |
| Installing a 2.5-inch hot swappable hard drive into a 3.5-inch hard drive adapter..... | 71 |
| Removing a 2.5-inch hot swappable hard drive from a 3.5-inch hard drive adapter..... | 72 |
| Installing a 3.5-inch hard drive adapter into the 3.5-inch hot swappable hard drive carrier..... | 73 |
| Removing a 3.5-inch hard drive adapter from a 3.5-inch hot swappable hard drive carrier..... | 74 |
| Removing a hot swappable hard drive from a hard drive carrier..... | 74 |
| Installing a hot swappable hard drive into a hot swappable hard drive carrier..... | 75 |
| Optical drive (optional)..... | 76 |
| Removing the optional optical drive..... | 76 |
| Installing the optional optical drive..... | 77 |
| Cooling fans..... | 78 |
| Removing the cooling fan blank..... | 78 |
| Installing the cooling fan blank..... | 79 |
| Removing a cooling fan..... | 80 |
| Installing a cooling fan..... | 81 |
| Internal USB memory key (optional)..... | 82 |
| Replacing the optional internal USB memory key..... | 82 |
| Expansion cards and expansion card riser..... | 83 |
| Expansion card installation guidelines..... | 83 |
| Removing the expansion card riser..... | 85 |
| Installing the expansion card riser..... | 86 |
| Removing an expansion card..... | 87 |
| Installing an expansion card..... | 88 |
| Removing the internal PERC card..... | 89 |
| Installing the internal PERC card..... | 90 |
| iDRAC port card (optional)..... | 91 |
| Replacing an optional SD vFlash card..... | 91 |
| Removing the optional iDRAC port card..... | 92 |
| Installing the optional iDRAC port card..... | 94 |
| Internal dual SD module (optional)..... | 94 |
| Removing an optional internal SD card..... | 94 |
| Installing an optional internal SD card..... | 95 |
| Removing the optional internal dual SD module..... | 95 |
| Installing the optional internal dual SD module | 97 |

| | |
|---|------------|
| Heat sink and processor..... | 98 |
| Removing the heat sink..... | 98 |
| Removing the processor..... | 99 |
| Installing the processor..... | 101 |
| Installing the heat sink..... | 103 |
| Power supply units..... | 105 |
| Hot spare feature..... | 105 |
| Removing a redundant power supply unit..... | 105 |
| Installing a redundant power supply unit..... | 106 |
| Removing the power supply unit blank..... | 107 |
| Installing the power supply unit blank..... | 108 |
| System battery..... | 108 |
| Replacing the system battery..... | 108 |
| Hard drive backplane..... | 110 |
| Removing the hard drive backplane..... | 110 |
| Installing the hard drive backplane..... | 119 |
| Control panel assembly..... | 119 |
| Removing the LCD control panel assembly..... | 119 |
| Installing the LCD control panel assembly..... | 121 |
| Removing the LED control panel assembly..... | 122 |
| Installing the LED control panel assembly..... | 123 |
| Power interposer board..... | 124 |
| Removing the power interposer board..... | 124 |
| Installing the power interposer board..... | 125 |
| Trusted Platform Module..... | 126 |
| Installing the Trusted Platform Module..... | 126 |
| Re-enabling the TPM for BitLocker users..... | 127 |
| Re-enabling the TPM for TXT users..... | 127 |
| System board..... | 128 |
| Removing the system board..... | 128 |
| Installing the system board..... | 130 |
| 5 Troubleshooting your system..... | 133 |
| Safety first—for you and your system..... | 133 |
| Troubleshooting system startup failure..... | 133 |
| Troubleshooting external connections..... | 133 |
| Troubleshooting the video subsystem..... | 133 |
| Troubleshooting a USB device..... | 133 |
| Troubleshooting iDRAC Direct (USB XML configuration)..... | 134 |
| Troubleshooting iDRAC Direct (Laptop connection)..... | 135 |
| Troubleshooting a serial I/O device..... | 135 |
| Troubleshooting an NIC..... | 135 |

| | |
|---|------------|
| Troubleshooting a wet system..... | 136 |
| Troubleshooting a damaged system..... | 137 |
| Troubleshooting the system battery..... | 137 |
| Troubleshooting power supply units..... | 138 |
| Troubleshooting power source problems..... | 138 |
| Power supply unit problems..... | 138 |
| Troubleshooting cooling problems..... | 139 |
| Troubleshooting cooling fans..... | 139 |
| Troubleshooting system memory..... | 140 |
| Troubleshooting an internal USB key..... | 141 |
| Troubleshooting an SD card..... | 141 |
| Troubleshooting an optical drive..... | 142 |
| Troubleshooting a tape backup unit..... | 143 |
| Troubleshooting a hard drive..... | 143 |
| Troubleshooting a storage controller..... | 144 |
| Troubleshooting expansion cards..... | 145 |
| Troubleshooting processors..... | 145 |
| 6 Using system diagnostics..... | 147 |
| Dell Embedded System Diagnostics..... | 147 |
| When to use the Embedded System Diagnostics..... | 147 |
| Running the Embedded System Diagnostics from Boot Manager..... | 147 |
| Running the Embedded System Diagnostics from the Dell Lifecycle Controller..... | 147 |
| System diagnostics controls..... | 148 |
| 7 Jumpers and connectors..... | 149 |
| System board jumper settings..... | 149 |
| System board connectors..... | 150 |
| Disabling a forgotten password..... | 151 |
| 8 Technical specifications..... | 153 |
| Dimensions and weight..... | 153 |
| Processor specifications..... | 153 |
| Expansion bus specifications..... | 154 |
| Memory specifications..... | 154 |
| Power specifications..... | 154 |
| Storage controller specifications..... | 155 |
| Drive specifications..... | 155 |
| Connectors specifications..... | 156 |
| Video specifications..... | 156 |
| Expanded operating temperature..... | 156 |
| Environmental specifications..... | 157 |

| | |
|---------------------------------------|------------|
| 9 Getting help..... | 160 |
| Contacting Dell..... | 160 |
| Locating your system Service Tag..... | 160 |
| Documentation feedback..... | 160 |

About your system

The Dell PowerEdge R330 rack server supports one processor based on the Intel E3-1200V5 series, up to 4 DIMMs, and up to eight hard drives or solid state drives (SSDs).

Supported configurations on PowerEdge R330 systems

The PowerEdge R330 systems are available in the following configurations:

Table 1. Supported configurations on PowerEdge R330 systems

| System | Configuration |
|--------------------------|---|
| Four hard drive systems | Up to four 3.5-inch, cabled hard drives and two optional 1.8-inch solid state drives (SSDs) in the optical drive slot Up to four 3.5-inch (2.5-inch with adapter), hot-swappable hard drives |
| Eight hard drive systems | Up to eight 2.5-inch, hot-swappable hard drives or SSDs |

Front panel features and indicators

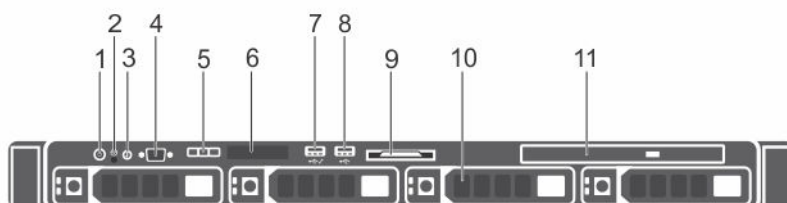









Figure 1. Front panel features and indicators — four 3.5-inch hot-swappable hard drive chassis

Table 2. Front panel features and indicators— four 3.5-inch hot-swappable hard drive chassis

| Item | Indicator, button, or connector | Icon | Description |
|------|----------------------------------|---|--|
| 1 | Power-on indicator, power button |  | Enables you to know the power status of the system. The power-on indicator glows when the system power is on. The power button controls the power supply output to the system. |

| Item | Indicator, button, or connector | Icon | Description |
|------|--|---|---|
| | | |  NOTE: On ACPI-compliant operating systems, turning off the system by pressing the power button causes the system to perform a graceful shutdown before power to the system is turned off. |
| 2 | NMI button |  | <p>Enables you to troubleshoot software and device driver errors when running certain operating systems. This button can be pressed by using the end of a paper clip.</p> <p>Use this button only if directed to do so by qualified support personnel or by the operating system's documentation.</p> |
| 3 | System identification button |  | <p>Enables you to locate a particular system within a rack. The identification buttons are on the front and back panels. When one of these buttons is pressed, the LCD panel on the front and the system status indicator on the back flash until one of the buttons is pressed again.</p> <p>Press the system identification button to turn the system ID on or off.</p> <p>If the system stops responding during POST, press and hold the system ID button for more than five seconds to enter BIOS progress mode.</p> <p>To reset iDRAC (if not disabled in F2 iDRAC setup), press and hold the button for more than 15 seconds.</p> |
| 4 | Video connector |  | Enables you to connect a display to the system. |
| 5 | LCD menu buttons | | Enable you to navigate the control panel LCD menu. |
| 6 | LCD panel | | <p>Displays system ID, status information, and system error messages. See LCD panel features.</p> <p> NOTE: LCD panel is not available in a cabled hard drive chassis.</p> |
| 7 | USB management port/ iDRAC managed USB port |  | Functions as a regular USB port or provide access to the iDRAC Direct features. For more information, see the iDRAC User's Guide at Dell.com/idracmanuals . |
| 8 | USB connector |  | Enables you to connect USB devices to the system. The port is USB 2.0-compliant. |
| 9 | Information tag | | Contains system information such as service tag, NIC, MAC address for your reference. The information tag is a slide-out label panel. |

| Item | Indicator, button, or connector | Icon | Description |
|------|---------------------------------|------|--|
| 10 | Hard drives slots | | Enables you to install up to four 3.5-inch hot-swappable hard drives or four 2.5-inch hot-swappable hard drives in 3.5-inch hard drive adapters. |
| 11 | Optical drive slot | | Enables you to install an optional slim SATA DVD-ROM drive or DVD+/-RW drive. |

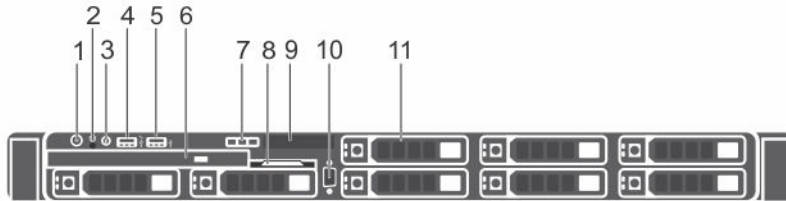





Figure 2. Front panel features and indicators — eight 2.5-inch hot-swappable hard drives or SSDs chassis

Table 3. Front panel features and indicators—eight 2.5-inch hot-swappable hard drives or SSDs chassis

| Item | Indicator, Button, or Connector | Icon | Description |
|------|----------------------------------|------|---|
| 1 | Power-on indicator, power button | | <p>Enables you to know the power status of the system. The power-on indicator glows when the system power is on. The power button controls the power supply output to the system.</p> <p>NOTE: On ACPI-compliant operating systems, turning off the system by pressing the power button causes the system to perform a graceful shutdown before power to the system is turned off.</p> |
| 2 | NMI button | | <p>Enables you to troubleshoot software and device driver errors when running certain operating systems. This button can be pressed by using the end of a paper clip.</p> <p>Use this button only if directed to do so by qualified support personnel or by the operating system's documentation.</p> |
| 3 | System identification button | | <p>Enables you to locate a particular system within a rack. The identification buttons are on the front and back panels. When one of these buttons is pressed, the LCD panel on the front and the system status indicator on the back flash until one of the buttons is pressed again.</p> |

| Item | Indicator, Button, or Connector | Icon | Description |
|------|--|---|--|
| | | | <p>Press the system identification button to turn the system ID on or off.</p> <p>If the system stops responding during POST, press and hold the system ID button for more than five seconds to enter BIOS progress mode.</p> <p>To reset iDRAC (if not disabled in F2 iDRAC setup), press and hold the button for more than 15 seconds.</p> |
| 4 | USB management port/ iDRAC managed USB port |  | Functions as a regular USB port or provide access to the iDRAC Direct features. For more information, see the iDRAC User's Guide at Dell.com/idracmanuals . |
| 5 | USB connector |  | Enables you to connect USB devices to the system. The port is USB 2.0-compliant. |
| 6 | Optical drive slot | | Enables you to install an optional slim SATA DVD-ROM drive or DVD+/-RW drive. |
| 7 | LCD menu buttons | | Enable you to navigate the control panel LCD menu. |
| 8 | Information tag | | Contains system information such as service tag, NIC, MAC address for your reference. The information tag is a slide-out label panel. |
| 9 | LCD panel | | Displays system ID, status information, and system error messages. See LCD panel features . |
| 10 | Video connector |  | Enables you to connect a VGA display to the system. |
| 11 | Hard drive slots | | Enables you to install up to eight 2.5-inch hot swappable hard drives. |

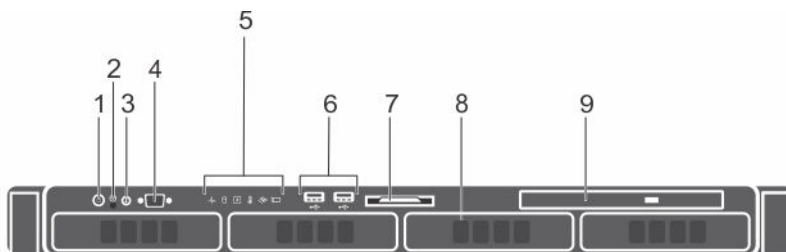







Figure 3. Front panel features and indicators — four 3.5-inch cabled hard drive chassis

Table 4. Front panel features and indicators — four 3.5-inch cabled hard drive chassis

| Item | Indicator, Button, or Connector | Icon | Description |
|------|----------------------------------|---|---|
| 1 | Power-on indicator, power button |  | <p>Enables you to know the power status of the system. The power-on indicator glows when the system power is on. The power button controls the power supply output to the system.</p> <p> NOTE: On ACPI-compliant operating systems, turning off the system by pressing the power button causes the system to perform a graceful shutdown before power to the system is turned off.</p> |
| 2 | NMI button |  | <p>Enables you to troubleshoot software and device driver errors when running certain operating systems. This button can be pressed by using the end of a paper clip.</p> <p>Use this button only if directed to do so by qualified support personnel or by the operating system's documentation.</p> |
| 3 | System identification button |  | <p>Enables you to locate a particular system within a rack. The identification buttons are on the front and back panels. When one of these buttons is pressed, the LCD panel on the front and the system status indicator on the back flash until one of the buttons is pressed again.</p> <p>Press the system identification button to turn the system ID on or off.</p> <p>If the system stops responding during POST, press and hold the system ID button for more than five seconds to enter BIOS progress mode.</p> <p>To reset iDRAC (if not disabled in F2 iDRAC setup), press and hold the button for more than 15 seconds.</p> |
| 4 | Video connector |  | Enables you to connect a display to the system. |
| 5 | Diagnostic indicators | | Glows to display error status. For more information, see Diagnostic indicators . |
| 6 | USB connectors |  | Enable you to connect USB devices to the system. The ports are USB 2.0-compliant. |
| 7 | Information tag | | Contains system information such as service tag, NIC, MAC address for your reference. The information tag is a slide-out label panel. |
| 8 | Hard drive slots | | Enables you to install up to four 3.5-inch cabled hard drives. |

| Item | Indicator, Button, or Connector | Icon | Description |
|------|--|------|---|
| 9 | Optical drive or solid state drive (SSDs) slot | | Enables you to install one optional SATA DVD-ROM drive or DVD+/-RW drive, or two optional 1.8-inch SSDs |

LCD panel features

The system's LCD panel provides system information and status and error messages to indicate if the system is operating correctly or if the system needs attention. For more information about the error messages, see the *Dell Event and Error Messages Reference Guide* at Dell.com/openmanagemanuals > **OpenManage software**.

- The LCD backlight turns blue during normal operating conditions and turns amber to indicate an error condition.
- The LCD backlight is turned off when the system is in standby mode and can be turned on by pressing either the Select, Left, or Right button on the LCD panel.
- The LCD backlight remains OFF if LCD messaging is turned off through the iDRAC utility, the LCD panel, or other tools.

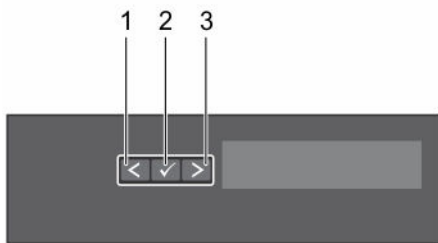

Figure 4. LCD panel Features

- | | |
|----------|-----------|
| 1. Left | 2. Select |
| 3. Right | |

| Button | Description |
|--------|--|
| Left | Moves the cursor back in one-step increments. |
| Select | Selects the menu item highlighted by the cursor. |
| Right | Moves the cursor forward in one-step increments. During message scrolling: <ul style="list-style-type: none"> • Press once to increase scrolling speed • Press again to stop • Press again to return to the default scrolling speed • Press again to repeat the cycle |

Diagnostic indicators

The diagnostic indicators on the system front panel display error status during system startup.







 **NOTE:** No diagnostic indicators are lit when the system is switched off. To start the system, plug it into a working power source and press the power button.

Table 5. Diagnostic indicators

| Icon | Description | Condition | Corrective action |
|---|-----------------------|---|--|
|  | Health indicator | <p>If the system is on and in good health, the indicator turns solid blue.</p> <p>The indicator flashes amber if the system is on or in standby, and if any error exists (for example, a failed fan or hard drive).</p> | <p>None required.</p> <p>Check the System Event Log or system messages for the specific issue. For more information about error messages, see the Dell Event and Error Messages Reference Guide at Dell.com/openmanagemanuals > OpenManage software.</p> <p>Invalid memory configurations can cause the system to halt at startup without any video output. See Getting help.</p> |
|  | Hard drive indicator | The indicator flashes amber if there is a hard drive error. | Check the System Event Log to determine the hard drive that has an error. Run the appropriate Online Diagnostics test. Restart the system and run embedded diagnostics (ePSA). If the hard drives are configured in a RAID array, restart the system and enter the host adapter configuration utility program. |
|  | Electrical indicator | The indicator flashes amber if the system experiences an electrical error (for example, voltage out of range, or a failed power supply unit (PSU) or voltage regulator). | Check the System Event Log or system messages for the specific issue. If it is due to a problem with the PSU, check the LED on the PSU. Reseat the PSU. If the problem persists, see Getting help . |
|  | Temperature indicator | The indicator flashes amber if the system experiences a thermal error (for example, a temperature out of range or fan failure). | <p>Ensure that none of the following conditions exist:</p> <ul style="list-style-type: none"> • A cooling fan is removed or has failed. • System cover, cooling shroud, EMI filler panel, memory module blank, or back filler bracket is removed. • Ambient temperature is too high. • External airflow is obstructed. <p>See Getting help.</p> |
|  | Memory indicator | The indicator flashes amber if a memory error occurs. | Check the system event log or system messages for the location of the failed memory. Reseat the memory module. If the problem persists, see Getting help . |

| Icon | Description | Condition | Corrective action |
|---|----------------|--|--|
|  | PCIe indicator | The indicator flashes amber if a PCIe card experiences an error. | Restart the system. Update any required drivers for the PCIe card. Reinstall the card. If the problem persists, see Getting help . |

Hot swappable hard drive indicator codes

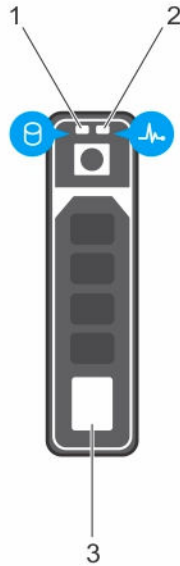



Figure 5. Hot swappable hard drive indicators

1. hard drive activity indicator
2. hard drive status indicator
3. hard drive

 **NOTE:** If the hard drive is in Advanced Host Controller Interface (AHCI) mode, the status indicator (on the right side) does not function and remains OFF.

Table 6. Hot swappable hard drive indicators

| Drive-status indicator pattern (RAID only) | Condition |
|--|--|
| Flashes green two times per second | Identifying drive or preparing for removal. |
| OFF | Drive ready for insertion or removal. |
| |  NOTE: The drive status indicator remains OFF until all hard drives are initialized after the system is turned on. Drives are not ready for insertion or removal during this time. |
| Flashes green, amber, and turns off | Predicted drive failure |
| Flashes amber four times per second | Drive failed |
| Flashes green slowly | Drive rebuilding |
| Turns green | Drive online |

| Drive-status indicator pattern (RAID only) | Condition |
|---|-----------------|
| Flashes green three seconds, amber three seconds, and turns off six seconds | Rebuild stopped |

Back panel features and indicators

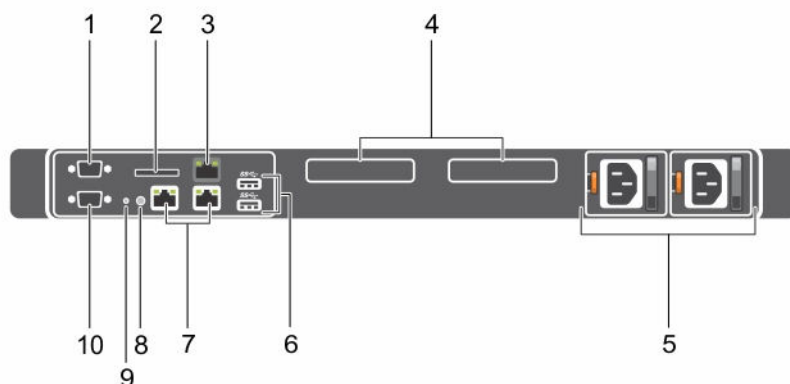



Figure 6. Back panel features and indicators

Table 7. Back panel features and indicators

| Item | Indicator, button, or connector | Icon | Description |
|------|-----------------------------------|-------|--|
| 1 | Serial connector | 10101 | Enables you to connect a serial device to the system. |
| 2 | vFlash card slot (optional) | | Enables you to connect the vFlash card. |
| 3 | iDRAC port (optional) | | Enables you to install a dedicated management port card. |
| 4 | PCIe expansion card slots (2) | | Enable you to connect PCI Express expansion cards. |
| 5 | Power supply unit (PSU1 and PSU2) | | Enables you to install up to two 350 W redundant AC power supply units. |
| 6 | USB connectors | SS | Enable you to connect USB devices to the system. These ports are USB 3.0-compliant. |
| 7 | Ethernet connectors | | Enable you to connect Integrated 10/100/1000 Mbps NIC connectors. |
| 8 | System identification button | | Enables you to locate a particular system within a rack. The identification buttons are on the front and back panels. When one of these buttons is pressed, the LCD panel on the front and the |

| Item | Indicator, button, or connector | Icon | Description |
|------|---------------------------------|---|--|
| | | | <p>system status indicator on the back flash until one of the buttons is pressed again.</p> <p>Press the system identification button to turn the system ID on or off.</p> <p>If the system stops responding during POST, press and hold the system ID button for more than five seconds to enter BIOS progress mode.</p> <p>To reset iDRAC (if not disabled in F2 iDRAC setup), press and hold the button for more than 15 seconds.</p> |
| 9 | System identification connector | | Connects the optional system status indicator assembly through the optional cable management arm. |
| 10 | Video connector |  | Enables you to connect a VGA display to the system. |

NIC indicator codes

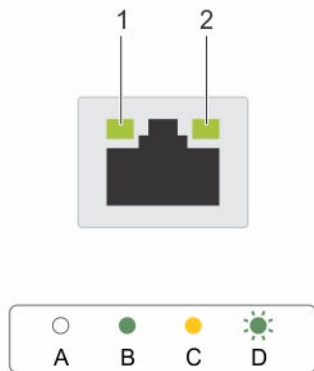

Figure 7. NIC indicators

1. link indicator
2. activity indicator

Table 8. NIC indicators

| Convention | Indicator pattern | Description |
|------------|--------------------------------------|---|
| A | Link and activity indicators are OFF | The NIC is not connected to the network. |
| B | Link indicator is green | The NIC is connected to a valid network at its maximum port speed (1 Gbps). |

| Convention | Indicator pattern | Description |
|------------|--------------------------------------|--|
| C | Link indicator is yellow | The NIC is connected to a valid network at less than its maximum port speed. |
| D | Activity indicator is flashing green | Network data is being sent or received. |

Indicator codes for redundant power supply unit

Each AC power supply unit (PSU) has an illuminated translucent handle that indicates whether power is present or whether a power fault has occurred.







Figure 8. AC PSU status indicator

1. AC PSU status indicator or handle

Table 9. Redundant AC PSU status indicator

| Convention | Power Indicator Pattern | Condition |
|------------|------------------------------|--|
| A | Green | A valid power source is connected to the PSU and the PSU is operational. |
| B | Flashing green | When the PSU firmware is being updated, the PSU handle flashes green. ⚠ CAUTION: Do not disconnect the power cord or unplug the PSU when updating firmware. If firmware update is interrupted, the PSUs will not function. You must roll back the PSU firmware by using Dell Lifecycle Controller. For more information, see Dell Lifecycle Controller User's Guide at Dell.com/idracmanuals. |
| C | Flashing green and turns off | When hot-adding a PSU, the PSU handle flashes green five times at 4 Hz rate and turns off. This indicates that there is a PSU mismatch |

| Convention | Power Indicator Pattern | Condition |
|------------|-------------------------|---|
| | | with respect to efficiency, feature set, health status, and supported voltage. Ensure that both the PSUs are the same. |
| D | Flashing amber | <p>Indicates a problem with the PSU.</p> <p> CAUTION: When correcting a PSU mismatch, replace only the PSU with the flashing indicator. Swapping the other PSU to make a matched pair can result in an error condition and unexpected system shutdown. To change from a High Output configuration to a Low Output configuration or vice versa, you must turn off the system.</p> <p> CAUTION: AC PSUs support both 220 V and 110 V input voltages with the exception of Titanium PSUs, which support only 220 V. When two identical PSUs receive different input voltages, they can output different wattages, and trigger a mismatch.</p> <p> CAUTION: If two PSUs are used, they must be of the same type and have the same maximum output power.</p> <p> CAUTION: Combining AC and DC PSUs is not supported and triggers a mismatch.</p> |
| E | Not lit | Power is not connected. |

Documentation matrix

The documentation matrix provides information on documents that you can refer to for setting up and managing your system.

Table 10. Documentation matrix

| To... | See the... |
|---|---|
| Install your system into a rack | Rack documentation included with your rack solution |
| Set up your system and know the system technical specifications | <i>Getting Started With Your System</i> that shipped with your system or see Dell.com/poweredgemanuals |
| Install the operating system | Operating system documentation at Dell.com/operatingsystemmanuals |
| Get an overview of the Dell Systems Management offerings | Dell OpenManage Systems Management Overview Guide at Dell.com/openmanagemanuals > OpenManage software |
| Configure and log in to iDRAC, set up managed and management system, know the iDRAC features, and troubleshoot by using iDRAC | Integrated Dell Remote Access Controller User's Guide at Dell.com/idracmanuals |
| Know about the RACADM subcommands and supported RACADM interfaces | RACADM Command Line Reference Guide for iDRAC at Dell.com/idracmanuals |

| To... | See the... |
|--|--|
| Launch, enable, and disable Dell Lifecycle Controller, know the features, use and troubleshoot Dell Lifecycle Controller | Dell Lifecycle Controller User's Guide at Dell.com/idracmanuals |
| Use Dell Lifecycle Controller Remote Services | Dell Lifecycle Controller Remote Services Quick Start Guide at Dell.com/idracmanuals |
| Set up, use, and troubleshoot OpenManage Server Administrator | Dell OpenManage Server Administrator User's Guide at Dell.com/openmanagemanuals > OpenManage Server Administrator |
| Install, use, and troubleshoot OpenManage Essentials | Dell OpenManage Essentials User's Guide at Dell.com/openmanagemanuals > OpenManage Essentials |
| Know the features of the storage controller cards, deploy the cards, and manage the storage subsystem | Storage controller documentation at Dell.com/storagecontrollermanuals |
| Check the event and error messages generated by the system firmware and agents that monitor system components | Dell Event and Error Messages Reference Guide at Dell.com/openmanagemanuals > OpenManage software |

Accessing system information by using QRL

You can use the Quick Resource Locator (QRL) to get immediate access to the information about your system.

Prerequisites

Ensure that your smartphone or tablet has the QR code scanner installed.

About this task

The QRL includes the following information about your system:

- How-to videos
- Reference materials, including the Owner's Manual, LCD diagnostics, and mechanical overview
- Your system service tag to quickly access your specific hardware configuration and warranty information
- A direct link to Dell to contact technical support and sales teams

Steps

1. Go to Dell.com/QRL and navigate to your specific product or
2. Use your smartphone or tablet to scan the model-specific Quick Resource (QR) code located in the following image or on your Dell PowerEdge system:



Performing initial system configuration

After you receive your system, you must set up your system, install the operating system if it is not pre-installed, and set up and configure the system iDRAC IP address.

Setting up your system

1. Unpack the system.
2. Install the system into the rack. For more information about installing the system into the rack, see your system *Rack Installation* placemat at Dell.com/poweredgemanuals.
3. Connect the peripherals to the system.
4. Connect the system to its electrical outlet.
5. Turn the system on by pressing the power button or by using iDRAC.
6. Turn on the attached peripherals.

Setting up and configuring the iDRAC IP address

You can set up the Integrated Dell Remote Access Controller (iDRAC) IP address by using one of the following interfaces:

- iDRAC Settings utility
- Dell Lifecycle Controller
- Dell OpenManage Deployment Toolkit
- Server LCD panel

You can use the default iDRAC IP address 192.168.0.120 to configure the initial network settings, including setting up DHCP or a static IP for iDRAC.

 **NOTE:** To access iDRAC, ensure that you install the iDRAC port card or connect the network cable to the Ethernet connector 1 on the system board.

You can configure iDRAC IP address by using the following interfaces:

 **NOTE:** Make sure that you change the default user name and password after setting up the iDRAC IP address.

- iDRAC web interface — For more information, see the Integrated Dell Remote Access Controller User's Guide.
- Remote Access Controller Admin (RACADM) — For more information, see the RACADM Command Line Interface Reference Guide and the Integrated Dell Remote Access Controller User's Guide.
- Remote Services that include Web Services Management (WS-Man) — For more information, see the Dell Lifecycle Controller Remote Services Quick Start Guide.

For more information about setting up and configuring iDRAC, see the Integrated Dell Remote Access Controller User's Guide at Dell.com/idracmanuals.

Logging in to iDRAC

You can log in to iDRAC as an iDRAC local user, a Microsoft Active Directory user, or a Lightweight Directory Access Protocol (LDAP) user. You can also log in by using Single Sign-On or a Smart Card. The default user name is **root** and password is **calvin**. For more information about logging in to iDRAC and iDRAC licenses, see the Integrated Dell Remote Access Controller User's Guide at Dell.com/idracmanuals.

You can also access iDRAC by using RACADM. For more information, see the RACADM Command Line Interface Reference Guide and the Integrated Dell Remote Access Controller User's Guide available at Dell.com/idracmanuals.

Methods of installing the operating system

If the system is shipped without an operating system, install the supported operating system on the system by using one of the following methods:

- Dell Systems Management Tools and Documentation media — see the operating system documentation at Dell.com/operatingsystemmanuals.
- Dell Lifecycle Controller — see the Dell Lifecycle Controller documentation at Dell.com/idracmanuals.
- Dell OpenManage Deployment Toolkit — see the Dell OpenManage documentation at Dell.com/openmanagemanuals > **OpenManage software**.

For information on the list of operating systems supported on your system, see the operating system's support matrix at Dell.com/ossupport.

Managing your system remotely

To perform out-of-band systems management using iDRAC, you must configure iDRAC for remote accessibility, set up the management station and managed system, and configure the supported Web browsers. For more information, see the Integrated Dell Remote Access Controller User's Guide at Dell.com/idracmanuals.

You can also remotely monitor and manage the server by using the Dell OpenManage Server Administrator (OMSA) software and OpenManage Essentials (OME) systems management console. For more information, see Dell.com/openmanagemanuals > **OpenManage Server Administrator** or Dell.com/openmanagemanuals > **OpenManage Essentials**.

Downloading drivers and firmware

It is recommended that you download and install the latest BIOS, drivers, and systems management firmware on your system.

Prerequisites

Ensure that you clear the web browser cache.

Steps

1. Go to **Dell.com/support/drivers**.
2. In the **Product Selection** section, enter the Service Tag of your system in the **Service Tag or Express Service Code** field.
 **NOTE:** If you do not have the Service Tag, select **Automatically detect my Service Tag** for me to enable the system to automatically detect your service tag, or select your product from the **Product Selection** page.
3. Click **Get drivers and downloads**.
The drivers that are applicable to your selection are displayed.
4. Download the drivers that you need to a USB drive, CD, or DVD.

Pre-operating system management applications

The pre-operating system management applications for your system help you manage different settings and features without booting to the operating system.

Your system has the following pre-operating system management applications:

- System Setup
- Boot Manager
- Dell Lifecycle Controller
- Preboot Execution Environment (PXE)

Navigation keys

The navigation keys can help you quickly access the pre-operating system management applications.

| Key | Description |
|------------|--|
| F2 | Enables you to enter System Setup . |
| F10 | Enables you to enter system services and starts Lifecycle Controller . |
| F11 | Enables you to enter Boot Manager . |
| F12 | Enables you to enter PXE Boot . |
| Page Up | Enables you to move to the previous screen. |
| Page Down | Enables you to move to the next screen. |
| Up arrow | Enables you to move to the previous field. |
| Down arrow | Enables you to move to the next field. |
| Enter | Enables you to type a value in the selected field (if applicable). |
| Spacebar | Enables you to expand or collapse a drop-down list, if applicable. |
| Tab | Enables you to move to the next menu item. |
| |  NOTE: This feature is applicable only for the standard graphic browser. |
| Esc | Enables you to move to the previous page until you view the main screen. Pressing Esc in the main screen exits System BIOS, iDRAC Settings, Device Settings, or Service Tag Settings , and proceeds with system boot. |
| F1 | Displays the system setup help. |

About System Setup

By using the **System Setup** screen, you can configure the BIOS settings, iDRAC settings, and device settings of your system.

 **NOTE:** Help text for the selected field is displayed in the graphical browser by default. To view the help text in the text browser, press F1.

You can access system setup in two ways:

- Standard graphical browser — The browser is enabled by default.
- Text Browser — The browser is enabled by using Console Redirection.

Entering System Setup

1. Turn on, or restart your system.
2. Press F2 immediately after you see the following message:
F2 = System Setup

If your operating system begins to load before you press F2, wait for the system to finish booting, and then restart your system and try again.

System Setup Main Menu

The **System Setup Main Menu** screen details are explained as follows:

| Option | Description |
|------------------------|--|
| System BIOS | Enables you to configure BIOS settings. |
| iDRAC Settings | Enables you to configure iDRAC settings. The iDRAC settings utility is an interface to set up and configure the iDRAC parameters by using UEFI. You can enable or disable various iDRAC parameters by using the iDRAC settings utility. For more information about this utility, see <i>Integrated Dell Remote Access Controller User's Guide</i> at Dell.com/idracmanuals . |
| Device Settings | Enables you to configure device settings. |

System BIOS screen details

You can use the **System BIOS** screen to edit specific functions such as boot order, system password, setup password, set the RAID mode, and enable or disable USB ports.

To view the **System BIOS** screen, click **System Setup Main Menu** → **System BIOS**.

The **System BIOS** screen details are explained as follows:

| Option | Description |
|---------------------------|---|
| System Information | Displays information about the system such as the system model name, BIOS version, and Service Tag. |
| Memory Settings | Displays information and options related to the installed memory. |

| Option | Description |
|--------------------------------|---|
| Processor Settings | Displays information and options related to the processor such as speed, cache size. |
| SATA Settings | Displays options to enable or disable the integrated SATA controller and ports. |
| Boot Settings | Displays options to specify the boot mode (BIOS or UEFI). Enables you to modify UEFI and BIOS boot settings. |
| Network Settings | Displays options to change the network settings. |
| Integrated Devices | Displays options to manage integrated device controllers and ports and specify related features and options. |
| Serial Communication | Displays options to manage the serial ports and specify related features and options. |
| System Profile Settings | Displays options to change the processor power management settings, memory frequency, and so on. |
| System Security | Displays options to configure the system security settings, such as system password, setup password, Trusted Platform Module (TPM) security. It also manages the power and NMI buttons on the system. |
| Miscellaneous Settings | Displays options to change the system date, time, and so on. |

System Information screen details

You can use the **System Information** screen to view system properties such as Service Tag, system model name, and the BIOS version.

To view the **System Information** screen, click **System Setup Main Menu** → **System BIOS** → **System Information**.

The **System Information** screen details are explained as follows:

| Option | Description |
|--|---|
| System Model Name | Displays the system model name. |
| System BIOS Version | Displays the BIOS version installed on the system. |
| System Management Engine Version | Displays the current version of the Management Engine firmware. |
| System Service Tag | Displays the system Service Tag. |
| System Manufacturer | Displays the name of the system manufacturer. |
| System Manufacturer Contact Information | Displays the contact information of the system manufacturer. |
| System CPLD Version | Displays the current version of the system complex programmable logic device (CPLD) firmware. |

| Option | Description |
|--------------------------------|--|
| UEFI Compliance Version | Displays the UEFI compliance level of the system firmware. |

Memory Settings screen details

You can use the **Memory Settings** screen to view all the memory settings and enable or disable specific memory functions, such as system memory testing and node interleaving. To view the **Memory Setting** screen, click **System Setup Main Menu** → **System BIOS** → **Memory Settings**. The **Memory Settings** screen details are explained as follows:



| Option | Description |
|------------------------------|--|
| System Memory Size | Displays the amount of memory installed in the system. |
| System Memory Type | Displays the type of memory installed in the system. |
| System Memory Speed | Displays the system memory speed. |
| System Memory Voltage | Displays the system memory voltage. |
| Video Memory | Displays the amount of video memory. |
| System Memory Testing | Specifies whether the system memory tests are run during system boot. Options are Enabled and Disabled . This option is set to Disabled by default. |
| Memory Operating Mode | Specifies the memory operating mode. The available option is Optimizer Mode . |

Processor Settings screen details

You can use the **Processor Settings** screen to view the processor settings, and perform specific functions such as enabling virtualization technology, hardware prefetcher and logical processor idling. To view the **Processor Settings** screen, click **System Setup Main Menu** → **System BIOS** → **Processor Settings**.

The **Processor Settings** screen details are explained as follows:

| Option | Description |
|-------------------------------------|--|
| Logical Processor | Enables or disables the logical processors and displays the number of logical processors. If this option is set to Enabled , the BIOS displays all the logical processors. If this option is set to Disabled , the BIOS displays only one logical processor per core. This option is set to Enabled by default. |
| Virtualization Technology | Enables or disables the additional hardware capabilities provided for virtualization. This option is set to Enabled by default. |
| Adjacent Cache Line Prefetch | Optimizes the system for applications that require high utilization of sequential memory access. This option is set to Enabled by default. You can disable this option for applications that require high utilization of random memory access. |
| Hardware Prefetcher | Enables or disables the hardware prefetcher. This option is set to Enabled by default. |

| Option | Description | | | | | | | | | | |
|--------------------------------------|--|--------|-------------|--------------|--------------------------|----------------------|------------------------------|----------------------|------------------------------|------------------------|---|
| DCU Streamer Prefetcher | Enables or disables the Data Cache Unit (DCU) streamer prefetcher. This option is set to Enabled by default. | | | | | | | | | | |
| DCU IP Prefetcher | Enables or disables the Data Cache Unit (DCU) IP prefetcher. This option is set to Enabled by default. | | | | | | | | | | |
| Configurable TDP | Enables you to reconfigure the processor Thermal Design Power (TDP) levels during POST based on the power and thermal delivery capabilities of the system. TDP verifies the maximum heat the cooling system is required to dissipate. This option is set to Nominal by default.  NOTE: This option is only available on certain stock keeping units (SKUs) of the processors. | | | | | | | | | | |
| X2Apic Mode | Enables or disables the X2Apic mode. | | | | | | | | | | |
| Dell Controlled Turbo | Controls the turbo engagement. Enable this option only when System Profile is set to Performance .  NOTE: Depending on the number of installed CPUs, there may be up to four processor listings. | | | | | | | | | | |
| Number of Cores per Processor | Controls the number of enabled cores in each processor. This option is set to All by default. | | | | | | | | | | |
| Processor 64-bit Support | Specifies if the processor(s) support 64-bit extensions. | | | | | | | | | | |
| Processor Core Speed | Displays the maximum core frequency of the processor. | | | | | | | | | | |
| Processor 1 | The following settings are displayed for each processor installed in the system: <table border="1" data-bbox="478 1113 1197 1325"> <thead> <tr> <th>Option</th> <th>Description</th> </tr> </thead> <tbody> <tr> <td>Brand</td> <td>Displays the brand name.</td> </tr> <tr> <td>Level 2 Cache</td> <td>Displays the total L2 cache.</td> </tr> <tr> <td>Level 3 Cache</td> <td>Displays the total L3 cache.</td> </tr> <tr> <td>Number of Cores</td> <td>Displays the number of cores per processor.</td> </tr> </tbody> </table> | Option | Description | Brand | Displays the brand name. | Level 2 Cache | Displays the total L2 cache. | Level 3 Cache | Displays the total L3 cache. | Number of Cores | Displays the number of cores per processor. |
| Option | Description | | | | | | | | | | |
| Brand | Displays the brand name. | | | | | | | | | | |
| Level 2 Cache | Displays the total L2 cache. | | | | | | | | | | |
| Level 3 Cache | Displays the total L3 cache. | | | | | | | | | | |
| Number of Cores | Displays the number of cores per processor. | | | | | | | | | | |

SATA Settings screen details

You can use the **SATA Settings** screen to view the SATA settings of SATA devices and enable RAID on your system.

To view the **SATA Settings** screen, click **System Setup Main Menu** → **System BIOS** → **SATA Settings**.

The **SATA Settings** screen details are explained as follows:

| Option | Description |
|-----------------------------|--|
| Embedded SATA | Enables the embedded SATA option to be set to Off , AHCI , or RAID modes. This option is set to AHCI by default. |
| Security Freeze Lock | Sends Security Freeze Lock command to the Embedded SATA drives during POST. This option is applicable only for AHCI mode. |

| Option | Description |
|--------------------|---|
| Write Cache | Enables or disables the command for Embedded SATA drives during POST. |
| Port A | For AHCI or RAID mode, BIOS support is always enabled. |

| Option | Description |
|-------------------|--|
| Model | Displays the drive model of the selected device. |
| Drive Type | Displays the type of drive attached to the SATA port. |
| Capacity | Displays the total capacity of the hard drive. This field is undefined for removable media devices such as optical drives. |

Port B For **AHCI** or **RAID** mode, BIOS support is always enabled.

| Option | Description |
|-------------------|--|
| Model | Displays the drive model of the selected device. |
| Drive Type | Displays the type of drive attached to the SATA port. |
| Capacity | Displays the total capacity of the hard drive. This field is undefined for removable media devices such as optical drives. |

Port C For **AHCI** or **RAID** mode, BIOS support is always enabled.

| Option | Description |
|-------------------|--|
| Model | Displays the drive model of the selected device. |
| Drive Type | Displays the type of drive attached to the SATA port. |
| Capacity | Displays the total capacity of the hard drive. This field is undefined for removable media devices such as optical drives. |

Port D For **AHCI** or **RAID** mode, BIOS support is always enabled.

| Option | Description |
|-------------------|--|
| Model | Displays the drive model of the selected device. |
| Drive Type | Displays the type of drive attached to the SATA port. |
| Capacity | Displays the total capacity of the hard drive. This field is undefined for removable media devices such as optical drives. |

Port E For **AHCI** or **RAID** mode, BIOS support is always enabled.

| Option | Description |
|--------------|--|
| Model | Displays the drive model of the selected device. |

| Option | Description |
|-------------------|--|
| Option | Description |
| Drive Type | Displays the type of drive attached to the SATA port. |
| Capacity | Displays the total capacity of the hard drive. This field is undefined for removable media devices such as optical drives. |

Port F For **AHCI** or **RAID** mode, BIOS support is always enabled.

| Option | Description |
|-------------------|--|
| Model | Displays the drive model of the selected device. |
| Drive Type | Displays the type of drive attached to the SATA port. |
| Capacity | Displays the total capacity of the hard drive. This field is undefined for removable media devices such as optical drives. |

Boot Settings screen details

You can use the **Boot Settings** screen to set the boot mode to either **BIOS** or **UEFI**. It also enables you to specify the boot order.

To view the **Boot Settings** screen, click **System Setup Main Menu** → **System BIOS** → **Boot Settings**.

The **Boot Settings** screen details are explained as follows:

| Option | Description |
|-----------------------------|---|
| Boot Mode | <p>Enables you to set the boot mode of the system. Setting this field to UEFI disables the BIOS Boot Settings menu. Setting this field to BIOS disables the UEFI Boot Settings menu.</p> <p> CAUTION: Switching the boot mode may prevent the system from booting if the operating system is not installed in the same boot mode.</p> <p>If the operating system supports UEFI, you can set this option to UEFI. Setting this field to BIOS allows compatibility with non-UEFI operating systems. This option is set to BIOS by default.</p> |
| Boot Sequence Retry | Enables or disables the Boot Sequence Retry feature. If this field is enabled and the system fails to boot, the system reattempts the boot sequence after 30 seconds. This option is set to Enabled by default. |
| Hard-Disk Failover | Specifies the hard drive that is booted in the event of a hard drive failure. The devices are selected in the Hard-Disk Drive Sequence on the Boot Option Setting menu. When this option is set to Disabled , only the first hard drive in the list is attempted to boot. When this option is set to Enabled , all hard drives are attempted to boot in the order selected in the Hard-Disk Drive Sequence . This option is not enabled for UEFI Boot Mode. |
| Boot Option Settings | Configures the boot sequence and the boot devices. |

Network Settings screen details

You can use the **Network Settings** screen to modify PXE device settings. The network settings option is available only in the UEFI boot mode. BIOS does not control network settings in the BIOS boot mode. For BIOS boot mode, the option ROM of the network controllers handles the network settings. To view the **Network Settings** screen, click **System Setup Main Menu** → **System BIOS** → **Network Settings**.

The **Network Settings** screen details are explained as follows:

| Option | Description |
|---|---|
| PXE Device n (n = 1 to 4) | Enables or disables the device. When enabled, a UEFI boot option is created for the device. |
| PXE Device n Settings (n = 1 to 4) | Enables you to control the configuration of the PXE device. |

UEFI iSCSI Settings screen details

You can use the iSCSI Settings screen to modify iSCSI device settings. The iSCSI Settings option is available only in the UEFI boot mode. BIOS does not control network settings in the BIOS boot mode. For BIOS boot mode, the option ROM of the network controller handles the network settings.

To view the **UEFI iSCSI Settings** screen, click **System Setup Main Menu** → **System BIOS** → **Network Settings** → **UEFI iSCSI Settings**.

The **UEFI iSCSI Settings** screen details are explained as follows:

| Option | Description |
|------------------------------------|--|
| iSCSI Initiator Name | Specifies the name of the iSCSI initiator (iqn format). |
| iSCSI Device n (n = 1 to 4) | Enables or disables the iSCSI device. When disabled, a UEFI boot option is created for the iSCSI device automatically. |

Integrated Devices screen details

You can use the **Integrated Devices** screen to view and configure the settings of all integrated devices including the video controller, integrated RAID controller, and the USB ports.

To view the **Integrated Devices** screen, click **System Setup Main Menu** → **System BIOS** → **Integrated Devices**.

The **Integrated Devices** screen details are explained as follows:

| Option | Description |
|----------------------------------|---|
| User Accessible USB Ports | Enables or disables the USB ports. Selecting Only Back Ports On disables the front USB ports, selecting All Ports Off disables all USB ports. The USB keyboard and mouse operates during boot process in certain operating systems. After the boot process is complete, the USB keyboard and mouse do not work if the ports are disabled. |



NOTE: Selecting **Only Back Ports On** and **All Ports Off** disables the USB management port and also restricts access to iDRAC features.



| Option | Description |
|---|---|
| Internal USB Port | Enables or disables the internal USB port. This option is set to Enabled by default. |
| Integrated Network Card 1 | Enables or disables the integrated network card. |
| Embedded NIC1 and NIC2 |  NOTE: The Embedded NIC1 and NIC2 options are only available on systems that do not have Integrated Network Card 1 . Enables or disables the Embedded NIC1 and NIC2 options. If set to Disabled , the NIC may still be available for shared network access by the embedded management controller. The embedded NIC1 and NIC2 options are only available on systems that do not have Network Daughter Cards (NDCs). This option is mutually exclusive with the Integrated Network Card 1 option. Configure this function by using the NIC management utilities of the system. |
| Embedded Video Controller | Allows you to enable or disable the Embedded Video Controller option. This option is set to Enabled by default. |
| Current State of Embedded Video Controller | Displays the current state of the embedded video controller. The Current State of Embedded Video Controller option is a read-only field. If the Embedded Video Controller is the only display capability in the system (that is, no add-in graphics card is installed), then the Embedded Video Controller is automatically used as the primary display even if the Embedded Video Controller setting is set to Disabled . |
| OS Watchdog Timer | If your system stops responding, this watchdog timer aids in the recovery of your operating system. When this option is set to Enabled , the operating system initializes the timer. When this option is set to Disabled (the default), the timer does not have any effect on the system. |
| Memory Mapped I/O above 4 GB | Enables or disables the support for PCIe devices that require large amounts of memory. This option is set to Enabled by default. |
| Slot Disablement | Enables or disables the available PCIe slots on your system. The slot disablement feature controls the configuration of PCIe cards installed in the specified slot. Slot disablement must be used only when the installed peripheral card prevents booting into the operating system or causes delays in system startup. If the slot is disabled, both the Option ROM and UEFI drivers are disabled. |

Serial Communication screen details

You can use the **Serial Communication** screen to view the properties of the serial communication port. To view the **Serial Communication** screen, click **System Setup Main Menu** → **System BIOS** → **Serial Communication**.

The **Serial Communication** screen details are explained as follows:

| Option | Description |
|-----------------------------|---|
| Serial Communication | Selects serial communication devices (Serial Device 1 and Serial Device 2) in BIOS. BIOS console redirection can also be enabled and the port address can be specified. This option is set to Auto by default. |
| Serial Port Address | Enables you to set the port address for serial devices. This option is set to Serial Device 1=COM2, Serial Device 2=COM1 by default.  NOTE: You can use only Serial Device 2 for the Serial Over LAN (SOL) feature. To use console redirection by SOL, configure the same port address for console redirection and the serial device. |

| Option | Description |
|----------------------------------|---|
| |  NOTE: Every time the system boots, the BIOS syncs the serial MUX setting saved in iDRAC. The serial MUX setting can independently be changed in iDRAC. Loading the BIOS default settings from within the BIOS setup utility may not always revert the serial MUX setting to the default setting of Serial Device 1. |
| External Serial Connector | <p>Enables you to associate the External Serial Connector to Serial Device 1, Serial Device 2, or the Remote Access Device by using this field.</p>  NOTE: Only Serial Device 2 can be used for Serial Over LAN (SOL). To use console redirection by SOL, configure the same port address for console redirection and the serial device.  NOTE: Every time the system boots, the BIOS syncs the serial MUX setting saved in iDRAC. The serial MUX setting can independently be changed in iDRAC. Loading the BIOS default settings from within the BIOS setup utility may not always revert this setting to the default setting of Serial Device 1. |
| Failsafe Baud Rate | Displays the failsafe baud rate for console redirection. The BIOS attempts to determine the baud rate automatically. This failsafe baud rate is used only if the attempt fails, and the value must not be changed. This option is set to 115200 by default. |
| Remote Terminal Type | Sets the remote console terminal type. This option is set to VT 100/VT 220 by default. |
| Redirection After Boot | Enables or disables the BIOS console redirection when the operating system is loaded. This option is set to Enabled by default. |



System Profile Settings screen details

You can use the **System Profile Settings** screen to enable specific system performance settings such as power management.

To view the **System Profile Settings** screen, click **System Setup Main Menu** → **System BIOS** → **System Profile Settings**.

The **System Profile Settings** screen details are explained as follows:

| Option | Description |
|-----------------------------|---|
| System Profile | <p>Sets the system profile. If you set the System Profile option to a mode other than Custom, the BIOS automatically sets the rest of the options. You can only change the rest of the options if the mode is set to Custom. This option is set to Performance Per Watt (OS).</p>  NOTE: All the parameters on the system profile setting screen available only when the System Profile option is set to Custom . |
| CPU Power Management | Sets the CPU power management. This option is set to OS DBPM by default. DBPM is Demand-Based Power Management. |
| Memory Frequency | Sets the speed of the system memory. You can select Maximum Performance , Maximum Reliability , or a specific speed. |
| Turbo Boost | Enables or disables the processor to operate in turbo boost mode. This option is set to Enabled by default. |



| Option | Description |
|---|---|
| C1E | Enables or disables the processor to switch to a minimum performance state when it is idle. This option is set to Enabled by default. |
| C States | Enables or disables the processor to operate in all available power states. This option is set to Enabled by default. |
| Memory Refresh Rate | Sets the memory refresh rate to either 1x or 2x. This option is set to 1x by default. |
| Uncore Frequency | Enables you to select the Processor Uncore Frequency . Dynamic mode enables the processor to optimize power resources across the cores and uncore during runtime. The optimization of the uncore frequency to either save power or optimize performance is influenced by the setting of the Energy Efficiency Policy . |
| Energy Efficient Policy | Enables you to select the Energy Efficient Policy . The CPU uses the setting to manipulate the internal behavior of the processor and determines whether to target higher performance or better power savings. |
| Number of Turbo Boot Enabled Cores for Processor 1 | Controls the number of turbo boost enabled cores for processor 1. The maximum number of cores is enabled by default. |
| Monitor/Mwait | Enables the Monitor/Mwait instructions in the processor. This option is set to Enabled for all system profiles, except Custom by default.  NOTE: This option can be disabled only if the C States option in the Custom mode is set to disabled .  NOTE: When C States is set to Enabled in the Custom mode, changing the Monitor/Mwait setting does not impact the system power or performance. |

System Security Settings screen details

You can use the **System Security** screen to perform specific functions such as setting the system password, setup password and disabling the power button. To view the **System Security** screen, click **System Setup Main Menu** → **System BIOS** → **System Security Settings**.

The **System Security Settings** screen details are explained as follows:

| Option | Description |
|------------------------|--|
| Intel AES-NI | Improves the speed of applications by performing encryption and decryption by using the Advanced Encryption Standard Instruction Set (AES-NI) and is set to Enabled by default. |
| System Password | Sets the system password. This option is set to Enabled by default and is read-only if the password jumper is not installed in the system. |
| Setup Password | Sets the setup password. This option is read-only if the password jumper is not installed in the system. |
| Password Status | Locks the system password. This option is set to Unlocked by default. |

| Option | Description |
|---|---|
| TPM Security |  NOTE: The TPM menu is available only when the TPM module is installed. Enables you to control the reporting mode of the TPM. The TPM Security option is set to Off by default. You can only modify the TPM Status, TPM Activation, and Intel TXT fields if the TPM Status field is set to either On with Pre-boot Measurements or On without Pre-boot Measurements . |
| TPM Information | Changes the operational state of the TPM. This option is set to No Change by default. |
| TPM Status | Displays the TPM status. |
| TPM Command |  CAUTION: Clearing the TPM results in the loss of all keys in the TPM. The loss of TPM keys may affect booting to the operating system. Clears all the contents of the TPM. The TPM Clear option is set to No by default. |
| Intel TXT | Enables or disables the Intel Trusted Execution Technology (TXT) option. To enable the Intel TXT option, virtualization technology and TPM Security must be enabled with Pre-boot measurements. This option is set to Off by default. |
| Power Button | Enables or disables the power button on the front of the system. This option is set to Enabled by default. |
| NMI Button | Enables or disables the NMI button on the front of the system. This option is set to Disabled by default. |
| AC Power Recovery | Sets how the system behaves after AC power is restored to the system. This option is set to Last by default. |
| AC Power Recovery Delay | Sets the time delay for system power up after AC power is restored to the system. This option is set to Immediate by default. |
| User Defined Delay (60s to 240s) | Sets the User Defined Delay option when the User Defined option for AC Power Recovery Delay is selected. |
| UEFI Variable Access | Provides varying degrees of securing UEFI variables. When set to Standard (the default), UEFI variables are accessible in the operating system per the UEFI specification. When set to Controlled , selected UEFI variables are protected in the environment and new UEFI boot entries are forced to be at the end of the current boot order. |
| Secure Boot | Enables Secure Boot, where the BIOS authenticates each pre-boot image by using the certificates in the Secure Boot Policy. Secure Boot is disabled by default. |
| Secure Boot Policy | When Secure Boot policy is set to Standard , the BIOS uses the system manufacturer's key and certificates to authenticate pre-boot images. When Secure Boot policy is set to Custom , the BIOS uses the user-defined key and certificates. Secure Boot policy is set to Standard by default. |
| Secure Boot Policy Summary | Displays the list of certificates and hashes that secure boot uses to authenticate images. |

Secure Boot Custom Policy Settings screen details

Secure Boot Custom Policy Settings is displayed only when the **Secure Boot Policy** option is set to **Custom**.

To view the **Secure Boot Custom Policy Settings** screen, click **System Setup Main Menu** → **System BIOS** → **System Security** → **Secure Boot Custom Policy Settings**.

The **Secure Boot Custom Policy Settings** screen details are explained as follows:

| Option | Description |
|--------------------------------------|---|
| Platform Key | Imports, exports, deletes, or restores the platform key (PK). |
| Key Exchange Key Database | Enables you to import, export, delete, or restore entries in the Key Exchange Key (KEK) Database. |
| Authorized Signature Database | Imports, exports, deletes, or restores entries in the Authorized Signature Database (db). |
| Forbidden Signature Database | Imports, exports, deletes, or restores entries in the Forbidden Signature Database (dbx). |

Miscellaneous Settings screen details

You can use the **Miscellaneous Settings** screen to perform specific functions such as updating the asset tag and changing the system date and time.

To view the **Miscellaneous Settings** screen, click **System Setup Main Menu** → **System BIOS** → **Miscellaneous Settings**.

The **Miscellaneous Settings** screen details are explained as follows:

| Option | Description |
|-------------------------------------|---|
| System Time | Enables you to set the time on the system. |
| System Date | Enables you to set the date on the system. |
| Asset Tag | Displays the asset tag and enables you to modify it for security and tracking purposes. |
| Keyboard NumLock | Enables you to set whether the system boots with the NumLock enabled or disabled. This option is set to On by default.  NOTE: This option does not apply to 84-key keyboards. |
| F1/F2 Prompt on Error | Enables or disables the F1/F2 prompt on error. This option is set to Enabled by default. The F1/F2 prompt also includes keyboard errors. |
| Load Legacy Video Option ROM | Enables you to determine whether the system BIOS loads the legacy video (INT 10H) option ROM from the video controller. Selecting Enabled in the operating system does not support UEFI video output standards. This field is available only for UEFI boot mode. You cannot set the option to Enabled if UEFI Secure Boot mode is enabled. |

About Boot Manager

Boot manager enables you to add, delete, and arrange boot options. You can also access System Setup and boot options without restarting the system.

Entering Boot Manager

The boot manager screen enables you to select boot options and diagnostic utilities.

1. Turn on, or restart your system.
2. Press F11 when you see the message `F11 = Boot Manager`.
If your operating system begins to load before you press F11, allow the system to complete the booting, and then restart your system and try again.

Boot Manager main menu

| Menu item | Description |
|------------------------------------|---|
| Continue Normal Boot | The system attempts to boot to devices starting with the first item in the boot order. If the boot attempt fails, the system continues with the next item in the boot order until the boot is successful or no more boot options are found. |
| One Shot Boot Menu | Takes you to the boot menu, where you can select a one time boot device to boot from. |
| Launch System Setup | Enables you to access System Setup. |
| Launch Lifecycle Controller | Exits the Boot Manager and invokes the Dell Lifecycle Controller program. |
| System Utilities | Launches System Utilities menu such as System Diagnostics and UEFI shell. |

About Dell Lifecycle Controller

Dell Lifecycle Controller enables you to perform tasks such as configuring BIOS and hardware settings, deploying an operating system, updating drivers, changing RAID settings, and saving hardware profiles. For more information about Dell Lifecycle Controller, see the documentation at Dell.com/idracmanuals.

Changing the boot order

You may have to change the boot order if you want to boot from a USB key or an optical drive. The following instructions may vary if you have selected **BIOS** for **Boot Mode**.

1. On the **System Setup Main Menu** screen, click **System BIOS** → **Boot Settings**.
2. Click **Boot Option Settings** → **Boot Sequence**.
3. Use the arrow keys to select a boot device, and use the plus (+) and minus (-) sign keys to move the device down or up in the order.
4. Click **Exit**, and then click **Yes** to save the settings on exit.

Choosing the system boot mode

System Setup enables you to specify one of the following boot modes for installing your operating system:

- BIOS boot mode (the default) is the standard BIOS-level boot interface.
 - Unified Extensible Firmware Interface (UEFI) boot mode is an enhanced 64-bit boot interface. If you have configured your system to boot to UEFI mode, it overlays the system BIOS.
1. From the **System Setup Main Menu**, click **Boot Settings** and select **Boot Mode**.
 2. Select the boot mode you want the system to boot into.

 **CAUTION: Switching the boot mode may prevent the system from booting if the operating system is not installed in the same boot mode.**

3. After the system boots in the specified boot mode, proceed to install your operating system from that mode.

 **NOTE:** Operating systems must be UEFI-compatible to be installed from the UEFI boot mode. DOS and 32-bit operating systems do not support UEFI and can only be installed from the BIOS boot mode.

 **NOTE:** For the latest information about supported operating systems, go to Dell.com/ossupport.

Creating a system and setup password

Prerequisites

Ensure that the password jumper is enabled. For more information, see System board jumper settings.

Ensure that the **Password Status** is set to **Unlocked**. For more information, see System Security Settings screen.

 **NOTE:** The password jumper enables or disables the system password and setup password features. For more information about the password jumper settings, see [System board jumper settings](#).

Steps

1. To enter System Setup, press F2 immediately after turning on or rebooting your system.
2. On the **System Setup Main Menu** screen, click **System BIOS** → **System Security**.
3. On the **System Security** screen, verify that **Password Status** is set to **Unlocked**.
4. In the **System Password** field, type your system password, and press Enter or Tab.

Use the following guidelines to assign the system password:

- A password can have up to 32 characters.
- The password can contain the numbers 0 through 9.
- Only the following special characters are allowed: space, ("), (+), (.), (-), (,), (/), (;), (I), (\), (l), (').

A message prompts you to reenter the system password.

5. Reenter the system password, and click **OK**.
6. In the **Setup Password** field, type your setup password and press Enter or Tab.
A message prompts you to reenter the setup password.
7. Reenter the setup password, and click **OK**.

8. Press Esc to return to the System BIOS screen. Press Esc again.
A message prompts you to save the changes.

 **NOTE:** Password protection does not take effect until the system reboots.

Using your system password to secure your system

About this task

If you have assigned a setup password, the system accepts your setup password as an alternate system password.

Steps

1. Turn on or reboot your system.
2. Type your system password and press Enter.

Next steps

When **Password Status** is set to **Locked**, type the password and press Enter when prompted at reboot.

 **NOTE:** If an incorrect system password is typed, the system displays a message and prompts you to reenter your password. You have three attempts to type the correct password. After the third unsuccessful attempt, the system displays an error message that the system stops functioning and must be turned off.

Even after you turn off and restart the system, the error message is displayed until the correct password is entered.

Deleting or changing system password and setup password

Prerequisites

Ensure that the password jumper is **Enabled** and the **Password Status** is set to **Unlocked** before attempting to delete or change the existing system or setup password.

 **NOTE:** You cannot delete or change an existing system or setup password if the **Password Status** is set to **Locked**.

Steps

1. To enter System Setup, press F2 immediately after a turning on or restarting your system.
2. On the **System Setup Main Menu** screen, click **System BIOS** → **System Security**.
3. On the **System Security** screen, verify that **Password Status** is set to **Unlocked**.
4. In the **System Password** field, alter or delete the existing system password, and then press Enter or Tab.
5. In the **Setup Password** field, alter or delete the existing setup password, and then press Enter or Tab.
If you change the system and setup password a message prompts you to reenter the new password.
If you delete the system and setup password, a message prompts you to confirm the deletion.
6. Press Esc to return to the **System BIOS** screen. Press Esc again, and a message prompts you to save the changes.
7. Select **Setup Password**, change or delete the existing setup password and press **Enter** or **Tab**.

 **NOTE:** If you change the system password or setup password, a message prompts you to reenter the new password. If you delete the system password or setup password, a message prompts you to confirm the deletion.

Operating with a setup password enabled

If **Setup Password** is set to **Enabled**, type the correct setup password before modifying the system setup options.

If you do not type the correct password in three attempts, the system displays the following message:

```
Invalid Password! Number of unsuccessful password attempts: <x> System Halted!  
Must power down.
```

Even after you turn off and restart the system, the error message is displayed until the correct password is typed. The following options are exceptions:

- If **System Password** is not set to **Enabled** and is not locked through the **Password Status** option, you can assign a system password. For more information, see System Security Settings screen.
- You cannot disable or change an existing system password.

 **NOTE:** You can use the password status option with the setup password option to protect the system password from unauthorized changes.

Embedded system management

The Dell Lifecycle Controller provides advanced embedded systems management throughout the server's lifecycle. The Dell Lifecycle Controller can be started during the boot sequence and can function independently of the operating system.

 **NOTE:** Certain platform configurations may not support the full set of features provided by the Dell Lifecycle Controller.

For more information about setting up the Dell Lifecycle Controller, configuring hardware and firmware, and deploying the operating system, see the Dell Lifecycle Controller documentation at Dell.com/idracmanuals.

iDRAC Settings utility

The iDRAC settings utility is an interface to set up and configure the iDRAC parameters by using UEFI. You can enable or disable various iDRAC parameters by using the iDRAC settings utility.

 **NOTE:** Accessing some of the features on the iDRAC settings utility requires the iDRAC Enterprise License upgrade.

For more information about using iDRAC, see *iDRAC User's Guide* at Dell.com/idracmanuals.

Entering the iDRAC settings utility

1. Turn on or restart the managed system.
2. Press F2 during Power-on Self-test (POST).
3. On the **System Setup Main Menu** page, click **iDRAC Settings**.
The **iDRAC Settings** screen is displayed.







Changing the thermal settings

The iDRAC settings utility enables you to select and customize the thermal control settings for your system.

1. Click **iDRAC Settings** → **Thermal**.
2. Under **SYSTEM THERMAL PROFILE** → **Thermal Profile**, select one of the following options:
 - Default Thermal Profile Settings
 - Maximum Performance (Performance Optimized)
 - Minimum Power (Performance per Watt Optimized)
3. Under **USER COOLING OPTIONS**, set the **Fan Speed Offset**, **Minimum Fan Speed**, and **Custom Minimum Fan Speed**.
4. Click **Back** → **Finish** → **Yes**.

Installing and removing system components

Safety instructions

-  **WARNING:** Whenever you need to lift the system, get others to assist you. To avoid injury, do not attempt to lift the system by yourself.
-  **WARNING:** Opening or removing the system cover while the system is powered on may expose you to a risk of electric shock.
-  **CAUTION:** Do not operate the system without the cover for a duration exceeding five minutes.
-  **CAUTION:** Many repairs may only be done by a certified service technician. You should only perform troubleshooting and simple repairs as authorized in your product documentation, or as directed by the online or telephone service and support team. Damage due to servicing that is not authorized by Dell is not covered by your warranty. Read and follow the safety instructions that came with the product.
-  **NOTE:** Dell recommends that you always use a static mat and static strap while working on components inside the system.
-  **NOTE:** To ensure proper operation and cooling, all bays in the system must be populated always with either a component or with a blank.

Before working inside your system

1. Ensure that you follow the [Safety instructions](#).
2. Turn off the system, including any attached peripherals.
3. Disconnect the system from the electrical outlet and disconnect the peripherals.
4. If applicable, remove the system from the rack. For more information, see the *Rack Installation* placemat at Dell.com/poweredgemanuals.
5. If installed, remove the front bezel.
6. Remove the system cover.

Related Tasks

[Removing the optional front bezel](#)

[Removing the system cover](#)

After working inside your system

1. Install the system cover.
2. If applicable, install the front bezel.

3. If applicable, install the system into the rack. For more information, see the *Rack Installation* placemat at Dell.com/poweredgemanuals.
4. Reconnect the peripherals and connect the system to the electrical outlet.
5. Turn on the system, including any attached peripherals.

Related Tasks

[Installing the optional front bezel](#)

[Installing the system cover](#)

Recommended tools

You need the following tools to perform the installation and removal procedures:

- Phillips #2 screwdriver
- Plastic scribe
- Wrist grounding strap connected to ground

Front bezel (optional)

Installing the optional front bezel

1. Locate and remove the bezel key.
 **NOTE:** The bezel key is attached to the back of the bezel.
2. Hook the right end of the bezel onto the chassis.
3. Fit the free end of the bezel onto the system.
4. Lock the bezel.

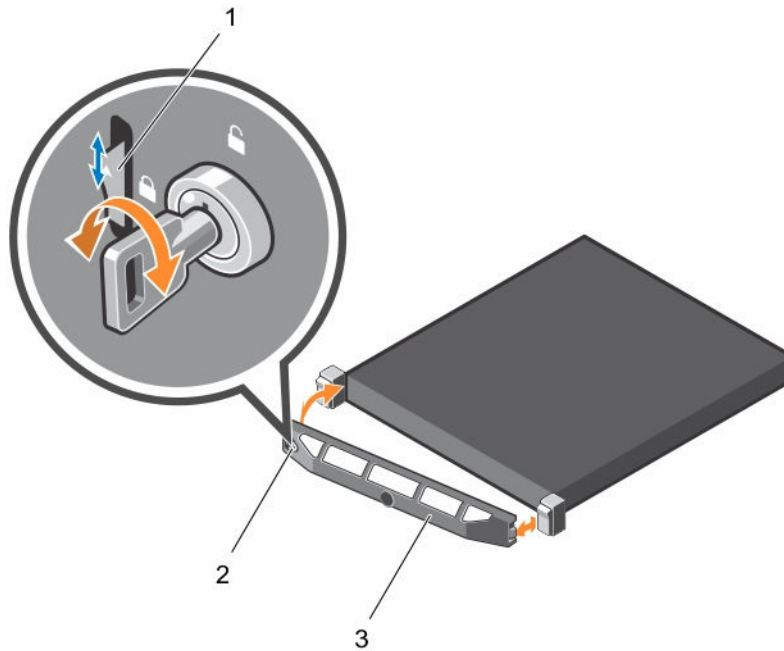

Figure 9. Removing and installing the optional front bezel

- | | |
|------------------|------------|
| 1. release latch | 2. keylock |
| 3. front bezel | |

Removing the optional front bezel

1. Unlock the keylock at the left end of the bezel.
2. Lift the release latch next to the keylock.
3. Rotate the left end of the bezel away from the front panel.
4. Unhook the right end of the bezel and pull the bezel away from the system.

System cover

Removing the system cover

Prerequisites

1. Ensure that you follow the [Safety instructions](#).
2. Turn off the system, including any attached peripherals.
3. Disconnect the system from the electrical outlet and peripherals.
4. If installed, remove the front bezel.

Steps

1. Turn the latch release lock to the unlock position.
2. Lift the latch and rotate the latch toward the back of the system.

The system cover slides back, disengaging the tabs on the system cover from the slots on the chassis.

3. Hold the cover on both sides, and lift the cover away from the system.

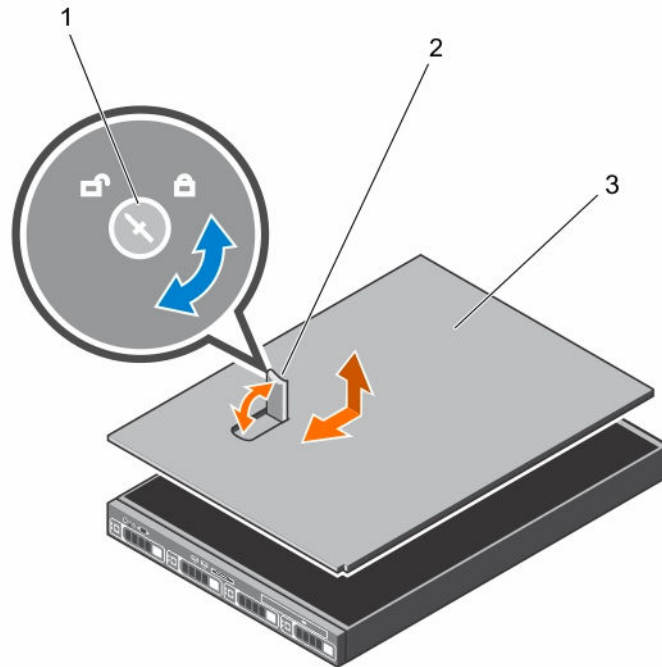

Figure 10. Removing and installing the system cover

1. latch release lock
2. latch
3. system cover

Next steps

Install the system cover.

Related Tasks

[Removing the optional front bezel](#)

[Installing the system cover](#)

Installing the system cover

Prerequisites

Ensure that you follow the [Safety instructions](#).

Steps

1. Align the slots of the system cover with the tabs on the chassis.
2. Push the system cover latch down to move the system cover into the closed position.
The system cover slides forward and the tabs on the system cover engage with the slots on the chassis. The system cover latch locks into place when the system cover engages with the slots on the chassis.
3. Turn the cover latch release lock clockwise to the locked position.

Next steps

1. If removed, install the bezel.
2. Reconnect the system to the electrical outlet.
3. Turn on the system, including any attached peripherals.

Related Tasks

[Installing the optional front bezel](#)

Inside the system

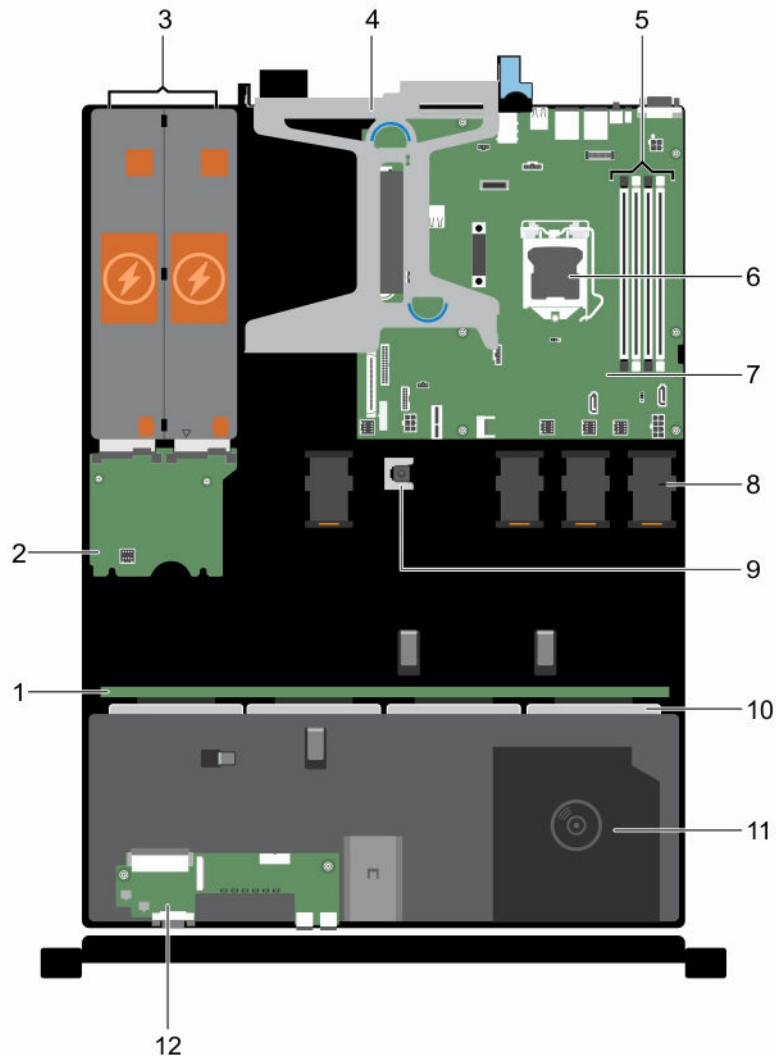

Figure 11. Inside the system—with four 3.5-inch hot swappable hard drives

- | | |
|--------------------------|---------------------------|
| 1. hard drive backplane | 2. power interposer board |
| 3. power supply unit (2) | 4. expansion card riser |

- 5. memory module sockets
- 7. system board
- 9. intrusion switch
- 11. optical drive (optional)
- 6. processor
- 8. cooling fan (4)
- 10. hard drives
- 12. control panel assembly

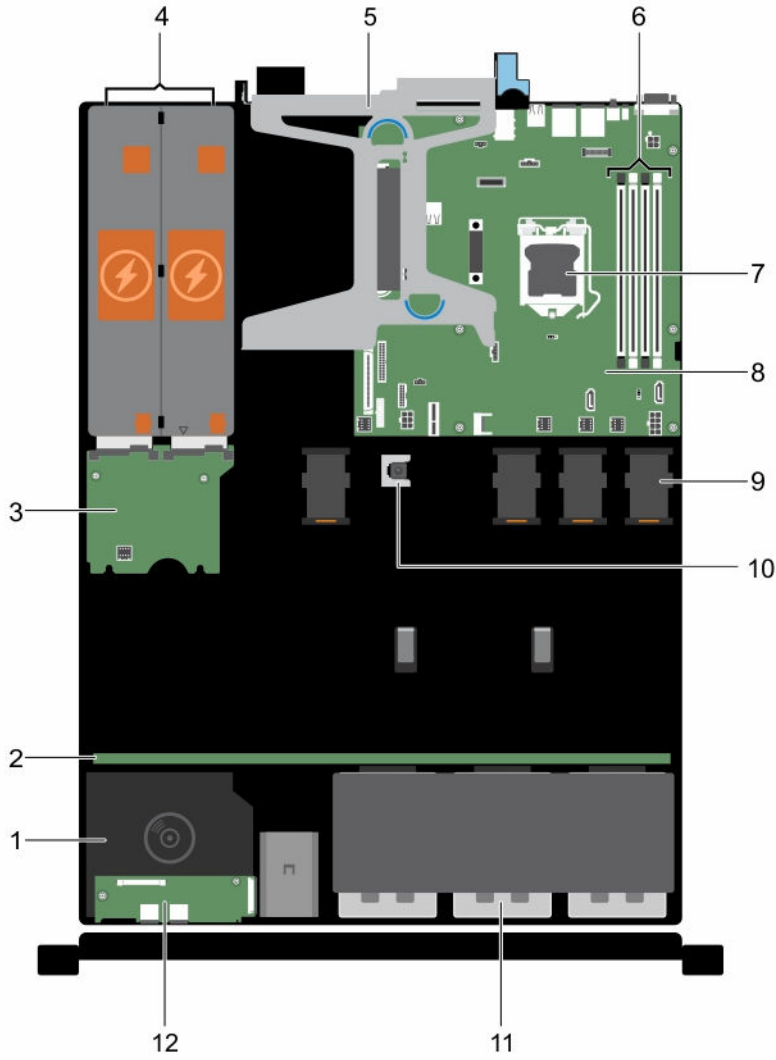

Figure 12. Inside the system—with eight 2.5-inch hard drives

- 1. optical drive (optional)
- 2. hard drive backplane
- 3. power interposer board
- 4. power supply unit (2)
- 5. expansion card riser
- 6. memory module socket (4)
- 7. processor
- 8. system board
- 9. cooling fan (4)
- 10. intrusion switch
- 11. hard drive (8)
- 12. control panel assembly

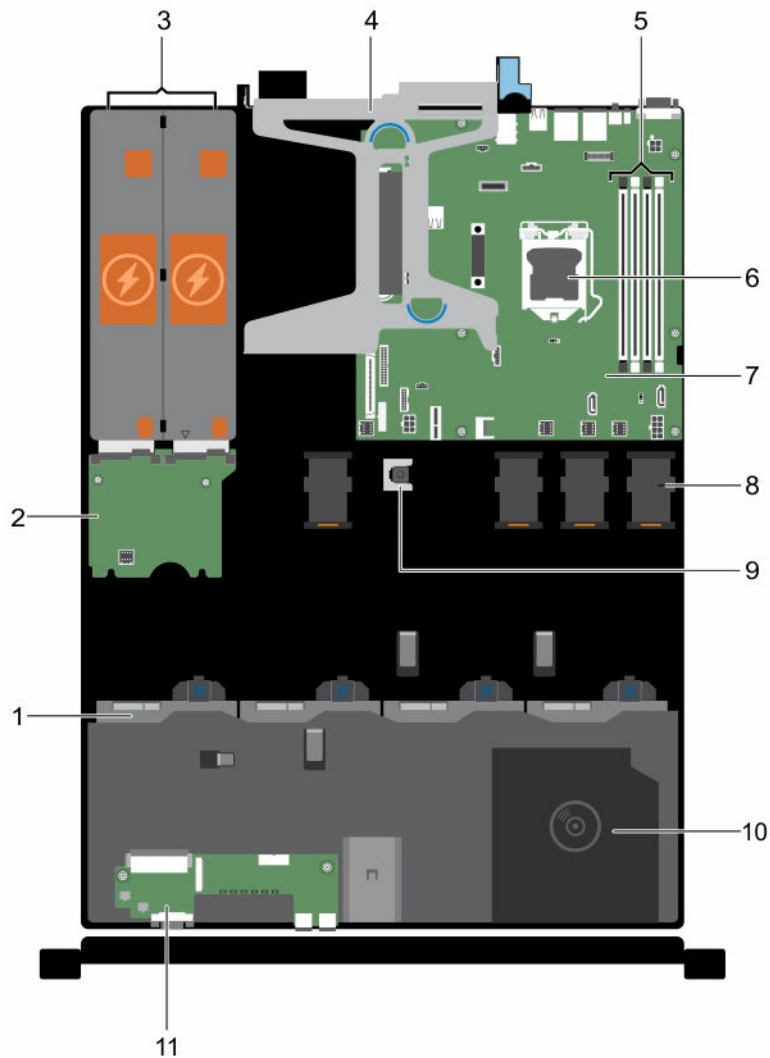

Figure 13. Inside the system—with four 3.5-inch cabled hard drives

- | | | | |
|-----|--------------------------|-----|--|
| 1. | hard drive (4) | 2. | power interposer board |
| 3. | power supply unit (2) | 4. | expansion card riser |
| 5. | memory module socket (4) | 6. | processor |
| 7. | system board | 8. | cooling fan (4) |
| 9. | intrusion switch | 10. | optional optical drive or 1.8-inch solid state drives (optional) |
| 11. | control panel assembly | | |

Intrusion switch

Removing the intrusion switch

Prerequisites

△ CAUTION: Many repairs may only be done by a certified service technician. You should only perform troubleshooting and simple repairs as authorized in your product documentation, or as directed by the online or telephone service and support team. Damage due to servicing that is not authorized by Dell is not covered by your warranty. Read and follow the safety instructions that came with the product.

1. Ensure that you follow the [Safety instructions](#).
2. Follow the procedure listed in [Before working inside your system](#).

Steps

1. Disconnect the intrusion switch cable from the connector on the system board.
2. Remove the cable from the cable routing latch.
3. Using a plastic scribe, slide the intrusion switch and remove it from under the intrusion switch slot.

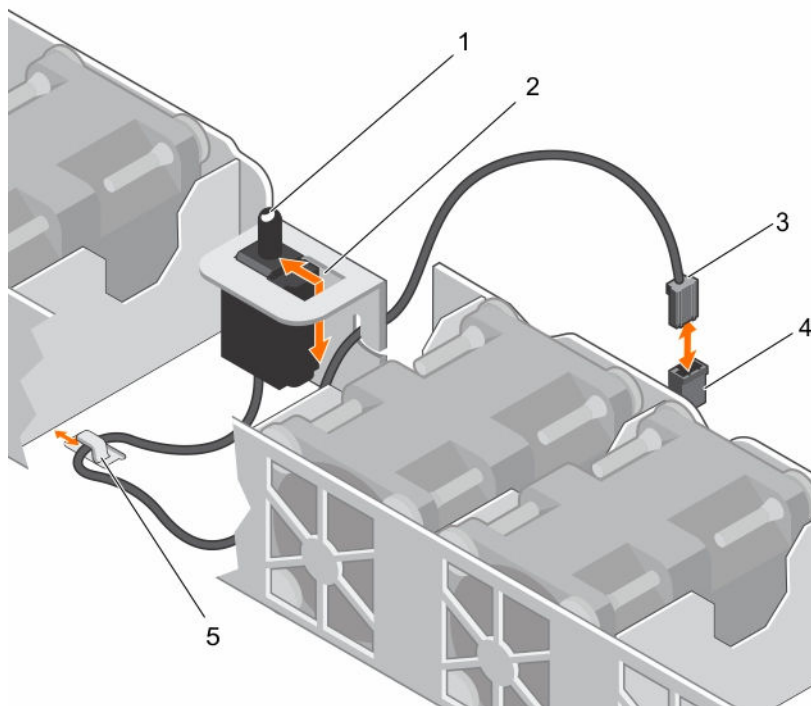

Figure 14. Removing and installing the intrusion switch

- | | |
|---------------------------|---|
| 1. intrusion switch | 2. intrusion switch slot |
| 3. intrusion switch cable | 4. intrusion switch connector on the system board |
| 5. cable routing clip | |

Next steps

Install the intrusion switch.

Related Tasks

[Installing the intrusion switch](#)

Installing the intrusion switch

Prerequisites

 **CAUTION:** Many repairs may only be done by a certified service technician. You should only perform troubleshooting and simple repairs as authorized in your product documentation, or as directed by the online or telephone service and support team. Damage due to servicing that is not authorized by Dell is not covered by your warranty. Read and follow the safety instructions that came with the product.

1. Ensure that you follow the [Safety instructions](#).
2. Follow the procedure listed in [Before working inside your system](#).

Steps

1. Insert the intrusion switch into the intrusion switch slot.
2. Slide the intrusion switch until it locks into position.
3. Route the intrusion switch cable through the cable routing tab.
4. Connect the intrusion switch cable to the connector on the system board.

Next steps

Follow the procedure listed in [After working inside your system](#).

Cooling shroud

Removing the cooling shroud

Prerequisites

 **CAUTION:** Many repairs may only be done by a certified service technician. You should only perform troubleshooting and simple repairs as authorized in your product documentation, or as directed by the online or telephone service and support team. Damage due to servicing that is not authorized by Dell is not covered by your warranty. Read and follow the safety instructions that came with the product.

1. Ensure that you follow the [Safety instructions](#).
2. Follow the procedure listed in [Before working inside your system](#).

 **CAUTION:** Never operate your system with the cooling shroud removed. The system may get overheated quickly, resulting in shutdown of the system and loss of data.

Steps

Hold the cooling shroud and lift it away from the system.

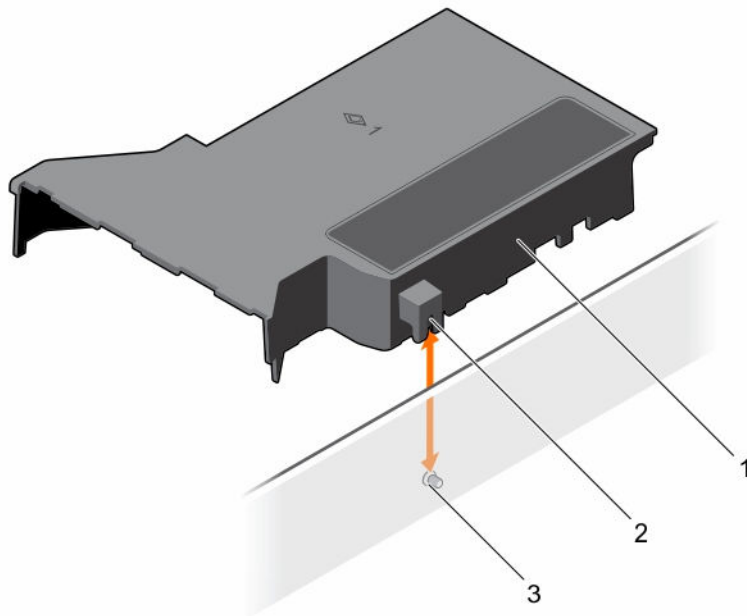

Figure 15. Removing and installing the cooling shroud

1. cooling shroud
2. guide on the cooling shroud
3. guide pin on the chassis wall

Next steps

1. Install the cooling shroud.
2. Follow the procedure listed in [After working inside your system](#).

Related Tasks

[Installing the cooling shroud](#)

Installing the cooling shroud

Prerequisites

⚠ CAUTION: Many repairs may only be done by a certified service technician. You should only perform troubleshooting and simple repairs as authorized in your product documentation, or as directed by the online or telephone service and support team. Damage due to servicing that is not authorized by Dell is not covered by your warranty. Read and follow the safety instructions that came with the product.

1. Ensure that you follow the [Safety instructions](#).
2. Follow the procedure listed in [Before working inside your system](#).

Steps

1. Align the guide on the cooling shroud with the guide pin on the chassis wall.
2. Lower the cooling shroud into the chassis until it is firmly seated.
When firmly seated, the memory socket numbers marked on the cooling shroud align with the respective memory sockets.

Next steps

Follow the procedure listed in [After working inside your system](#).

System memory

Your system supports DDR4 ECC unbuffered DIMMs (UDIMMs).

 **NOTE:** MT/s indicates memory module speed in Mega Transfers per second.

Memory bus operating frequency can be 2133 MT/s, 1866 MT/s, or 1600 MT/s depending on the following factors:

- System profile selected (for example, Performance Optimized, Custom, or Dense Configuration Optimized)
- Maximum supported memory module frequency of the processors

The system contains four memory sockets — two sets of 2-sockets each. Each 2-socket set is organized into one channel. In each 2-socket set, the first socket release lever is marked white and the second socket release lever is marked black.

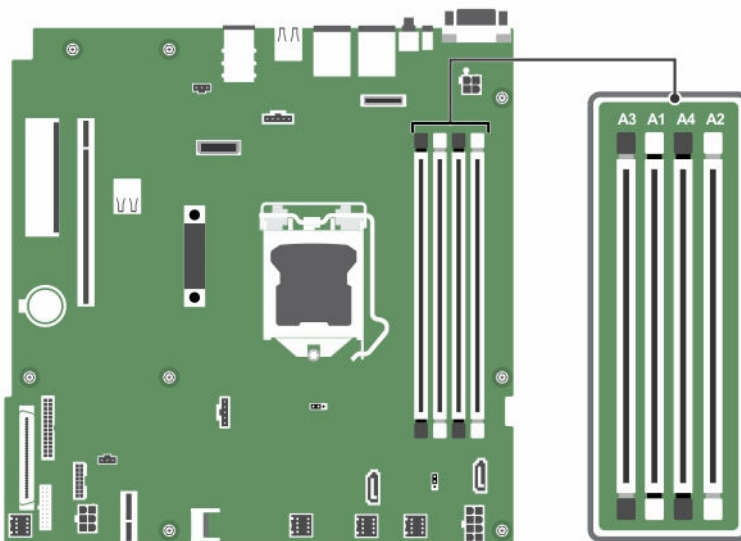

Figure 16. Memory socket locations on the system board

Memory channels are organized as follows:

Processor 1

- channel 0: memory sockets A1 and A3
- channel 1: memory sockets A2 and A4

The following table shows the memory populations and operating frequencies for the supported configurations:

Table 11. Memory populations and operating frequencies for the supported configurations

| Memory module type | Memory modules populated per channel | Operating frequency (in MT/s) | Maximum memory module ranks per channel |
|--------------------|--------------------------------------|-------------------------------|---|
| 1.2 V | | | |
| ECC UDIMM | 1 | 2133, 1866, 1600 | Dual rank or single rank |
| | 2 | 2133, 1866, 1600 | Dual rank or single rank |

General memory module installation guidelines

Your system supports Flexible Memory Configuration, enabling the system to be configured and run in any valid chipset architectural configuration. The following are the recommended guidelines for installing memory modules:

- x4 and x8 DRAM-based DIMMs can be mixed.
- Up to two dual- or single-rank ECC UDIMMs can be populated per channel.
- Populate DIMM sockets only if a processor is installed. For single-processor systems, sockets A1 to A4 are available.
- Populate all sockets with white release levers first, and then all the sockets with black release levers.
- When mixing memory modules with different capacities, populate the sockets with memory modules with the highest capacity first. For example, if you want to mix 4 GB and 8 GB DIMMs, populate 8 GB DIMMs in the sockets with white release levers and 4 GB DIMMs in the sockets with black release levers.
- Memory modules of different capacities can be mixed provided other memory population rules are followed (for example, 4 GB and 8 GB memory modules can be mixed).
- Mixing of more than two DIMM capacities in a system is not supported.
- Populate two DIMMs per processor (one DIMM per channel) at a time to maximize performance.

Sample memory configurations

The following table shows sample memory configurations for a single processor configuration.

 **NOTE:** 1R and 2R in the following table indicate single and dual-rank memory modules respectively.

Table 12. Memory configurations—single processor

| Populated system capacity (in GB) | Memory module size (in GB) | Number of memory modules | Memory module rank, organization, and frequency | memory module slot population |
|-----------------------------------|----------------------------|--------------------------|---|-------------------------------|
| 4 | 4 | 1 | 1R, x8, 2133 MT/s, | A1 |
| | | | 1R, x8, 1866 MT/s | |
| 8 | 4 | 2 | 1R, x8, 2133 MT/s, | A1, A2 |
| | | | 1R, x8, 1866 MT/s | |
| 16 | 4 | 4 | 1R, x8, 2133 MT/s, | A1, A2, A3, A4 |
| | | | 1R, x8, 1866 MT/s | |

| Populated system capacity (in GB) | Memory module size (in GB) | Number of memory modules | Memory module rank, organization, and frequency | memory module slot population |
|-----------------------------------|----------------------------|--------------------------|---|-------------------------------|
| | 8 | 2 | 2R, x8, 2133 MT/s, | A1, A2 |
| | | | 2R, x8, 1866 MT/s | |
| 32 | 8 | 4 | 2R, x8, 2133 MT/s, | A1, A2, A3, A4 |
| | | | 2R, x8, 1866 MT/s | |
| | 16 | 2 | 2R, x8, 2133 MT/s, | A1, A2 |
| | | | 2R, x8, 1866 MT/s | |
| 64 | 16 | 4 | 2R, x8, 2133 MT/s, | A1, A2, A3, A4 |
| | | | 2R, x8, 1866 MT/s | |

Removing a memory module

Prerequisites

 **CAUTION:** Many repairs may only be done by a certified service technician. You should only perform troubleshooting and simple repairs as authorized in your product documentation, or as directed by the online or telephone service and support team. Damage due to servicing that is not authorized by Dell is not covered by your warranty. Read and follow the safety instructions that came with the product.

1. Ensure that you follow the [Safety instructions](#).
2. Follow the procedure listed in [Before working inside your system](#).
3. Remove the cooling shroud.

 **WARNING:** The memory modules are hot to touch for some time after the system has been powered down. Allow the memory modules to cool before handling them. Handle the memory modules by the card edges and avoid touching the components or metallic contacts on the memory module.

Steps

1. Locate the appropriate memory module socket.
2. To release the memory module from the socket, simultaneously press the ejectors on both ends of the memory module socket.

 **CAUTION:** Handle each memory module only by the card edges, making sure not to touch the middle of the memory module or metallic contacts.

3. Lift the memory module away from the chassis.

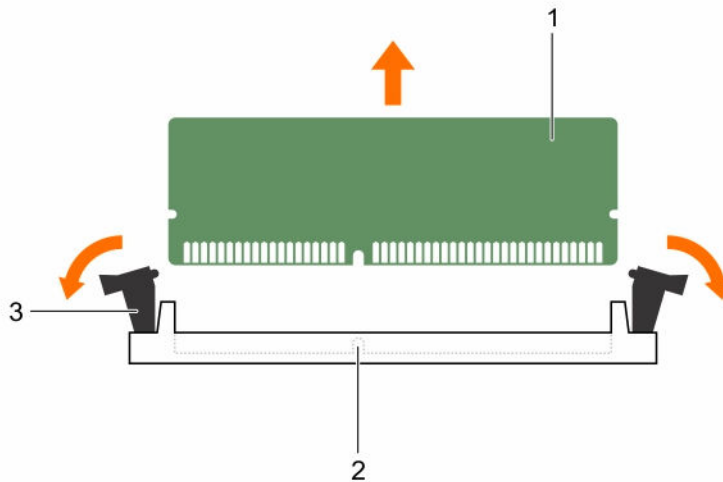

Figure 17. Removing the memory module

1. memory module
2. memory module socket
3. memory module ejector (2)

Next steps

1. Install the memory module.
2. If you are removing a memory module permanently, install a memory module blank.
NOTE: The procedure to install a memory module blank is similar to the procedure to install a memory module.
3. Install the cooling shroud.

Related Tasks

- [Installing a memory module](#)
- [Removing the cooling shroud](#)
- [Installing the cooling shroud](#)

Installing a memory module

Prerequisites

CAUTION: Many repairs may only be done by a certified service technician. You should only perform troubleshooting and simple repairs as authorized in your product documentation, or as directed by the online or telephone service and support team. Damage due to servicing that is not authorized by Dell is not covered by your warranty. Read and follow the safety instructions that came with the product.

1. Ensure that you read the [Safety instructions](#).
2. Follow the procedure listed in [Before working inside your system](#).
3. Remove the cooling shroud.

 **WARNING:** The memory modules are hot to touch for some time after the system has been powered down. Allow the memory modules to cool before handling them. Handle the memory modules by the card edges and avoid touching the components or metallic contacts on the memory module.

Steps

1. Locate the appropriate memory module socket.

 **CAUTION:** Handle each memory module only by the card edges, making sure not to touch the middle of the memory module or metallic contacts.

 **CAUTION:** To prevent damage to the memory module or the memory module socket during installation, do not bend or flex the memory module; insert both ends of the memory module simultaneously.

2. If a memory module or a memory module blank is installed in the socket, remove it.

 **NOTE:** The procedure to remove a memory module blank is similar to the procedure to remove a memory module.

 **NOTE:** Retain the removed memory module blank(s) for future use.

3. Align the edge connector of the memory module with the alignment key of the memory module socket, and insert the memory module in the socket.

 **NOTE:** The memory module socket has an alignment key that enables you to install the memory module in the socket in only one orientation.

 **CAUTION:** Do not apply pressure at the center of the memory module; apply pressure at both ends of the memory module evenly.

4. Press the memory module with your thumbs until the socket levers firmly click into place. When the memory module is properly seated in the socket, the levers on the memory module socket align with the levers on the other sockets that have memory modules installed.

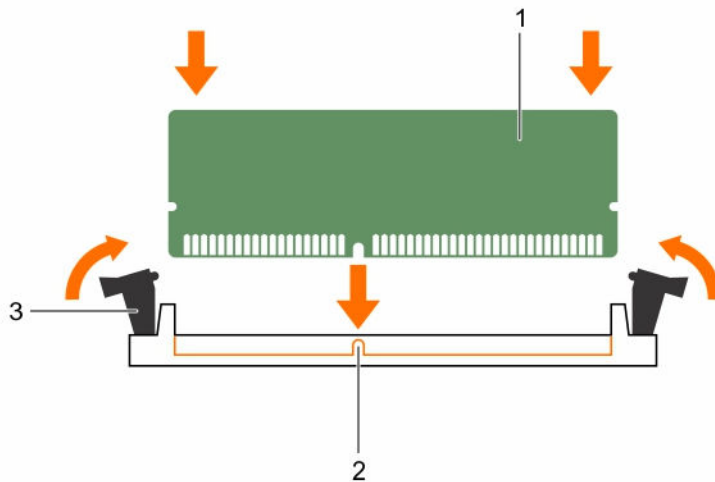

Figure 18. Installing the memory module

- | | |
|-------------------------------------|------------------|
| 1. memory module | 2. alignment key |
| 3. memory module socket ejector (2) | |

Next steps

1. Install the cooling shroud.
2. Follow the procedure listed in [After working inside your system](#).
3. Press F2 to enter System Setup, and check the **System Memory** setting. The **System Memory Size** indicates the installed memory.
4. If the **System Memory Size** is incorrect, one or more of the memory modules may not be installed properly. Ensure that the memory modules are firmly seated in their sockets.
5. Run the system memory test in the system diagnostics.

Related Tasks

- [Removing the cooling shroud](#)
- [Installing the cooling shroud](#)

Hard drives

Your system supports enterprise class hard drives. Enterprise class drives are designed for 24x7 operating environment. Selecting the correct drive class enables the critical areas of quality, functionality, performance, and reliability to be optimized for the target implementation.

Choosing the right drive type depends on the usage pattern. Due to industry advances, in some cases, the larger capacity drives have been changed to a larger sector size. The larger sector size can have impacts on operating systems and applications. For more information about these hard drives, see the *512e and 4Kn Disk Formats* whitepaper and *4K Sector HDD FAQ* document at Dell.com/poweredge/manuals.

 **CAUTION:** Before attempting to remove or install a hard drive while the system is running, see the documentation for the storage controller card to ensure that the host adapter is configured correctly to support hot swappable hard drive removal and insertion.

 **CAUTION:** Do not turn off or restart your system while the hard drive is being formatted. Doing so can cause a hard drive failure.

Use only hard drives that have been tested and approved for use with the hard drive backplane.

When you format a hard drive, allow enough time for the formatting to be completed. Be aware that high-capacity hard drives can take a long time to format.

Supported hard drive configurations

Depending on the configuration, your system supports one of the following:

Four hard drive systems Up to four 3.5-inch hot-swappable SATA hard drives, or SATA solid state drives (SSDs)
Up to four 3.5-inch cabled hard drives

Six hard drive systems Up to four 3.5-inch cabled hard drives and two optional 1.8-inch SSDs in the optical drive slot

Eight hard drive systems Up to eight 2.5-inch, hot-swappable hard drives/SSDs

 **NOTE:** SAS/SATA hard drives cannot be mixed in a system.

The hot-swappable hard drives connect to the system board through the hard drive backplane. Hot-swappable hard drives are supplied in hot-swappable hard drive carriers that fit in the hard drive slots.

Removing a 2.5-inch hot swappable hard drive blank

Prerequisites

 **CAUTION:** Many repairs may only be done by a certified service technician. You should only perform troubleshooting and simple repairs as authorized in your product documentation, or as directed by the online or telephone service and support team. Damage due to servicing that is not authorized by Dell is not covered by your warranty. Read and follow the safety instructions that came with the product.

 **CAUTION:** To maintain proper system cooling, all empty hard drive slots must have hard drive blanks installed.

1. Ensure that you follow the [Safety instructions](#).
2. If installed, remove the bezel.

Steps

Press the release button and slide the hard drive blank out of the hard drive slot.

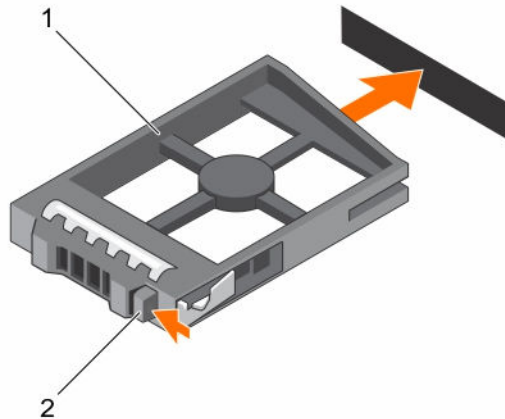

Figure 19. Removing and installing a 2.5-inch hard drive blank

1. hard drive blank
2. release button

Next steps

If removed, install the front bezel.

Related Tasks

[Removing the optional front bezel](#)

[Installing the optional front bezel](#)

Installing a 2.5-inch hot swappable hard drive blank

Prerequisites

⚠ CAUTION: Many repairs may only be done by a certified service technician. You should only perform troubleshooting and simple repairs as authorized in your product documentation, or as directed by the online or telephone service and support team. Damage due to servicing that is not authorized by Dell is not covered by your warranty. Read and follow the safety instructions that came with the product.

1. Ensure that you follow the [Safety instructions](#).
2. If installed, remove the front bezel.

Steps

Insert the hard drive blank into the hard drive slot until the release button clicks into place.

Next steps

If applicable, install the front bezel.

Related Tasks

[Removing the optional front bezel](#)

[Installing the optional front bezel](#)

Removing a 3.5-inch hot swappable hard drive carrier blank

Prerequisites

⚠ **CAUTION:** Many repairs may only be done by a certified service technician. You should only perform troubleshooting and simple repairs as authorized in your product documentation, or as directed by the online or telephone service and support team. Damage due to servicing that is not authorized by Dell is not covered by your warranty. Read and follow the safety instructions that came with the product.

⚠ **CAUTION:** To maintain proper system cooling, all empty hard drive slots must have drive carrier blanks installed.

1. Ensure that you follow the [Safety instructions](#).
2. If installed, remove the front bezel.

Steps

Press the release button and slide the hard drive carrier blank out of the hard drive slot.

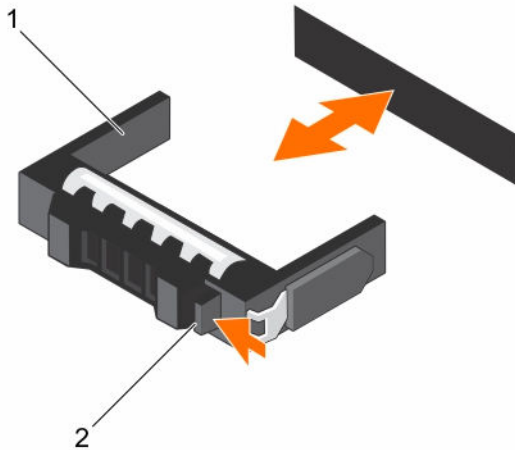

Figure 20. Removing and installing a 3.5-inch hot swappable hard drive carrier blank

1. hard drive carrier blank

2. release button

Next steps

If removed, install the front bezel.

Related Tasks

[Removing the optional front bezel](#)

[Installing the optional front bezel](#)

Installing a 3.5-inch hot swappable hard drive carrier blank

Prerequisites

⚠ **CAUTION:** Many repairs may only be done by a certified service technician. You should only perform troubleshooting and simple repairs as authorized in your product documentation, or as directed by the online or telephone service and support team. Damage due to servicing that is not authorized by Dell is not covered by your warranty. Read and follow the safety instructions that came with the product.

1. Ensure that you follow the [Safety instructions](#).
2. If installed, remove the front bezel.

Steps

Insert the hard drive carrier blank into the hard drive slot, and push the hard drive carrier blank until the release button clicks into place.

Next steps

If removed, install the front bezel.

Related Tasks

[Removing the optional front bezel](#)

[Installing the optional front bezel](#)

Removing a 3.5-inch cabled hard drive carrier

Prerequisites

 **CAUTION:** Many repairs may only be done by a certified service technician. You should only perform troubleshooting and simple repairs as authorized in your product documentation, or as directed by the online or telephone service and support team. Damage due to servicing that is not authorized by Dell is not covered by your warranty. Read and follow the safety instructions that came with the product.

1. Ensure that you follow the [Safety instructions](#).
2. Follow the procedure listed in [Before working inside your system](#).

 **NOTE:** The empty cabled hard drive carrier can be used as a blank.

Steps

1. Disconnect the data and power cable from the hard drive.
2. Press the release tab on the hard drive carrier and slide the hard drive carrier out of the hard drive slot.

 **CAUTION:** To maintain proper system cooling, all empty hard drive slots must have hard drive carrier blanks installed.

3. Insert a hard drive blank in the empty hard drive slot.

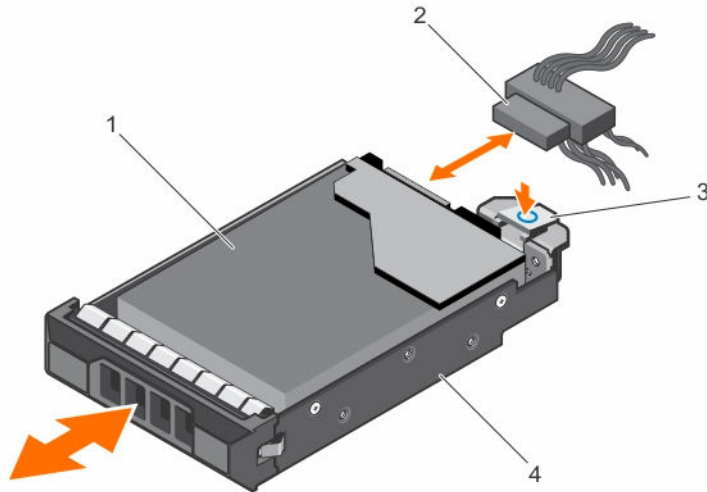

Figure 21. Removing and installing a cabled hard drive carrier

- | | |
|----------------|-----------------------|
| 1. hard drive | 2. power/data cable |
| 3. release tab | 4. hard drive carrier |

Next steps

1. If required, install a hard drive in the hard drive carrier and install the hard drive carrier into the hard drive slot in the system.
2. If you are not replacing the hard drive immediately, insert a hard drive carrier in the empty hard drive slot.
3. Follow the procedure listed in [After working inside your system](#).

Related Tasks

[Installing a 3.5-inch cabled hard drive carrier](#)

Removing a cabled hard drive from a hard drive carrier

Prerequisites

⚠ CAUTION: Many repairs may only be done by a certified service technician. You should only perform troubleshooting and simple repairs as authorized in your product documentation, or as directed by the online or telephone service and support team. Damage due to servicing that is not authorized by Dell is not covered by your warranty. Read and follow the safety instructions that came with the product.

1. Ensure that you follow the [Safety instructions](#).
2. Follow the procedure listed in [Before working inside your system](#).
3. Remove the cabled hard drive carrier.
4. Keep the Phillips #2 screwdriver ready.

Steps

1. Remove the screws from the side of the cabled hard drive carrier.
2. Remove the hard drive from the hard drive carrier.

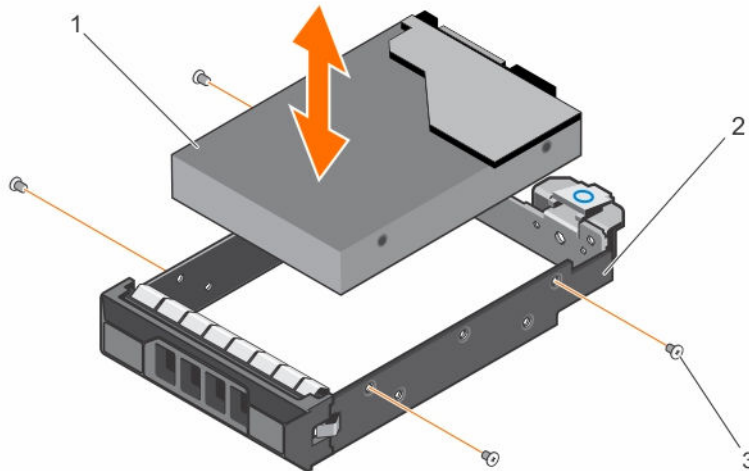

Figure 22. Removing a cabled hard drive from a cabled hard drive carrier

1. cabled hard drive
2. cabled hard drive carrier
3. screw (4)

Next steps

1. Install the cabled hard drive in the hard drive carrier.
2. Install the hard drive carrier into the slot.
3. Follow the procedure listed in [After working inside your system](#).

Related Tasks

- [Removing a 3.5-inch cabled hard drive carrier](#)
- [Installing a cabled hard drive into a hard drive carrier](#)
- [Installing a 3.5-inch cabled hard drive carrier](#)

Installing a cabled hard drive into a hard drive carrier

Prerequisites

⚠ CAUTION: Many repairs may only be done by a certified service technician. You should only perform troubleshooting and simple repairs as authorized in your product documentation, or as directed by the online or telephone service and support team. Damage due to servicing that is not authorized by Dell is not covered by your warranty. Read and follow the safety instructions that came with the product.

1. Ensure that you follow the [Safety instructions](#).

2. Follow the procedure listed in [Before working inside your system](#).
3. Remove the hard drive carrier.
4. Keep the Phillips #2 screwdriver ready.

Steps

1. Insert the hard drive into the hard drive carrier with the connector end of the hard drive toward the back of the hard drive carrier.
2. Align the screw holes on the hard drive with the screw holes on the hard drive carrier.
When aligned correctly, the back of the hard drive is flush with the back of the hard drive carrier.
3. Install the screws to secure the hard drive to the hard drive carrier.

Next steps

1. Install the cabled hard drive carrier.
2. Follow the procedure listed in [After working inside your system](#).

Related Tasks

- [Removing a 3.5-inch cabled hard drive carrier](#)
- [Installing a 3.5-inch cabled hard drive carrier](#)

Installing a 3.5-inch cabled hard drive carrier

Prerequisites

 **CAUTION: Many repairs may only be done by a certified service technician. You should only perform troubleshooting and simple repairs as authorized in your product documentation, or as directed by the online or telephone service and support team. Damage due to servicing that is not authorized by Dell is not covered by your warranty. Read and follow the safety instructions that came with the product.**

1. Ensure that you follow the [Safety instructions](#).
2. Follow the procedure listed in [Before working inside your system](#).

Steps

1. Press the release tab on the hard drive carrier and slide the hard drive carrier out of the system.
2. Install the hard drive into the hard drive carrier.
3. Insert the hard drive carrier into the hard drive slot, and push the hard drive carrier until it clicks into place.
4. Connect the power and data cable to the hard drive.
 - If connecting to the integrated SATA controller (SATA hard drives only), connect the SATA data cable to the SATA_A-D connector on the system board.
 - If connecting to a SAS RAID controller card (SAS or SATA hard drives), connect the data cable to the connector on the card.

Next steps

1. Follow the procedure listed in [After working inside your system](#).
2. Reconnect the system to its electrical outlet and turn on the system, including any attached peripherals.
3. Enter System Setup and ensure that the controller of the hard drive is enabled.
4. Exit System Setup and reboot the system.
5. Install any software required for the hard drive operation as described in the documentation for the hard drive.

Removing a hot swappable hard drive carrier

Prerequisites

⚠ CAUTION: Many repairs may only be done by a certified service technician. You should only perform troubleshooting and simple repairs as authorized in your product documentation, or as directed by the online or telephone service and support team. Damage due to servicing that is not authorized by Dell is not covered by your warranty. Read and follow the safety instructions that came with the product.

1. Ensure that you follow the [Safety instructions](#).
2. If installed, remove the front bezel.
3. Using the management software, prepare the hard drive for removal. For more information, see the documentation for the storage controller.

If the hard drive is online, the green activity or fault indicator flashes when the hard drive is turned off. You can remove the hard drive when the hard drive indicators turn off.

⚠ CAUTION: To prevent data loss, ensure that your operating system supports hot-swap drive installation. See the documentation supplied with your operating system.

✎ NOTE: Hot swappable hard drives are supplied in hot swappable hard drive carriers that fit in the hard drive slots.

Steps

1. Press the release button to open the hard drive carrier release handle.
2. Slide the hard drive carrier out of the hard drive slot.

⚠ CAUTION: To maintain proper system cooling, all empty hard drive slots must have hard drive carrier blanks installed.

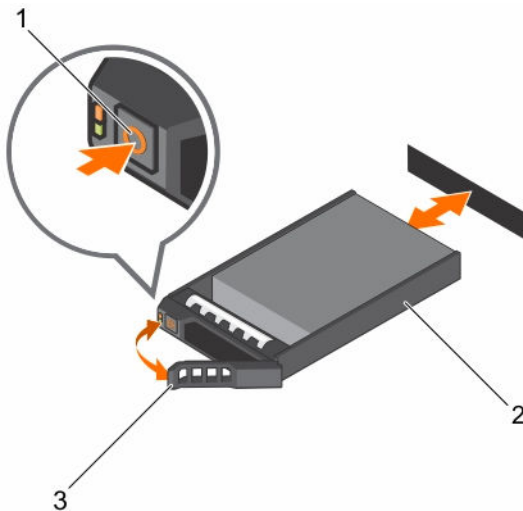

Figure 23. Removing and installing a hot swappable hard drive carrier

1. release button
2. hard drive carrier
3. hard drive carrier handle

Next steps

If you are not replacing the hard drive immediately, insert a hard drive carrier blank in the empty hard drive slot, or install a hard drive carrier.

Related Tasks

[Removing the optional front bezel](#)

[Installing a 2.5-inch hot swappable hard drive blank](#)

[Installing a 3.5-inch hot swappable hard drive carrier blank](#)

[Installing a hot swappable hard drive carrier](#)

Installing a hot swappable hard drive carrier

Prerequisites

 **CAUTION:** Many repairs may only be done by a certified service technician. You should only perform troubleshooting and simple repairs as authorized in your product documentation, or as directed by the online or telephone service and support team. Damage due to servicing that is not authorized by Dell is not covered by your warranty. Read and follow the safety instructions that came with the product.

 **CAUTION:** Use only hard drives that have been tested and approved for use with the hard drive backplane.

 **CAUTION:** Combining SAS and SATA hard drives in the same RAID volume is not supported.

 **CAUTION:** When installing a hard drive, ensure that the adjacent drives are fully installed. Inserting a hard drive carrier and attempting to lock its handle next to a partially installed carrier can damage the partially installed carrier's shield spring and make it unusable.

 **CAUTION:** To prevent data loss, ensure that your operating system supports hot-swap drive installation. See the documentation supplied with your operating system.

 **CAUTION:** When a replacement hot swappable hard drive is installed and the system is powered on, the hard drive automatically begins to rebuild. Make absolutely sure that the replacement hard drive is blank or contains data that you wish to have over-written. Any data on the replacement hard drive is immediately lost after the hard drive is installed.

 **NOTE:** Hot swappable hard drives are supplied in hot swappable hard drive carriers that fit in the hard drive slots.

1. If installed, remove the hard drive carrier blank.
2. Install a hot swappable hard drive into the hot swappable hard drive carrier.

Steps

1. Press the release button on the front of the hot swappable hard drive carrier and open the hot swappable hard drive carrier handle.
2. Insert the hot swappable hard drive carrier into the hard drive slot, and push the hot swappable hard drive carrier until it comes in contact with the backplane.
3. Close the hot swappable hard drive carrier handle to lock the hot swappable hard drive carrier in place.

Next steps

If removed, install the front bezel.

Related Tasks

[Removing a 2.5-inch hot swappable hard drive blank](#)

[Removing a 3.5-inch hot swappable hard drive carrier blank](#)

[Installing a hot swappable hard drive into a hot swappable hard drive carrier](#)
[Installing the optional front bezel](#)

Removing the optional 1.8-inch solid state drives

Prerequisites

CAUTION: Many repairs may only be done by a certified service technician. You should only perform troubleshooting and simple repairs as authorized in your product documentation, or as directed by the online or telephone service and support team. Damage due to servicing that is not authorized by Dell is not covered by your warranty. Read and follow the safety instructions that came with the product.

1. Ensure that you follow the [Safety instructions](#).
2. Follow the procedure listed in [Before working inside your system](#).

Steps

1. Disconnect the power and data cables from the back of the solid state drives (SSDs).
2. If required, disconnect the power and data cables from the system board.
Observe the routing of the power and data cables inside the chassis as you remove them from the system board and the optical drive. You must route these cables properly when you replace them to prevent them from being pinched or crimped.
3. To release the SSD tray, press and push the tray release tab toward the front of the system.

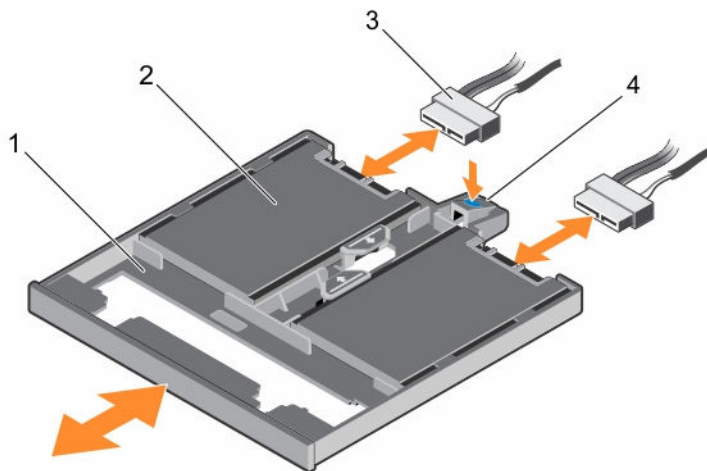

Figure 24. Removing and installing the 1.8-inch SSD tray

- | | |
|-------------------------|---------------------|
| 1. SSD tray | 2. SSD |
| 3. data and power cable | 4. tray release tab |
4. Slide the SSD carrier out of the system until it is free of the optical-drive slot.
 5. Press the SSD release tab and lift the SSD from the tray.

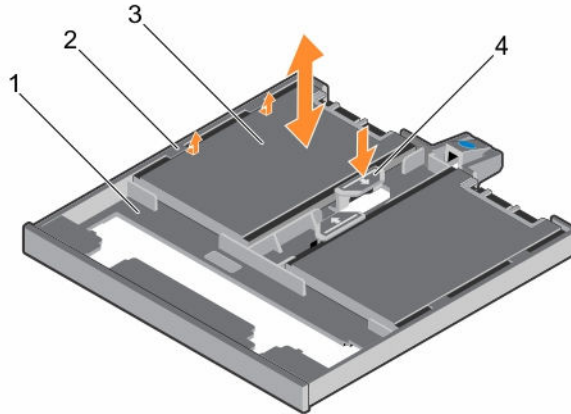



Figure 25. Removing and installing the 1.8-inch solid state drives from the SSD tray

- | | |
|-------------|---------------------|
| 1. SSD tray | 2. tabs on the tray |
| 3. SSD | 4. SSD release tab |

Next steps

1. Depending on your system configuration, install an optical drive or two 1.8-inch solid state drives.
2. If you are not immediately installing an optical drive or 1.8-inch SSDs, install an optical drive blank.

 **NOTE:** Blanks must be installed on empty optical drive or tape drive slots to maintain FCC certification of the system. The brackets also keep dust and dirt out of the system and aid in proper cooling and airflow inside the system.

3. Follow the procedure listed in [After working inside your system](#).

Related Tasks

[Installing the optional 1.8-inch solid state drives](#)

[Installing the optional optical drive](#)

Installing the optional 1.8-inch solid state drives

Prerequisites

 **CAUTION:** Many repairs may only be done by a certified service technician. You should only perform troubleshooting and simple repairs as authorized in your product documentation, or as directed by the online or telephone service and support team. Damage due to servicing that is not authorized by Dell is not covered by your warranty. Read and follow the safety instructions that came with the product.

1. Ensure that you follow the [Safety instructions](#).
2. Follow the procedure listed in [Before working inside your system](#).
3. If installed, remove the optical drive blank or the SSD tray by pressing the blue release tab at the back of the blank or tray and pushing the blank or tray out of the system.

Steps

1. Press the SSD release tab on the SSD tray, and slide the SSD under the tabs on the tray.
2. Press the SSD until it locks into place.
3. Align the SSD tray with the optical drive slot on the front of chassis.
4. Slide the SSD tray into the slot until the latch snaps into place.
5. Connect the power and data cable to the back of the SSD.
6. Route the power and data cable underneath the cable routing latch of the system.
7. Connect the power and data cable to the connectors on the system board.

Next steps

Follow the procedure listed in [After working inside your system](#).

Related Tasks

[Removing the optional optical drive](#)

[Removing the optional 1.8-inch solid state drives](#)

Installing a 2.5-inch hot swappable hard drive into a 3.5-inch hard drive adapter

Prerequisites



CAUTION: Many repairs may only be done by a certified service technician. You should only perform troubleshooting and simple repairs as authorized in your product documentation, or as directed by the online or telephone service and support team. Damage due to servicing that is not authorized by Dell is not covered by your warranty. Read and follow the safety instructions that came with the product.

1. Ensure that you follow the [Safety instructions](#).
2. Keep the Phillips #2 screwdriver ready.

Steps

1. Align the screw holes on the 2.5-inch hot swappable hard drive with the screw holes on the 3.5-inch hard drive adapter.
2. Install the screws to secure the 2.5-inch hot swappable hard drive to the 3.5-inch hard drive adapter.

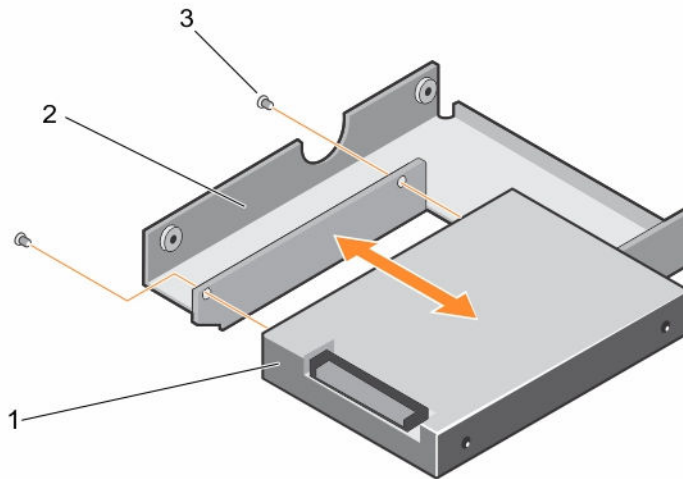

Figure 26. Removing and installing a 2.5-inch hot swappable hard drive into a 3.5-inch hard drive adapter

- | | |
|--------------------------------------|--------------------------------|
| 1. 2.5-inch hot swappable hard drive | 2. 3.5-inch hard drive adapter |
| 3. screw (2) | |

Next steps

Install the 3.5-inch adapter into the 3.5-inch hot swappable hard drive carrier.

Related Tasks

[Installing a 3.5-inch hard drive adapter into the 3.5-inch hot swappable hard drive carrier](#)

Removing a 2.5-inch hot swappable hard drive from a 3.5-inch hard drive adapter

Prerequisites

⚠ CAUTION: Many repairs may only be done by a certified service technician. You should only perform troubleshooting and simple repairs as authorized in your product documentation, or as directed by the online or telephone service and support team. Damage due to servicing that is not authorized by Dell is not covered by your warranty. Read and follow the safety instructions that came with the product.

1. Ensure that you follow the [Safety instructions](#).
2. Keep the Phillips #2 screwdriver ready.
3. Remove the 3.5-inch hard drive adapter from the 3.5-inch hot swappable hard drive carrier.

✍ NOTE: A 2.5-inch hot swappable hard drive is installed in a 3.5-inch hard drive adapter, which is then installed in the 3.5-inch hot swappable hard drive carrier.

Steps

1. Remove the screws from the side of the 3.5-inch hard drive adapter.
2. Remove the 2.5-inch hot swappable hard drive from the 3.5-inch hard drive adapter.

Related Tasks

[Removing a 3.5-inch hard drive adapter from a 3.5-inch hot swappable hard drive carrier](#)

Installing a 3.5-inch hard drive adapter into the 3.5-inch hot swappable hard drive carrier

Prerequisites

CAUTION: Many repairs may only be done by a certified service technician. You should only perform troubleshooting and simple repairs as authorized in your product documentation, or as directed by the online or telephone service and support team. Damage due to servicing that is not authorized by Dell is not covered by your warranty. Read and follow the safety instructions that came with the product.

1. Ensure that you follow the [Safety instructions](#).
2. Keep the Phillips #2 screwdriver ready.
3. Install the 2.5-inch hot swappable hard drive into the 3.5-inch hard drive adapter.

Steps

1. Insert the 3.5-inch hard drive adapter into the 3.5-inch hot swappable hard drive carrier with the connector end of the hard drive toward the back of the 3.5-inch hot swappable hard drive carrier.
2. Align the screw holes on the 3.5-inch hard drive adapter and the 3.5-inch hot swappable hard drive carrier.
3. Install the screws to secure the 3.5-inch hard drive adapter to the 3.5-inch hot swappable hard drive carrier.

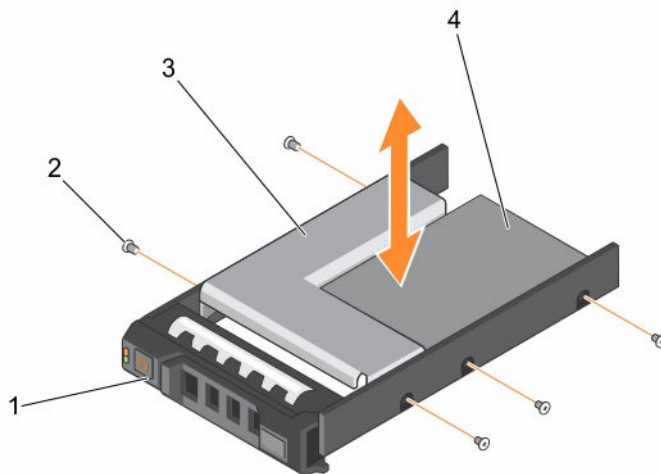

Figure 27. Removing and installing a 3.5-inch hard drive adapter into a 3.5-inch hot swappable hard drive carrier

- | | |
|--|--------------------------------------|
| 1. 3.5-inch hot swappable hard drive carrier | 2. screw (5) |
| 3. 3.5-inch hard drive adapter | 4. 2.5-inch hot swappable hard drive |

Next steps

Install the 3.5-inch hot swappable hard drive carrier into the system.

Related Tasks

- [Installing a 2.5-inch hot swappable hard drive into a 3.5-inch hard drive adapter](#)
- [Installing a hot swappable hard drive carrier](#)

Removing a 3.5-inch hard drive adapter from a 3.5-inch hot swappable hard drive carrier

Prerequisites

1. Ensure that you follow the [Safety instructions](#).
2. Keep the Phillips #2 screwdriver ready.
3. Remove the 3.5-inch hot swappable hard drive carrier from the system.

Steps

1. Remove the screws from the rails on the 3.5-inch hot swappable hard drive carrier.
2. Lift the 3.5-inch hard drive adapter out of the 3.5-inch hot swappable hard drive carrier.

Next steps

Remove the 2.5-inch hot swappable hard drive from a 3.5-inch hard drive adapter.

Related Tasks

[Removing a hot swappable hard drive carrier](#)

[Removing a 2.5-inch hot swappable hard drive from a 3.5-inch hard drive adapter](#)

Removing a hot swappable hard drive from a hard drive carrier

Prerequisites



CAUTION: Many repairs may only be done by a certified service technician. You should only perform troubleshooting and simple repairs as authorized in your product documentation, or as directed by the online or telephone service and support team. Damage due to servicing that is not authorized by Dell is not covered by your warranty. Read and follow the safety instructions that came with the product.



NOTE: Hot swappable hard drives are supplied in hot swappable hard drive carriers that fit in the hard drive slots.

1. Keep the Phillips #2 screwdriver ready.
2. Remove the hard drive carrier from the system.

Steps

1. Remove the screws from the side rails on the hard drive carrier.
2. Lift the hard drive out of the hard drive carrier.

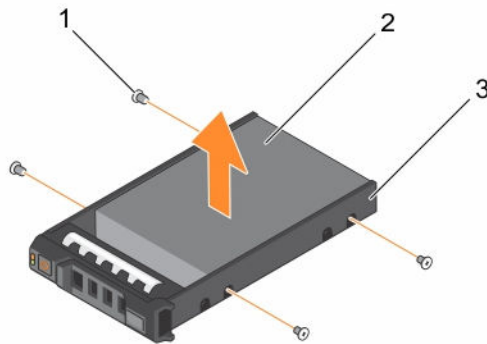

Figure 28. Removing and installing a hot swappable hard drive into a hard drive carrier

1. screw (4)
2. hard drive
3. hard drive carrier

Next steps

1. Install the hot swappable hard drive into the hard drive carrier.
2. Install the hot swappable hard drive carrier into the system.

Related Tasks

[Removing a hot swappable hard drive carrier](#)

[Installing a hot swappable hard drive into a hot swappable hard drive carrier](#)

[Installing a hot swappable hard drive carrier](#)

Installing a hot swappable hard drive into a hot swappable hard drive carrier

Prerequisites



CAUTION: Many repairs may only be done by a certified service technician. You should only perform troubleshooting and simple repairs as authorized in your product documentation, or as directed by the online or telephone service and support team. Damage due to servicing that is not authorized by Dell is not covered by your warranty. Read and follow the safety instructions that came with the product.



NOTE: Hot swappable hard drives are supplied in hot swappable hard drive carriers that fit in the hard drive slots.

1. Keep the Phillips #2 screwdriver ready.
2. Remove the hot swappable hard drive carrier.

Steps

1. Insert the hot swappable hard drive into the hard drive carrier with the connector end of the hard drive toward the back.
2. Align the screw holes on the hard drive with the set of screw holes on the hard drive carrier. When aligned correctly, the back of the hard drive is flush with the back of the hard drive carrier.

3. Attach the screws to secure the hard drive to the hard drive carrier.

Next steps

Install the hard drive carrier into the system.

Related Tasks

[Removing a hot swappable hard drive carrier](#)

[Installing a hot swappable hard drive carrier](#)

Optical drive (optional)

Removing the optional optical drive

The procedure for removing an optical drive and optical drive blank is the same.

Prerequisites

 **CAUTION:** Many repairs may only be done by a certified service technician. You should only perform troubleshooting and simple repairs as authorized in your product documentation, or as directed by the online or telephone service and support team. Damage due to servicing that is not authorized by Dell is not covered by your warranty. Read and follow the safety instructions that came with the product.

1. Ensure that you follow the [Safety instructions](#).
2. Follow the procedure listed in [Before working inside your system](#).

 **NOTE:** Observe the routing of the power and data cables inside the chassis as you remove them from the system board and the optical drive. Route these cables in the same way when you replace them to prevent them from being pinched or crimped.

Steps

1. Disconnect the power and data cables from the back of the optical drive.
2. If required, disconnect the power and data cables from the system board.
3. To release the optical drive, press and push the release tab toward the front of the system.
4. Slide the optical drive out of the system.

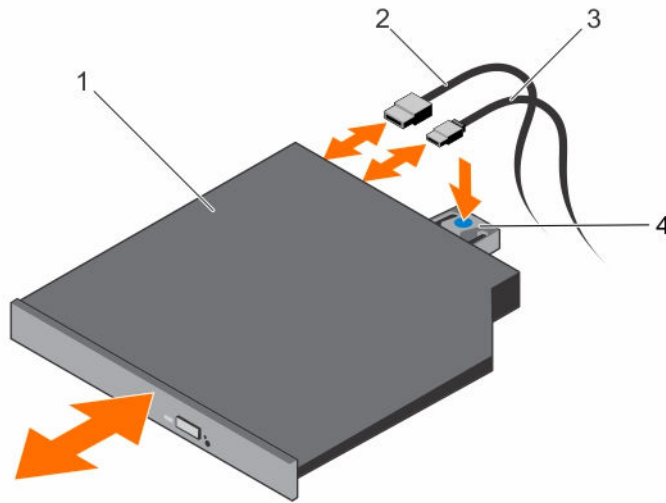

Figure 29. Removing and installing the optical drive

- | | |
|------------------|----------------|
| 1. optical drive | 2. data cable |
| 3. power cable | 4. release tab |

Next steps

1. Depending on your system configuration, install an optical drive or two 1.8-inch solid state drives (SSDs).
2. If you are not immediately installing an optical drive or 1.8-inch SSDs, install an optical drive blank.

NOTE: Blanks must be installed on empty optical drive or tape drive slots to maintain FCC certification of the system. The brackets also keep dust and dirt out of the system and aid in proper cooling and airflow inside the system.

3. Follow the procedure listed in [After working inside your system](#).

Related References

[Supported hard drive configurations](#)

Related Tasks

[Installing the optional optical drive](#)

[Installing the optional 1.8-inch solid state drives](#)

Installing the optional optical drive

The procedure for installing an optical drive and optical drive blank is the same.

Prerequisites

CAUTION: Many repairs may only be done by a certified service technician. You should only perform troubleshooting and simple repairs as authorized in your product documentation, or as directed by the online or telephone service and support team. Damage due to servicing that is not authorized by Dell is not covered by your warranty. Read and follow the safety instructions that came with the product.

1. Ensure that you follow the [Safety instructions](#).
2. Follow the procedure listed in [Before working inside your system](#).
3. If installed, remove the optical drive blank by pressing the blue release tab at the back of the blank and pushing the blank out of the system.

Steps



1. Align the optical drive with the optical drive slot on the front of the chassis.
2. Slide the optical drive into the slot until the latch snaps into place.
3. Connect the power and data cables to the back of the optical drive.
4. Route the power and data cables through the cable routing latch of the system.
5. Connect the power and data cables to the connectors on the system board.

Next steps

Follow the procedure listed in [After working inside your system](#).

Cooling fans

Depending on your system configuration, your system can support up to four cooling fans.

-  **NOTE:** Hot swappable removal or installation of the fans is not supported.
-  **NOTE:** Each fan is listed in the management software of the system, referenced by the respective fan number. If there is a problem with a particular fan, you can easily identify and replace the proper fan by noting down the fan numbers provided on the cooling fans.

The following table shows the number of fans required for different system configurations:

Table 13. Number of fans based on system configuration

| System configuration | Number of fans |
|---|----------------|
| Systems with four 3.5-inch hard drives or four 2.5-inch hard drives with adapter | 3 |
| Systems with four 3.5-inch hard drives or four 2.5-inch hard drives with adapter with PCIe riser card | 4 |
| Systems with eight 2.5-inch hard drives | 4 |

-  **NOTE:** Ensure that you install a cooling fan blank in an empty cooling fan bracket.

Removing the cooling fan blank

Prerequisites

-  **CAUTION:** Many repairs may only be done by a certified service technician. You should only perform troubleshooting and simple repairs as authorized in your product documentation, or as directed by the online or telephone service and support team. Damage due to servicing that is not authorized by Dell is not covered by your warranty. Read and follow the safety instructions that came with the product.

-  **NOTE:** The procedure for removing each cooling fan blank is identical.

1. Ensure that you follow the [Safety instructions](#).
2. Follow the procedure listed in [Before working inside your system](#).

Steps

1. Press the release tabs and push the cooling fan blank to disengage it from the cooling fan bracket.
2. Lift the cooling fan blank out of the cooling fan bracket.

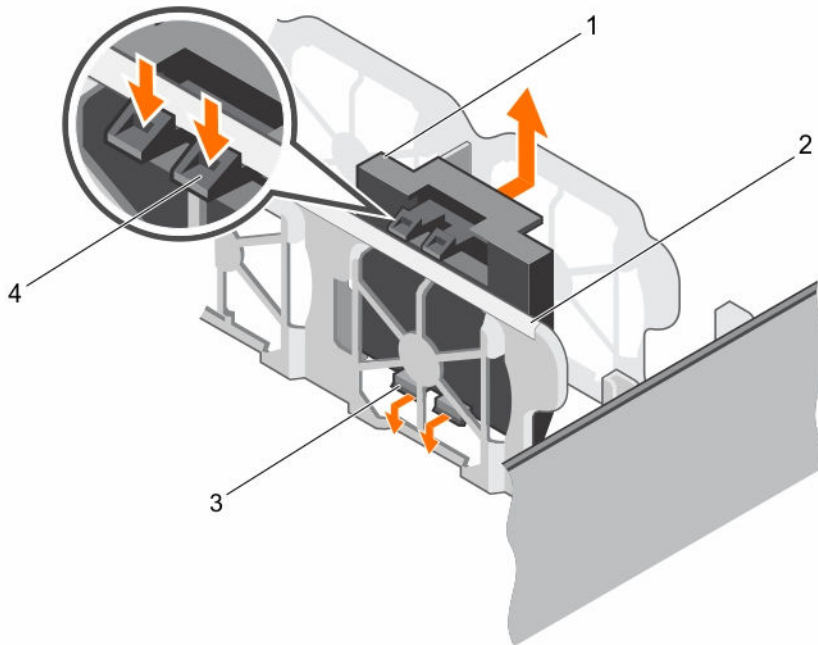

Figure 30. Removing and installing a cooling fan blank

- | | |
|--------------------------|--------------------|
| 1. cooling fan blank (2) | 2. release tab (2) |
| 3. cooling fan bracket | 4. tab |

Next steps

1. Install the cooling fan.
2. Follow the procedure listed in [After working inside your system](#).

Related Tasks

[Installing a cooling fan](#)

[Installing the cooling fan blank](#)

Installing the cooling fan blank

Prerequisites

CAUTION: Many repairs may only be done by a certified service technician. You should only perform troubleshooting and simple repairs as authorized in your product documentation, or as directed by the online or telephone service and support team. Damage due to servicing that is not authorized by Dell is not covered by your warranty. Read and follow the safety instructions that came with the product.

NOTE: The procedure for removing each cooling fan blank is identical.

1. Ensure that you follow the [Safety instructions](#).
2. Follow the procedure listed in [Before working inside your system](#).

Steps

1. Lower the cooling fan blank into the cooling fan bracket.
2. Insert the tabs on the cooling fan blanks into the slots on the cooling fan bracket.
3. Press the cooling fan blank until it clicks into place.

Next steps

Follow the procedure listed in [After working inside your system](#).

Removing a cooling fan

Prerequisites



CAUTION: Many repairs may only be done by a certified service technician. You should only perform troubleshooting and simple repairs as authorized in your product documentation, or as directed by the online or telephone service and support team. Damage due to servicing that is not authorized by Dell is not covered by your warranty. Read and follow the safety instructions that came with the product.



NOTE: The procedure for removing each fan is identical.

1. Ensure that you follow the [Safety instructions](#).
2. Follow the procedure listed in [Before working inside your system](#).
3. If required, remove the cooling shroud.

Steps

1. Disconnect the power cable from the power connector on the system board by pressing the sides of the power cable.
2. Lift the fan out of the cooling fan bracket.

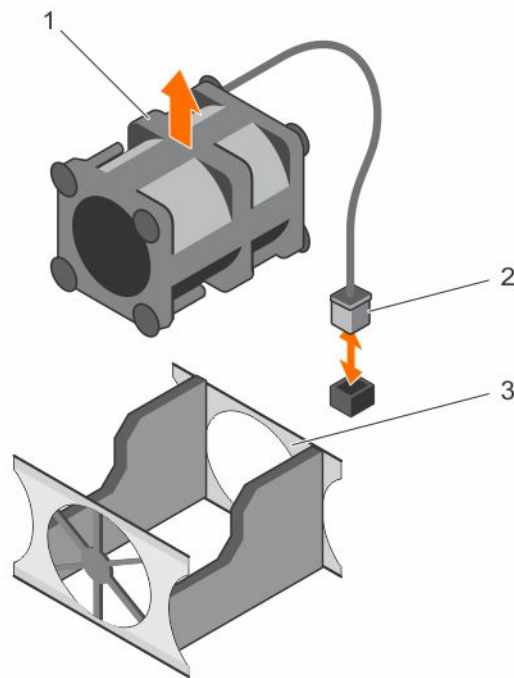

Figure 31. Removing and installing a cooling fan

- | | |
|------------------------|--------------------------|
| 1. cooling fan | 2. power cable connector |
| 3. cooling fan bracket | |

Next steps

1. Install the cooling fan.
2. Follow the procedure listed in [After working inside your system](#).

Related Tasks

- [Removing the cooling shroud](#)
- [Installing a cooling fan](#)

Installing a cooling fan

Prerequisites

CAUTION: Many repairs may only be done by a certified service technician. You should only perform troubleshooting and simple repairs as authorized in your product documentation, or as directed by the online or telephone service and support team. Damage due to servicing that is not authorized by Dell is not covered by your warranty. Read and follow the safety instructions that came with the product.

NOTE: The procedure for installing each fan is identical.

1. Ensure that you follow the [Safety instructions](#).
2. Follow the procedure listed in [Before working inside your system](#).

3. If installed, remove the cooling fan blank.
4. If required, remove the cooling shroud.

Steps

1. Lower the fan into the cooling fan bracket.
2. Connect the power cable to the power cable connector on the system board.

Next steps

1. Install the cooling shroud.
2. Follow the procedure listed in [After working inside your system](#).

Related Tasks

[Removing the cooling fan blank](#)

[Removing the cooling shroud](#)

[Installing the cooling shroud](#)

Internal USB memory key (optional)

The USB memory key installed inside your system can be used as a boot device, security key, or mass storage device.

To boot from the USB memory key, configure the USB memory key with a boot image and then specify the USB memory key in the boot sequence in System Setup.

The internal USB connector is located on the system board.

Related References

[System board connectors](#)

Replacing the optional internal USB memory key

Prerequisites



CAUTION: Many repairs may only be done by a certified service technician. You should only perform troubleshooting and simple repairs as authorized in your product documentation, or as directed by the online or telephone service and support team. Damage due to servicing that is not authorized by Dell is not covered by your warranty. Read and follow the safety instructions that came with the product.

1. Ensure that you follow the [Safety instructions](#).
2. Follow the procedure listed in [Before working inside your system](#).
3. Remove the expansion card riser.

Steps

1. Locate the USB connector or USB key on the system board.
To locate the USB connector, see [System board connectors](#).
2. If installed, remove the USB key from the USB connector.
3. Insert the replacement USB key into the USB connector.

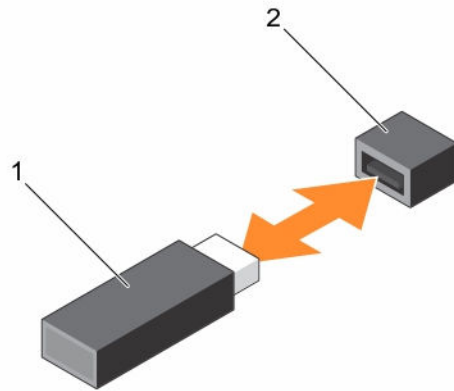

Figure 32. Replacing the internal USB key

1. USB memory key
2. USB memory key connector

Next steps

1. Install the expansion card riser.
2. Follow the procedure listed in [After working inside your system](#).
3. While booting, press F2 to enter System Setup and verify that the system detects the USB key.

Related Tasks

[Removing the expansion card riser](#)

[Installing the expansion card riser](#)

Expansion cards and expansion card riser

 **NOTE:** A System Event Log (SEL) is logged if an expansion card riser is unsupported or missing. It does not prevent your system from turning on and no BIOS POST message or F1/F2 pause is displayed.

 **NOTE:** The expansion card riser is optional for systems with four hard drives.

Expansion card installation guidelines

Your system supports PCIe Express Generation 3 cards. The following table provides riser configurations for R330 systems:

Table 14. Expansion card slots available on the expansion card riser

| PCIe slot on the expansion card riser | Height | Length | Link width | Slot width |
|---------------------------------------|-------------|-------------|------------|------------|
| LP SLOT 1 | Half Height | Half Length | x4 | x8 |
| FH SLOT 2 | Full Height | Half Length | x8 | x16 |

Table 15. Expansion card slots available on the system board

| PCIe slot on the system board | Height | Length | Link width | Slot width |
|-------------------------------|-------------|-------------|------------|------------|
| PCIE_G3_X4 | Half Height | Half Length | x4 | x8 |

 **NOTE:** The expansion cards are not hot-swappable.

The following table provides a guide for installing expansion cards to ensure proper cooling and mechanical fit. The expansion cards with the highest priority must be installed first using the slot priority indicated. All other expansion cards must be installed in card priority and slot priority order.

Table 16. Expansion card installation order

| Card priority | Card type | | Slot priority | Maximum allowed |
|---------------|------------|--|--------------------|-----------------|
| 1 | RAID | PowerEdge RAID Controller (PERC) H730 and H330 | Internal PERC slot | 1 |
| | | PERC H830 Full Height | 2 | 1 |
| | | PERC H830 Low Profile | 1 | 1 |
| 2 | 10 Gb NICs | Intel and Broadcom Dual Port | 2 | 1 |
| | | Intel and Broadcom Dual Port Low Profile | 1 | 1 |
| 3 | FC8 HBA | Qlogic QLE2562, Qlogic QLE2560, Emulex LPE12002, Emulex LPE12000, Emulex LPE15000, and Emulex LPE15002 | 2 | 1 |

| Card priority | Card type | | Slot priority | Maximum allowed |
|---------------|-----------|--|---------------|-----------------|
| | | Qlogic QLE2562, Qlogic QLE2560, Emulex LPE12002, Emulex LPE12000, Emulex LPE15000, and Emulex LPE15002 Low Profile | 1 | 1 |
| 4 | 1 Gb NICs | Intel and Broadcom Dual and Quad Port | 2 | 1 |
| | | Intel and Broadcom Dual and Quad Port Low Profile | 1 | 1 |
| 5 | Non-RAID | 12GB SAS HBA Full Height | 2 | 1 |
| | | 12GB SAS HBA Low Profile | 1 | 1 |

Removing the expansion card riser

Prerequisites



CAUTION: Many repairs may only be done by a certified service technician. You should only perform troubleshooting and simple repairs as authorized in your product documentation, or as directed by the online or telephone service and support team. Damage due to servicing that is not authorized by Dell is not covered by your warranty. Read and follow the safety instructions that came with the product.

1. Ensure that you follow the [Safety instructions](#).
2. Follow the procedure listed in [Before working inside your system](#).

Steps

1. Lift and rotate the expansion card riser latch to open it.
2. Holding the touch points, lift the expansion card riser from the riser connector on the system board.

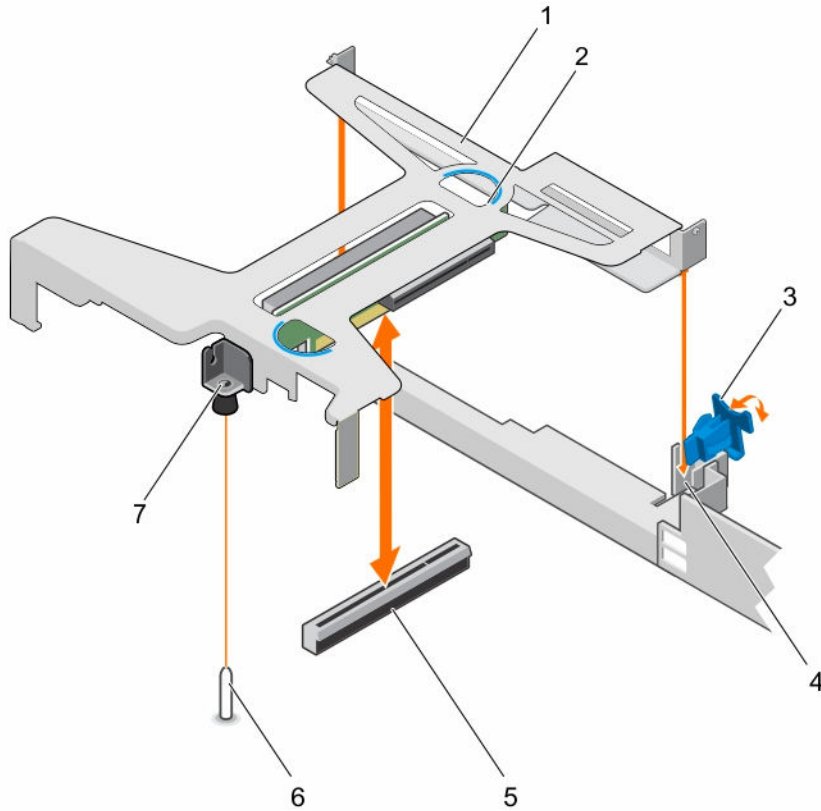

Figure 33. Removing and installing the expansion card riser

- | | |
|---|----------------------------------|
| 1. expansion card riser | 2. touch point (2) |
| 3. expansion card latch | 4. guide slot on the chassis |
| 5. riser connector on the system board | 6. guide pin on the system board |
| 7. guide slot on the expansion card riser | |

Next steps

Install the expansion card riser.

Related Tasks

[Installing the expansion card riser](#)

Installing the expansion card riser

Prerequisites

CAUTION: Many repairs may only be done by a certified service technician. You should only perform troubleshooting and simple repairs as authorized in your product documentation, or as directed by the online or telephone service and support team. Damage due to servicing that is not authorized by Dell is not covered by your warranty. Read and follow the safety instructions that came with the product.

1. Ensure that you follow the [Safety instructions](#).
2. Install the expansion card into the expansion card riser.

Steps

1. Open the expansion card riser latch.
2. Align the following:
 - a. Guide on the expansion card riser with the guide pin on the system board.
 - b. Expansion card riser connector with the connector on the system board.
3. Lower the expansion card riser until the expansion card riser is firmly seated in the connector on the system board.
4. Close the expansion card riser latch.

Next steps

Follow the procedure listed in [After working inside your system](#).

Related Tasks

[Installing an expansion card](#)

Removing an expansion card

Prerequisites



CAUTION: Many repairs may only be done by a certified service technician. You should only perform troubleshooting and simple repairs as authorized in your product documentation, or as directed by the online or telephone service and support team. Damage due to servicing that is not authorized by Dell is not covered by your warranty. Read and follow the safety instructions that came with the product.

1. Ensure that you follow the [Safety instructions](#).
2. Follow the procedure listed in [Before working inside your system](#).
3. Disconnect any cables connected to the expansion card or expansion card riser.
4. If installed, remove the expansion card riser.

Steps

1. Hold the expansion card by its edges and remove it from the expansion card riser connector.
2. If you are removing the card permanently, install a filler bracket in the empty expansion card slot and close the expansion card latch.



NOTE: You must install a filler bracket over an empty expansion card slot to maintain Federal Communications Commission (FCC) certification of the system. The brackets also keep dust and dirt out of the system and aid in proper cooling and airflow inside the system.

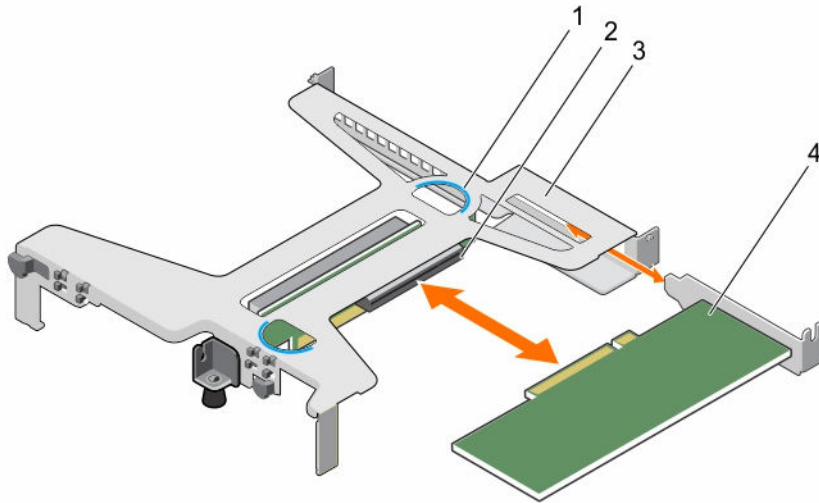

Figure 34. Removing and installing the expansion card from the expansion card riser

- | | |
|-------------------------|-----------------------------------|
| 1. touch point (2) | 2. expansion card riser connector |
| 3. expansion card riser | 4. expansion card |

Next steps

1. Install the filler bracket or expansion card, if applicable.
2. Install the expansion card riser
3. Follow the procedure listed in [After working inside your system](#).

Related Tasks

- [Installing an expansion card](#)
- [Removing the expansion card riser](#)
- [Installing the expansion card riser](#)

Installing an expansion card

Prerequisites

⚠ CAUTION: Many repairs may only be done by a certified service technician. You should only perform troubleshooting and simple repairs as authorized in your product documentation, or as directed by the online or telephone service and support team. Damage due to servicing that is not authorized by Dell is not covered by your warranty. Read and follow the safety instructions that came with the product.

1. Ensure that you follow the [Safety instructions](#).
2. Follow the procedure listed in [Before working inside your system](#).
3. Remove the expansion card riser.
4. If installed, remove the filler bracket.

Steps

1. Locate the expansion card connector on the riser.
2. Holding the expansion card by its edges, position the card so that the card connector aligns with the connector on the expansion card riser.

3. Insert the card connector into the expansion card riser connector until the card is firmly seated.
4. If required, connect the cables to the expansion card.

Next steps

1. Install the expansion card riser.
2. Follow the procedure listed in [After working inside your system](#).

Related Tasks

[Removing the expansion card riser](#)

[Installing the expansion card riser](#)

Removing the internal PERC card

Prerequisites

⚠ CAUTION: Many repairs may only be done by a certified service technician. You should only perform troubleshooting and simple repairs as authorized in your product documentation, or as directed by the online or telephone service and support team. Damage due to servicing that is not authorized by Dell is not covered by your warranty. Read and follow the safety instructions that came with the product.

1. Ensure that you follow the [Safety instructions](#).
2. Follow the procedure listed in [Before working inside your system](#).
3. Remove the expansion card riser.
4. Keep the Phillips #2 screwdriver ready.

Steps

1. Remove the screw from the PERC card lock.
2. Turn the PERC card lock to disengage the lock from the PERC card.
3. Push the PERC card lock until the tab on the PERC card lock clicks into the slot on the chassis.

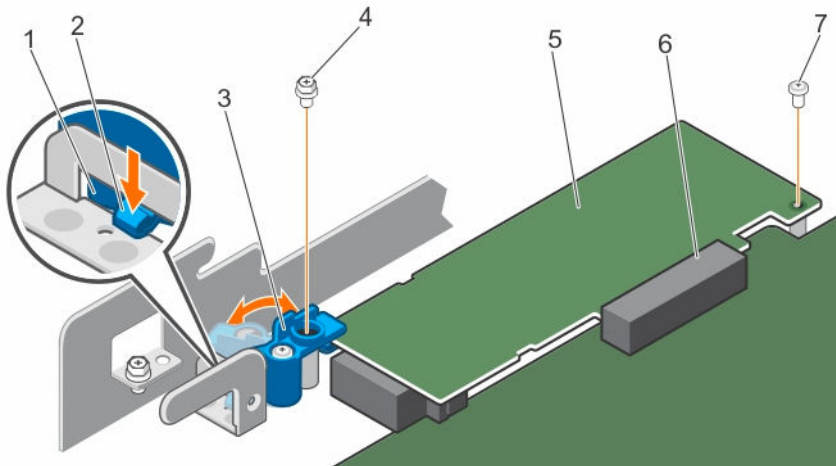

Figure 35. Opening and closing the PERC card lock

- | | |
|------------------------|--------------------------------|
| 1. slot on the chassis | 2. tab on the PERC card lock |
| 3. PERC card lock | 4. screw on the PERC card lock |

5. PERC card
 6. PERC card slot
 7. screw securing the PERC card to the chassis
4. Remove the screw that secures the PERC card to the chassis.
 5. Disconnect the PERC card LED cable from the system board.
 6. Hold the PERC card by the edges and pull the PERC card to disengage it from the PERC card slot.
 7. Lift the PERC card away from the chassis.

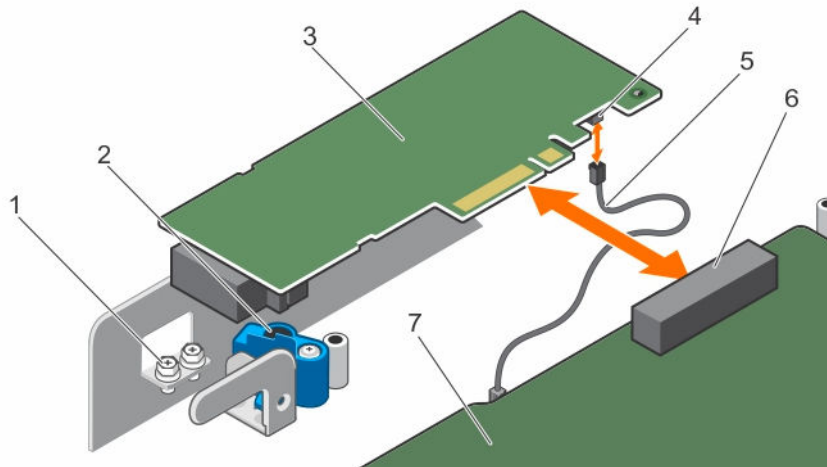

Figure 36. Removing and installing the internal PERC card

1. screw (2)
2. PERC card lock
3. PERC card
4. LED cable connector on the PERC card
5. PERC card LED cable
6. PERC card connector
7. LED cable connector on the system board

Next steps

1. Install the internal PERC card.
2. Install the expansion card riser.
3. Follow the procedure listed in [After working inside your system](#).

Related Tasks

- [Removing the expansion card riser](#)
- [Installing the expansion card riser](#)
- [Installing the internal PERC card](#)

Installing the internal PERC card

Prerequisites

1. Ensure that you follow the [Safety instructions](#).
2. Follow the procedure listed in [Before working inside your system](#).
3. Remove the expansion card riser.
4. Keep the Phillips #2 screwdriver ready.

Steps

1. Connect the PERC LED cable to the LED cable connector on the PERC card.
2. Insert the PERC card in the PERC card slot.
3. Press and slide the tab on the PERC card lock to disengage it from the slot on the chassis.
4. Turn the internal PERC card lock to engage it with the PERC card.
5. Install the first screw to secure the PERC card lock to the PERC card.
6. Install the second screw to secure the PERC card to the chassis.



NOTE: Use the two screws supplied with the system to secure the PERC card to the PERC card lock and the chassis

7. Connect the PERC LED cable to the LED cable connector on the system board.

Next steps

1. Install the expansion card riser.
2. Follow the procedure listed in [After working inside your system](#).

Related Tasks

[Removing the expansion card riser](#)

[Installing the expansion card riser](#)

iDRAC port card (optional)

The iDRAC port card consists of the SD vFlash card slot and an iDRAC port. The iDRAC port card features a dedicated NIC port and is used for remote, advanced management of the system through the network. An SD vFlash card is a Secure Digital (SD) card that plugs into the SD vFlash card slot in the iDRAC port card. It provides persistent on-demand local storage and a custom deployment environment that enables automation of server configuration, scripts, and imaging. It emulates a USB device. For more information, see the Integrated Dell Remote Access Controller User's Guide at Dell.com/idracmanuals.

Replacing an optional SD vFlash card

1. Locate the SD vFlash card slot at the back of the chassis.
2. To remove the SD vFlash card, push the SD vFlash card inward to release it, and pull the SD vFlash card from the SD vFlash card slot.

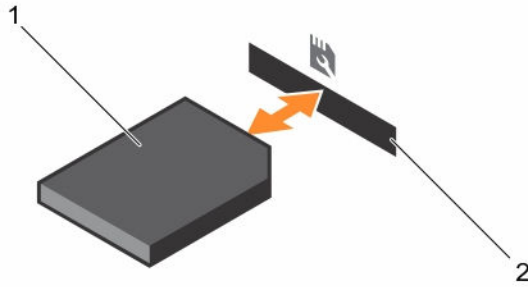



Figure 37. Removing and installing the SD vFlash card

1. SD vFlash card
 2. SD vFlash card slot
 3. Install a replacement SD vFlash card by inserting the contact-pin end of the SD vFlash card into the SD vFlash card slot on the module.
-  **NOTE:** The slot is keyed to ensure correct insertion of the SD vFlash card.
4. Press the SD vFlash card inward to lock it into the SD vFlash card slot.

Removing the optional iDRAC port card

Prerequisites

 **CAUTION:** Many repairs may only be done by a certified service technician. You should only perform troubleshooting and simple repairs as authorized in your product documentation, or as directed by the online or telephone service and support team. Damage due to servicing that is not authorized by Dell is not covered by your warranty. Read and follow the safety instructions that came with the product.

1. Ensure that you follow the [Safety instructions](#).
2. Follow the procedure listed in [Before working inside your system](#).
3. Keep the Phillips #2 screwdriver ready.
4. If connected, disconnect the network cable from the iDRAC port card.
5. Remove the cooling shroud.

Steps

1. Loosen the screw securing the iDRAC port card holder to the system board.
2. Pull the iDRAC port card to disengage it from the iDRAC port card connector on the system board, and remove the card from the chassis.

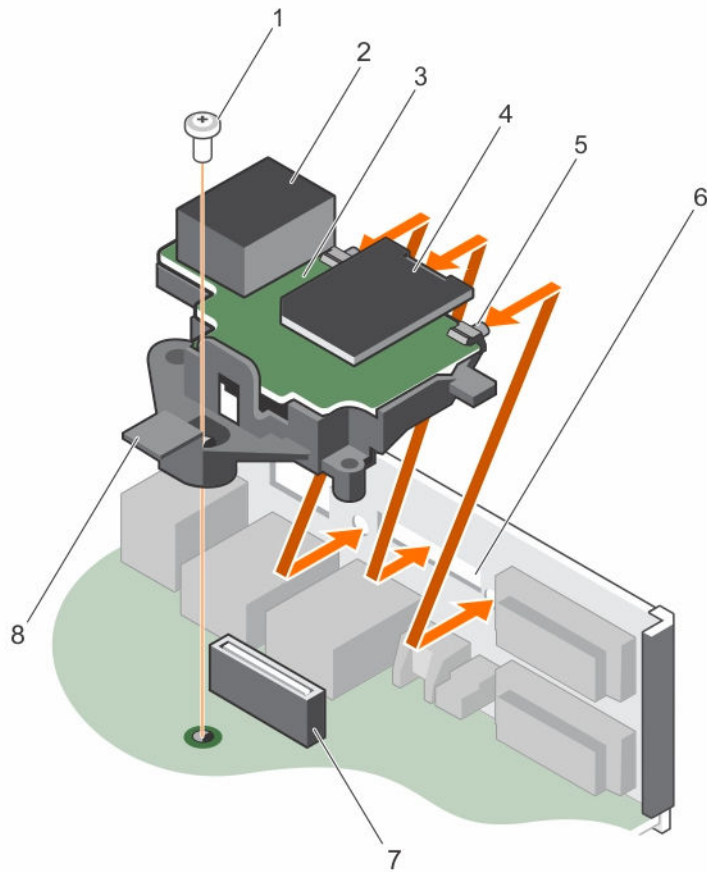

Figure 38. Removing and installing the iDRAC port card

- | | |
|------------------------------|------------------------------|
| 1. screw | 2. iDRAC port |
| 3. iDRAC port card board | 4. SD vFlash media card slot |
| 5. tabs on the iDRAC port | 6. slots on the chassis |
| 7. iDRAC port card connector | 8. iDRAC port card holder |

Next steps

1. Install the iDRAC port card.
2. Install the cooling shroud.
3. If disconnected, reconnect the network cable.
4. Follow the procedure listed in [After working inside your system](#).

Related Tasks

- [Removing the cooling shroud](#)
- [Installing the optional iDRAC port card](#)
- [Installing the cooling shroud](#)

Installing the optional iDRAC port card

Prerequisites

 **CAUTION:** Many repairs may only be done by a certified service technician. You should only perform troubleshooting and simple repairs as authorized in your product documentation, or as directed by the online or telephone service and support team. Damage due to servicing that is not authorized by Dell is not covered by your warranty. Read and follow the safety instructions that came with the product.

1. Ensure that you follow the [Safety instructions](#).
2. Follow the procedure listed in [Before working inside your system](#).
3. Keep the Phillips #2 screwdriver ready.
4. Remove the cooling shroud.

Steps

1. Align and insert the tabs on the iDRAC port card into the slots on the chassis.
2. Insert the iDRAC port card into the connector on the system board.
3. Tighten the screw that secures the iDRAC port card holder to the system board.

Next steps

1. Install the cooling shroud.
2. If disconnected, reconnect the network cable.
3. Follow the procedure listed in [After working inside your system](#).

Related Tasks

[Removing the cooling shroud](#)

[Installing the cooling shroud](#)

Internal dual SD module (optional)

The Internal Dual SD Module (IDSMD) card provides two SD card slots. This card offers the following features:

- Dual card operation — maintains a mirrored configuration by using SD cards in both the slots and provides redundancy.
 -  **NOTE:** When the **Redundancy** option is set to **Mirror Mode** in the **Integrated Devices** screen of System Setup, the information is replicated from one SD card to another.
- Single card operation — single card operation is supported, but without redundancy.

Removing an optional internal SD card

Prerequisites

1. Ensure that you follow the [Safety instructions](#).
2. Follow the procedure listed in [Before working inside your system](#).

 **CAUTION:** Many repairs may only be done by a certified service technician. You should only perform troubleshooting and simple repairs as authorized in your product documentation, or as directed by the online or telephone service and support team. Damage due to servicing that is not authorized by Dell is not covered by your warranty. Read and follow the safety instructions that came with the product.

Steps

Locate the SD card slot on the Internal Dual SD Module (IDSMD) and press the SD card to release it from the slot.

 **NOTE:** Temporarily label each SD card with its corresponding slot number before removal. Re-install the SD card(s) into the corresponding slots.

Next steps

1. Installing an internal SD card.
2. Follow the procedure listed in [After working inside your system](#).

Related Tasks

[Installing an optional internal SD card](#)

Installing an optional internal SD card

Prerequisites

1. Ensure that you follow the [Safety instructions](#).
2. Follow the procedure listed in [Before working inside your system](#).
3. Ensure that the **Internal SD Card Port** option is set to enabled in System Setup.

 **CAUTION:** Many repairs may only be done by a certified service technician. You should only perform troubleshooting and simple repairs as authorized in your product documentation, or as directed by the online or telephone service and support team. Damage due to servicing that is not authorized by Dell is not covered by your warranty. Read and follow the safety instructions that came with the product.

Steps

1. Locate the SD card connector on the Internal Dual SD Module (IDSMD).
2. Orient the SD card appropriately and insert the contact-pin end of the card into the slot.

 **NOTE:** The slot is keyed to ensure correct insertion of the card.

3. Press the card into the card slot to lock it into place.

Next steps

Follow the procedure listed in [After working inside your system](#).

Removing the optional internal dual SD module

Prerequisites

 **CAUTION:** Many repairs may only be done by a certified service technician. You should only perform troubleshooting and simple repairs as authorized in your product documentation, or as directed by the online or telephone service and support team. Damage due to servicing that is not authorized by Dell is not covered by your warranty. Read and follow the safety instructions that came with the product.

1. Ensure that you follow the [Safety instructions](#).
2. Follow the procedure listed in [Before working inside your system](#).
3. Locate the Internal Dual SD Module (IDSDM) on the system board.
4. If installed, remove the SD card(s).

Steps

Hold the pull tab and pull the IDSDM out of the chassis.

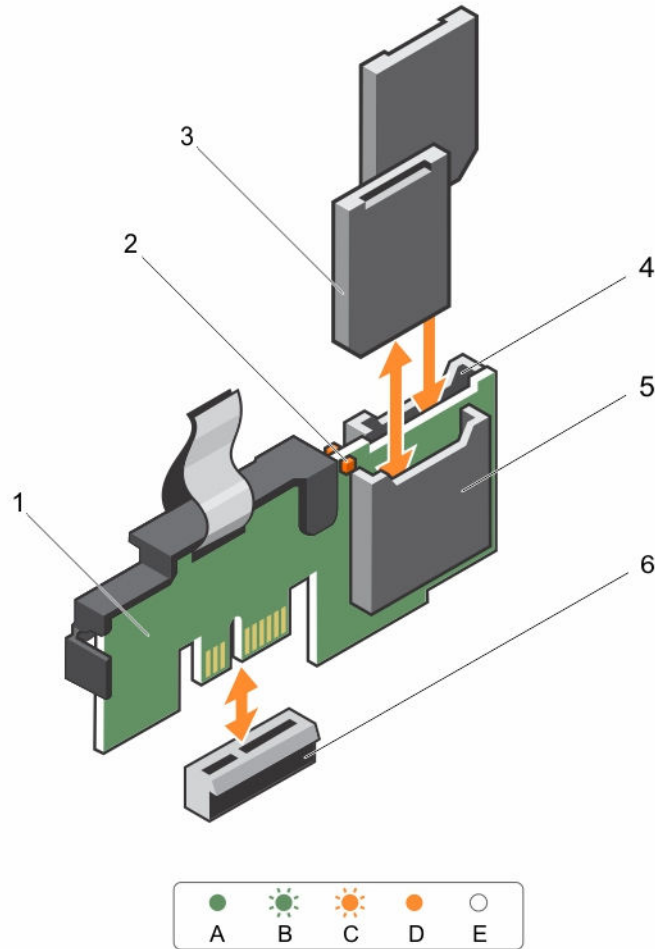

Figure 39. Removing and installing the Internal Dual SD Module (IDSDM)

- | | |
|----------------------------|-----------------------------|
| 1. Internal Dual SD module | 2. LED status indicator (2) |
| 3. SD card (2) | 4. SD card slot 2 |
| 5. SD card slot 1 | 6. IDSDM connector |

The following table describes the IDSDM indicator codes:

Table 17. IDSDM indicator codes

| Convention | IDSDM indicator code | Description |
|------------|----------------------|--|
| A | Green | Indicates that the card is online. |
| B | Flashing green | Indicates rebuild or activity. |
| C | Flashing amber | Indicates card mismatch or that the card has failed. |
| D | Amber | Indicates that the card is offline, has failed, or is write protected. |
| E | Not lit | Indicates that the card is missing or is booting. |

Next steps

1. Installing the dual SD module.
2. Follow the procedure listed in [After working inside your system](#).

Related Tasks

- [Removing an optional internal SD card](#)
- [Installing an optional internal SD card](#)
- [Installing the optional internal dual SD module](#)

Installing the optional internal dual SD module

Prerequisites

 **CAUTION:** Many repairs may only be done by a certified service technician. You should only perform troubleshooting and simple repairs as authorized in your product documentation, or as directed by the online or telephone service and support team. Damage due to servicing that is not authorized by Dell is not covered by your warranty. Read and follow the safety instructions that came with the product.

1. Ensure that you follow the [Safety instructions](#).
2. Follow the procedure listed in [Before working inside your system](#).

Steps

1. Locate the Internal Dual SD Module (IDSDM) connector on the system board. To locate the internal dual SD module connector, see [System board connectors](#).
2. Align the IDSDM with the connector on the system board.
3. Push the IDSDM until it is firmly seated on the system board.

Next steps

1. Install the SD card(s).
 -  **NOTE:** Temporarily label each SD card with its corresponding slot before removal. Replace the SD card(s) into the same slots.
2. Follow the procedure listed in [After working inside your system](#).

Related Tasks

- [Installing an optional internal SD card](#)

Heat sink and processor

Removing the heat sink

Prerequisites

 **CAUTION:** Many repairs may only be done by a certified service technician. You should only perform troubleshooting and simple repairs as authorized in your product documentation, or as directed by the online or telephone service and support team. Damage due to servicing that is not authorized by Dell is not covered by your warranty. Read and follow the safety instructions that came with the product.

 **CAUTION:** Never remove the heat sink from a processor unless you intend to remove the processor. The heat sink is necessary to maintain proper thermal conditions.

 **NOTE:** This is a Field Replaceable Unit (FRU). Removal and installation procedures should be performed only by Dell certified service technicians.

1. Ensure that you follow the [Safety instructions](#).
2. Keep the Phillips #2 screwdriver ready.
3. Follow the procedure listed in [Before working inside your system](#).
4. Remove the cooling shroud.

 **WARNING:** The heat sink and processor are hot to the touch for some time after the system has been powered down. Allow the heat sink and processor to cool before handling them.

Steps

1. Loosen one of the screws that secure the heat sink to the system board.
Allow some time (around 30 seconds) for the heat sink to loosen from the processor.
2. Loosen the screw that is diagonally opposite the screw you first removed.
3. Repeat the procedure for the remaining two screws.
4. Lift the heat sink away from the system.

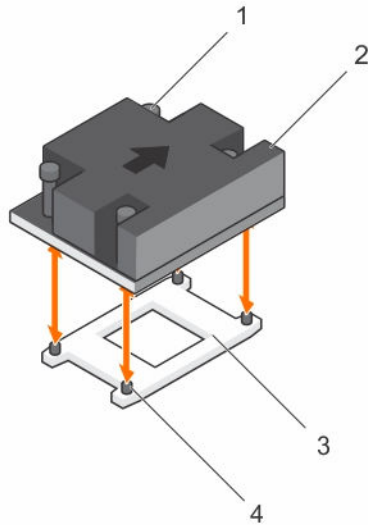

Figure 40. Removing and installing a heat sink

- | | |
|----------------------|--------------|
| 1. captive screw (4) | 2. heat sink |
| 3. processor socket | 4. slot (4) |

Next steps

1. If you are removing only a faulty heat sink, install the replacement heat sink, if not, remove the processor.
2. Follow the procedure listed in [After working inside your system](#).

Related Tasks

- [Removing the cooling shroud](#)
- [Installing the processor](#)
- [Installing the cooling shroud](#)
- [Installing the heat sink](#)

Removing the processor

Prerequisites

CAUTION: Many repairs may only be done by a certified service technician. You should only perform troubleshooting and simple repairs as authorized in your product documentation, or as directed by the online or telephone service and support team. Damage due to servicing that is not authorized by Dell is not covered by your warranty. Read and follow the safety instructions that came with the product.

NOTE: This is a Field Replaceable Unit (FRU). Removal and installation procedures should be performed only by Dell certified service technicians.

1. Ensure that you follow the [Safety instructions](#).
2. Keep the Phillips #2 screwdriver ready.
3. If you are upgrading your system, download the latest system BIOS version from [Dell.com/support](#) and follow the instructions included in the compressed download file to install the update on your system.

 **NOTE:** You can update the system BIOS by using the Dell Lifecycle Controller.

4. Follow the procedure listed in [Before working inside your system](#).
5. Remove the cooling shroud.
6. Remove the heat sink.

 **WARNING:** The processor will be hot to touch for some time after the system has been powered down. Allow the processor to cool before removing it.

 **CAUTION:** The processor is held in its socket under strong pressure. Be aware that the release lever can spring up suddenly if not firmly held.

Steps

1. Release the socket lever by pushing the lever down and out from under the tab on the processor shield.
2. Lift the lever upward until the processor shield lifts.

 **CAUTION:** The processor socket pins are fragile and can be permanently damaged. Be careful not to bend the pins in the processor socket when removing the processor out of the socket.

3. Lift the processor out of the socket.

 **NOTE:** After removing the processor, place it in an antistatic container for reuse, return, or temporary storage. Do not touch the bottom of the processor to avoid damage to the processor contacts. Touch only the side edges of the processor.

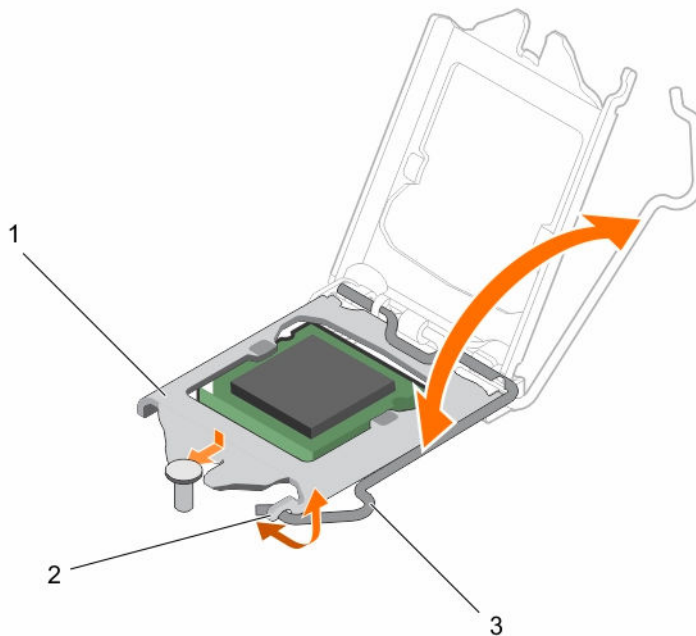

Figure 41. Opening and closing the processor shield

1. processor shield
2. tab on the processor shield
3. socket lever

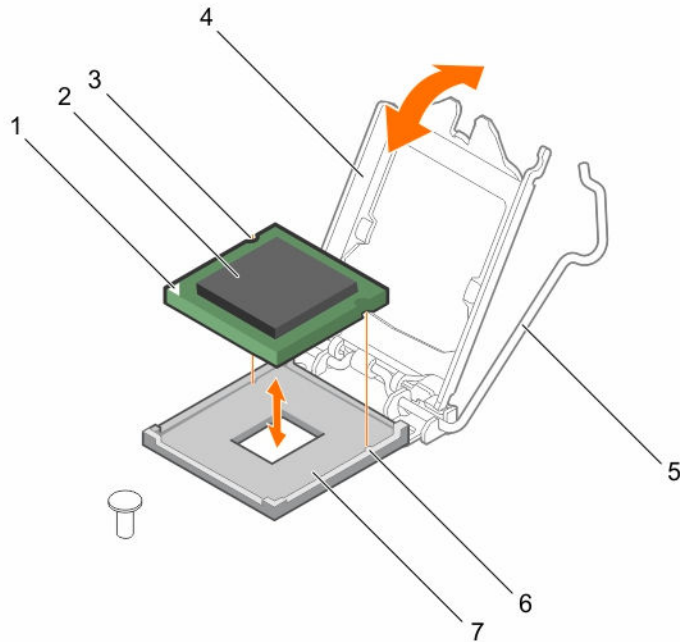

Figure 42. Removing and installing a processor

- | | |
|---------------------------------|---------------------|
| 1. pin-1 indicator of processor | 2. processor |
| 3. slot (2) | 4. processor shield |
| 5. socket lever | 6. socket keys (2) |
| 7. socket | |

Next steps

1. Replace the processor.
2. Follow the procedure listed in [After working inside your system](#).

Related Tasks

- [Removing the cooling shroud](#)
- [Removing the heat sink](#)
- [Installing the processor](#)
- [Installing the heat sink](#)
- [Installing the cooling shroud](#)

Installing the processor

Prerequisites

- ⚠ CAUTION:** Many repairs may only be done by a certified service technician. You should only perform troubleshooting and simple repairs as authorized in your product documentation, or as directed by the online or telephone service and support team. Damage due to servicing that is not authorized by Dell is not covered by your warranty. Read and follow the safety instructions that came with the product.

 **NOTE:** This is a Field Replaceable Unit (FRU). Removal and installation procedures should be performed only by Dell certified service technicians.

1. Ensure that you follow the [Safety instructions](#).
2. If you are upgrading your system, download the latest system BIOS version from [Dell.com/support](https://www.dell.com/support) and follow the instructions included in the compressed download file to install the update on your system.

 **NOTE:** You can update the system BIOS by using the Dell Lifecycle Controller.

3. Follow the procedure listed in [Before working inside your system](#).
4. Remove the cooling shroud.

Steps

1. Unpack the new processor.

If the processor has previously been used in a system, remove any remaining thermal grease from the processor by using a lint free cloth.

2. Locate the processor socket.

 **CAUTION:** While removing or reinstalling the processor, wipe your hands of any contaminants. Contaminants on the processor contacts such as thermal grease or oil can damage the processor.

3. Align the processor with the socket keys.

 **CAUTION:** Do not use force to seat the processor. When the processor is positioned correctly, it engages easily into the socket.

 **CAUTION:** Positioning the processor incorrectly can permanently damage the system board or the processor. Be careful not to bend the pins in the socket.

4. Align the pin-1 indicator of the processor with the triangle on the socket.
5. Place the processor on the socket such that the slots on the processor align with the socket keys.
6. Close the processor shield by sliding it under the retention screw.
7. Lower the socket lever and push it under the tab to lock it.

Next steps

 **NOTE:** Ensure that you install the heat sink after you install the processor. The heat sink is necessary to maintain proper thermal conditions.

1. Install the heat sink.
2. Follow the procedure listed in [After working inside your system](#).
3. While booting, press F2 to enter System Setup and check that the processor information matches the new system configuration.
4. Run the system diagnostics to verify that the new processor operates correctly.

Related Tasks

[Removing the cooling shroud](#)

[Installing the heat sink](#)

[Installing the cooling shroud](#)

Installing the heat sink

Prerequisites

 **CAUTION:** Many repairs may only be done by a certified service technician. You should only perform troubleshooting and simple repairs as authorized in your product documentation, or as directed by the online or telephone service and support team. Damage due to servicing that is not authorized by Dell is not covered by your warranty. Read and follow the safety instructions that came with the product.

 **NOTE:** This is a Field Replaceable Unit (FRU). Removal and installation procedures should be performed only by Dell certified service technicians.

1. Ensure that you follow the [Safety instructions](#).
2. Keep the Phillips #2 screwdriver ready.
3. Follow the procedure listed in [Before working inside your system](#).
4. Remove the cooling shroud.
5. Install the processor.

Steps

1. If you are using an existing heat sink, remove the thermal grease from the heat sink by using a clean lint free cloth.
2. Use the thermal grease syringe included with your processor kit to apply the grease in a thin spiral on the top of the processor as shown in the following figure.

 **CAUTION:** Applying too much thermal grease can result in excess grease coming in contact with and contaminating the processor socket.

 **NOTE:** The thermal grease syringe is intended for one-time use only. Dispose of the syringe after you use it.

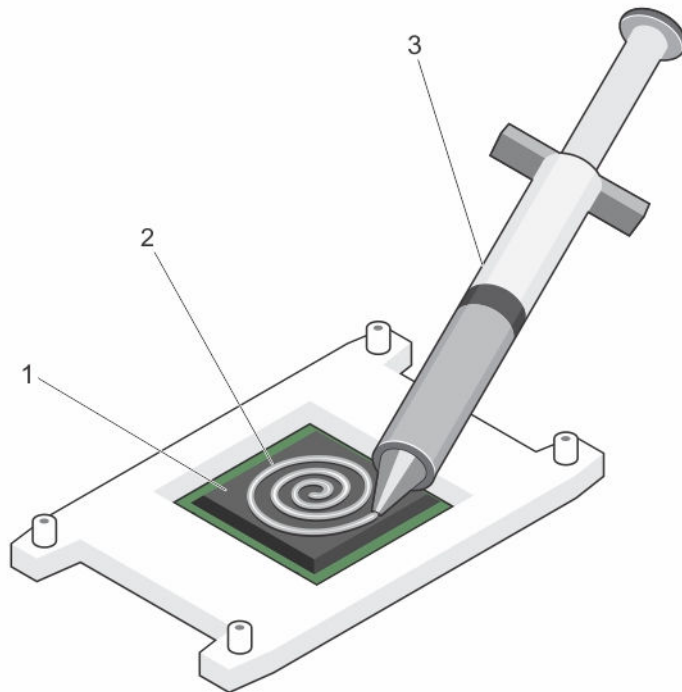



Figure 43. Applying thermal grease on the top of the processor

1. processor
 2. thermal grease
 3. thermal grease syringe
3. Place the heat sink onto the processor.
 4. Tighten one of the four screws to secure the heat sink to the system board.
 5. Tighten the screw diagonally opposite to the first screw you tightened.
-  **NOTE:** Do not overtighten the heat sink retention screws when installing the heat sink. To prevent overtightening, tighten the retention screw until resistance is felt. The screw tension must not be more than 6 in-lb (6.9 kg-cm).
6. Repeat the procedure for the remaining two screws.

Next steps

1. Install the cooling shroud.
2. Follow the procedure listed in [After working inside your system](#).
3. While booting, press F2 to enter System Setup and check that the processor information matches the new system configuration.
4. Run the system diagnostics to verify that the new processor operates correctly.

Related Tasks

- [Removing the cooling shroud](#)
- [Installing the processor](#)
- [Installing the cooling shroud](#)

Power supply units

Your system supports 350 W AC redundant power supply units (PSUs).

 **NOTE:** If two PSUs are used, they must be of the same type and have the same maximum output power.

When two identical PSUs are installed, the PSU configuration is redundant (1 + 1). In redundant mode, power is supplied to the system equally from both PSUs to maximize efficiency.

When only one PSU is installed, the PSU configuration is non-redundant (1 + 0). Power is supplied to the system only by the single PSU.

In a non-redundant configuration, install a PSU blank in the empty PSU slot.

Hot spare feature

Your system supports the hot spare feature that significantly reduces the power overhead associated with power supply redundancy.

When the hot spare feature is enabled, one of the redundant PSUs is switched to the sleep state. The active PSU supports 100% of the load, thus operating at higher efficiency. The PSU in the sleep state monitors output voltage of the active PSU. If the output voltage of the active PSU drops, the PSU in the sleep state returns to an active output state.

If having both PSUs active is more efficient than having one PSU in the sleep state, the active PSU can also activate the sleeping PSU.

The default PSU settings are as follows:

- If the load on the active PSU is more than 50%, then the redundant PSU is switched to the active state.
- If the load on the active PSU falls below 20%, then the redundant PSU is switched to the sleep state.

You can configure the hot spare feature by using the iDRAC settings. For more information about iDRAC settings, see the Integrated Dell Remote Access Controller User's Guide at Dell.com/idracmanuals.

Removing a redundant power supply unit

Prerequisites

 **CAUTION:** Many repairs may only be done by a certified service technician. You should only perform troubleshooting and simple repairs as authorized in your product documentation, or as directed by the online or telephone service and support team. Damage due to servicing that is not authorized by Dell is not covered by your warranty. Read and follow the safety instructions that came with the product.

 **CAUTION:** The system requires one power supply for normal operation. On power-redundant systems, remove and replace only one power supply at a time in a system that is powered on.

1. Ensure that you follow the [Safety instructions](#).
2. Disconnect the power cable from the power source.
3. Disconnect the power cable from the power supply unit (PSU) and remove the straps that bundle and secure the system cables.

- Unlatch and lift the optional cable management arm if it interferes with PSU removal. For information about the cable management arm, see the system's rack documentation.

Steps

Press the release latch and pull the PSU out of the chassis.

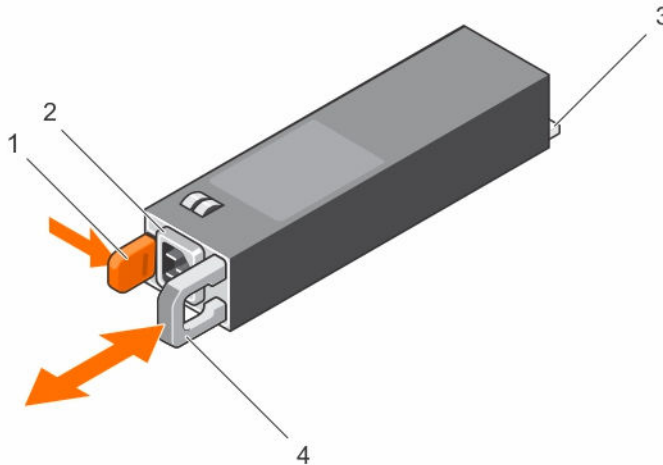

Figure 44. Removing and installing a redundant PSU

- | | |
|------------------|---------------------------|
| 1. release latch | 2. power supply connector |
| 3. connector | 4. power supply handle |

Next steps

- Install the power supply unit.
- If you are not immediately installing a power supply unit, install the power supply unit blank.

Related Tasks

[Installing a redundant power supply unit](#)

[Installing the power supply unit blank](#)

Installing a redundant power supply unit

Prerequisites

CAUTION: Many repairs may only be done by a certified service technician. You should only perform troubleshooting and simple repairs as authorized in your product documentation, or as directed by the online or telephone service and support team. Damage due to servicing that is not authorized by Dell is not covered by your warranty. Read and follow the safety instructions that came with the product.

- Ensure that you follow the [Safety instructions](#).
- Verify that both power supply units (PSUs) are of the same type and have the same maximum output power.

NOTE: The maximum output power (shown in Watts) is listed on the PSU label.

3. If installed, remove the PSU blank.

Steps

Slide the new PSU into the chassis until the PSU is fully seated and the release latch snaps into place.

Next steps

1. If you have unlatched the cable management arm, relatch it. For information about the cable management arm, see the rack documentation of the system.
2. Connect the power cable to the PSU and plug the cable into a power outlet.



CAUTION: When connecting the power cable, secure the cable with the strap.



NOTE: When installing, hot-swapping, or hot-adding a new PSU in a system with two PSUs, allow several seconds for the system to recognize the PSU and determine its status. The PSU status indicator turns green to signify that the PSU is functioning properly.

Related Tasks

[Removing the power supply unit blank](#)

Removing the power supply unit blank

Prerequisites

Ensure that you follow the [Safety instructions](#).

Steps

If you are installing a second power supply unit (PSU), remove the PSU blank in the bay by pulling the blank outward.



CAUTION: To ensure proper system cooling, the PSU blank must be installed in the second PSU bay in a non-redundant configuration. Remove the PSU blank only if you are installing a second PSU.

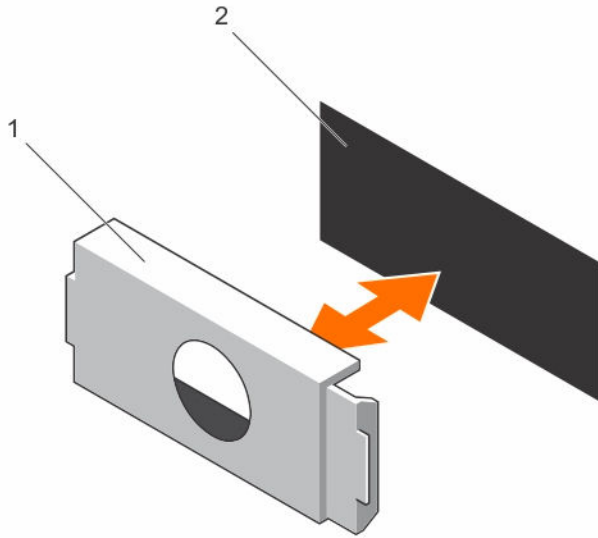

Figure 45. Removing and installing the PSU blank

1. PSU blank

2. PSU bay

Installing the power supply unit blank

Install the power supply unit (PSU) blank only in the second PSU bay.

Prerequisites

⚠ CAUTION: To ensure proper system cooling, the PSU blank must be installed in the second PSU bay in a non-redundant configuration. Remove the PSU blank only if you are installing a second PSU.

Steps

Align the PSU blank with the PSU bay, and push the PSU blank into the chassis until it clicks into place.

System battery

Replacing the system battery

Prerequisites

1. Ensure that you follow the [Safety instructions](#).
2. Follow the procedure listed in [Before working inside your system](#).
3. Remove the expansion card riser.
4. Keep the plastic scribe ready.

⚠ WARNING: There is a danger of a new battery exploding if it is incorrectly installed. Replace the battery only with the same or equivalent type recommended by the manufacturer. For more information, see the safety information that shipped with your system.

CAUTION: Many repairs may only be done by a certified service technician. You should only perform troubleshooting and simple repairs as authorized in your product documentation, or as directed by the online or telephone service and support team. Damage due to servicing that is not authorized by Dell is not covered by your warranty. Read and follow the safety instructions that came with the product.

NOTE: This is a Field Replaceable Unit (FRU). Removal and installation procedures must be performed only by Dell certified service technicians.

Steps

1. Locate the battery socket. For more information, see [System board connectors](#).

CAUTION: To avoid damage to the battery connector, you must firmly support the connector while installing or removing a battery.

2. Use a plastic scribe to pry out the system battery as shown in the following illustration:

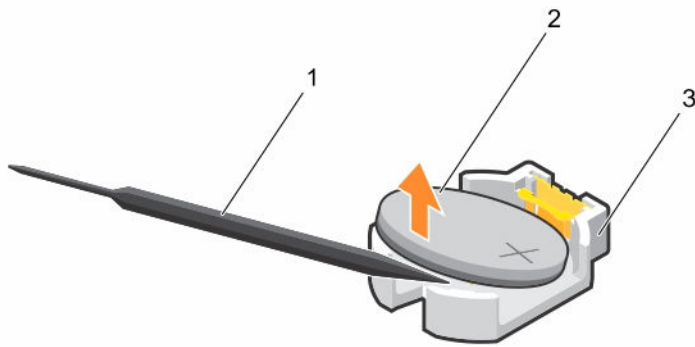

Figure 46. Removing the system battery

1. plastic scribe
 2. positive side of the battery connector
 3. securing tabs
3. Install a new system battery by holding the battery with the "+" sign facing up and slide it under the securing tabs.
 4. Press the battery into the connector until it snaps into place.

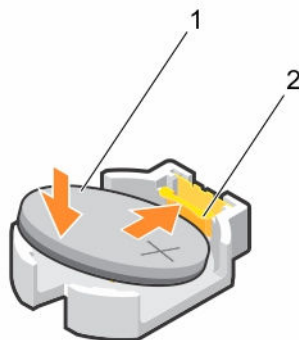

Figure 47. Installing the system battery

1. positive side of the battery connector
2. battery connector

Next steps

1. Install the expansion card riser.
2. Follow the procedure listed in [After working inside your system](#).
3. While booting, press F2 to enter System Setup and ensure that the battery is operating properly.
4. Enter the correct time and date in the System Setup **Time** and **Date** fields.
5. Exit System Setup.

Related Tasks

[Removing the expansion card riser](#)

[Installing the expansion card riser](#)

Hard drive backplane

Depending on your system configuration, PowerEdge R330 supports:

- Four 3.5-inch or 2.5-inch SAS/SATA backplane or
- Eight 2.5-inch SAS/SATA backplane

Removing the hard drive backplane

Prerequisites

 **CAUTION:** Many repairs may only be done by a certified service technician. You should only perform troubleshooting and simple repairs as authorized in your product documentation, or as directed by the online or telephone service and support team. Damage due to servicing that is not authorized by Dell is not covered by your warranty. Read and follow the safety instructions that came with the product.

 **CAUTION:** To prevent damage to the drives and backplane, you must remove the hard drives from the system before removing the backplane.

 **CAUTION:** You must note the number of each hard drive and temporarily label them before removal so that you can replace them in the same locations.

1. Ensure that you follow the [Safety instructions](#).
2. Follow the procedure listed in [Before working inside your system](#).
3. Remove all hard drives.
4. Disconnect the SAS/SATA data, signal, and power cables from the backplane.

Steps

Press the release tabs and lift the backplane upward and slide it toward the back of the chassis.

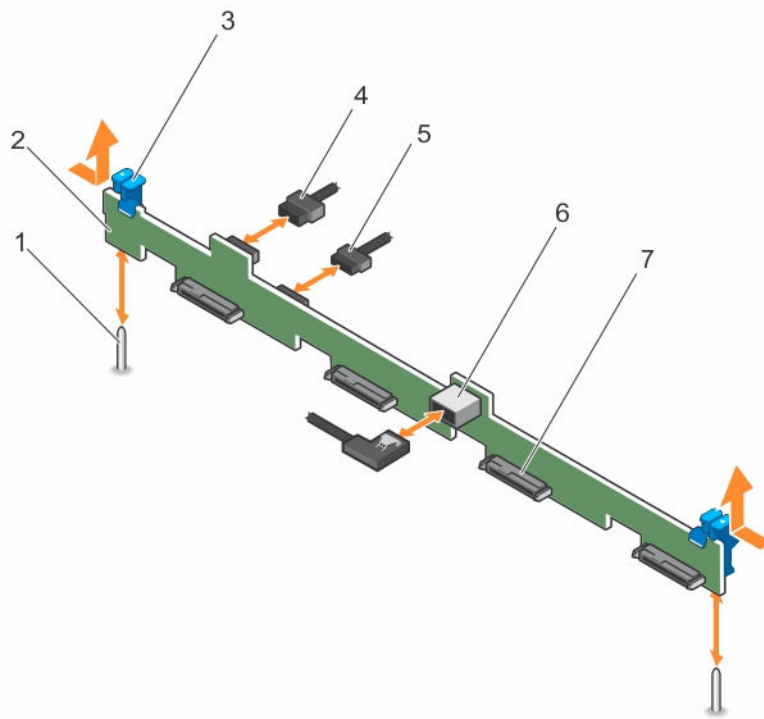

Figure 48. Removing and installing the four 3.5-inch or four 2.5-inch hard drive SAS/SATA backplane

- | | |
|------------------------------------|-------------------------------------|
| 1. guide pin (2) | 2. hard drive or SSD backplane |
| 3. release tab (2) | 4. backplane power cable |
| 5. backplane signal cable | 6. SAS A connector on the backplane |
| 7. hard drive or SSD connector (4) | |

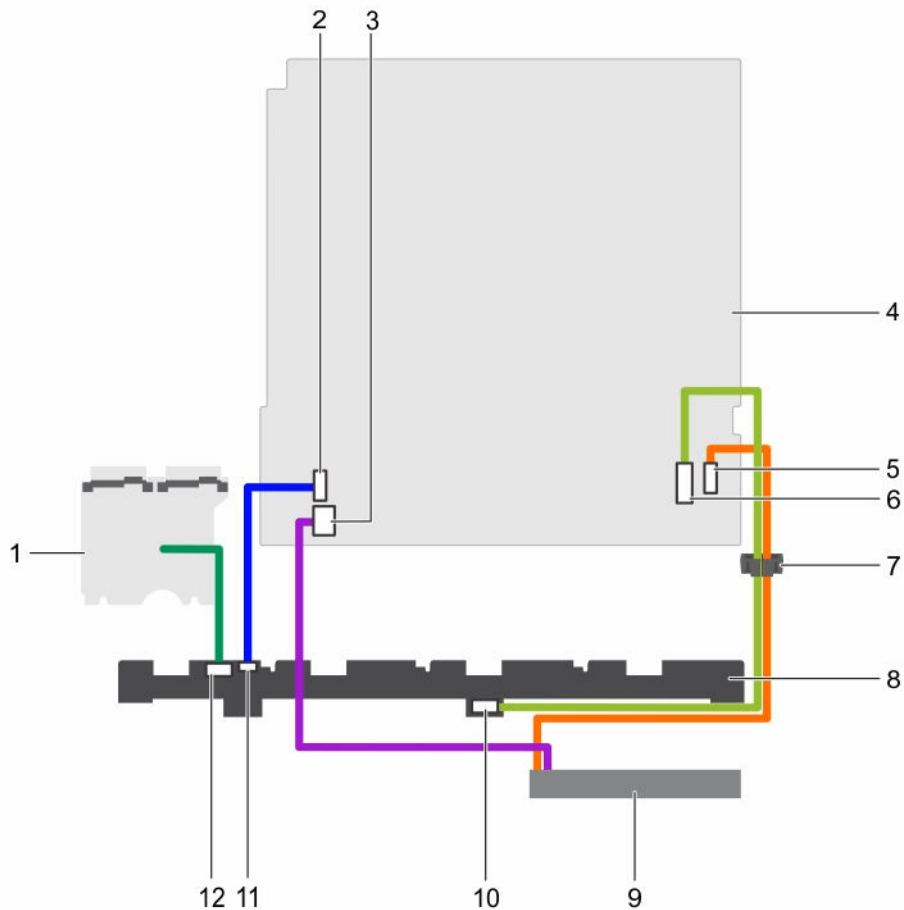

Figure 49. Cabling diagram—Four 3.5-inch or 2.5-inch hard drive SAS/SATA backplane

- | | |
|--|---|
| 1. power interposer board (PIB) | 2. signal cable connector on the system board |
| 3. optical drive power cable connector on the system board | 4. system board |
| 5. optical drive SATA connector on the system board | 6. SAS connector on the system board |
| 7. cable routing clip | 8. backplane |
| 9. optical drive | 10. SAS connector on the backplane |
| 11. signal cable connector on the backplane | 12. power cable connector on the backplane |

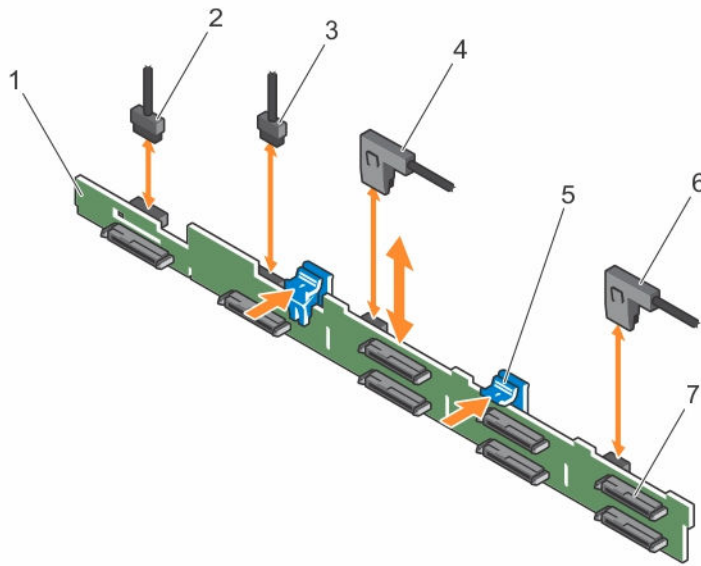

Figure 50. Removing and installing the eight 2.5-inch SAS/SATA backplane

- | | |
|------------------------------------|--------------------------|
| 1. hard drive/SSD backplane | 2. backplane power cable |
| 3. backplane signal cable | 4. SAS A cable connector |
| 5. release tab (2) | 6. SAS B cable connector |
| 7. hard drive or SSD connector (8) | |

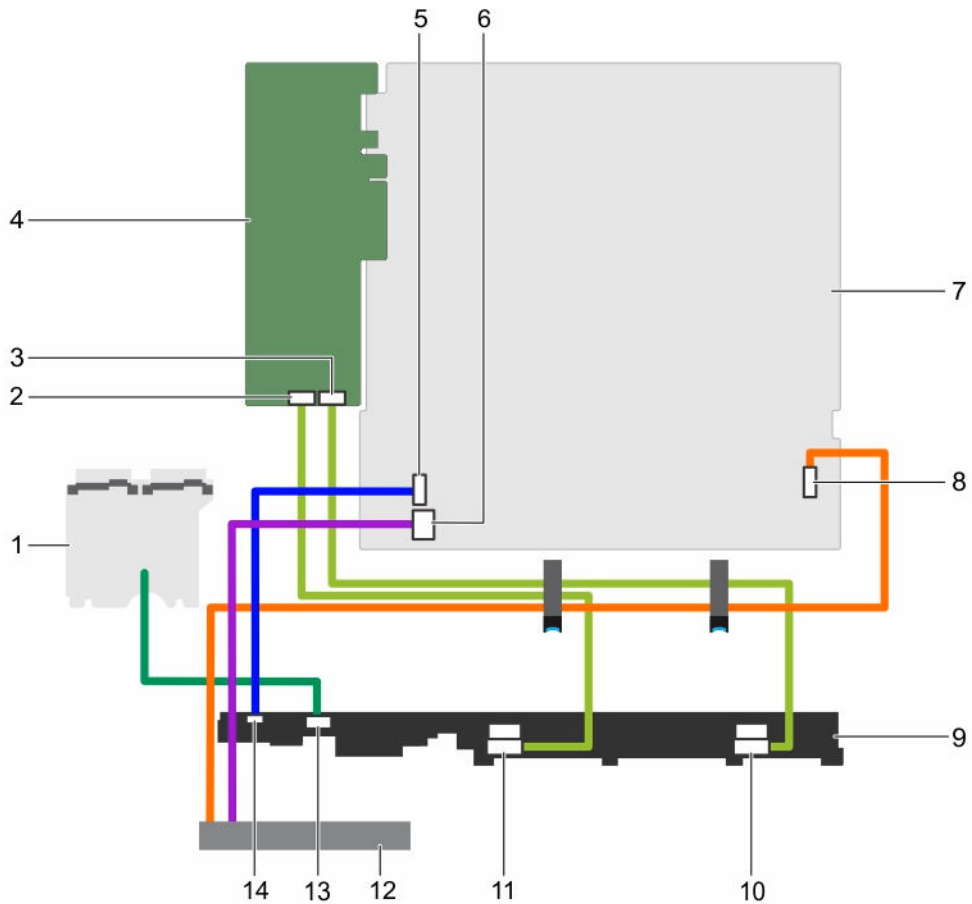

Figure 51. Cabling diagram—Eight 2.5-inch SAS/SATA backplane with PERC card

- | | |
|---|--|
| 1. power interposer board (PIB) | 2. Connector A on the PERC card |
| 3. Connector B on the PERC card | 4. PERC card |
| 5. signal cable connector on the system board | 6. optical drive power cable connector on the system board |
| 7. system board | 8. optical drive SATA connector on the system board |
| 9. backplane | 10. SAS B connector on the backplane |
| 11. SAS A connector on the backplane | 12. optical drive |
| 13. power cable connector on the backplane | 14. signal cable connector on the backplane |

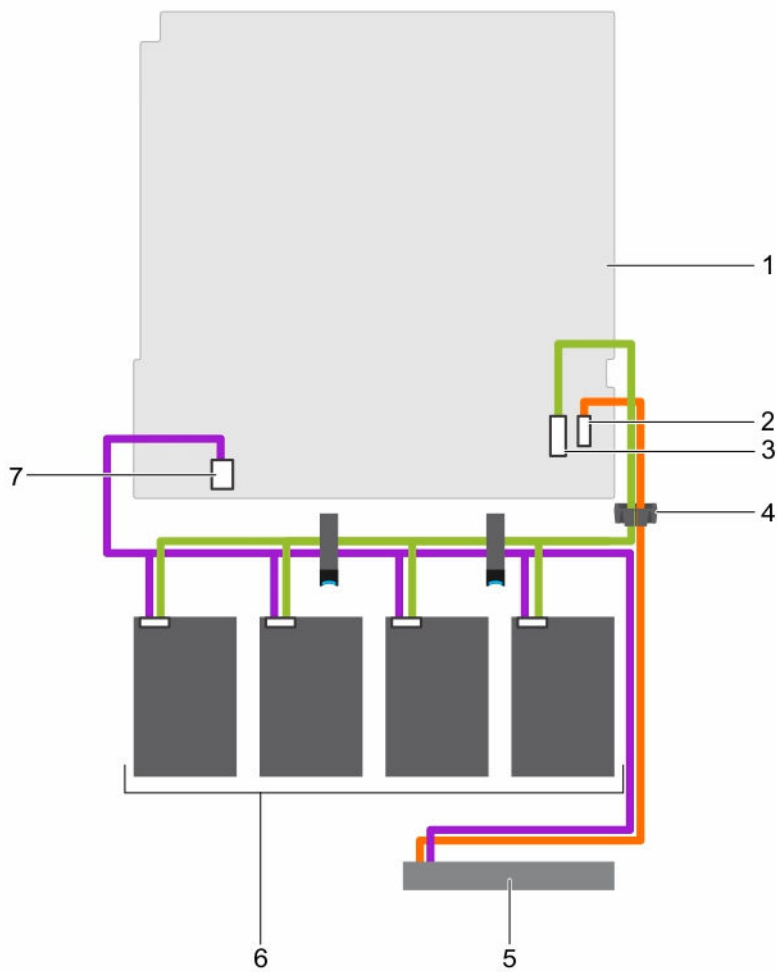

Figure 52. Cabling diagram—Four 3.5-inch cabled hard drives

- | | |
|---|---|
| 1. system board | 2. optical drive SATA connector on the system board |
| 3. SAS connector on the system board | 4. cable routing clip |
| 5. optical drive | 6. cabled hard drive (4) |
| 7. hard drive and optical drive power connector on the system board | |

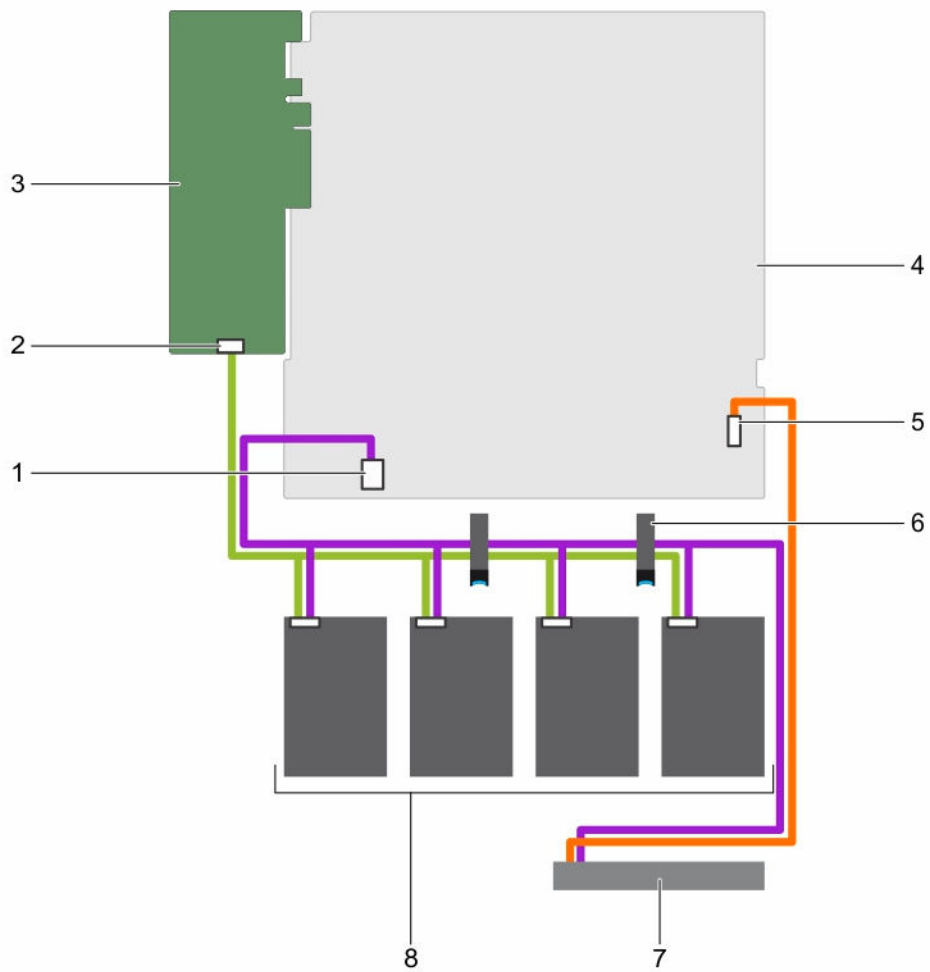

Figure 53. Cabling diagram—Four 3.5-inch cabled hard drives and PERC card

- | | |
|---|---------------------------------|
| 1. hard drive and optical drive power connector on the system board | 2. Connector A on the PERC card |
| 3. PERC card | 4. system board |
| 5. optical drive SATA connector on the system board | 6. cable routing clip |
| 7. optical drive | 8. cabled hard drive (4) |

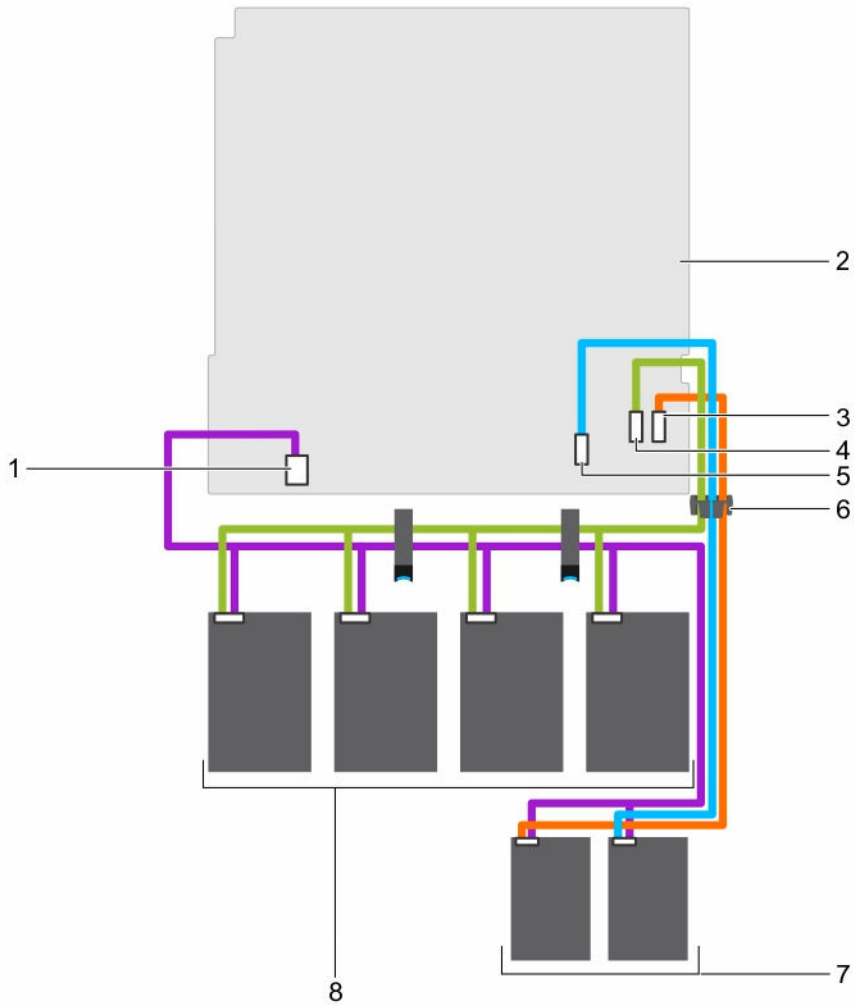

Figure 54. Cabling diagram—Four 3.5-inch cabled hard drives and two 1.8-inch SSDs

- | | |
|---|--|
| 1. hard drive/SSD power cable connector on the system board | 2. system board |
| 3. optical drive/solid state drive (SSD) SATA connector on the system board | 4. SATA0-3 connector on the system board |
| 5. SATA SSD connector on the system board | 6. cable routing clip |
| 7. 1.8-inch SSD (2) | 8. cabled hard drive (4) |

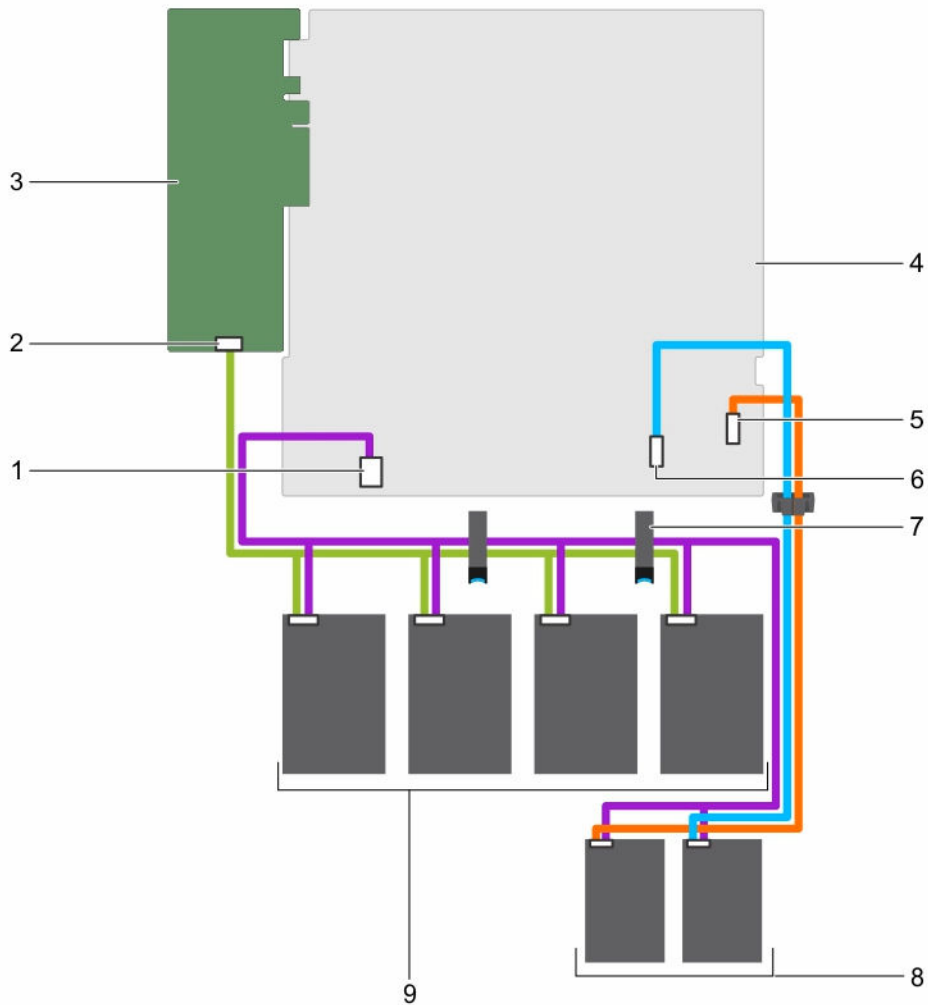

Figure 55. Cabling diagram—Four 3.5-inch cabled hard drives, two 1.8-inch SSDs, and PERC card

- | | |
|---|---|
| 1. hard drive/SSD power cable connector on the system board | 2. Connector A on the PERC card |
| 3. PERC card | 4. system board |
| 5. optical drive/solid state drive SATA connector on the system board | 6. SATA SSD connector on the system board |
| 7. cable routing latch | 8. 1.8-inch SSD (2) |
| 9. cabled hard drive (4) | |

Next steps

1. Install the hard drive backplane.
2. Follow the procedure listed in [After working inside your system.](#)

Related Tasks

- [Removing a hot swappable hard drive carrier](#)
- [Installing the hard drive backplane](#)

Installing the hard drive backplane

Prerequisites

 **CAUTION:** Many repairs may only be done by a certified service technician. You should only perform troubleshooting and simple repairs as authorized in your product documentation, or as directed by the online or telephone service and support team. Damage due to servicing that is not authorized by Dell is not covered by your warranty. Read and follow the safety instructions that came with the product.

 **CAUTION:** To prevent damage to the control panel flex cable, do not bend the control panel flex cable after it is inserted into the connector.

1. Ensure that you follow the [Safety instructions](#).
2. Follow the procedure listed in [Before working inside your system](#).

Steps

1. Align the slots on the hard drive backplane with the hooks on the chassis.
2. Press down the hard drive backplane until the release tabs snap into place.
3. Connect the SAS/SATA/SSD data, signal, and power cables to the backplane.

Next steps

1. Install the hard drives in their original locations.
2. Follow the procedure listed in [After working inside your system](#).

Related Tasks

[Installing a hot swappable hard drive carrier](#)

Control panel assembly

Removing the LCD control panel assembly

Prerequisites

 **CAUTION:** Many repairs may only be done by a certified service technician. You should only perform troubleshooting and simple repairs as authorized in your product documentation, or as directed by the online or telephone service and support team. Damage due to servicing that is not authorized by Dell is not covered by your warranty. Read and follow the safety instructions that came with the product.

1. Ensure that you follow the [Safety instructions](#).
2. Follow the procedure listed in [Before working inside your system](#).
3. Keep the Phillips #2 screwdriver ready.

Steps

1. Disconnect the cables from the control panel board.

 **CAUTION:** Do not use excessive force when removing the control panel as it can damage the connectors.

2. Hold the top edge of the LCD control panel at the corners and pull upward until the LCD control panel tabs are released.
3. Pull the control panel away from the chassis.

4. Remove the screws securing the LCD control panel board.
5. Lift the LCD control panel board away from the chassis.

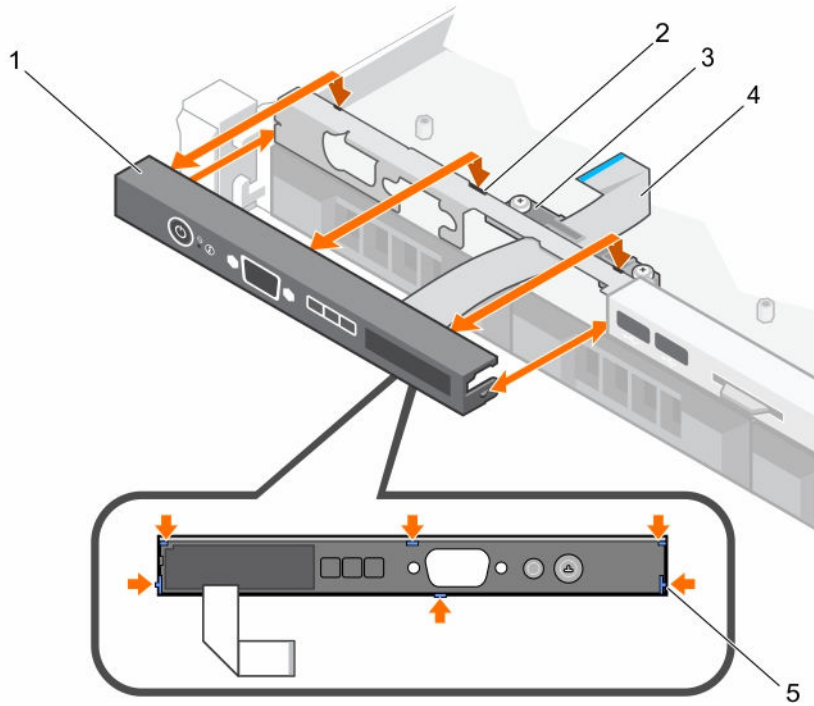

Figure 56. Removing and installing the LCD control panel—four 3.5-inch hot swappable hard drive chassis

- | | |
|--|-------------------------|
| 1. LCD control panel | 2. notches (6) |
| 3. display module cable retention clip | 4. display module cable |
| 5. tabs on the LCD control panel (6) | |

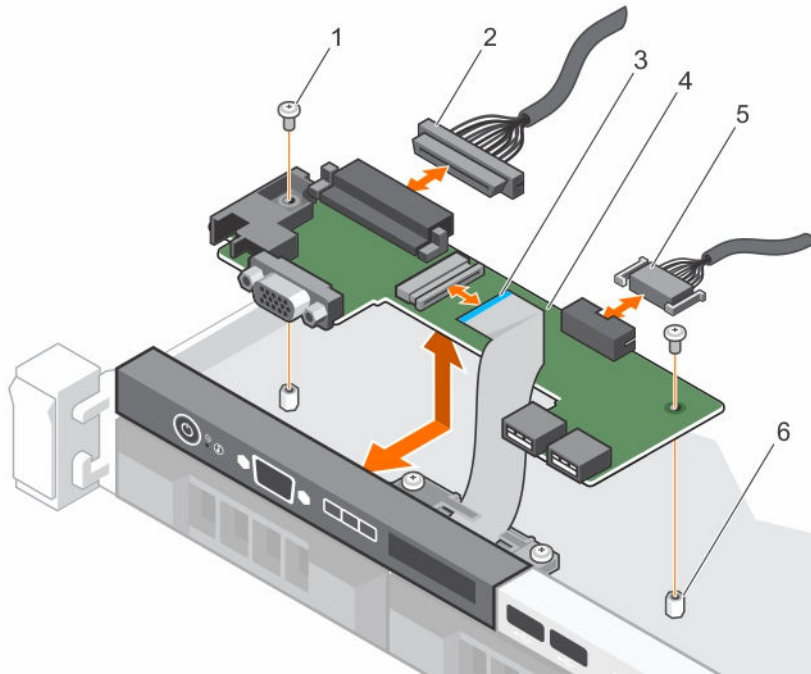

Figure 57. Removing and installing the LCD control panel board—four hard drive chassis

- | | |
|-------------------------|----------------------------------|
| 1. screw (2) | 2. control panel connector cable |
| 3. display module cable | 4. control panel board |
| 5. USB connector cable | 6. standoff on the chassis (2) |

Next steps

1. Install the LCD control panel assembly.
2. Follow the procedure listed in [After working inside your system](#).

Related Tasks

[Installing the LCD control panel assembly](#)

Installing the LCD control panel assembly

Prerequisites

⚠ CAUTION: Many repairs may only be done by a certified service technician. You should only perform troubleshooting and simple repairs as authorized in your product documentation, or as directed by the online or telephone service and support team. Damage due to servicing that is not authorized by Dell is not covered by your warranty. Read and follow the safety instructions that came with the product.

1. Ensure that you follow the [Safety instructions](#).
2. Follow the procedure listed in [Before working inside your system](#).
3. Keep the Phillips #2 screwdriver ready.

Steps

1. Align the tabs on the control panel with the notches on the chassis.
2. Route the LCD cable through the cable retention clip.

3. Push the control panel toward the chassis until it snaps into place.

Next steps

Follow the procedure listed in [After working inside your system](#).

Removing the LED control panel assembly

Prerequisites

CAUTION: Many repairs may only be done by a certified service technician. You should only perform troubleshooting and simple repairs as authorized in your product documentation, or as directed by the online or telephone service and support team. Damage due to servicing that is not authorized by Dell is not covered by your warranty. Read and follow the safety instructions that came with the product.

1. Ensure that you follow the [Safety instructions](#).
2. Follow the procedure listed in [Before working inside your system](#).
3. Disconnect the cables connected to the control panel module.

CAUTION: Do not use excessive force when removing the control panel as it can damage the connectors.

Steps

1. For cabled hard drive chassis, perform the following steps:
 - a. Remove the screw(s) that secure the LED panel to the chassis.
 - b. Remove the LED panel.
2. Remove the screws that secure the control panel board to the chassis.
3. Lift the control panel board away from the chassis.

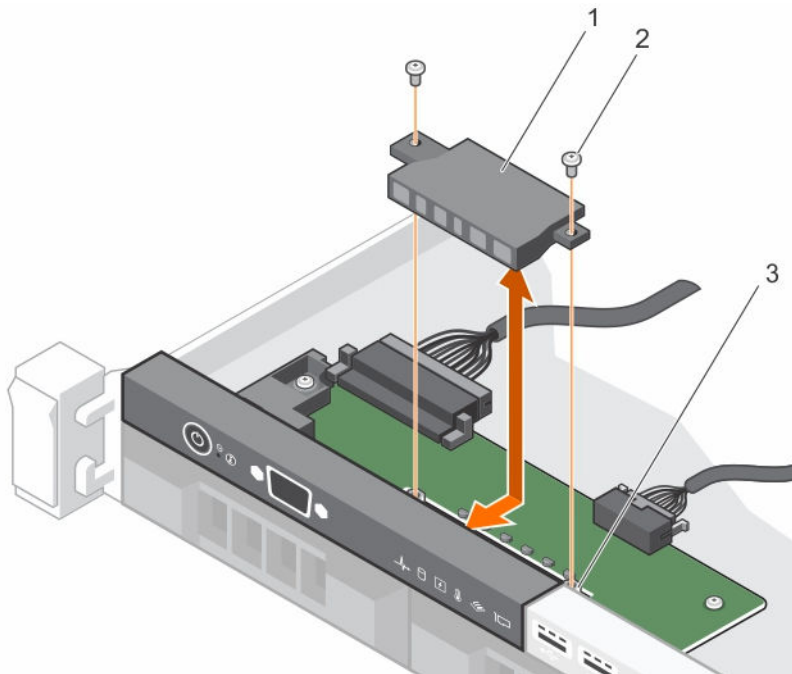

Figure 58. Removing and installing the LED module—four cabled hard drive chassis

1. LED module

2. screw (2)

3. slot on the chassis

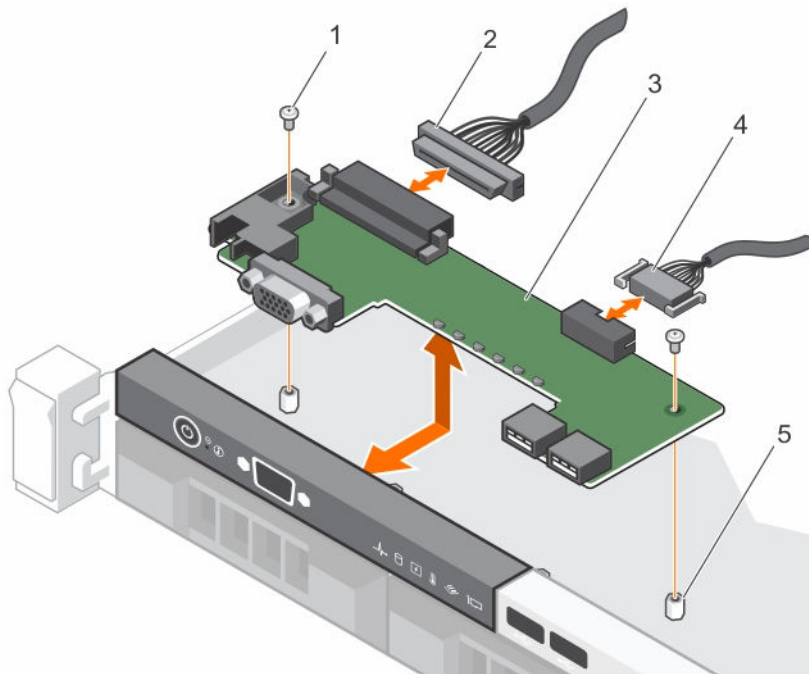

Figure 59. Removing and installing the LED control panel board—four cabled hard drive chassis

- | | |
|--------------------------------|----------------------------------|
| 1. screw (2) | 2. control panel connector cable |
| 3. control panel board | 4. USB connector cable |
| 5. standoff on the chassis (2) | |

Next steps

1. Install the LED control panel assembly.
2. Follow the procedure listed in [After working inside your system](#).

Related Tasks

[Installing the LED control panel assembly](#)

Installing the LED control panel assembly

Prerequisites

CAUTION: Many repairs may only be done by a certified service technician. You should only perform troubleshooting and simple repairs as authorized in your product documentation, or as directed by the online or telephone service and support team. Damage due to servicing that is not authorized by Dell is not covered by your warranty. Read and follow the safety instructions that came with the product.

1. Ensure that you follow the [Safety instructions](#).
2. Follow the procedure listed in [Before working inside your system](#).

Steps

1. For cabled hard drive systems, perform the following steps:

- a. Insert the LED panel into the slot in the chassis.
- b. Secure the LED panel with the screws.
2. Insert the control panel board into the slot in the chassis and align the two screw holes on the control panel board with the corresponding holes on the chassis.
3. Secure the control panel board with the screws.
4. Connect all the cables to the control panel board.

Next steps

Follow the procedure listed in [After working inside your system](#).

Power interposer board

The power interposer board is present only in systems that support redundant power supply units.

Removing the power interposer board

Prerequisites



CAUTION: Many repairs may only be done by a certified service technician. You should only perform troubleshooting and simple repairs as authorized in your product documentation, or as directed by the online or telephone service and support team. Damage due to servicing that is not authorized by Dell is not covered by your warranty. Read and follow the safety instructions that came with the product.



NOTE: The power interposer board is present only in systems that support redundant power supplies.

1. Ensure that you follow the [Safety instructions](#).
2. Keep the Phillips #2 screwdriver ready.
3. Follow the procedure listed in [Before working inside your system](#).
4. Remove the power supply units from the system.

Steps

1. Disconnect the power distribution cables from the system board.
2. Remove the two screws securing the power interposer board (PIB) to the chassis.
3. Holding the PIB, lift it slightly to disengage it from the screw holes.
4. Slide the PIB toward the back of the chassis and lift it out of the chassis.

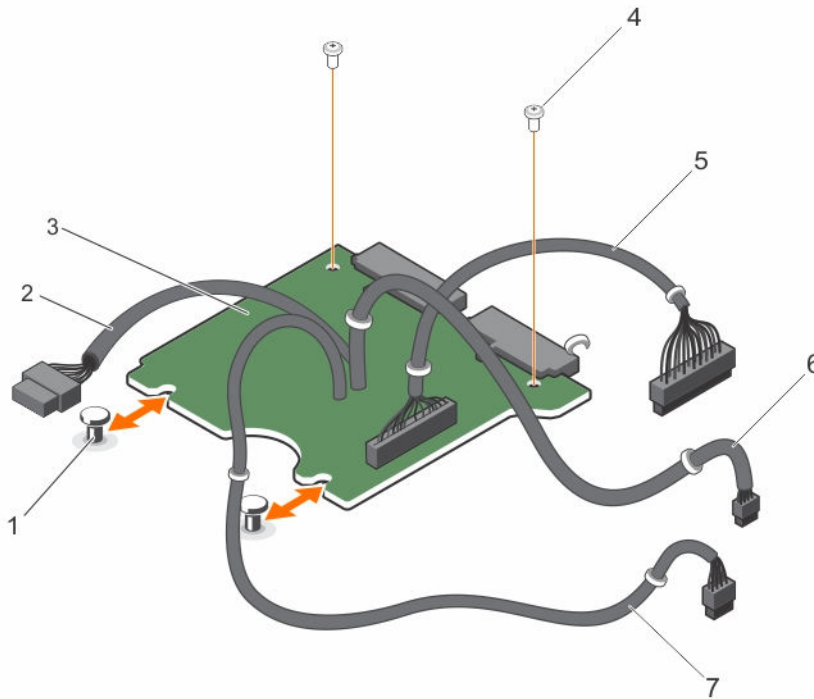

Figure 60. Removing and installing the power interposer board

- | | |
|---------------------------------|---|
| 1. standoffs (2) | 2. 10 pin cable to hard drive backplane |
| 3. power interposer board | 4. screw (2) |
| 5. 28 pin cable to system board | 6. 4 pin cable to system board |
| 7. 8 pin cable to system board | |

NOTE: For systems without a hard drive backplane, do not connect the 10 pin cable.

Next steps

1. Install the power interposer board.
2. Follow the procedure listed in [After working inside your system](#).

Related Tasks

- [Removing a redundant power supply unit](#)
- [Installing the power interposer board](#)

Installing the power interposer board

Prerequisites

CAUTION: Many repairs may only be done by a certified service technician. You should only perform troubleshooting and simple repairs as authorized in your product documentation, or as directed by the online or telephone service and support team. Damage due to servicing that is not authorized by Dell is not covered by your warranty. Read and follow the safety instructions that came with the product.

1. Ensure that you follow the [Safety instructions](#).
2. Follow the procedure listed in [Before working inside your system](#).
3. Keep the Phillips #2 screwdriver ready.

Steps

1. Align the power interposer board (PIB) with the standoffs on the chassis.
2. Install the two screws that secure the PIB to the chassis.
3. Connect the power distribution cables to the system board and the hard drive power connector to the hard drive backplane.

Next steps

1. Install the power supply units.
2. Follow the procedure listed in [After working inside your system](#).

Related Tasks

[Installing a redundant power supply unit](#)

Trusted Platform Module

The Trusted Platform Module (TPM) is used to generate or store keys, protect or authenticate passwords, and create or store digital certificates. TPM can also be used to enable the BitLocker hard drive encryption feature on a Windows Server.

 **CAUTION:** Do not attempt to remove the Trusted Platform Module (TPM) from the system board. Once the TPM is installed, it is cryptographically bound to that specific system board. Any attempt to remove an installed TPM breaks the cryptographic binding, and it cannot be re-installed or installed on another system board.

 **NOTE:** This is a Field Replaceable Unit (FRU). Removal and installation procedures must be performed only by Dell certified service technicians.

Installing the Trusted Platform Module

Prerequisites

 **CAUTION:** Many repairs may only be done by a certified service technician. You should only perform troubleshooting and simple repairs as authorized in your product documentation, or as directed by the online or telephone service and support team. Damage due to servicing that is not authorized by Dell is not covered by your warranty. Read and follow the safety instructions that came with the product.

 **NOTE:** This is a Field Replaceable Unit (FRU). Removal and installation procedures should be performed only by Dell certified service technicians.

1. Ensure that you follow the [Safety instructions](#).
2. Follow the procedure listed in [Before working inside your system](#).

Steps

1. Locate the Trusted Platform Module (TPM) connector on the system board.

 **NOTE:** To locate the internal USB connector on the system board, see [System board connectors](#).

2. Align the edge connectors on the TPM with the slot on the TPM connector.
3. Insert the TPM into the TPM connector such that the plastic bolt aligns with the slot on the system board.

4. Press the plastic bolt until the bolt snaps into place.

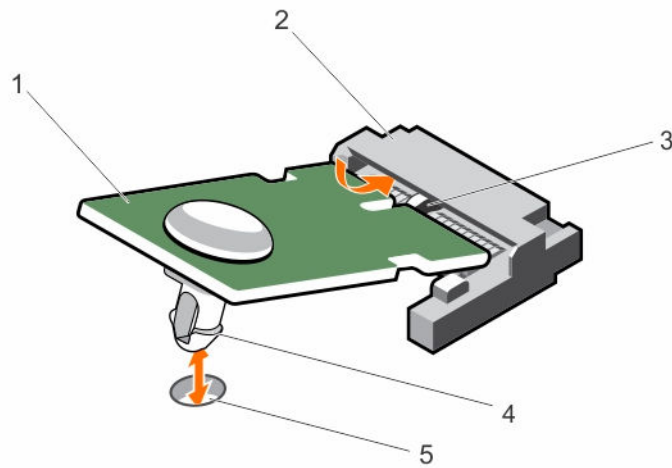

Figure 61. Installing the TPM

- | | |
|------------------------------|------------------|
| 1. TPM | 2. TPM connector |
| 3. slot on the TPM connector | 4. plastic bolt |
| 5. slot on the system board | |

Next steps

1. Install the system board.
2. Follow the procedure listed in [After working inside your system](#).

Related Tasks

[Installing the system board](#)

Re-enabling the TPM for BitLocker users

Initialize the TPM.

For more information about initializing the TPM, see <http://technet.microsoft.com/en-us/library/cc753140.aspx>.

The **TPM Status** changes to **Enabled, Activated**.

Re-enabling the TPM for TXT users

1. While booting your system, press F2 to enter System Setup.
2. In the **System Setup Main Menu**, click **System BIOS** → **System Security Settings**.
3. In the **TPM Security** option, select **On with Pre-boot Measurements**.
4. In the **TPM Command** option, select **Activate**.

5. Save the settings.
6. Restart your system.
7. Enter System Setup again.
8. In the **System Setup Main Menu**, click **System BIOS** → **System Security Settings**.
9. In the **Intel TXT** option, select **On**.

System board

Removing the system board

Prerequisites

 **CAUTION:** Many repairs may only be done by a certified service technician. You should only perform troubleshooting and simple repairs as authorized in your product documentation, or as directed by the online or telephone service and support team. Damage due to servicing that is not authorized by Dell is not covered by your warranty. Read and follow the safety instructions that came with the product.

 **NOTE:** This is a Field Replaceable Unit (FRU). Removal and installation procedures must be performed only by Dell certified service technicians.

 **CAUTION:** If you are using the Trusted Program Module (TPM) with an encryption key, you may be prompted to create a recovery key during program or System Setup. Be sure to create and safely store this recovery key. If you replace this system board, you must supply the recovery key when you restart your system or program before you can access the encrypted data on your hard drives.

 **CAUTION:** Do not attempt to remove the TPM plug-in module from the system board. After the TPM plug-in module is installed, it is cryptographically bound to that specific system board. Any attempt to remove an installed TPM plug-in module breaks the cryptographic binding, and it cannot be re-installed or installed on another system board.

1. Ensure that you follow the [Safety instructions](#).
2. Keep the Phillips #2 screwdriver ready.
3. Follow the procedure listed in [Before working inside your system](#).
4. Remove the following components:
 - a. cooling shroud
 - b. memory modules
 - c. cooling fan cables
 - d. expansion cards
 - e. expansion card riser
 - f. heat sink and processor
 - g. iDRAC port card, if installed
 - h. internal dual SD module, if installed

Steps

1. Disconnect all cables from the system board.

 **CAUTION:** Take care not to damage the system identification button while removing the system board from the chassis.

2. Remove the screws on the system board, and slide the system board toward the front of the chassis.

3. Hold the system board by the touch points and lift it out of the chassis.

CAUTION: To prevent damage to the system board, do not lift the system board by holding a memory module, processor, or other components; hold the system board by its edges only.

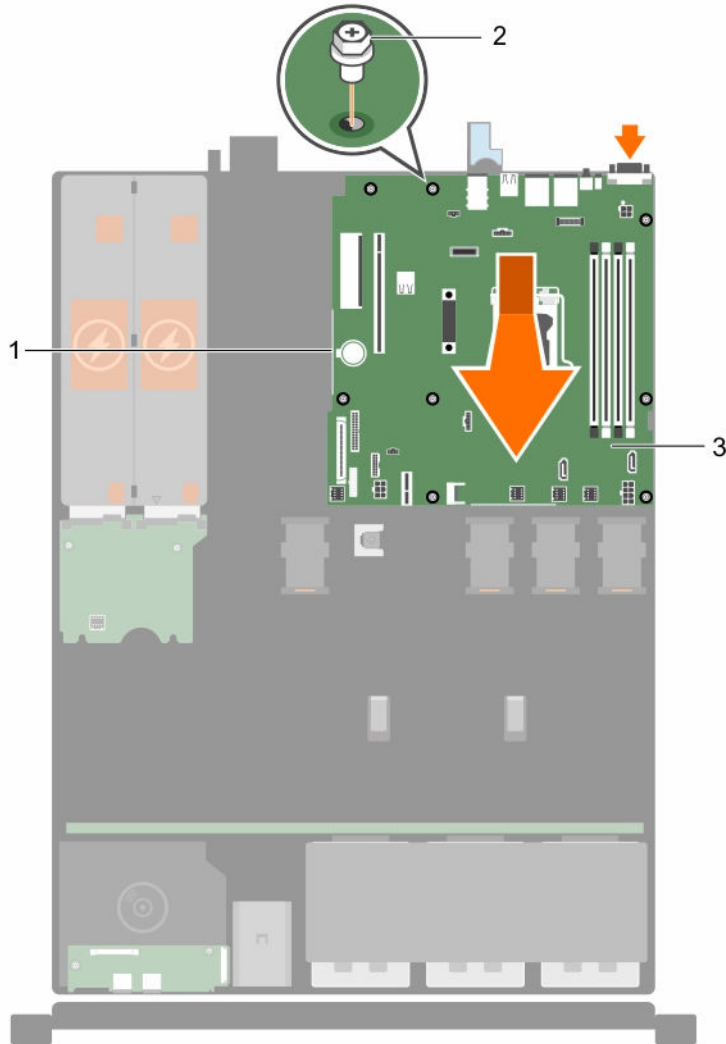

Figure 62. Removing and installing the system board

1. touch point (2)
2. screw (8)
3. system board

Next steps

1. Install the system board.
2. Follow the procedure listed in [After working inside your system.](#)

Related Tasks

- [Removing the cooling shroud](#)
- [Removing a memory module](#)

- [Removing a cooling fan](#)
- [Removing an expansion card](#)
- [Removing the expansion card riser](#)
- [Removing the optional iDRAC port card](#)
- [Removing the heat sink](#)
- [Removing the processor](#)
- [Removing the optional internal dual SD module](#)

Installing the system board

Prerequisites

 **CAUTION:** Many repairs may only be done by a certified service technician. You should only perform troubleshooting and simple repairs as authorized in your product documentation, or as directed by the online or telephone service and support team. Damage due to servicing that is not authorized by Dell is not covered by your warranty. Read and follow the safety instructions that came with the product.

 **NOTE:** This is a Field Replaceable Unit (FRU). Removal and installation procedures must be performed only by Dell certified service technicians.

 **CAUTION:** Do not lift the system board by holding a memory module, processor, or other components.

 **CAUTION:** Take care not to damage the system identification button while placing the system board into the chassis.

1. Ensure that you follow the [Safety instructions](#).
2. Follow the procedure listed in [Before working inside your system](#).
3. Keep the Phillips #2 screwdriver ready.

Steps

1. Hold the system board by its edges, and orient it toward the back of the chassis.
2. Lower the system board into the chassis until the connectors at the back of the system board align with the slots on the back of the chassis.
3. Tighten the screws that secure the system board to the chassis.

Next steps

1. If required, install the Trusted Platform Module (TPM). See, [Installing the Trusted Platform Module](#).
2. Reinstall the following components:
 - a. expansion card riser
 - b. memory modules
 - c. heat sink and processor
 - d. cooling shroud
 - e. iDRAC port card, if removed
 - f. internal dual SD module, if removed
3. Reconnect all cables to the system board.

 **NOTE:** Ensure that the cables inside the system are routed through the cable routing latch.
4. Follow the procedure listed in [After working inside your system](#).
5. Import your new or existing iDRAC Enterprise license. For more information, see the Integrated Dell Remote Access Controller User's Guide, at Dell.com/idracmanuals.

 **NOTE:** If you are using Easy Restore, you do not have to import an existing iDRAC Enterprise license.

6. Ensure that you perform the following steps:
 - a. Use the Easy Restore feature to restore the service tag. See [Restoring the Service Tag by using the Easy Restore feature](#).
 - b. If the service tag is not backed up in the backup flash device, enter the system service tag manually. See [Entering the system service tag by using System Setup](#).
 - c. Update the BIOS and iDRAC versions.
 - d. Re-enable the Trusted Platform Module (TPM). See [Re-enabling the TPM for BitLocker users](#) or [Re-enabling the TPM for TXT users](#).

Related Tasks

- [Installing the cooling shroud](#)
- [Installing a memory module](#)
- [Installing a cooling fan](#)
- [Installing an expansion card](#)
- [Installing the expansion card riser](#)
- [Installing the optional iDRAC port card](#)
- [Installing the heat sink](#)
- [Installing the processor](#)
- [Installing the Trusted Platform Module](#)

Restoring the Service Tag by using the Easy Restore feature

The Easy Restore feature enables you to restore your system's Service Tag, license, UEFI configuration, and the system configuration data after replacing the system board. All data is automatically backed up in a backup flash device. If BIOS detects a new system board and the Service Tag in the backup flash device, BIOS prompts the user to restore the backup information.

1. Turn on the system.

If BIOS detects a new system board, and if the Service Tag is present in the backup flash device, BIOS displays the Service Tag, the status of the license, and the **UEFI Diagnostics** version.
2. Perform one of the following steps:
 - Press **Y** to restore the Service Tag, license, and diagnostics information.
 - Press **N** to navigate to the Dell Lifecycle Controller based restore options.
 - Press F10 to restore data from a previously created **Hardware Server Profile**.

After the restore process is complete, BIOS prompts to restore the system configuration data.

3. Perform one of the following steps:
 - Press **Y** to restore the system configuration data.
 - Press **N** to use the default configuration settings.

After the restore process is complete, the system restarts.

Entering the system service tag by using System Setup

If Easy Restore fails to restore the service tag, use System Setup to enter the service tag.

1. Turn on the system.
2. Press F2 to enter System Setup.
3. Click **Service Tag Settings**.

4. Enter the service tag.



NOTE: You can enter the service tag only when the **service tag** field is empty. Ensure that you enter the correct service tag. After the service tag is entered, it cannot be updated or changed.

5. Click **Ok**.
6. Import your new or existing iDRAC Enterprise license.

For more information, see the Integrated Dell Remote Access Controller User's Guide, at Dell.com/idracmanuals.

Troubleshooting your system

Safety first—for you and your system

 **CAUTION:** Many repairs may only be done by a certified service technician. You should only perform troubleshooting and simple repairs as authorized in your product documentation, or as directed by the online or telephone service and support team. Damage due to servicing that is not authorized by Dell is not covered by your warranty. Read and follow the safety instructions that came with the product.

Troubleshooting system startup failure

If you boot the system to the BIOS boot mode after installing an operating system from the UEFI Boot Manager, the system stops responding. To avoid this issue, you must boot to the same boot mode in which you installed the operating system.

For all other startup issues, note the system messages that appear on the screen.

Troubleshooting external connections

Before troubleshooting any external devices, ensure that all external cables are securely attached to the external connectors on your system before troubleshooting any external devices.

Troubleshooting the video subsystem

Steps

1. Check the power connections to the monitor.
2. Check the video interface cabling from the system to the monitor.
3. Run the appropriate diagnostic test.

If the tests run successfully, the problem is not related to video hardware.

Next steps

If the tests fail, see [Getting Help](#).

Troubleshooting a USB device

Prerequisites

 **NOTE:** Follow steps 1 to 6 to troubleshoot a USB keyboard or mouse. For other USB devices, go to step 7.

Steps

1. Disconnect the keyboard and/or mouse cables from the system and reconnect them.
2. If the problem persists, connect the keyboard and/or mouse to another USB port on the system.
3. If the problem is resolved, restart the system, enter System Setup, and check if the non-functioning USB ports are enabled.



NOTE: Older operating systems may not support USB 3.0.

4. Check if USB 3.0 is enabled in System Setup. If enabled, disable it and see if the issue is resolved.
5. In **iDRAC Settings Utility**, ensure that **USB Management Port Mode** is configured as **Automatic** or **Standard OS Use**.
6. If the problem is not resolved, replace the keyboard and/or mouse with a known working keyboard or mouse.
If the problem is not resolved, proceed to step 7 to troubleshoot other USB devices attached to the system.
7. Turn off all attached USB devices, and disconnect them from the system.
8. Restart the system.
9. If your keyboard is functioning, enter System Setup, verify that all USB ports are enabled on the **Integrated Devices** screen. If your keyboard is not functioning, use remote access to enable or disable the USB options.
10. Check if USB 3.0 is enabled in System Setup. If it is enabled, disable it and restart your system.
11. If the system is not accessible, reset the NVRAM_CLR jumper inside your system and restore the BIOS to the default settings.
12. In the **iDRAC Settings Utility**, ensure that **USB Management Port Mode** is configured as **Automatic** or **Standard OS Use**.
13. Reconnect and turn on each USB device one at a time.
14. If a USB device causes the same problem, turn off the device, replace the USB cable with a known good cable, and turn on the device.

Next steps

If all troubleshooting fails, see [Getting Help](#).

Troubleshooting iDRAC Direct (USB XML configuration)

For information on USB storage device and server configuration, see the Integrated Dell Remote Access Controller User's Guide at Dell.com/esmmanuals.

Steps

1. Ensure that your USB storage device is connected to the front USB Management Port, identified by  icon.
2. Ensure that your USB storage device is configured with an NTFS or an FAT32 file system with only one partition.
3. Verify that the USB storage device is configured correctly. For more information about configuring the USB storage device, see the Integrated Dell Remote Access Controller User's Guide at Dell.com/esmmanuals.
4. In the **iDRAC Settings Utility**, ensure that **USB Management Port Mode** is configured as **Automatic** or **iDRAC Direct Only**.
5. Ensure that the **iDRAC Managed: USB XML Configuration** option is either **Enabled** or **Enabled only when the server has default credential settings**.
6. Remove and reinsert the USB storage device.

7. If import operation does not work, try with a different USB storage device.

Next steps

If all troubleshooting fails, see [Getting help](#).

Troubleshooting iDRAC Direct (Laptop connection)

For information on USB laptop connection and server configuration, see the Integrated Dell Remote Access Controller User's Guide at Dell.com/esmmanuals.

Steps

1. Ensure that your laptop is connected to the front USB Management Port, identified by  icon with a USB Type A/A cable.
2. In the **iDRAC Settings Utility**, ensure that **USB Management Port Mode** is configured as **Automatic** or **iDRAC Direct Only**.
3. If the laptop is running the Windows operating system, ensure that the iDRAC Virtual USB NIC device driver is installed.
4. If the driver is installed, ensure that you are not connected to any network through WiFi or cabled ethernet, as iDRAC Direct uses a non-routable address.

Next steps

If all troubleshooting fails, see [Getting help](#).

Troubleshooting a serial I/O device

Steps

1. Turn off the system and any peripheral devices connected to the serial port.
2. Swap the serial interface cable with a known working cable, and turn on the system and the serial device.
If the problem is resolved, replace the interface cable with a known working cable.
3. Turn off the system and the serial device, and swap the serial device with a compatible device.
4. Turn on the system and the serial device.

Next steps

If the problem persists, see [Getting Help](#).

Troubleshooting an NIC

Steps

1. Run the appropriate diagnostic test. For more information, see [Using system diagnostics](#) for the available diagnostic tests.
2. Restart the system and check for any system messages pertaining to the NIC controller.
3. Check the appropriate indicator on the NIC connector:
 - If the link indicator does not glow, the cable connected might be disengaged.
 - If the activity indicator does not glow, the network driver files might be damaged or missing. Install or replace the drivers as necessary. For more information, see the NIC documentation.
 - If the problem persists, use another connector on the switch or hub.
4. Ensure that the appropriate drivers are installed and the protocols are bound. For more information, see the NIC documentation.

5. Enter System Setup and confirm that the NIC ports are enabled on the **Integrated Devices** screen.
6. Ensure that all the NICs, hubs, and switches on the network are set to the same data transmission speed and duplex. For more information, see the documentation for each network device.
7. Ensure that all network cables are of the proper type and do not exceed the maximum length.

Next steps

If all troubleshooting fails, see [Getting Help](#).

Troubleshooting a wet system

Prerequisites



CAUTION: Many repairs may only be done by a certified service technician. You should only perform troubleshooting and simple repairs as authorized in your product documentation, or as directed by the online or telephone service and support team. Damage due to servicing that is not authorized by Dell is not covered by your warranty. Read and follow the safety instructions that came with the product.

Steps

1. Turn off the system and attached peripherals, and disconnect the system from the electrical outlet.
2. Remove the system cover.
3. Remove the following components from the system:
 - hard drives
 - hard drive backplane
 - USB memory key
 - hard drive tray
 - cooling shroud
 - expansion card risers (if present)
 - expansion cards
 - power supply unit(s)
 - cooling fan assembly (if present)
 - cooling fans
 - processor(s) and heat sink(s)
 - memory modules
4. Let the system dry thoroughly for at least 24 hours.
5. Reinstall the components you removed in step 3 except the expansion cards.
6. Install the system cover.
7. Turn on the system and attached peripherals.
If the system does not start properly, see [Getting Help](#).
8. If the system starts properly, shut down the system, and reinstall all the expansion cards that you removed.
9. Run the appropriate diagnostic test. For more information, see [Using System Diagnostics](#).

Next steps

If the tests fail, see [Getting Help](#).

Troubleshooting a damaged system

Prerequisites

 **CAUTION:** Many repairs may only be done by a certified service technician. You should only perform troubleshooting and simple repairs as authorized in your product documentation, or as directed by the online or telephone service and support team. Damage due to servicing that is not authorized by Dell is not covered by your warranty. Read and follow the safety instructions that came with the product.

Steps

1. Turn off the system and attached peripherals, and disconnect the system from the electrical outlet.
2. Remove the system cover.
3. Ensure that the following components are properly installed:
 - cooling shroud
 - expansion card risers (if present)
 - expansion cards
 - power supply unit(s)
 - cooling fan assembly (if present)
 - cooling fans
 - processor(s) and heat sink(s)
 - memory modules
 - hard drive carriers
 - hard drive backplane
4. Ensure that all cables are properly connected.
5. Install the system cover.
6. Run the appropriate diagnostic test. For more information, see [Using System Diagnostics](#).

Next steps

If the tests fail, see [Getting Help](#).

Troubleshooting the system battery

Prerequisites

 **CAUTION:** Many repairs may only be done by a certified service technician. You should only perform troubleshooting and simple repairs as authorized in your product documentation, or as directed by the online or telephone service and support team. Damage due to servicing that is not authorized by Dell is not covered by your warranty. Read and follow the safety instructions that came with the product.

 **NOTE:** If the system is turned off for long periods of time (for weeks or months), the NVRAM may lose its system configuration information. This situation is caused by a defective battery.

 **NOTE:** Some software may cause the system time to speed up or slow down. If the system seems to operate normally except for the time set in System Setup, the problem may be caused by a software, rather than by a defective battery.

Steps

1. Re-enter the time and date in System Setup.
2. Turn off the system, and disconnect it from the electrical outlet for at least an hour.
3. Reconnect the system to the electrical outlet, and turn on the system.
4. Enter System Setup.

If the date and time displayed in System Setup are not correct, check the System Error Log (SEL) for system battery messages.

Next steps

If the problem persists, see [Getting Help](#).

Troubleshooting power supply units

 **CAUTION:** Many repairs may only be done by a certified service technician. You should only perform troubleshooting and simple repairs as authorized in your product documentation, or as directed by the online or telephone service and support team. Damage due to servicing that is not authorized by Dell is not covered by your warranty. Read and follow the safety instructions that came with the product.

Troubleshooting power source problems

1. Press the power button to ensure that your system is turned on. If the power indicator does not glow when the power button is pressed, press the power button firmly.
2. Plug in another working PSU to ensure that the system board is not faulty.
3. Ensure that no loose connections exist.
For example, loose power cables.
4. Ensure that the power source meets applicable standards.
5. Ensure that there are no short circuits.
6. Have a qualified electrician check the line voltage to ensure that it meets the required specifications.

Power supply unit problems

1. Ensure that no loose connections exist.
For example, loose power cables.
2. Ensure that the power supply handle/LED indicates that the power supply is working properly.
For more information on power supply indicators, see [Indicator codes for redundant power supply unit](#).
3. If you have recently upgraded your system, ensure that the power supply unit has enough power to support the new system.
4. If you have a redundant power supply configuration, ensure that both the power supply units are of the same type and wattage.
You may have to upgrade to a higher wattage power supply unit.
5. Ensure that you use only power supply units with the Extended Power Performance (EPP) label on the back.
6. Reseat the power supply unit.



NOTE: After installing a power supply unit, allow several seconds for the system to recognize the power supply unit and determine if it is working properly.

If the problem persists, see [Getting Help](#).

Troubleshooting cooling problems

 **CAUTION:** Many repairs may only be done by a certified service technician. You should only perform troubleshooting and simple repairs as authorized in your product documentation, or as directed by the online or telephone service and support team. Damage due to servicing that is not authorized by Dell is not covered by your warranty. Read and follow the safety instructions that came with the product.

Ensure that the following conditions exist:

- System cover, cooling shroud, EMI filler panel, or back-filler bracket is not removed.
- Ambient temperature is not higher than the specified ambient temperature.
- External airflow is not obstructed.
- A cooling fan is not removed or has not failed.
- The expansion card installation guidelines have been followed.

Additional cooling can be added by one of the following methods:

From the iDRAC Web GUI:

1. Click **Hardware** → **Fans** → **Setup**.
2. From the **Fan Speed Offset** drop-down list, select the cooling level needed or set the minimum fan speed to a custom value.

From F2 System Setup:

1. Select **iDRAC Settings** → **Thermal**, and set a higher fan speed from the fan speed offset or minimum fan speed.

From RACADM commands:

1. Run the command `racadm help system.thermalsettings`

For more information, see the Integrated Dell Remote Access Controller User's Guide at Dell.com/idracmanuals.

Troubleshooting cooling fans

Prerequisites

 **CAUTION:** Many repairs may only be done by a certified service technician. You should only perform troubleshooting and simple repairs as authorized in your product documentation, or as directed by the online or telephone service and support team. Damage due to servicing that is not authorized by Dell is not covered by your warranty. Read and follow the safety instructions that came with the product.

 **NOTE:** The fan number is referenced by the systems management software. In the event of a problem with a particular fan, you can easily identify and replace it by noting down the fan numbers on the cooling fan assembly.

Steps

1. Remove the system cover.
2. Reseat the fan or the fan's power cable.
3. Install the system cover.
4. Restart the system.

Next steps

If the problem persists, see [Getting Help](#).

Troubleshooting system memory

Prerequisites



CAUTION: Many repairs may only be done by a certified service technician. You should only perform troubleshooting and simple repairs as authorized in your product documentation, or as directed by the online or telephone service and support team. Damage due to servicing that is not authorized by Dell is not covered by your warranty. Read and follow the safety instructions that came with the product.

Steps

1. If the system is operational, run the appropriate system diagnostic test. See [Using system diagnostics](#) for the available diagnostic tests.
If the diagnostic tests indicate a fault, follow the corrective actions provided by the diagnostic tests.
2. If the system is not operational, turn off the system and attached peripherals, and unplug the system from the power source. Wait at least for 10 seconds, and then reconnect the system to the power source.
3. Turn on the system and attached peripherals, and note the messages on the screen.
If an error message is displayed indicating a fault with a specific memory module, go to step 12.
4. Enter System Setup, and check the system memory setting. Make any changes to the memory settings, if needed.
If the memory settings match the installed memory but the problem still persists, go to step 12.
5. Turn off the system and attached peripherals, and disconnect the system from the electrical outlet.
6. Remove the system cover.
7. Check the memory channels and ensure that they are populated correctly.
 **NOTE:** See the system event log or system messages for the location of the failed memory module. Reinstall the memory device.
8. Reseat the memory modules in their sockets.
9. Install the system.
10. Enter System Setup and check the system memory setting.
If the problem is not resolved, proceed with step 11.
11. Remove the system cover.
12. If a diagnostic test or error message indicates a specific memory module as faulty, swap or replace the module with a known working memory module.
13. To troubleshoot an unspecified faulty memory module, replace the memory module in the first DIMM socket with a module of the same type and capacity.
If an error message is displayed on the screen, this may indicate a problem with the installed DIMM type(s), incorrect DIMM installation, or defective DIMM(s). Follow the on-screen instructions to resolve the problem.

14. Install the system cover.
15. As the system boots, observe any error message that is displayed and the diagnostic indicators on the front of the system.
16. If the memory problem persists, repeat step 12 through step 15 for each memory module installed.

Next steps

If the problem persists after all memory modules have been checked, see [Getting Help](#).

Troubleshooting an internal USB key

Prerequisites

 **CAUTION:** Many repairs may only be done by a certified service technician. You should only perform troubleshooting and simple repairs as authorized in your product documentation, or as directed by the online or telephone service and support team. Damage due to servicing that is not authorized by Dell is not covered by your warranty. Read and follow the safety instructions that came with the product.

Steps

1. Enter System Setup and ensure that the **USB key port** is enabled on the **Integrated Devices** screen.
2. Turn off the system and attached peripherals, and disconnect the system from the electrical outlet.
3. Remove the system cover.
4. Locate the USB key and reseat it.
5. Install the system cover.
6. Turn on the system and attached peripherals, and check if the USB key is functioning.
7. If the problem is not resolved, repeat step 2 and step 3.
8. Insert a known working USB key.
9. Install the system cover.

Next steps

If the problem is not resolved, see [Getting Help](#).

Troubleshooting an SD card

Prerequisites

 **CAUTION:** Many repairs may only be done by a certified service technician. You should only perform troubleshooting and simple repairs as authorized in your product documentation, or as directed by the online or telephone service and support team. Damage due to servicing that is not authorized by Dell is not covered by your warranty. Read and follow the safety instructions that came with the product.

 **NOTE:** Certain SD cards have a physical write-protect switch on the card. If the write-protect switch is turned on, the SD card is not writable.

Steps

1. Enter System Setup, and ensure that the **Internal SD Card Port** is enabled.
2. Turn off the system, including any attached peripherals, and disconnect the system from the electrical outlet.
3. Remove the system cover.

 **NOTE:** When an SD card failure occurs, the internal dual SD module controller notifies the system. On the next restart, the system displays a message indicating the failure. If redundancy is enabled at the time of SD card failure, a critical alert will be logged and chassis health will degrade.

4. Replace the failed SD card with a new SD card.
5. Install the system cover.
6. Reconnect the system to its electrical outlet and turn on the system, including any attached peripherals.
7. Enter System Setup, and ensure that the **Internal SD Card Port** and **Internal SD Card Redundancy** modes are set to the required modes.
Verify that the correct SD slot is set as **Primary SD Card**.
8. Check if the SD card is functioning properly.
9. If the **Internal SD Card Redundancy** option is set to **Enabled** at the time of the SD card failure, the system prompts you to perform a rebuild.

 **NOTE:** The rebuild is always sourced from the primary SD card to the secondary SD card.

Troubleshooting an optical drive

Prerequisites

 **CAUTION:** Many repairs may only be done by a certified service technician. You should only perform troubleshooting and simple repairs as authorized in your product documentation, or as directed by the online or telephone service and support team. Damage due to servicing that is not authorized by Dell is not covered by your warranty. Read and follow the safety instructions that came with the product.

Steps

1. Try using a different CD or DVD.
2. If the problem is not resolved, enter System Setup and ensure that the integrated SATA controller and the drive's SATA port are enabled.
3. Run the appropriate diagnostic test.
4. Turn off the system and attached peripherals, and disconnect the system from the electrical outlet.
5. If installed, remove the bezel.
6. Remove the system cover.
7. Ensure that the interface cable is securely connected to the optical drive and to the controller.
8. Ensure that a power cable is properly connected to the drive.
9. Install the system cover.

Next steps

If the problem is not resolved, see [Getting Help](#).

Troubleshooting a tape backup unit

Prerequisites

 **CAUTION:** Many repairs may only be done by a certified service technician. You should only perform troubleshooting and simple repairs as authorized in your product documentation, or as directed by the online or telephone service and support team. Damage due to servicing that is not authorized by Dell is not covered by your warranty. Read and follow the safety instructions that came with the product.

Steps

1. Use a different tape cartridge.
2. Ensure that the device drivers for the tape backup unit are installed and are configured correctly. See your tape drive documentation for more information about device drivers.
3. Reinstall the tape-backup software as instructed in the tape-backup software documentation.
4. Ensure that the interface cable of the tape drive is connected to the external port on the controller card.
5. Perform the following steps to ensure that the controller card is properly installed:
 - a. Turn off the system and attached peripherals, and disconnect the system from the electrical outlet.
 - b. Remove the system cover.
 - c. Reseat the controller card in the expansion card slot.
 - d. Install the system cover.
 - e. Turn on the system and attached peripherals.
6. Run the appropriate diagnostic test. For more information, see [Using System Diagnostics](#).

Next steps

If you cannot resolve the problem, see [Getting Help](#).

Troubleshooting a hard drive

Prerequisites

 **CAUTION:** Many repairs may only be done by a certified service technician. You should only perform troubleshooting and simple repairs as authorized in your product documentation, or as directed by the online or telephone service and support team. Damage due to servicing that is not authorized by Dell is not covered by your warranty. Read and follow the safety instructions that came with the product.

 **CAUTION:** This troubleshooting procedure can erase data stored on the hard drive. Before you proceed, back up all files on the hard drive.

Steps

1. Run the appropriate diagnostic test. For more information, see [Using System Diagnostics](#). Depending on the results of the diagnostics test, proceed as needed through the following steps.
2. If your system has a RAID controller and your hard drives are configured in a RAID array, perform the following steps:
 - a. Restart the system and press F10 during system startup to run the Dell Lifecycle Controller, and then run the Hardware Configuration wizard to check the RAID configuration. See the Dell Lifecycle Controller documentation or online help for information on RAID configuration.

- b. Ensure that the hard drives are configured correctly for the RAID array.
 - c. Take the hard drive offline and reseal the drive.
 - d. Exit the configuration utility and allow the system to boot to the operating system.
3. Ensure that the required device drivers for your controller card are installed and are configured correctly. See the operating system documentation for more information.
 4. Restart the system and enter the System Setup.
 5. Verify that the controller is enabled and the drives are displayed in the System Setup.

Next steps

If the problem persists, try troubleshooting the expansion cards or see [Getting Help](#).

Troubleshooting a storage controller

 **CAUTION:** Many repairs may only be done by a certified service technician. You should only perform troubleshooting and simple repairs as authorized in your product documentation, or as directed by the online or telephone service and support team. Damage due to servicing that is not authorized by Dell is not covered by your warranty. Read and follow the safety instructions that came with the product.

 **NOTE:** When troubleshooting a SAS or PERC controller, see the documentation for your operating system and the controller.

1. Run the appropriate diagnostic test. For more information, see [Using system diagnostics](#).
2. Turn off the system and attached peripherals, and disconnect the system from the electrical outlet.
3. Remove the system cover.
4. Verify that the installed expansion cards are compliant with the expansion card installation guidelines.
5. Ensure that each expansion card is firmly seated in its connector.
6. Install the system cover.
7. Reconnect the system to the electrical outlet, and turn on the system and attached peripherals.
8. If the problem is not resolved, turn off the system and attached peripherals, and disconnect the system from the electrical outlet.
9. Remove the system cover.
10. Remove all expansion cards installed in the system.
11. Install the system cover.
12. Reconnect the system to the electrical outlet, and turn on the system and attached peripherals.
13. Run the appropriate diagnostic test. For more information, see [Using system diagnostics](#). If the tests fail, see [Getting Help](#).
14. For each expansion card you removed in step 10, perform the following steps:
 - a. Turn off the system and attached peripherals, and disconnect the system from the electrical outlet.
 - b. Remove the system cover.
 - c. Reinstall one of the expansion cards.
 - d. Install the system cover.
 - e. Run the appropriate diagnostic test. For more information, see [Using system diagnostics](#).

If the tests fail, see [Getting Help](#).

Troubleshooting expansion cards

Prerequisites

 **CAUTION:** Many repairs may only be done by a certified service technician. You should only perform troubleshooting and simple repairs as authorized in your product documentation, or as directed by the online or telephone service and support team. Damage due to servicing that is not authorized by Dell is not covered by your warranty. Read and follow the safety instructions that came with the product.

 **NOTE:** When troubleshooting an expansion card, you also have to see the documentation for your operating system and the expansion card.

Steps

1. Run the appropriate diagnostic test. For more information, see [Using system diagnostics](#).
2. Turn off the system and attached peripherals, and disconnect the system from the electrical outlet.
3. Remove the system cover.
4. Ensure that each expansion card is firmly seated in its connector.
5. Install the system cover.
6. Turn on the system and attached peripherals.
7. If the problem is not resolved, turn off the system and attached peripherals, and disconnect the system from the electrical outlet.
8. Remove the system cover.
9. Remove all expansion cards installed in the system.
10. Install the system cover.
11. Run the appropriate diagnostic test. For more information, see [Using system diagnostics](#).
If the tests fail, see [Getting Help](#).
12. For each expansion card you removed in step 8, perform the following steps:
 - a. Turn off the system and attached peripherals, and disconnect the system from the electrical outlet.
 - b. Remove the system cover.
 - c. Reinstall one of the expansion cards.
 - d. Install the system cover.
 - e. Run the appropriate diagnostic test. For more information, see [Using system diagnostics](#).
13. If the problem persists, see [Getting Help](#).

Troubleshooting processors

Prerequisites

 **CAUTION:** Many repairs may only be done by a certified service technician. You should only perform troubleshooting and simple repairs as authorized in your product documentation, or as directed by the online or telephone service and support team. Damage due to servicing that is not authorized by Dell is not covered by your warranty. Read and follow the safety instructions that came with the product.

Steps

1. Run the appropriate diagnostics test. See [Using system diagnostics](#) for available diagnostic tests.
2. Turn off the system and attached peripherals, and disconnect the system from the electrical outlet.
3. Remove the system cover.

4. Ensure that the processor and heat sink are properly installed.
5. Install the system cover.
6. Run the appropriate diagnostic test. For more information, see [Using system diagnostics](#).
7. If the problem persists, see [Getting Help](#).

Using system diagnostics

If you experience a problem with your system, run the system diagnostics before contacting Dell for technical assistance. The purpose of running system diagnostics is to test your system hardware without requiring additional equipment or risking data loss. If you are unable to fix the problem yourself, service and support personnel can use the diagnostics results to help you solve the problem.

Dell Embedded System Diagnostics

 **NOTE:** The Dell Embedded System Diagnostics is also known as Enhanced Pre-boot System Assessment (ePSA) diagnostics.

The Embedded System Diagnostics provides a set of options for particular device groups or devices enabling you to:

- Run tests automatically or in an interactive mode
- Repeat tests
- Display or save test results
- Run thorough tests to introduce additional test options to provide extra information about the failed device(s)
- View status messages that inform you if tests are completed successfully
- View error messages that inform you of problems encountered during testing

When to use the Embedded System Diagnostics

Run the Embedded System Diagnostics (ePSA) if your system does boot.

Running the Embedded System Diagnostics from Boot Manager

1. When the system is booting, press **F11**.
2. Use the up and down arrow keys to select **System Utilities** → **Launch Diagnostics**.
The **ePSA Pre-boot System Assessment** window is displayed, listing all devices detected in the system. The diagnostics starts executing the tests on all the detected devices.

Running the Embedded System Diagnostics from the Dell Lifecycle Controller

1. As the system boots, press F11.
2. Select **Hardware Diagnostics** → **Run Hardware Diagnostics**.
The **ePSA Pre-boot System Assessment** window is displayed, listing all devices detected in the system. The diagnostics starts executing the tests on all the detected devices.

System diagnostics controls

| Menu | Description |
|---------------|---|
| Configuration | Displays the configuration and status of all detected devices. |
| Results | Displays the results of all tests that are executed. |
| System health | Provides the current overview of the system performance. |
| Event log | Displays a time-stamped log of the results of all tests run on the system. This is displayed if at least one event description is recorded. |

Jumpers and connectors

System board jumper settings

⚠ CAUTION: Many repairs may only be done by a certified service technician. You should only perform troubleshooting and simple repairs as authorized in your product documentation, or as directed by the online or telephone service and support team. Damage due to servicing that is not authorized by Dell is not covered by your warranty. Read and follow the safety instructions that came with the product.

For information about resetting the password jumper to disable a password, see [Disabling a forgotten password](#).

Table 18. System Board Jumper settings

| Jumper | Setting | Description |
|-----------|-----------------|---|
| PWRD_EN | 1 2 3 (default) | The password feature is enabled (pins 1–2). |
| | 1 2 3 | The password feature is disabled (pins 2–3). |
| NVRAM_CLR | 1 2 3 (default) | The configuration settings are retained at system boot (pins 2–3). |
| | 1 2 3 | The configuration settings are cleared at the next system boot. (pins 1–2). |

System board connectors

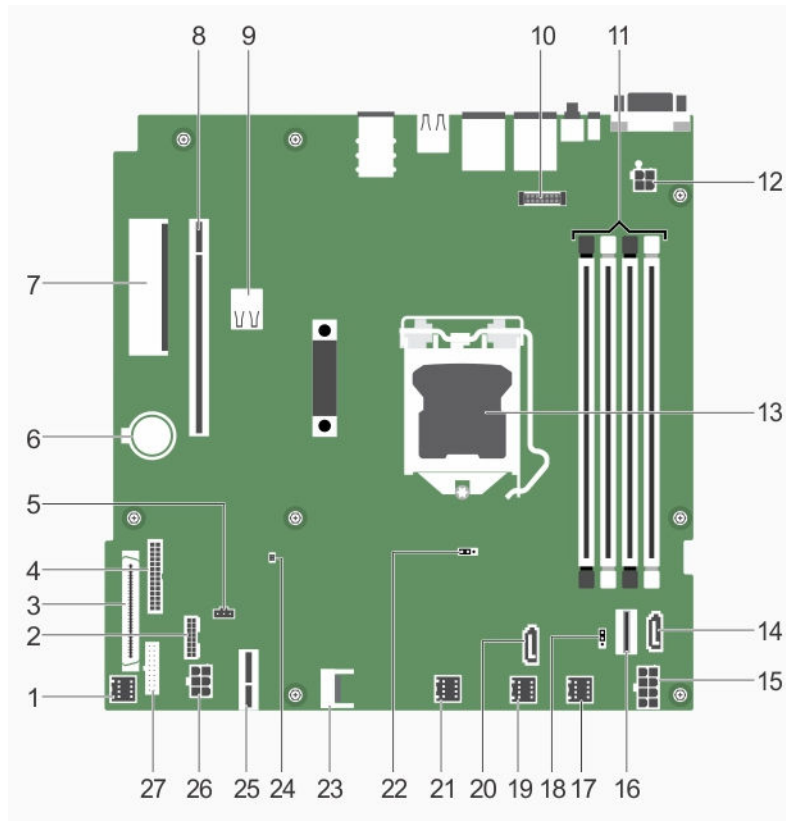

Figure 63. System board connectors

Table 19. System board connectors

| Item | Connector | Description |
|------|-------------|-----------------------------------|
| 1 | FAN1 | Cooling fan connector |
| 2 | BP_SIG | Backplane signal connector |
| 3 | CTRL_PNL | Control panel interface connector |
| 4 | PIB_CONN | Power connector |
| 5 | R_INTRUSION | Intrusion switch connector |
| 6 | BATTERY | Battery connector |
| 7 | PCIE_G3_X4 | Internal PERC connector |
| 8 | PCIE_G3_X8 | Riser card connector |
| 9 | INT_USB_3.0 | Internal USB connector 3.0 |
| 10 | AMEA | iDRAC port card connector |
| 11 | DIMMs | Memory module sockets |

| Item | Connector | Description |
|------|--------------|-----------------------------------|
| 12 | CPU_PWR | 4-pin power connector |
| 13 | CPU | Processor socket |
| 14 | SATA_ODD/SSD | Optical drive/SSD SATA connector |
| 15 | SYS_PWR | 8-pin power connector |
| 16 | SATA0-3 | SATA connector |
| 17 | FAN4 | Cooling fan connector |
| 18 | PWRD_EN | Password jumpers |
| 19 | FAN3 | Cooling fan connector |
| 20 | J_SATA_2 | SATA SSD connector |
| 21 | FAN2 | Cooling fan connector |
| 22 | NVRAM_CLR | NVRAM password jumper |
| 23 | TPM | Trusted Platform Module connector |
| 24 | SAS_LED | PERC card LED connector |
| 25 | IDSDM | Internal dual SD module connector |
| 26 | HDD/ODD_PWR | 6-pin power connector |
| 27 | FP_USB | Front panel USB connector |

Disabling a forgotten password

The system's software security features include a system password and a setup password. The password jumper enables these password features or disables them and clears any password(s) currently in use.

Prerequisites



CAUTION: Many repairs may only be done by a certified service technician. You should only perform troubleshooting and simple repairs as authorized in your product documentation, or as directed by the online or telephone service and support team. Damage due to servicing that is not authorized by Dell is not covered by your warranty. Read and follow the safety instructions that came with the product.

Steps

1. Turn off the system, including any attached peripherals, and disconnect the system from the electrical outlet.
2. Remove the system cover.
3. Move the jumper on the system board jumper from pins 2 and 3 to pins 1 and 2.
4. Install the system cover.

The existing passwords are not disabled (erased) until the system boots with the jumper on pins 1 and 2. However, before you assign a new system and/or setup password, you must move the jumper back to pins 2 and 3.



NOTE: If you assign a new system and/or setup password with the jumper on pins 1 and 2, the system disables the new password(s) the next time it boots.

5. Reconnect the system to its electrical outlet and turn on the system, including any attached peripherals.
6. Turn off the system, including any attached peripherals, and disconnect the system from the electrical outlet.
7. Remove the system cover.
8. Move the jumper on the system board jumper from pins 1 and 2 to pins 2 and 3.
9. Install the system cover.
10. Reconnect the system to its electrical outlet and turn on the system, including any attached peripherals.
11. Assign a new system or setup password.

Technical specifications

Dimensions and weight

| Physical | Dimensions |
|---|------------------------|
| Height | 42.8 mm (1.68 inch) |
| Width with rack latches | 482.38 mm (18.99 inch) |
| Width without rack latches | 434.15 mm (17.09 inch) |
| Depth without bezel | 610 mm (24 inch) |
| Maximum weight for four hard drive chassis | 13.8 kg (30.42 lbs) |
| Maximum weight for eight hard drive chassis | 13.4 kg (29.54 lbs) |
| Empty weight for four hard drive chassis | 6.0 kg (13.22 lbs) |
| Empty weight for eight hard drive chassis | 6.4 kg (14.1 lbs) |

Processor specifications

| Processor | Specification |
|-----------|-----------------------------|
| Type | One Intel E3-1200 V5 series |

Expansion bus specifications

PCI Express (PCIe) Generation 3 expansion slots (with optional expansion card risers)

| | |
|-----------|--------------------------------------|
| LP SLOT 1 | One half-height, half-length x4 link |
| FH SLOT 2 | One full-height, half-length x8 link |

PCI Express Generation 3 expansion slots (without expansion card risers)

| | |
|------------|--|
| PCIE_G3_X4 | One half-height, half-length x4 link for PERC card |
| PCIE_G3_X8 | One x8 link for riser |

Memory specifications



Memory Specification

| | |
|----------------------------------|--|
| Architecture | 1600 MT/s, 1866 MT/s, or 2133 MT/s DDR4 Unbuffered DIMMs Support for advanced ECC or memory optimized operation |
| Memory module sockets | Four 288-pin sockets |
| Memory module capacities (UDIMM) | 4 GB (single-rank), 8 GB (single- and dual-rank), 16 GB (single- and dual-rank) |
| Minimum RAM | 4 GB |
| Maximum RAM | 64 GB |

Power specifications

Power supply unit Specification



| | |
|------------------------------------|--|
| Power rating per power supply unit | 350 W (Platinum) (100–240 V AC, 50/60 Hz, 4.8 A–2.4 A) |
|------------------------------------|--|

| Power supply unit | Specification |
|-------------------|---|
| Heat dissipation | 1357.1 BTU/hr  NOTE: Heat dissipation is calculated by using the power supply wattage rating. |
| Voltage | 100-240 V AC, autoranging, 50/60 Hz  NOTE: This system is also designed to be connected to IT power systems with a phase-to-phase voltage not exceeding 230 V. |

Storage controller specifications

| Storage controller | Specification |
|-------------------------|---|
| Storage controller type | PERC H730, PERC H330, PERC H830, PERC S130.  NOTE: Your system supports software RAID S130 and a PERC card. For more information on software RAID, see the Dell PowerEdge RAID Controller (PERC) documentation at Dell.com/storagecontrollermanuals . |

Drive specifications

| Drives | Specification |
|---------------------------|---|
| Eight hard drive systems | Up to eight 2.5-inch, hot swappable SAS, SATA, SATA SSD, or Nearline SAS hard drives. |
| Four hard drive systems | Up to four 3.5-inch cabled hard drives, or Up to four 3.5-inch hot swappable SAS, SATA, or Nearline SAS hard drives, or Up to four 2.5-inch hot swappable SAS, SATA, SATA SSD, or Nearline SAS hard drives.  NOTE: For more information about software RAID, see the Dell PowerEdge RAID Controller (PERC) documentation at Dell.com/storagecontrollermanuals . |
| Optical drive | One optional slim SATA DVD-ROM or DVD+/-RW drive. |
| Solid state drives (SSDs) | Up to two 1.8-inch SSDs in the optical drive slot.  NOTE: 1.8-inch SSDs can be installed only on systems with cabled hard drives. |

Connectors specifications

Back connectors

Specification

| | |
|--------------------|------------------------------------|
| NIC | Two 10/100/1000 Mbps |
| Serial | DB-9 Serial Port connector |
| USB | Two 9-pin, USB 3.0-compliant |
| Video | 15-pin VGA |
| iDRAC8 | One optional 1 GbE Ethernet |
| External SD vFlash | One optional SD vFlash memory card |

 **NOTE:** The card slot is available for use only if the iDRAC8 Enterprise license is installed on your system.

Front connectors

Specification

| | |
|-------|------------------------------|
| USB | Two 4-pin, USB 2.0-compliant |
| Video | 15-pin VGA |

 **NOTE:** The front VGA port is available only with the rack configuration.

Internal connectors

Specification

| | |
|-------------------------|--|
| USB | One 9-pin, USB 3.0-compliant |
| Internal Dual SD Module | Two optional flash memory card slots with the internal SD module |

 **NOTE:** One card slot is dedicated for redundancy.

Video specifications

Video

Specification

| | |
|--------------|------------------------|
| Video type | Integrated Matrox G200 |
| Video memory | 16 MB shared |

Expanded operating temperature

 **NOTE:** When operating in the expanded temperature range, system performance may be impacted.

 **NOTE:** When operating in the expanded temperature range, ambient temperature warnings may be reported on the LCD and in the System Event Log.

Expanded operating temperature

≤ 10% of annual operating hours

Specifications

5°C to 40°C at 5% to 85% RH with 26°C dew point.

 **NOTE:** Outside the standard operating temperature (10°C to 35°C), the system can operate down to 5°C or up to 40°C for a maximum of 10% of its annual operating hours.

For temperatures between 35°C and 40°C, de-rate maximum allowable dry bulb temperature by 1°C per 175 m above 950 m (1°F per 319 ft).

≤ 1% of annual operating hours

–5°C to 45°C at 5% to 90% RH with 26°C dew point.

 **NOTE:** Outside the standard operating temperature (10°C to 35°C), the system can operate down to –5°C or up to 45°C for a maximum of 1% of its annual operating hours.

For temperatures between 40°C and 45°C, de-rate maximum allowable dry bulb temperature by 1°C per 125 m above 950 m (1°F per 228 ft).

Expanded Operating Temperature Restrictions

- The operating temperature specified is for a maximum altitude of 3048 m (10,000 ft).
- Non-redundant power supply units are not supported.
- Non Dell qualified peripheral cards and/or peripheral cards greater than 25 W are not supported.
- Do not perform a cold startup below 5°C.
- Enable processor performance degrade.

Environmental specifications

 **NOTE:** For additional information about environmental measurements for specific system configurations, see [Dell.com/environmental_datasheets](https://www.dell.com/environmental_datasheets).

Temperature

Specifications

Storage

–40°C to 65°C (–40°F to 149°F)

Continuous operation (for altitude less than 950 m or 3117 ft)

10°C to 35°C (50°F to 95°F) with no direct sunlight on the equipment.

Fresh air

For information on fresh air, see Expanded Operating Temperature section.

Maximum temperature gradient (operating and storage)

20°C/h (36°F/h)

| | |
|--------------------------|--|
| Relative humidity | Specifications |
| Storage | 5% to 95% RH with 33°C (91°F) maximum dew point. Atmosphere must be non-condensing at all times. |
| Operating | 10% to 80% Relative Humidity with 29°C (84.2°F) maximum dew point. |



| | |
|--------------------------|---|
| Maximum vibration | Specifications |
| Operating | 0.26 G _{rms} at 5 Hz to 350 Hz (all operation orientations). |
| Storage | 1.88 G _{rms} at 10 Hz to 500 Hz for 15 min (all six sides tested). |

| | |
|----------------------|--|
| Maximum shock | Specifications |
| Operating | Six consecutively executed shock pulses in the positive and negative x, y, and z axes of 40 G for up to 2.3 ms. |
| Storage | Six consecutively executed shock pulses in the positive and negative x, y, and z axes (one pulse on each side of the system) of 71 G for up to 2 ms. |

| | |
|-------------------------|-----------------------|
| Maximum altitude | Specifications |
| Operating | 3048 m (10,000 ft). |
| Storage | 12,000 m (39,370 ft). |

| | |
|--|---|
| Operating temperature de-rating | Specifications |
| Up to 35 °C (95 °F) | Maximum temperature is reduced by 1°C/300 m (1°F/547 ft) above 950 m (3,117 ft) |

The following section defines the limits to help avoid IT equipment damage and/or failure from particulates and gaseous contamination. If the levels of particulates or gaseous pollution are beyond the specified limits and cause equipment damage or failure, you may need to rectify the environmental conditions. Remediation of environmental conditions is the responsibility of the customer.

| | |
|----------------------------------|--|
| Particulate contamination | Specifications |
| Air filtration | Data center air filtration as defined by ISO Class 8 per ISO 14644-1 with a 95% upper confidence limit. |
| |  NOTE: Applies to data center environments only. Air filtration requirements do not apply to IT equipment designed to be used outside a data center, in environments such as an office or factory floor. |
| |  NOTE: Air entering the data center must have MERV11 or MERV13 filtration. |
| Conductive dust | Air must be free of conductive dust, zinc whiskers, or other conductive particles. |

Particulate contamination

Specifications

 **NOTE:** Applies to data center and non-data center environments.

Corrosive dust

- Air must be free of corrosive dust.
- Residual dust present in the air must have a deliquescent point less than 60% relative humidity.

 **NOTE:** Applies to data center and non-data center environments.

Gaseous contamination

Specifications

Copper coupon corrosion rate

<300 Å/month per Class G1 as defined by ANSI/ISA71.04-1985.

Silver coupon corrosion rate

<200 Å/month as defined by AHSRAE TC9.9.

 **NOTE:** Maximum corrosive contaminant levels measured at $\leq 50\%$ relative humidity.

Getting help

Contacting Dell

Dell provides several online and telephone-based support and service options. If you do not have an active internet connection, you can find contact information on your purchase invoice, packing slip, bill, or Dell product catalog. Availability varies by country and product, and some services may not be available in your area. To contact Dell for sales, technical assistance, or customer-service issues:

1. Go to **Dell.com/support**.
2. Select your country from the drop-down menu on the bottom right corner of the page.
3. For customized support:
 - a. Enter your system Service Tag in the **Enter your Service Tag** field.
 - b. Click **Submit**.
The support page that lists the various support categories is displayed.
4. For general support:
 - a. Select your product category.
 - b. Select your product segment.
 - c. Select your product.
The support page that lists the various support categories is displayed.

Locating your system Service Tag

Your system is identified by a unique Express Service Code and Service Tag number. The Express Service Code and Service Tag are found on the front of the system by pulling out the information tag. Alternatively, the information may be on a sticker on the chassis of the system. This information is used by Dell to route support calls to the appropriate personnel.

 **NOTE:** The Quick Resource Locator (QRL) code on the information tag is unique to your system. Scan the QRL to get immediate access to your system information using your smart phone or tablet.

Documentation feedback

Click the **Feedback** link in any of the Dell documentation pages, fill out the form, and click **Submit** to send your feedback.