

Dell EMC PowerEdge R450

Technical Guide

Notes, cautions, and warnings

 **NOTE:** A NOTE indicates important information that helps you make better use of your product.

 **CAUTION:** A CAUTION indicates either potential damage to hardware or loss of data and tells you how to avoid the problem.

 **WARNING:** A WARNING indicates a potential for property damage, personal injury, or death.

Chapter 1: System overview	5
Key workloads.....	5
New technologies.....	5
Chapter 2: System features and generational comparison	7
Chapter 3: Chassis views and features	9
Chassis views.....	9
Front view of the system.....	9
Rear view of the system.....	9
Inside the system.....	10
Quick Resource Locator.....	11
Chapter 4: Processor	12
Processor features	12
Supported processors.....	12
Chapter 5: Memory subsystem	13
Supported memory.....	13
Memory speed.....	14
Chapter 6: Storage	15
Storage controllers.....	15
Supported drives.....	15
External storage.....	16
Chapter 7: Networking	17
Overview.....	17
Supported OCP cards.....	17
OCP form factors.....	18
OCP NIC 3.0 vs. rack Network Daughter Card comparisons.....	18
Chapter 8: Expansion cards and expansion card risers	20
Expansion card installation guidelines.....	20
Chapter 9: Power, thermal, and acoustics	24
Power.....	24
Thermal design.....	25
PowerEdge R450 acoustics.....	25
Acoustical performance.....	26
Chapter 10: Rack, rails, and cable management	28
Rails information.....	28

Sliding Rails.....	28
Static Rails.....	29
Cable Management Arm.....	29
Strain Relief Bar	29
Chapter 11: Supported Operating Systems.....	30
Chapter 12: Dell EMC OpenManage systems management.....	31
Server and Chassis Managers.....	32
Dell EMC consoles.....	32
Automation Enablers.....	32
Integration with third-party consoles.....	32
Connections for third-party consoles.....	32
Dell EMC Update Utilities.....	32
Dell resources.....	32
Chapter 13: Dell Technologies Services	34
Dell EMC ProDeploy Enterprise Suite	34
Dell EMC ProDeploy Plus.....	35
Dell EMC ProDeploy.....	35
Basic Deployment.....	35
Dell EMC ProDeploy for HPC.....	35
Dell EMC Server Configuration Services.....	36
Dell EMC Residency Services.....	36
Dell EMC Data Migration Service.....	36
Dell EMC ProSupport Enterprise Suite.....	36
Dell EMC ProSupport Plus for Enterprise.....	37
Dell EMC ProSupport for Enterprise.....	37
Dell EMC ProSupport One for Data Center.....	38
ProSupport for HPC.....	38
Support Technologies.....	38
Services for Data Security.....	39
Dell Technologies Education Services.....	40
Dell Technologies Consulting Services.....	40
Dell EMC Remote Consulting Services.....	40
Dell EMC Managed Services.....	40
Chapter 14: Appendix A. Additional specifications.....	41
Chassis dimensions.....	41
Chassis weight.....	42
Video specifications.....	42
USB Ports.....	43
PSU rating.....	43
Environmental specifications.....	44
Thermal restrictions.....	46
Chapter 15: Appendix B. Standards compliance.....	48
Chapter 16: Appendix C Additional resources.....	49

System overview

The Dell™ PowerEdge™ R450 is Dell's latest 2-socket, 1 U rack servers designed to run complex workloads using highly scalable memory, I/O, and network options. The systems feature 3rd Generation Intel® Xeon® Processor Scalable Family, up to 16 DIMMs, PCI Express® (PCIe) 4.0 enabled expansion slots, and a choice of network interface technologies to cover NIC. The R450 is a general-purpose platform capable of handling demanding workloads and applications, such as data warehouses, ecommerce, databases, and high-performance computing (HPC).

Topics:

- [Key workloads](#)
- [New technologies](#)

Key workloads

The target workloads for the PowerEdge R450 include light duty virtualization, small IT infrastructure, and small business specific workloads.

New technologies

Technology	Detailed Description
3rd Generation Intel® Xeon® Processor	Core count: Up to 24 per processor supported on R450 UPI speed: Up to 3x UPIs/Socket at 10.4 GT/s or 11.2 GT/s Maximum number of PCIe lanes: Integrated 64 PCIe 4.0 lanes @ 16 GT/s PCIe Gen4 Maximum TDP: 185 W
3200 MT/s DDR4 Memory	Maximum 8 DIMMs per processor and 16 DIMMs in total Supports DDR4 ECC RDIMM, with ECC up to 2933 MT/s on R450 as the memory speed depends on the processor supported by the system.
Flex IO	LOM, 2x 1 Gb with BCM5720 LAN controller Rear IO with 1 Gb Dedicated Management Network Port, USB 3.0 x1, USB 2.0 x1 and VGA port Serial port option OCP Mezz 3.0 (supported by x16 PCIe lanes)
Dedicated PERC	Front storage module PERC with front PERC 10.5 and PERC 11
Software RAID	OS RAID/S150
Power Supplies	60 mm dimension is the new PSU form factor on 15G design <ul style="list-style-type: none"> • Platinum 600 W AC/HVDC • Platinum 800 W AC/HVDC

Technology	Detailed Description
	<ul style="list-style-type: none"><li data-bbox="810 230 997 253">• 1100 W HVDC

System features and generational comparison

The following table shows the comparison between the PowerEdge R450 with the PowerEdge R440.

Table 1. Features compared to previous version

Feature	PowerEdge R450	PowerEdge R440
Processor	Up to two 3rd Generation Intel Xeon Scalable processors with up to 24 cores per processor	2nd Generation Intel® Xeon® Scalable Processor Family
Processor Interconnect	Intel Ultra Path Interconnect (Intel UPIx3)	Intel Ultra Path Interconnect (Intel UPI)
Memory	16x RDIMM/No NVDIMM	16x DDR4 RDIMM, LRDIMM
Storage Drives	Up to 4 x 3.5-inch SAS/SATA (HDD/SSD) max 64 TB Up to 8 x 2.5-inch SAS/SATA (HDD/SSD) max 61.44 TB	Up to 10 x 2.5" SAS/SATA (HDD/SSD) with up to 4 NVMe SSD max 76.8 TB or Up to 4 x 3.5 SAS/SATA HDD max 64 TB
Storage Controllers	Internal controllers: PERC H345, PERC H745, PERC H755, HBA355i, S150 Internal Boot: Internal Dual SD Module or Boot Optimized Storage Subsystem (BOSS-S1): HWRAID 2 x M.2 SSDs or USB External PERC (RAID): PERC H840, HBA355e	Internal Controllers: PERC H330, H730P, H740P, HBA330 External Controllers: H840, 12 Gbps SAS HBA Software RAID:S140 Boot Optimized Storage Subsystem (BOSS):HWRAID 2 x M.2 SSDs 240GB, 480GB Internal Dual SD Module
PCIe Slots	2 x PCIe Gen4 slots	2 x PCIe Gen3 (x16/x16)
Embedded NIC (LOM)	2 x 1GbE	2 x 1GbE + OCP riser: LRC 2 x 1GbE or 2 x 10GbE
Networking options (OCP 3.0)	OCP3 x16 Gen4	OCP2 x16 Gen3
I/O Ports	Front ports: <ul style="list-style-type: none"> 1 x iDRAC Direct (Micro-AB USB) port 1 x USB 2.0 1x VGA Rear ports: <ul style="list-style-type: none"> 1 x USB 2.0 1 x Serial (optional) 1 x USB 3.0 2 x Ethernet 1 x VGA 1 x Dedicated iDRAC network port Internal Port: 1 x USB 3.0 (optional)	Front ports: <ul style="list-style-type: none"> 1 x iDRAC Direct (Micro-AB USB) port 1 x USB 2.0 1x VGA Rear ports: <ul style="list-style-type: none"> 1 x USB 2.0 1 x Serial (optional) 2 x USB 3.0 1 x Dedicated iDRAC network port Up to 2 x PCIe Gen 3 slots all x16

Table 1. Features compared to previous version (continued)

Feature	PowerEdge R450	PowerEdge R440
Rack Height	1U	1U
Power Supplies	1100 W DC / -48-(-60) V 800 W Platinum AC/240 V HVDC 600 W Platinum AC/240 V HVDC	Bronze 450W (Cabled PSU) Platinum 550W (Hot plug PSU with full redundancy option)
System Management	iDRAC9 iDRAC Direct iDRAC Service Module Quick Sync 2 wireless module	iDRAC9 iDRAC9 Direct iDRAC REST API with Redfish Quick Sync 2 BLE/wireless module
Internal GPU	No GPU support	No GPU support
Availability	Hot-plug Drives Hot-plug Redundant Power Supplies iDSDM	Hot-plug Drives Hot-plug Redundant Power Supplies iDSDM

Chassis views and features

Topics:

- Chassis views

Chassis views

Front view of the system



Figure 1. Front view of 4 x 3.5-inch drive system



Figure 2. Front view of 8 x 2.5-inch drive system

Rear view of the system

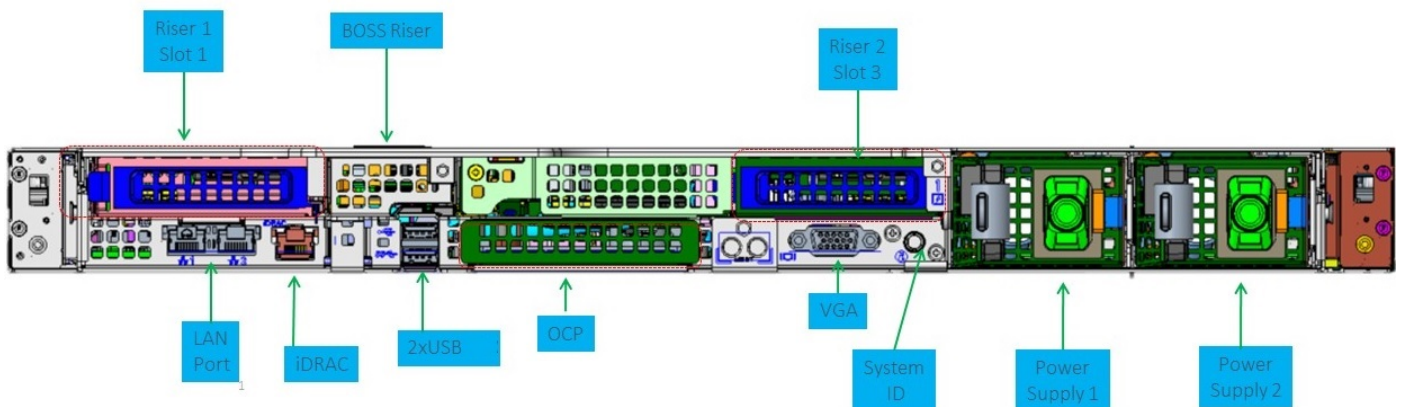

Figure 3. Rear view of the system

Inside the system

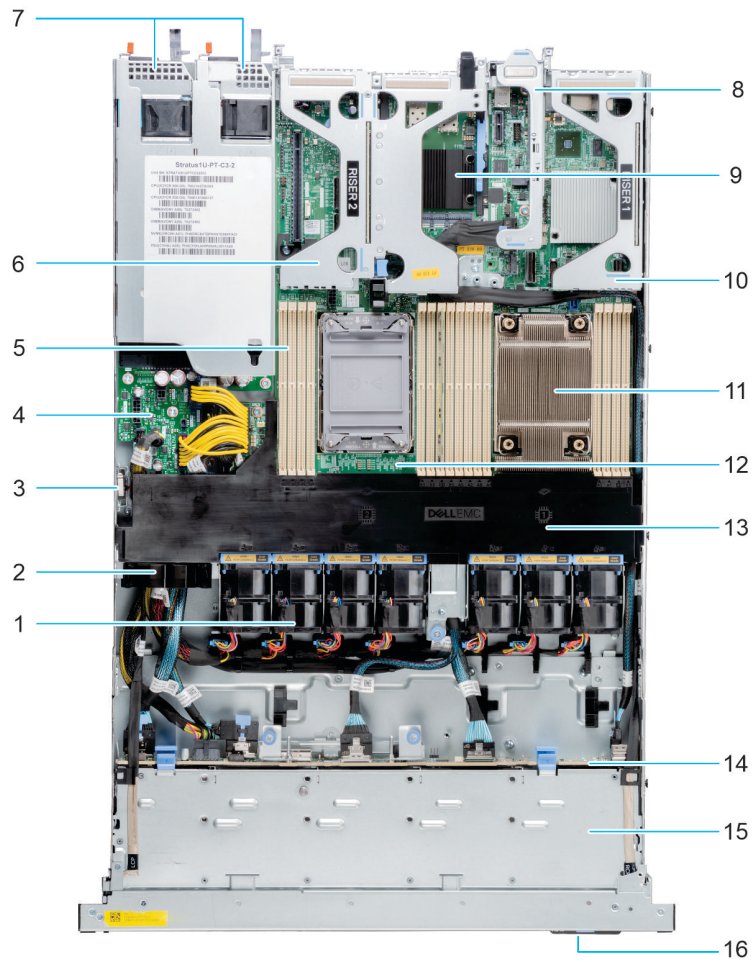

Figure 4. Inside the system

- | | |
|------------------------|---------------------------|
| 1. Fan | 2. Cable retention latch |
| 3. Intrusion switch | 4. Power interposer board |
| 5. Memory module slots | 6. Riser 2c |
| 7. PSU 1 and PSU 2 | 8. BOSS riser |
| 9. OCP | 10. Riser 1 |
| 11. Heat sink | 12. System board |
| 13. Air shroud | 14. Drive backplane |
| 15. Backplane cover | 16. Information tag |

Quick Resource Locator



Figure 5. Quick Resource Locator for R450

Processor



Topics:

- [Processor features](#)
- [Supported processors](#)

Processor features

The 3rd Generation Xeon Scalable Processors stack is the next generation data center processor offering with the latest features, increased performance, and incremental memory options. This latest generation Xeon Scalable processor will support usages from entry designs based on Intel Xeon Silver processors to advanced capabilities offered in new Intel Xeon Platinum processor.

The following lists the features and functions included in the upcoming 3rd Generation Intel Xeon Scalable Processor offering :

- Faster UPI with 3 Intel Ultra Path Interconnect (Intel UPI) at 11.2 GT/s (supported in gold and platinum options)
- More, Faster I/O with PCI Express 4 and up to 64 lanes (per socket) at 16 GT/s
- Enhanced Memory Performance with support for up to 2933 MT/s DIMMs (2 DPC)

Supported processors

Following tables list the various Processor SKUs supported.

Table 2. Supported processors for R450

Processor	Clock Speed (GHz)	Cache (M)	UPI (GT/s)	Cores	Threads	Turbo	Memory Speed (MT/s)	Memory Capacity	TDP	R450
5318Y	2.1	36	11.2	24	48	Turbo	2933	6TB	165W	Supported
5317	3	18	11.2	12	24	Turbo	2933	6TB	150W	Supported
5315Y	3.2	12	11.2	8	16	Turbo	2933	6TB	140W	Supported
4316	2.3	30	10.4	20	40	Turbo	2666	6TB	150W	Supported
4314	2.4	24	10.4	16	32	Turbo	2666	6TB	135W	Supported
4310	2.1	18	10.4	12	24	Turbo	2666	6TB	120W	Supported
4309Y	2.8	12	10.4	8	16	Turbo	2666	6TB	105W	Supported

Memory subsystem

The R450 supports up to 16 DIMMs, with up to 1024GB of memory and speeds of up to 3200MT/s.

The R450 supports registered (RDIMMs) which use a buffer to reduce memory loading and provide greater density, allowing for the maximum platform memory capacity. Unbuffered DIMMs (UDIMMs) are not supported.

Topics:

- [Supported memory](#)
- [Memory speed](#)

Supported memory

The table below lists the memory technologies supported by the platform.

Table 3. Supported memory technologies

Feature	PowerEdge R450 (DDR4)
DIMM type	RDIMM
Transfer speed	2933 MT/s
Voltage	1.2 V (DDR4)

The following table lists the supported DIMMs for the R450 at launch. For information on memory configuration, see the *Dell EMC PowerEdge R450 Installation and Service Manual* at www.dell.com/poweredgemanuals.

Table 4. Supported DIMMs

DIMM Speed (MT/s)	DIMM Type	DIMM Capacity (GB)	Ranks per DIMM	Data Width	DIMM Volts
3200	RDIMM	8 GB	1R	8	1.2 V
3200	RDIMM	16 GB	2R	8	1.2 V
3200	RDIMM	32 GB	2R	8	1.2 V
3200	RDIMM	64 GB	2R	4	1.2 V

NOTE: Maximum memory speed depends on the processor specification. The DIMM can support up to 3200 MT/s, but the memory may not support this memory speed. See [Supported Processors](#) table for the processor type and the supported memory speed.

Memory speed

Table 5. DIMM performance details

DIMM type	Ranks per DIMM and Data Width	DIMM Capacity (GB)		Speed (MT/s) ;Voltage (V);
				DIMM Per Channel (DPC)
				1 DPC
				1.2 V
RDIMM	SRx8	8 GB	16 GB	D: 2933
	SRx4	16 GB	32 GB	
	DRx8	16 GB	32 GB	D: 2933
	DRx4	32 GB	64 GB	

i **NOTE:** Maximum memory speed depends on the processor specification. The DIMM can support upto 3200 MT/s, but the memory may not support this memory speed. See [Supported Processors](#) table for the processor type and the supported memory speed.

Storage

Topics:

- [Storage controllers](#)
- [Supported drives](#)
- [External storage](#)

Storage controllers

Dell's RAID controller options offer performance improvements, including the fPERC solution. fPERC provides a base RAID HW controller without consuming a PCIe slot by using a small form factor and high-density connector to the base planar.

15G PERC Controller offerings will be a heavy leverage of 14G PERC family. The Value and Value Performance levels will carry over to 15G from 14G. New to 15G, is the Harpoon-based Premium Performance tier offering. This high-end offering will drive IOPs performance and enhanced SSD performance.

15G PERC Controller offerings will be a heavy leverage of 14G PERC family. The Value and Value Performance levels will carry over to 15G from 14G. New to 15G, is the Harpoon-based Premium Performance tier offering. This high-end offering will drive IOPs performance and enhanced SSD performance.

Table 6. PERC Series Controller Offerings

Performance Level	Controller and Description
Entry	S150 (SATA) SW RAID SATA
Value	H345, HBA355 (Internal/External)
Value Performance	H745, H755

Supported drives

The table shown below lists the internal drives supported by the R450.

Table 7. Supported drives

Form Factor	Type	Speed	Rotational Speed	Capacities
2.5-inch	SATA	6 Gb	SSD	120 GB, 200 GB, 240 GB, 400 GB, 480 GB, 800 GB, 960 GB, 1.6 TB, 1.92 TB, 3.84 TB, 7.68 TB
2.5-inch	SAS	12 Gb	SSD	400 GB, 480 GB, 800 GB, 960 GB, 1.6 TB, 1.92 TB, 3.2 TB, 3.84 TB, 6.4 TB, 7.68 TB, 12.8 TB, 15.36 TB, 30.72 TB
2.5-inch	SAS	12 Gb	10K	600 GB, 1.2 TB, 2.4 TB
2.5-inch	SAS	12 Gb	15K	600 GB, 900 GB

Table 7. Supported drives (continued)

Form Factor	Type	Speed	Rotational Speed	Capacities
3.5-inch	SAS	12 Gb	7.2K	2 TB, 4 TB, 8 TB, 12 TB, 16 TB
3.5-inch	SATA	6 Gb	7.2K	2 TB, 4 TB, 8 TB, 12 TB, 16 TB
M.2	SATA	6 Gb	SSD	240 GB, 480 GB
uSD	NA	NA	NA	16 GB, 32 GB, 64 GB

External storage

The R450 supports the external storage device types listed in the table below.

Table 8. Supported external storage devices

Device Type	Description
External Tape	Supports connection to external tape products
NAS/IDM appliance software	Supports NAS software stack
JBOD	Supports connection to 12GB MD/ME - series JBODs

Networking

Topics:

- [Overview](#)
- [Supported OCP cards](#)

Overview

PowerEdge offers a wide variety of options to get information moving to and from our servers. Industry best technologies are chosen, and systems management features are added by our partners to firmware to tie in with iDRAC. These adapters are rigorously validated for worry-free, fully supported use in our servers.

The [PowerEdge Server Adapter Matrix](#) posted to our knowledge portal is the central repository for PowerEdge NIC, HBA and HCA information. The matrix covers:

- Part Numbers, Tied SKUs and Customer Kits
- Server Compatibility & Support
- Optics & Cable Support
- Systems Management
- Adapter Features
- Spec Sheet Links

This document is updated as changes happen, so be sure to bookmark it rather than downloading an offline copy to stay with the latest information.

 **NOTE:** This is a direct download link to an .XLSX and may not open in a tab as expected depending on your browser.

Supported OCP cards

Table 9. OCP support list

Form Factor	Vendor	Port type	Port speed	Port count
OCP 3.0	Intel	SFP+	10GbE	2
OCP 3.0	Broadcom	BT	1GbE	4
OCP 3.0	Broadcom	BT	10GbE	2
OCP 3.0	Broadcom	SFP28	25GbE	2
OCP 3.0	Broadcom	SFP28	25GbE	4
OCP 3.0	Broadcom	SFP+	10GbE	2
OCP 3.0	QLogic	BT	10GbE	2
OCP 3.0	QLogic	SFP+	10GbE	2
OCP 3.0	QLogic	SFP28	25GbE	2
OCP 3.0	Intel	BT	1GbE	4
OCP 3.0	Intel	BT	10GbE	2
OCP 3.0	Intel	SFP+	10GbE	4

Table 9. OCP support list (continued)

OCP 3.0	Intel	SFP28	25GbE	2
OCP 3.0	Mellanox	SFP28	25GbE	2

OCP form factors

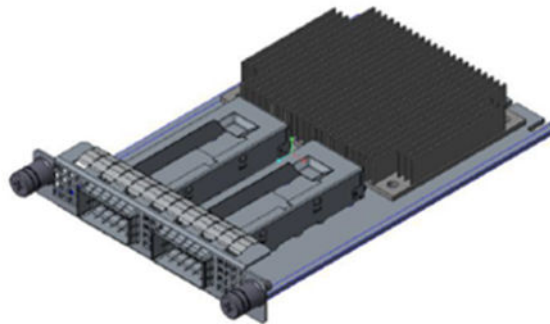

Figure 6. OCP 3.0 Small Card Form Factor (LS)

Table 10. OCP 3.0 Feature List

	OCP 3.0
Form factor	SFF and LFF
PCIe Gen	Gen4
Max PCIe width	x16
Max of ports	4
Port type	BT/SFP/SFP+/SFP28/SFP56
Max port speed	100Gbe
NC-SI	Yes
WoL	Yes
Power consumption	15 W ~150 W

OCP NIC 3.0 vs. rack Network Daughter Card comparisons

Table 11. OCP 3.0, 2.0, and rNDC NIC comparison

Form Factor	Dell rNDC	OCP 2.0 (LOM Mezz)	OCP 3.0	Notes
PCIe Gen	Gen 3	Gen 3	Gen 4	Supported OCP3 are SFF (small form factor)
Max PCIe Lanes	x8	Up to x16	Up to x16	See server slot priority matrix

Table 11. OCP 3.0, 2.0, and rNDC NIC comparison (continued)

Form Factor	Dell rNDC	OCP 2.0 (LOM Mezz)	OCP 3.0	Notes
Shared LOM	Yes	Yes	Yes	This is iDRAC port redirect
Aux Power	Yes	Yes	Yes	Used for Shared LOM

Expansion cards and expansion card risers

NOTE: A system event entry is logged in the iDRAC Lifecycle Controller if an expansion card riser is not supported or missing. It does not prevent your system from turning on. However, if a F1/F2 pause occurs with an error message, see *Troubleshooting expansion cards* section in the *Dell EMC PowerEdge Servers Troubleshooting Guide* at www.dell.com/poweredgemanuals.

Topics:

- [Expansion card installation guidelines](#)

Expansion card installation guidelines

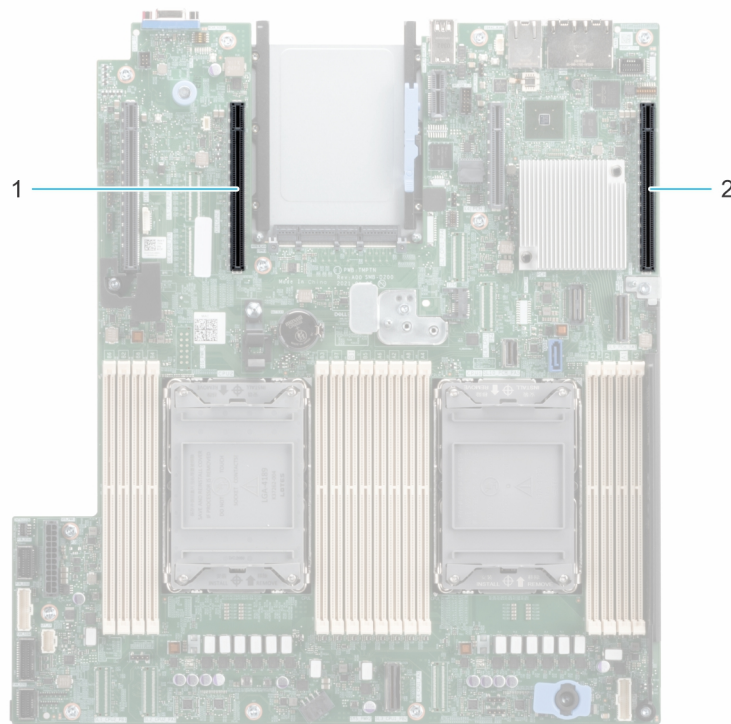

Figure 7. Expansion card slot connectors

1. Riser 2C (Slot 3)
2. Riser 1 (Slot 1)

The following table describes the expansion card riser configurations:

Table 12. Expansion card riser configurations

Configurations	Expansion card risers	PCIe Slots	Controlling processor	Height	Length	Slot width
Config0. with 1x LP	R1	1	Processor 1	Low Profile	Half length	x16
Config1. with 2x LP	R1	1	Processor 1	Low Profile	Half length	x16
	R2c	3	Processor 2	Low Profile	Half length	x16

Table 12. Expansion card riser configurations (continued)

Configurations	Expansion card risers	PCIe Slots	Controlling processor	Height	Length	Slot width
Config2. with 0x LP	NA	NA	NA	NA	NA	NA

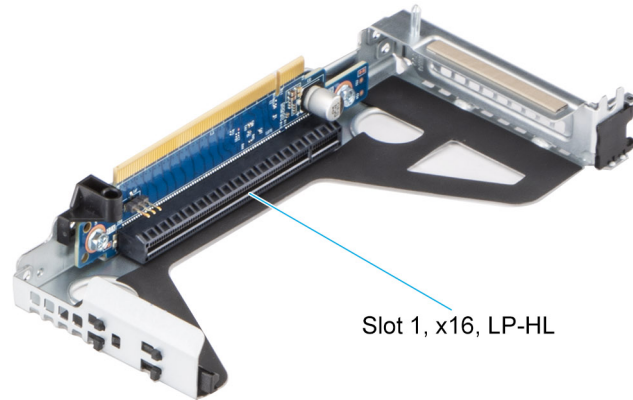

Figure 8. Riser 1

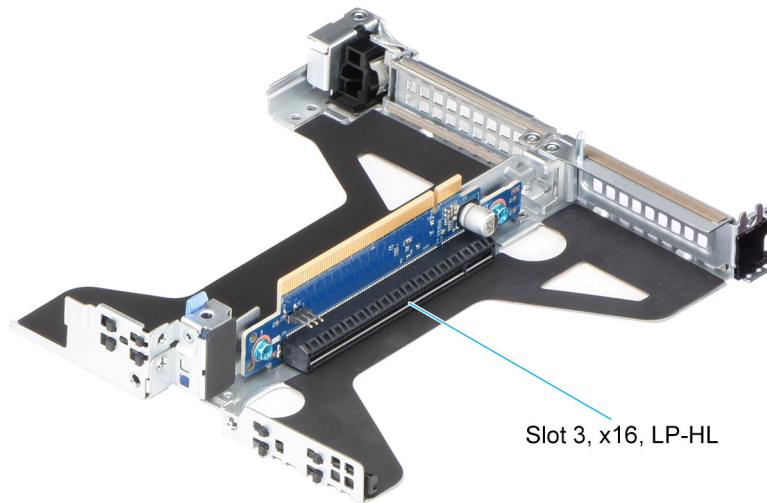

Figure 9. Riser 2c

NOTE: The expansion-card slots are not hot-swappable.

The following table provides guidelines for installing expansion cards to ensure proper cooling and mechanical fit. The expansion cards with the highest priority should be installed first using the slot priority indicated. All the other expansion cards should be installed in the card priority and slot priority order.

Table 13. Configuration 0: R1

Card type	Slot priority	Maximum number of cards
Dell Serial port module (LP)	1	1

Table 13. Configuration 0: R1 (continued)

Card type	Slot priority	Maximum number of cards
Broadcom (NIC: 25 Gb)	1	1
Intel (NIC: 25 Gb)	1	1
Mellanox (NIC: 25 Gb)	1	1
Qlogic (NIC: 25 Gb)	1	1
SolarFlare (NIC: 25 Gb)	1	1
Broadcom (NIC: 10 Gb)	1	1
Intel (NIC: 10 Gb)	1	1
Qlogic (NIC: 10 Gb)	1	1
Broadcom (NIC: 1 Gb)	1	1
Intel (NIC: 1 Gb)	1	1
Broadcom (OCP: 25 Gb)	Integrated slot	1
Intel (OCP: 25 Gb)	Integrated slot	1
Marvell (OCP: 25 Gb)	Integrated slot	1
Mellanox (OCP: 25 Gb)	Integrated slot	1
SolarFlare (OCP: 25 Gb)	Integrated slot	1
Broadcom (OCP: 10 Gb)	Integrated slot	1
Marvell (OCP: 10 Gb)	Integrated slot	1
Intel (OCP: 10 Gb)	Integrated slot	1
Broadcom (OCP: 1 Gb)	Integrated slot	1
Intel (OCP: 1 Gb)	Integrated slot	1
Dell External PERC Adapter	1	1
Dell BOSS S1 Module	Integrated slot	1
Intel (PCIe SSD AIC)	1	1
Samsung (PCIe SSD AIC)	1	1

Table 14. Configuration 2: R1+R2c

Card type	Slot priority	Maximum number of cards
Broadcom (NIC: 25 Gb)	3, 1	2
Intel (NIC: 25 Gb)	3, 1	2
Mellanox (NIC: 25 Gb)	3, 1	2
Qlogic (NIC: 25 Gb)	3, 1	2
SolarFlare (NIC: 25 Gb)	3, 1	2
Broadcom (NIC: 10 Gb)	3, 1	2
Intel (NIC: 10 Gb)	3, 1	2
Qlogic (NIC: 10 Gb)	3, 1	2
Broadcom (NIC: 1 Gb)	3, 1	2
Intel (NIC: 1 Gb)	3, 1	2
Broadcom (OCP: 25 Gb)	Integrated slot	1

Table 14. Configuration 2: R1+R2c (continued)

Card type	Slot priority	Maximum number of cards
Intel (OCP: 25 Gb)	Integrated slot	1
Marvell (OCP: 25 Gb)	Integrated slot	1
Mellanox (OCP: 25 Gb)	Integrated slot	1
SolarFlare (OCP: 25 Gb)	Integrated slot	1
Broadcom (OCP: 10 Gb)	Integrated slot	1
Marvell (OCP: 10 Gb)	Integrated slot	1
Intel (OCP: 10 Gb)	Integrated slot	1
Broadcom (OCP: 1 Gb)	Integrated slot	1
Intel (OCP: 1 Gb)	Integrated slot	1
Dell External PERC Adapter	3, 1	2
Dell BOSS S1 Module	Integrated slot	1
Intel (PCIe SSD AIC)	3, 1	2
Samsung (PCIe SSD AIC)	3, 1	2

Table 15. Configuration 3: No Riser

Card type	Slot priority	Maximum number of cards
Broadcom (OCP: 25 Gb)	Integrated slot	1
Intel (OCP: 25 Gb)	Integrated slot	1
Marvell (OCP: 25 Gb)	Integrated slot	1
Mellanox (OCP: 25 Gb)	Integrated slot	1
SolarFlare (OCP: 25 Gb)	Integrated slot	1
Broadcom (OCP: 10 Gb)	Integrated slot	1
Intel (OCP: 10 Gb)	Integrated slot	1
Marvell (OCP: 10 Gb)	Integrated slot	1
Broadcom (OCP: 1 Gb)	Integrated slot	1
Intel (OCP: 1 Gb)	Integrated slot	1
Dell BOSS S1 Module	Integrated slot	1

Power, thermal, and acoustics

Topics:

- Power
- Thermal design
- PowerEdge R450 acoustics

Power

Table 16. Power tools and technologies

Feature	Description
Power Supply Units(PSU) portfolio	Dell's PSU portfolio includes intelligent features such as dynamically optimizing efficiency while maintaining availability and redundancy. Find additional information in the Power supply units section.
Industry Compliance	Dell's servers are compliant with all relevant industry certifications and guide lines, including 80 PLUS, Climate Savers and ENERGY STAR.
Power monitoring accuracy	PSU power monitoring improvements include: <ul style="list-style-type: none"> • Dell's power monitoring accuracy is currently 1%, whereas the industry standard is 5%. • More accurate reporting of power. • Better performance under a power cap.
Power capping	Use Dell's systems management to set the power cap limit for your systems to limit the output of a PSU and reduce system power consumption. Dell is the first hardware vendor to leverage Intel Node Manager for circuit-breaker fast capping.
Systems Management	iDRAC Enterprise and Datacenter provides server- level management that monitors, reports and controls power consumption at the processor, memory and system level. Dell OpenManage Power Center delivers group power management at the rack, row and data center level for servers, power distribution units and uninterruptible power supplies.
Rack infrastructure	Dell offers some of the industry's highest-efficiency power infrastructure solutions, including <ul style="list-style-type: none"> • Power distribution units (PDUs). • Uninterruptible power supplies (UPSs). • Energy Smart containment rack enclosures. • Find additional information at: http://content.dell.com/us/en/enterprise/power-and-cooling-technologies-components-rack-infrastructure.aspx.

Thermal design

Thermal management of PowerEdge R450 delivers high performance for the right amount of cooling to components at the lowest fan speeds across a wide range of ambient temperatures from 10°C to 35°C (50°F to 86°F) and to extended ambient temperature ranges (see Environmental Specifications). The benefits to you are lower fan power consumption (lower server system power and data center power consumption) and greater acoustical versatility.

Reliability	<ul style="list-style-type: none"> • Component hardware reliability remains the top thermal priority. • System thermal architectures and thermal control algorithms are designed to ensure there are no tradeoffs in system level hardware life.
Performance	<ul style="list-style-type: none"> • Performance and uptime are maximized through the development of cooling solutions that meet the needs of even the densest of hardware configurations
Efficiency	<ul style="list-style-type: none"> • 15G servers are designed with an efficient thermal solution to minimize power and airflow consumption, and/or acoustics for acoustical deployments. • Dell's advanced thermal control algorithms enable minimization of system fans speeds while meeting the above Reliability and Performance tenets.
Management	<ul style="list-style-type: none"> • System management settings are provided such that customers have options to customize for their unique hardware, environments, and/or workloads.
Forward Compatibility	<ul style="list-style-type: none"> • Forward compatibility means that thermal controls and thermal architecture solutions are robust to scale to new components that historically would have otherwise required firmware updates to ensure proper cooling. • The frequency of required firmware updates is thus reduced.

The thermal design of the PowerEdge R450 reflects the following:

- Optimized thermal design: The system layout is architected for optimum thermal design.
- System component placement and layout are designed to provide maximum airflow coverage to critical components with minimum expense of fan power.
- Comprehensive thermal management: The thermal control system regulates the fan speed based on several different responses from all system- component temperature sensors, as well as inventory for system configurations. Temperature monitoring includes components such as processors, DIMMs, chipset, the inlet air ambient, hard disk drives, OCP.
- Open and closed loop thermal fan speed control: Open loop thermal control uses system configuration to determine fan speed based on inlet air ambient temperature. Closed loop thermal control method uses feedback temperatures to dynamically determine proper fan speeds.
- User-configurable settings: With the understanding and realization that every customer has unique set of circumstances or expectations from the system, in this generation of servers, we have introduced limited user- configurable settings residing in the iDRAC BIOS setup screen. For more information, see the PowerEdge R450 Owner's Manual at www.dell.com/poweredgemanuals and "Advanced Thermal Control: Optimizing across Environments and Power Goals" on Dell.com.
- Cooling redundancy: The R450 allows N+1 fan redundancy, allowing continuous operation with one fan failure in the system.
- Environmental Specifications: The optimized thermal management makes the R450 reliable under a wide range of operating environments.
- Optimized thermal design: The system layout is architected for optimum thermal design.

PowerEdge R450 acoustics

Dell EMC PowerEdge R450 is a rack-mount server appropriate for attended data center environment. However, lower acoustical output is attainable with proper hardware or software configurations. For example, the minimum configuration of R450 is quiet enough for typical office environment.

Acoustical performance

Dell EMC PowerEdge R450 is a rack-mount server appropriate for attended data center environment. However, lower acoustical output is attainable with proper hardware or software configurations.

Table 17. Acoustical configurations of R450

Configuration	Single Socket	Typical 3.5-inch	Typical 2.5-inch	Margin Rich
Processor Type	3rd Generation Intel® Xeon® Processor	3rd Generation Intel® Xeon® Processor	3rd Generation Intel® Xeon® Processor	3rd Generation Intel® Xeon® Processor
Processor TDP	105 W / 10 C	105 W / 10 C	105 W / 10 C	150 W / 24 C
Processor Quantity	1	2	2	2
RDIMM Memory	8 GB DDR4	16 GB DDR4	16 GB DDR4	32 GB DDR4
Memory Quantity	2	4	4	8
Backplane Type	4x3.5-inch	4x3.5-inch	8x2.5-inch	10x2.5-inch
HDD Type	3.5-inch 7.2 K RPM SATA	3.5-inch 7.2 K RPM SAS	2.5-inch 10 K RPM SAS	2.5-inch 10 K RPM SAS
HDD Quantity	2	4	6	10
PSU Type	800 W	800 W	800 W	1400 W
PSU Quantity	1	2	2	2
M.2	X	X	X	X
OCP	Dual Port 1 GbE	Dual Port 1 GbE	Dual Port 1 GbE	Dual Port 10 GbE
PCI 1	X	X	X	X
PCI 2	X	X	X	X
Front PERC	PERC H345	PERC H345	PERC H345	PERC H345
LOM Card	X	X	X	X
PERC	X	X	X	X

Table 18. Acoustical performance of R450 acoustical configurations

Configuration	Single Socket	Typical 3.5-inch	Typical 2.5-inch	Margin Rich	
Acoustical Performance: Idle/ Operating @ 25 °C Ambient					
L_{wA,m} (B)	Idle	4.6	4.7	4.7	4.8
	Operating	5.2	5.2	5.2	5.3
K_v (B)	Idle	0.4	0.4	0.4	0.4
	Operating	0.4	0.4	0.4	0.4
L_{pA,m} (dB)	Idle	32	33	33	35
	Operating	37	37	39	43
Prominent tones	No prominent tones in Idle and Operating				
Acoustical Performance: Idle @ 28°C Ambient					
L_{wA,m} (B)	5.0	5.0	5.0	5.1	
K_v (B)	0.4	0.4	0.4	0.4	

Table 18. Acoustical performance of R450 acoustical configurations (continued)

Configuration	Single Socket	Typical 3.5-inch	Typical 2.5-inch	Margin Rich
$L_{pA,m}$ (dB)	36	36	36	37
Acoustical Performance: Max. Loading @ 35°C Ambient				
$L_{wA,m}$ (B)	6.9	7.0	7.0	6.9
K_v (B)	0.4	0.4	0.4	0.4
$L_{pA,m}$ (dB)	54	55	55	53

NOTE:

- **$L_{wA,m}$** The declared mean A-weighted sound power level (LwA) is calculated per section 5.2 of ISO 9296 (2017) with data collected using the methods described in ISO 7779 (2010). Data presented here may not be fully compliant with ISO 7779
- **$L_{pA,m}$** The declared mean A-weighted emission sound pressure level is at the bystander position per section 5.3 of ISO 9296 (2017) and measured using methods described in ISO 7779 (2010). The system is placed in a 24U rack enclosure, 25cm above a reflective floor. Data presented here may not be fully compliant with ISO 7779.
- **Prominent tones:** Criteria of D.6 and D.11 of ECMA-74 are followed to determine if discrete tones are prominent and to report them, if so.
- **Idle mode:** The steady-state condition in which the server is energized but not operating any intended function.
- **Operating mode:** The maximum of the steady state acoustical output at 50% of CPU TDP or active HDDs per C.9.3.2 in ECMA-74 .

Rack, rails, and cable management

Key factors in selecting the proper rails include, Identifying:

- Type of rack in which the rails will be installed
- Spacing between the front and rear mounting flanges of the rack
- Type and location of any equipment mounted on the rear of the rack such as power distribution units (PDUs), and the overall depth of the rack

Reference the [DellEMC Enterprise Systems Rail Sizing and Rack Compatibility Matrix](#) for the following information:

- Specific details about rail types and their functionalities
- Rail adjustability ranges for various rack mounting flange types
- Rail depth with and without cable management accessories
- Rack types supported for various rack mounting flange types

Topics:

- [Rails information](#)
- [Cable Management Arm](#)
- [Strain Relief Bar](#)

Rails information

The R450 supports both sliding rails and static rails. Both rails have a slim rail design that supports the wide system chassis.

Sliding Rails

Stab-in/Drop-in sliding rails: The Stab-in/Drop-in sliding rail also provides tool-less support for 4-post racks with square or unthreaded round mounting holes including all generations of Dell racks. Additionally, these rails offer tool-less support for 4-post threaded racks with no conversion required.

The optional cable management arm (CMA) can be mounted on either the left or right side of the sliding rails without the use of tools for fast and easy deployment.

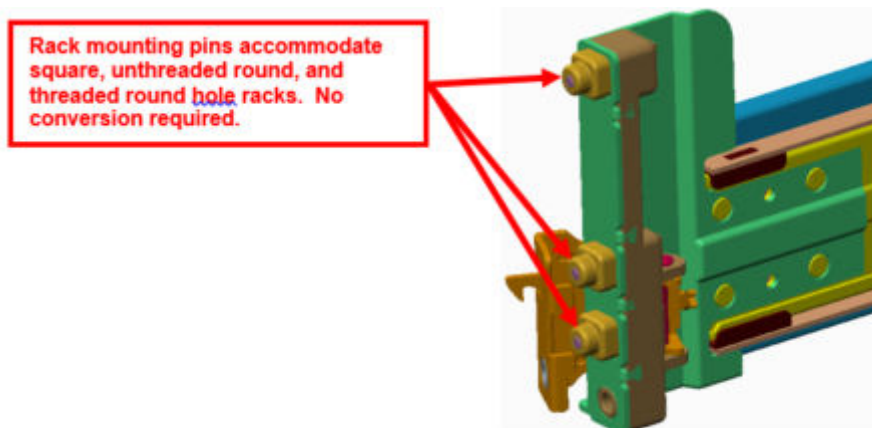

Figure 10. Drop in/Stab-in Sliding Rail mounting interface

Static Rails

ReadyRails Static Rails for 4-post and 2-post Racks:

- The ReadyRails static rails also supports tool-less installation to 4-post racks with square or unthreaded round mounting holes including all generations of Dell racks.
- The static rails support tooled mounting in 2-post (Telco) racks as well for added versatility.

i | **NOTE:** The R450 is compatible with the R440, R6515, and R6415 rails and CMA.

Cable Management Arm

The optional Cable Management Arm (CMA) for the system organizes and secures the cords and cables exiting the back of the server and unfolds to allow the server to extend out of the rack without having to detach the cables.

Some key features of the CMA include:

- Large U-shaped baskets to support dense cable loads.
- Open vent pattern for optimal airflow.
- Support for mounting on either side by swinging the spring-loaded brackets from one side to the other.
- Utilizes hook-and-loop straps rather than plastic tie wraps to eliminate the risk of cable damage during cycling.
- Includes a low-profile fixed tray to both support and retain the CMA in its fully closed position.
- Both the CMA and the tray mount without the use of tools through simple and intuitive snap-in designs.

The CMA can be mounted to either side of the sliding rails without the use of tools or the need for conversion. For systems with one power supply unit (PSU), it is recommended to mount on the side opposite to that of the power supply to allow easier access to it and the rear drives (if applicable) for service or replacement.

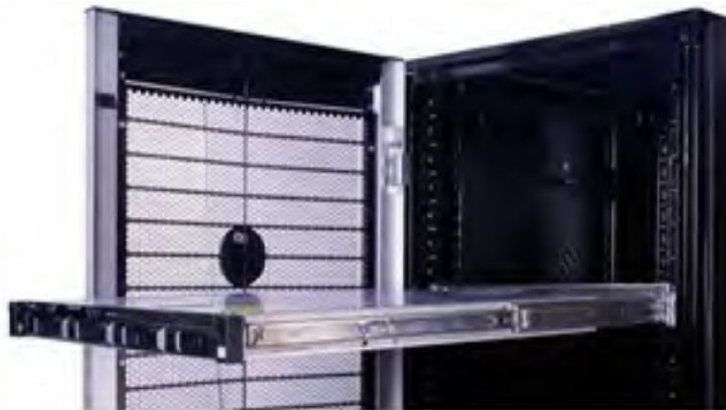

Strain Relief Bar

The optional Strain Relief Bar (SRB) for the system organizes and secures cables exiting the back of the server.

Sliding rails with optional SRB:

- Supports tool-less attachment to rails
- Supports Two depth positions to accommodate various cable loads and rack depths
- Supports cable loads and controls stresses on server connectors
- Cables can be segregated into discrete, purpose-specific bundles

Supported Operating Systems

The PowerEdge R450 system supports the following operating systems:

- Canonical® Ubuntu® Server LTS
- Citrix® Hypervisor®
- Microsoft® Windows Server® with Hyper-V
- Red Hat® Enterprise Linux
- SUSE® Linux Enterprise server
- VMware® ESXi®

Links to specific OS versions and editions, certification matrices, Hardware Compatibility Lists (HCL) portal, and Hypervisor support are available at [Dell EMC Enterprise Operating Systems](#).

Dell EMC OpenManage systems management

Dell EMC OpenManage Portfolio

Simplifying hardware management through ease of use and automation

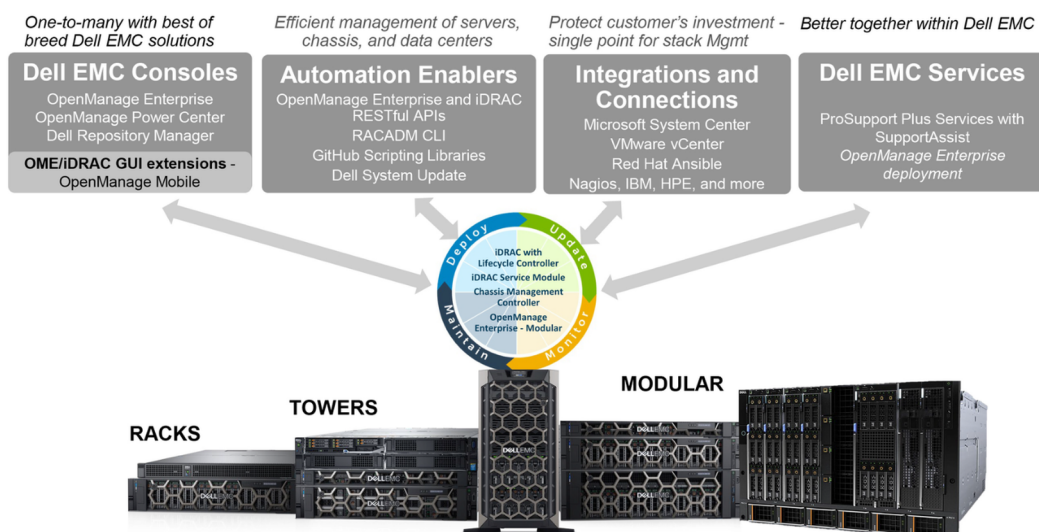

Figure 11. Dell EMC OpenManage Portfolio

Dell EMC delivers management solutions that help IT Administrators effectively deploy, update, monitor, and manage IT assets. OpenManage solutions and tools enable you to quickly respond to problems by helping them to manage Dell EMC servers effectively and efficiently; in physical, virtual, local, and remote environments, operating in-band, and out-of-band (agent-free). The OpenManage portfolio includes innovative embedded management tools such as the integrated Dell Remote Access Controller (iDRAC), Chassis Management Controller and Consoles like OpenManage Enterprise, OpenManage Power Manager plug in, and tools like Repository Manager.

Dell EMC has developed comprehensive systems management solutions based on open standards and has integrated with management consoles that can perform advanced management of Dell hardware. Dell EMC has connected or integrated the advanced management capabilities of Dell hardware into offerings from the industry's top systems management vendors and frameworks such as Ansible, thus making Dell EMC platforms easy to deploy, update, monitor, and manage.

The key tools for managing Dell EMC PowerEdge servers are iDRAC and the one-to-many OpenManage Enterprise console. OpenManage Enterprise helps the system administrators in complete lifecycle management of multiple generations of PowerEdge servers. Other tools such as Repository Manager, which enables simple yet comprehensive change management.

OpenManage tools integrate with systems management framework from other vendors such as VMware, Microsoft, Ansible, and ServiceNow. This enables you to use the skills of the IT staff to efficiently manage Dell EMC PowerEdge servers.

Topics:

- [Server and Chassis Managers](#)
- [Dell EMC consoles](#)
- [Automation Enablers](#)
- [Integration with third-party consoles](#)
- [Connections for third-party consoles](#)
- [Dell EMC Update Utilities](#)
- [Dell resources](#)

Server and Chassis Managers

- Integrated Dell Remote Access Controller (iDRAC)
- iDRAC Service Module (iSM)

Dell EMC consoles

- Dell EMC OpenManage Enterprise
- Dell EMC Repository Manager (DRM)
- Dell EMC OpenManage Enterprise Power Manager plugin to OpenManage Enterprise
- Dell EMC OpenManage Mobile (OMM)

Automation Enablers

- OpenManage Ansible Modules
- iDRAC RESTful APIs (Redfish)
- Standards-based APIs (Python, PowerShell)
- RACADM Command Line Interface (CLI)
- GitHub Scripting Libraries

Integration with third-party consoles

- Dell EMC OpenManage Integrations with Microsoft System Center
- Dell EMC OpenManage Integration for VMware vCenter (OMIVV)
- Dell EMC OpenManage Ansible Modules
- Dell EMC OpenManage Integration with ServiceNow

Connections for third-party consoles

- Micro Focus and other HPE tools
- OpenManage Connection for IBM Tivoli
- OpenManage Plug-in for Nagios Core and XI

Dell EMC Update Utilities

- Dell System Update (DSU)
- Dell EMC Repository Manager (DRM)
- Dell EMC Update Packages (DUP)
- Dell EMC Server Update Utility (SUU)
- Dell EMC Platform Specific Bootable ISO (PSBI)

Dell resources

For additional information about white papers, videos, blogs, forums, technical material, tools, usage examples, and other information, go to the OpenManage page at <https://www.dell.com/openmanagemanuals> or the following product pages:

Table 19. Dell resources

Resource	Location
Integrated Dell Remote Access Controller (iDRAC)	https://www.dell.com/idracmanuals
iDRAC Service Module (iSM)	https://www.dell.com/support/kbdoc/000178050/
OpenManage Ansible Modules	https://www.dell.com/support/kbdoc/000177308/
OpenManage Essentials (OME)	https://www.dell.com/support/kbdoc/000175879/
OpenManage Mobile (OMM)	https://www.dell.com/support/kbdoc/000176046
OpenManage Integration for VMware vCenter (OMIVV)	https://www.dell.com/support/kbdoc/000176981/
OpenManage Integration for Microsoft System Center (OMIMSSC)	https://www.dell.com/support/kbdoc/000147399
Dell EMC Repository Manager (DRM)	https://www.dell.com/support/kbdoc/000177083
Dell EMC System Update (DSU)	https://www.dell.com/support/kbdoc/000130590
Dell EMC Platform Specific Bootable ISO (PSBI)	Dell.com/support/article/sln296511
Dell EMC Chassis Management Controller (CMC)	www.dell.com/support/article/sln311283
OpenManage Connections for Partner Consoles	https://www.dell.com/support/kbdoc/000146912
OpenManage Enterprise Power Manager	https://www.dell.com/support/kbdoc/000176254
OpenManage Integration with ServiceNow (OMISNOW)	Dell.com/support/article/sln317784

 **NOTE:** Features may vary by server. Please refer to the product page on <https://www.dell.com/manuals> for details.

Dell Technologies Services

Dell Technologies Services include a wide, customizable range of service choices to simplify the assessment, design, implementation, management and maintenance of IT environments and to help you transition from platform to platform. Depending on your current business requirements and the level of service right for you, we provide factory, on-site, remote, modular, and specialized services that fit your needs and budget. We'll help with a little or a lot—your choice—and provide access to our global resources.

For more information, see DellEMC.com/Services.

Topics:

- [Dell EMC ProDeploy Enterprise Suite](#)
- [Dell EMC Data Migration Service](#)
- [Dell EMC ProSupport Enterprise Suite](#)
- [Dell EMC ProSupport Plus for Enterprise](#)
- [Dell EMC ProSupport for Enterprise](#)
- [Dell EMC ProSupport One for Data Center](#)
- [ProSupport for HPC](#)
- [Support Technologies](#)
- [Services for Data Security](#)
- [Dell Technologies Education Services](#)
- [Dell Technologies Consulting Services](#)
- [Dell EMC Managed Services](#)

Dell EMC ProDeploy Enterprise Suite

ProDeploy Enterprise Suite gets your server out of the box and into optimized production—fast. Our elite deployment engineers with broad and deep experience utilizing best-in-class processes along with our established global scale can help you around the clock and around the globe. From simple to the most complex server installations and software integration, we take the guess work and risk out of deploying your new server technology.

		Basic Deployment	ProDeploy	ProDeploy Plus
Pre-deployment	Single point of contact for project management	-	●	In-region
	Site readiness review	-	●	●
	Implementation planning	-	●	●
	SAM engagement for ProSupport Plus entitled devices	-	-	●
Deployment	Deployment service hours	Business hours	24x7	24x7
	Remote guidance for hardware installation or Onsite hardware installation and packaging material removal	Onsite	Remote or Onsite	Onsite
	Install and configure system software	-	Remote	Onsite
	Install support software and connect with Dell Technologies	-	●	●
	Project documentation with knowledge transfer	-	●	●
Post-deployment	Deployment verification	-	●	●
	Configuration data transfer to Dell EMC technical support	-	●	●
	30-days of post-deployment configuration assistance	-	-	●
	Training credits for Dell EMC Education Services	-	-	●

Figure 12. ProDeploy Enterprise Suite capabilities

NOTE: Hardware installation not applicable on selected software products.

Dell EMC ProDeploy Plus

From beginning to end, ProDeploy Plus provides the skill and scale needed to successfully execute demanding deployments in today's complex IT environments. Certified Dell EMC experts start with extensive environmental assessments and detailed migration planning and recommendations. Software installation includes set up of most versions of Dell EMC SupportAssist and OpenManage system management utilities. Post-deployment configuration assistance, testing, and product orientation services are also available.

Dell EMC ProDeploy

ProDeploy provides full service installation and configuration of both server hardware and system software by certified deployment engineers including set up of leading operating systems and hypervisors as well as most versions of Dell EMC SupportAssist and OpenManage system management utilities. To prepare for the deployment, we conduct a site readiness review and implementation planning exercise. System testing, validation, and full project documentation with knowledge transfer complete the process.

Basic Deployment

Basic Deployment delivers worry-free professional installation by experienced technicians who know Dell EMC servers inside and out.

Dell EMC ProDeploy for HPC

HPC deployments require specialist that understand that cutting edge is yesterday's news. Dell EMC deploys the world's fastest systems and understands the nuances that make them perform. ProDeploy for HPC provides:

- Global team of dedicated HPC specialists
- Proven track record, thousands of successful HPC deployments
- Design validation, bench marking and production orientation

Learn more at <http://DellEMC.com/HPC-Services>

ProDeploy for HPC

Get more out of your cluster starting Day One

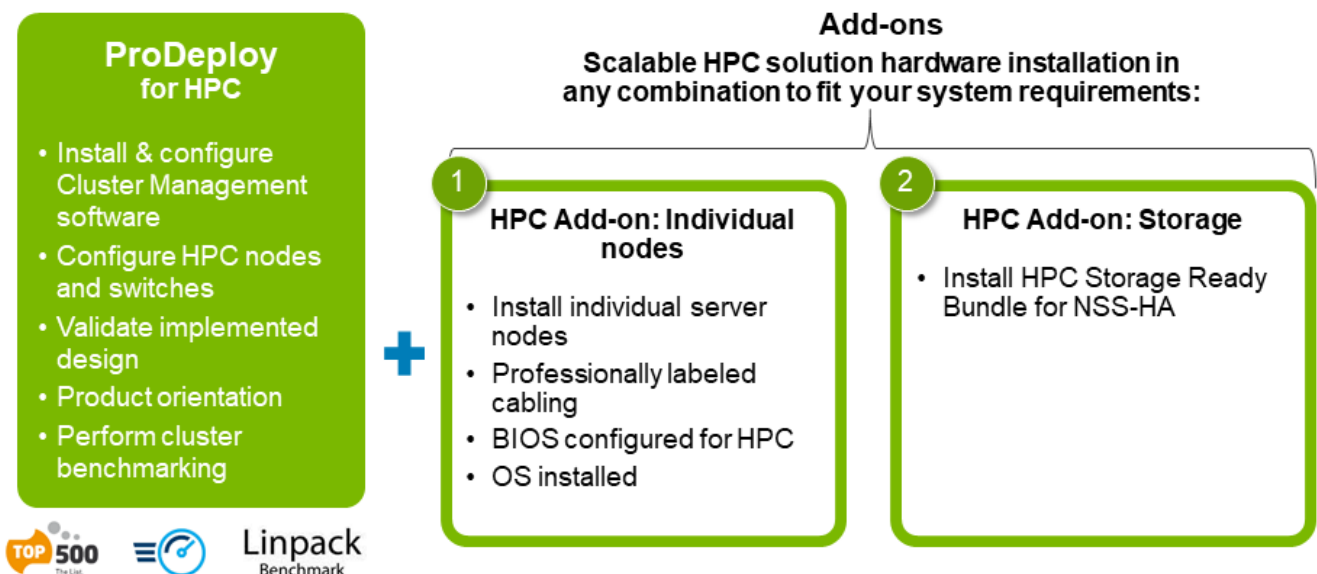

Figure 13. ProDeploy for HPC

Dell EMC Server Configuration Services

With Dell EMC Rack Integration and other Dell EMC PowerEdge Server Configuration Services, you save time by receiving your systems racked, cabled, tested, and ready to integrate into the data center. Dell EMC staff pre-configure RAID, BIOS and iDRAC settings, install system images, and even install third-party hardware and software.

For more information, see [Server Configuration Services](#).

Dell EMC Residency Services

Residency Services helps customers transition to new capabilities quickly with the assistance of on-site or remote Dell EMC experts whose priorities and time you control. Residency experts can provide post implementation management and knowledge transfer related to a new technology acquisition or day-to-day operational management of the IT infrastructure.

Dell EMC Data Migration Service

Protect your business and data with our single point of contact to manage your data migration project. Your project manager will work with our experienced team of experts to create a plan using industry-leading tools and proven processes based on global best practices to migrate your existing files and data so your business system get up and running quickly and smoothly.

Dell EMC ProSupport Enterprise Suite

With the ProSupport Enterprise Suite, we help keep your IT systems running smoothly, so you can focus on running your business. We will help maintain peak performance and availability of your most essential workloads. ProSupport Enterprise Suite is a suite of support services that enable you to build the solution that is right for your organization.

Choose support models based on how you use technology and where you want to allocate resources. From the desktop to the data center, address everyday IT challenges, such as unplanned downtime, mission-critical needs, data and asset protection, support planning, resource allocation, software application management and more. Optimize IT resources by choosing the right support model.

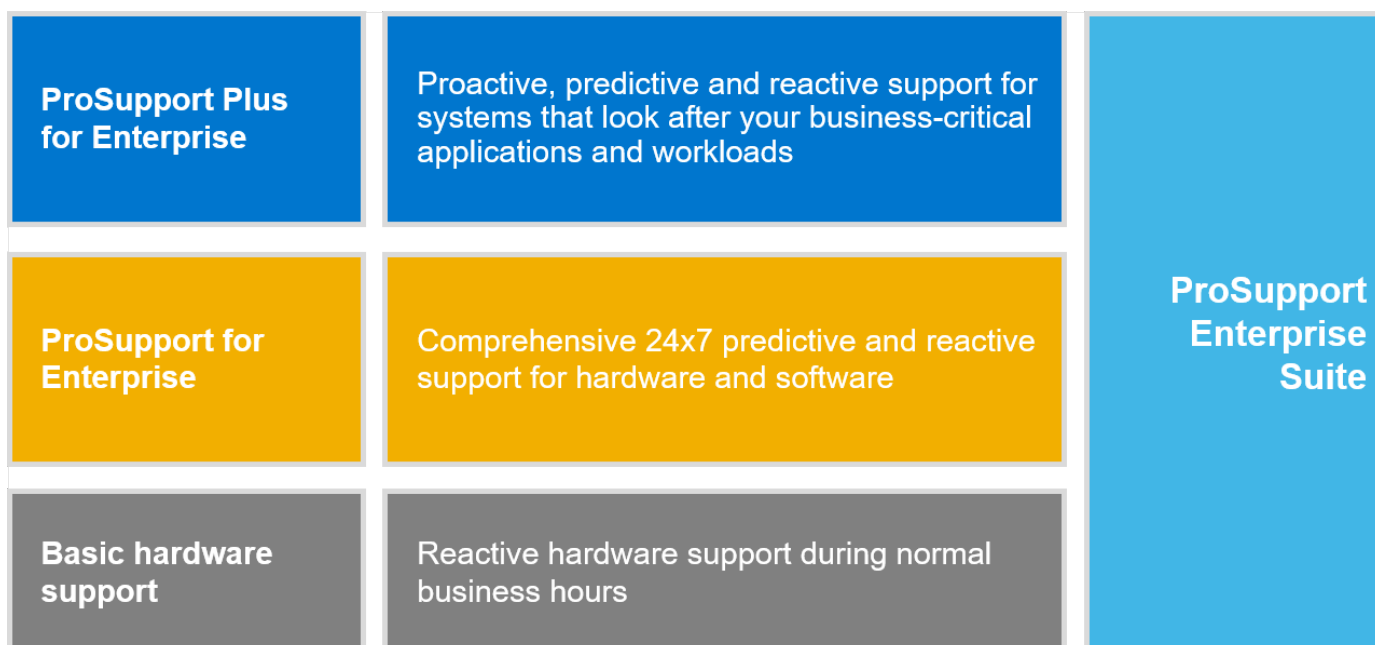

Figure 14. Dell EMC ProSupport Enterprise Suite

Dell EMC ProSupport Plus for Enterprise

When you purchase your PowerEdge server, we recommend ProSupport Plus, our proactive and preventative support service for your business-critical systems. ProSupport Plus provides you with all the benefits of ProSupport, plus the following:

- An assigned Services Account Manager who knows your business and your environment
- Immediate advanced troubleshooting from an engineer who understands your PowerEdge server
- Personalized, preventive recommendations based on analysis of support trends and best practices from across the Dell Technologies infrastructure solutions customer base to reduce support issues and improve performance
- Predictive analysis for issue prevention and optimization enabled by SupportAssist
- Proactive monitoring, issue detection, notification, and automated case creation for accelerated issue resolution enabled by SupportAssist
- On-demand reporting and analytics-based recommendations enabled by SupportAssist and TechDirect

Dell EMC ProSupport for Enterprise

Our ProSupport service offers highly trained experts around the clock and around the globe to address your IT needs. We help minimize disruptions and maximize availability of PowerEdge server workloads with:

- 24x7 support through phone, chat and online
- Predictive, automated tools and innovative technology
- A central point of accountability for all hardware and software issues
- Collaborative 3rd party support
- Hypervisor, operating system and application support
- Consistent experience regardless of where you are located or what language you speak
- Optional onsite parts and labor response options including next business day or four-hour mission critical

i **NOTE:** Subject to service offer country availability.

Enterprise Support Services Feature Comparison

	Basic	ProSupport	ProSupport Plus
Remote technical support	9x5	24x7	24x7
Covered products	Hardware	Hardware Software	Hardware Software
Onsite hardware support	Next business day	Next business day or 4hr mission critical	Next business day or 4 hr mission critical
3 rd party collaborative assistance		●	●
Automated issue detection & proactive case creation		●	●
Self-service case initiation and management		●	●
Access to software updates		●	●
Priority access to specialized support experts			●
3 rd party software support			●
Assigned Services Account Manager			●
Personalized assessments and recommendations			●
Semiannual systems maintenance			●

Availability and terms of Dell Technologies services vary by region and by product. For more information, please view our Service Descriptions available on Dell.com

Figure 15. Dell EMC Enterprise Support model

Dell EMC ProSupport One for Data Center

ProSupport One for Data Center offers flexible site-wide support for large and distributed data centers with more than 1,000 assets. This offering is built on standard ProSupport components that leverage our global scale but are tailored to your company's needs. While not for everyone, this service option offers a truly unique solution for Dell Technologies largest customers with the most complex environments.

- Team of assigned Services Account Managers with remote, on-site options
- Assigned ProSupport One technical and field engineers who are trained on your environment and configurations
- On-demand reporting and analytics-based recommendations enabled by SupportAssist and TechDirect
- Flexible on-site support and parts options that fit your operational model
- A tailored support plan and training for your operations staff

ProSupport for HPC

The ProSupport for HPC provides solution-aware support including:

- Access to senior HPC experts
- Advanced HPC cluster assistance: performance, interoperability & configuration
- Enhanced HPC solution level end-to-end support
- Remote pre-support engagement with HPC Specialists during ProDeploy implementation

Learn more at DellEMC.com/HPC-Services.

ProSupport Add-on for HPC

Delivering a true end-to-end support experience across your HPC environment

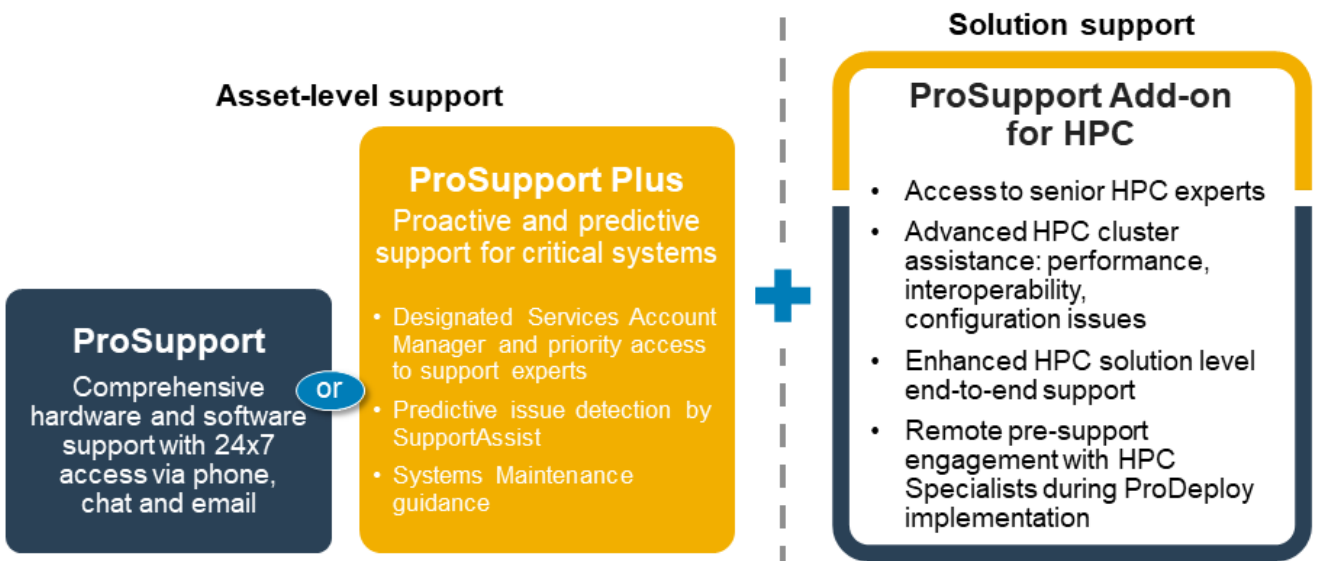

8 © Copyright 2020 Dell Inc.

DALLEMC

Figure 16. ProSupport for HPC

Support Technologies

Powering your support experience with predictive, data-driven technologies.

Dell EMC SupportAssist

The best time to solve a problem is before it happens. The automated proactive and predictive technology SupportAssist helps reduce steps and time to resolution, often detecting issues before they become a crisis. Benefits include:

- Value—SupportAssist is available to all customers at no additional charge
- Improve productivity—replace manual, high-effort routines with automated support
- Accelerate time to resolution—receive issue alerts, automatic case creation, and proactive contact from Dell EMC experts
- Gain insight and control—optimize enterprise devices with on-demand ProSupport Plus reporting in TechDirect, and get predictive issue detection before the problem starts

NOTE: SupportAssist is included with all support plans, but features vary based on service level agreement.

	Basic Hardware Warranty	ProSupport	ProSupport Plus
Automated issue detection and system state information collection	•	•	•
Proactive, automated case creation and notification		•	•
Predictive issue detection for failure prevention			•
Recommendation reporting available on-demand in TechDirect			•

Figure 17. SupportAssist model

Get started at Dell.com/SupportAssist

Dell EMC TechDirect

Boost IT team productivity when supporting Dell EMC systems. With over 1.4 million self-dispatches processed each year, TechDirect has proven its effectiveness as a support tool. You can:

- Self-dispatch replacement parts
- Request technical support
- Integrate APIs into your help desk

Or, access all your Dell EMC certification and authorization requirements. Train your staff on Dell EMC products, as TechDirect allows you to:

- Download study guides
- Schedule certification and authorization exams
- View transcripts of completed courses and exams

Register at techdirect.dell.

Services for Data Security

As data security concerns intensify, businesses require focused security strategies to help mitigate risk. Get end to end protection throughout the life of your technology. Keep sensitive data on failed parts completely in your control with Dell EMC Keep Your Hard Drive and Keep Your Component for Enterprise or render data unrecoverable on re-purposed or retired products with Dell EMC Data Sanitization and Data Destruction for Enterprise. Promote social responsibility while maintaining data security with Dell EMC Data Sanitization for Enterprise Offsite with Asset Resale & Recycle we can help customers secure data on specific Dell EMC Server and Storage products as well as similar third-party systems. As part of this service, we remove old systems from your environment, securely sanitize data and responsibly reuse or recycle those systems to contribute to a more sustainable future. No matter your need, risk of unauthorized access to sensitive information is eliminated.

Dell Technologies Education Services

Build the IT skills required to influence the transformational outcomes of the business. Enable talent and empower teams with the right skills to lead and execute transformational strategy that drives competitive advantage. Leverage the training and certification required for real transformation.

Dell Technologies Education Services offers PowerEdge server training and certifications designed to help you achieve more from your hardware investment. The curriculum delivers the information and the practical, hands-on skills that you and your team need to confidently install, configure, manage, and troubleshoot your Dell EMC servers. To learn more or register for a class today, see [LearnDell.com/Server](https://www.dell.com/learn/server).

Dell Technologies Consulting Services

Our expert consultants help you transform faster, and quickly achieve business outcomes for the high value workloads Dell EMC PowerEdge systems can handle.

From strategy to full-scale implementation, Dell Technologies Consulting can help you determine how to execute your IT, workforce, or application transformation.

We use prescriptive approaches and proven methodologies combined with Dell Technologies' portfolio and partner ecosystem to help you achieve real business outcomes. From multi-cloud, applications, DevOps, and infrastructure transformations, to business resiliency, data center modernization, analytics, workforce collaboration, and user experiences—we're here to help.

Dell EMC Remote Consulting Services

When you are in the final stages of your PowerEdge server implementation, you can rely on Dell EMC Remote Consulting Services and our certified technical experts to help you optimize your configuration with best practices for your software, virtualization, server, storage, networking, and systems management.

Dell EMC Managed Services

Reduce the cost, complexity, and risk of managing IT. Focus your resources on digital innovation and transformation while our experts help optimize your IT operations and investment with managed services backed by guaranteed service levels.

Appendix A. Additional specifications

Topics:

- Chassis dimensions
- Chassis weight
- Video specifications
- USB Ports
- PSU rating
- Environmental specifications

Chassis dimensions

The R450 has the following dimensions:

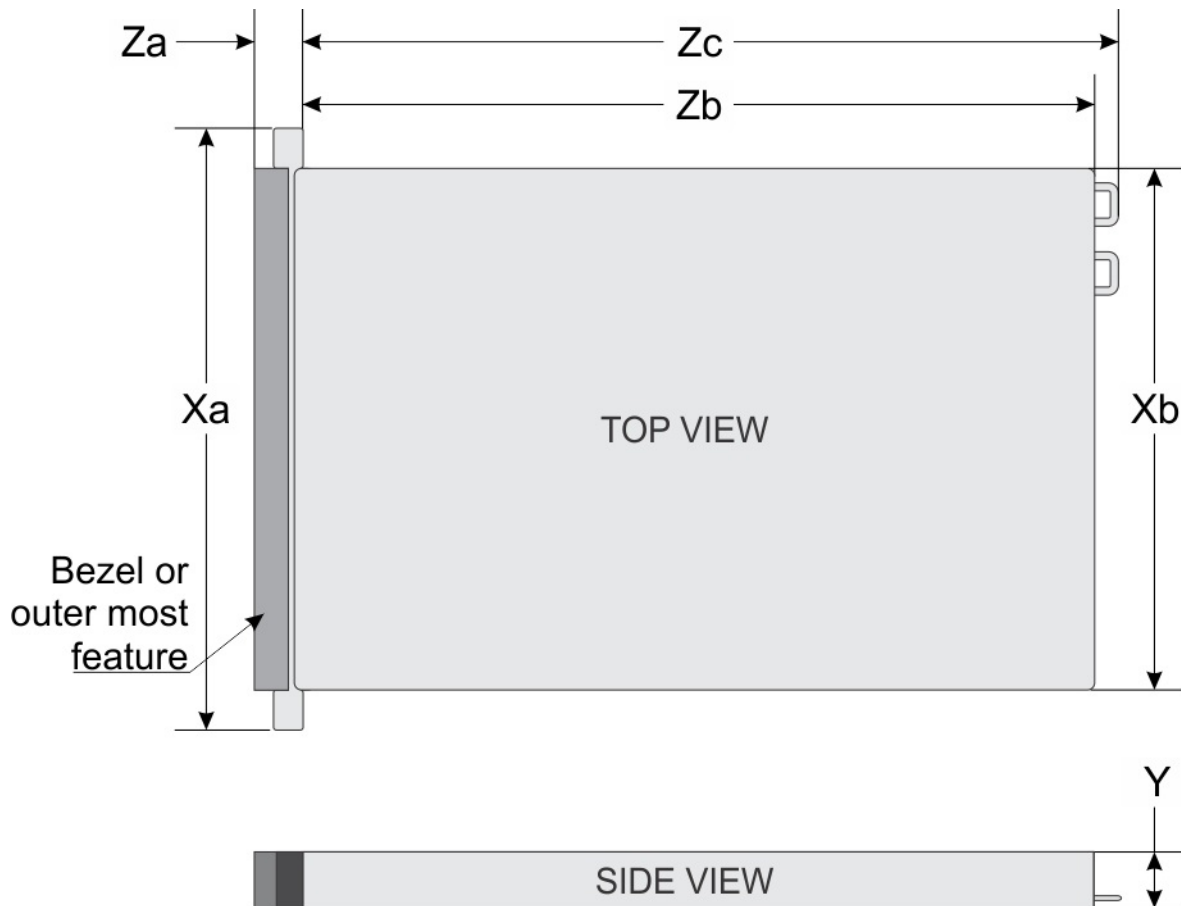

Figure 18. PowerEdge R450 Chassis dimensions

Table 20. Chassis dimensions

Drives	Xa	Xb	Y	Za	Zb	Zc
4 x 3.5-inch	482 mm	434 mm (17.08 inches)	42.8 mm(1.68	22 mm (0.866 inches) without bezel	677.8 mm (26.685 inches) (Ear to PSU surface)	712.95 mm (28.069 inches)

Table 20. Chassis dimensions (continued)

Drives	Xa	Xb	Y	Za	Zb	Zc
	(18.976 inches)		5 inches)	35.84 mm (1.41 inches) with bezel	691.07mm (27.207 inches) (Ear to butterfly L bracket housing)	(Ear to PSU handle without velcro strap)
8 x 2.5-inch	482 mm (18.976 inches)	434 mm (17.08 inches)	42.8 mm(1.68 5 inches)	22 mm (0.866 inches) without bezel 35.84 mm (1.41 inches) with bezel	627.03 mm (24.686 inches) (Ear to PSU surface) 640.3 mm (25.209 inches) (Ear to butterfly L bracket housing)	662.19 mm (26.070 inches) (Ear to PSU handle without velcro strap)

NOTE: Zb is the nominal rear wall external surface where the system board I/O connectors reside.

Chassis weight

Table 21. Chassis maximum weight

System configuration	Maximum weight (with all drives/SSDs/rails/bezel)
4 x 3.5-inch system	18.62 kg (41.05 pound)
8 x 2.5-inch system	16.58 kg (36.55 pound)

Video specifications

The platform supports Integrated Matrox G200 graphics controller with 16 MB of video frame buffer:

Table 22. Video Resolution and Refresh Rate

Resolution	Refresh rate (Hz)	Color depth (bits)
1024 x 768	60	8, 16, 32
1280 x 800	60	8, 16, 32
1280 x 1024	60	8, 16, 32
1360 x 768	60	8, 16, 32
1440 x 900	60	8, 16, 32
1600 x 900	60	8, 16, 32
1600 x 1200	60	8, 16, 32
1680 x 1050	60	8, 16, 32
1920 x 1080	60	8, 16, 32
1920 x 1200	60	8, 16, 32

*DVO - DP is for investigation only, dependent on Nuvoton DVO capabilities to support up to 165 MHz.Rear Panel Performance is TBD subject to final board design and losses to rear VGA connector

*(RB) - Reduced Blanking for Digital Displays requiring less blank time. This was introduced for Signal Integrity improvements by reducing Pixel Clock rates for VGA- Analog input devices.

USB Ports

All USB ports follow USB specifications.

USB 2.0 and USB 3.0 ports support maximum output current of 0.5 A and 0.9 A, respectively. The ports cannot support high power consumption devices such as CD-ROM on the rear USB port of the rear I/O board and on the right control panel USB 2.0 port.

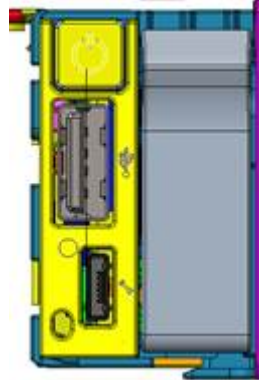

Figure 19. Front USB 2.0 Port



Figure 20. Rear USB

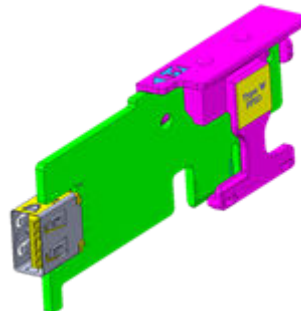

Figure 21. Internal USB

The size of the internal USB card dangle is 40 x 16 x 8 mm (L x W x H).

PSU rating

Below table lists the power capacity the PSUs in High/Low line operation mode.

Table 23. PSUs Highline and Lowline Ratings

1400 W Platinum	2400 W Platinum
Peak Power (Highline/-72 VDC) Highline/-72 VDC	
Peak Power (Lowline/-40 VDC) Lowline/-40 VDC	
Highline 240 VDC	
Highline 200-380 VDC	
DC-48-60 V	

PowerEdge systems support number of AC or DC power supplies.

Dell PSUs have achieved Platinum efficiency levels as shown in the table below.

Table 24. PSU Efficiency Level

Form Factor	Output	Class	10%	20%	50%	100%
Redundant 60 mm						
Redundant 86 mm						

Environmental specifications

The table below details the environmental specifications for the platform. For additional information about environmental measurements for specific system configurations, see [Product Safety, EMC and Environmental datasheets](#).

An important feature of having a broad menu of different categories is to allow the same platform model to have different operational ranges depending on the MRD defined.

A list of range categories for different configurations shall be identified by thermal team as early in the project as possible. Post release, see the Dell EMC PowerEdge R450 Technical Specifications at www.dell.com/poweredgemanuals.

Table 25. Operational Climatic Range Categories

Category A2	Allowable Operation
Temperature Ranges (For Altitude <900 meters or 2953 feet)	10 to 35°C (50 to 95°F) with no direct sunlight on the platform
Humidity Percent Ranges (Non-Condensing at all times)	8%RH with -12°C minimum dew point to 80%RH with 21°C (69.8°F) maximum dew point
Operational Altitude De-Rating	Maximum temperature is reduced by 1°C/300 meters (1.8°F/984 feet) above 900 meters (2,953 feet)

Table 26. Operational Climatic Range Categories

Category A3	Allowable Operation
Temperature Ranges (For Altitude <900 meters or 2953 feet)	5 to 40°C (41 to 104°F) with no direct sunlight on the platform

Table 26. Operational Climatic Range Categories (continued)

Category A3	Allowable Operation
Humidity Percent Ranges (Non-Condensing at all times)	8%RH with -12°C minimum dew point to 85%RH with 24°C (75.2°F) maximum dew point
Operational Altitude De-Rating	Maximum temperature is reduced by 1°C/175meters (1.8°F/574 feet) above 900 meters (2,953 feet)

Table 27. Operational Climatic Range Categories

Category A3	Allowable Operation
Temperature Ranges (For Altitude <900 meters or 2953 feet)	5 to 45°C (41 to 113°F) with no direct sunlight on the platform
Humidity Percent Ranges (Non-Condensing at all times)	8%RH with -12°C minimum dew point to 90%RH with 24°C (75.2°F) maximum dew point
Operational Altitude De-Rating	Maximum temperature is reduced by 1°C/125 meters (1.8°F/410 feet) above 900 meters (2,953 feet)

The table below shows the requirements shared across all environmental categories:

Table 28. Shared Requirements

Allowable Operation	
Maximum Temperature Gradient (applies to both operation and non-operation)	20°C in an hour* (36°F in an hour) and 5°C in 15 minutes (9°F in 15 minutes), 5°C in an hour* (9°F in an hour) for tape hardware
Non-Operational Temperature Limits	-40 to 65°C (-40 to 149°F)
Non-Operational Humidity Limits (Non-Condensing at all times)	5% to 95%RH with 27°C (80.6°F) maximum dew point
Maximum Non-Operational Altitude	12,000 meters (39,370 feet)
Maximum Operational Altitude	3,048 meters (10,000 feet)

Table 29. Maximum vibration specifications

Maximum vibration	Specifications
Operating	0.26Grms at 5Hz to 350Hz (x, y, and z axes)
Storage	1.88Grms at 10Hz to 500Hz for 15min (all six sides tested)

Table 30. Maximum shock specifications

Maximum vibration	Specifications
Operating	Six consecutively executed shock pulses in the positive and negative x, y, and z axes of 6G for up to 11ms
Storage	Six consecutively executed shock pulses in the positive and negative x, y, and z axes (one pulse on each side of the system) of 71 G for up to 2 ms

Thermal restrictions

Table 31. Thermal Solution Configuration

Configurations		CPU	Fan Type/ Q'ty	HSK Type	Air Shroud	DIMM blank	CPU Blank	Fan Counts	Fan Blank
SM Config	Rear Wall Config	TDP							
3.5" HDDs x4	W/O Rear HDDs	TDP <= 165W	STD Fan HPR SLVR (HPR) Fan for 165W CPU only	STD HS HPR HS for 165W CPU only	Yes	No	Only required on CPU2 for 1 Processor Config	7x Fans for 2 Processors Config 5x Fans for 1 Processor Config	Only required on Fan Slot 1 & Slot 2 for 1 Processor Config
		165W <TDP<= 220W	HPR Silver Fan (HPR)	HPR HS					
2.5" SAS/ SATA x8	W/O Rear HDDs	TDP<= 165W	STD Fan HPR SLVR (HPR) Fan for 165W CPU only	STD HS HPR HS for 165W CPU only	Yes	No	Only required on CPU2 for 1 Processor Config	7x Fans for 2 Processors Config 5x Fans for 1 Processor Config	Only required on Fan Slot 1 & Slot 2 for 1 Processor Config
		165W <TDP<= 220W	HPR Silver Fan (HPR)	STD HS					

i | **NOTE:** HDD Blanks are required for empty HDD slots.

Table 32. Thermal Restriction of 8x2.5 SAS/SATA & 4x3.5" Storage Configuration

Dell EMC PowerEdge Server Standard Operating Support (ASHRAE A2 compliant) All options supported unless otherwise noted.	Dell EMC PowerEdge Server Extended Inletient 40 ° C Operating Support (ASHRAE A3 compliant)	Dell EMC PowerEdge Server Extended Inletient 45 ° C Operating Support (ASHRAE A4 compliant)
<ul style="list-style-type: none"> • HPR Silver (HPR) Fan is required for CPU >165W • The Following OCP3.0 NIC only support optic cable with thermal Spec 85C and power <=1.2W <ul style="list-style-type: none"> ◦ Intel Columbiaville DP 25GbE SFP28 ◦ 8x2.5 SAS/SATA configuration only ◦ Broadcom Thor QP 25G SFP28 ◦ both Configurations ◦ Mellanox CX5 DP 25GbE SFP28 ◦ both configurations 	<ul style="list-style-type: none"> • Not support CPU TDP > 150W • Not support BOSS M.2 Module • Not support Non-Dell qualified peripheral cards. • Not support PCIe NIC consuming power >= 25W. Ex: CX6 card • Not Support Config with RM • Not support OCP transfer rate >25G or cooling tier > 10 • Optic Cable with spec 85C is required. • Two PSUs are required. System performance may 	A4 environment not Support

Table 32. Thermal Restriction of 8x2.5 SAS/SATA & 4x3.5" Storage Configuration

Dell EMC PowerEdge Server Standard Operating Support (ASHRAE A2 compliant) All options supported unless otherwise noted.	Dell EMC PowerEdge Server Extended Inletient 40 ° C Operating Support (ASHRAE A3 compliant)	Dell EMC PowerEdge Server Extended Inletient 45 ° C Operating Support (ASHRAE A4 compliant)
<ul style="list-style-type: none"> ○ Solarflare Medford2 DP 25GbE SFP28 both configurations ● PCIe NIC: Solarflare Medford2 DP 25GbE SFP28 only support optic cable with thermal Spec 85C and power <=1.2W ● PCIe NIC: Mellanox CX6 DP 100GbE QSFP56 only support optic cable with thermal Spec 85C and power <=2.5W ● PCIe SSD: Intel P4800X 750G and 375G could only support in PCIe slot2 and PCIe slot3 in 4x3.5 configs. No restriction in 8x2.5 SAS/SATA config. 	<p>be reduced in the event of a PSU failure</p>	

Appendix B. Standards compliance

The system conforms to the following industry standards.

Table 33. Industry standard documents

Standard	URL for information and specifications
ACPI Advance Configuration and Power Interface Specification, v2.0c	https://uefi.org/specsandtesttools
Ethernet IEEE 802.3-2005	https://standards.ieee.org/
HDG Hardware Design Guide Version 3.0 for Microsoft Windows Server	microsoft.com/whdc/system/platform/pcdesign/desguide/serverdg.mspx
IPMI Intelligent Platform Management Interface, v2.0	intel.com/design/servers/ipmi
DDR4 Memory DDR4 SDRAM Specification	jedec.org/standards-documents/docs/jesd79-4.pdf
PCI Express PCI Express Base Specification Rev. 2.0 and 3.0	pcisig.com/specifications/pciexpress
PMBus Power System Management Protocol Specification, v1.2	http://pmbus.org/Assets/PDFS/Public/PMBus_Specification_Part_1_Rev_1-1_20070205.pdf
SAS Serial Attached SCSI, v1.1	http://www.t10.org/
SATA Serial ATA Rev. 2.6; SATA II, SATA 1.0a Extensions, Rev. 1.2	sata-io.org
SMBIOS System Management BIOS Reference Specification, v2.7	dmtf.org/standards/smbios
TPM Trusted Platform Module Specification, v1.2 and v2.0	trustedcomputinggroup.org
UEFI Unified Extensible Firmware Interface Specification, v2.1	uefi.org/specifications
USB Universal Serial Bus Specification, Rev. 2.0	usb.org/developers/docs

Appendix C Additional resources

Table 34. Additional resources

Resource	Description of contents	Location
Installation and Service Manual	This manual, available in PDF format, provides the following information: <ul style="list-style-type: none"> • Chassis features • System Setup program • System indicator codes • System BIOS • Remove and replace procedures • Diagnostics • Jumpers and connectors 	Dell.com/Support/Manuals
Getting Started Guide	This guide ships with the system, and is also available in PDF format. This guide provides the following information: <ul style="list-style-type: none"> • Initial setup steps 	Dell.com/Support/Manuals
Rack Installation Guide	This document ships with the rack kits, and provides instructions for installing a server in a rack.	Dell.com/Support/Manuals
System Information Label	The system information label documents the system board layout and system jumper settings. Text is minimized due to space limitations and translation considerations. The label size is standardized across platforms.	Inside the system chassis cover
Quick Resource Locator (QRL)	This code on the chassis can be scanned by a phone application to access additional information and resources for the server, including videos, reference materials, service tag information, and Dell EMC contact information.	Inside the system chassis cover
Energy Smart Solution Advisor (ESSA)	The Dell EMC online ESSA enables easier and more meaningful estimates to help you determine the most efficient configuration possible. Use ESSA to calculate the power consumption of your hardware, power infrastructure, and storage.	Dell.com/calc