

AG50 CORE

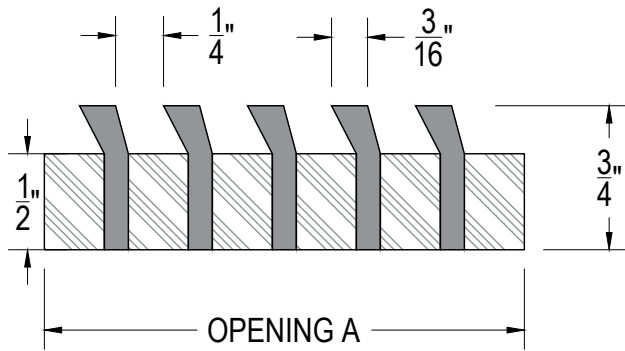

OPENING A
SECTION VIEW
SCALE 1:1

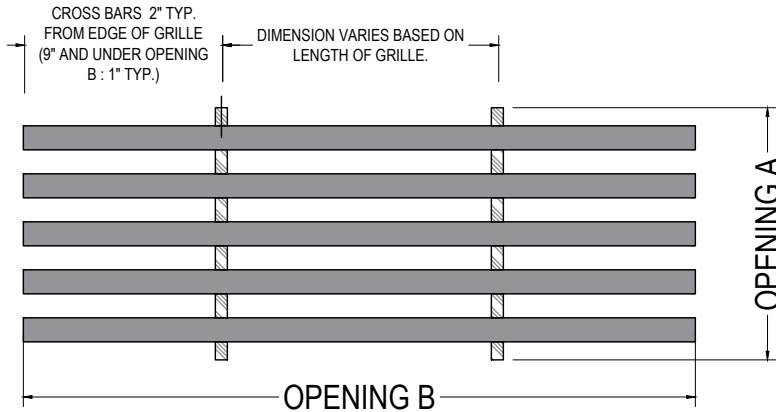

OPENING B
PLAN VIEW
SCALE 1:2

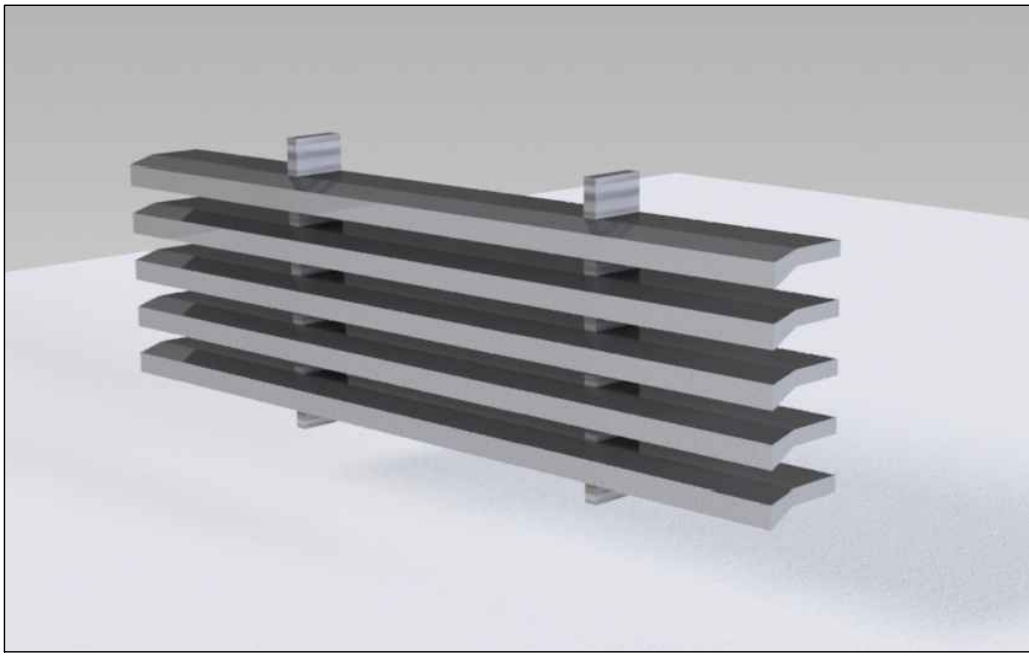

PERSPECTIVE VIEW

AG50 CORE REQUIREMENTS

DISCLAIMER:
We will manufacture **to the size requested**. We do not deduct for clearance and we do not undersize.

MATERIAL/FINISH:

- ALUMINUM
 - SATIN
 - MIRROR POLISH
 - POWDER COAT / RAL COLOR
 - PRIMED
 - ANODIZED CLEAR, BLACK, DURANOXID (LIGHT, MEDIUM OR DARK)
- BRONZE
 - SATIN
 - MIRROR POLISH
 - STATUARY BRONZE (LIGHT, MEDIUM OR DARK)

SPECIFY GRILLE LOCATION:

- WALL
- CEILING
- FLOOR
- (SEE DISCLAIMER ON OUR WEBSITE)
- OTHER

MOUNTING OPTIONS:

- 501 DROP IN
- 502 MOUNTING TABS

SEE MOUNTING SHEET FOR DETAIL

DOOR:

- YES • LEFT • RIGHT
- NO DOOR
- STANDARD DOOR (6 1/2")
OR CUSTOM SIZE
- STANDARD PIVOT (1 1/2" IN FROM DOOR EDGE.)
OR CUSTOM

OTHER:

- CUSTOM BAR SPACING
- T-BAR SUPPORT
- MITERED ENDS

ORDER FORM AVAILABLE AT:
<https://www.archgrille.com/pages/quotes>



ARCHITECTURAL GRILLE

42 SECOND AVE
BROOKLYN, NY 11215
718-832-1200
FAX: 718-832-1390

AG50 A FRAME

With a 3/4" flange offering a classic style, the B Frame gives a bolder look to any core while 'covering' any rough or uneven cuts made for the air vent opening. Please note that the B Frame is fixed to the core.

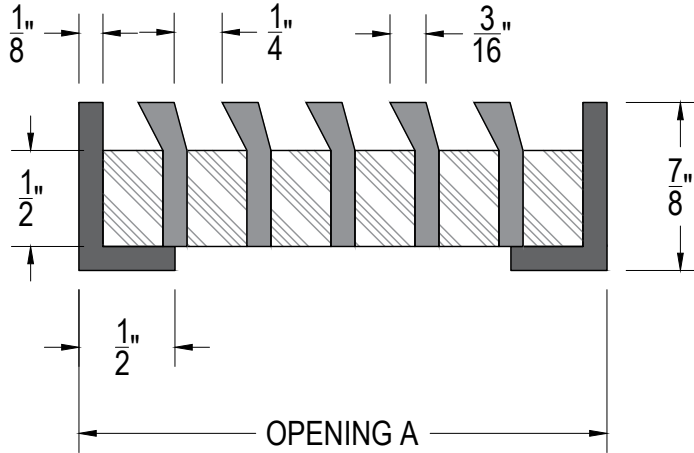

SECTION VIEW
SCALE 1:1

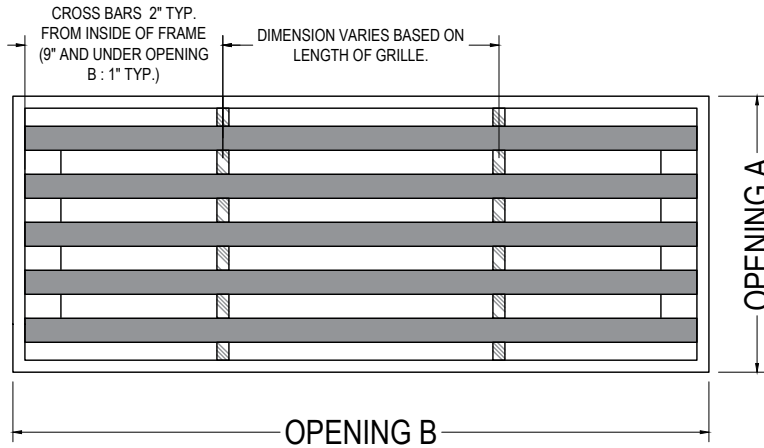

PLAN VIEW
SCALE 1:2



PERSPECTIVE VIEW

AG50 A FRAME REQUIREMENTS

DISCLAIMER:
We will manufacture to the size requested. We do not deduct for clearance and we do not undersize.

MATERIAL/FINISH:

- ALUMINUM
 - SATIN
 - MIRROR POLISH
 - POWDER COAT / RAL COLOR
 - PRIMED
 - ANODIZED CLEAR, BLACK, DURANODIC (LIGHT, MEDIUM OR DARK)
- BRONZE
 - SATIN
 - MIRROR POLISH
 - STATUARY BRONZE (LIGHT, MEDIUM OR DARK)

SPECIFY GRILLE LOCATION:

- WALL
- CEILING
- FLOOR
- (SEE DISCLAIMER ON OUR WEBSITE)
- OTHER

MOUNTING OPTIONS:

- 503 WELDED CORE. NO MOUNTING.
- 505 REMOVABLE CORE WITH MOUNTING TABS AND SIDEWALL SCREWS.
- 508 REMOVABLE CORE WITH MOUNTING TABS.
- 516 WELDED CORE WITH CONCEALED MOUNTING USING SCREWS THROUGH BACK LEG.

SEE MOUNTING SHEET FOR DETAIL

DOOR:

- YES • LEFT • RIGHT
- NO DOOR
- STANDARD DOOR (6 1/2") OR CUSTOM SIZE
- STANDARD PIVOT (1 1/2" IN FROM DOOR EDGE) OR CUSTOM

OTHER:

- CUSTOM BAR SPACING
- T-BAR SUPPORT
- MITERED ENDS

ORDER FORM AVAILABLE AT:
<https://www.archgrille.com/pages/quotes>



ARCHITECTURAL GRILLE

42 SECOND AVE
BROOKLYN, NY 11215
718-832-1200
FAX: 718-832-1390

AG50 B FRAME

(WELDED CORE ONLY)

With a 3/4" flange offering a classic style, the B Frame gives a bolder look to any core while 'covering' any rough or uneven cuts made for the air vent opening.

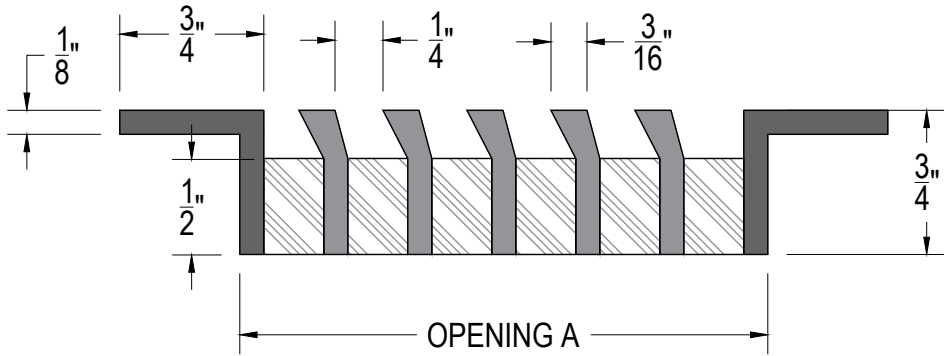

OPENING A

SECTION VIEW
SCALE 1:1

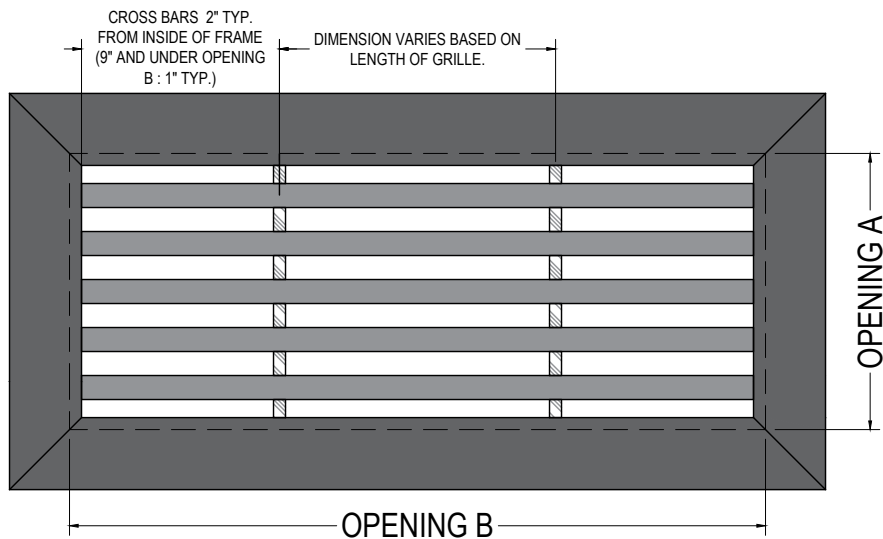

OPENING B

PLAN VIEW
SCALE 1:2

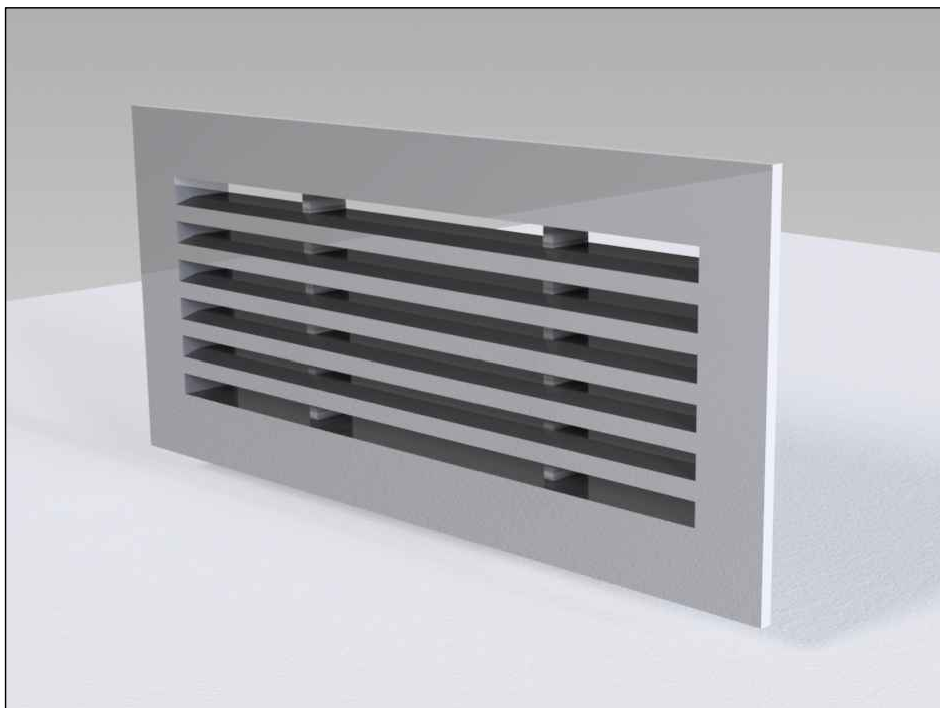

PERSPECTIVE VIEW

AG60 B FRAME REQUIREMENTS

DISCLAIMER:
We will manufacture **to the size requested**. We do not deduct for clearance and we do not undersize.

MATERIAL/FINISH:

- ALUMINUM
 - SATIN
 - MIRROR POLISH
 - POWDER COAT / RAL COLOR
 - PRIMED
 - ANODIZED CLEAR, BLACK, DURANODIC (LIGHT, MEDIUM OR DARK)
- BRONZE
 - SATIN
 - MIRROR POLISH
 - STATUARY BRONZE (LIGHT, MEDIUM OR DARK)

SPECIFY GRILLE LOCATION:

- WALL
- CEILING
- FLOOR
- (SEE DISCLAIMER ON OUR WEBSITE)
- OTHER

MOUNTING OPTIONS:

- 506 OPENING ROUTED TO FLANGE SIZE
 - 507 FLANGE RESTS ON COUNTER/WALL/FLOOR NO ADDITIONAL MOUNTING INCLUDED.
 - 511 T-BAR FOR ADDITIONAL SUPPORT (IDEAL FOR FLOOR USE)
 - 514 COUNTERSUNK SCREWS THROUGH FRAME
 - 523 REVERSE FRAME FOR MOUNTING FROM BEHIND WITH SCREWS
 - 524 MOUNTING TABS
- SEE MOUNTING SHEET FOR DETAIL

DOOR:

- YES • LEFT • RIGHT
- NO DOOR
- STANDARD DOOR (6 1/2") OR CUSTOM SIZE
- STANDARD PIVOT (1 1/2" IN FROM DOOR EDGE.) OR CUSTOM

OTHER:

- CUSTOM BAR SPACING
- T-BAR SUPPORT
- MITERED ENDS

ORDER FORM AVAILABLE AT:
<https://www.archgrille.com/pages/quotes>



ARCHITECTURAL GRILLE

42 SECOND AVE
BROOKLYN, NY 11215
718-832-1200
FAX: 718-832-1390

AG50 C FRAME

The best of both the A and B Frames, the C Frame has a 3/4" flange for a bolder look and a 1/2" return on the bottom for added support. It can be removable (loose) or fixed to the core and is recommended for floor applications

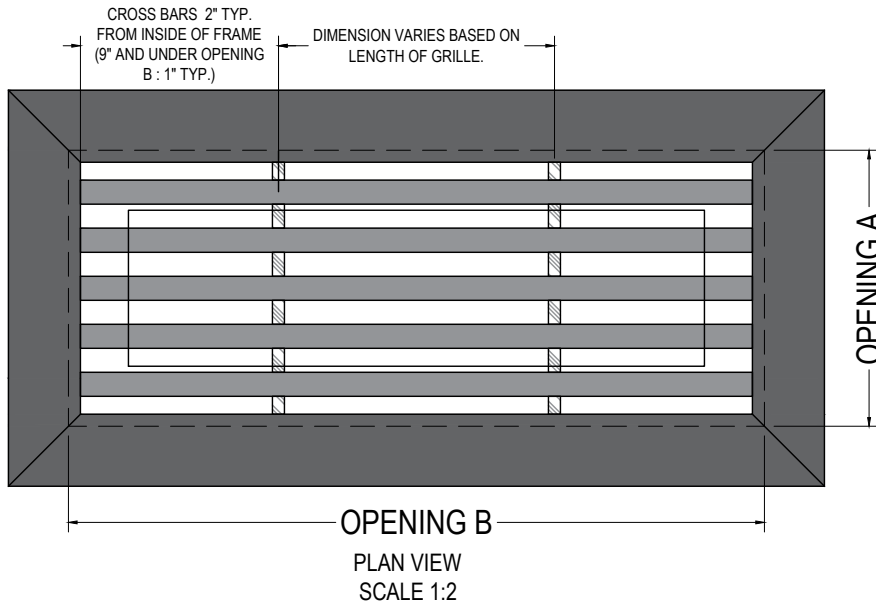
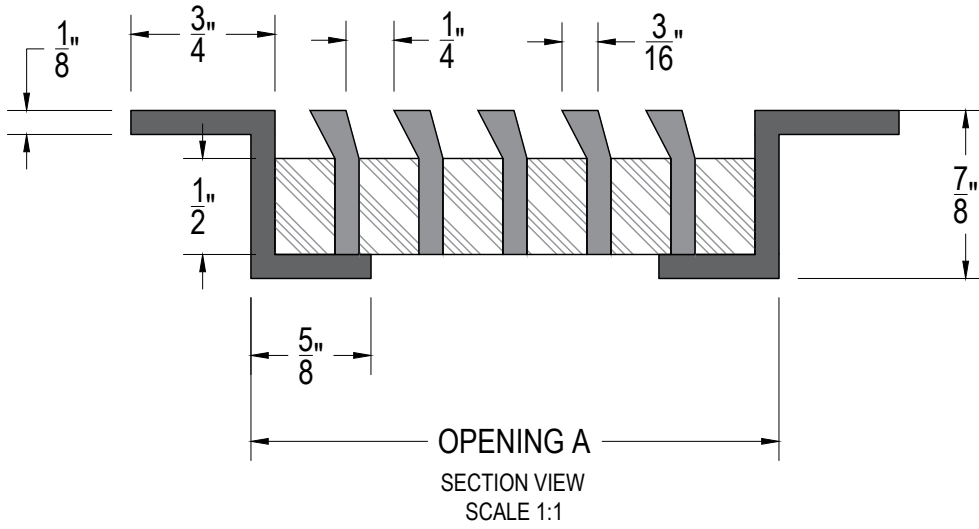

PERSPECTIVE VIEW

AG50 C FRAME REQUIREMENTS

DISCLAIMER:
We will manufacture to the size requested. We do not deduct for clearance and we do not undersize.

MATERIAL/FINISH:

- ALUMINUM
 - SATIN
 - MIRROR POLISH
 - POWDER COAT / RAL COLOR
 - PRIMED
 - ANODIZED (CLEAR, BLACK, DURANODIC (LIGHT, MEDIUM OR DARK))
- BRONZE
 - SATIN
 - MIRROR POLISH
 - STATUARY BRONZE (LIGHT, MEDIUM OR DARK)

SPECIFY GRILLE LOCATION:

- WALL
- CEILING
- FLOOR
- (SEE DISCLAIMER ON OUR WEBSITE)
- OTHER

MOUNTING OPTIONS:

- 504 WELDED CORE. NO MOUNTING.
- 505 REMOVABLE CORE WITH MOUNTING TABS AND SIDEWALL SCREWS.
- 508 REMOVABLE CORE WITH MOUNTING TABS.
- 511 T-BAR FOR ADDITIONAL SUPPORT (IDEAL FOR FLOOR USE)
- 515 COUNTERSUNK SCREWS THROUGH FLANGE.

SEE MOUNTING SHEET FOR DETAIL

DOOR:

- YES • LEFT • RIGHT
- NO DOOR
- STANDARD DOOR (6 1/2") OR CUSTOM SIZE
- STANDARD PIVOT (1 1/2" IN FROM DOOR EDGE.) OR CUSTOM

OTHER:

- CUSTOM BAR SPACING
- T-BAR SUPPORT
- MITERED ENDS

ORDER FORM AVAILABLE AT:
<https://www.archgrille.com/pages/quotes>



ARCHITECTURAL GRILLE

42 SECOND AVE
BROOKLYN, NY 11215
718-832-1200
FAX: 718-832-1390

AG50 D FRAME

Featuring a flange like the B frame, to cover any rough or uneven air vent openings, each style offers varied flange sizes with a beveled edge for a more decorative look

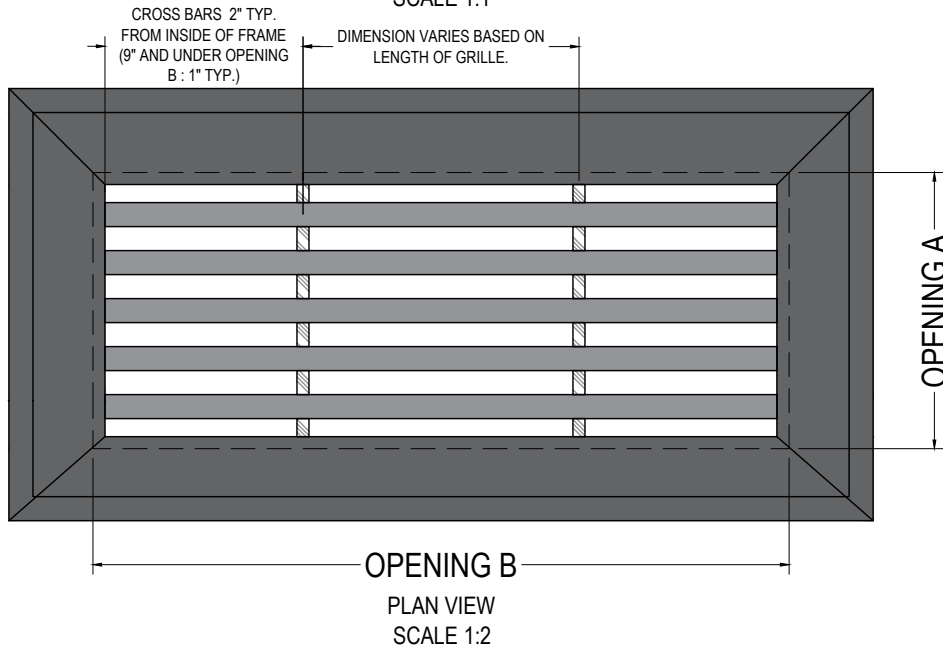
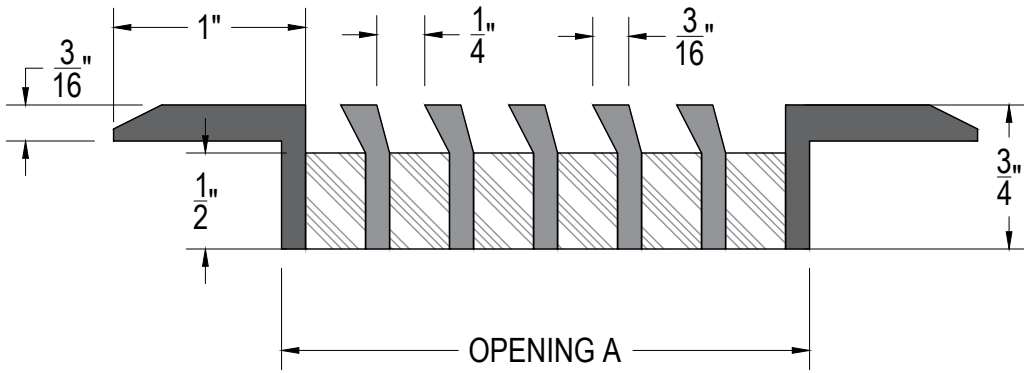

PERSPECTIVE VIEW

AG50 D FRAME REQUIREMENTS

DISCLAIMER:
We will manufacture **to the size requested**. We do not deduct for clearance and we do not undersize.

MATERIAL/FINISH:

- ALUMINUM
 - SATIN
 - MIRROR POLISH
 - POWDER COAT / RAL COLOR
 - PRIMED
 - ANODIZED (CLEAR, BLACK, DURANODIC (LIGHT, MEDIUM OR DARK))
- BRONZE
 - SATIN
 - MIRROR POLISH
 - STATUARY BRONZE (LIGHT, MEDIUM OR DARK)

SPECIFY GRILLE LOCATION:

- WALL
- CEILING
- FLOOR
- (SEE DISCLAIMER ON OUR WEBSITE)
- OTHER

MOUNTING OPTIONS:

- 507 FLANGE RESTS ON COUNTER/WALL/FLOOR NO ADDITIONAL MOUNTING INCLUDED.
- 511 T-BAR FOR ADDITIONAL SUPPORT (IDEAL FOR FLOOR USE)
- 515 COUNTERSUNK SCREWS THROUGH FLANGE.
- 524 MOUNTING TABS

SEE MOUNTING SHEET FOR DETAIL

DOOR:

- YES • LEFT • RIGHT
- NO DOOR
- STANDARD DOOR (6 1/2") OR CUSTOM SIZE
- STANDARD PIVOT (1 1/2" IN FROM DOOR EDGE) OR CUSTOM

OTHER:

- CUSTOM BAR SPACING
- T-BAR SUPPORT
- MITERED ENDS

ORDER FORM AVAILABLE AT:
<https://www.archgrille.com/pages/quotes>



ARCHITECTURAL GRILLE

42 SECOND AVE
BROOKLYN, NY 11215
718-832-1200
FAX: 718-832-1390

AG50 E FRAME

Featuring a flange like the B frame, to cover any rough or uneven air vent openings, each style offers varied flange sizes with a beveled edge for a more decorative look

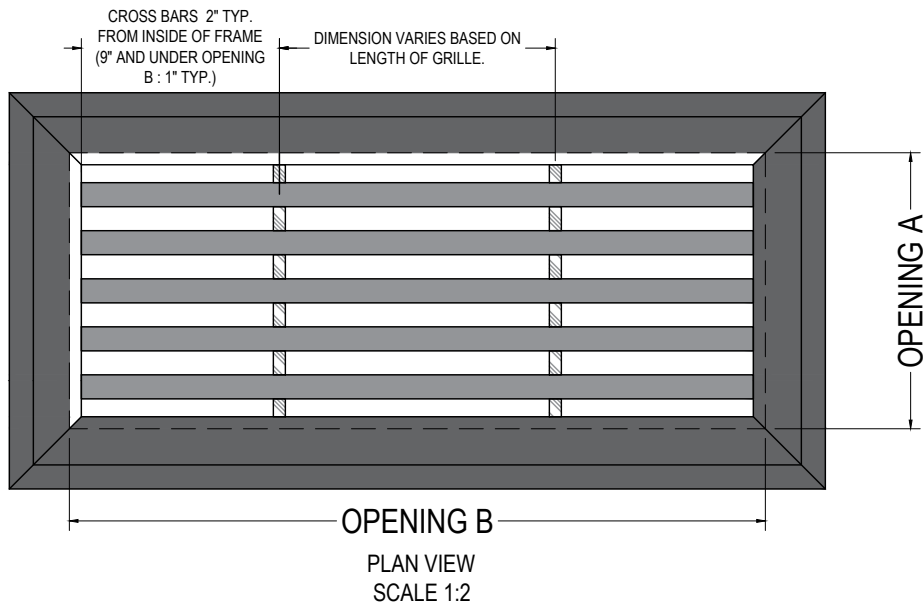
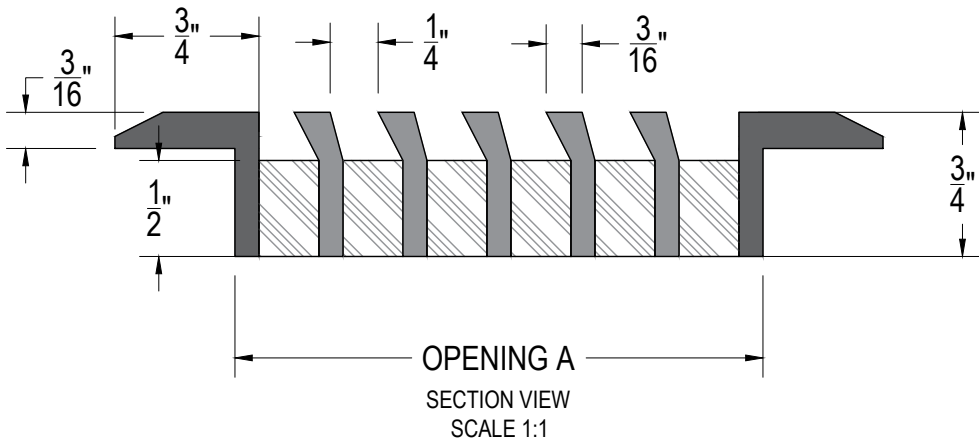

PERSPECTIVE VIEW

AG50 E FRAME REQUIREMENTS

DISCLAIMER:
We will manufacture **to the size requested**. We do not deduct for clearance and we do not undersize.

MATERIAL/FINISH:

- ALUMINUM
 - SATIN
 - MIRROR POLISH
 - POWDER COAT / RAL COLOR
 - PRIMED
 - ANODIZED CLEAR, BLACK, DURANODIC (LIGHT, MEDIUM OR DARK)
- BRONZE
 - SATIN
 - MIRROR POLISH
 - STATUARY BRONZE (LIGHT, MEDIUM OR DARK)

SPECIFY GRILLE LOCATION:

- WALL
- CEILING
- FLOOR
- (SEE DISCLAIMER ON OUR WEBSITE)
- OTHER

MOUNTING OPTIONS:

- 507 FLANGE RESTS ON COUNTER/WALL/FLOOR NO ADDITIONAL MOUNTING INCLUDED.
- 511 T-BAR FOR ADDITIONAL SUPPORT (IDEAL FOR FLOOR USE)
- 515 COUNTERSUNK SCREWS THROUGH FLANGE.
- 524 MOUNTING TABS

SEE MOUNTING SHEET FOR DETAIL

DOOR:

- YES • LEFT • RIGHT
- NO DOOR
- STANDARD DOOR (6 1/2") OR CUSTOM SIZE
- STANDARD PIVOT (1 1/2" IN FROM DOOR EDGE) OR CUSTOM

OTHER:

- CUSTOM BAR SPACING
- T-BAR SUPPORT
- MITERED ENDS

ORDER FORM AVAILABLE AT:
<https://www.archgrille.com/pages/quotes>



ARCHITECTURAL GRILLE

42 SECOND AVE
BROOKLYN, NY 11215
718-832-1200
FAX: 718-832-1390

AG50 F FRAME

Featuring a flange like the B frame, to cover any rough or uneven air vent openings, each style offers varied flange sizes with a beveled edge for a more decorative look

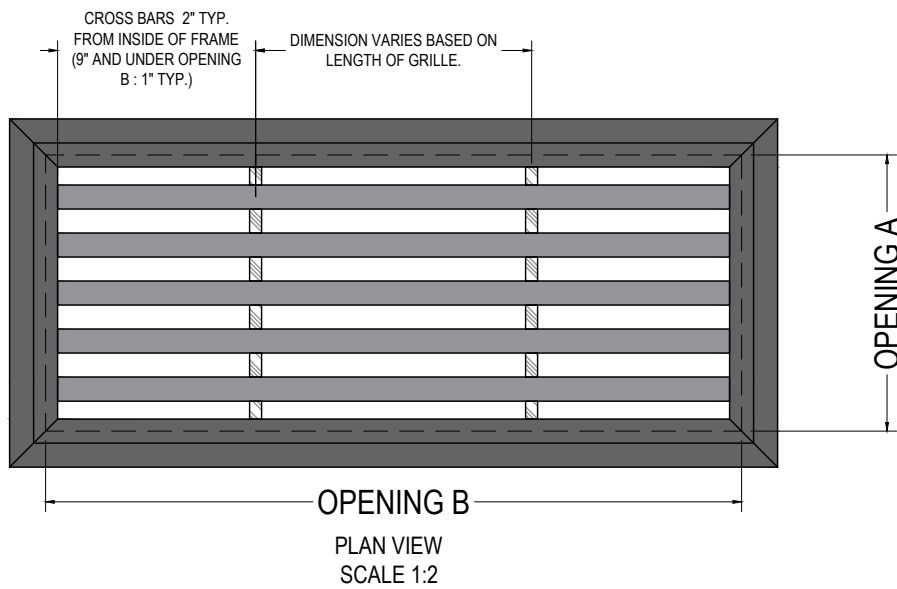
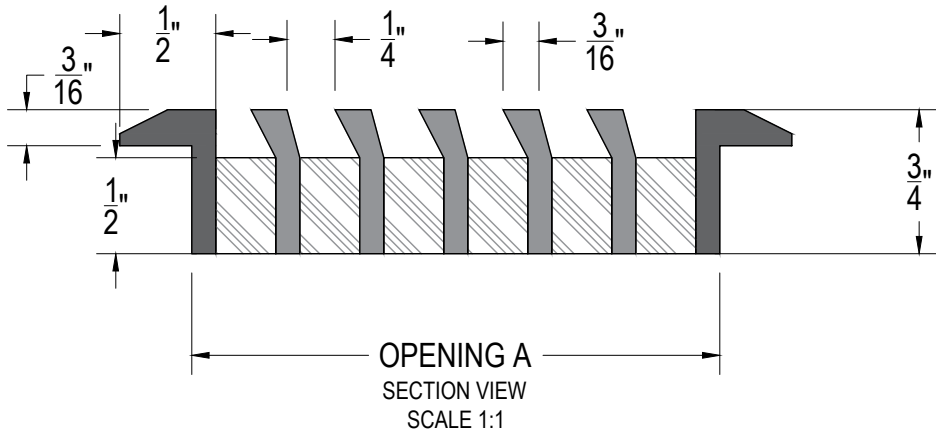

PERSPECTIVE VIEW

AG50 F FRAME REQUIREMENTS

DISCLAIMER:
We will manufacture to the size requested. We do not deduct for clearance and we do not undersize.

MATERIAL/FINISH:

- ALUMINUM
 - SATIN
 - MIRROR POLISH
 - POWDER COAT / RAL COLOR
 - PRIMED
 - ANODIZED (CLEAR, BLACK, DURANODIC (LIGHT, MEDIUM OR DARK))
- BRONZE
 - SATIN
 - MIRROR POLISH
 - STATUARY BRONZE (LIGHT, MEDIUM OR DARK)

SPECIFY GRILLE LOCATION:

- WALL
- CEILING
- FLOOR
- (SEE DISCLAIMER ON OUR WEBSITE)
- OTHER

MOUNTING OPTIONS:

- 507 FLANGE RESTS ON COUNTERWALL/FLOOR NO ADDITIONAL MOUNTING INCLUDED.
- 511 T-BAR FOR ADDITIONAL SUPPORT (IDEAL FOR FLOOR USE)
- 515 COUNTERSUNK SCREWS THROUGH FLANGE.
- 524 MOUNTING TABS

SEE MOUNTING SHEET FOR DETAIL

DOOR:

- YES • LEFT • RIGHT
- NO DOOR
- STANDARD DOOR (6 1/2") OR CUSTOM SIZE
- STANDARD PIVOT (1 1/2" IN FROM DOOR EDGE.) OR CUSTOM

OTHER:

- CUSTOM BAR SPACING
- T-BAR SUPPORT
- MITERED ENDS

ORDER FORM AVAILABLE AT:
<https://www.archgrille.com/pages/quotes>



ARCHITECTURAL GRILLE

42 SECOND AVE
BROOKLYN, NY 11215
718-832-1200
FAX: 718-832-1390

AG50 G FRAME

When added stability isn't required (it does not have a return), this frame style offers the same 1/8" bar around the perimeter of the core as the A Frame, it is also only available with a fixed core.

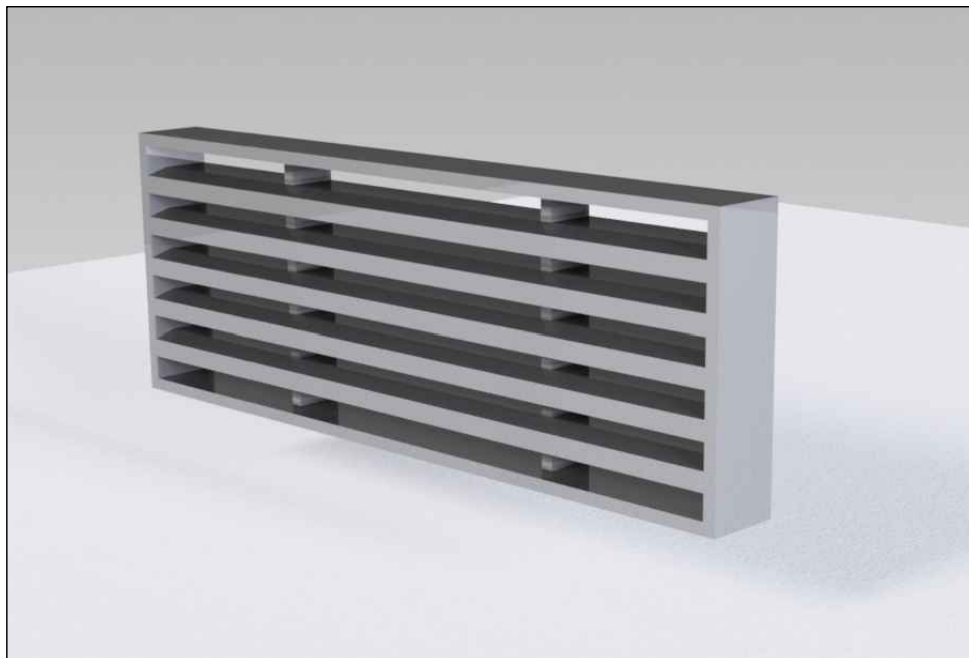
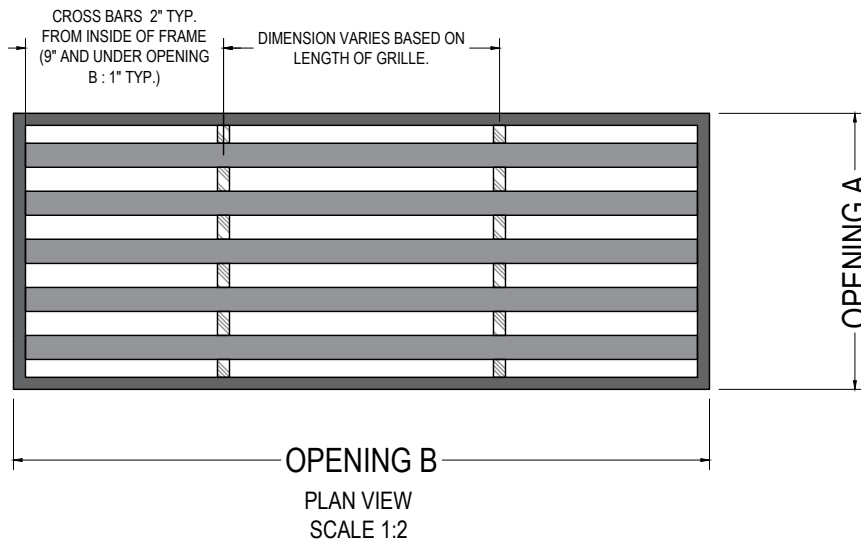
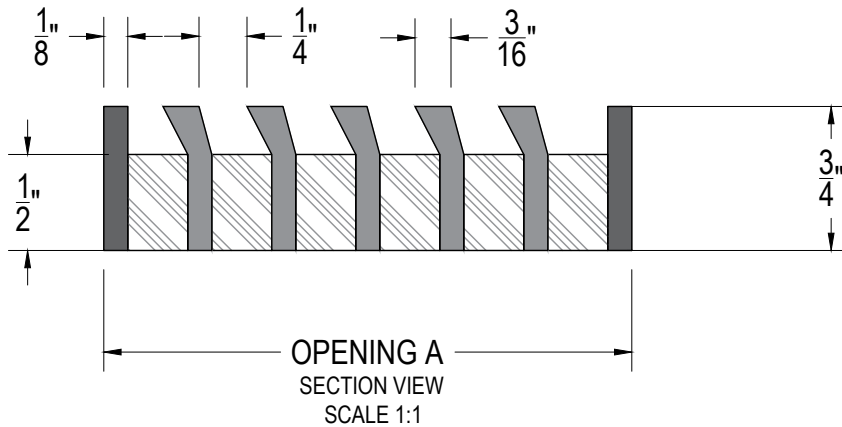

PERSPECTIVE VIEW

AG50 G FRAME REQUIREMENTS

DISCLAIMER:
We will manufacture to the size requested. We do not deduct for clearance and we do not undersize.

MATERIAL/FINISH:

- ALUMINUM
 - SATIN
 - MIRROR POLISH
 - POWDER COAT / RAL COLOR
 - PRIMED
 - ANODIZED (CLEAR, BLACK, DURANODIC (LIGHT, MEDIUM OR DARK))
- BRONZE
 - SATIN
 - MIRROR POLISH
 - STATUARY BRONZE (LIGHT, MEDIUM OR DARK)

SPECIFY GRILLE LOCATION:

- WALL
- CEILING
- FLOOR
- (SEE DISCLAIMER ON OUR WEBSITE)
- OTHER

MOUNTING OPTIONS:

- 503 WELDED CORE
- 510 WELDED CORE, NO MOUNTING.
- 511 T-BAR FOR ADDITIONAL SUPPORT (IDEAL FOR FLOOR USE)
- 525 MOUNTING TABS

SEE MOUNTING SHEET FOR DETAIL

DOOR:

- YES • LEFT • RIGHT
- NO DOOR
- STANDARD DOOR (6 1/2") OR CUSTOM SIZE
- STANDARD PIVOT (1 1/2" IN FROM DOOR EDGE) OR CUSTOM

OTHER:

- CUSTOM BAR SPACING
- T-BAR SUPPORT
- MITERED ENDS

ORDER FORM AVAILABLE AT:
<https://www.archgrille.com/pages/quotes>



ARCHITECTURAL GRILLE

42 SECOND AVE
BROOKLYN, NY 11215
718-832-1200
FAX: 718-832-1390

AG50 H FRAME

With an easy "clean line" installation method, this "less is more" frame style is ideal for sub-floor applications. The 1/2" return at the bottom allows for the core to be loose (removable) or fixed to the frame.

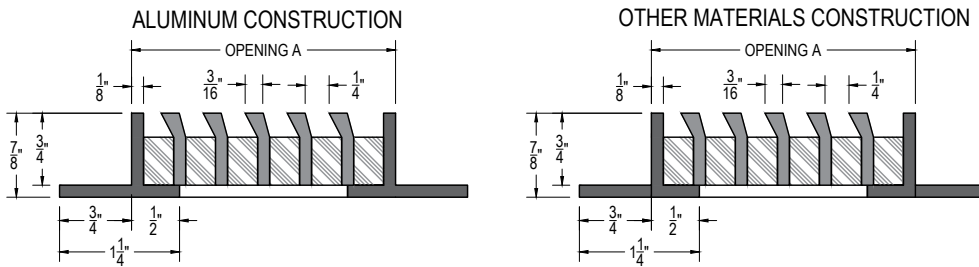

SECTION VIEW
SCALE 1:1

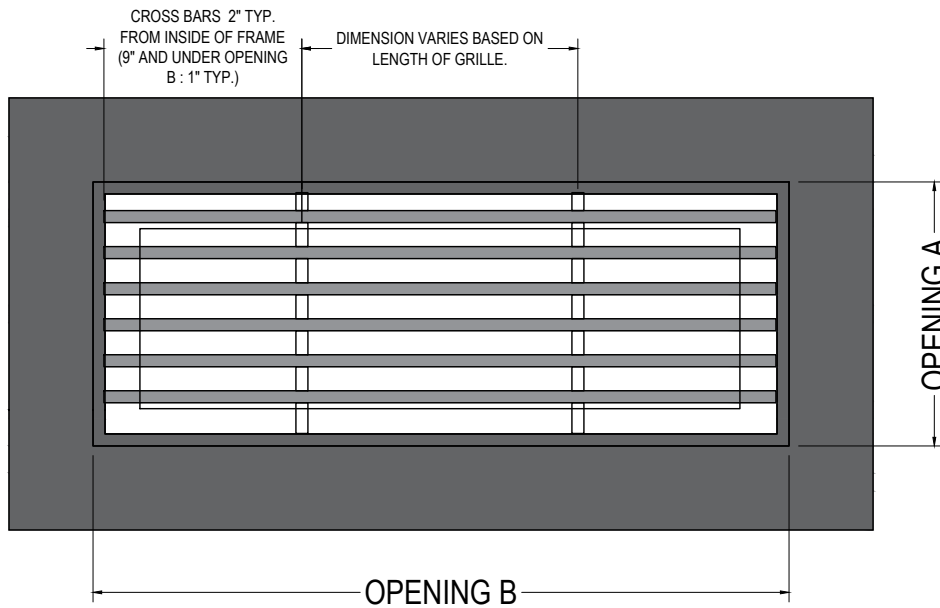

OPENING B
PLAN VIEW
SCALE 1:2



PERSPECTIVE VIEW

AG50 H FRAME REQUIREMENTS

DISCLAIMER:
We will manufacture **to the size requested**. We do not deduct for clearance and we do not undersize.

MATERIAL/FINISH:

- **ALUMINUM**
SATIN
MIRROR POLISH
POWDER COAT / RAL COLOR
PRIMED
ANODIZED CLEAR, BLACK, DURANODIC (LIGHT, MEDIUM OR DARK)
- **BRONZE**
SATIN
MIRROR POLISH
STATUARY BRONZE (LIGHT, MEDIUM OR DARK)

SPECIFY GRILLE LOCATION:

- WALL
- CEILING
- FLOOR
- (SEE DISCLAIMER ON OUR WEBSITE)
- OTHER

MOUNTING OPTIONS:

- 521 WELDED CORE. SPACKLE IN FRAME.
- 522 REMOVABLE CORE WITH MOUNTING TABS.

SEE MOUNTING SHEET FOR DETAIL

DOOR:

- YES • LEFT • RIGHT
- NO DOOR
- STANDARD DOOR (6 1/2")
OR CUSTOM SIZE
- STANDARD PIVOT (1 1/2" IN FROM DOOR EDGE.)
OR CUSTOM

OTHER:

- CUSTOM BAR SPACING
- T-BAR SUPPORT
- MITERED ENDS

ORDER FORM AVAILABLE AT:
<https://www.archgrille.com/pages/quotes>



ARCHITECTURAL GRILLE

42 SECOND AVE
BROOKLYN, NY 11215
718-832-1200
FAX: 718-832-1390

AG50 I FRAME

With an easy "clean line" installation method, this "less is more" frame style is ideal for drywall or plaster applications.

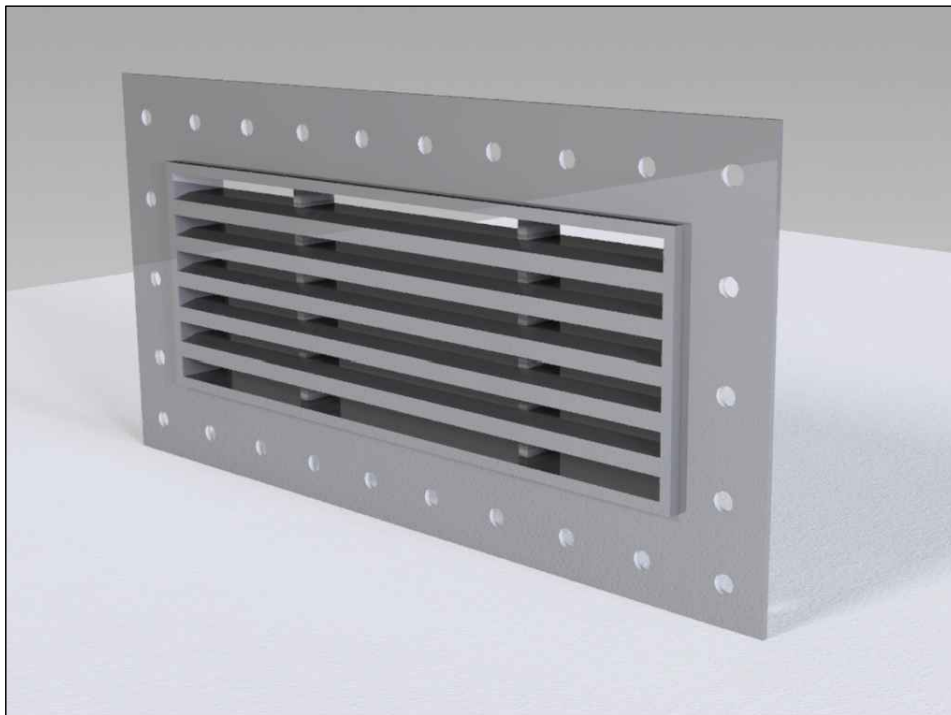
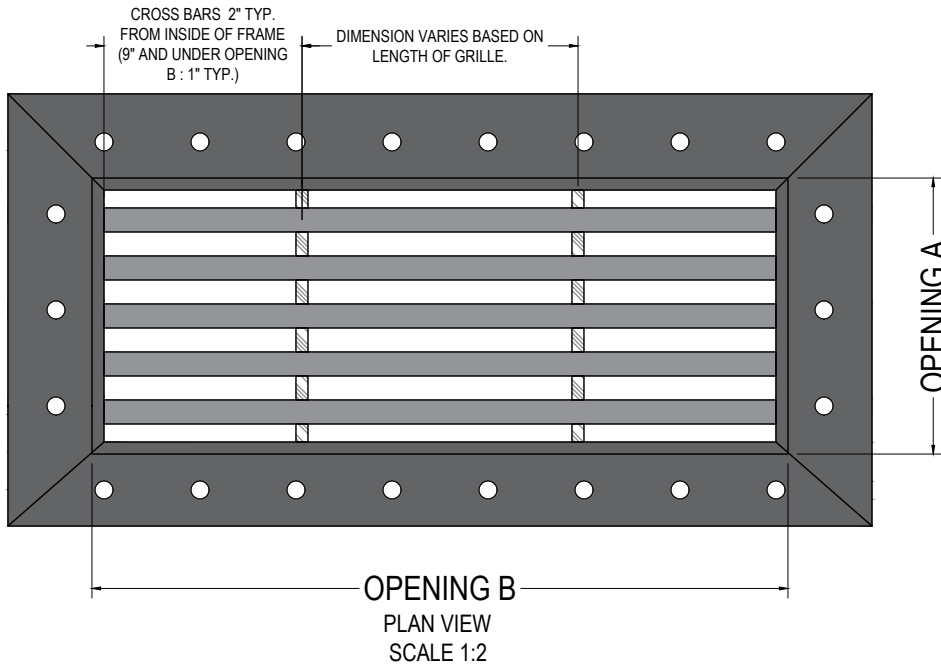
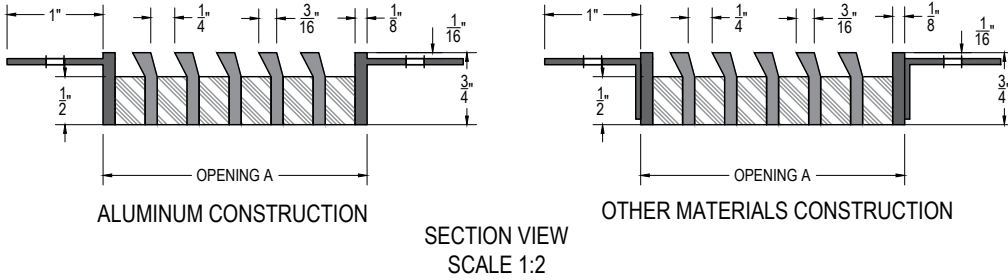

AG50 I FRAME REQUIREMENTS

DISCLAIMER:
We will manufacture **to the size requested**. We do not deduct for clearance and we do not undersize.

MATERIAL/FINISH:

- ALUMINUM
 - SATIN
 - MIRROR POLISH
 - POWDER COAT / RAL COLOR
 - PRIMED
 - ANODIZED CLEAR, BLACK, DURANOXIC (LIGHT, MEDIUM OR DARK)
- BRONZE
 - SATIN
 - MIRROR POLISH
 - STATUARY BRONZE (LIGHT, MEDIUM OR DARK)

SPECIFY GRILLE LOCATION:

- WALL
- CEILING
- FLOOR
(SEE DISCLAIMER ON OUR WEBSITE)
- OTHER

MOUNTING OPTIONS:

- 518 WELDED CORE. SPACKLE IN FRAME.

SEE MOUNTING SHEET FOR DETAIL

DOOR:

- YES • LEFT • RIGHT
- NO DOOR
- STANDARD DOOR (6 1/2")
OR CUSTOM SIZE
- STANDARD PIVOT (1 1/2" IN FROM DOOR EDGE)
OR CUSTOM

OTHER:

- CUSTOM BAR SPACING
- T-BAR SUPPORT
- MITERED ENDS

ORDER FORM AVAILABLE AT:
<https://www.archgrille.com/pages/quotes>



ARCHITECTURAL GRILLE

42 SECOND AVE
BROOKLYN, NY 11215
718-832-1200
FAX: 718-832-1390

AG50 J FRAME

With an easy "clean line" installation method, this "less is more" frame style is ideal for drywall or plaster applications. The 1/2" return at the bottom allows for the core to be loose (removable) or fixed to the frame.

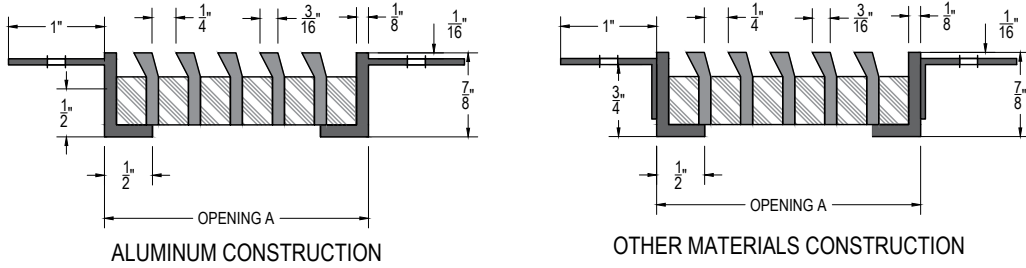

SECTION VIEW
SCALE 1:2

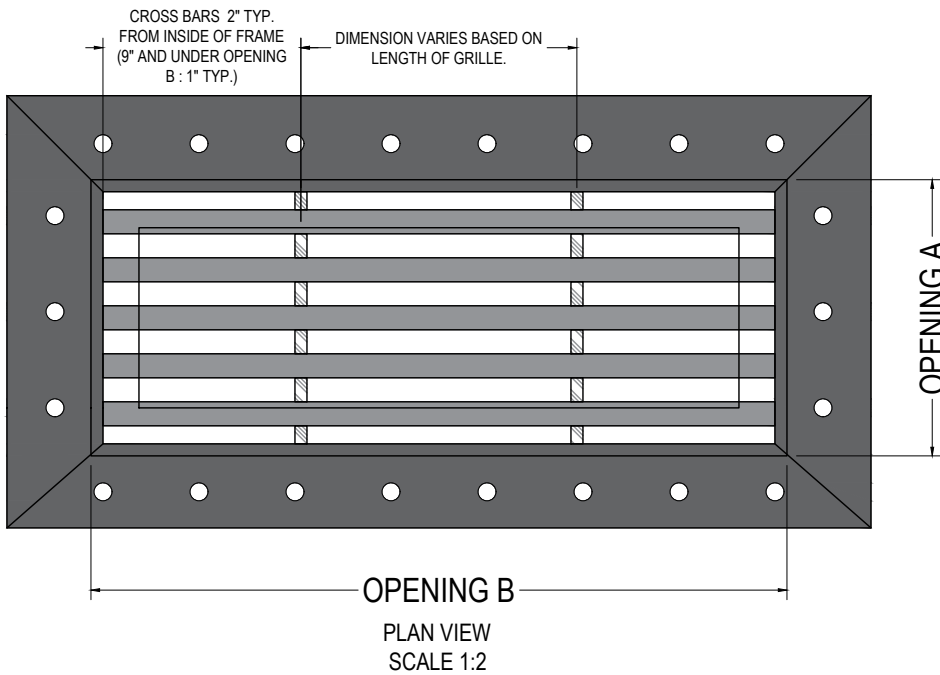

PLAN VIEW
SCALE 1:2

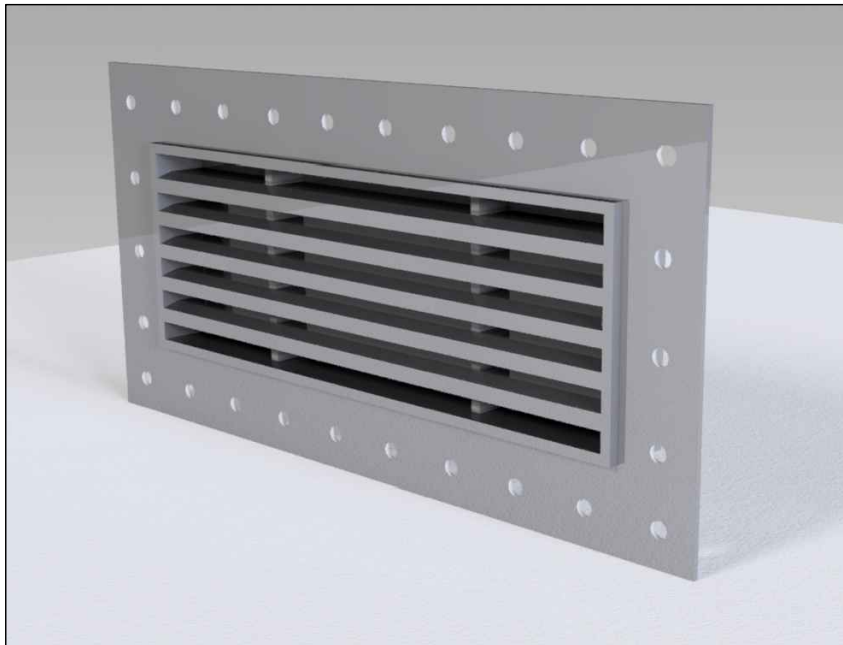

PERSPECTIVE VIEW

AG50 J FRAME REQUIREMENTS

DISCLAIMER:
We will manufacture to the size **requested**. We do not deduct for clearance and we do not undersize.

MATERIAL/FINISH:

- **ALUMINUM**
 - SATIN
 - MIRROR POLISH
 - POWDER COAT / RAL COLOR
 - PRIMED
 - ANODIZED CLEAR, BLACK, DURANODIC (LIGHT, MEDIUM OR DARK)
- **BRONZE**
 - SATIN
 - MIRROR POLISH
 - STATUARY BRONZE (LIGHT, MEDIUM OR DARK)

SPECIFY GRILLE LOCATION:

- WALL
- CEILING
- FLOOR
- (SEE DISCLAIMER ON OUR WEBSITE)
- OTHER

MOUNTING OPTIONS:

- 512 WELDED CORE.
- 513 REMOVABLE CORE WITH MOUNTING TABS.

SEE MOUNTING SHEET FOR DETAIL

DOOR:

- YES • LEFT • RIGHT
- NO DOOR
- STANDARD DOOR (6 1/2") OR CUSTOM SIZE
- STANDARD PIVOT (1 1/2" IN FROM DOOR EDGE.) OR CUSTOM

OTHER:

- CUSTOM BAR SPACING
- T-BAR SUPPORT
- MITERED ENDS

ORDER FORM AVAILABLE AT:
<https://www.archgrille.com/pages/quotes>



ARCHITECTURAL GRILLE

42 SECOND AVE
BROOKLYN, NY 11215
718-832-1200
FAX: 718-832-1390

AG50 K FRAME

With an easy "clean line" installation method, this "less is more" frame style is ideal for drywall or plaster applications. The 1/2" return at the bottom allows for the core to be loose (removable) or fixed to the frame.

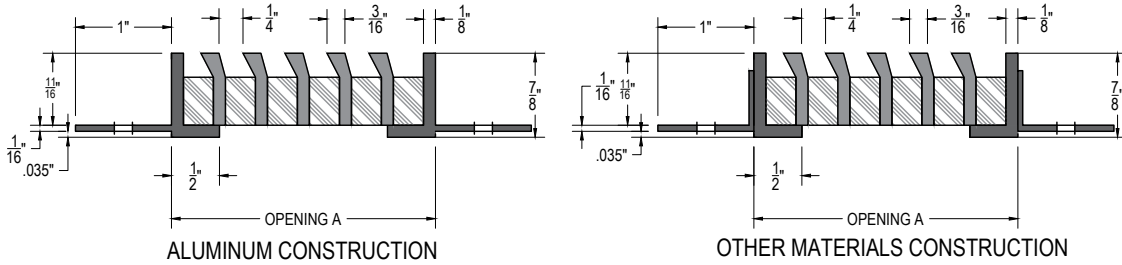

SECTION VIEW
SCALE 1:2

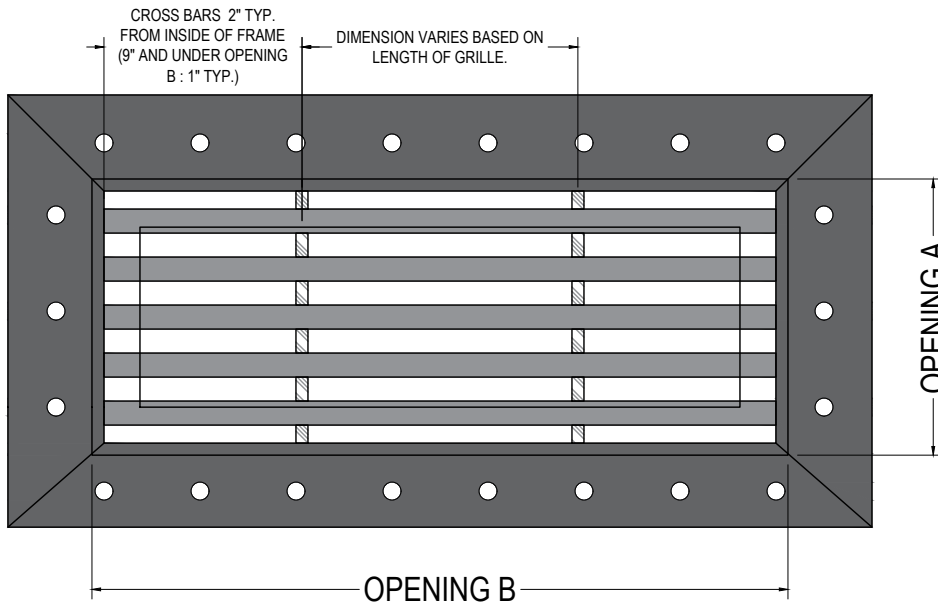

PLAN VIEW
SCALE 1:2



PERSPECTIVE VIEW

AG50 K FRAME REQUIREMENTS

DISCLAIMER:
We will manufacture to the size requested. We do not deduct for clearance and we do not undersize.

MATERIAL/FINISH:

- ALUMINUM
 - SATIN
 - MIRROR POLISH
 - POWDER COAT / RAL COLOR
 - PRIMED
 - ANODIZED (CLEAR, BLACK, DURANODIC (LIGHT, MEDIUM OR DARK))
- BRONZE
 - SATIN
 - MIRROR POLISH
 - STATUARY BRONZE (LIGHT, MEDIUM OR DARK)

SPECIFY GRILLE LOCATION:

- WALL
- CEILING
- FLOOR
(SEE DISCLAIMER ON OUR WEBSITE)
- OTHER

MOUNTING OPTIONS:

- 519 WELDED CORE. SPACKLE IN FRAME.
- 520 REMOVABLE CORE WITH MOUNTING TABS.

SEE MOUNTING SHEET FOR DETAIL

DOOR:

- YES • LEFT • RIGHT
- NO DOOR
- STANDARD DOOR (6 1/2") OR CUSTOM SIZE
- STANDARD PIVOT (1 1/2" IN FROM DOOR EDGE) OR CUSTOM

OTHER:

- CUSTOM BAR SPACING
- T-BAR SUPPORT
- MITERED ENDS

ORDER FORM AVAILABLE AT:
<https://www.archgrille.com/pages/quotes>

ARCHITECTURAL GRILLE
42 SECOND AVE
BROOKLYN, NY 11215
718-832-1200
FAX: 718-832-1390