

# *bella velio*



 EARLY RIDER

USER MANUAL



# HEY! THANK YOU...

Thanks for choosing an Early Rider. Our products are brought to you by a small team of life-long adventurers based in Henley-on-Thames, UK.

We love what we do and hope this shows in our Velio. If for any reason you're not happy, or if you have any questions, please drop us a line at [info@earlyrider.com](mailto:info@earlyrider.com)



So, you're ready for your first adventure. Why not tag us on Instagram and share it with the world?

[@earlyriderbikes](#) [#earlyrider](#)

Your Velio will require some assembly, this manual will guide you through the final assembly steps.

The instructions are intended to detail points that are vital for the safe and efficient running of your Velio and key adjustments to accommodate your child's development.

Please retain these instructions for future reference.

**PLEASE KEEP A RECORD OF YOUR VELIO SERIAL NUMBER ON PAGE 4 OF THIS MANUAL.** The serial number is on the underside of the frame and consists of letters and numbers. Please retain your sales receipt as proof of purchase. If you ever need to contact customer service, it's more than likely we will ask you for this information.

- 4 USER INFORMATION
- 6 WHAT'S IN THE BOX
- 7 UNBOXING THE VELIO
- 8 FITTING THE GRIPS
- 10 TILLER
- 12 ACTIVE BALANCE CONTROL (ABC) SYSTEM
- 14 SADDLE POSITIONS
- 15 SAFETY



### VELIO MODEL

### VELIO SERIAL NUMBER

### DATE OF PURCHASE

### NOTES



## WARNING

### STAYING SAFE ON YOUR VELIO

- This toy should be checked before every ride to ensure all bolts are securely fastened and the toy is in good working order.
- This toy requires protective equipment such as a safety helmet to be worn when in use.
- This toy should be used under the direct supervision of an adult.
- This toy should not be used in traffic at any time.
- This toy should not be used on public highways.
- This toy has no brake.
- This toy should only be used on flat level surfaces.
- Instructions to be given to the child in the proper use of the toy.
- A reminder that the toy should be used with caution since skill is required to avoid falls or collisions causing injury to the user or third parties.



**NOT SUITABLE FOR CHILDREN OVER 36 MONTHS. MAX WEIGHT 20KG / 44LBS  
ADULT ASSEMBLY REQUIRED**

### ASSEMBLING YOUR VELIO

- Please remove all packaging material before giving it to a child.
- The box contains plastic packaging which must be kept away from children.
- Please keep this packaging and the instructions for future use or return.
- Please keep all tools included for future use.
- This toy must be assembled by an adult in accordance with the instructions in the user manual before being given to a child to ride. In its unassembled state it contains potentially hazardous sharp edges or points and small parts, so please keep out of reach until fully assembled.

### LOOKING AFTER YOUR VELIO

- Wipe down with a damp cloth periodically and free any moving parts of dirt.
- Once clean store in a dry place. This toy should not be left outside.

## WARRANTY

Warranty coverage on your Velio extends for TWO YEARS from the date of purchase while owned by the original purchaser. For more information please visit our support page using the QR code opposite.



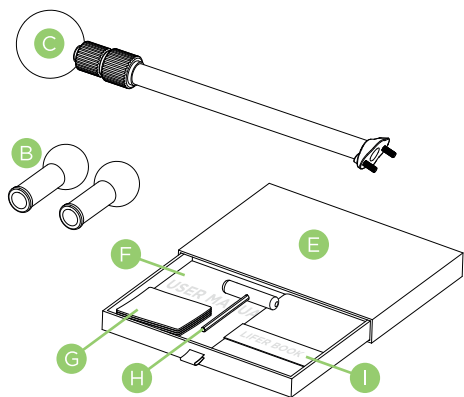
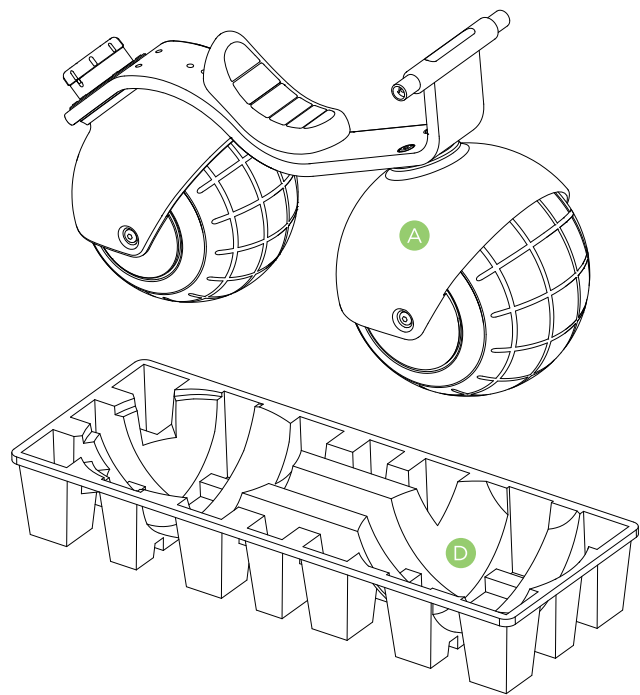

- A VELIO
- B GRIPS
- C TILLER
- D UNDER-TRAY / VELIO STAND
- E PARTS BOX
- F USER MANUAL
- G MICRO FIBRE CLEANING CLOTH
- H 4MM ALLEN KEY
- I LIFER BOOK

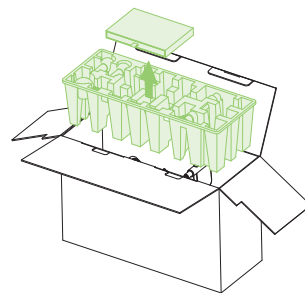

1 Open the box and remove the top tray and Velio parts kit.

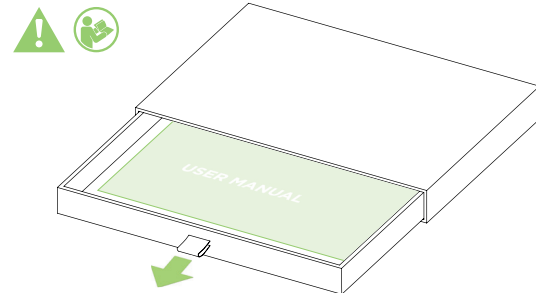

2 Read the assembly instructions.

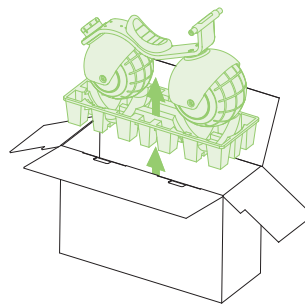

3 Remove the Velio from the box and lift out the under-tray.

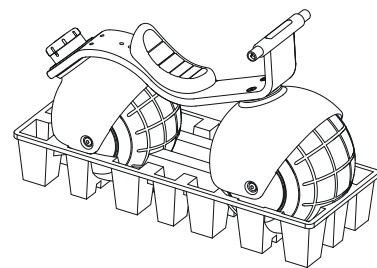

4 The under-tray is a Velio stand and can be used to hold the Velio during the fitting of the handlebar grips.



**WARNING: CAREFULLY FOLLOW THE INSTRUCTIONS FOR GRIP INSTALLATION, FAILURE TO DO SO COULD DAMAGE THE BAR END.**

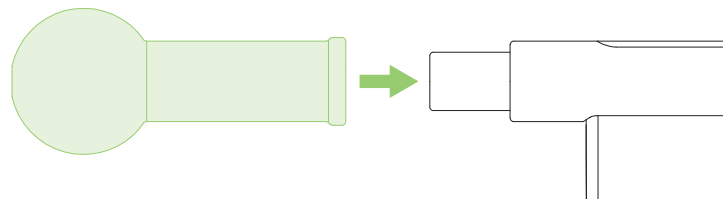

**1** Slide the grip onto the handlebar.

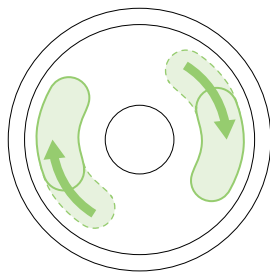

**2** Gently push whilst rotating the grip until you feel the grip locate.

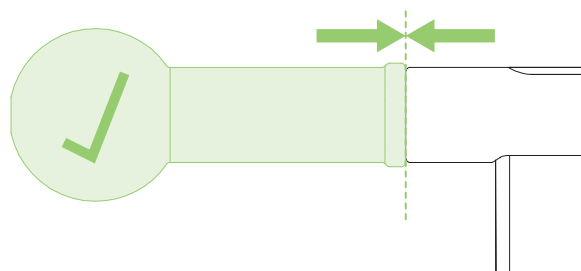
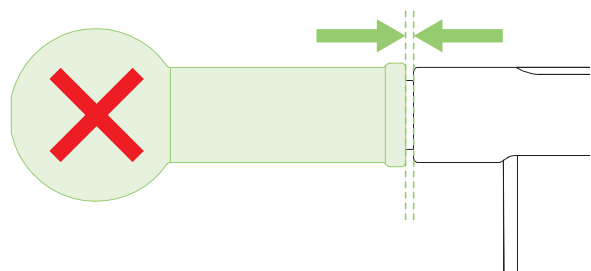

**3** There should be no gap between the grip and the frame, and you shouldn't be able to rotate the grip. If there is a gap, then rotate the grip whilst pushing gently until the gap is closed, and the grip can't turn.

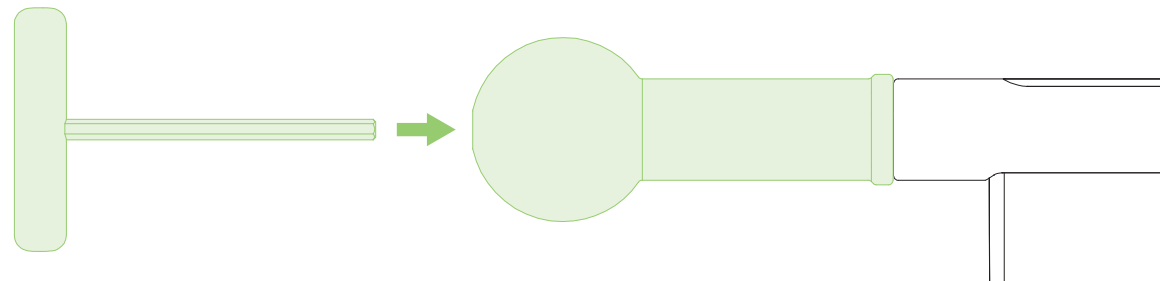

**4** Insert the allen key into the hole at the end of the grip.

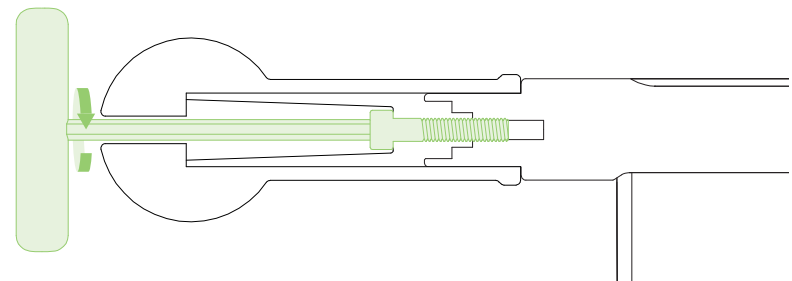

**5** Tighten the bolt by turning the allen key clockwise until the bolt is finger tight - this is between 2.5-3Nm. Do not over tighten as this may damage the grip.



## FITTING THE TILLER

10

The steering pole, or 'tiller', is key to getting the most from your Velio during the early stages of the rider's development. It allows you to provide extra support as your child builds confidence. Please use the QR code provided below for tips and advice on the tiller's best use.

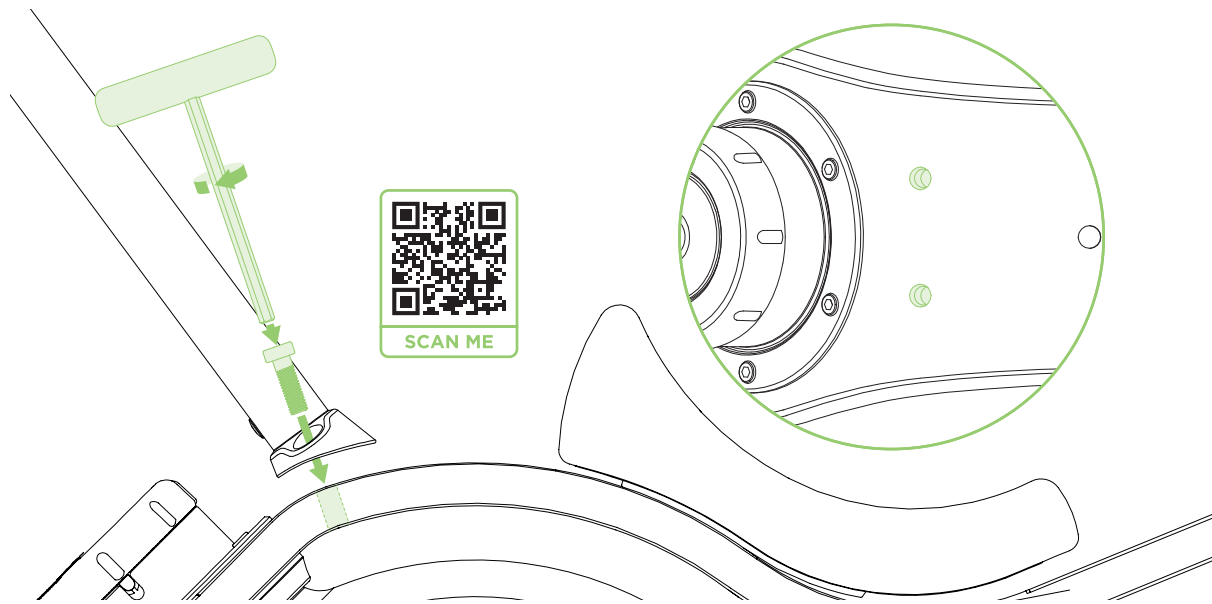

- 1 To attach, locate the tiller's end into the tiller mount on the frame. Using the 4mm allen key, secure the tiller to the frame with the bolts provided, tighten to 2.5-3nm.

## EXTENDING THE TILLER

11

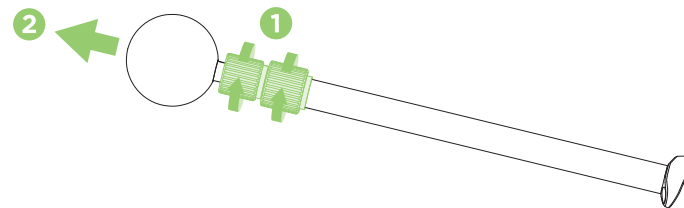

- 1 To extend the tiller, loosen the twist locks by turning them counter clockwise.
- 2 Pull the ball on the tiller to extend to your desired length.

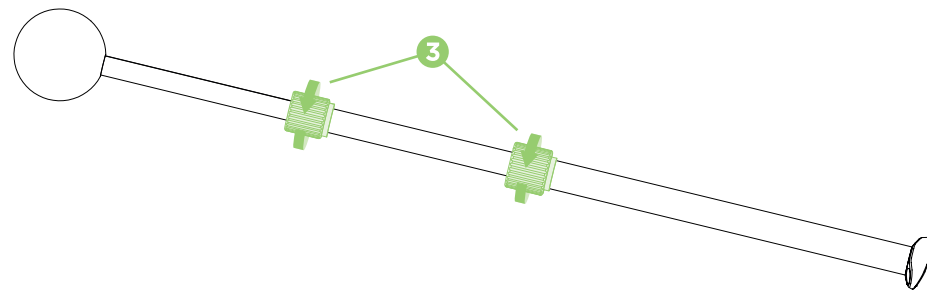

- 3 Tighten the twist locks by rotating them in a clockwise direction. Reverse these steps to shorten the tiller.



# ACTIVE BALANCE CONTROL (ABC) SYSTEM

Our patented ABC system is designed to simulate the steps we take to balance on a bike. When a rider loses balance it will automatically initiate a turn in the direction they are falling, giving them more support and more time to correct their balance. The rider is further helped to regain balance through a return-to-centre spring.

A novice rider will require the ABC system to be more responsive than an experienced rider. There is a selector dial that allows you to adjust the ABC system's compression according to your child's progress.

Please note, when using the tiller, we recommend using the minimum compression setting. For further guidance and advice on how to best use the ABC system, please visit our support page using the QR code opposite.

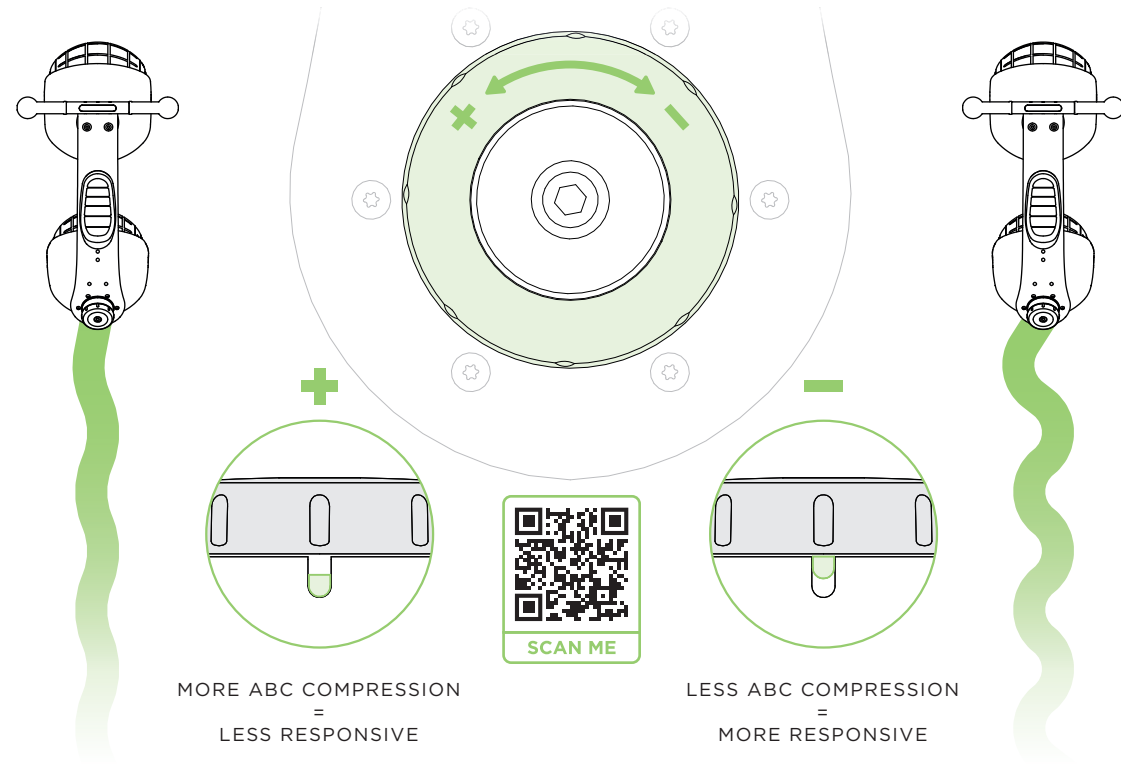
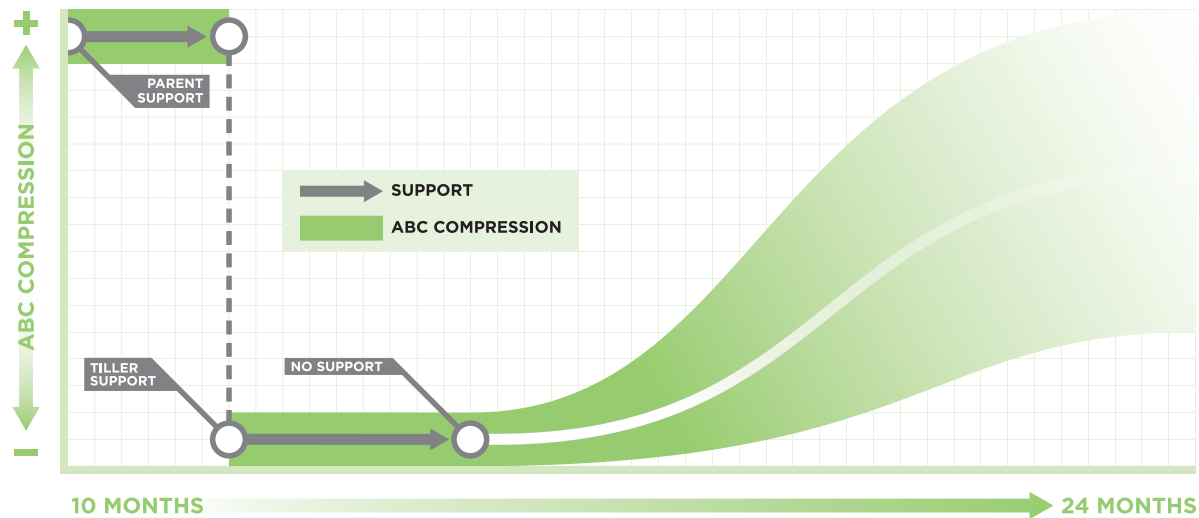



Gently lift the lip on the rear of the seat pad to remove. Once removed the seat bolts **A** will be accessible and you are able to position the seat as required. When you are happy with the position, replace the seat cover starting at the front, making sure it is securely fitted on all edges.

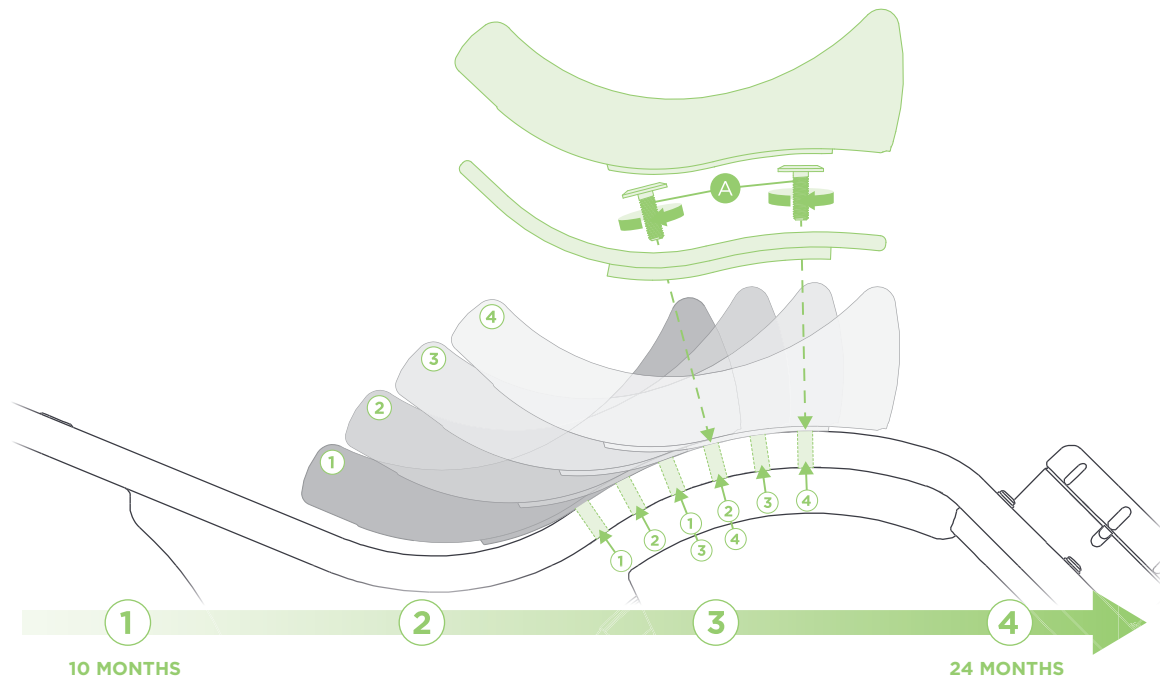

## PLEASE RIDE WITH CARE!

No matter how confident you or your child are, it's worth spending time in a safe indoor, open area, free from traffic, to get comfortable using the Velio.

Please also remember the Velio is designed to build confidence, as well as encourage adventure, and this is best safeguarded by making sure they are always wearing appropriate protective equipment, above all...

ALWAYS WEAR A  
HELMET!





**WWW.EARLYRIDER.COM**

**@EARLYRIDERBIKES**

**INFO@EARLYRIDER.COM**

**+44 (0) 118 996 0638**

**HENLEY•ON•THAMES, UK**

**© 2023 EARLY RIDER LIMITED**

All other trademarks are the  
property of their respective owners.

Specifications are subject to change without notice.