

# NOMA<sup>®</sup> MD

## FLUSH MOUNT LED LIGHT

model no. 052-1424-2

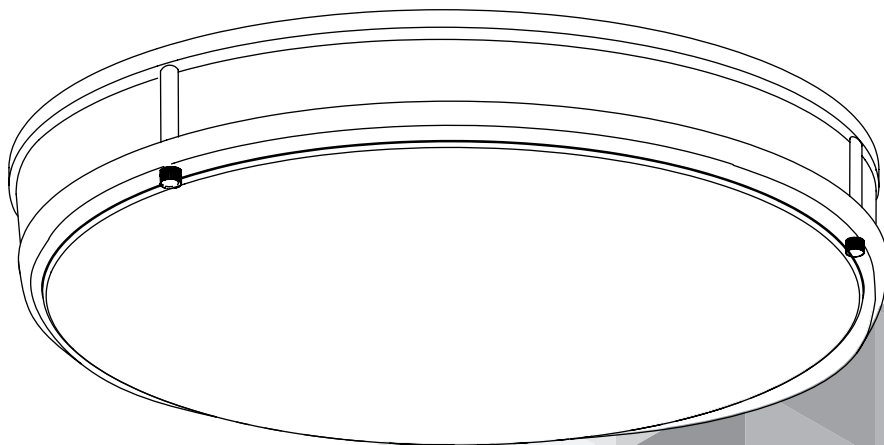

**Toll-free: 1-866-827-4985**

**IMPORTANT:** Please read this manual carefully  
before installing this LED light and save it for reference

**Instruction Manual**

model no. 052-1424-2 | contact us: 1.866.827.4985

Suggested Dimmers	2
Specifications	3
Parts List	3
Installation	4
Cleaning And Maintenance	5
Safety	6
FCC / ICES Information	7
Warranty	7

1. Below is a list of dimmers that have been tested with this fixture.
2. This list of dimmers do not imply any guarantee or warranty of compatibility with a particular application.
3. Dimmers that are not listed do not imply non-compatibility.

Lutron	DVCL-153P
Lutron	TGCL-153P
Lutron	CTCL-153P
Lutron	PD-6WCL
Leviton	6672
Leviton	6674

# NOMA<sup>®</sup> MD

Model	052-1424-2
Item	SP6070
Voltage	120 V AC
Frequency	60Hz
Watt	24 w
Brightness	1450 Lumens
Net Weight	2 LB 8 1/2 oz (1.15 kg)
Dimension (Diameter x Height)	14 x 4" (35.5 x 10.3 cm)

Specifications

- A. Fixture Pan
- B. Light Shade
- DD. Mounting Screw
- EE. Wire Connector

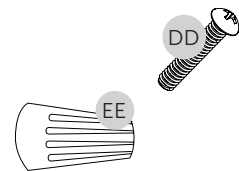
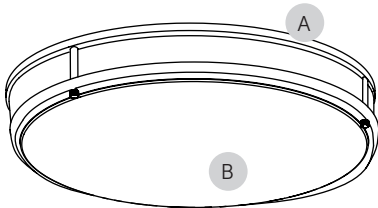

Parts List

1. Thread the mounting screws into the outlet box.

Do not tighten.

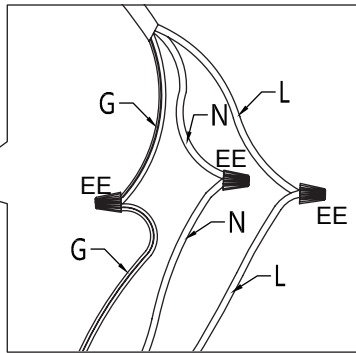
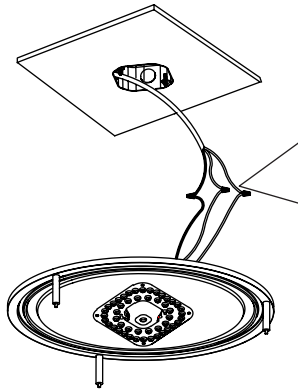
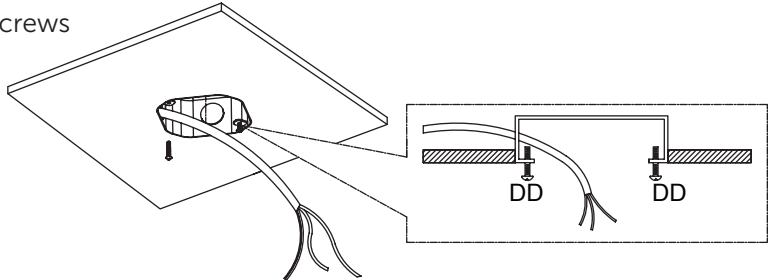

2. Connect white wire(s) from the fixture to the white (neutral) wire of the supply circuit. And screw on a wire connector.
3. Connect the black wire(s) from the fixture to the black (live) wire of the supply circuit. And screw on a wire connector.
4. Connect the green wire(s) from the fixture to the ground wire and screw on a wire connector.

5. Carefully tuck all the wires and wire connections into the outlet box. Place the fixture pan over the outlet box and onto the mounting screws, making sure they feed through the keyhole slots.
6. Twist the fixture pan so that the mounting screws slide into the narrow ends of the keyhole slots. Tighten the mounting screws so that the fixture pan is secured flush with the ceiling.

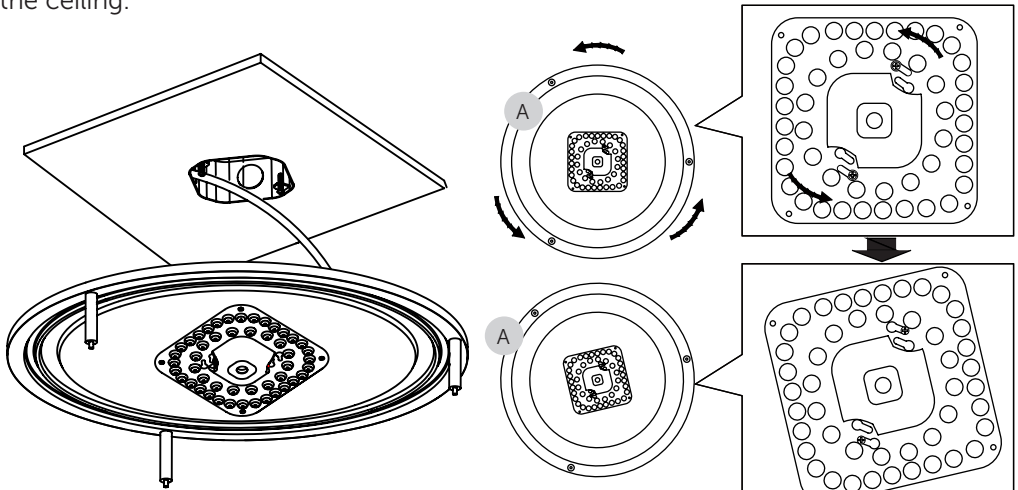

7. Add the light shade (B) to the fixture pan. Add top ring over light shade and use the 3 hold-down nuts (included with light shade) to secure ring.

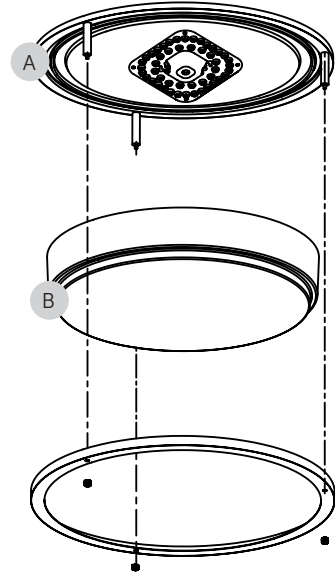

Shut off main power supply before wiping product with damp cloth or window cleaner. Do not use abrasives.

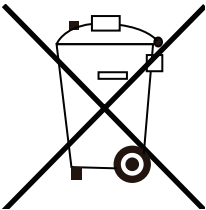

### ENVIRONMENTAL PROTECTION

Electrical products must be discarded in an environmentally friendly area.

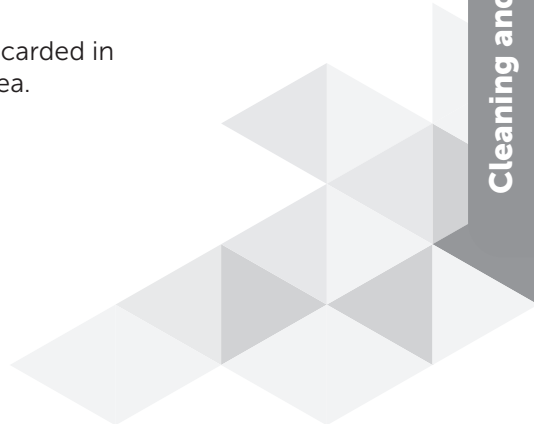

**GENERAL**

1. To ensure the success of the installation, be sure to read these instructions and review the diagrams thoroughly before beginning.
2. All electrical connections must be in accordance with local codes, ordinances, or the National Electrical Code.
3. Before starting installation, disconnect the power by turning Off the circuit breaker or by removing the fuse at the fuse box. Turning the power off using the light switch is not sufficient to prevent electrical shock.
4. This lamp is for 120VAC 60Hz.

**CAUTION:** Before assembling your lighting fixture, refer to the section below titled **ELECTRICAL CONNECTIONS**. If you feel you do not have enough electrical wiring experience, refer to a do-it-yourself wiring handbook or have your fixture installed by a qualified licensed electrician.

**DANGER!**

**Warning:** Risk of injury due to electric shock! Installation may be carried out only by a suitably qualified electrical specialist. Before installation, it must be ensured that there is no current to the electrical network.

**ELECTRICAL CONNECTIONS**

1. Connect white wire(s) from the fixture to the white (neutral) wire of the supply circuit and screw on a wire connector.
2. Connect the black wire(s) from the fixture to the black (live) wire of the supply and screw on a wire connector.
3. Connect green wire(s) from the fixture to the Ground wire and screw on a wire connector.

**READ AND SAVE THESE INSTRUCTIONS!****WARNING: RISK OF ELECTRIC SHOCK**

These servicing instructions are for use by qualified personnel only. To reduce the risk of electric shock, do not perform any servicing other than that contained in the operating instructions unless you are qualified to do so.

This equipment has been tested and found to comply with the limits for Class B digital devices, pursuant to Part 15 of the FCC rules. These limits are designed to provide reasonable protection against harmful interference in a residential installation. The equipment generates, uses and can radiate radio frequency energy and, if not installed and used in accordance with the instructions, may cause harmful interference to radio or television reception, which can be determined by turning the equipment off and on. The user is encouraged to try and correct the interference by one or more of the following measures:

- Reorient or relocate the receiving antenna.
- Increase the separation between the equipment and the receiver.
- Connect the equipment into an outlet on a circuit different from that to which the receiver is connected.
- Consult the dealer or an experienced radio/TV technician for help.

This device complies with Part 15 of the FCC rules. Operation is subject to the following two conditions:

1. This device may not cause harmful interference, and
2. This device must accept any interference received, including interference that may cause undesired operation.

Modifications not approved by the party responsible for compliance could void user's authority to operate the equipment.

CAN ICES-005 (B) / NMB-005 (B)

---

This Noma<sup>®</sup> product carries a five (5) year repair warranty against defects in workmanship and materials. At its discretion, Noma Canada agrees to have any defective part(s) repaired or replaced free of charge within the stated warranty period, when returned with proof of purchase. This product is not guaranteed against wear or breakage due to misuse and/or abuse.

Made in China

Imported by  
Noma Canada  
Toronto, Canada M4S 2B8

