

19. Insert the Ignitor II black and red wires into the opening in the distributor housing. Verify the grommet is seated properly.
20. Remove the excess wire from inside the distributor housing by gently pulling the wire through the grommet. Check to insure that the wire does not interfere with any moving parts.
21. Install the distributor cap. Check to insure that all spark plug wires are seated securely in the distributor cap.

### WIRING INSTRUCTIONS

1. The Ignitor II ignition can be used in conjunction with most ignition coils rated at 0.6 ohms or greater. For optimum performance purchase and install the Flame-Thrower II high performance coil. Attach the black Ignitor II wire to the negative coil terminal. Attach the red Ignitor II wire to the positive coil terminal. (See Figure 1)
- A. **Recommended:** Many vehicles came equipped with ballast resistors or resistance wires. To achieve optimum performance from the Ignitor II ignition system, we recommended removal of these components.
  1. To remove a ballast resistor, (normally white ceramic blocks 3 to 4" inches long), disconnect all wires on both ends of the ballast resistor. Remove the resistor from the vehicle and splice the disconnected wires together at a single point.
  2. To remove a resistance wire, trace the coil power wire, which was previously connected to the positive coil terminal, back to the fuse block. Bypass this wire with a 12-gauge copper stranded wire.
- B. **Alternative:** The Ignitor II can also be installed in applications retaining the ballast resistor or resistance wire. (See Figure 2)
1. Attach the Ignitor II black wire to the negative coil terminal. Attach the Ignitor II red wire to the ignition side of the resistance, or any other 12 volt ignition power source.
3. Check to insure that the polarity is correct, and that all connections are tight.
4. Re-connect the battery.
5. Start the engine and allow it to reach normal operating temperature. Check the timing, and adjust to the desired setting.

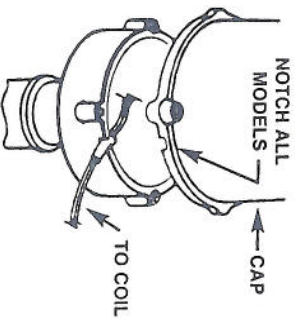

FIGURE A

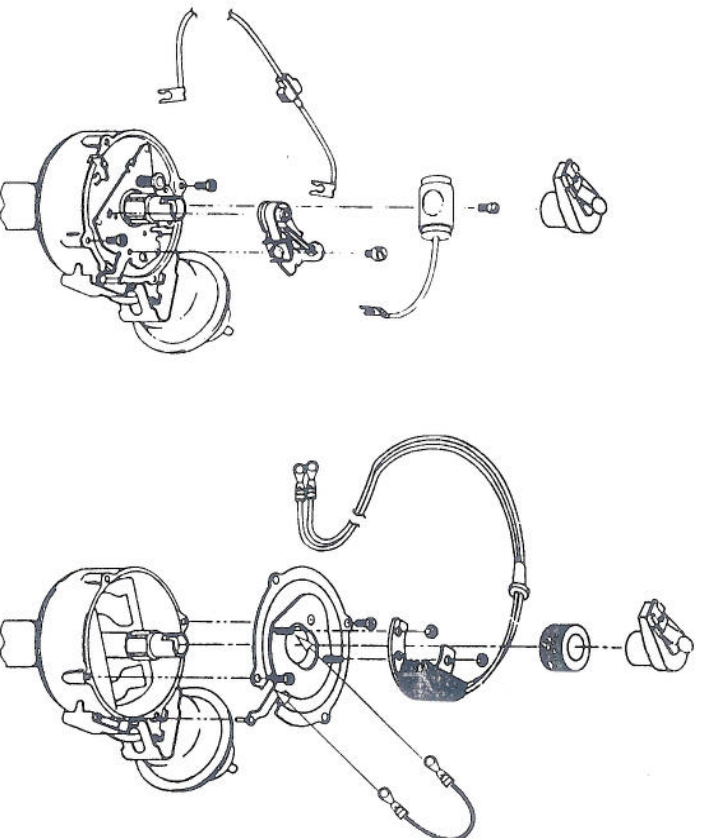

FIGURE 1

**ATTENTION O.M.C. BOAT OWNERS....** If your boat is equipped with a shift interrupter you will need to install the following "FIX" to insure proper operation of the unit.

### O.M.C. SHIFT INTERRUPTER FIX.

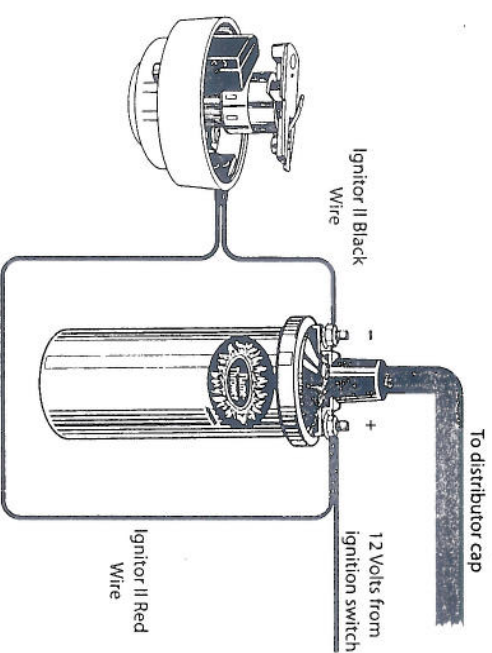
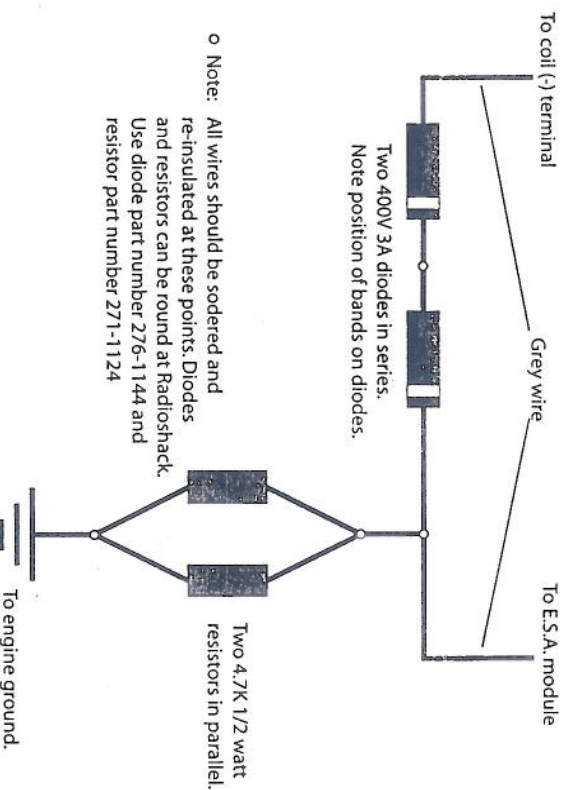
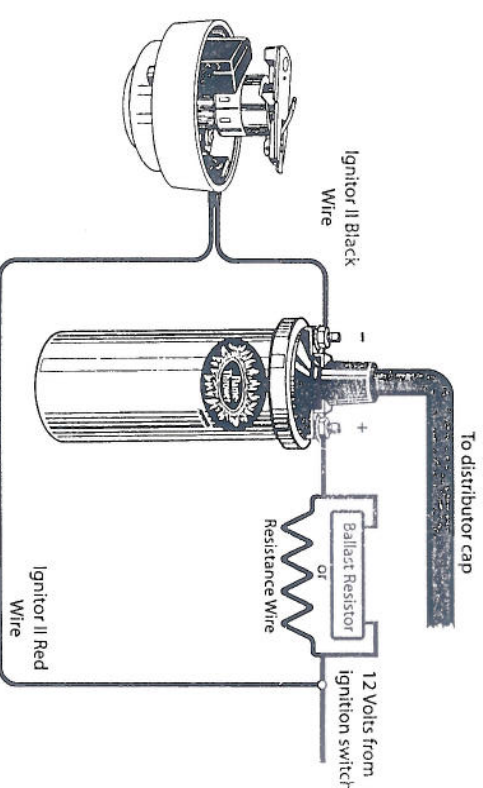

FIGURE 2





## COMMON QUESTIONS AND ANSWERS

- Q. The engine will not start or runs rough. What is the problem?**  
**A.** Check all connections to insure that they are tight, and in the proper location. Check all grounds; if a distributor ground wire was removed make sure that it was reattached properly. Make sure that the red Ignitor II wire is supplied with a full 12 volts. The Ignitor II is designed to sense high current levels, and shut off before damage occurs. Check all wires for shorts, correct polarity and that the ignition coil's primary resistance level is acceptable.
- Q. The vehicle will start, but then die. After waiting it will start again. What is wrong?**  
**A.** The Ignitor II may have a "Low Voltage Problem." If the voltage supplied to the red Ignitor II wire is insufficient, the system may run for a period of time, and then shut down as the voltage drops due to engine heat. The period may vary from minutes to hours depending on available voltage and wiring condition. To remedy this condition refer to steps 2-4 of the wiring instructions.
- Q. How do I check for a "Low Voltage Problem" or determine if I am getting adequate voltage?**  
**A.** To quickly test for a "Low Voltage Problem" or for adequate voltage, remove the Ignitor II red wire from the coil positive terminal. Attach a jumper wire from the battery positive terminal to the Ignitor II red wire. Try to start the vehicle. If the vehicle starts with this test refer to steps 2-4 of the wiring instructions for further information.
- Q. How do I check my coil for primary resistance?**  
**A.** Remove all wires from the coil. Set the ohmmeter to the lowest scale. Attach one lead of the meter to the positive coil terminal. Attach the other lead to the negative coil terminal. The Ignitor II is compatible with coils having a resistance of 0.6 ohms or greater.
- Q. May I modify the length of the wires?**  
**A.** Yes, you may cut the wires to any length your application requires. You may also add lengths of wire if needed (20-gauge). Make sure that all wire splices are clean and the connections are tight.
- Q. Will the Ignitor II work with aftermarket capacitive discharge boxes?**  
**A.** Yes, the Ignitor II is compatible with most CD boxes in the same respect as points. Use the CD box wiring instructions for point systems and treat the Ignitor II black wire as a point wire. The Ignitor II red wire should be attached to the 12-volt power source.
- Q. Will the electronic shift assist in an OMC boat work with the Ignitor II?**  
**A.** The Ignitor II will work with all OMC sterndrive applications, when our "diode fix" is used. If you've purchased a kit that didn't include the "diode fix" diagram, call our tech line.
- Q. How can I receive additional help?**  
**A.** Check our web site for current trouble shooting tips and up to date technical information. Log on to [www.petronix.com](http://www.petronix.com). You may also contact our tech line at: (800-827-3756)

**WARNING... DO NOT USE SOLID CORE SPARK PLUG WIRES WITH THE IGNITOR II IGNITION SYSTEM.**

**PETRONIX** PERFORMANCE PRODUCTS  
 440 E. ARROW HIGHWAY, SAN-DIMAS, CA 91773  
[www.petronix.com](http://www.petronix.com)

## LIMITED WARRANTY

Petronix, Inc. warrants to the original Purchaser of its solid-state ignition system that the product shall be free from defects in material and workmanship for a period of (30) months from the date of purchase.

If within the period of the foregoing warranty Petronix finds, after inspection, that the product or any component thereof is defective, Petronix will, at its option, repair such products or component or replace them with identical or similar parts PROVIDED that within such period Purchaser:

1. Promptly notifies Petronix, in writing, of such defects.
2. Delivers the defective products product or component to Petronix (Attn: Warranty) with proof of purchase date; and
3. Has installed and used the product in a normal and proper manner, consistent with Petronix printed instructions

THE FOREGOING LIMITED WARRANTY IS EXCLUSIVE AND IN LIEU OF ALL OTHER WARRANTIES, WHETHER EXPRESS OR IMPLIED, INCLUDING ANY IMPLIED WARRANTY OR MERCHANTABILITY OR FITNESS FOR A PARTICULAR PURPOSE.

THE FURNISHING OF A REPAIR OR REPLACEMENT COMPONENT OR COMPONENTS SHALL CONSTITUTE THE SOLE REMEDY OF PURCHASER AND THE SOLE LIABILITY OF Petronix WHETHER ON WARRANTY, CONTRACT OR FOR NEGLIGENCE, AND IN NO EVENT WILL Petronix BE LIABLE FOR MONEY DAMAGES WHETHER DIRECT OR CONSEQUENTIAL.

## Complete your ignition upgrade with a high performance coil!

### The 45,000 volt Flame-Thrower® II High Performance Coil. IT'S HOT!

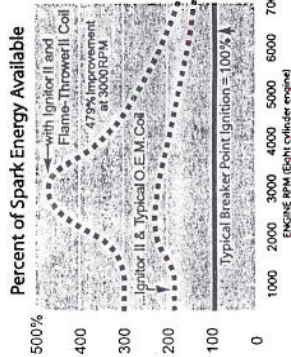
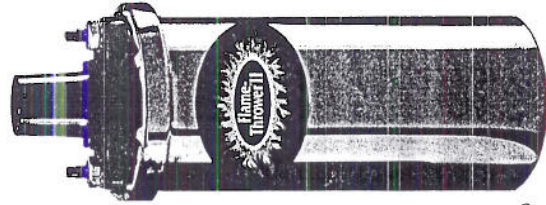

An illustration of the spark energy available with Ignitor II compared to points and how the Ignitor II improves performance with the OEM coil.

Available in  
 Oil filled chrome  
 or stock black.

Epoxy version  
 available for  
 racing applications

- Maximizes energy and reliability over the full RPM range
- Enables larger plug gaps for greater fuel efficiency, more power
- Delivers more spark energy and voltage
- CARB E.O. #D-57-10, legal in all 50 states and Canada
- Fits existing brackets
- Made in the USA

# Ignitor II<sup>®</sup>

## ELECTRONIC IGNITION

INSTALLATION INSTRUCTIONS FOR  
 PART NUMBERS 91144A & 91162A

READ ALL INSTRUCTIONS  
 BEFORE BEGINNING INSTALLATION

1. Turn the ignition switch off and disconnect the battery negative (-) cable.
2. Remove the distributor cap and rotor. Do not disconnect the spark plug wires from the cap.
3. Examine the distributor cap and rotor for excessive wear or damage. Replace as needed.
4. Disconnect the points wire from the negative (-) terminal of the coil.
5. Remove the screws retaining the breaker plate, and lift out the entire breaker plate. The Ignitor II does not require any modification to distributor. Therefore retain all parts and hardware for backup.
6. Clean all dirt and excess oil from the distributor and point cam.
7. Set the Ignitor II adapter plate into the distributor housing.
8. Place the provided ground wire on one of the adapter plate screws.
9. Confirm that the Ignitor plate is flat and fits without any modification.
10. Fasten the plate into place using the original screws.
11. Install the module over the studs and down onto the adapter plate.
12. Place the loose end of the ground wire over one of the studs.
13. Use the provided lock nuts to hold module, and ground wire in place. Do not tighten the nuts all the way at this time.
14. Install magnet sleeve over distributor shaft, onto point cam. Rotate the sleeve until a slight locating position is felt before applying pressure. With sleeve lined up on point cam, press down firmly insuring sleeve is fully seated.
15. Using the plastic feeler gauge provided, adjust the air gap between the module and the magnet sleeve. The gap should be approximately 0.030".
16. Secure the module by tightening the two lock nuts.
17. Rotate the distributor shaft through a complete revolution. Verify that the magnet sleeve does not rub the module.
18. It is necessary to file a slot in the distributor cap to allow for the larger grommet. Using the indentation on the rim of the cap as a guide, file away enough material so that the grommet will not be pinched when the cap is installed. A 3/16" deep by 1/4" wide slot is sufficient. (See Figure A) IT IS IMPERATIVE THAT THIS SLOT BE FILED INTO THE CAP. FAILURE TO DO SO COULD RESULT IN AN ELECTRICAL SHORT.