



## LIMITED WARRANTY

PerTronix, Inc. warrants to the original Purchaser of its solid-state ignition system (product) that the Ignitor shall be free from defects in material and workmanship for a period of (30) months from the date of purchase.

If within the period of the foregoing warranty PerTronix finds, after inspection, that the product or any component thereof is defective, PerTronix will, at its option, repair such products or component or replace them with identical or similar parts PROVIDED that within such period Purchaser:

1. Promptly notifies PerTronix, in writing, of such defects.
2. Delivers the defective products product or component to PerTronix (Attn: Warranty) with proof of purchase date; and
3. Has installed and used the product in a normal and proper manner, consistent with PerTronix printed instructions

THE FOREGOING LIMITED WARRANTY IS EXCLUSIVE AND IN LIEU OF ALL OTHER WARRANTIES, WHETHER EXPRESS OR IMPLIED, INCLUDING ANY IMPLIED WARRANTY OR MERCHANTABILITY OR FITNESS FOR A PARTICULAR PURPOSE.

THE FURNISHING OF A REPAIR OR REPLACEMENT COMPONENTS SHALL CONSTITUTE THE SOLE REMEDY OF PURCHASER AND THE SOLE LIABILITY OF PerTronix WHETHER ON WARRANTY, CONTRACT OR FOR NEGLIGENCE, AND IN NO EVENT WILL PerTronix BE LIABLE FOR MONEY DAMAGES WHETHER DIRECT OR CONSEQUENTIAL.



440 East Arrow Highway  
San Dimas, California 91773  
(909) 599-5955



## INSTALLATION INSTRUCTIONS FOR 6 VOLT NEGATIVE GROUND APPLICATIONS



Read all instructions before attempting to install...

- For 6-volt negative ground systems.
- Compatible with "points style" coils.
- Do not use "HEI" type coils.

1. Turn the ignition switch off or disconnect the battery.
2. Remove the distributor cap and rotor. Do not disconnect the spark plug wires.
3. Examine the cap and rotor for wear or damage. Replace as needed.
4. Remove the points, condenser, and grommet.
5. The Ignitor does not require any modification to the distributor. Therefore the points, condenser and hardware can be used as backup.
6. Clean any oil or dirt from the breaker plate and point cam.
7. Install the Ignitor plate onto the breaker plate, and fasten Ignitor plate in place.
8. If the distributor ground wire was removed during the installation process, be sure to re-attach it securely.
9. Install the magnet sleeve over distributor shaft and onto the point cam. Rotate sleeve until a slight locating position is felt before applying pressure. With sleeve lined up on point cam, press down firmly insuring the sleeve is fully seated.
10. Insert both wires through the hole in the distributor housing. Pull the grommet into place. Make sure that the wires do not interfere with any moving parts.
11. Replace the rotor and distributor cap. Make sure that all spark plug wires are attached securely.
12. Connect the Ignitor black wire to the negative (-) side of the ignition coil.
13. Connect the Ignitor red wire to the positive (+) side of the ignition coil.
14. Reconnect the battery and make sure all wires are connected correctly.
15. The engine can now be started. Let the engine run for a few minutes and then set the timing in the conventional manner.

FIGURE 1  
WIRING DIAGRAM  
CONVENTIONAL POINTS SYSTEM  
WITH BALLAST RESISTOR

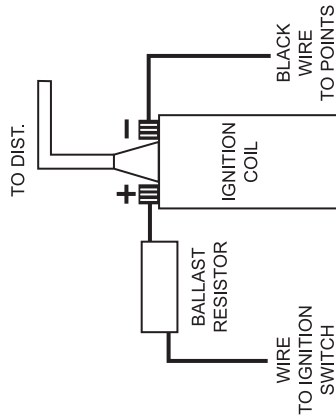

FIGURE 2  
WIRING DIAGRAM  
IGNITOR SYSTEM  
WITHOUT BALLAST RESISTOR

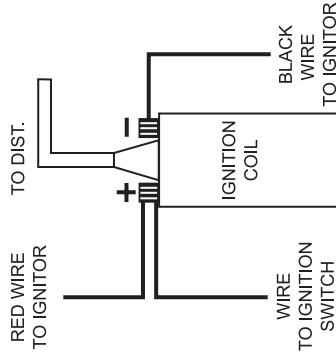
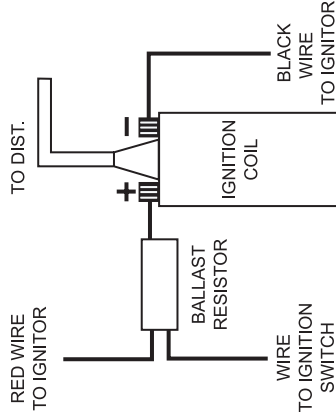

FIGURE 3  
WIRING DIAGRAM  
IGNITOR SYSTEM  
WITH BALLAST RESISTOR



**NOTE:**

A RESISTOR WIRE OR BALLAST RESISTOR MAY OR MAY NOT BE INCLUDED IN THE ORIGINAL EQUIPMENT.

## Ignitor™ COMMON QUESTIONS AND ANSWERS

**Q. What is the first thing I should check if the engine would not start?**

A. Make certain all wires are connected securely to the proper terminals.

**Q. The engine will not start or runs rough. Are there any tests that I can do?**

A. Yes, remove the red Ignitor™ wire from the coil positive terminal. Connect a jumper wire from the positive side of the battery directly to the red Ignitor™ wire. If the engine starts and runs well, you may have a low voltage problem. Remember this is just a test and not intended for permanent installation. Read " How to correct a low voltage problem"

**Q. How to correct a low voltage problem?**

A. First, if you have an external ballast resistor, connect the red Ignitor™ wire to the ignition wire prior to the ballast resistor. Second, if you do not have a ballast resistor you must locate a 6-volt source that is controlled by the ignition switch to connect the red Ignitor™ wire to.

**Q. What type of coil can I use?**

A. The Ignitor™ is compatible only with a "points style" coil.

**Q. What happens if I leave the ignition switch on when the engine is not running?**

A. This can cause you coil to overheat, which may cause permanent damage to the coil and the Ignitor™.

**Q. May I modify the length of the Ignitor™ wires?**

A. Yes, you may cut the wires to any length your application may require. You may also add lengths of wire if needed (20-gauge wire). Please make sure all wire splice are clean and connections are secure.

**Q. Will the shift interrupter on an OMC stern drive boat work with the Ignitor™?**

A. The Ignitor is compatible with all OMC stern drive applications, when equipped with a "diode fix". If you purchased a kit that does not include the "diode fix" diagram, call our tech line.

**Q. How can I get additional help?**

A. Call our tech line (800-827-3758) for any further instructions or questions. You may also logon to [www.pertronix.com](http://www.pertronix.com) for the latest technical information.