

6 DEALER MANUAL FOR H400B (RM G020.250/350.D)



CONTENT

6.1 Introduction	2	6.3 Drive Unit Installation	4
6.2 Specifications	3	6.3.1 List of Tools to be used.....	4
6.2.1 Outline and geometric size.....	3	6.3.2 Motor Installation.....	4
6.2.2 Surface.....	3	6.4 Maintenance	6
6.2.3 Storage Information.....	3		

6.1 INTRODUCTION



- **Product Model**

RM G020.250.D

RM G020.350.D

- **Scope**



Applies only to electrically powered pedelecs developed or licensed by Bafang. It is suitable for city and trekking bikes, which have been developed for road use. The engine is not suitable for sport competitions.

- **Identification**

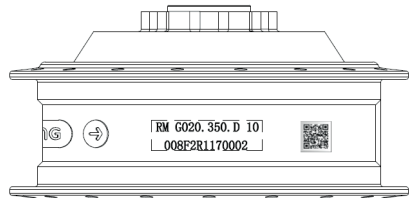

The following graphic, is the identification numbers of the product, which are shown on the housing:



Note: Content in the label is important information about this product. Please do not remove the information from the motor.

6.3 DRIVE UNIT INSTALLATION

6.3.1 List of Tools to be used

Use of the Tools	Tools
To tighten/loosen the M5*8 screws onto the disk brake.	 Internal hex wrench
To tighten/loosen the M12 flange nuts onto the frame.	 Open-end wrench

6.3.2 Motor Installation

1. First place the disc brake on to the motor and tighten with six M5*8 screws.
3. Insert the stop pin into on the shaft.

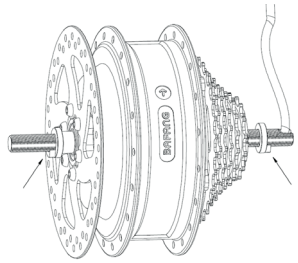
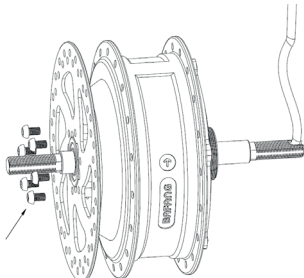

2. Fasten the cassette on the housing.

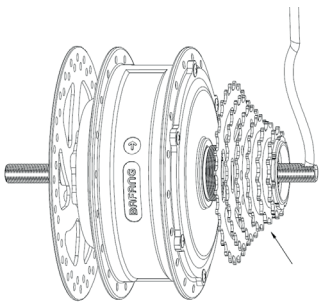

4. Insert the motor into the frame.

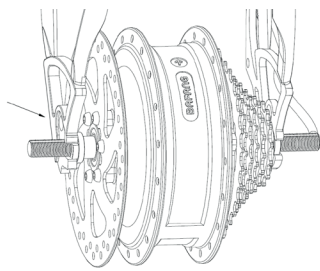

5. Mount the 4mm washer on both sides of the frame.

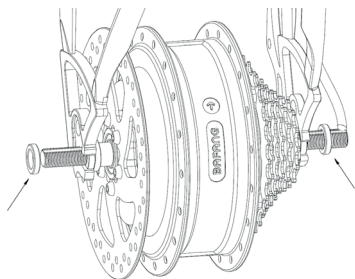

7. Mount the shaft end sheath on both sides of the shaft ends.

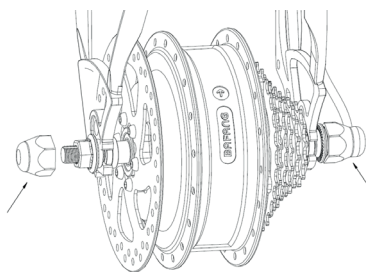

6. Tighten clockwise M12 flange nuts with open spanner at both sides of the motor. (torque requirement: 47-60N.m.)

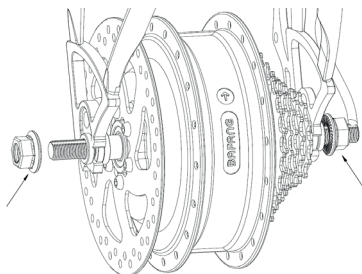

6.4 MAINTENANCE

- Maintenance must be carried out by authorized personnel with the correct equipment.
- Do not disassemble the motor.
- Do not use thinners or other solvents to clean the components. Such substances can damage the surfaces.
- Avoid water submerging, to keep the components protected.
- Avoid using high-pressure cleaning jets.
- For prolonged storage, turn off the battery and avoid storing near heat sources.