

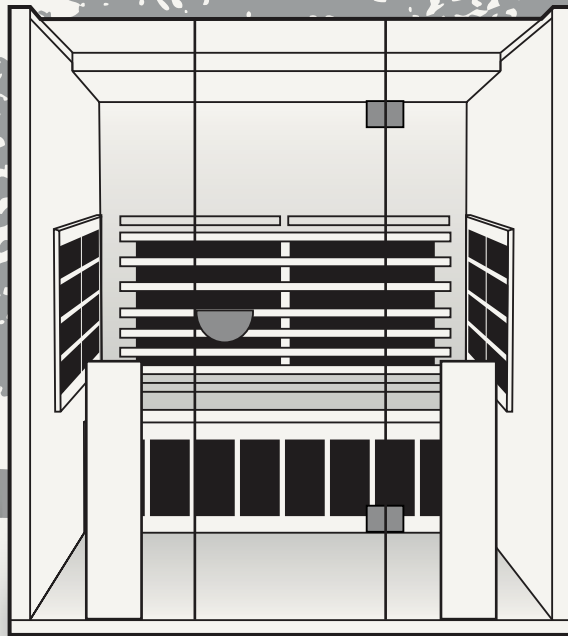

Clearlight
INFRARED™ by Sauna Works

OWNER'S MANUAL



CLEARLIGHT SANCTUARY FULL SPECTRUM SAUNAS

Superior Quality and Service

Congratulations on your purchase of a Clearlight Infrared Sauna™.
We are confident that you will enjoy the many benefits of your sauna for years to come.

Please read this manual before using your Sauna for the first time.
Please keep this manual for future reference.

Table of Contents

Installation 04

01 | SANCTUARY 1 05

02 | SANCTUARY 2 19

03 | SANCTUARY 3 33

04 | SANCTUARY Y 47

05 | SANCTUARY C 65

Enjoying Your Sauna 80

Using Your Sauna Control Panel 81

Tips for Use 85

Safety Instructions 87

Important Safeguards 89

Warranty 91

Why Detoxify 97

* The information contained in this manual is subject to change without notice.

Installation

Choosing a location

Place your sauna on a dry and level surface for best results. Garage, basement, attic, playroom, bedroom, or garden house are just a few of the possible locations for your sauna.

Your sauna's natural cedar or basswood exterior will beautifully compliment any location.

Outside, place the sauna on a deck or concrete pavers, available at your local building supply store, to protect it from moisture in the ground which can wick up through the wooden feet. Outside installation also requires our optional canvas cover.

Installation requirements for your sauna are as follows:

1. Your Clearlight® sauna is a self-contained and freestanding unit. It should not be built into any structure without prior authorization.
2. Please maintain a minimum of 4-inch clearance on all sides of the unit to allow air to circulate while giving access for the power cord..

Cleaning and maintenance

1. Before using your sauna for the first time, clean the inside of the sauna with a damp cloth. Use your favorite furniture polish on the exterior.
2. Place a towel on the floor and bench to absorb any perspiration. Wash these often to maintain a clean and pleasant environment inside your sauna.
3. Perspiration may darken the wood over time. This can be removed by a light sanding with fine grit sandpaper.



Please be careful when carrying and installing the glass pieces to avoid breakage. Make certain the glass is securely fastened during installation before letting go of any individual piece that could break.



01

SANCTUARY 1

Packaging	-----	06
Assembly Instructions	-----	07

Packaging

CONTENTS OF BOXES

Box 1 of 4

1. Floor Panel
2. Ceiling Panel
3. Accessories
4. Installation Manual

Box 2 of 4

1. Left Side Wall
2. Right Side Wall

Box 3 of 4

1. Front Wall Glass
2. Back Wall
3. Bench & Bench Support

Box 4 of 4

1. Front Heaters

ACCESSORY BOX CONTENTS

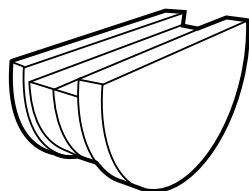

Door Handle

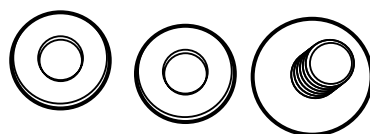

Front Heater
Mounting Screws
(4 sets)

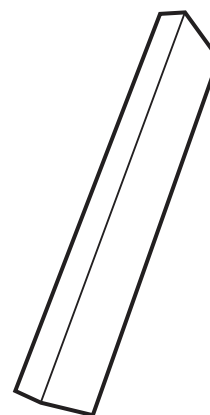

Wood piece
(2 pieces)

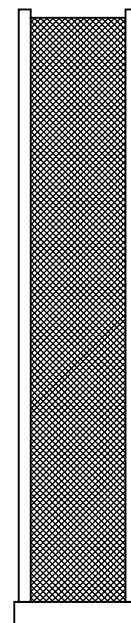

Full Spectrum
Heater Guard (2 pieces)

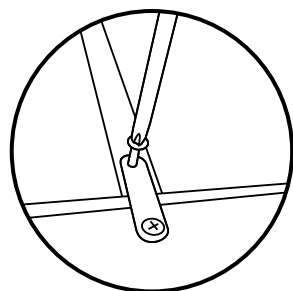

Wall Security
Bracket (4 pieces)

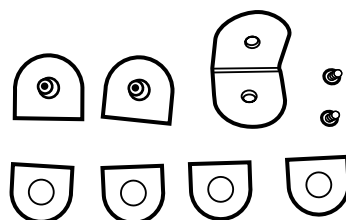

Glass Security
Brackets (2 sets)

Assembly Instructions

Assembly of the sauna requires two adults to complete. Please read the instructions thoroughly before and during assembly to ensure proper installation of the unit. If you encounter any problems or have questions during assembly, please feel free to call our Customer Service department at 1-800-798-1779 or +1-510-601-1775.

1 - LOCATION OF SAUNA & INSTALLATION ORDER

When determining a location for your sauna, please keep in mind the following:

1. The main power cord on the sauna must be easily accessible.
2. The location must be dry and level.
3. Panels should be installed in the following order:
 - 1) Floor
 - 2) Back Wall
 - 3) Left Side Wall
 - 4) Right Side Wall
 - 5) Under Bench Support
 - 6) Bench
 - 7) Wood Roof
 - 8) Glass Roof
 - 9) Front Wall Glass

2 - PLACING FLOOR PANEL

1. Place the bottom floor panel on the ground near the location you will using the sauna. Make sure the front of the floor is in the desired location of the door. The two floor receptacles and the door magnet indicate the front of the sauna.

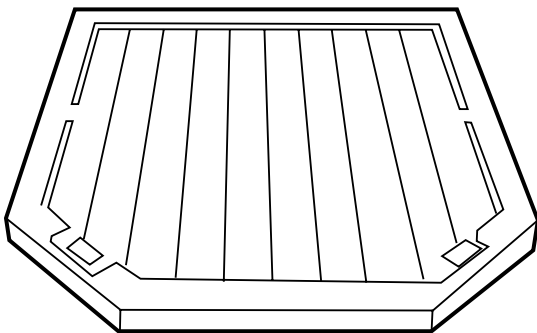

3 - CONNECTING THE BACK PANEL TO THE FLOOR PANEL

1. Place the back panel on the floor panel by placing it in the groove of the floor panel.

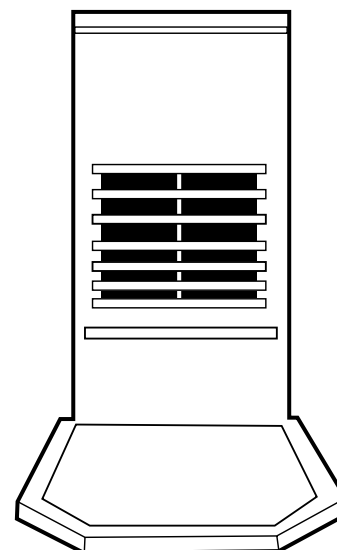

Assembly Instructions Cont'd

4 - CONNECTING SIDE WALLS

The side wall panels connect to the back wall with the installed locking brackets. There are mating brackets on the side of each panel.

1. Place the left side wall in the slot in the floor. Lift the side wall up about 4" (10cm) higher than the backwall panel (See Picture 1).
2. Place the side wall panel against the back wall (See Picture 2), then slide down side wall panel until the two panels are equal height. (See Picture 3).
3. If the panels are not equal height or there is an obvious gap between the two panels, this means they are not properly attached and you should try again.
4. Repeat the steps above for the right side wall panel.

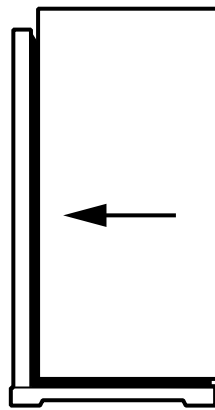

Picture 1

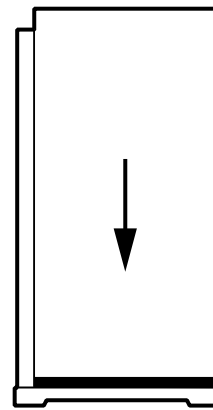

Picture 2

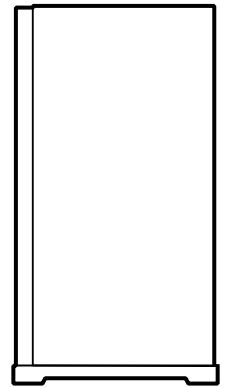

Picture 3



If the panels still seem too tight to come down all the way, try backing off the bracket screws by one half turn with a Phillips head screwdriver on the female bracket.

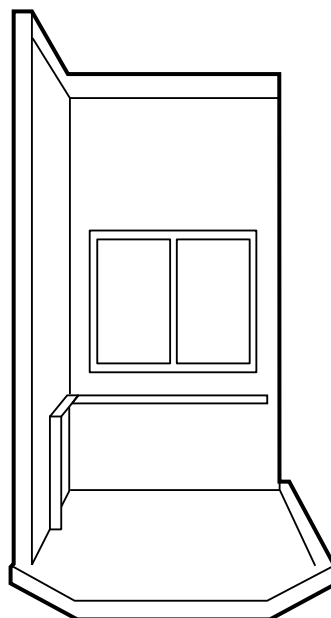

Left Side Wall Installed

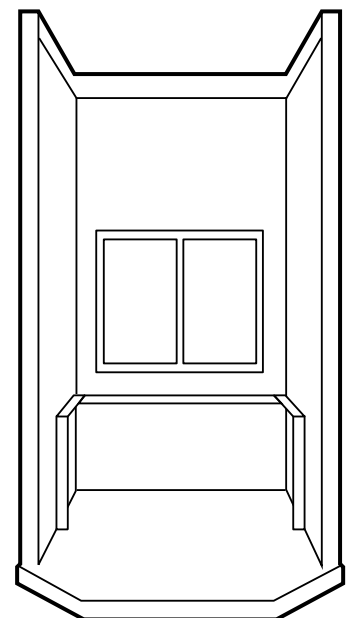

Right Side Wall Installed

Assembly Instructions Cont'd

5 - INSTALLING UNDER BENCH SUPPORT

Slide down the bench heater panel by lining up its sides with the vertical guides on the left and right side wall panel.

1. Be careful not to scratch the side panels when positioning the heater panel.
2. Push the bench heater panel all the way down until it is touching the floor panel and securely in place.

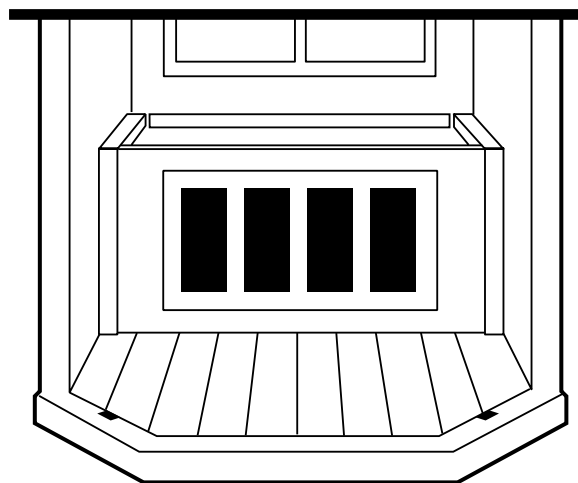
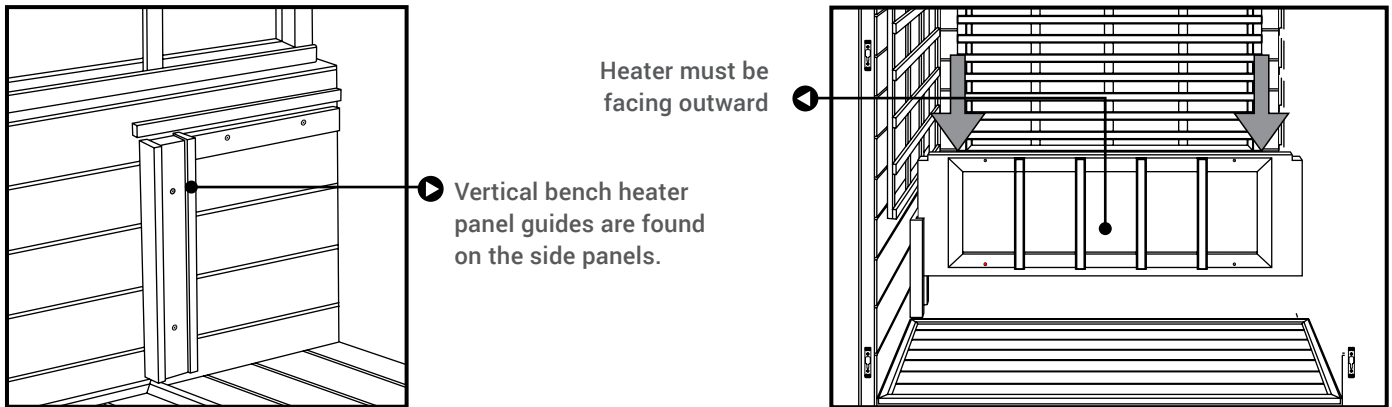

Assembly Instructions Cont'd

6 - CONNECT HEATER CONNECTION UNDER BENCH

Follow the connections as in the following illustration:

1. Connect the black and white cable coming out of the back of the under bench support to one of the left side wall connectors.
2. Connect the side black and white wall cable to one of the floor connectors.
3. Connect the black and white back wall cable to the other floor connector.
4. Connect the green ground connectors together.



You can plug any male connector to any female one as long as the colors match.

5. The two remaining cables labeled "VRT" will be connected if Vibrational Resonance Therapy is being added to the sauna. If you did not add this to your sauna, these cables will not be used.

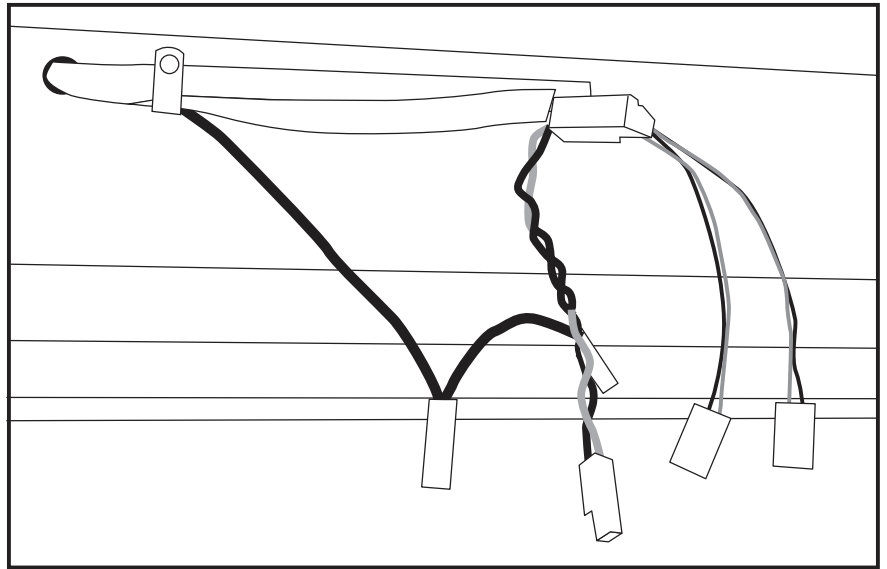
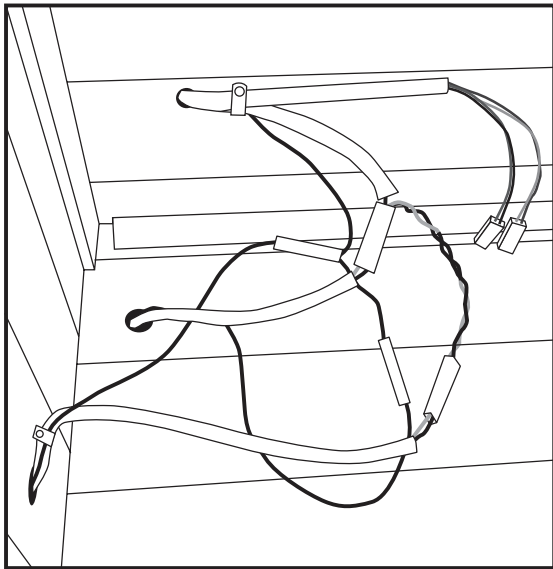

Assembly Instructions Cont'd

7 - INSTALLING THE BENCH

Install the bench panel by sliding it over the horizontal bench guides on the side panels. Be careful not to scratch the adjacent panels when sliding in the bench.

Push the bench all the way in until it touches the back panel and is securely in place.

The bench is reversible. One side is ergonomic and one side is flat. You can reverse the bench after the sauna installation is finished. **Be sure that the bench is pushed all the way back until it slides under the heater guard to secure the bench in place.**

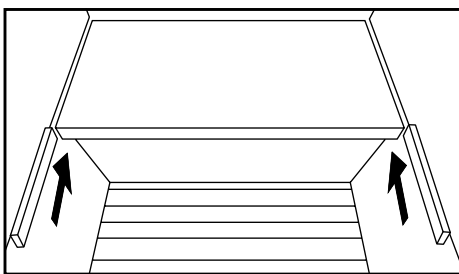
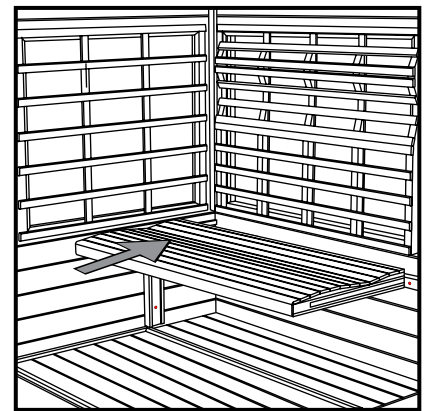
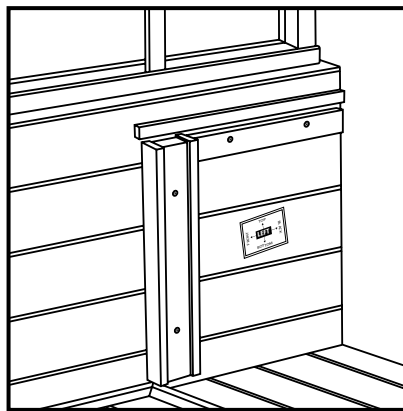
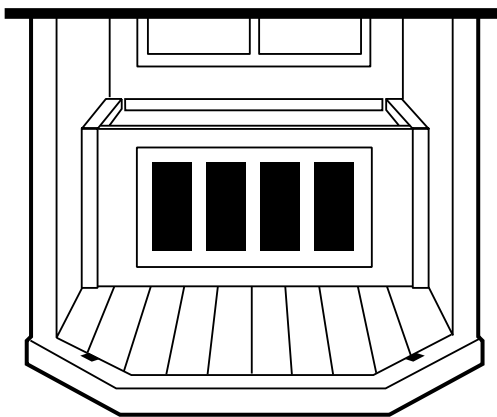

Optional: After the bench is installed, you can slide in the included wood pieces to prevent the bench from sliding left to right. One piece can be placed on each side next to the bench. If you decide to flip the reversible bench over, please remove the wood pieces first.

8 - INSTALLING WOOD PORTION OF ROOF

1. Set the wood portion of the roof on the back roof guide. Be sure to slide the roof back against the back wall.

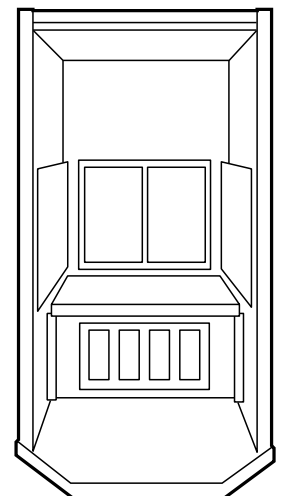

Assembly Instructions Cont'd

9 - INSTALLING WALL LOCKS



**THIS STEP IS VERY IMPORTANT.
PLEASE DO NOT OMIT THIS STEP.**

1. The side walls must be secured to the back wall and wood roof piece using the attached eye hooks.
2. Screw in one of the eye hooks between the left side wall and backwall and one between the right side wall and backwall.
3. Secure one of the eye hooks between the left side wall and top front of the wood roof piece and one between the right side wall and the top front of the wood roof piece.

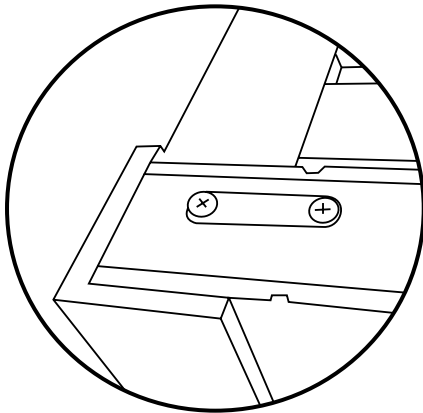

Attach eye hook so that it is screwed into both the side walls and back walls.

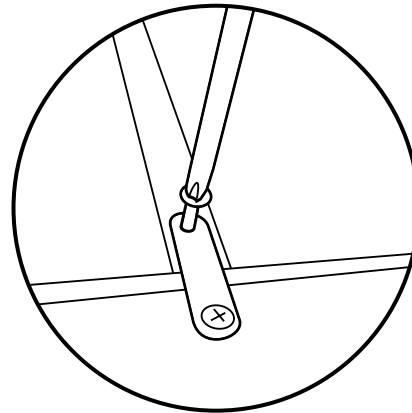

Attach the eye hook so that it is screwed into side walls and the wood roof piece.

4. Latch the three buckles that connect the wood roof piece to the back and side walls.

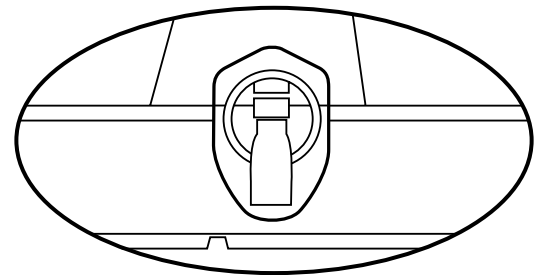

Assembly Instructions Cont'd

10 - INSTALLING GLASS PORTION OF ROOF AND RIGHT FRONT WALL

1. Locate the glass roof piece as in the photo below.
2. Locate the 4 sets of roof locking brackets with washers and screws.

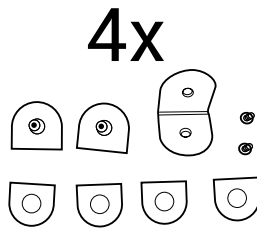

3. Attach the brackets to the roof piece as shown below using the enclosed Allen Wrench.

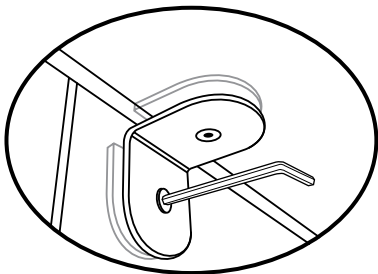

4. Place the long edge of the glass roof piece into the groove in the wood roof piece. Center this piece in the wood roof piece.



HOLD THIS PIECE IN PLACE UNTIL THE RIGHT SIDE FRONT WALL AND DOOR ARE INSTALLED

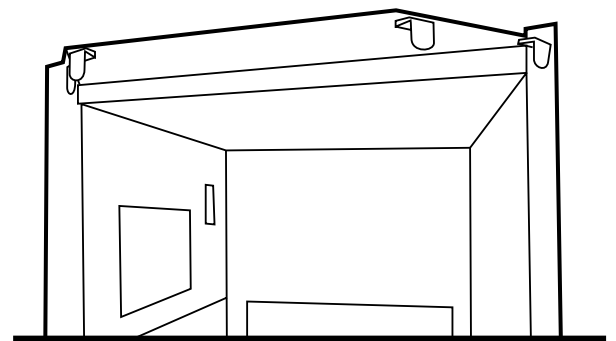

Assembly Instructions Cont'd

10 - INSTALLING GLASS PORTION OF ROOF AND RIGHT FRONT WALL

1. Locate the right front wall with right door.
2. Place the right front wall into the groove in the floor and align it under the glass roof piece. **Until this piece is secured using the enclosed brackets, someone should hold the wall and roof in place.**
3. Secure the left front glass window to the roof glass using the included brackets. You will see pre-drilled holes in both the front glass and roof glass.

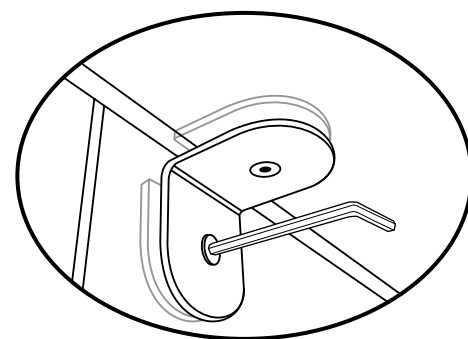
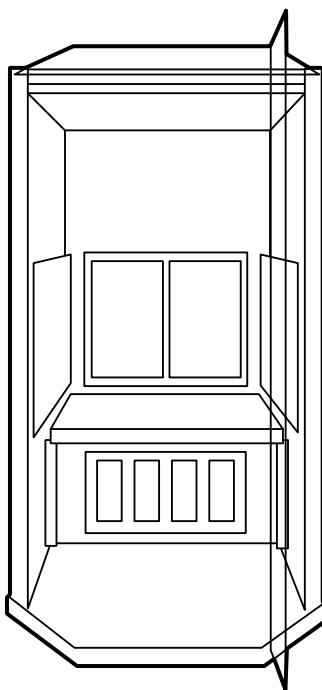

4. Repeat this process for the left front wall and door.

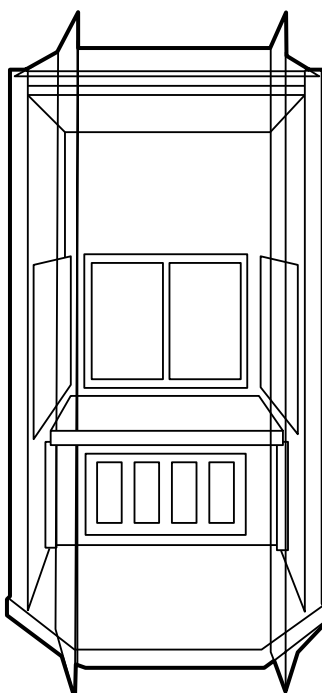

Assembly Instructions Cont'd

11 - CONNECT HEATERS IN ROOF

1. Locate the "trap" doors that open in the wood roof.
2. Connect the black and white cables that that come out of the side wall to the connector located in the wood roof.
3. Connect the green ground wire that come out of the side wall to the green ground wire that is in the wood roof.

Push the wiring inside the roof area and close the roof door compartments.

4. In the left side wall compartment, there will be two connectors: 1) Heater connector. 2) Keypad connector. The heater connector is a two wire connector. The keypad connector is a seven wire connector.

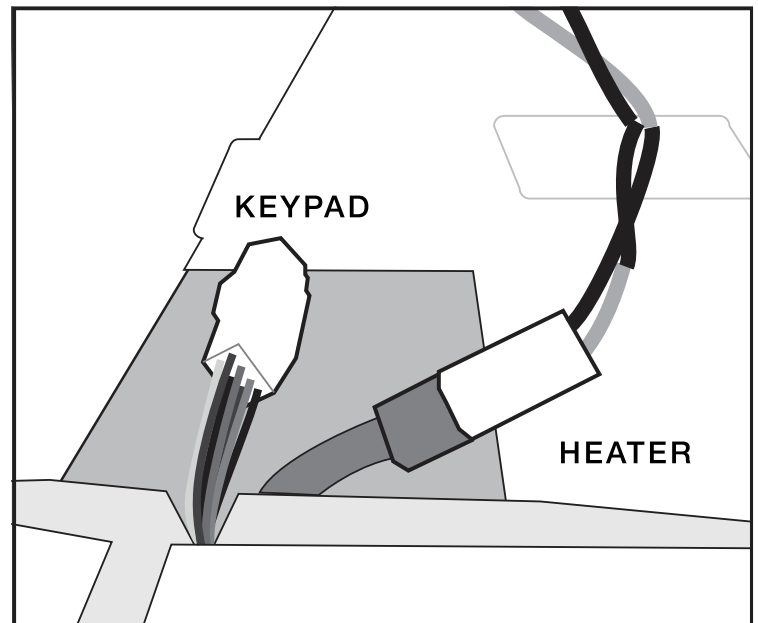

BE SURE TO MATCH THE COLORS IN THE CONNECTORS.
THE BLACK WIRE SHOULD MATCH UP WITH THE BLACK WIRE, ETC.

12 - INSTALLING DOOR HANDLE

1. Locate the two door handles.
2. Attach the right side door handle using the enclosed screws.
3. Attach the left side door handle using the enclosed screws.

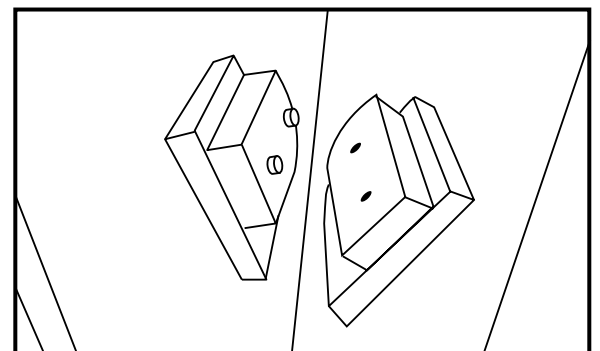

Note: If you are using a tablet or smartphone to control your sauna, the door handle will act as both the door handle and tablet/smartphone holder when the door is closed.

Assembly Instructions Cont'd

13 - INSTALLING FRONT HEATERS

1. Locate the two front heaters.
2. Align the left front heater and plug the connector that comes out of the bottom of the heater into the plug coming out of the in the floor.
3. Align the the hole in the back of the heater with the hole in the front wall glass Using the enclosed screws and washers, secure the heater to the glass through the pre-drilled hole. One washer will be placed on the inside and one on the outside glass. The heater will be secured with these screws in two locations.
4. Repeat this step for the right front heater.

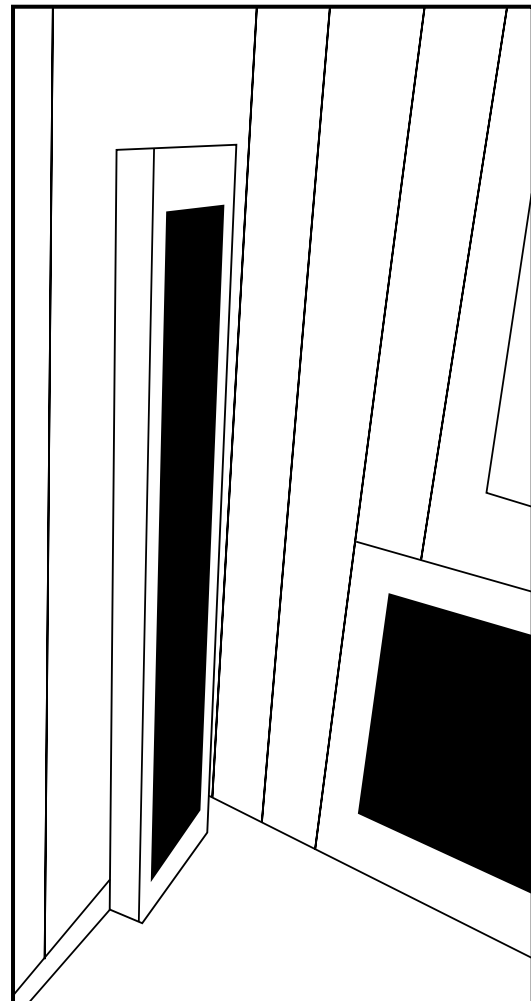
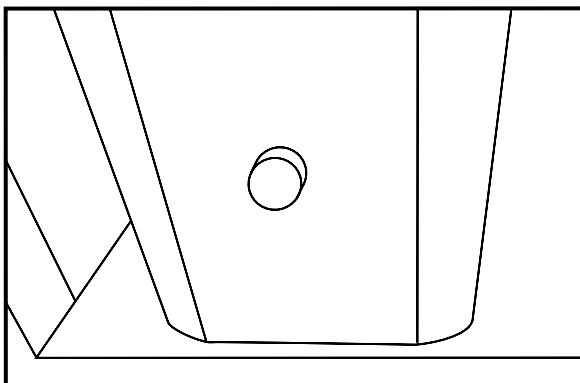
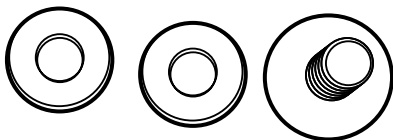
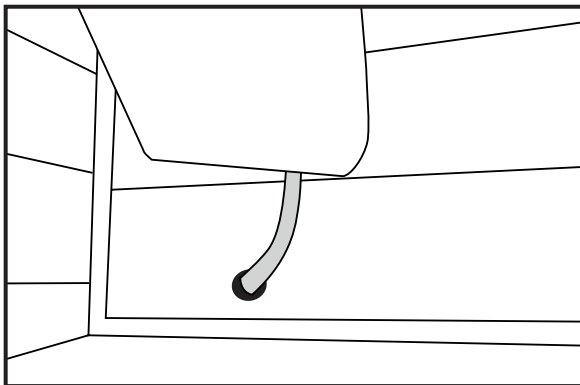

Front
Heater
Installed

Assembly Instructions Cont'd

13 - INSTALLING FRONT HEATERS

5. Once both heaters are installed carefully push the included Full Spectrum Heater guards securely over each of the front heaters. The full spectrum heaters are hot to the touch when running and this will prevent burning should you get close to the heater.

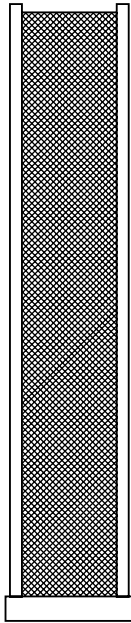

Warning Notice: The infrared heaters in your sauna are a potential BURN HAZARD. Do NOT touch the infrared heaters when they are in operation and allow to cool before servicing.

14 - LOCATING AND PLUGGING IN POWER CORD

The power cord comes out of the roof of the sauna. If you are standing facing the sauna, it comes out of the rear left corner of the roof. Open the trap door to access the power cord and run the cord down the back of the sauna. The power cord will plug into the appropriate electrical receptacle.



Note: We do not recommend using an extension cord for your sauna. Please plug the sauna directly into the wall receptacle.

Assembly Instructions Cont'd

15 - INSTALLATION IS COMPLETE

Installation of your sauna is now complete. Using a damp cloth, wipe out the sauna to remove any excess saw dust that may have settled on the wall & floor panels and the heater panels during manufacturing and shipment.

Please refer to usage instructions located later on in this manual.

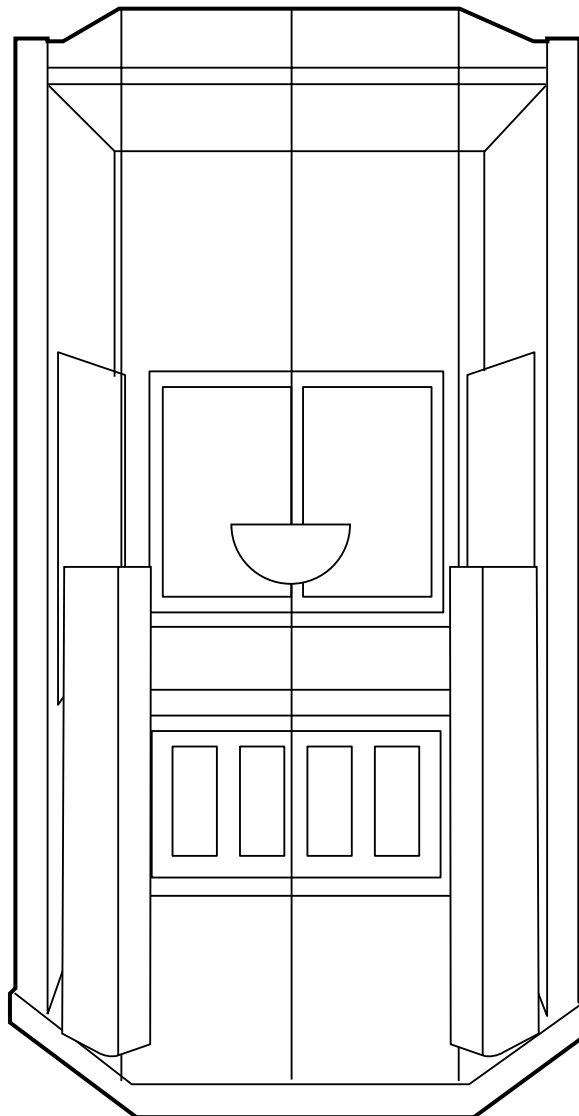



02 | SANCTUARY 2

Packaging	-----	20
Assembly Instructions	-----	21

Packaging

CONTENTS OF BOXES

Box 1 of 4

1. Floor Panel
2. Ceiling Panel
3. Accessories
4. Installation Manual

Box 2 of 4

1. Left Side Wall
2. Right Side Wall

Box 3 of 4

1. Front Wall Glass
2. Back Wall
3. Bench & Bench Support

Box 4 of 4

1. Front Heaters

ACCESSORY BOX CONTENTS

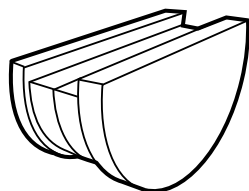

Door Handle

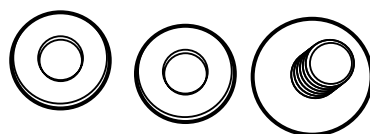

Front Heater
Mounting Screws
(4 sets)

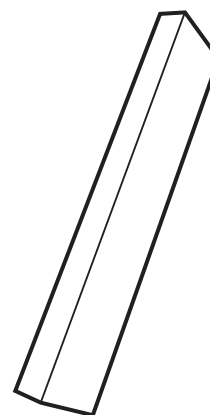

Wood piece
(2 pieces)

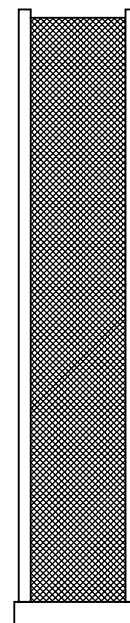

Full Spectrum
Heater Guard (2 pieces)

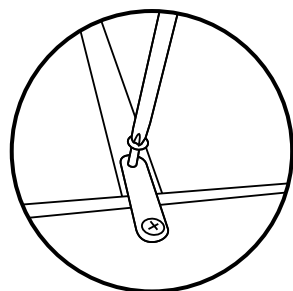

Wall Security
Bracket (4 pieces)

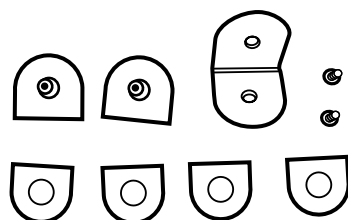

Glass Security
Brackets (2 sets)

Assembly Instructions

Assembly of the sauna requires two adults to complete. Please read the instructions thoroughly before and during assembly to ensure proper installation of the unit. If you encounter any problems or have questions during assembly, please feel free to call our Customer Service department at 1-800-798-1779 or +1-510-601-1775.

1 - LOCATION OF SAUNA & INSTALLATION ORDER

When determining a location for your sauna, please keep in mind the following:

1. The main power cord on the sauna must be easily accessible.
2. The location must be dry and level.
3. Panels should be installed in the following order:
 - 1) Floor
 - 2) Back Wall
 - 3) Left Side Wall
 - 4) Right Side Wall
 - 5) Under Bench Support
 - 6) Bench
 - 7) Wood Roof
 - 8) Glass Roof
 - 9) Front Wall Glass

2 - PLACING FLOOR PANEL

1. Place the bottom floor panel on the ground near the location you will using the sauna. Make sure the front of the floor is in the desired location of the door. The two plugs and the door magnet indicate the front of the sauna.

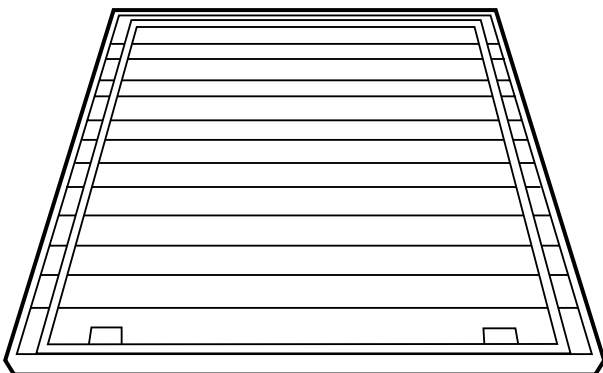

3 - CONNECTING THE BACK PANEL TO THE FLOOR PANEL

1. Connect the back panel to the floor panel by lining up the back panel on the groove of the floor panel.

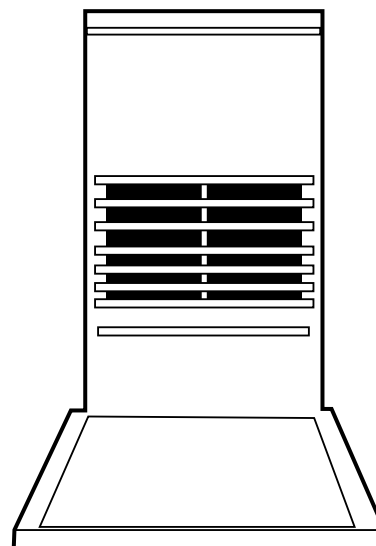

Assembly Instructions Cont'd

4 - CONNECTING SIDE WALLS

The side wall panels will be connected to the back wall by connecting together the installed brackets. There are "+" brackets and "-" brackets on the side of each panel. The side walls will be installed as follows:

1. Place the left side wall in the slot in the floor. Lift the side wall up about 4" (10cm) higher than the backwall panel (See Picture 1).
2. Place the side wall panel against the back wall (See Picture 2), then slide down side wall panel until the two panels are equal height. (See Picture 3).
3. If the panels are not equal height or there is an obvious gap between the two panels, this means they are not properly attached and you should try again.
4. Repeat the steps above for the right side wall panel.

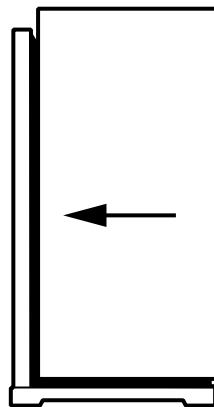

Picture 1

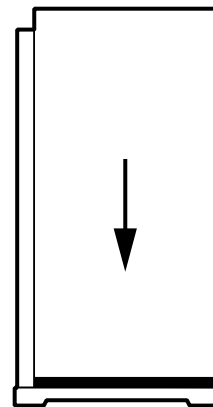

Picture 2

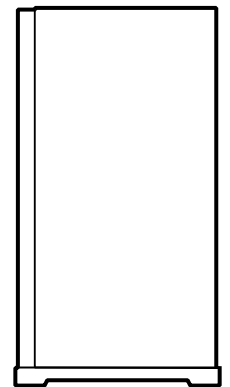

Picture 3



If the panels still seem too tight to come down all the way, try backing off the bracket screws by one half turn with a Phillips head screwdriver on the female bracket.

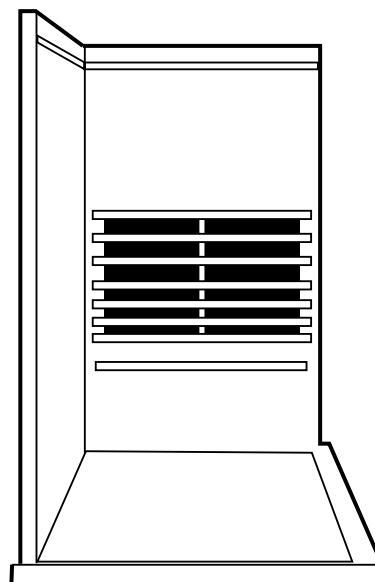

Left Side Wall Installed

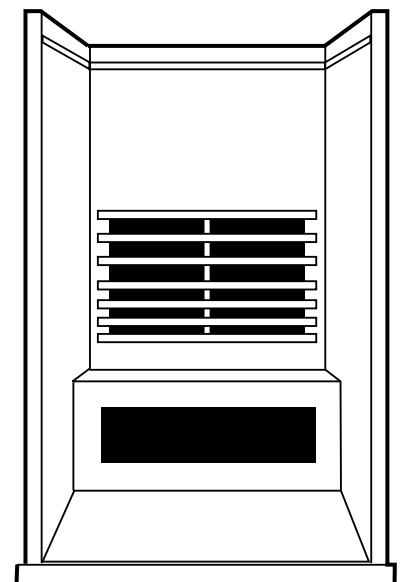

Right Side Wall Installed

Assembly Instructions Cont'd

5 - INSTALLING UNDER BENCH SUPPORT

Slide down the bench heater panel by lining up its sides with the vertical guides on the left and right side wall panel.

1. Be careful not to scratch the side panels when positioning the heater panel.
2. Push the bench heater panel all the way down until it is touching the floor panel and securely in place.

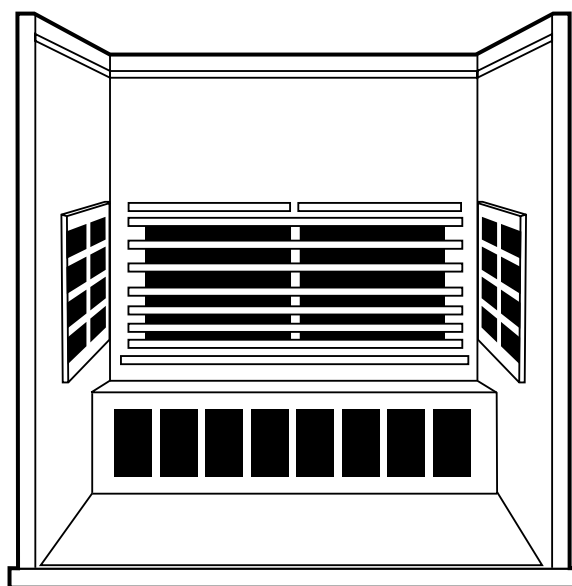
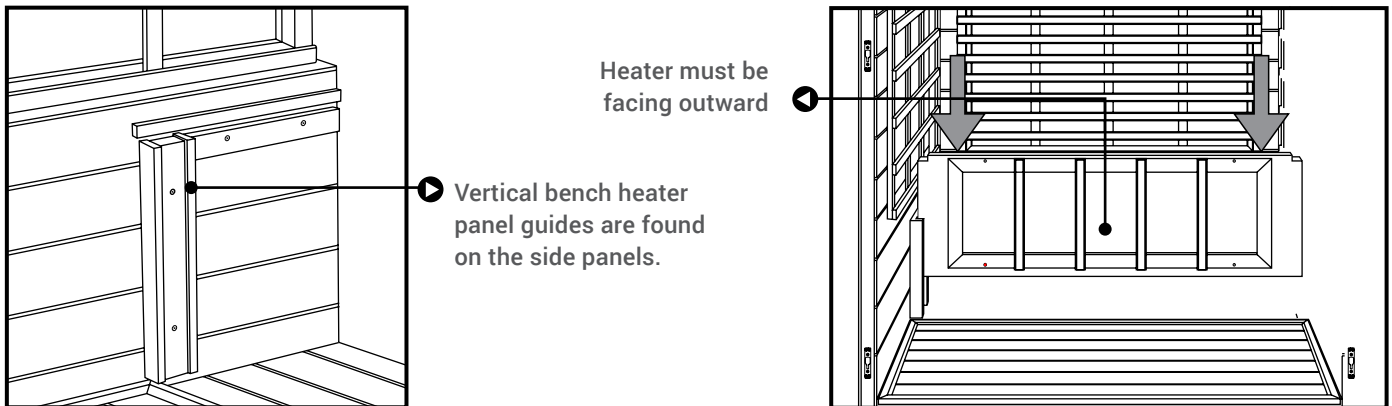

Assembly Instructions Cont'd

6 - CONNECT HEATER CONNECTION UNDER BENCH

Follow the connections as in the following illustration:

1. Connect the black and white cable coming out of the back of the under bench support to one of the left side wall connectors.
2. Connect the side black and white wall cable to one of the floor connectors.
3. Connect the black and white back wall cable to the other floor connector.
4. Connect the green ground connectors together.



You can plug any male connector to a female one as long as the colors match.

5. The two remaining cables labeled "VRT" will be connected if added Vibrational Resonance Therapy is being added to the sauna. If you did not add this to your sauna, these cables will not be used.

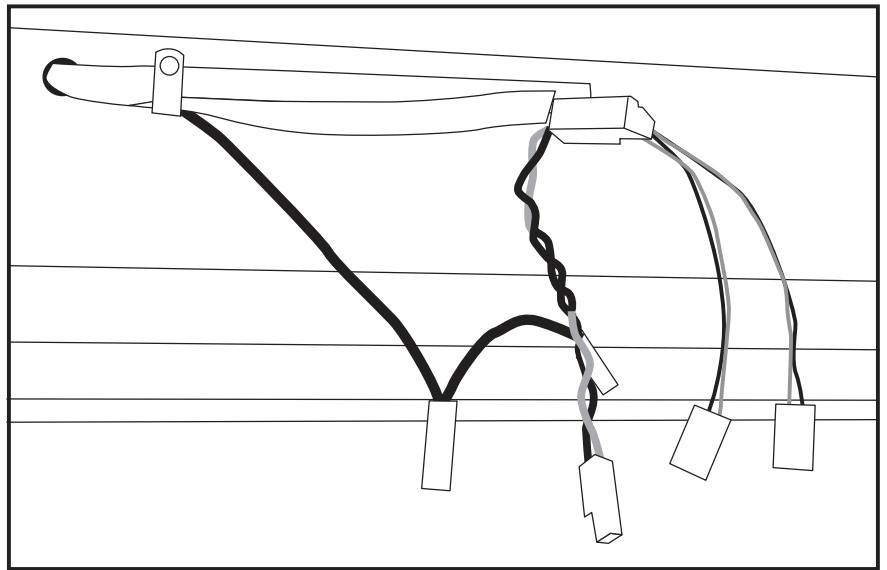
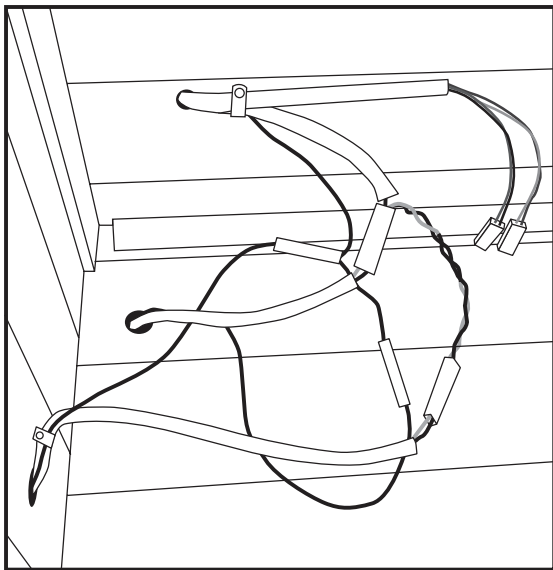

Assembly Instructions Cont'd

7 - INSTALLING THE BENCH

Install the bench panel by sliding it over the horizontal bench guides on the side panels. Be careful not to scratch the adjacent panels when sliding in the bench.

Push the bench all the way in until it touches the back panel and is securely in place.

The bench is reversible. One side is ergonomic and one side is flat. You can reverse the bench after the sauna installation is finished. **Be sure that the bench is pushed all the way back until it slides under the heater guard to secure the bench in place.**

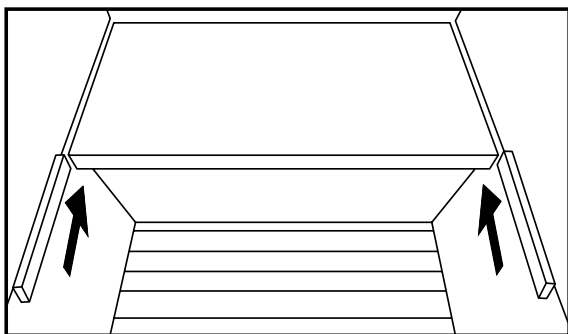
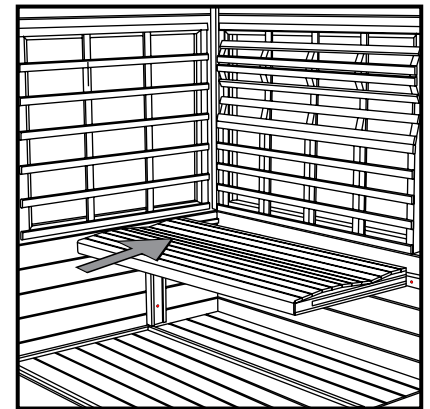
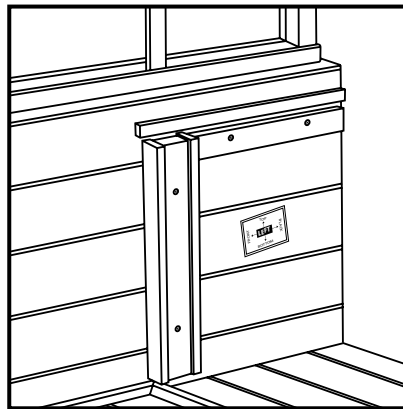
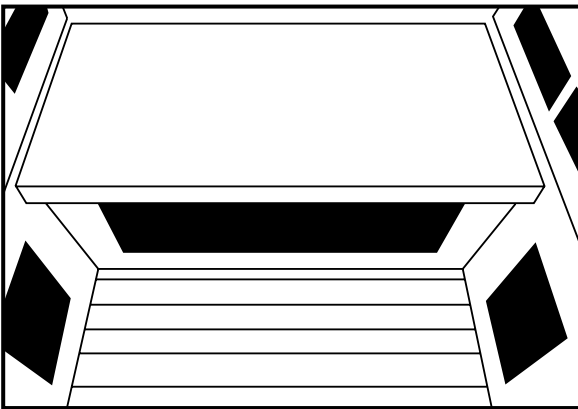

Optional: After the bench is installed, you can slide in the included wood pieces to prevent the bench from sliding left to right. One piece can be placed on each side next to the bench. If you decide to flip the reversible bench over, please remove the wood pieces first.

Assembly Instructions Cont'd

8 - INSTALLING WOOD PORTION OF ROOF

1. Set the wood portion of the roof on the back roof guide. Be sure to slide the roof back against the back wall.

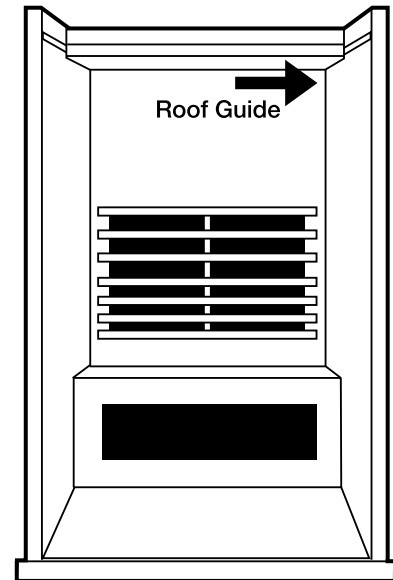

9 - INSTALLING GLASS PORTION OF ROOF

1. Place the glass roof portion on the front roof guides. Be sure that it is pushed firmly back against the wood roof portion.

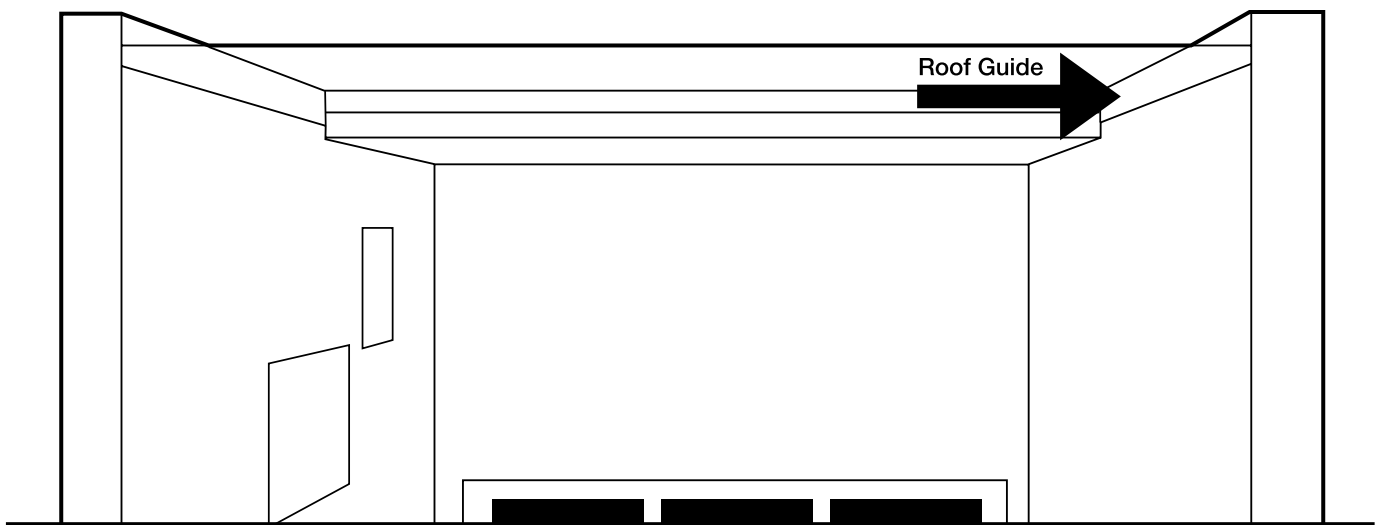

Assembly Instructions Cont'd

10 - INSTALLING WALL LOCKS



THIS STEP IS VERY IMPORTANT. PLEASE DO NOT OMIT THIS STEP.

1. The side walls must be secured to the back wall and wood roof piece using the attached eye hooks.
2. Screw in one of the eye hooks between the left side wall and backwall and one between the right side wall and backwall.
3. Secure one of the eye hooks between the left side wall and top front of the wood roof piece and one between the right side wall and the top front of the wood roof piece.
4. Latch the three buckles that connect the wood roof piece to the back and side walls.

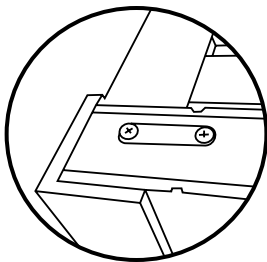

Attach eye hook so that it is screwed into both the side walls and back walls.

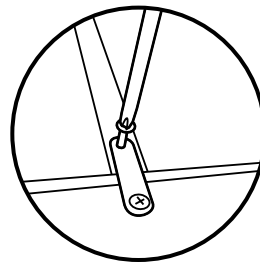

Attach the eye hook so that it is screwed into side walls and the wood roof piece.

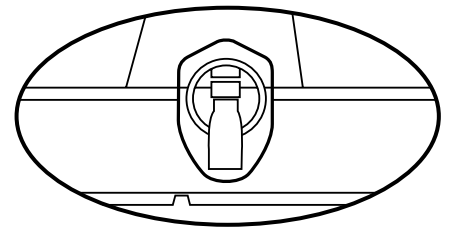

11 - INSTALLING GLASS DOOR AND RIGHT SIDE GLASS WINDOW

1. We recommend using two people to move the glass door and right window piece. Place the glass door with right window in the groove in the floor and slide it securely into place against the right wall. It may help to put the corner of the glass in place first then put the rest of the glass in the slot. **Until this piece is secured as in step 2 below using the enclosed brackets, please hold this piece in place.**
2. Secure the front glass door and right side glass window to the roof glass using the included brackets. You will see pre-drilled holes in both the front glass and roof glass. One person should hold the outside piece while the other person screws in the bolt.

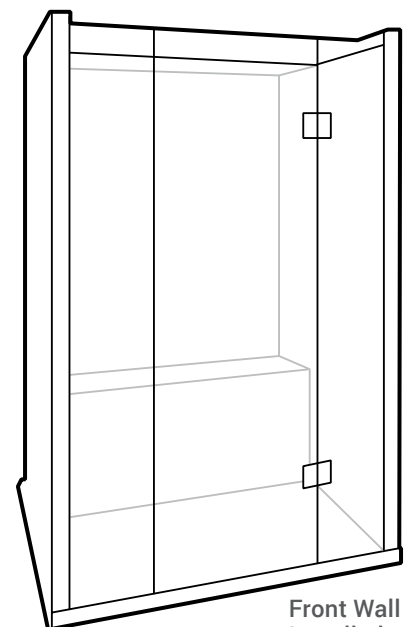
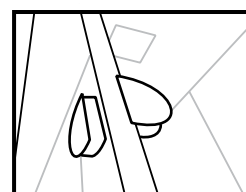
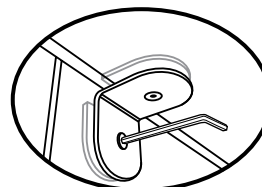
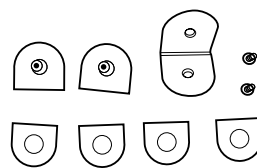

Front Wall Installed

Assembly Instructions Cont'd

12 - INSTALLING LEFT SIDE GLASS

1. Open the door of the sauna to allow room to place the left side glass window.
2. Place the left side glass window and push it against the left side wall so it is securely in place. Until this piece is secured using the included brackets, someone should hold the piece in place.
3. Secure the left front glass window to the roof glass using the included brackets. You will see pre-drilled holes in both the front glass and roof glass.

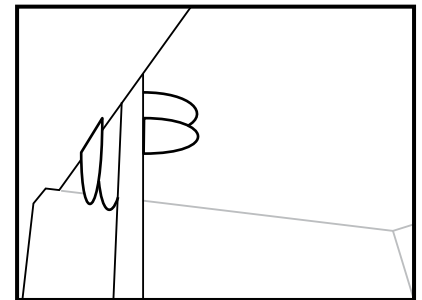
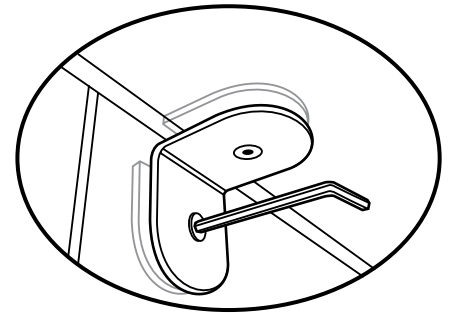
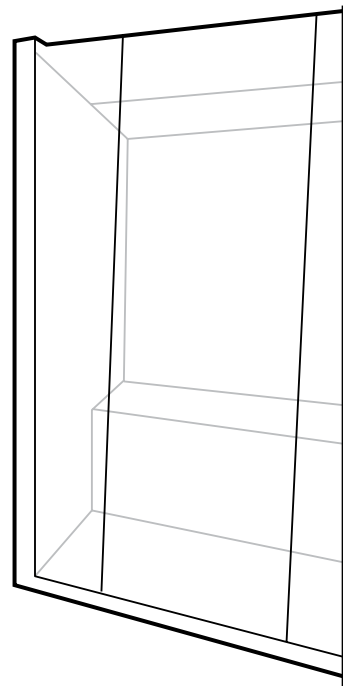

Front Wall
Installed

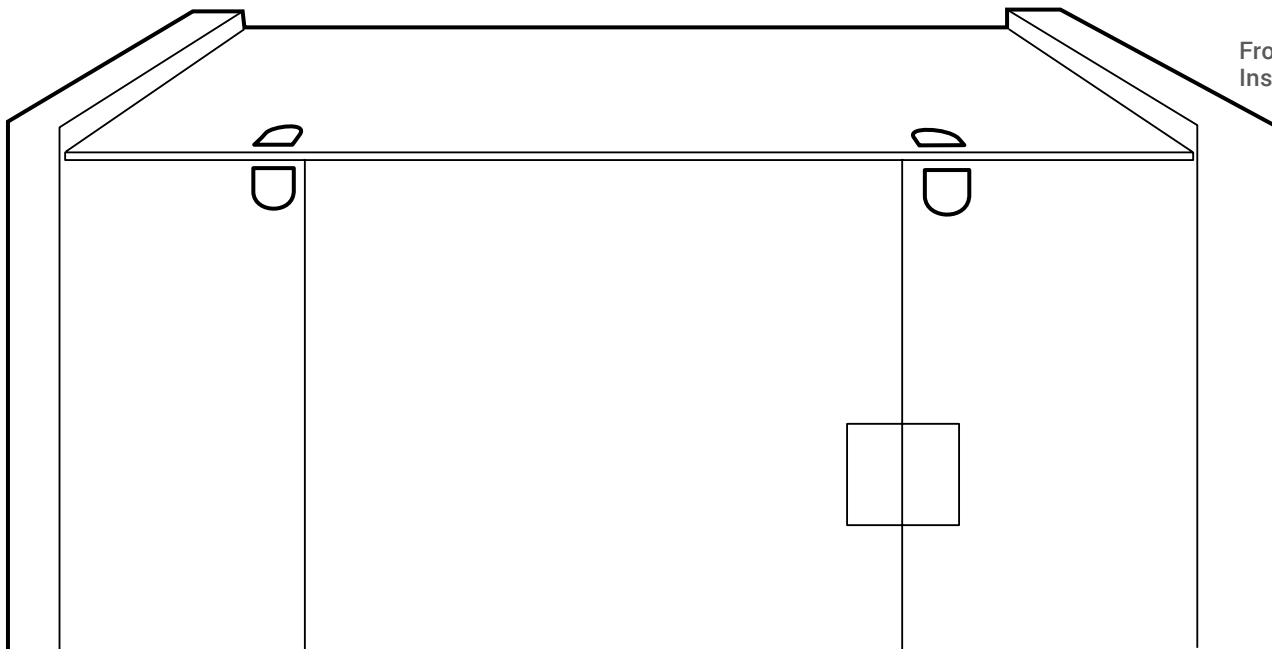

Assembly Instructions Cont'd

13 - CONNECT HEATERS IN ROOF

1. Locate the "trap" doors that open in the wood roof.
2. Connect the black and white cables that come out of the side wall to the connector located in the wood roof.
3. Connect the green ground wire that come out of the side wall to the green ground wire that is in the wood roof. Push the wiring inside the roof area and close the roof door compartments.
4. In the left side wall compartment, there will be two connectors: 1) Heater connector. 2) Keypad connector. The heater connector is a two wire connector. The keypad connector is a seven wire connector.

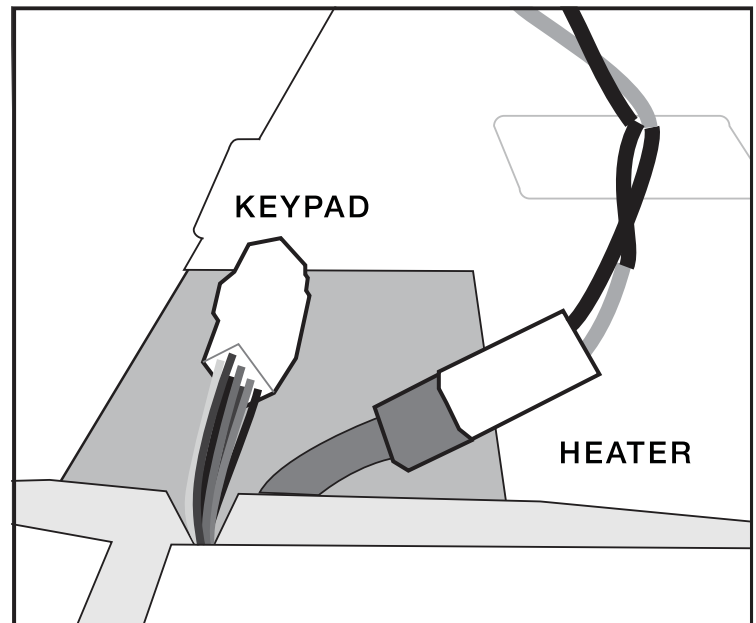

BE SURE TO MATCH THE COLORS IN THE CONNECTORS.
THE BLACK WIRE SHOULD MATCH UP WITH THE BLACK WIRE, ETC.

14 - INSTALLING DOOR HANDLE

1. Locate the door handle.
2. Attach the door handle using the enclosed screws.

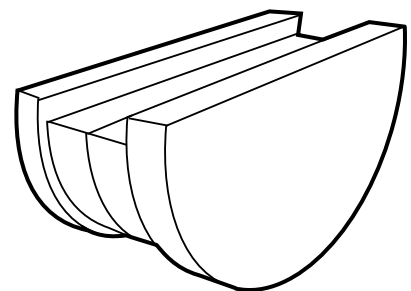

Note: If you are using a tablet or smartphone to control your sauna, the door handle will act as both the door handle and tablet/smartphone holder when the door is closed.

Assembly Instructions Cont'd

15 - INSTALLING FRONT HEATERS

1. Locate the two front heaters.
2. Align the left front heater and plug the connector that comes out of the bottom of the heater into the plug coming out of the in the floor.
3. Align the the hole in the back of the heater with the hole in the front wall glass. Using the included screws and washers, secure the heater to the glass through the pre-drilled hole. One washer will be placed on the inside and one on the outside glass. The heater will be secured with these screws in two locations.
4. Repeat this step for the right front heater.

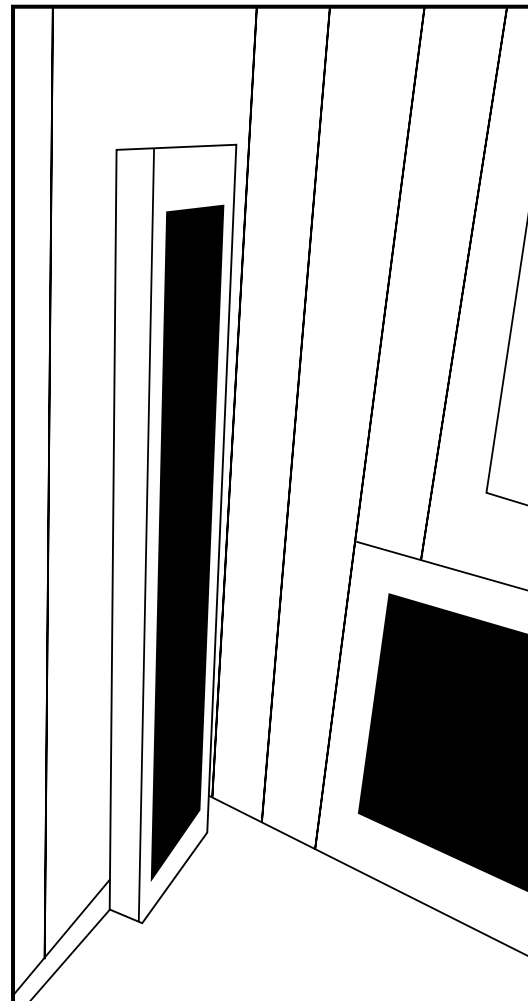
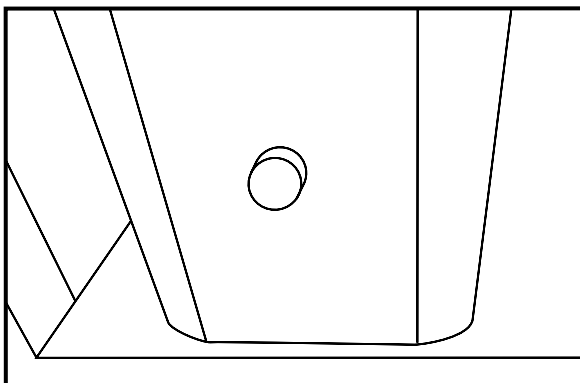
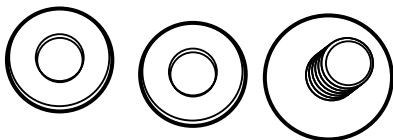
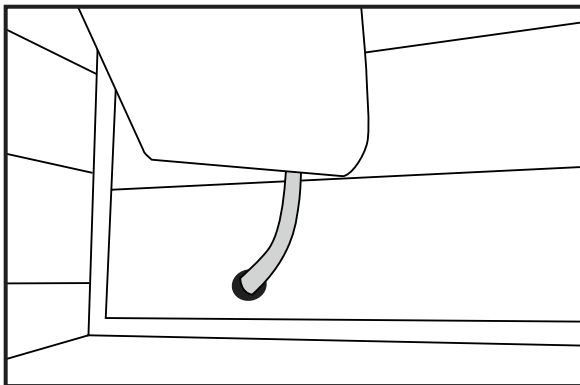

Front
Heater
Installed

Assembly Instructions Cont'd

15 - INSTALLING FRONT HEATERS

- Once both heaters are installed carefully push the included Full Spectrum Heater guards securely over each of the front heaters. The full spectrum heaters are hot to the touch when running and this will prevent burning should you get close to the heater.

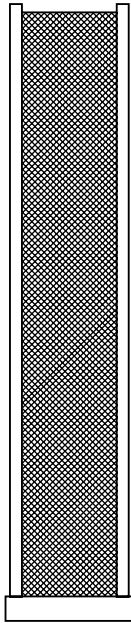

Warning Notice: The infrared heaters in your sauna are a potential BURN HAZARD. Do NOT touch the infrared heaters when they are in operation and allow to cool before servicing.

16 - LOCATING AND PLUGGING IN POWER CORD

The power cord comes out of the roof of the sauna. If you are standing facing the sauna, it comes out of the rear left corner of the roof. Open the trap door to access the power cord and run the cord down the back of the sauna. The power cord will plug into the appropriate electrical receptacle.



Note: We do not recommend using an extension cord for your sauna. Please plug the sauna directly into the wall receptacle.

Assembly Instructions Cont'd

17 - INSTALLATION IS COMPLETE

Installation of your sauna is now complete. Using a damp cloth, wipe out the sauna to remove any excess saw dust that may have settled on the wall & floor panels and the heater panels during manufacturing and shipment.

Please refer to usage instructions located later on in this manual.

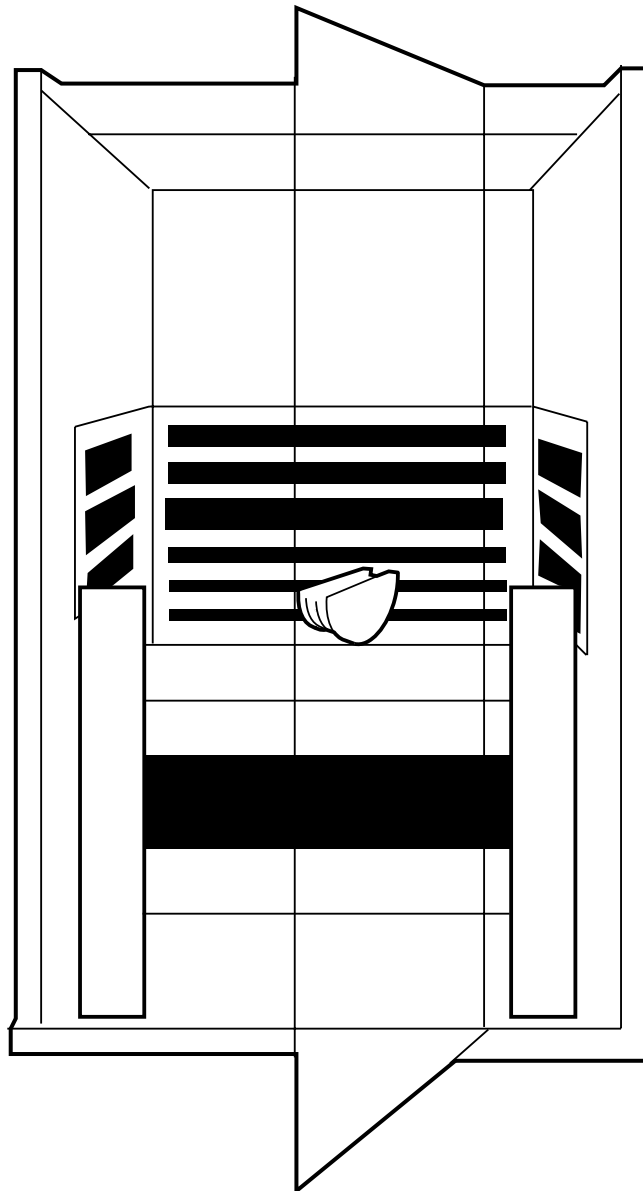



03

SANCTUARY 3

Packaging	-----	34
Assembly Instructions	-----	35

Packaging

CONTENTS OF BOXES

Box 1 of 4

1. Floor Panel
2. Ceiling Panel
3. Accessories
4. Installation Manual

Box 2 of 4

1. Left Side Wall
2. Right Side Wall

Box 3 of 4

1. Front Wall Glass
2. Back Wall
3. Bench & Bench Support

Box 4 of 4

1. Front Heaters

ACCESSORY BOX CONTENTS

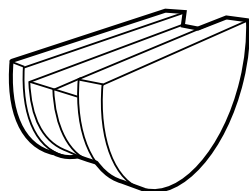

Door Handle

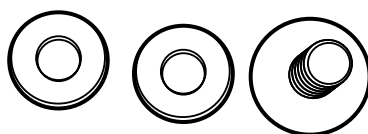

Front Heater
Mounting Screws
(4 sets)

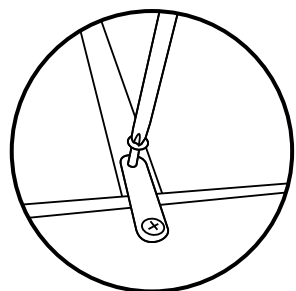

Wall Security
Bracket (4 pieces)

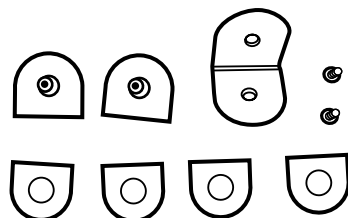

Glass Security
Brackets (2 sets)

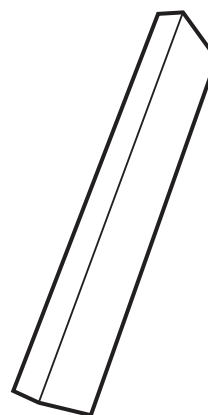

Wood piece
(2 pieces)

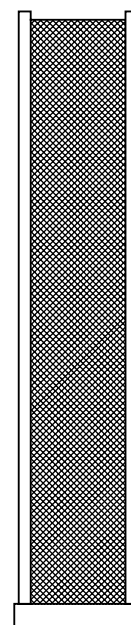

Full Spectrum
Heater Guard (2 pieces)

Assembly Instructions

Assembly of the sauna requires two adults to complete. Please read the instructions thoroughly before and during assembly to ensure proper installation of the unit. If you encounter any problems or have questions during assembly, please feel free to call our Customer Service department at 1-800-798-1779 or +1-510-601-1775.

1 - LOCATION OF SAUNA & INSTALLATION ORDER

When determining a location for your sauna, please keep in mind the following:

1. The main power cord on the sauna must be easily accessible.
2. The location must be dry and level.
3. Panels should be installed in the following order:
 - 1) Floor
 - 2) Back Wall
 - 3) Left Side Wall
 - 4) Right Side Wall
 - 5) Under Bench Support
 - 6) Bench
 - 7) Wood Roof
 - 8) Glass Roof
 - 9) Front Wall Glass

2 - PLACING FLOOR PANEL

1. Place the bottom floor panel on the ground near the location you will using the sauna. Make sure the front of the floor is in the desired location of the door. The two plugs and the door magnet indicate the front of the sauna.

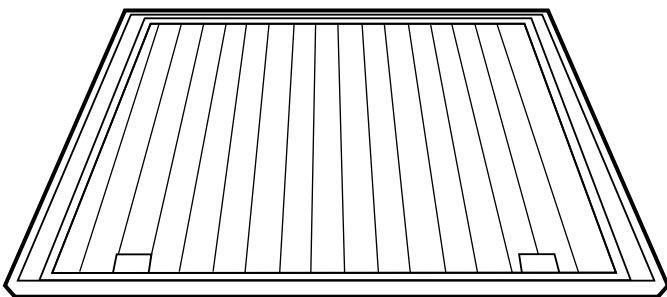

3 - CONNECTING THE BACK PANEL TO THE FLOOR PANEL

1. Connect the back panel to the floor panel by lining up the back panel on the groove of the floor panel.

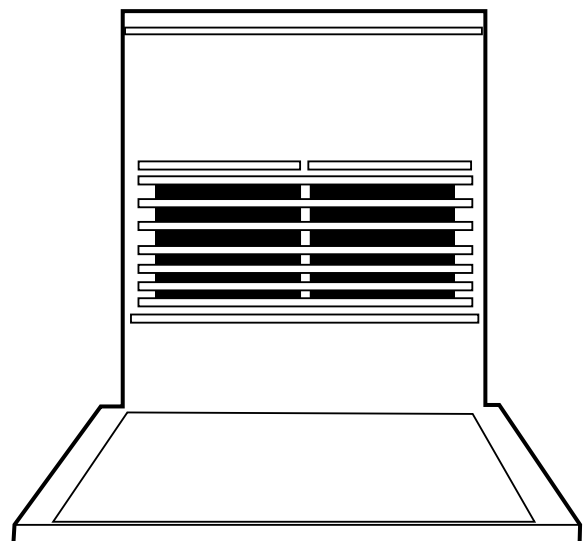

Assembly Instructions Cont'd

4 - CONNECTING SIDE WALLS

The side wall panels will be connected to the back wall by connecting together the installed brackets. There are "+" brackets and "-" brackets on the side of each panel. The side walls will be installed as follows:

1. Place the left side wall in the slot in the floor. Lift the side wall up about 4" (10cm) higher than the backwall panel (See Picture 1).
2. Place the side wall panel against the back wall (See Picture 2), then slide down side wall panel until the two panels are equal height. (See Picture 3).
3. If the panels are not equal height or there is an obvious gap between the two panels, this means they are not properly attached and you should try again.
4. Repeat the steps above for the right side wall panel.

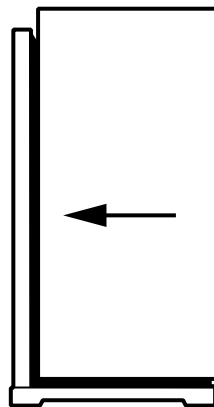

Picture 1

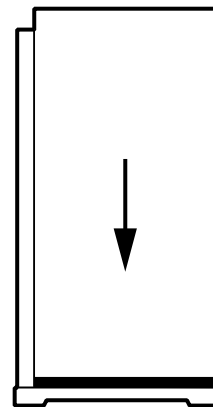

Picture 2

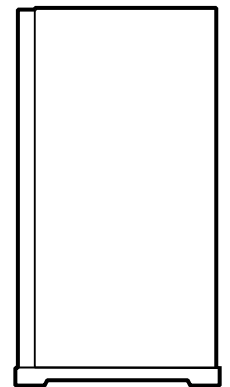

Picture 3



If the panels still seem too tight to come down all the way, try backing off the bracket screws by one half turn with a Phillips head screwdriver.

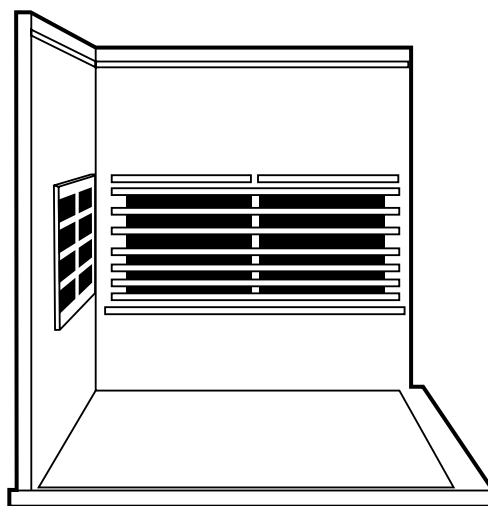

Left Side Wall Installed

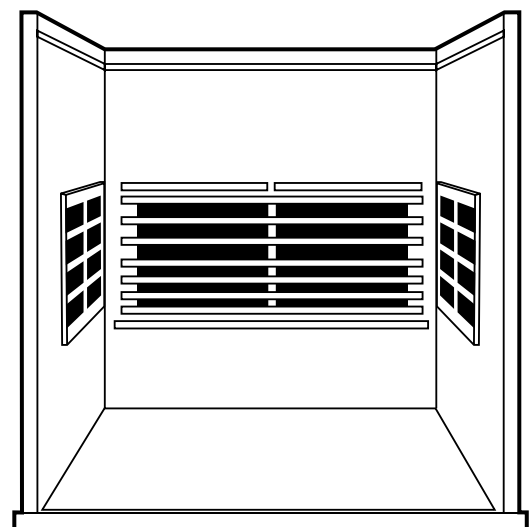

Right Side Wall Installed

Assembly Instructions Cont'd

5 - INSTALLING UNDER BENCH SUPPORT

Slide down the bench heater panel by lining up its sides with the vertical guides on the left and right side wall panel.

1. Be careful not to scratch the side panels when positioning the heater panel.
2. Push the bench heater panel all the way down until it is touching the floor panel and securely in place.

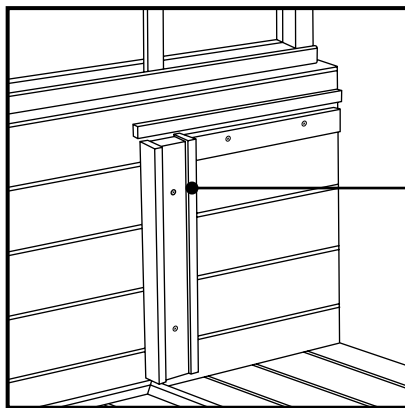

Vertical bench heater panel guides are found on the side panels.

Heater must be facing outward

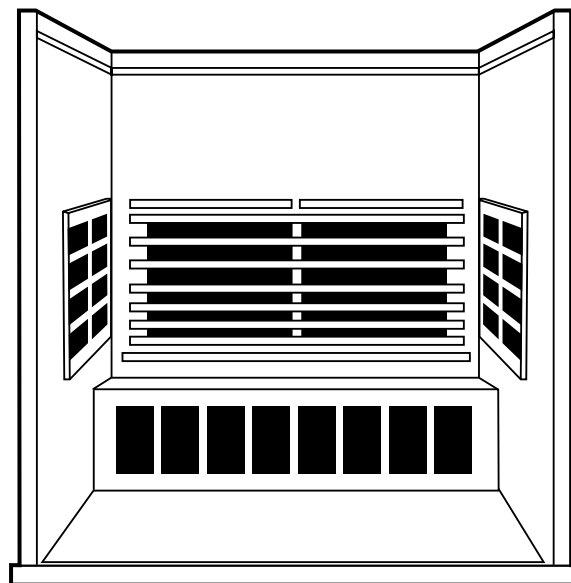
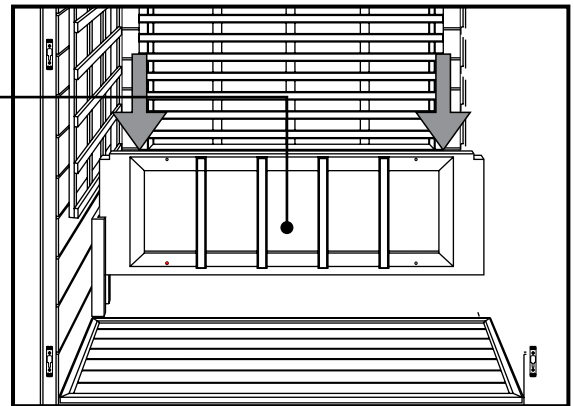

Assembly Instructions Cont'd

6 - CONNECT HEATER CONNECTION UNDER BENCH

Follow the connections as in the following illustration:

1. Connect the black and white cable coming out of the back of the under bench support to one of the left side wall connectors.
2. Connect the side black and white wall cable to one of the floor connectors.
3. Connect the black and white back wall cable to the other floor connector.
4. Connect the green ground connectors together.



You can plug any male connector to a female one as long as the colors match.

5. The two remaining cables labeled "VRT" will be connected if Vibrational Resonance Therapy is being added to the sauna. If you did not add this to your sauna, these cables will not be used.

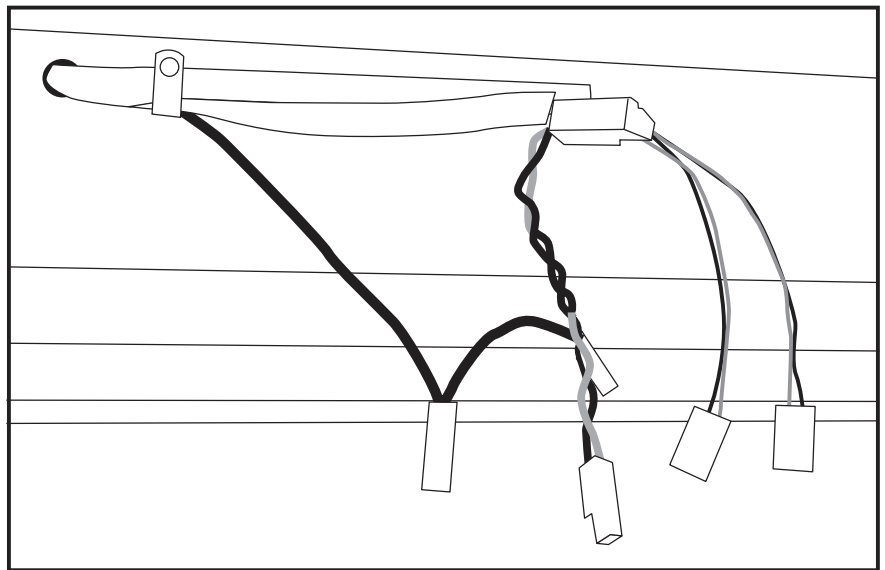
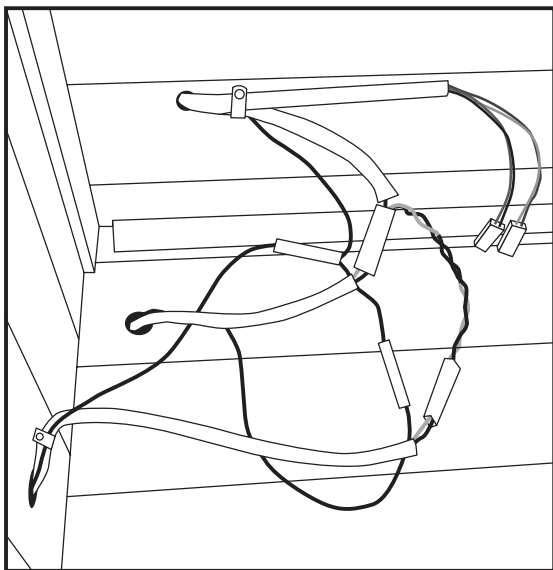

Assembly Instructions Cont'd

7 - INSTALLING THE BENCH

Install the bench panel by sliding it over the horizontal bench guides on the side panels. Be careful not to scratch the adjacent panels when sliding in the bench.

Push the bench all the way in until it touches the back panel and is securely in place.

The bench is reversible. One side is ergonomic and one side is flat. You can reverse the bench after the sauna installation is finished. **Be sure that the bench is pushed all the way back until it slides under the heater guard to secure the bench in place.**

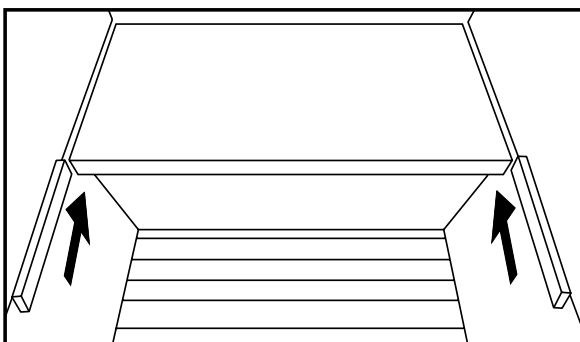
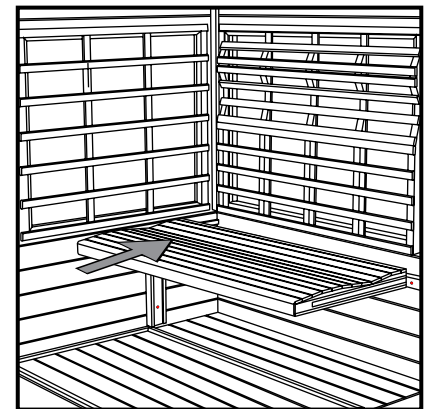
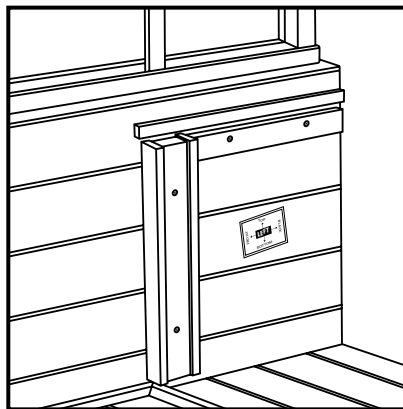
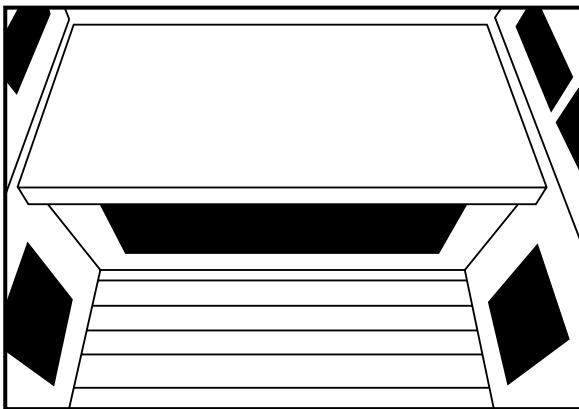

Optional: After the bench is installed, you can slide in the included wood pieces to prevent the bench from sliding left to right. One piece can be placed on each side next to the bench. If you decide to flip the reversible bench over, please remove the wood pieces first.

Assembly Instructions Cont'd

8 - INSTALLING WOOD PORTION OF ROOF

1. Set the wood portion of the roof on the back roof guide. Be sure to slide the roof back against the back wall.

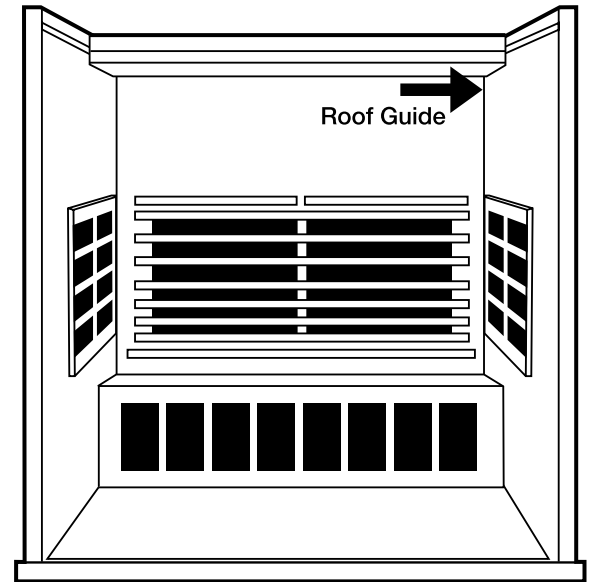

9 - INSTALLING GLASS PORTION OF ROOF

1. Place the glass roof portion on the front roof guides. Be sure that it is pushed firmly back against the wood roof portion.

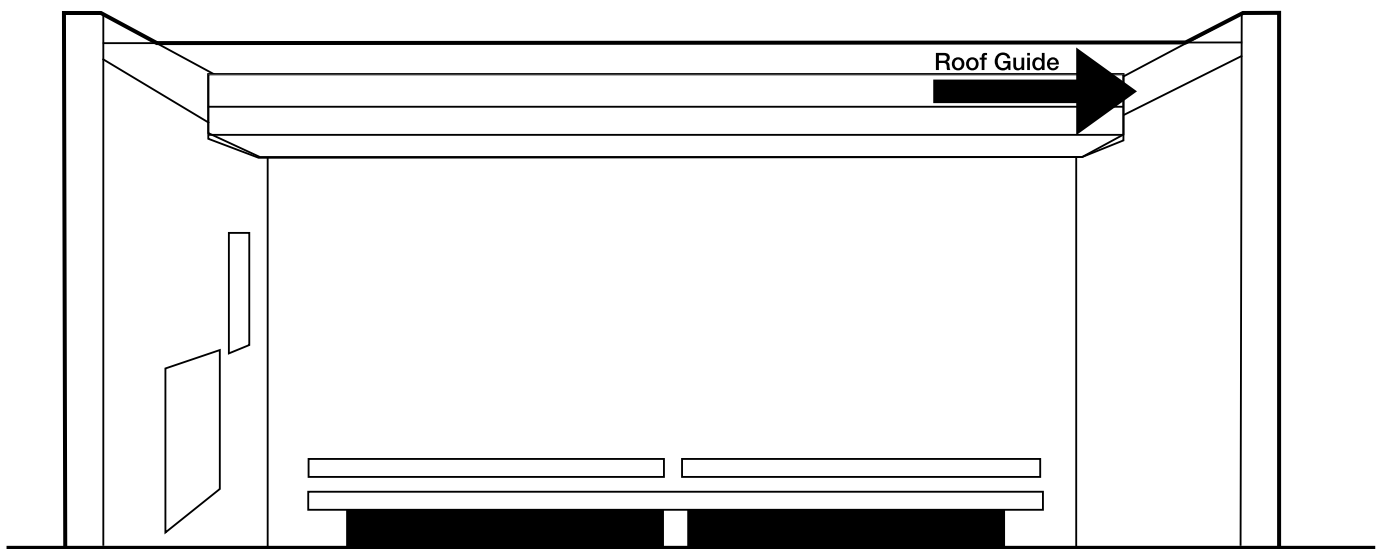

Assembly Instructions Cont'd

10 - INSTALLING WALL LOCKS



**THIS STEP IS VERY IMPORTANT.
PLEASE DO NOT OMIT THIS STEP.**

1. The side walls must be secured to the back wall and wood roof piece using the attached eye hooks.
2. Screw in one of the eye hooks between the left side wall and backwall and one between the right side wall and backwall.
3. Secure one of the eye hooks between the left side wall and top front of the wood roof piece and one between the right side wall and the top front of the wood roof piece.

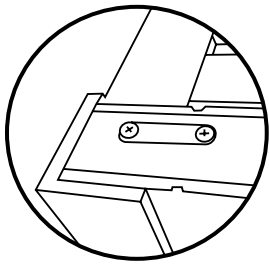

Attach eye hook so that it is screwed into both the side walls and back walls.

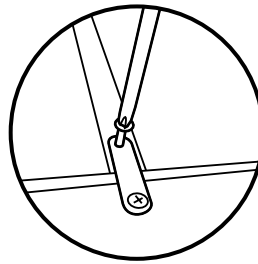

Attach the eye hook so that it is screwed into side walls and the wood roof piece.

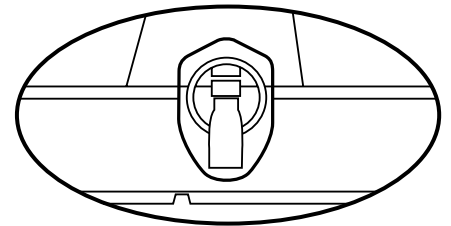

11 - INSTALLING LEFT SIDE GLASS WINDOW

1. We recommend using two people to move the glass door and right window piece. Place the glass door with left window in the groove in the floor and slide it securely into place against the left wall. It may help to put the corner of the glass in place first then put the rest of the glass in the slot. **Until this piece is secured as in step 2 below using the enclosed brackets, please hold this piece in place.**
2. Secure the left side glass window to the roof glass using the included brackets. You will see pre-drilled holes in both the front glass and roof glass. One person should hold the outside piece while the other person screws in the bolt.

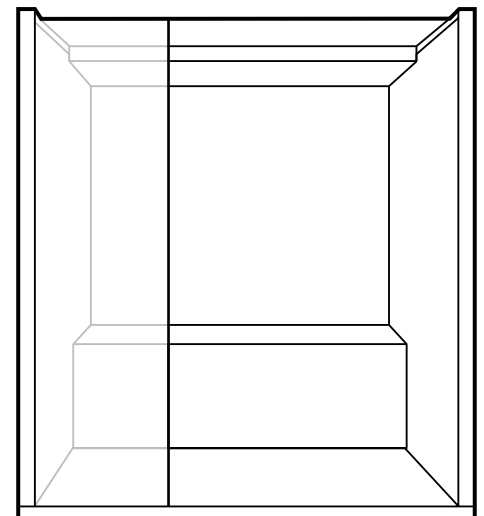
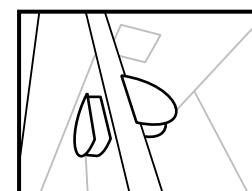
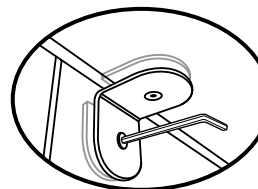
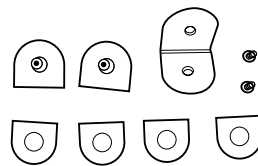

Front Wall Installed

Assembly Instructions Cont'd

12 - INSTALLING DOOR / RIGHT SIDE GLASS WINDOW

1. Place the right side glass window and push it against the right side wall so it is securely in place.
Be sure to secure the door so it does not swing open. Until this piece is secured using the included brackets, someone should hold the piece in place.
2. Secure the right front glass window to the roof glass using the included brackets. You will see pre-drilled holes in both the front glass and roof glass.

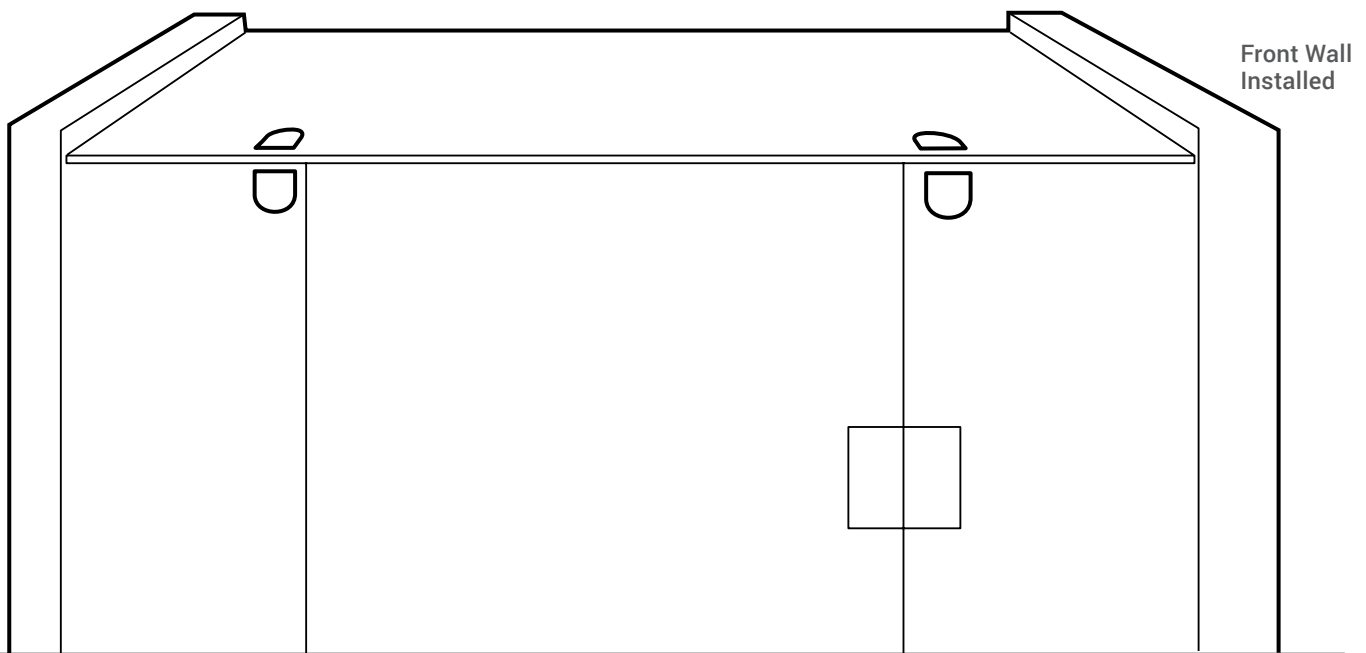
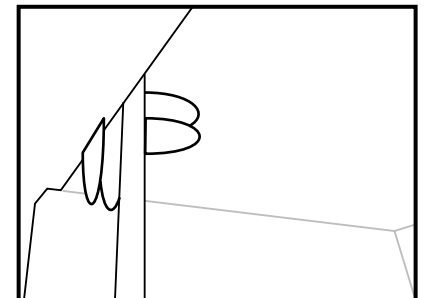
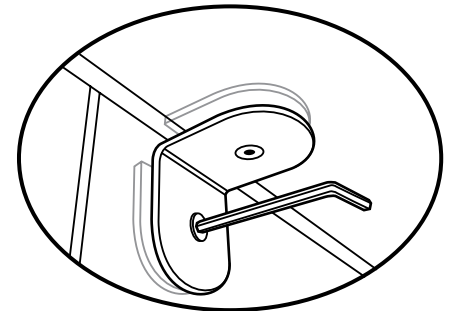
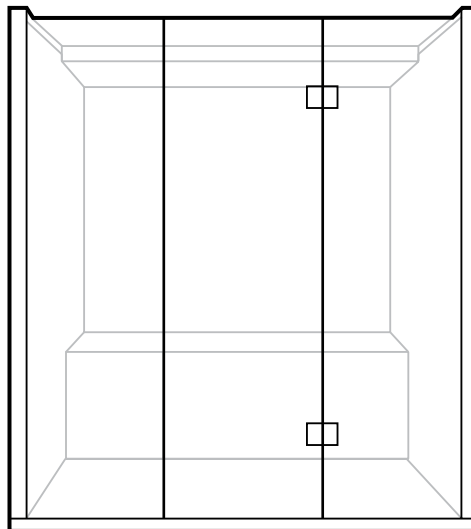

Assembly Instructions Cont'd

13 - CONNECT HEATERS IN ROOF

1. Locate the "trap" doors that open in the wood roof.
2. Connect the black and white cables that come out of the side wall to the connector located in the wood roof.
3. Connect the green ground wire that come out of the side wall to the green ground wire that is in the wood roof. Push the wiring inside the roof area and close the roof door compartments.
4. In the left side wall compartment, there will be two connectors: 1) Heater connector. 2) Keypad connector. The heater connector is a two wire connector. The keypad connector is a seven wire connector.

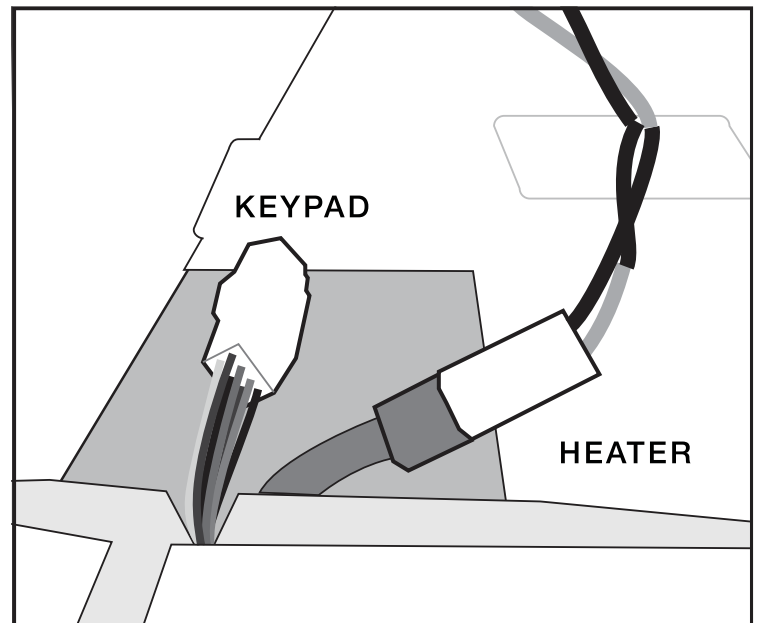

BE SURE TO MATCH THE COLORS IN THE CONNECTORS.
THE BLACK WIRE SHOULD MATCH UP WITH THE BLACK WIRE, ETC.

14 - INSTALLING DOOR HANDLE

1. Locate the door handle.
2. Attach the door handle using the enclosed screws.

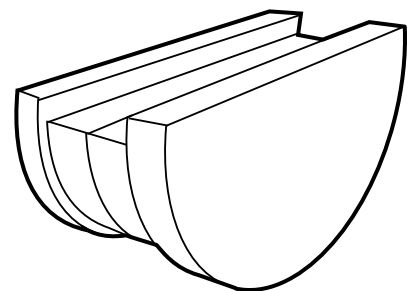

Note: If you are using a tablet or smartphone to control your sauna, the door handle will act as both the door handle and tablet/smartphone holder when the door is closed.

Assembly Instructions Cont'd

15 - INSTALLING FRONT HEATERS

1. Locate the two front heaters.
2. Align the left front heater and plug the connector that comes out of the bottom of the heater into the plug coming out of the in the floor.
3. Align the the hole in the back of the heater with the hole in the front wall glass. Using the included screws and washers, secure the heater to the glass through the pre-drilled hole. One washer will be placed on the inside and one on the outside glass. The heater will be secured with these screws in two locations.
4. Repeat this step for the right front heater.

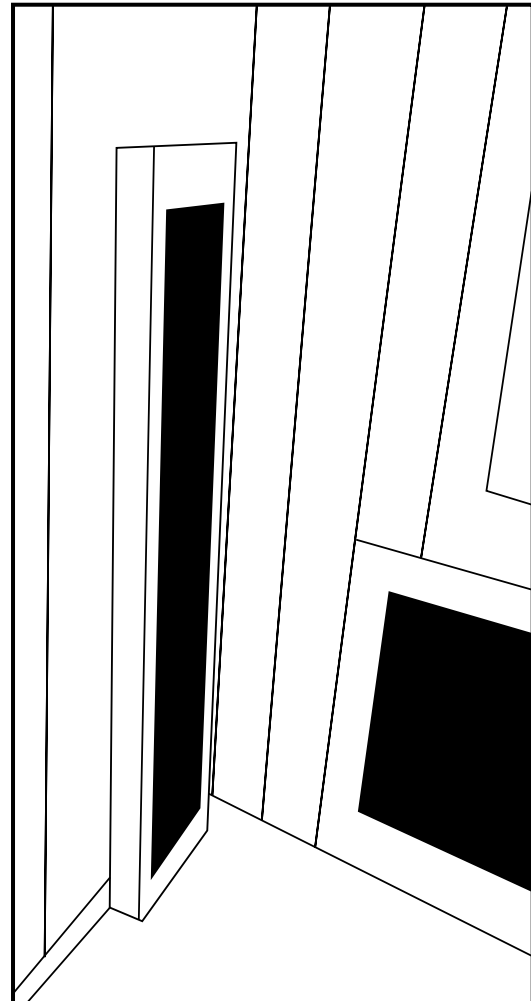
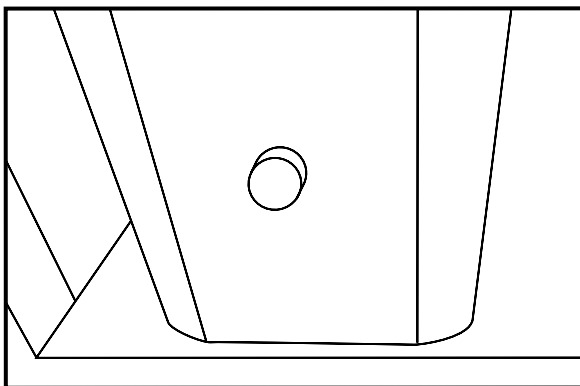
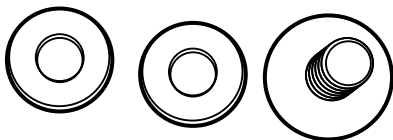
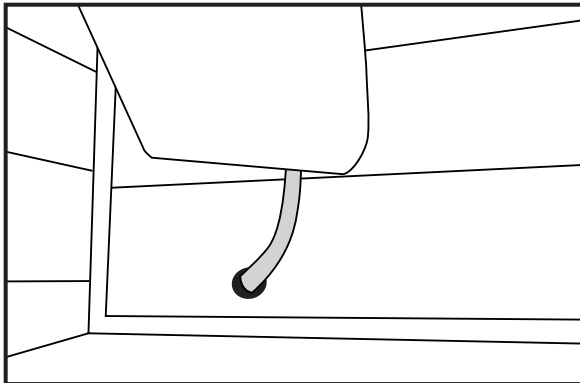

Front
Heater
Installed

Assembly Instructions Cont'd

15 - INSTALLING FRONT HEATERS

- Once both heaters are installed carefully push the included Full Spectrum Heater guards securely over each of the front heaters. The full spectrum heaters are hot to the touch when running and this will prevent burning should you get close to the heater.

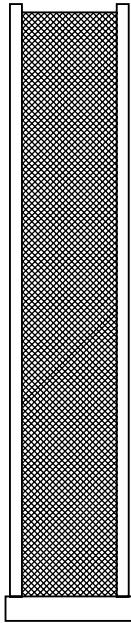

Warning Notice: The infrared heaters in your sauna are a potential BURN HAZARD. Do NOT touch the infrared heaters when they are in operation and allow to cool before servicing.

16 - LOCATING AND PLUGGING IN POWER CORD

The power cord comes out of the roof of the sauna. If you are standing facing the sauna, it comes out of the rear left corner of the roof. Open the trap door to access the power cord and run the cord down the back of the sauna. The power cord will plug into the appropriate electrical receptacle.



Note: We do not recommend using an extension cord for your sauna. Please plug the sauna directly into the wall receptacle.

Assembly Instructions Cont'd

17 - INSTALLATION IS COMPLETE

Installation of your sauna is now complete. Using a damp cloth, wipe out the sauna to remove any excess saw dust that may have settled on the wall & floor panels and the heater panels during manufacturing and shipping.

Please refer to usage instructions located later on in this manual.

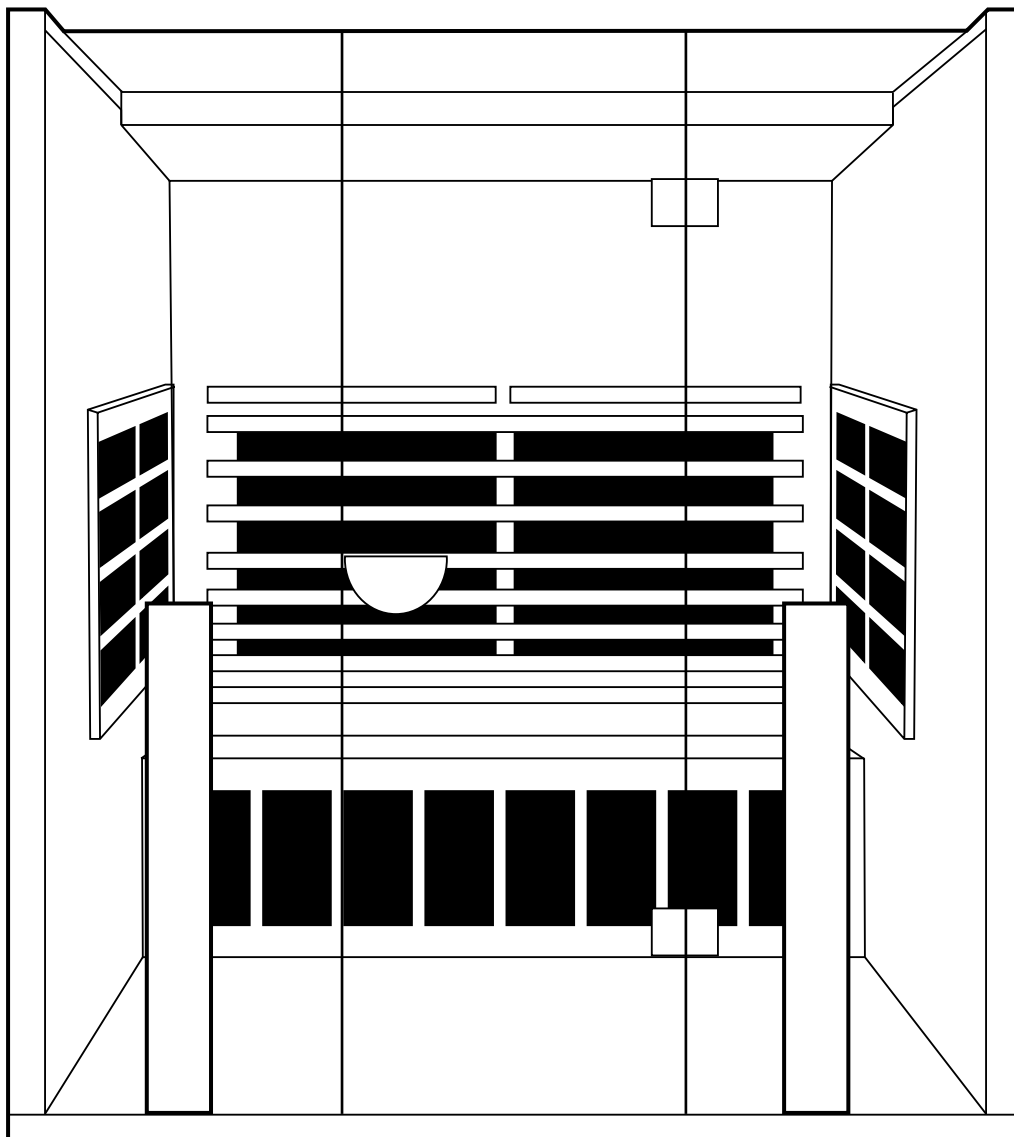



04

SANCTUARY Y

Packaging	-----	48
Assembly Instructions	-----	49

Packaging

CONTENTS OF BOXES

Box 1 of 4

1. Floor Panel
2. Ceiling Panel
3. Accessories
4. Installation Manual

Box 2 of 4

1. Left Side Wall
2. Right Side Wall

Box 3 of 4

1. Front Wall Glass
2. Back Wall
3. Bench & Bench Support

Box 4 of 4

1. Front Heaters

ACCESSORY BOX CONTENTS

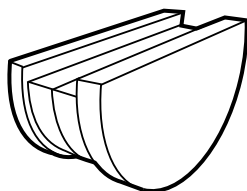

Door Handle

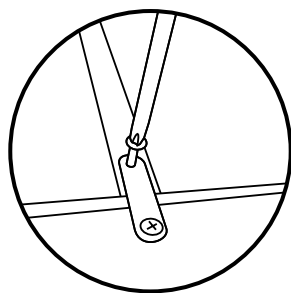

Wall Security Bracket (4 pieces)

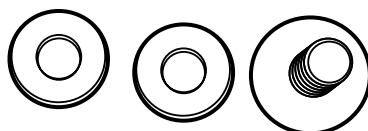

Front Heater Mounting Screws (4 sets)

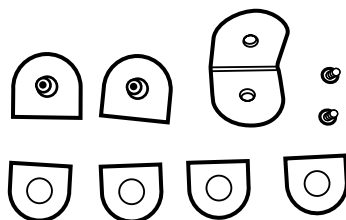

Glass Security Brackets (2 sets)

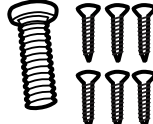
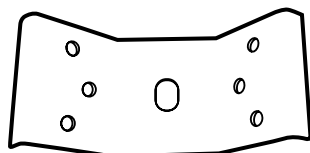

Bench Metal Brackets (4 sets)

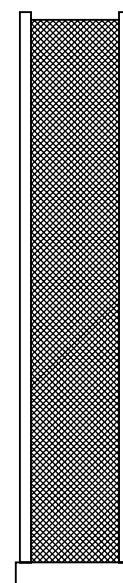

Full Spectrum Heater Guard (2 pieces)

Assembly Instructions

Assembly of the sauna requires two adults to complete. Please read the instructions thoroughly before and during assembly to ensure proper installation of the unit. If you encounter any problems or have questions during assembly, please feel free to call our Customer Service department at 1-800-798-1779 or +1-510-601-1775.

1 - LOCATION OF SAUNA & INSTALLATION ORDER

When determining a location for your sauna, please keep in mind the following:

1. The main power cord on the sauna must be easily accessible.
2. The location must be dry and level.
3. Panels should be installed in the following order:

- | | | |
|-------------------|------------------------|---------------------|
| 1) Floor | 4) Right Side Wall | 7) Wood Roof |
| 2) Back Wall | 5) Under Bench Support | 8) Glass Roof |
| 3) Left Side Wall | 6) Bench | 9) Front Wall Glass |

2 - PLACING FLOOR PANEL

1. Place the bottom floor panel on the ground near the location you will using the sauna. Make sure the front of the floor is in the desired location of the door. The two plugs and the door magnet indicate the front of the sauna.

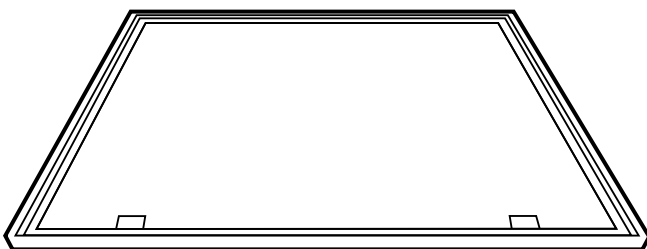

3 - CONNECTING THE BACK PANEL TO THE FLOOR PANEL

1. Connect the back panel to the floor panel by lining up the back panel on the groove of the floor panel. Connect the cables coming out of the floor to the cables coming out of the back wall panel as you insert the wall into the groove.

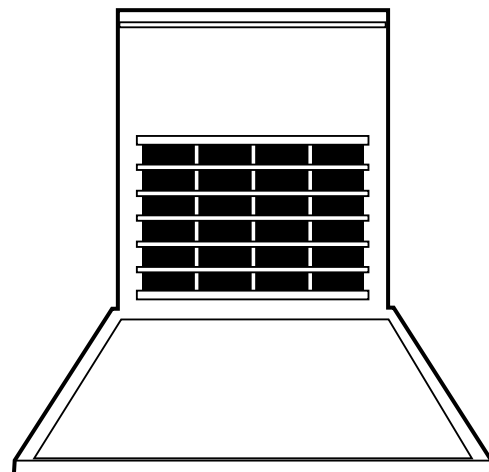

Assembly Instructions Cont'd

4 - CONNECTING SIDE WALLS

The side wall panels will be connected to the back wall by connecting together the installed brackets. There are "+" brackets and "-" brackets on the side of each panel. The side walls will be installed as follows:

1. Place the left side wall in the slot in the floor. Lift the side wall up about 4" (10cm) higher than the backwall panel (See Picture 1).
2. Place the side wall panel against the back wall (See Picture 2), then slide down side wall panel until the two panels are equal height. (See Picture 3).
3. If the panels are not equal height or there is an obvious gap between the two panels, this means they are not properly attached and you should try again.

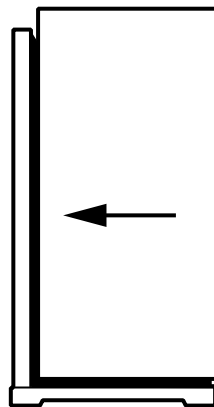

Picture 1

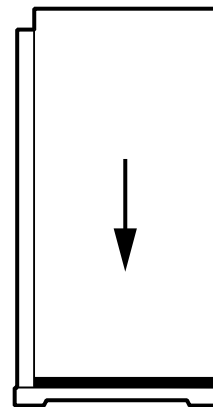

Picture 2

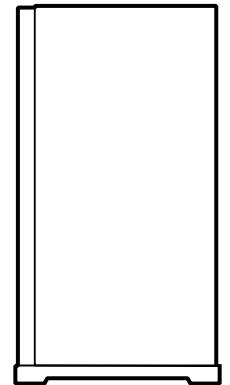

Picture 3



If the panels still seem too tight to come down all the way, try backing off the bracket screws by one half turn with a Phillips head screwdriver on the female bracket.

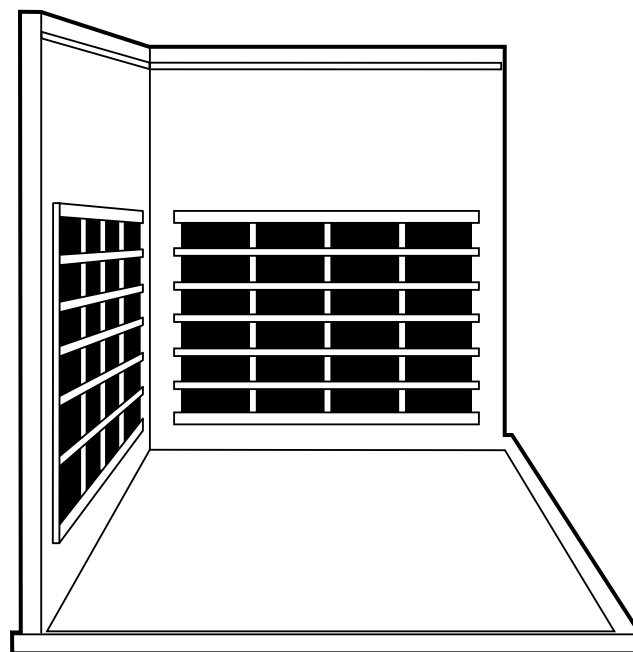

Left Side Wall Installed

Assembly Instructions Cont'd

5 - INSTALLING RIGHT SIDE WALL

Install the right side wall in the same manner as the left side wall.

1. Place the right side wall in the slot in the floor. Lift the side wall up about 4" (10cm) higher than the backwall panel (See Picture 1).
2. Place the side wall panel against the back wall (See Picture 2), then slide down side wall panel until the two panels are equal height. (See Picture 3).
3. If the panels are not equal height or there is an obvious gap between the two panels, this means they are not properly attached and you should try again.

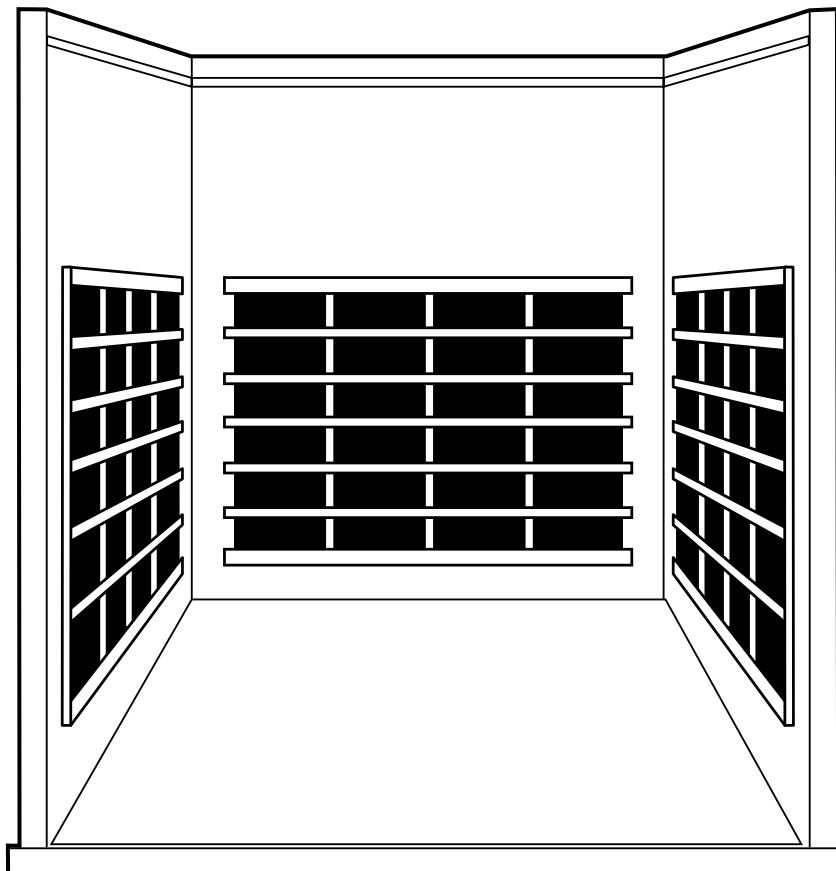

Right Side Wall Installed

Assembly Instructions Cont'd

6 - INSTALLING WOOD PORTION OF ROOF

1. Set the wood portion of the roof on the back roof guide. Be sure to slide the roof back against the back wall.

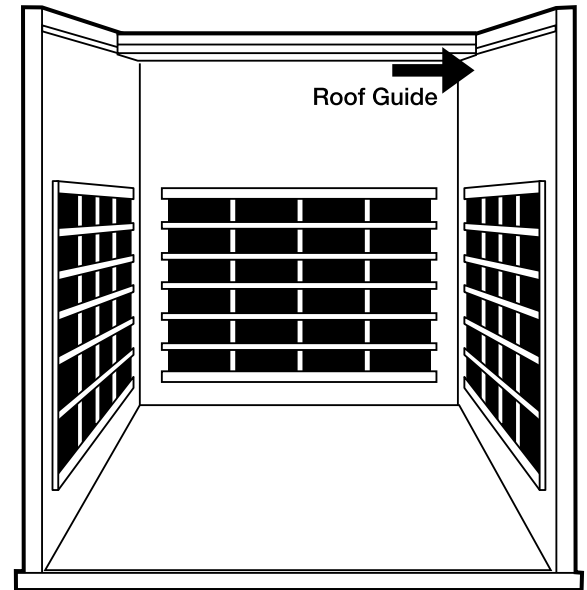

7 - INSTALLING GLASS PORTION OF ROOF

1. Place the glass roof portion on the front roof guides. Be sure that it is pushed firmly back against the wood roof portion.

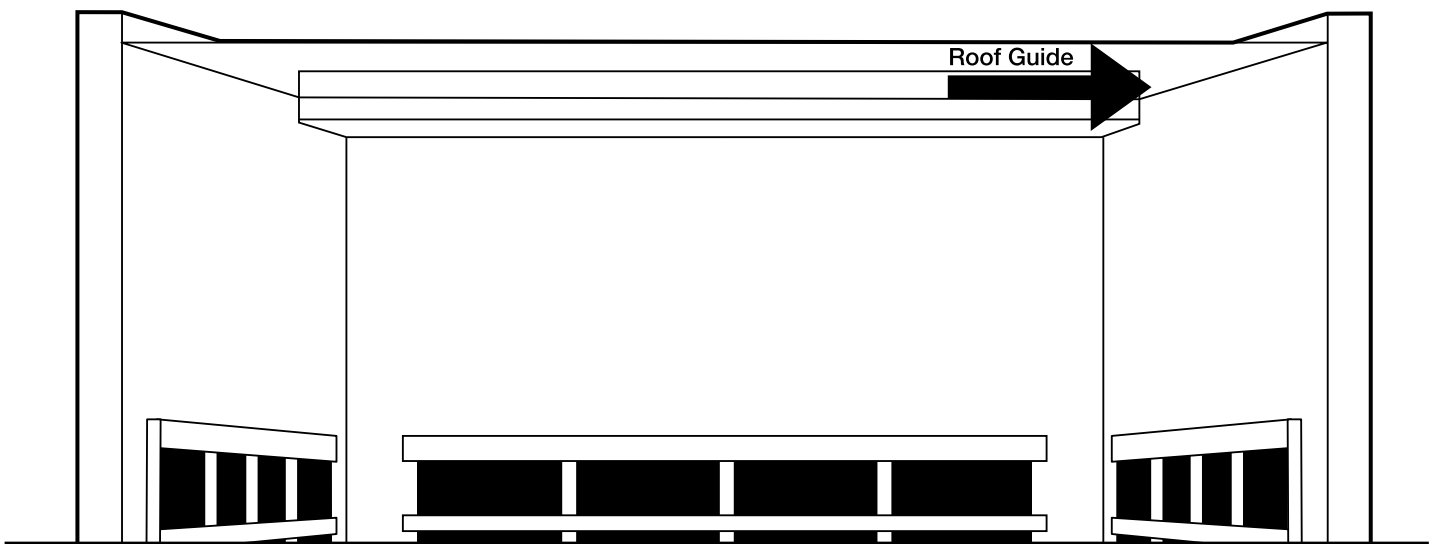

Assembly Instructions Cont'd

8 - INSTALLING WALL LOCKS



**THIS STEP IS VERY IMPORTANT.
PLEASE DO NOT OMIT THIS STEP.**

1. The side walls must be secured to the back wall and wood roof piece using the attached eye hooks.
2. Screw in one of the eye hooks between the left side wall and backwall and one between the right side wall and backwall.
3. Secure one of the eye hooks between the left side wall and top front of the wood roof piece and one between the right side wall and the top front of the wood roof piece.

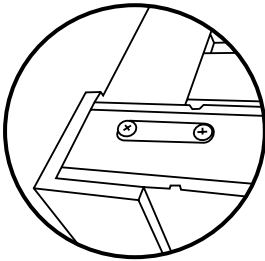

Attach eye hook so that it is screwed into both the side walls and back walls.

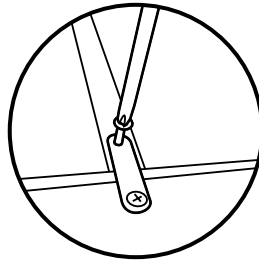

Attach the eye hook so that it is screwed into side walls and the wood roof piece.

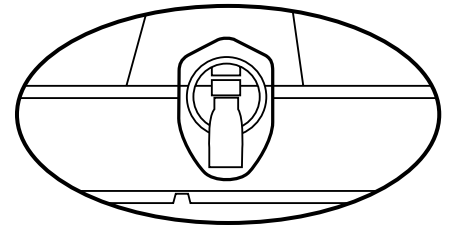

9 - ASSEMBLING BENCHES

1. The Sanctuary Y - FS comes with two benches. The benches are identical. Please located the pieces for one bench as shown below:

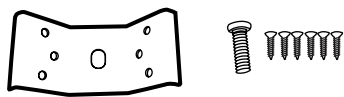

(4 x)

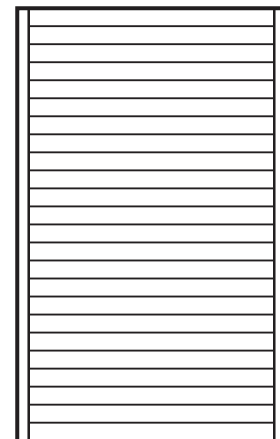
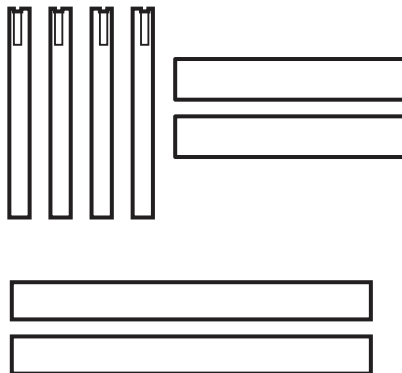

(4 x legs, 2 x long side supports, 2 x short side supports)

Assembly Instructions Cont'd

9 - ASSEMBLING BENCH'S CONTINUED

2. Line up the two long side support, two short side supports and four legs as shown in the image below:

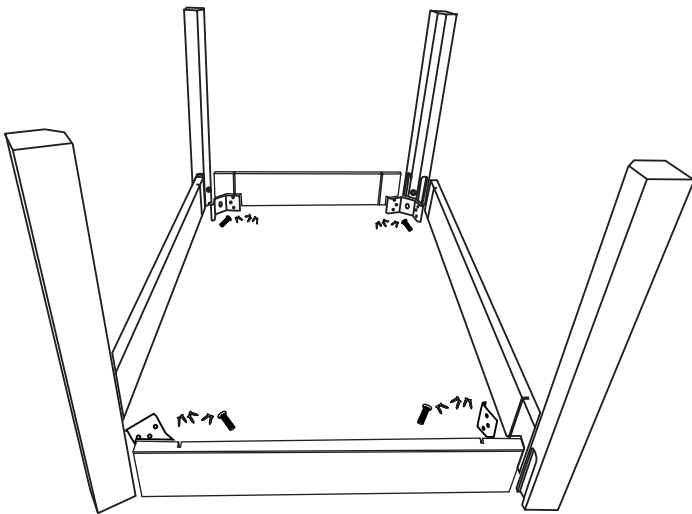

3. Insert the side pieces into the slots in the legs

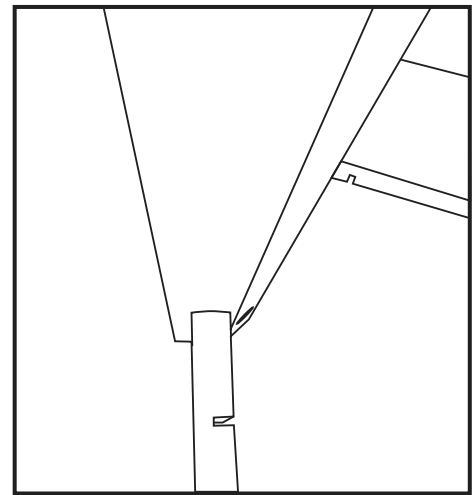

4. Place one of the metal brackets in one of the corners of the bench support frame as show below:

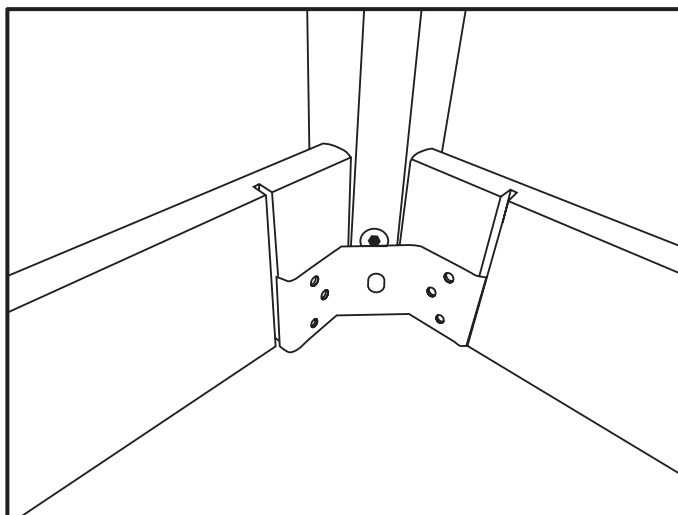

Assembly Instructions Cont'd

9 - ASSEMBLING BENCH'S CONTINUED

5. Line up the hole in the bracket with the screw thread in the leg piece and screw one of the bolts into the leg piece. Be sure that the bracket ends are inserted into the groove of the side support pieces.

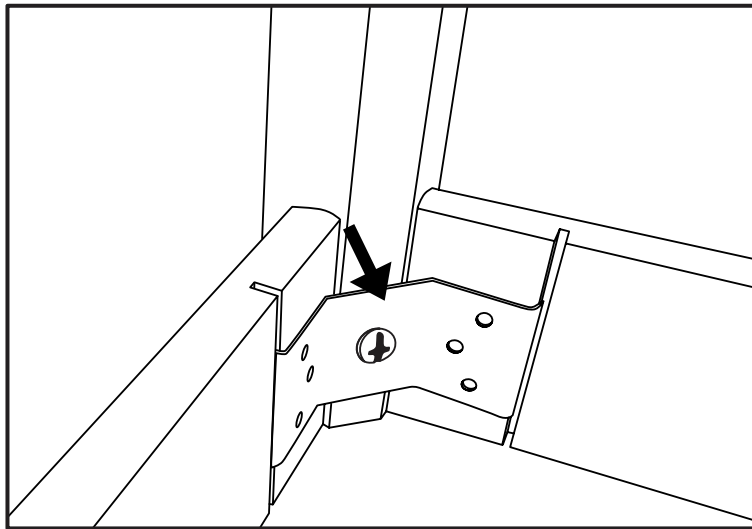

6. Repeat this for all four legs.
7. Using 6 x wood screws for each bracket, screw the wood screws into the bracket to secure it to the side support pieces.

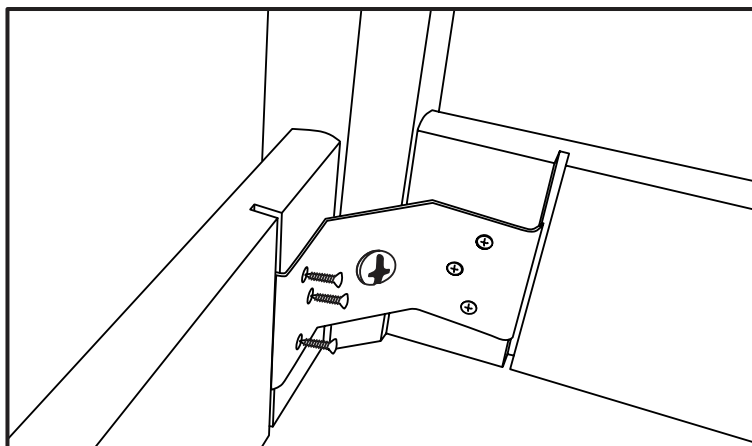

Assembly Instructions Cont'd

9 - ASSEMBLING BENCH'S CONTINUED

8. Locate the bench top

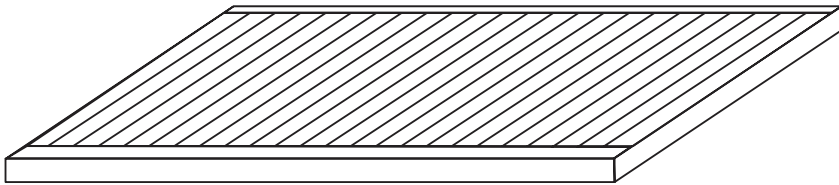

9. Turn the bench top upside down as in the drawing below:

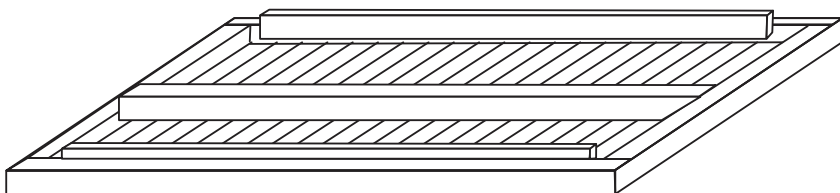

Assembly Instructions Cont'd

9 - ASSEMBLING BENCH'S CONTINUED

10. Place the frame support piece completed in steps 1-7 on the bottom side of the bench top.

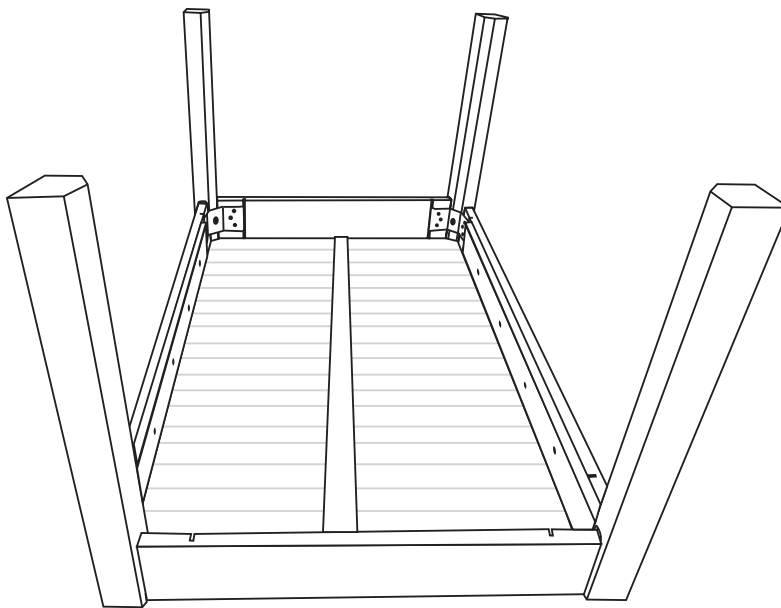

11. Locate the bag with 6 x wood screws.

Assembly Instructions Cont'd

9 - ASSEMBLING BENCH'S CONTINUED

12. Screw the bench top into the long side supports using the pre-drilled holes as guides.

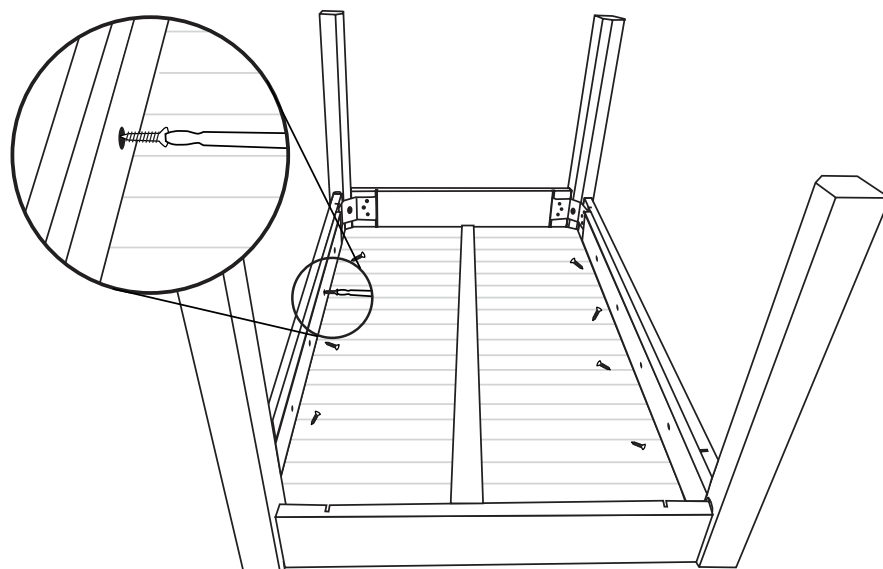

13. The bench is complete

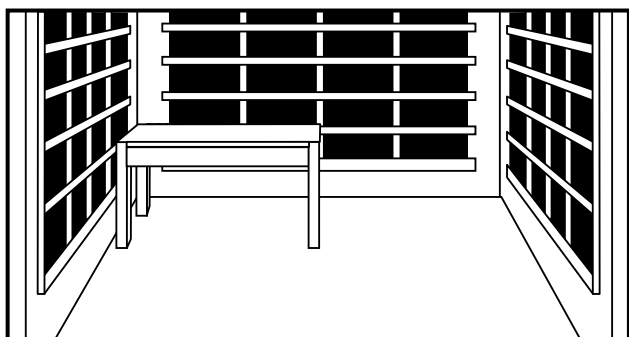

14. Repeat steps 1-13 for the second bench.

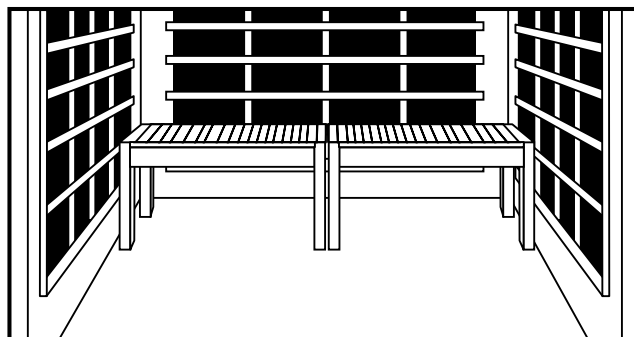

Assembly Instructions Cont'd

10 - INSTALLING RIGHT SIDE GLASS WINDOW

1. We recommend using two people to move the glass door and right window piece. Place the glass door with left window in the groove in the floor and slide it securely into place against the left wall. It may help to put the corner of the glass in place first then put the rest of the glass in the slot. **Until this piece is secured as in step 2 below using the included brackets, please hold this piece in place.**
2. Secure the left side glass window to the roof glass using the included brackets. You will see pre-drilled holes in both the front glass and roof glass. One person should hold the outside piece while the other person screws in the bolt.

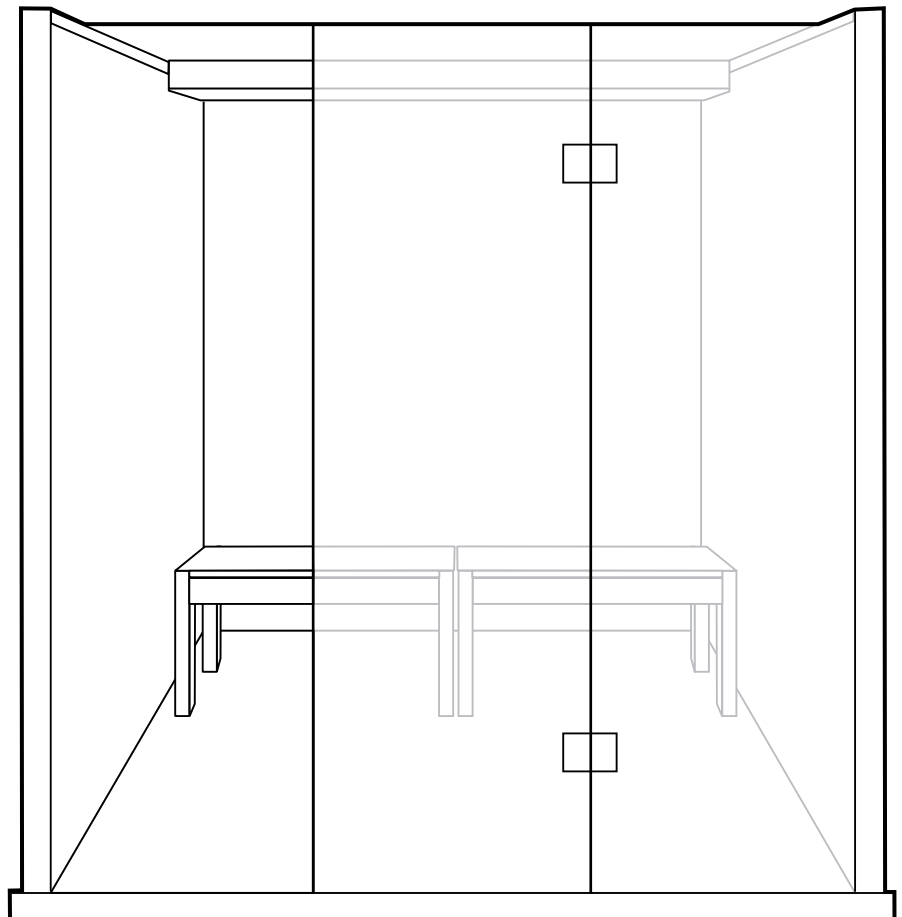
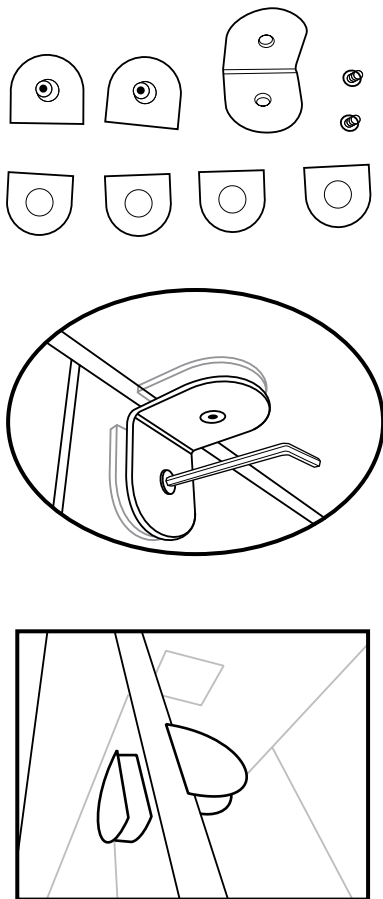

Door and Right Front Wall Installed

Assembly Instructions Cont'd

11 - INSTALLING LEFT SIDE GLASS WINDOW

1. Open the door of the sauna to allow room to place the left side glass window.
2. Place the left side glass window and push it against the left side wall so it is securely in place. Until this piece is secured using the enclosed brackets, someone should hold the piece in place.
3. Secure the left front glass window to the roof glass using the included brackets. You will see pre-drilled holes in both the front glass and roof glass.

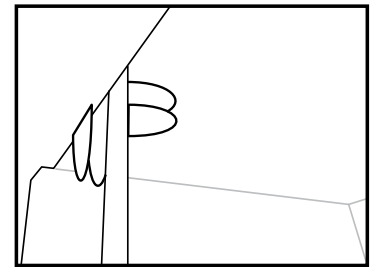
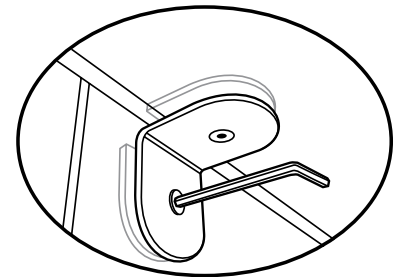
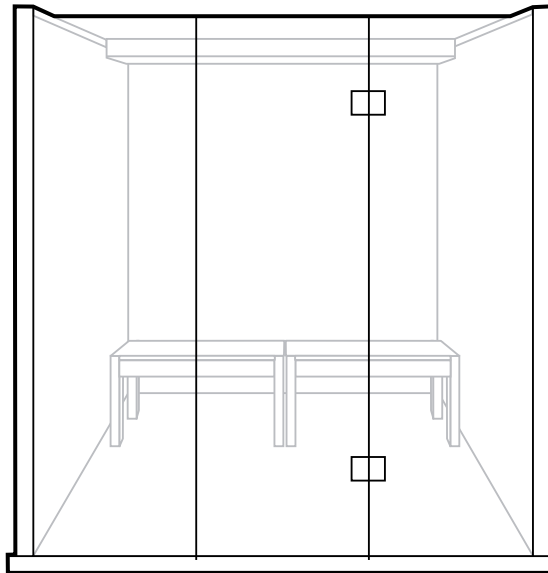

Front Wall
Installed

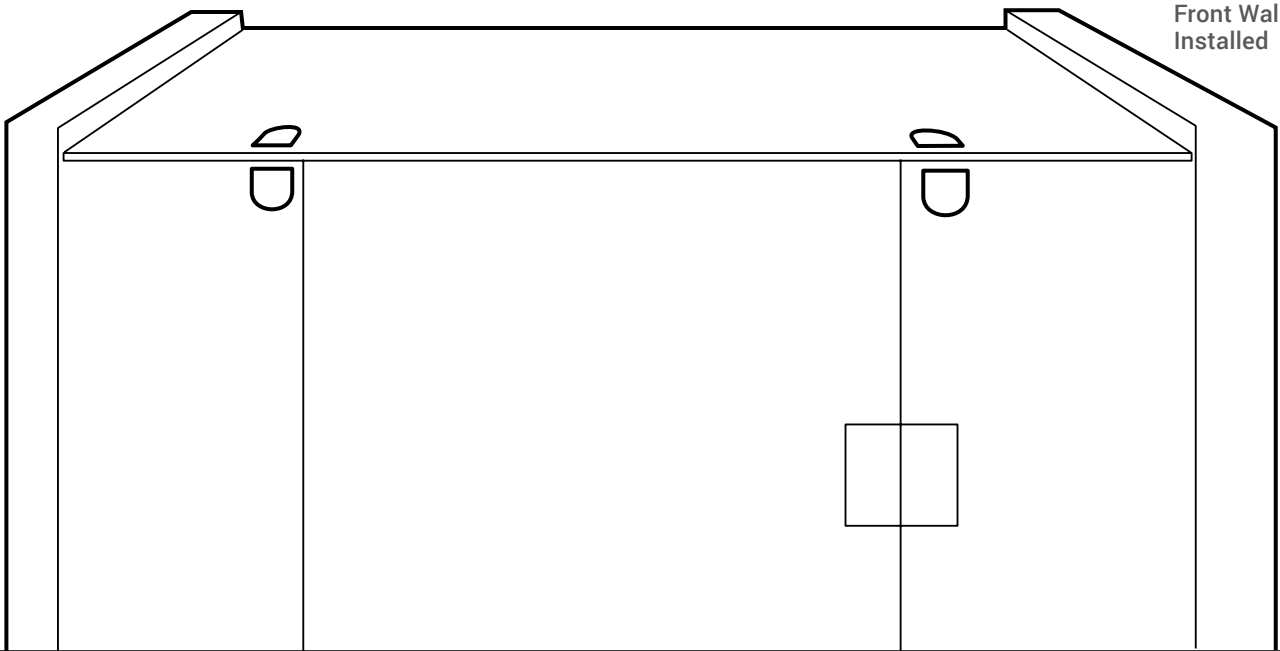

Assembly Instructions Cont'd

12 - CONNECT HEATERS IN ROOF

1. Locate the “trap” doors that open in the wood roof.
2. Connect the black and white cables that that come out of the side wall to the connector located in the wood roof.
3. Connect the green ground wire that come out of the side wall to the green ground wire that is in the wood roof.

Push the wiring inside the roof area and close the roof door compartments.

4. In the left side wall compartment, there will be two connectors: 1) Heater connector. 2) Keypad connector. The heater connector is a two wire connector. The keypad connector is a seven wire connector.

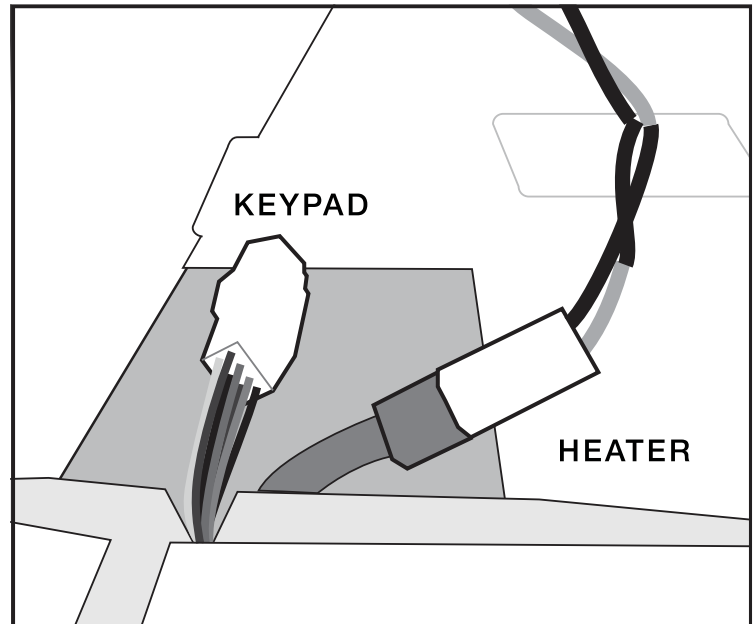

BE SURE TO MATCH THE COLORS IN THE CONNECTORS.
THE BLACK WIRE SHOULD MATCH UP WITH THE BLACK WIRE, ETC.

13 - INSTALLING DOOR HANDLE

1. Locate the door handle.
2. Attach the door handle using the enclosed screws.

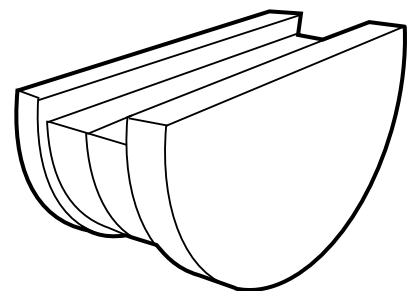

Note: If you are using a tablet or smartphone to control your sauna, the door handle will act as both the door handle and tablet/smartphone holder when the door is closed.

Assembly Instructions Cont'd

14 - INSTALLING FRONT HEATERS

1. Locate the two front heaters.
2. Align the left front heater and plug the connector that comes out of the bottom of the heater into the plug coming out of the in the floor.
3. Align the the hole in the back of the heater with the hole in the front wall glass Using the enclosed screws and washers, secure the heater to the glass through the pre-drilled hole. One washer will be placed on the inside and one on the outside glass. The heater will be secured with these screws in two locations.
4. Repeat this step for the right front heater.

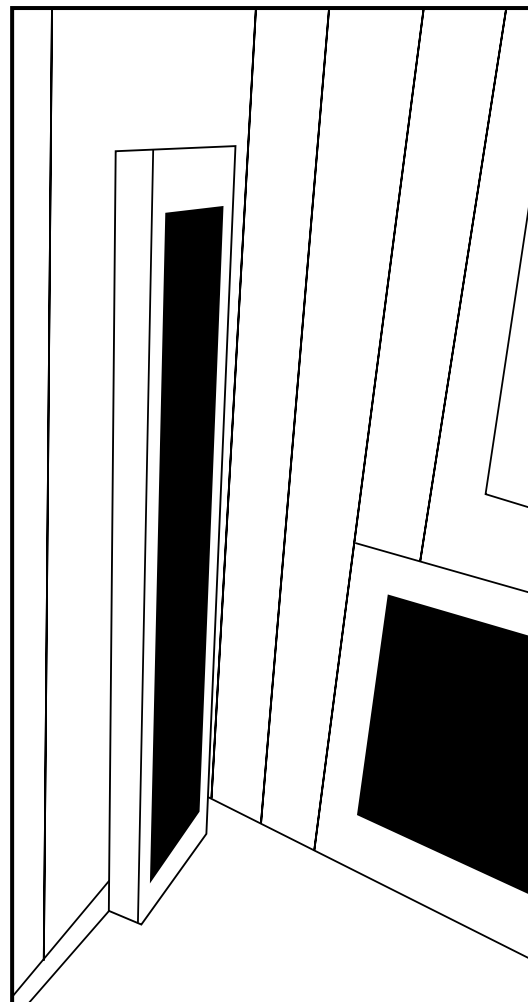
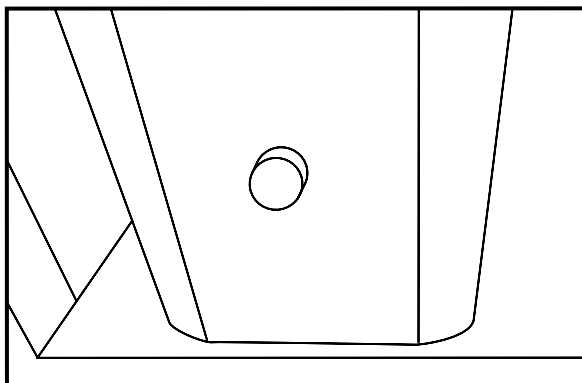
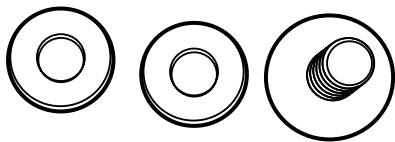
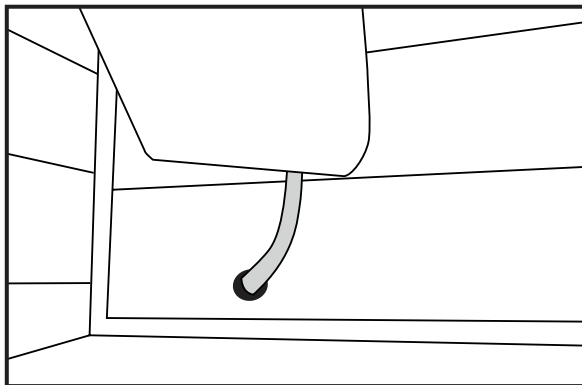

Front
Heater
Installed

Assembly Instructions Cont'd

14 - INSTALLING FRONT HEATERS

5. Once both heaters are installed carefully push the included Full Spectrum Heater guards securely over each of the front heaters. The full spectrum heaters are hot to the touch when running and this will prevent burning should you get close to the heater.

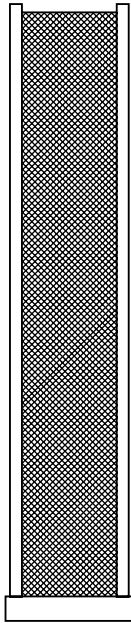

Warning Notice: The infrared heaters in your sauna are a potential BURN HAZARD. Do NOT touch the infrared heaters when they are in operation and allow to cool before servicing.

15 - LOCATING AND PLUGGING IN POWER CORD

The power cord comes out of the roof of the sauna. If you are standing facing the sauna, it comes out of the rear left corner of the roof. Open the trap door to access the power cord and run the cord down the back of the sauna. The power cord will plug into the appropriate electrical receptacle.



Note: We do not recommend using an extension cord for your sauna. Please plug the sauna directly into the wall receptacle.

Assembly Instructions Cont'd

16 - INSTALLATION IS COMPLETE

Installation of your sauna is now complete. Using a damp cloth, wipe out the sauna to remove any excess saw dust that may have settled on the wall & floor panels and the heater panels.

Please refer to usage instructions located later on in this manual.

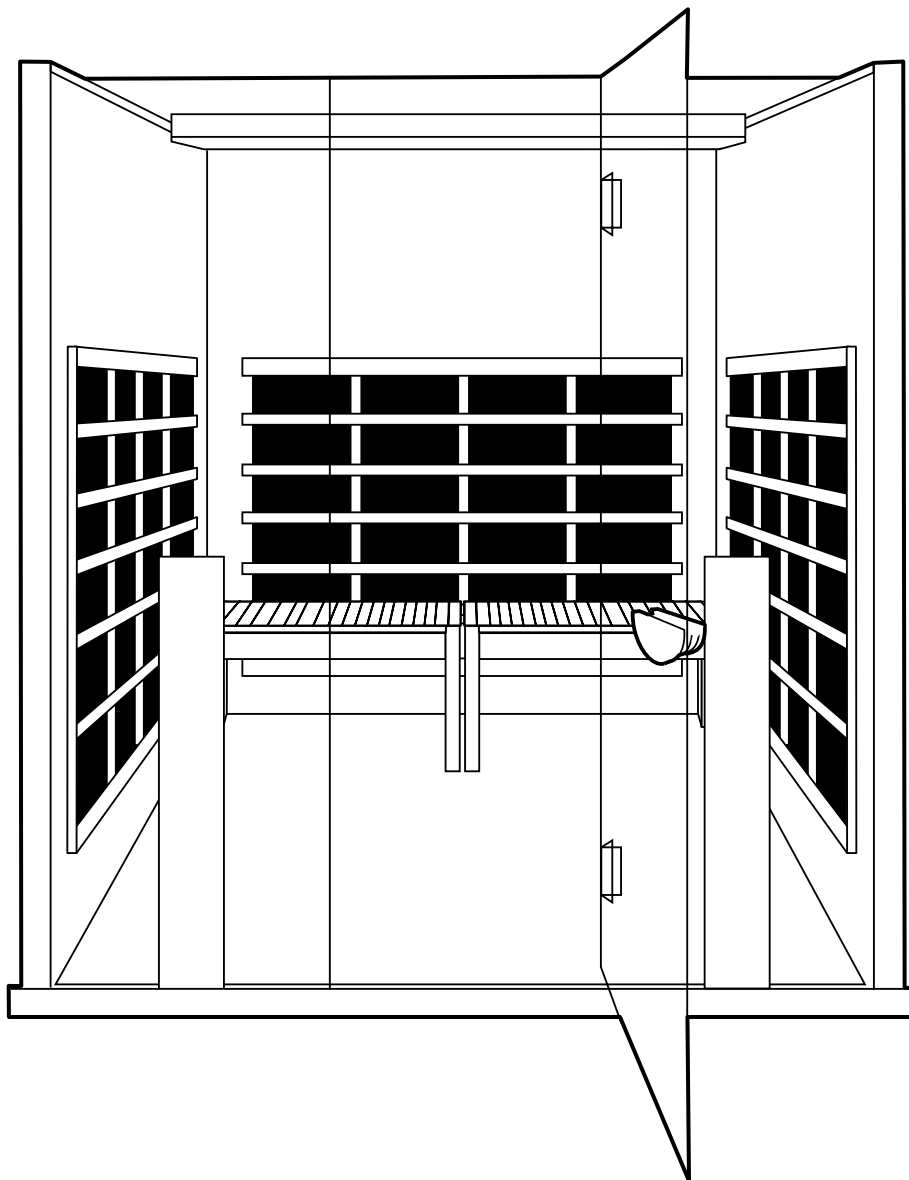



05 | SANCTUARY C

Packaging	-----	66
Assembly Instructions	-----	67

Packaging

CONTENTS OF BOXES

Box 1 of 4

1. Floor Panel
2. Ceiling Panel
3. Accessories
4. Installation Manual

Box 2 of 4

1. Left Side Wall
2. Right Side Wall

Box 3 of 4

1. Front Wall Glass
2. Back Wall
3. Bench & Bench Support

Box 4 of 4

1. Front Heaters

ACCESSORY BOX CONTENTS

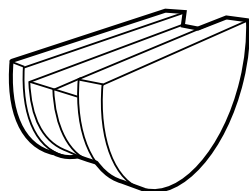

Door Handle

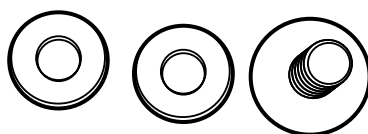

Front Heater
Mounting Screws
(4 sets)

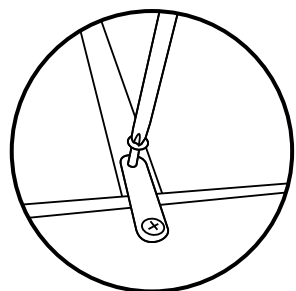

Wall Security
Bracket (4 pieces)

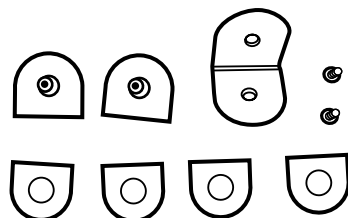

Glass Security
Brackets (2 sets)

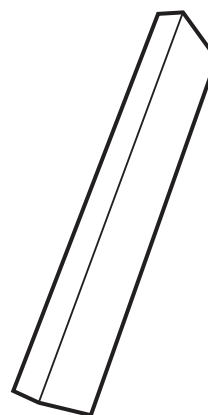

Wood piece
(2 pieces)

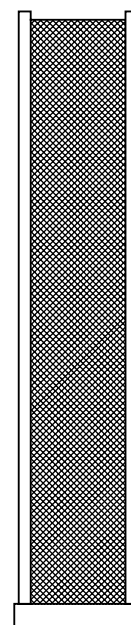

Full Spectrum
Heater Guard (2 pieces)

Assembly Instructions

Assembly of the sauna requires two adults to complete. Please read the instructions thoroughly before and during assembly to ensure proper installation of the unit. If you encounter any problems or have questions during assembly, please feel free to call our Customer Service department at 1-800-798-1779 or +1-510-601-1775.

1 - LOCATION OF SAUNA & INSTALLATION ORDER

When determining a location for your sauna, please keep in mind the following:

1. The main power cord on the sauna must be easily accessible.
2. The location must be dry and level.
3. Panels should be installed in the following order:

- | | | |
|-------------------|------------------------|---------------------|
| 1) Floor | 4) Right Side Wall | 7) Wood Roof |
| 2) Back Wall | 5) Under Bench Support | 8) Glass Roof |
| 3) Left Side Wall | 6) Bench | 9) Front Wall Glass |

2 - PLACING FLOOR PANEL

1. Place the bottom floor panel on the ground near the location you will using the sauna. Make sure the front of the floor is in the desired location of the door. The two plugs and the door magnet indicate the front of the sauna.

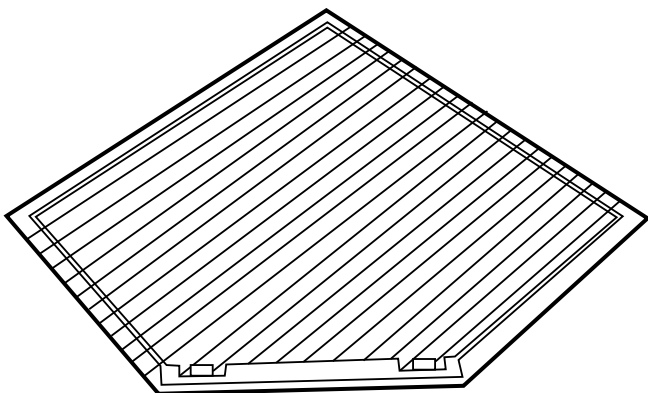

3 - CONNECTING THE LEFT BACK PANEL TO THE FLOOR

1. Place the Left Back panel on the floor panel by lining up the back panel on the groove of the floor panel.

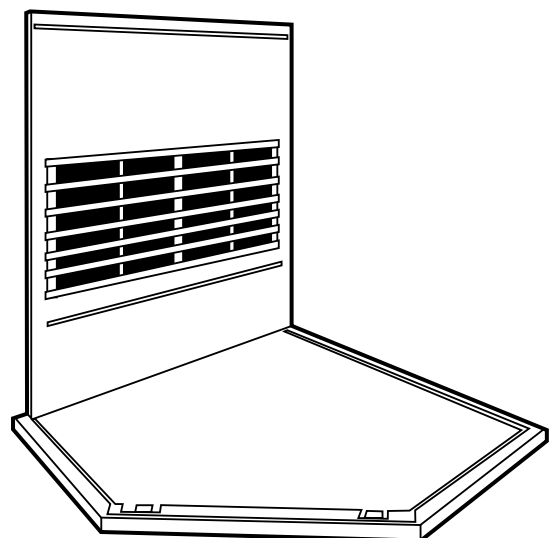

Assembly Instructions Cont'd

4 - CONNECTING THE RIGHT BACK PANEL

1. Place the Right Backwall in the slot in the floor.

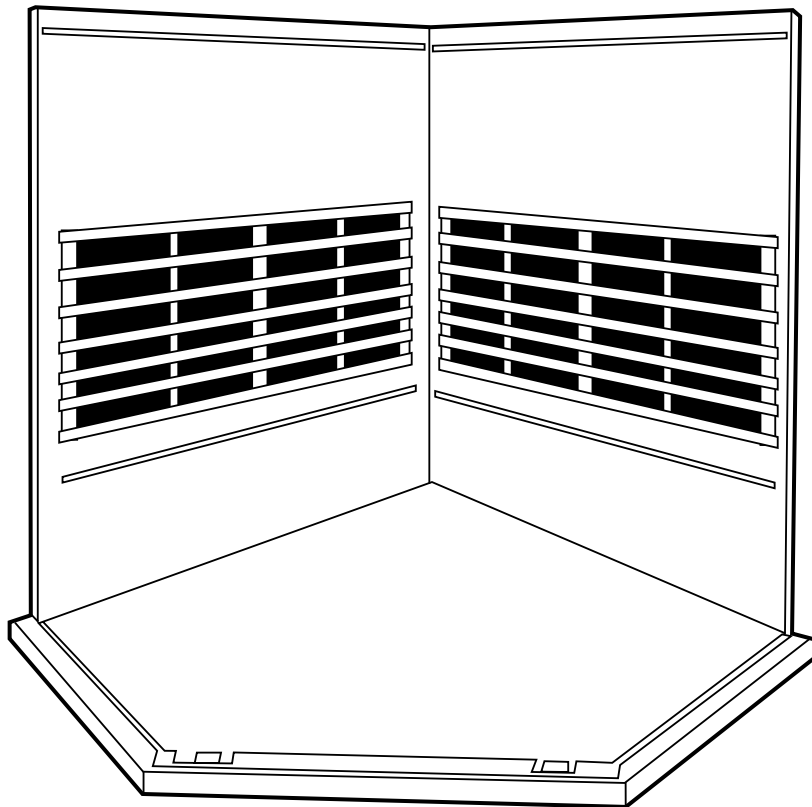

Left and Right Backwalls Installed

Assembly Instructions Cont'd

5 - INSTALLING UNDER BENCH SUPPORT

Locate the long under bench support (left side) and shorter under bench support (right side).

1. Install the left long under bench support first. Slide the bench support down by lining it up with the vertical guide on the right back wall panel.
2. Install the shorter right side under bench support by sliding it down the vertical guide on the long bench support that was just installed.
3. Be careful not to scratch the side panels while positioning the heater panel.
4. Make certain that the under bench supports are seated on the floor panel and are securely in place.

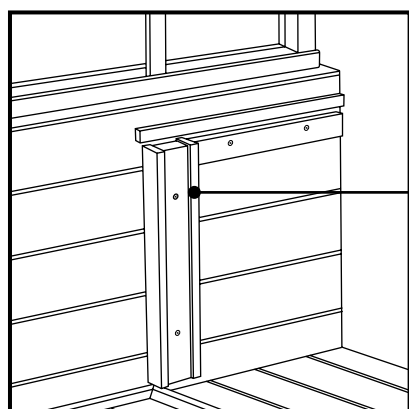

Heater must be facing outward

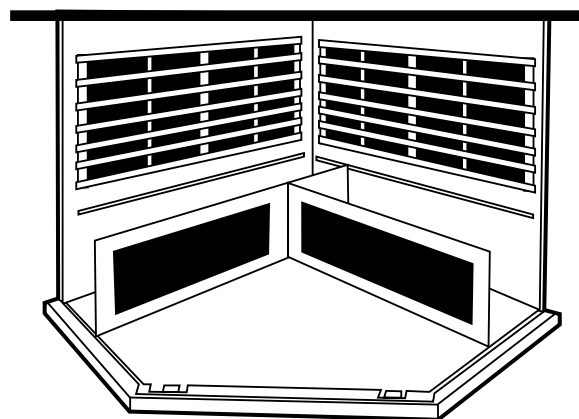
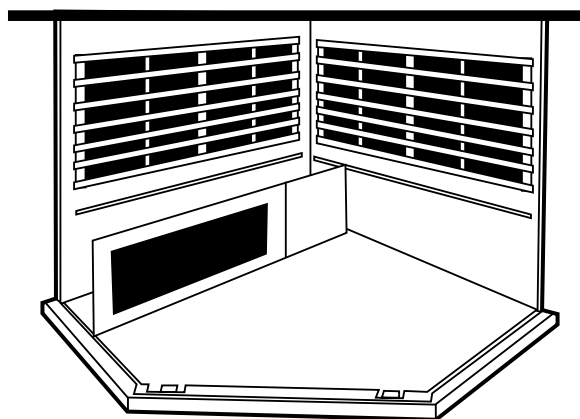
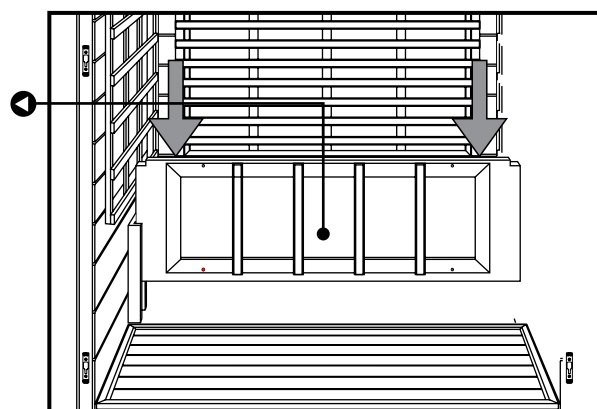

Assembly Instructions Cont'd

6 - INSTALL THE LEFT AND RIGHT SIDE WALLS

1. Place the left side wall in the slot in the floor. Lift the side wall up about 4" (10cm) higher than the backwall panel (See Picture 1).
2. Place the side wall panel against the back wall (See Picture 2), then slide down side wall panel until the two panels are equal height. (See Picture 3).



If the panels still seem too tight to come down all the way, try backing off the bracket screws by one half turn with a Phillips head screwdriver on the female brackets.

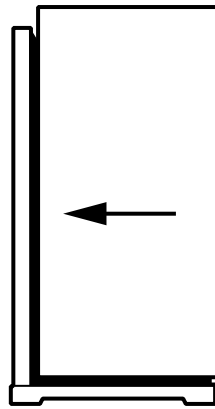

Picture 1

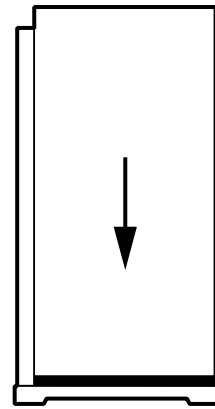

Picture 2

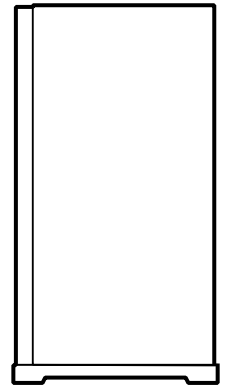

Picture 3

3. Repeat the steps above for the right side wall panel.

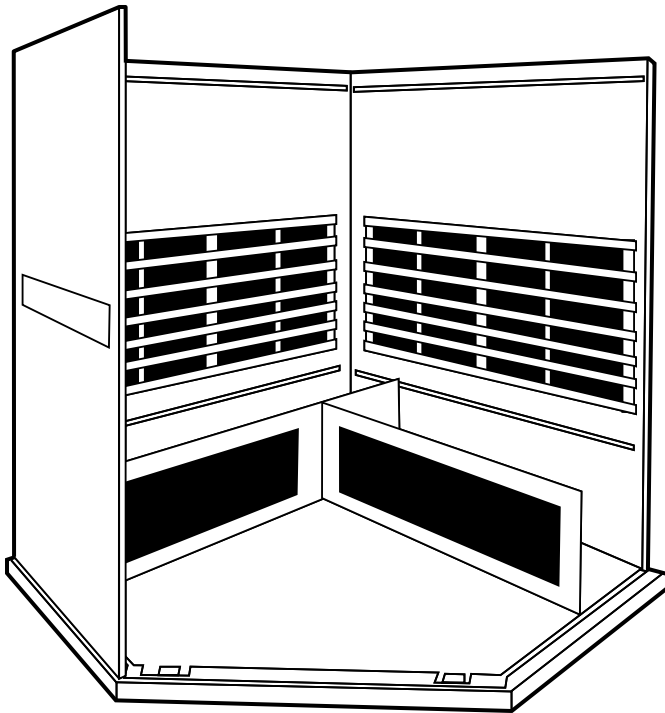

Left Side Wall Connected

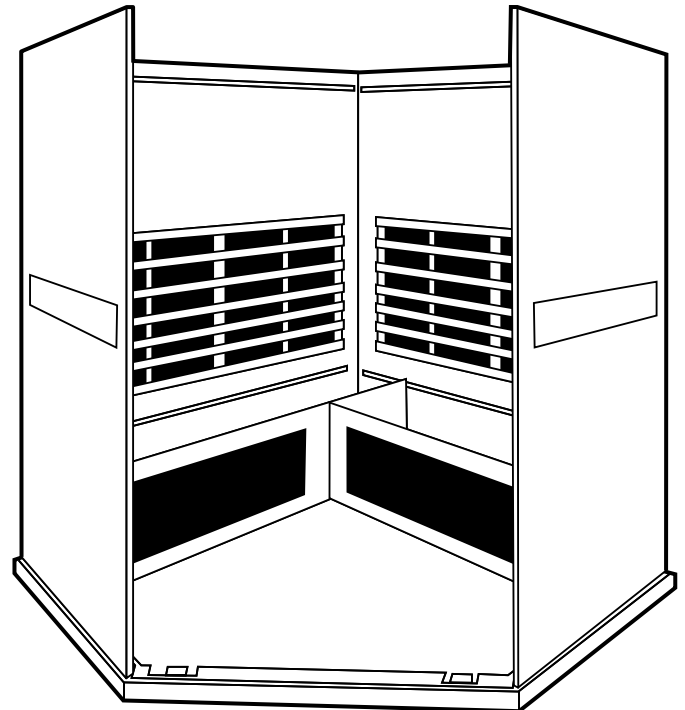

Right Side Wall Connected

Assembly Instructions Cont'd

7 - CONNECT HEATER CONNECTION UNDER BENCH

Follow the connections as in the following illustration:

1. Connect the black and white cable coming out of the back of the under bench support to one of the left side wall connectors.
2. Connect the side black and white wall cable to one of the floor connectors.
3. Connect the black and white back wall cable to the other floor connector.
4. Connect the green ground connectors together.



You can plug any male connector to a female one as long as the colors match.

5. The two remaining cables labeled "VRT" will be connected if Vibrational Resonance Therapy is being added to the sauna. If you did not add this to your sauna, these cables will not be used.

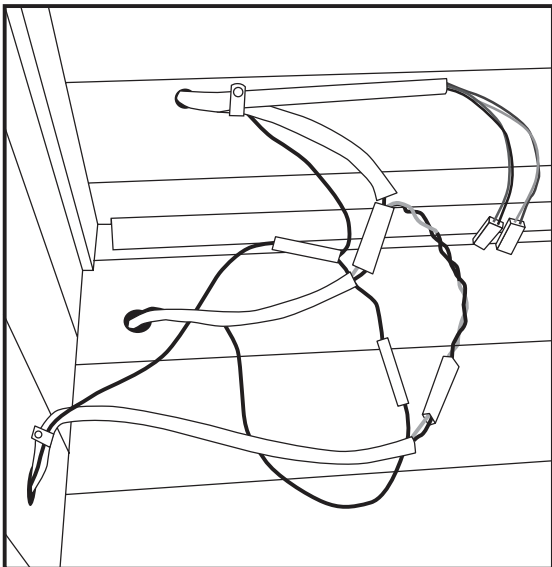

Left Bench Installed

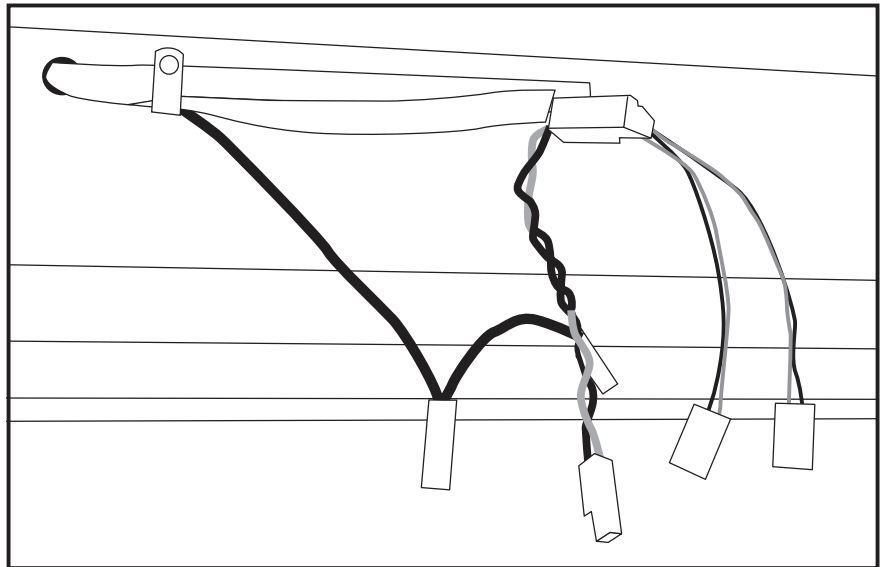

Right Bench Installed

Assembly Instructions Cont'd

8 - INSTALLING BENCH

Install the benches by sliding it over the horizontal bench guides on the back and side walls. Be careful not to scratch the adjacent panels when sliding in the bench.

Push the bench all the way in until it touches the back panel and is securely in place.

The bench is reversible. One side is ergonomic and one side is flat. You can reverse the bench after the sauna installation is finished. **Be sure that the bench is pushed all the way back until it slides under the heater guard to secure the bench in place.**

1. Install the long left side bench first.
2. Install the shorter right side bench second.

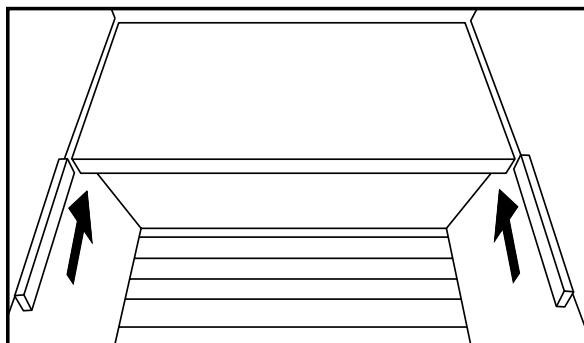
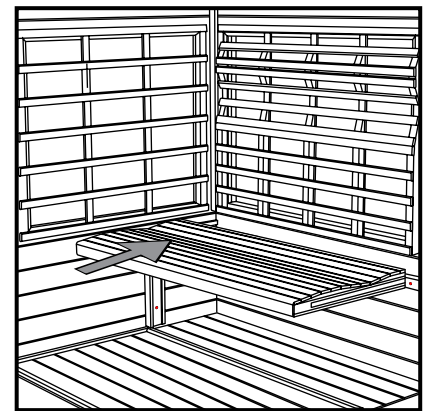
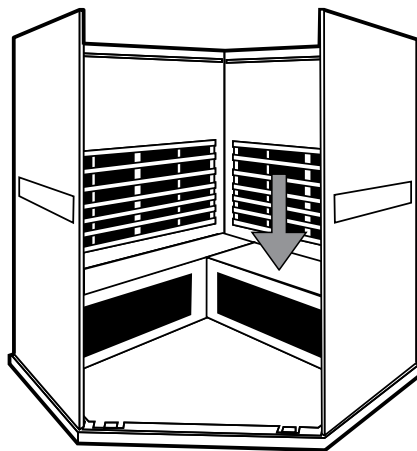
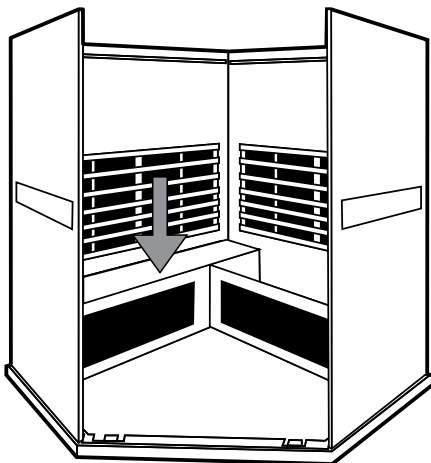

Optional: After the bench is installed, you can slide in the included wood pieces to prevent the bench from sliding left to right. One piece can be placed on each side next to the bench. If you decide to flip the reversible bench over, please remove the wood pieces first.

Assembly Instructions Cont'd

9 - INSTALLING WOOD PORTION OF ROOF

1. Set the wood portion of the roof on the back roof guide. Be sure to slide the roof back against the back wall.

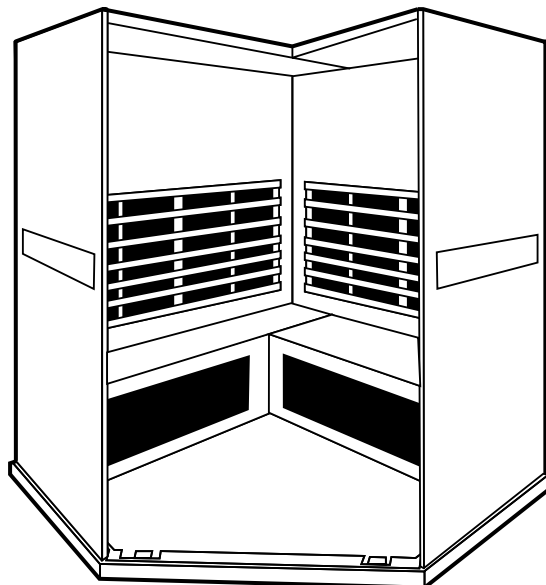

10 - INSTALLING WALL LOCKS



**THIS STEP IS VERY IMPORTANT.
PLEASE DO NOT OMIT THIS STEP.**

1. The side walls must be secured to the back wall and wood roof piece using the attached eye hooks.
2. Screw in one of the eye hooks between the left side wall and backwall and one between the right side wall and backwall.
3. Secure one of the eye hooks between the left side wall and top front of the wood roof piece and one between the right side wall and the top front of the wood roof piece.

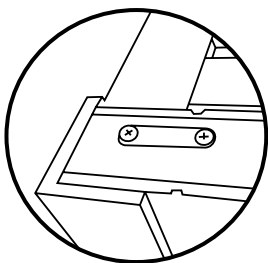

Attach eye hook so that it is screwed into both the side walls and back walls.

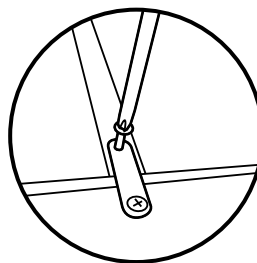

Attach the eye hook so that it is screwed into side walls and the wood roof piece.

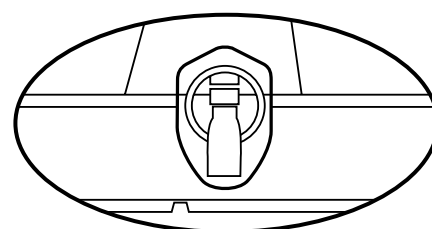

Assembly Instructions Cont'd

11 - INSTALLING GLASS PORTION OF ROOF

1. Place the glass roof portion on the front roof guides. Be sure that it is pushed firmly back against the wood roof portion.

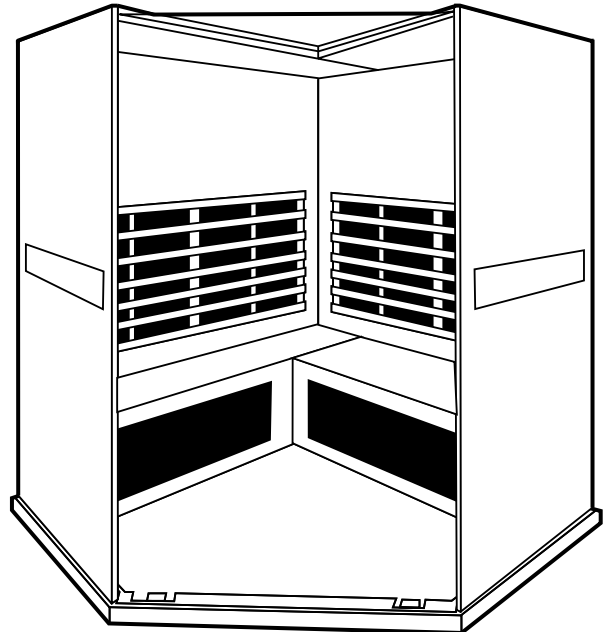

12 - INSTALLING GLASS DOOR AND RIGHT SIDE GLASS WINDOW

1. We recommend using two people to move the glass door and right window piece. Place the glass door with left window in the groove in the floor and slide it securely into place against the left wall. It may help to put the corner of the glass in place first then put the rest of the glass in the slot. **Until this piece is secured as in step 2 below using the included brackets, please hold this piece in place.**
2. Secure the left side glass window to the roof glass using the included brackets. You will see pre-drilled holes in both the front glass and roof glass. One person should hold the outside piece while the other person screws in the bolt.

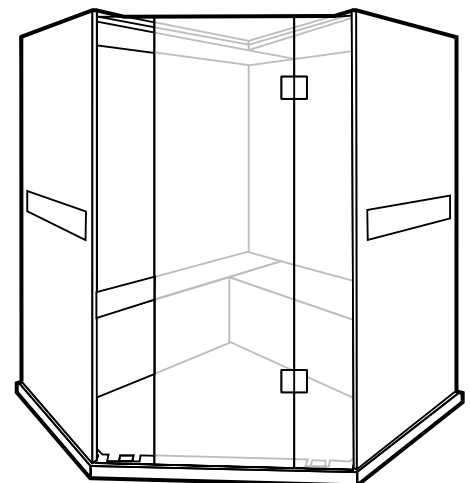
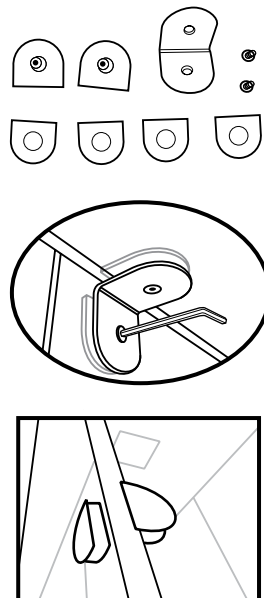

Right Front Wall Installed

Assembly Instructions Cont'd

13 - INSTALLING LEFT SIDE GLASS WINDOW

1. Open the door of the sauna to allow room to place the left side glass window.
2. Place the left side glass window and push it against the left side wall so it is securely in place. Until this piece is secured using the enclosed brackets, someone should hold the piece in place.
3. Secure the left front glass window to the roof glass using the included brackets. You will see pre-drilled holes in both the front glass and roof glass.

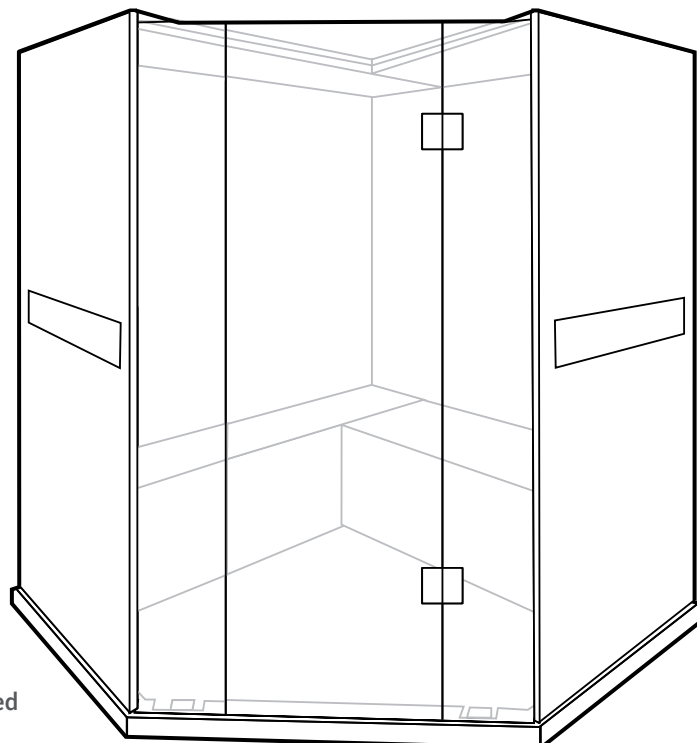
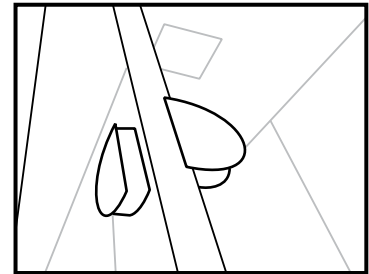
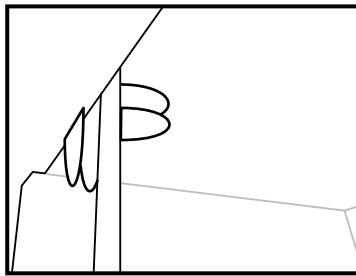
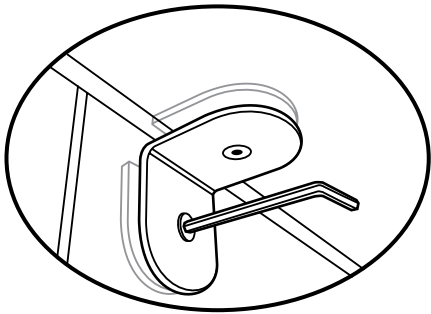

Left Front Wall Installed

Assembly Instructions Cont'd

14 - CONNECT HEATERS IN ROOF

1. Locate the "trap" doors that open in the wood roof.
2. Connect the black and white cables that that come out of the side wall to the connector located in the wood roof.
3. Connect the green ground wire that come out of the side wall to the green ground wire that is in the wood roof. Push the wiring inside the roof area and close the roof door compartments.
4. In the left side wall compartment, there will be two connectors: 1) Heater connector. 2) Keypad connector. The heater connector is a two wire connector. The keypad connector is a seven wire connector.

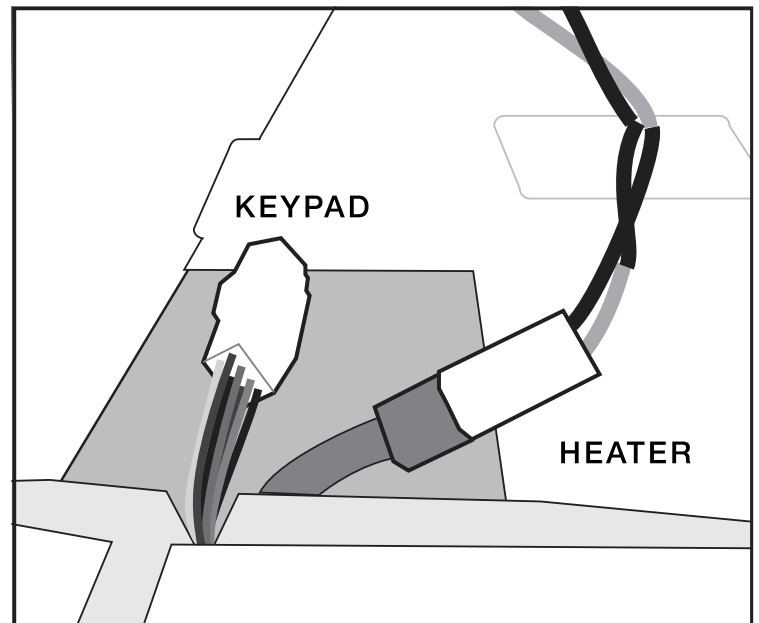

BE SURE TO MATCH THE COLORS IN THE CONNECTORS.
THE BLACK WIRE SHOULD MATCH UP WITH THE BLACK WIRE, ETC.

15 - INSTALLING DOOR HANDLE

1. Locate the door handle.
2. Attach the door handle using the enclosed screws.

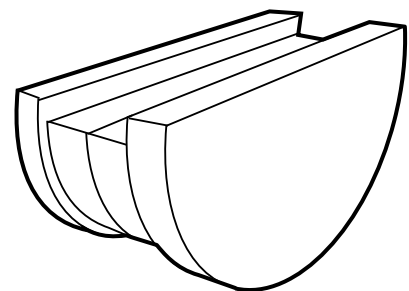

Note: If you are using a tablet or smartphone to control your sauna, the door handle will act as both the door handle and tablet/smartphone holder when the door is closed.

Assembly Instructions Cont'd

16 - INSTALLING FRONT HEATERS

1. Locate the two front heaters.
2. Align the left front heater and plug it into the receptacle in the floor near the front wall.
3. Align the the hole in the back of the heater with the hole in the front wall glass and using the enclosed screw/washers, secure the heater to the glass through the pre-drilled hole. One washer will be placed on the inside and one on the outside glass. The heater will be secured with these screws in two locations.
4. Repeat this step for the right front heater.

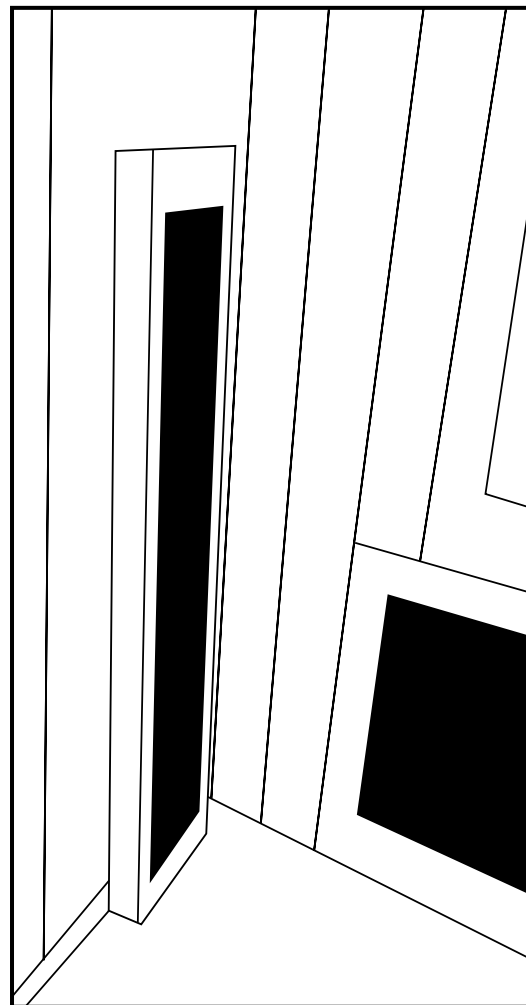
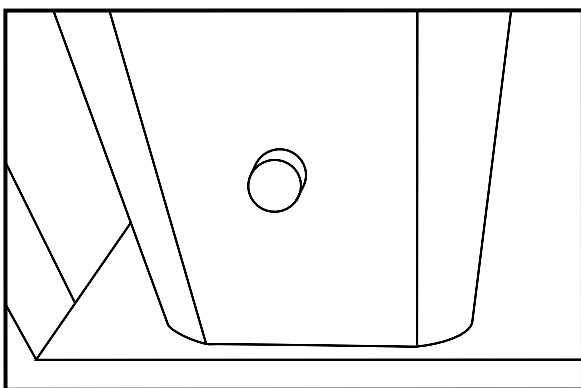
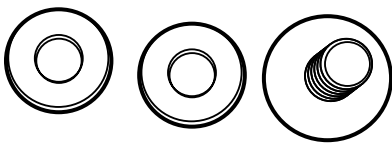
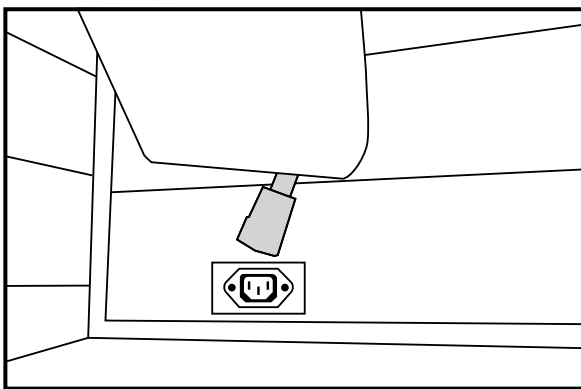

Front Heater
Installed

Assembly Instructions Cont'd

16 - INSTALLING FRONT HEATERS

- Once both heaters are installed carefully push the included Full Spectrum Heater guards securely over each of the front heaters. The full spectrum heaters are hot to the touch when running and this will prevent burning should you get close to the heater.

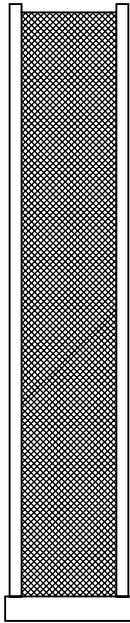

Warning Notice: The infrared heaters in your sauna are a potential BURN HAZARD. Do NOT touch the infrared heaters when they are in operation and allow to cool before servicing.

17 - LOCATING AND PLUGGING IN POWER CORD

The power cord comes out of the roof of the sauna. If you are standing facing the sauna, it comes out of the rear left corner of the roof. Open the trap door to access the power cord and run the cord down the back of the sauna. The power cord will plug into the appropriate electrical receptacle.



Note: We do not recommend using an extension cord for your sauna. Please plug the sauna directly into the wall receptacle.

Assembly Instructions Cont'd

18 - INSTALLATION IS COMPLETE

Installation of your sauna is now complete. Using a damp cloth, wipe out the sauna to remove any excess saw dust that may have settled on the wall & floor panels and the heater panels during shipping.

Please refer to usage instructions located later on in this manual.

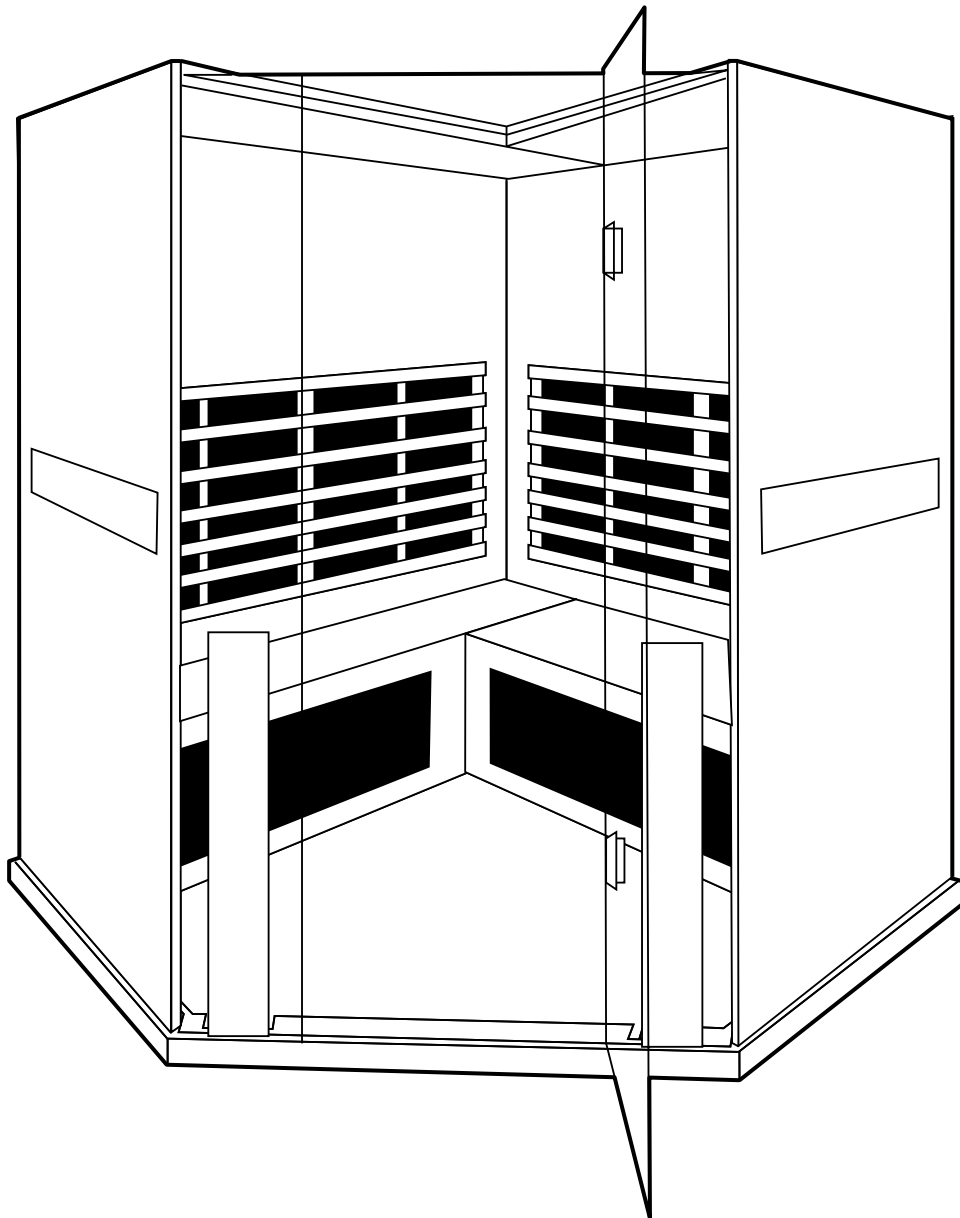

Enjoying Your Sauna

ENJOY YOUR SAUNA!

Your sauna is now ready for use and you are about to enjoy the finest infrared sauna experience available. Make sure you have a plenty of water to drink and enough towels. Sit back and relax as you are now on your way to better health.

Infrared heat works by warming your body directly without having to heat the air inside the sauna. Breathing is easier and healthier because the air temperature is not heated to the same degree as other types of saunas. The infrared heat penetrates deeply into your body to relax sore muscles and help alleviate pain. The bench, walls and fixtures are not hot to the touch. This allow for a more enjoyable sauna session.

Instructions for use

Review all health and safety instructions. If in doubt as to the advisability of using your infrared sauna, consult with your physician. If you feel light-headed or heat-exhausted during a session, exit the sauna immediately.

1. Select the desired session temperature and time using the control panel.
2. Allow approximately 10-15 minutes for the sauna to warm up before beginning a session.
3. Starting out, we recommend that your sauna session does not exceed 30 minutes.
4. When the temperature reaches the level set on the control panel, the heaters will turn off and on periodically in order to maintain the desired temperature level inside the sauna. **Keeping the thermostat set at its maximum will ensure the heaters stay on continuously.**
5. The ceiling vent(s) in the ceiling panel can be opened at any time to allow fresh air into the sauna.
6. Infrared's unique property of direct penetration into the body without heating the intervening space in-between allows the users to enjoy all of its benefits while the door is open for ventilation.
7. Always drink plenty of water before, during, and after a session. Doing so will replenish fluids lost from the body through perspiration.
8. Choosing to take a hot shower or bath prior to the sauna session will further promote perspiration. However, dry off thoroughly before going into the sauna because excessive water will stain or warp the wood. A shower after the session is refreshing and rinses perspiration from the body.
9. To absorb perspiration and keep the sauna tidy during the session, place a towel on the bench and floor of the sauna. Keep one towel handy to wipe excessive perspiration from your body.
10. Your Clearlight Infrared Sauna is made of the finest Western Red Canadian Cedar or Basswood. If the light fragrance of the fresh wood is too strong during the first few months of usage, wipe the wood with a damp cloth to minimize the aroma.

Using Your Sauna Control Panel

USING YOUR INFRARED SAUNA

Unlike a traditional sauna, infrared heats the body directly. Air temperature in the sauna is not as important as the type and quality of the infrared being received. We recommend the following protocol:

- a. Turn the sauna on for 10 minutes to allow the heaters to come up to optimal temperature and for the cabin to warm to a comfortable temperature.
- b. When you enter the sauna, set the time to the desired session time and turn the thermostat up to 150°F / 65°C. This will keep the heaters on the entire time to ensure that you are receiving constant infrared heat. **During a 30 minute sauna session, the air temperature will reach between 115-125°F / 46-51°C depending on the starting ambient air temperature.**
- c. Sit back and relax. Enjoy your sauna session.



When connected to the properly grounded power source, your Clearlight® sauna will turn ON to the set temperature and count-down with a few pushes of the Power button.



System On/Off

- 1) Press the "POWER" button once to turn on the sauna.
- 2) Your session will automatically end after the programmed timer expires.
- 3) Press the "POWER" button at any time to turn off the sauna.



Sauna Session Time

You can set the duration of your sauna session for a maximum of 60 minutes. Press the TIME UP or TIME DOWN buttons to increase or decrease your desired sauna session time in 5 minute increments. When you have reached your desired time, release the button.

Controlling the Set Temperature

You can program your sauna for a maximum temperature of 158°F (70°C). Press the TEMP UP/DOWN (+/-) buttons to set the desired temperature. When the display shows your desired temperature, release the buttons. Press either the TEMP UP or TEMP DOWN buttons during your sauna session to manually control the desired cabin temperature.

*See "Instructions For Use" on next page for recommendations.

Using Your Sauna Control Panel

USING YOUR INFRARED SAUNA

Fahrenheit & Celsius

You can alternate between Fahrenheit and Celsius by pressing the F/C button on the keypad.

Inside / Outside Light

1. Press the button labeled "INSIDE" to turn on or off the Interior light.
2. Press the button labeled "OUTSIDE" to turn on or off the exterior light and the heater backlights.

Full Spectrum

Press the "Full Spectrum" button to turn on and off the Full Spectrum heaters. When the sauna is turned on, both Full Spectrum heaters will turn on.

1. Press the button once and the right front heater will turn off with the left front heater on.
2. Press the button a second time and the left front heater will turn off with the right front heater on.
3. Press the button a third time and both front full spectrum heaters will turn off.
4. Press the button a fourth time and both front full spectrum heaters will turn on.

Reservation

You can preset your sauna to turn on up to 36 hours in the future:

1. Press the POWER button to turn on your sauna.
2. Press the RESERVE button.
3. The time and temperature will begin to flash.
4. Press the TIME UP button to set the number of hours ahead you would like your sauna to turn on.
5. The range is 1 - 36.
6. Set the maximum set temperature by pressing the TEMP UP or TEMP DOWN button.
7. The keypad will flash and the time will count down in one hour increments until the sauna turns on.
8. To cancel the reservation, press the "POWER" button once to turn off the sauna.

AUX

The AUX button will be used to control additional features that can be added to your sauna. The instructions to use these features will be included when the item is purchased.

Using Your Sauna Control Panel

USING YOUR INFRARED SAUNA

Keypad Lock

The keypad can be locked to prevent it from being turned on or off or the temperature adjusted. There are two locking functions:

1. **Lock Entire Keypad:** Hold down the TIME UP and TEMP DOWN buttons at the same time for 5 seconds. This will lock the entire keypad. To unlock the keypad, repeat the above step.
2. **Lock Keypad - Light Button Will Continue To Work:** Hold down the TIME DOWN / TEMP UP buttons at the same time for 5 seconds. This will lock the entire keypad except the light button.



Note: With the keypad locked, the time will continue to count down and the sauna will turn off when the time is expired.

Audio System

Your Clearlight® sauna is equipped with stereo speakers that can be accessed by either Bluetooth or through the Aux 3.5 mm connection in the charging compartment. You can also charge your device via the USB connection in the charging compartment.

1. Your Clearlight® sauna is Bluetooth ready. To connect audio via Bluetooth:
 - A) Open your Bluetooth enabled phone, tablet or computer and search for surrounding Bluetooth devices to find a device called **Infrared Sauna**. The pairing code for this device is **0000**.
2. There is a 3.5mm jack in the charging compartment that is connected to the speakers in your sauna. You can connect any audio to the speakers using this connection.
3. There is a switch located in the ceiling of the sauna next to the left speaker. This switch will toggle between the audio speakers included in the sauna and the Vibrational Resonance Therapy (VRT) that can be added to your sauna. If you did not purchase the VRT, you do not need to use this switch.

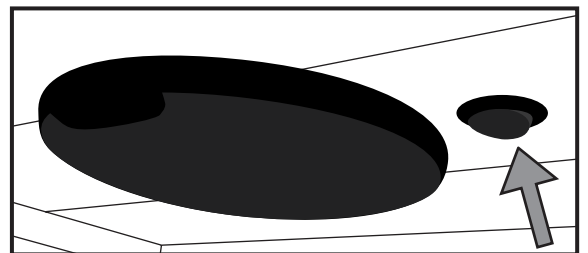

Using Your Sauna Control Panel

USING YOUR INFRARED SAUNA

Chromotherapy

Color light therapy can benefit your well being. Chromotherapy or Color Light Therapy is the science that uses the seven colors of the light spectrum. The seven colors have the ability to affect the vibrations of the body various frequencies. For optimal health, we all need the light of the sun. We receive light from the sun which is divided into 7 main groups of rays which are absorbed by our bodies.

Chromotherapy works on various energy points to help balance your body using the full spectrum of visible light. Color and light have been utilized by healers for thousands of years. Color therapy possibly has roots in Ayurveda, ancient Egyptian culture and traditional Chinese healing.

Alternative medicine practitioners who use chromotherapy often relate the seven colors of the color spectrum to specific body areas. Color has a profound effect on us on all levels, physical, mental, emotional and spiritual.

The chromotherapy light is controlled by pressing the buttons on the INCLUDED REMOTE CONTROL.

- 1. Press the "POWER" button to turn on the Chromotherapy light.**
- 2. Press the "MANUAL" button to manually select a color.**
- 3. Press the "AUTO" button and the Chromotherapy light will automatically change through the various colors.**
- 4. Press the "INTENSITY" up or down buttons to control the brightness of the Chromotherapy light.**

The available color in the Chromotherapy light have been specifically selected based on their wavelength:

- 1) Red:** Activates the circulatory and nervous systems.
- 2) Strong Green:** Provides anti-infectious, anti-septic and regenerative stimulation.
- 3) Strong Blue:** Lubricates joints. Helps address infections, stress, nervous tension.
- 4) Orange:** Energized and eliminates localized fat. Helps address asthma and bronchitis.
- 5) Green:** Acts as a relaxant.
- 6) Blue:** Stimulates muscle and skin cells, nerves and the circulatory systems.
- 7) Strong Yellow:** Strengthens the body and acts on internal tissue.
- 8) Strong Indigo:** Helps address eye inflammation, cataracts, glaucoma and ocular fatigue.
- 9) Strong Pink:** Act as a cleanser, strengthening the veins & arteries.
- 10) Yellow:** Reactivates and purifies the skin. Helps with indigestion and bodily stress.
- 11) Indigo:** Activates and eliminates impurities from the blood stream.
- 12) Violet:** Relaxes the nerves & lymphatic system. Addresses inflammation and urinary illness.

Tips for Use

1. Opening the roof vent and/or door allows fresh air to enter the sauna.
2. Drink liquids prior to and after your session.
3. Towel off during your session. This will help the body perspire more freely.
4. To relieve sore and tight muscles massage these areas for faster healing and effectiveness
5. Oil and lotions tend to decrease perspiration by blocking pores. Apply these after your session for best results.
6. Some minerals can be lost in perspiration. Eating a sensible diet including fruits and green leafy vegetables will replace these. Supplements can also be taken to replenish minerals.
7. Limit food intake an hour before your sauna session. Your body will be able to detox more effectively because it will not be using that energy for digestion.
8. Taking a shower or bath before a sauna session tends to increase perspiration as bathing opens the pores.
9. Use at least 2-3 towels for maximum comfort.
 - a. Sit on one towel folded over several times for added cushioning.
 - b. Use another towel on the floor to absorb extra perspiration.
10. At the first sign of cold or flu, increasing your sauna sessions may be beneficial in boosting your immune system and decreasing the reproductive rate of the viruses. Consult your physician for the proper treatment for this, or any other condition.
11. As you become more heat conditioned, you may wish to increase the length of your Clearlight® sauna session to 40 minutes. This is especially useful for soft tissue therapy. (Make sure to drink fluids throughout your sauna session.)

Tips for Use

12. If you notice any drying of your skin with ongoing use of your Clearlight® sauna or wish to maximize the detoxification benefits from your Sauna, it is suggested that you obtain the best quality oil available (i.e. expeller pressed oil such as Organic Canola Oil or Organic Coconut Oil are very good). Add 2-4 tablespoons a day to your diet. The essential oils in these products are needed for skin health and allow the body to let go of stored toxins, fat and cholesterol.
13. Unlike a traditional sauna, infrared heats the body directly. Air temperature in the sauna is not as important as the type and quality of the infrared being received. We recommend the following protocol:
 - a. Turn the sauna on for 10-15 minutes to allow the heaters to come up to optimal temperature and for the cabin to warm to a comfortable temperature.
 - b. When you enter the sauna, set the time to the desired session time and turn the thermostat up to 158 degrees. This will keep the heaters on the entire time to ensure that you are receiving constant infrared heat. **During a 30 minute sauna session, the air temperature will reach between 115-125F.**
 - c. Sit back and relax. Enjoy your sauna session.

We hope you enjoy years of relaxation and better health from regular use of your Clearlight® sauna. If you have any question on the proper use of your sauna, please call us at 800.798.1779 or +1.510.601.1775.

Clearlight® saunas... Here's to good health!

Safety Instructions

1. Read and follow all instructions carefully.
2. When installing and using this electrical equipment, basic safety precautions should always be followed.
3. To reduce the risk of injury, do not allow children to use the sauna unless they are closely supervised at all times.
4. Do not use the sauna immediately following strenuous exercise. Wait at least 15 minutes to allow the body to cool down completely.
5. Excessive temperatures have a high potential for causing fetal damage during the early months of pregnancy. Pregnant or possibly pregnant women should contact their physician prior to using the sauna.
6. Hyperthermia Danger: Prolonged exposure to hot air will induce hyperthermia. Hyperthermia occurs when the internal temperature of the body reaches a level several degrees above the normal body temperature of 98.6F (37C). While hyperthermia has many health benefits, it is important not to allow your body's core temperature to rise above 103F (39.5C). Symptoms of excessive hyperthermia include dizziness, lethargy, drowsiness, and fainting. The effects of excessive hyperthermia may include failure to perceive heat, failure to recognize the need to exit, unawareness of impending hazard, fetal damage in pregnant women, physical inability to exit the sauna, and unconsciousness.
7. The use of alcohol, drugs, or medications prior to or during the sauna session may lead to unconsciousness.
8. Persons suffering from obesity or with a medical history of heart disease, low or high blood pressure, circulatory system problems, or diabetes should consult a physician prior to using the sauna.
9. Persons using medications should consult a physician before using the sauna since some medications may induce drowsiness while others may affect heart rate, blood pressure, and circulation.

Safety Instructions

10. Exercise care when entering or exiting the sauna.
11. Never sleep inside the sauna while the unit is in full operation.
12. Do not use any type of cleaning agents on the interior of the sauna.
13. Do not stack or store any objects on top of or inside the sauna.
14. If the power supply cord becomes damaged, it must immediately be replaced by the manufacturer or its agent or a similarly qualified person to avoid a hazard.
15. Do not use the unit during an electrical storm, as there is a remote risk of shock.
16. Altering or tampering of any electrical connections on the power supply will void the manufacturer's warranty.
17. Dry your hands before handling electrical controls. Never unplug the power cord or adjust the controls with wet hands or when you have wet bare feet. A danger of electrical shock exists.
18. Do not attempt any repair without consulting the manufacturer first. Unauthorized repair attempts will void manufacturer's warranty.
19. We strongly recommend the use of a GROUND FAULT CIRCUIT INTERRUPTER (GFCI) device in any potentially wet locations.
20. Your Clearlight® sauna is made of the finest Canadian Cedar or Basswood. All wood products have variations in the color, grain, and may have irregularities such as knots, and fine cracks. These reflect reflect the natural beauty of the wood and should not be considered defects.
21. To safeguard against burns, do not touch heaters or lamps directly.

Important Safeguards

IMPORTANT SAFEGUARDS

- 1. READ INSTRUCTIONS** - All safety and operating instructions should be read before the sauna is installed & operated.
- 2. RETAIN INSTRUCTIONS** - The safety and operating instructions should be retained for future reference.
- 3. HEED WARNINGS** - All warnings on the sauna should be adhered to.
- 4. FOLLOW INSTRUCTIONS** - All operating and usage instructions should be followed at all times.
- 5. CLEANING** - Unplug the sauna from the wall outlet before cleaning. Do not use liquid cleaners or aerosol cleansers inside the sauna. Use a damp cloth for cleaning.
- 6. ATTACHMENTS** - Do not use attachments that are not recommended by the manufacturer as they may cause hazard.
- 7. WATER OR MOISTURE** - Do not use this product near water-for example near a bathtub, in a wet basement, or near a swimming pool or similar area.
- 8. GROUNDING OR POLARIZATION** - This sauna is intended for use with a 3-wire properly grounded power socket Do not defeat the safety purpose of the supplied line cord and plug.
- 9. POWER SOURCES** - This product should be operated only from the required type of power source indicated on the marking label. If you are not sure of the type of power supplied to your home, consult your local power company.
- 10. POWER-CORD PROTECTION** - Power supply cords should be routed so they are not likely to be walked on or pinched.
- 11. LIGHTNING** - For added protection for this product during a lightning storm, or when it is left unattended and unused for long periods of time, unplug it from the wall outlet.
- 12. OVERLOADING** - Do not overload wall outlets and extension cords as this can result in a risk of fire or electrical shock.

Important Safeguards

IMPORTANT SAFEGUARDS

- 13. SERVICING** - Always unplug this product from the wall outlet before servicing the product.
- 14. POWER SUPPLY** - Do not remove power supply covers. No user-serviceable parts are located inside the power supply.
- 15. REPLACEMENT PARTS** - When replacement parts are required, only use parts specified by the manufacturer. Unauthorized substitutes could result in fire, electrical shock or other hazards.
- 16. SAFETY CHECK** - Upon completion of any service or repairs to this product by a service technician, ask the technician to perform safety checks make certain that the product is in proper operating condition.

PRECAUTIONS FOR POWER SUPPLY



This FEMALE INLET takes the MALE POWER CORD from the back panel.

Make sure that the cord is plugged securely into this inlet at all times.

Rear Heater Inlet

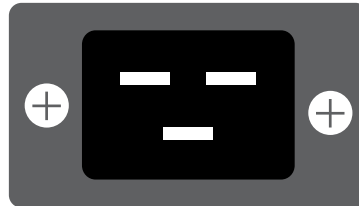

This MALE INLET takes the FEMALE PLUG on the main power cord.

Make sure that the cord is plugged securely into this inlet at all times.

B Main Power Cord Inlet

Warranty

SAUNA WORKS LIMITED LIFETIME WARRANTY

Sauna Works, Inc. ("Company") offers the following to the original purchaser of any Sauna Works manufactured or distributed Clearlight® saunas ("Sauna") and designated parts and accessories:

Product	Indoor Residential-Use Saunas*	Outdoor Residential-Use Saunas	Commercial-Use Saunas
Clearlight® brand sauna Cabin	Lifetime	5 Years	5 Years
Factory-Installed Sauna Controls and Wiring	Lifetime	Lifetime	5 Years
Factory-Installed Heater Components	Lifetime	Lifetime	5 Years
Factory-Installed Audio Components	Lifetime	Lifetime	5 Years
Labor on Clearlight® brand sauna Cabin (USA & Canada only)	7 Years	5 Years	5 Years
Labor of Factory-Installed Components (USA & Canada only)	7 Years	5 Years	5 Years
Water-Resistant Cover (fabric only)	1 Year	1 Year	1 Year
Non-Factory Installed Components, Options, Parts and Accessories	Per manufacturer's warranty unless specified in Sauna Works' Quote, Invoice or Website		

*Extends to outdoor use if purchased simultaneously with and kept continually covered by the Sauna Works water-resistant cover specified for that Sauna model.

Warranty

SAUNA WORKS LIMITED LIFETIME WARRANTY

For the coverage period specified (“warranty period”), Company agrees to repair or replace, at its sole option, the products listed above, subject to and solely in accordance with the terms, conditions, exclusions and limitations set forth herein. PLEASE READ THIS LIMITED WARRANTY IN ITS ENTIRETY TO UNDERSTAND YOUR RIGHTS AND OBLIGATIONS.

LIMITED WARRANTY ON SAUNA CABIN AND FACTORY-INSTALLED COMPONENTS

Company warrants to the user during the warranty period (a) that the Sauna Cabin will maintain its structural integrity and for outdoor models, that it will not leak, and (b) that factory-installed components (i.e., heater controls, power supply, electrical wiring, and audio system) will be free from defects in material or workmanship. This limited warranty shall not apply to any display model unless expressly agreed by Sauna Works in writing at the time of purchase or to any Sauna installed more than six months after the delivery date.

LABOR WARRANTY FOR SAUNA CABIN AND FACTORY-INSTALLED COMPONENTS

The Sauna cabin and factory-installed components are covered under Company’s labor warranty for the specified labor warranty period.

LIMITED WARRANTY ON NON-FACTORY-INSTALLED COMPONENTS, OPTIONS, PARTS AND ACCESSORIES

Non-factory installed components, and Sauna Works options, parts and accessories are not warranted to the user against defects in material or workmanship except to the extent of any warranty period expressly set forth in the Sauna Works final quote or invoice. These items may also be covered by a manufacturer’s warranty which may have a longer duration than this limited warranty. Please confirm with the manufacturer of these items the duration of its warranty. If no warranty period is specified, only the manufacturer’s warranty, if any, shall apply. The Sauna Works water-resistant cover warranty only applies to the cover’s fabric under normal usage and environmental exposure. It does not cover failure or unserviceability resulting from excessive environmental exposure, cleaning or other chemicals, or failure to follow the care instructions included with the cover.

Warranty

SAUNA WORKS LIMITED LIFETIME WARRANTY

DISCLAIMER OF IMPLIED WARRANTIES

ALL IMPLIED WARRANTIES, INCLUDING WITHOUT LIMITATION, THE IMPLIED WARRANTIES OF MERCHANTABILITY AND FITNESS FOR A PARTICULAR PURPOSE ARE HEREBY DISCLAIMED IN THEIR ENTIRETY OR TO THE FULLEST EXTENT ALLOWED BY LAW. THIS LIMITED WARRANTY TAKES THE PLACE OF ALL OTHER WARRANTIES, EXPRESS OR IMPLIED, IN FACT OR AT LAW, INCLUDING IMPLIED WARRANTIES OF MERCHANTABILITY AND FITNESS FOR A PARTICULAR PURPOSE.

WARRANTY LIMITATIONS AND EXCLUSIONS

The warranty period begins on the date the unit is purchased by the user. This warranty may not be transferred, sold, donated, gifted or assigned to a third party except with the prior written consent of Sauna Works, in its sole and absolute discretion. Absent written consent, only the original purchaser can make claims hereunder. All warranty labor must be performed by Company or its designated representative using authorized Sauna Works parts. No agent, dealer, distributor, service company or other party is authorized to change, modify, or extend the terms of this limited warranty in any manner whatsoever. Any warranty so provided shall be solely their separate obligation. As used in this warranty, (a) "commercial use" shall mean any use that involves a fee, rate, charge, or other consideration, any use directly or indirectly in connection with a business, going concern, or undertaking intended for profit or pecuniary gain, and any non-residential use, (b) "residential use" shall mean when purchased for use by a single-family for internal household purposes, and (c) "user" shall mean the original purchaser.

The limited warranty does not cover defects, damage, or failure ("Damage") caused by the delivery service providers or common carrier, the installer, user, or other persons and animals, including without limitation, termites and other wood-destroying insects or rodents. The limited warranty excludes Damage resulting from transportation, careless handling, improper location, storage, or relocation, as well as from cleaning, painting, staining or other use of abrasive or improper chemicals. The limited warranty also excludes Damage arising from user's or a third party's negligence; modification of any type for any reason (including modification to meet local codes); improper installation (including installation not in accordance with instructions and specifications provided with the unit); connections supplied by the installer of the equipment, an electrician or a third party; improper voltage supply; unauthorized electrical modification; misuse; improper use; abuse; incorrect operation, lack of proper routine or preventive maintenance; unauthorized repair by a third-party; normal wear and tear; fire, and acts of God such as lightning, floods, earthquakes, etc. Outdoor-Use Sauna warranties do not include damage arising from a failure (i) to maintain the Sauna on a flat, level, hardtop surface with adequate drainage and (ii) to keep the exterior free and clear from plants, trees, grasses, soil, and snow deposits.

Warranty

SAUNA WORKS LIMITED LIFETIME WARRANTY

The limited warranty does not include: labor, transportation, or other costs incurred in the removal and/or reinstallation of the original unit and/or installation of a replacement unit; any costs relating to obtaining access for repair; or loss of use damage, including loss of sales, profit or business advantage of any kind under any circumstances. The labor warranty is provided in the United States of America and Canada only. User shall be obligated to pay for postage and handling for mailing and delivery of any products outside the United States and Canada. Dated proof of purchase of the product is required for a warranty claim. These disclaimers shall be equally applicable to any labor or service provided by Company and its designated representatives.

RESPONSIBILITIES OF OTHERS

Unless otherwise expressly agreed in writing, (a) all installers are separately contracted for by user and are not under the direction and control of Company, (b) the installer is the user's responsibility, and (c) Company will have no obligation, liability, or responsibility in connection with the same. Your installer is responsible for inspecting the unit prior to installation and ensuring the unit is free of defect or damage. Notices are placed on and in the unit and on the shipping carton advising the installer of this responsibility. In the event of a problem identified prior to installation, the unit must not be installed, and Company is not responsible for failures or damage that could have been discovered, repaired, or avoided by proper inspection prior to installation. Damage occurring in transit is the responsibility of the carrier. The user or installer MUST open the crate and inspect the unit for damage when it is delivered. If damage is discovered, it must be reported immediately to the seller and the carrier in writing, and an inspection requested. Failure of the carrier to respond should be reported to the seller and the carrier. Your freight claims should be filed promptly thereafter. Damage occurring to the unit during installation is the responsibility of the installer and/or building contractor and damage occurring thereafter is the responsibility of the user. Failure of any non-factory installed components, parts and accessories is the sole responsibility of the equipment manufacturer except as provided above. Any replacement parts shall be covered only by the original equipment manufacturer warranty, if any. Your installer is responsible for knowing local code requirements and installing the unit safely in accordance with the same. The Company is not responsible for costs to modify any product to obtain any code approval, such as city, county, or state building codes.

WARRANTY REGISTRATION

To register your product, please go to our website www.clearlight-saunas.eu/warrantyform. You will then be prompted to enter your product Serial Number followed by your warranty registration information.

Warranty

SAUNA WORKS LIMITED LIFETIME WARRANTY

The warranty must be registered within thirty (30) days from the date of purchase in order for this warranty to become effective.

WARRANTY SERVICE

For the user's benefit, the Company maintains a list of independent service personnel to perform required warranty service repairs. Such firms are not agents or representatives of the Company and cannot bind the Company by words or conduct.

The Company will provide the warranty service described above when the following conditions have been met: the failure is covered by the warranty; the user has informed an Authorized Sauna Works Warranty Service Department Representative of the nature of the problem during the warranty period; conclusive evidence (e.g., proof of purchase or installation) is provided to the foregoing by the user proving that the failure occurred or was discovered within the warranty period; and, an authorized independent service person or Company representative has been permitted to inspect the unit during regular business hours within a reasonable time after the problem was reported by the user. In order to obtain warranty service, contact Sauna Works at:

www.clearlight-saunas.eu/ or

Clearlight Saunas Europe UG (haftungsbeschränkt)

Warranty Service Department

EU: +44 118 324 1242

Germany +49 361 7473 4613

To obtain warranty service, call or write the above. Provide a description of the problem and proof of purchase. You will be instructed how to obtain replacements and where to return, at your expense, the failed component(s), option(s), or accessory(ies). All replacement parts, equipment, and repairs shall assume the remaining warranty period of the part(s) replaced and do not extend the same.

The Company's warranty obligation shall be discharged upon tender of replacement or repair. The customer's refusal to accept the tender terminates the Company's warranty obligation. Company will only pay for shipping and handling fees to return the repaired or replacement unit to you if we elect to replace the defective unit.

Warranty

SAUNA WORKS LIMITED LIFETIME WARRANTY

LEGAL RIGHTS: This Limited Warranty gives you specific legal rights. There are no warranties applicable to Clearlight® brand sauna products manufactured and distributed by Company, except as expressly stated herein or as implied by applicable state and federal laws. You may also have other rights that vary from state to state. Some states do not allow limitations on how long an implied warranty lasts, disclaimer of certain warranties, or the exclusion or limitation of incidental or consequential damages, so some of the above limitations and exclusions may not apply to you. Company will not be responsible for any statements or representations made in any form that go beyond, are broader than, or are inconsistent with any technical specifications furnished by the Company.

LIMITATION OF LIABILITY

THE REMEDIES DESCRIBED IN THIS LIMITED WARRANTY ARE YOUR SOLE AND EXCLUSIVE REMEDIES AND COMPANY'S ENTIRE LIABILITY, INCLUDING, WITHOUT LIMITATION, FOR ANY BREACH OF THIS LIMITED WARRANTY. COMPANY'S LIABILITY SHALL UNDER NO CIRCUMSTANCES EXCEED THE ACTUAL AMOUNT PAID BY USER FOR THE APPLICABLE DEFECTIVE PRODUCT, NOR SHALL COMPANY UNDER ANY CIRCUMSTANCES BE LIABLE FOR ANY CONSEQUENTIAL, INCIDENTAL, SPECIAL OR PUNITIVE DAMAGES OR LOSSES, WHETHER DIRECT OR INDIRECT. IN ADDITION, THE COMPANY WILL NOT BE RESPONSIBLE FOR CONSEQUENTIAL, INCIDENTAL, SPECIAL OR PUNITIVE DAMAGES OR LOSSES, WHETHER DIRECT OR INDIRECT FROM ANY CAUSE WHATSOEVER, INCLUDING BUT NOT LIMITED TO COMPANY'S GROSS NEGLIGENCE. THIS EXCLUSION APPLIES EVEN IF COMPANY WAS ADVISED IN ADVANCE OF THE POSSIBILITY OF SUCH DAMAGES.

SOME STATES DO NOT ALLOW THE EXCLUSION OR LIMITATION OF INCIDENTAL OR CONSEQUENTIAL DAMAGES, SO THE ABOVE LIMITATION OR EXCLUSION MAY NOT APPLY TO YOU.

Why Detoxify

Why Is Detoxification Important

Excerpted from: Literature Review & Comparison Studies of Sauna/Hyperthermia in Detoxification Townsend Letter for Doctors, June 1992 Zane R. Gard, M.D. & Erma J. Brown, BSN, PhN

The past 150 years have been a time of incredible progress for medicine, science and industry. Because of these advancements we now enjoy longer, more productive lives. However, there are many who pay a tremendously high price for our modern lifestyle. The by-products of our chemical technology have resulted in ubiquitous contamination of our atmosphere, lakes, oceans and soil. Our natural environment is now permeated by a barrage of “unnatural” substances.

Unquestionably, many of the chemical sources have been in existence for centuries. However, today we are exposed to chemical concentrations far greater than were our ancestors. Although the human mechanism is known to be accommodating, ecological alterations are now occurring at a faster rate than our bodies are able to adapt. We are now faced with a situation where inadequacies or uncertainties centering around the manufacturing, use, storage, and disposal of toxic chemicals, have resulted in an overwhelming number of environmentally-induced illnesses.

Since 1965, over 4 million distinct chemical compounds have been reported in scientific literature. Over 6000 new chemicals were added to this list between 1965 and 1978. As of 1981, of over 70,000 chemicals in commercial production, 3,000 have been identified as intentionally added to our food supplies and over 700 in drinking water. During food processing and storage 10,000 other compounds can become an integral part of many commonly used foods. Added to this list of potential body toxins, petrochemicals, industrial waste, medical and street drugs, radiation (X-rays, nuclear fallout etc.) and tons of pesticides, herbicides, and insecticides, the result is an incredible chemicalavalanche to have befallen the human race in a relatively short period of evolutionary history.

There is currently a wealth of scientific evidence showing that thousands of drugs, preservatives, pesticides, and other pollutants remain stored in the body long after exposure. We know for example that an organochlorinated pesticide such as the metabolites of DDT have a half life of between 20 and 50 years in the fat deposits of humans. According to the U.S. Environmental Protection Agency over 400 chemicals have been detected in human tissue; 48 were found in adipose tissue, 40 in breastmilk, 73 in the liver and over 250 in the blood.

Why Detoxify

The process of bodily accumulation and storage of toxins is known as “toxic bio-accumulation”. Though the predominate storage site in the body is the fatty tissue, toxins may re-enter the bloodstream during times of physical stress (i.e.. illness, fasting, excessive heat, exercise) or emotional stress. Every organ that is accessible to these chemicals, which have been mobilized or released from the fat, is being continually exposed at low levels. As stated by Dr. William L. Marcus, Senior Advisor and Chief Toxicologist for the U.S. Environmental Protection Agency, “It’s a chronic exposure. That’s why chemicals like dioxin, even in small amounts, are extremely dangerous. Unfortunately the human body has no previous experience with these chemicals and there is no natural machinery in the body to break them down, much less eliminate them.

Human accumulation of such compounds as DDT, PCP, PCB, and dioxin, reflect biologically persistent chemicals which are partitioned in the body from water into lipids. Eventually the metabolizing of xenobiotics (chemicals foreign to the biological system) leads to the accumulation of the chemicals and/or their products in lipid deposits throughout the body, particularly in adipose tissue. The simple chemistry involved in this process can be illustrated by the fact that some chemicals readily dissolve in water, while others dissolve only in oil bases. Oil soluble chemicals therefore have a tendency to accumulate in body fatty tissue or lipids, which are also insoluble in water. There is no such thing as a fat “cell”...[rather] almost every cell has a fat component.

The brain has a high fat content as does virtually every organ.

Directly or indirectly, toxic residues find their way into our air, food and water supplies. The net effect of this ecological overload is to alter the body’s balance or “homeostasis”. This interference with our natural biological tendencies to restore internal balance, results in “disease” in one form or another. According to Professor Edward J. Calabrese of the University of Massachusetts, and author of *Pollutants and High Risk Groups*, “It is this homeostatic process which neutralizes the pollutant’s effect and returns the system to equilibrium.”

Marshall Mandell, MD, nationally renowned in the field of bio-ecologic medicine, wrote in a recent publication that the influx of chemicals in our society today “has resulted in a lowered threshold of resistance and subsequent inability to cope with the natural and unnatural environment due to altered body metabolism, enzyme dysfunction, nutritional deficiencies, and hormonal imbalances.” Health depends on the balance of both external and internal environmental forces.

In response to the above facts, many health care practitioners have been recommending a vast array of detoxification programs. Circulating toxins and toxic bowels need proper cleansing. The removal of these toxins is relatively well known. When toxins are deposited in fat storage sites this becomes much more complicated. The only way to remove toxins from the fat storage sites is to mobilize the toxic fat. Heat-stress [of a sauna] is an effective method of removing fat-stored toxins from the body.

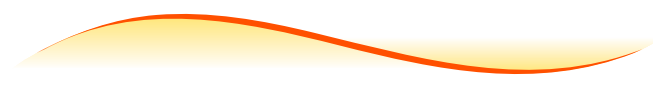

Clearlight

INFRARED™ *by Sauna Works*

