

(D) Ersatzteilliste	Motorsäge	675	Inhaltsverzeichnis	Seite
			Motoreinheit: Kurbelwelle, Zylinder, Zündung	2
			Auspuff, Vergaser, Luftfilter, Haube	4
			Ölpumpe, Kupplung, Kettenbremse	6
			Starter	7
			Handgriff / Hauptgehäuse, Haltebügel, Handschutz	8
			Schwert, Kette, Anschlagkralle, Kettenspannung	10
			Ersatzteile	12
			Richtlinien für die Bestellung	12
(GB) Spare parts list	Chain saw	675	Table of contents	Page
			Engine: Crankshaft, Cylinder, Ignition coil	2
			Exhaust, carburetor, air filter, Cover	4
			Oil-pump, clutch, chain brake	6
			Starter	7
			Handle bar / main housing, hand protection	8
			Guide bar, chain, bucking spike, Tension screw / tension carriage	10
			Spare parts	12
			Directions for Ordering	12
(F) Liste de pièces de rechange	Tronçonneuses	675	Table des matières	Page
			Moteur : Embiellage, Cylindre, Bobine allumage	2
			Echappement, carburateur, filtre à air, Coquille	4
			Pompe à huile, embrayage, frein de la chaîne	6
			Lanceur	7
			Etrier / carter principal, protège main	8
			Guide chaîne, chaîne, griffe de butée, Vis de tension	10
			Pièces de rechange	12
			Directives pour les commandes	12
(E) Lista de piezas de recambio	Motosierras	675	Indice	Página
			Motor: Cigüenal, Cilindro, Bobina	2
			Escape, carburador, filtro de aire, Cubierta	4
			Bomba de aceite, embrague, freno de cadena	6
			Arranque	7
			Asa / carter principal, proteccion de mano	8
			Espada, cadena, garra de apoyo, Tornillo de tension	10
			Piezas de recambio	12
			Directivas de pedido	12

Motoreinheit: Kurbelwelle, Zylinder, Zündung
Engine: Crankshaft, Cylinder, Ignition coil
Moteur : Embiellage, Cylindre, Bobine allumage
Motor: Cigüenal, Cilindro, Bobina



Bild-Nr. Pos.-No. No.Pos. Pos.-No.	Bestell-Nr. Order-No. No. de Cde Ref.-Nr.	Menge Quantity Nombres Cantidad	Motoreinheit: Kurbelwelle, Zylinder, Zündung	Engine: Crankshaft, Cylinder, Ignition coil	Moteur : Embiellage, Cylindre, Bobine allumage	Motor: Cigüenal, Cilindro, Bobina
1	22 00 681 52	1	Kurbelwelle	Crankshaft	Embiellage	Cigüenal
2	00 50 186	1	Kugellager 17x47x14 mm	Ball bearing	Roulement à billes	Cojinete de bolas
3	00 54 143	1	Wellendichtring 17x28x5 mm	Oil seal	Joint spy	Reten
4	00 50 183	1	Kugellager 15x42x13 mm	Ball bearing	Roulement à billes	Cojinete de bolas
5	00 54 159	1	Wellendichtring 15x24x7 mm	Oil seal	Joint spy	Reten
6	21 00 934	1	Kurbelgehäuse enth. (-> 6, 11	Crankcase incl. (-> 6, 11	Carter-moteur y inclus (-> 6, 11	Carter cigüenal incl. (-> 6, 11
7	20 61 526	1	Kurbelgehäusedichtung	Gasket	Joint	Junta
8	00 40 166	3	Stift 3 M6x16mm	Pin	Goujon cylindrique	Pasador cil.
9	27 00 441	1	Belüftungsventil	Ventilation valve	Valve de ventilation	Valvula de ventilacion
10	20 31 250	1	Einpressbolzen	Bolt	Axe	Bulon
11	00 18 339	6	Zylinderschraube M5x30 mm (-)	Screw (-)	Vis (-)	Tornillo (-)
12	20 42 875	1	Isolierfolie	Isolating foil	Feuille isolatrice	Laminilla
13	28 00 681	1	Dekoventil D 1,5	Deco-valve	Soupape decompression	Valvula
14	00 94 270	1	Kappe Dekoventil	Rubber Cap	Capuchon	Caperuza
15	22 00 521	1	Zylinder + Kolben, Reparatursatz enth.: (-> 15 - 20	Cylinder + piston, repair kit incl. (-> 15 - 20	Cylindre + piston, kit de réparation y inclus (-> 15 - 20	Cilindro + piston, juego de reparacion incl. (-> 15 - 20
16	20 61 525	1	Zylinderfußdichtung	Cylinder foot gasket	Joint de cylindre	Junta del cilindro
17	22 00 514	1	Kolben Ø 50mm enth. (-> 17, 20	Piston incl. (-> 17, 20	Piston y inclus (-> 17, 20	Piston incl. (-> 17, 20
18	20 31 233 25	1	Kolbenbolzen 12/8x32 mm	Piston pin	Axe de piston	Bulon
19	00 55 266	2	Sprengring	Ring	Circlips d'axe de piston	Anillo
20	20 48 259	1	Kolbenring 50x1,2 mm (-))	Piston ring (-))	Segment (-))	Anillo de piston (-))
21	00 52 236	1	Nadelkäfig 12x16x13 mm	Needle sleeve	Douille	Casquillo
22	00 10 604	4	Zylinderschraube M5x22 mm	Screw	Vis	Tornillo
23	00 72 144	4	Sicherungsscheibe 5 mm	Tension washer	Rondelle de tension	Arandela elastica
24	00 72 143	1	Sicherungsscheibe 6 mm	Safety washer	Circlip	Seguro
25	00 73 264	1	Dämpfungsfeder	Spring	Ressort amortisseur	Resorte
26	00 18 335	1	Zylinderschraube M5x12 mm	Screw	Vis	Tornillo
27	27 00 445	1	Tankverschluss Öl enth. (-> 27, 28	Tank cap incl. (-> 27, 28	Bouchon réservoir y inclus (-> 27, 28	Tapa de deposito incl. (-> 27, 28
28	00 62 347	1	O-Ring 25x3 mm (-)	Gasket (-)	Joint (-)	Junta (-)
29	23 00 730	1	Zündkerze WSR6F200	Spark plug	Bougie	Bujia
30	00 15 111	1	Gewindeeinsatz D23,5x7 mm	Insert	Insert	Insercion
31	60 43 938	1	Klammer Massearm	Clamp	Collier	Abrazadera
32	24 00 320	1	Polrad enth. 2 x Klinkenset	Flywheel incl. 2 x starter pawl	Roue polaire y inclus 2 x cliquet de lanceur	Volante incl. 2 x Trinquete
33	00 72 145	1	Sicherungsscheibe 8 mm	Tension washer	Rondelle de tension	Arandela elastica
34	00 20 145	1	Sechskantmutter M8	Nut	Écrou	Tuerca
35	23 00 852	1	Zündspule Selettra	Ignition coil	Bobine	Bobina
36	00 72 148	2	Sicherungsscheibe 4 mm	Tension washer	Rondelle de tension	Arandela elastica
37	00 18 327	2	Zylinderschraube M4x20 mm	Screw	Vis	Tornillo
38	00 64 469	1	Schlauch 6x120 mm	Hose	Tuyau	Tubo
39	00 84 898	1	Masseleitung	Ground cable	Cable de masse	Cable de masa
40	00 94 247	1	Gi.Metall	Rubber element	Element de gomme	Elemento av
41	00 75 101	1	Scheibfeder 3x3,7 mm	Disc spring	Clavette	Chaveta
42	00 94 246	1	Gi.Metall	Rubber element	Element de gomme	Elemento av
43	00 84 897	1	Zündkerzenstecker	Spark plug cap	Cosse de bougie d' allumage	Tapa de bujia
44	00 73 433	2	Klammer	Clamp	Collier	Abrazadera
45	00 66 164	2	Tülle	Grommet	Passe fil	Boca

9681702_02
24Pt

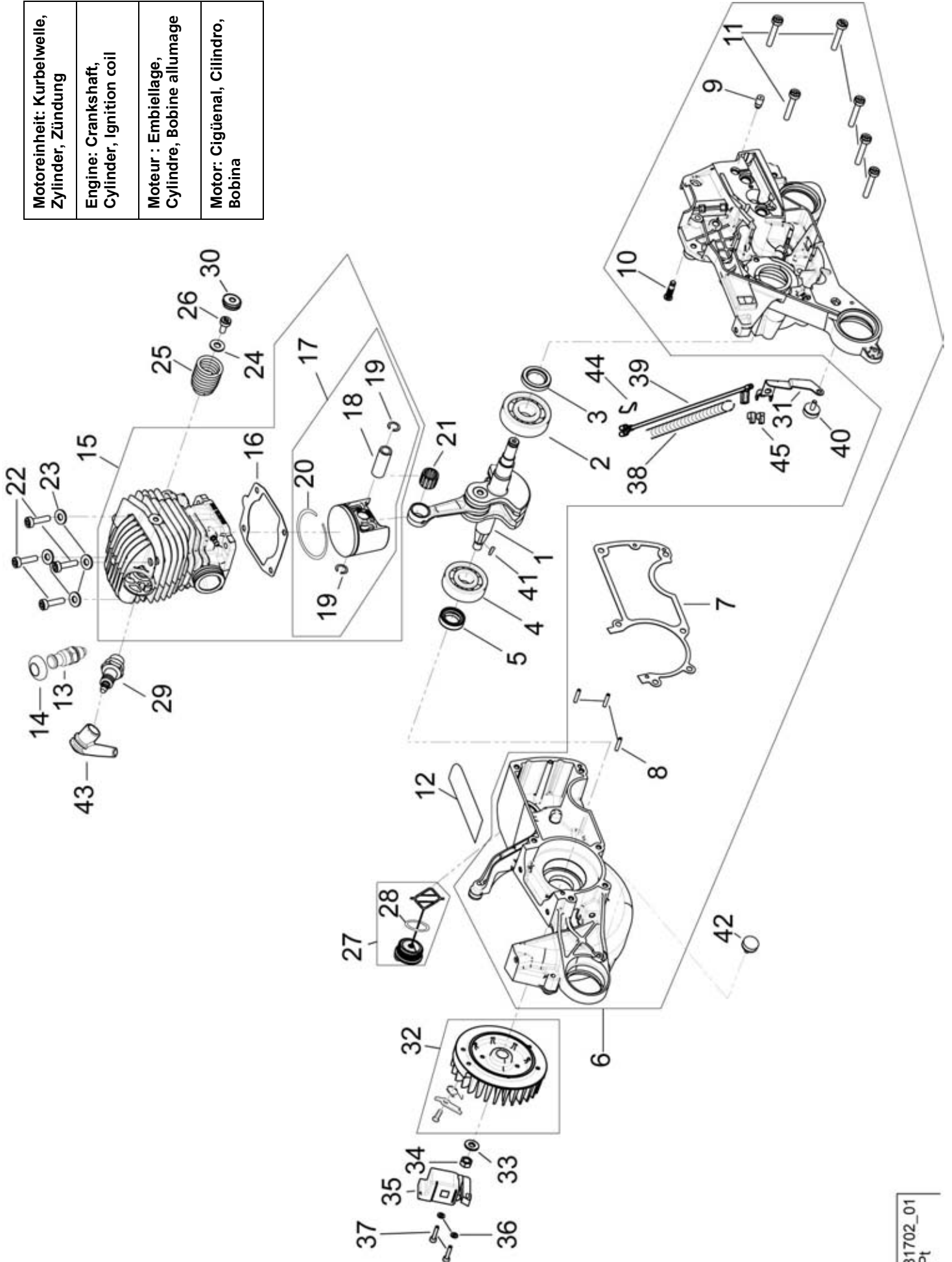
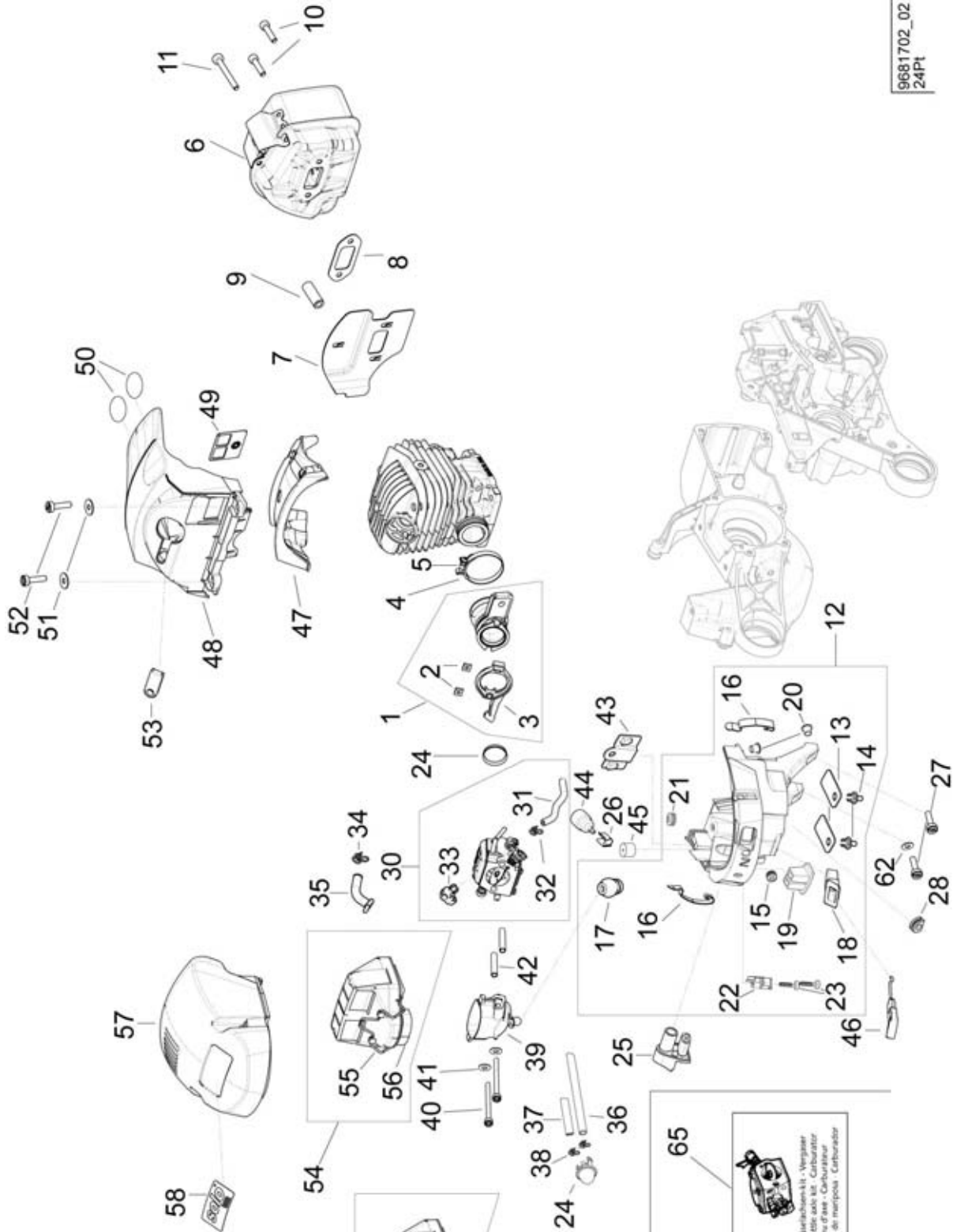

Auspuff, Vergaser, Luffilter, Haube
Exhaust, carburetor, air filter, Cover
Echappement, carburateur, filtre à air, Coquille
Escape, carburador, filtro de aire, Cubierta

63

Dichtungs- Vergaser
Gasket - Air - Carburator
Pochete de joints - Carburador
Juego de juntas - Carburador

64

Reparaturset - Vergaser
Kit de réparation - Carburator
Juego de reparación - Carburador

65

Overhaulkit - Vergaser
Trocable solo kit - Carburator
Juego de meriposa - Carburador

Bild-Nr. Pos.-No. No.Pos. Pos.-No.	Bestell-Nr. Order-No. No. de Cde Ref.-Nr.	Menge Quantity Nombres Cantidad	Auspuff, Vergaser, Luftfilter, Haube	Exhaust, carburetor, air filter, Cover	Echappement, carbureteur, filtre à air, Coquille	Escape, carburador, filtro de aire, Cubierta
1	23 00 652	1	Ansaugschlauch enth. (-> 1 - 3	Suction hose incl. (-> 1 - 3	Tuyau d'aspiration y inclus (-> 1 - 3	Tubo de aspiracion incl. (-> 1 - 3
2	00 21 215	2	Vierkantmutter M4	Nut	Écrou	Tuerca
3	60 74 533	1	Flanschring (-)	Flange ring (-)	Anneau (-)	Anillo (-)
4	00 66 677	1	Schlauchschelle enth. (-> 4, 5	Clamp incl. (-> 4, 5	Collier y inclus (-> 4, 5	Abrazadera incl. (-> 4, 5
5	00 33 119	1	Distanzrohr (-)	Spacer tube (-)	Tube d'entretoise (-)	Tubo espaciador (-)
6	25 00 825	1	Auspuff	Exhaust	Echappement	Escape
7	20 45 762	1	Luftleitblech	Air baffle	Plaque de guide d'air	Chapa de guia de aire
8	20 61 523	1	Dichtung Auspuff	Exhaust gasket	Joint d'échappement	Junta del escape
9	00 33 240	1	Distanzhülse 10x5,4x26,8 mm	Spacer tube	Entretoise	Tubo distanciador
10	00 18 341	2	Zylinderschraube M5x20 mm	Screw	Vis	Tornillo
11	00 18 340	1	Zylinderschraube M5x40 mm	Screw	Vis	Tornillo
12	61 00 476	1	Vergaserboden enth. (-> 12 - 23	Intermediate housing incl. (-> 12 - 23	Carter intermédiaire y inclus (-> 12 - 23	Carter intermedia incl. (-> 12 - 23
13	00 94 339	2	Gummiklappe	Rubber flap	Clapet de gomme	Mariposa de goma
14	60 74 530	2	Spreizniet	Rivet	Rivet	Remache
15	20 63 128	1	Kabeltülle	Bushing	Passe fil	Goma
16	00 73 108 1	2	Federstahlklammer	Fasatening clips	Clips de fixation	Pinza de fijación
17	60 63 354	1	Halterung Ansaugkrümmer	Support	Support	Soporte
18	60 74 540	1	Chokeführung	Choke guide	Guide de choke	Guia del choke
19	60 74 643	1	Dämpfungsplatte	Damping plate	Plaque d'amortisseur	Chapa amortiguadora
20	00 44 248	4	Rohrniet 7x0,7x7,5 mm	Rivet	Rivet	Remache
21	00 66 429	1	Kabeltülle	Bushing	Passe fil	Goma
22	60 74 681	1	Halter Primer	Primer support	Support Primer	Soporte Primer
23	00 18 355	2	Linsenschraube 4x16 mm (-)	Screw (-)	Vis (-)	Tornillo (-)
24	27 00 322	1	Primer	Primer	Pompe d'amorçage	Cabador
25	60 74 541	1	Einstellführung	Setting guide	Guide de réglage	Guia de ajuste
26	00 66 425	1	Schlauchhalter	Clamp support	Support de tuyau	Soporte de abrazadera
27	00 18 337	2	Zylinderschraube M5x20 mm	Screw	Vis	Tornillo
28	00 66 335	1	Tülle 6,5/9x2,2/6,mm	Grommet	Passe fil	Boca
29	60 43 137	1	Einsatz Ansaugschlauch	Suction hose	Tube d'aspiration	Tubo de aspiracion
30	23 00 862	1	Vergaser enth. (-> 30 - 33	Carburetor incl. (-> 30 - 33	Carburateur y inclus (-> 30 - 33	Carburador incl. (-> 30 - 33
31	00 64 353	1	Schlauch Impuls 3x1,5x65 mm	Hose	Tuyau	Tubo
32	00 73 279	1	Schlauchöse 6,5/5,8x0,9x4 mm	Tube eye	Collier en spiral conique	Eje de tubo
33	60 74 531	1	Aufnahme Bowdenzug (-)	Seat (-)	Support (-)	Soporte (-)
34	00 73 205	1	Schlauchöse 5,3 mm	Tube eye	Collier en spiral conique	Eje de tubo
35	60 63 359	1	Schlauch	Hose	Tuyau	Tubo
36	00 64 441	1	Schlauch 3x1,5x200 mm	Hose	Tuyau	Tubo
37	00 64 407	55 mm	Schlauch 2x1,5 mm	Hose	Tuyau	Tubo
38	00 73 434	2	Schlauchöse 5,2 mm	Tube eye	Collier en spiral conique	Eje de tubo
39	23 00 863	1	Ansaugkrümmer	Suction elbow	Coude d'aspiration	Codo de aspiracion
40	00 18 331	2	Zylinderschraube M4x55 mm	Screw	Vis	Tornillo
41	00 34 152	2	Sicherungsscheibe 4 mm	Tension washer	Rondelle de tension	Arandela elastica
42	00 64 328	2	Isolierschlauch 4x0,5x30 mm	Spacer tube	Tuyau d'entretoise	Tubo distanciador
43	60 74 536	1	Stopfen	Plug	Bouchon	Tapon
44	27 00 414	1	Belüftungsstutzen	Ventilation socket	Soupape d'aeration	Munon
45	60 63 301	1	Ring Schlauchfüh. 5x25x20 mm	Hose guide	Mousse de protection durite	Guide tubo
46	28 00 554	1	Chokegestänge	Choke linkage	Tringlerie de choke	Varillaje de choke
47	60 73 702	1	Haubeneinsatz	Cover insert	Piece de coquille	Pieza de union
48	60 73 701	1	Haube	Cover	Coquille	Cubierta
49	60 74 535	1	Einsatz Sommer/Winterbetrieb	Plug	Tampon	Tapon
50	00 68 220	1	Selbstklebeschild "Warnh."	Sticker	Autocollant	Adhesivo
51	00 72 175	2	Scheibe 5,2x15x0,7 mm	Washer	Rondelle	Arandela
52	00 18 337	2	Zylinderschraube M5x20 mm	Screw	Vis	Tornillo
53	60 63 353	1	Kabeldurchführung	Cable guide	Guide de cable	Guia de cable
54	25 00 158	1	Luftfilter Flies enth. (-> 54 - 56	Air filter incl. (-> 54 - 56	Filtre d'air y inclus (-> 54 - 56	Filtro de aire incl. (-> 54 - 56
55	60 36 168	1	Drahtbügel	Clamp	Collier	Abrazadera
56	00 62 278	1	O-Ring 30x1,5 mm (-)	O-ring (-)	Joint torique (-)	Anillo (-)
547	60 73 663	1	Filterhaube	Filter cover	Coquille de filtre	Cubierta de filtro
58	00 68 212	1	SKS SOLO 675	Sticker	Autocollant	Adhesivo
59	25 00 161	1	Luftfilter Nylon enth. (-> 59- 61	Air filter incl. (-> 59- 61	Filtre d'air y inclus (-> 59- 61	Filtro de aire incl. (-> 59- 61
60	60 36 168	1	Drahtbügel	Clamp	Collier	Abrazadera
61	00 62 278	1	O-Ring 30x1,5 mm (-)	O-ring (-)	Joint torique (-)	Anillo (-)
62	00 72 140	1	Scheibe 5,2x12x0,5 mm	Washer	Rondelle	Arandela
63	05 10 794	1	Dichtsatz - Vergaser	Gasket-kit - carburetor	Pochette de joints - carbureteur	Juego de juntas - carburador
64	05 10 793	1	Reparatursatz - Vergaser	Repair-kit - carburetor	Kit de réparation - carbureteur	Juego de reparacion - carburador
65	05 10 795	1	Drosselachsen-kit - Vergaser	Throttle axle kit - carburetor	Jeu d'axe - carbureteur	Juego de mariposa - carburador

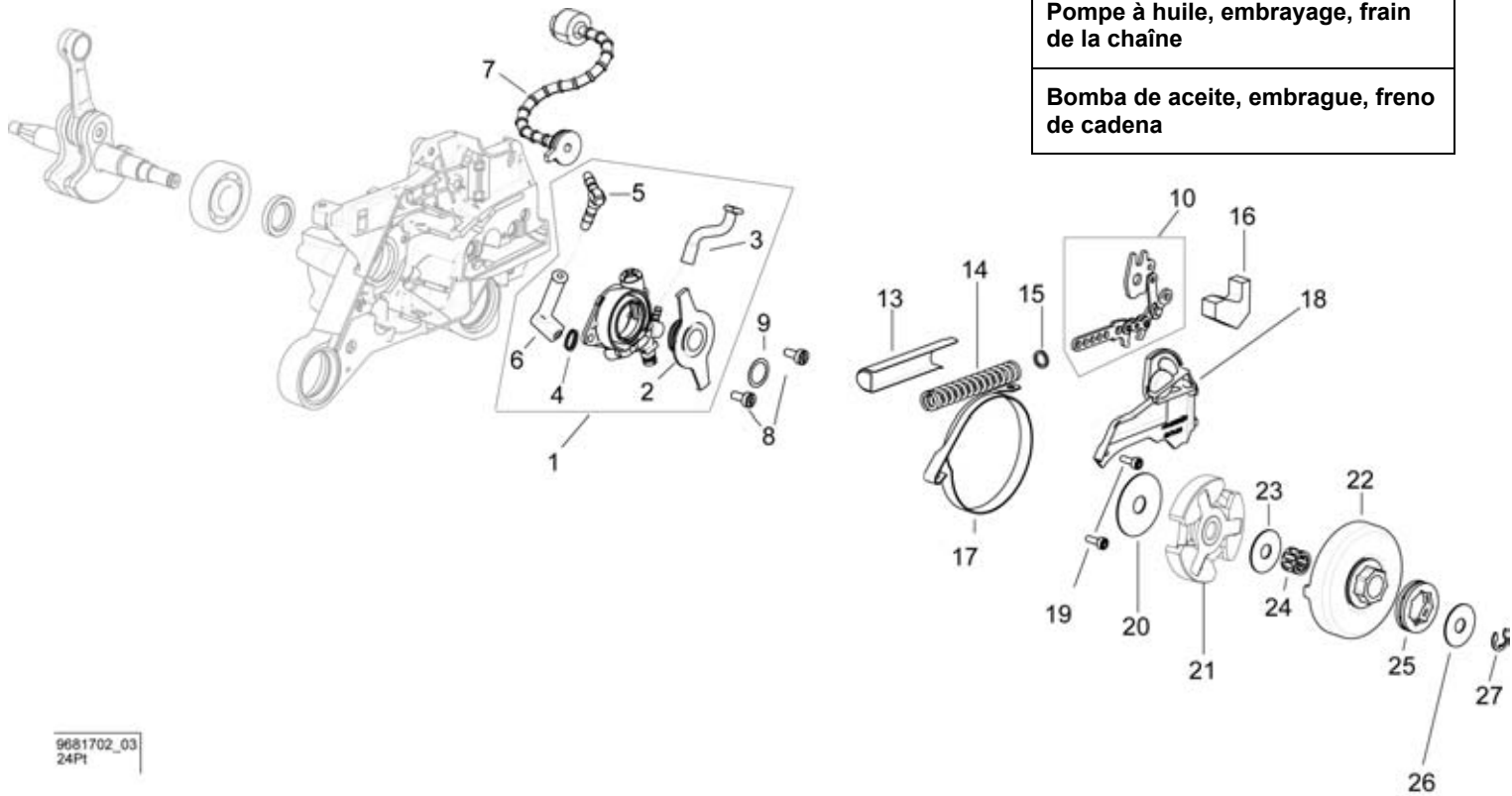

Ölpumpe, Kupplung, Kettenbremse
Oil-pump, clutch, chain brake
Pompe à huile, embrayage, frein de la chaîne
Bomba de aceite, embrague, freno de cadena

9681702_03
24Pt

Bild-Nr. Pos.-No. No.Pos. Pos.-No.	Bestell-Nr. Order-No. No. de Cde Ref.-Nr.	Menge Quantity Nombres Cantidad	Ölpumpe, Kupplung, Kettenbremse	Oil-pump, clutch, chain brake	Pompe à huile, embrayage, frein de la chaîne	Bomba de aceite, embrague, freno de cadena
1	64 00 232	1	Ölpumpe enth. (-> 1 - 6	Oil pump incl. (-> 1 - 6	Pmpe à hulle y inclus (-> 1 - 6	Juego bomba incl. (-> 1 - 6
2	60 74 180	1	Mitnehmerschnecke	Activator	Activateur	Activador
3	60 63 356	1	Ölschlauch	Oil hose	Tuyau d' huile	Tubo de aceite
4	00 73 331	1	Schlauchöse	Tube eye	Oiellet de tuyau	Ojete de tubo
5	00 66 390	1	Stutzen 4x17,5 mm	Elbow	Raccord coude	Racor
6	60 63 355	1	Ölleitung <-)	Oil hose <-)	Tuyau d'huile <-)	Tubo de aceite <-)
7	64 00 231	1	Saugleitung Öl	Suction hose	Tuyau d' aspiration	Tubo de aspiracion
8	00 18 335	2	Zylinderschraube M5x12 mm	Screw	Vis	Tornillo
9	60 42 851	1	Anlaufscheibe	Washer	Rondelle	Arandela
10	63 00 353	1	Ausrückmechanismus	Stopper	Arret	Desembrague
13	60 42 489	1	Federtopf	Spring-pot	Capuchon	Pote
14	00 70 309	1	Druckfeder	Pressure spring	Ressort de tension	Resorte de presion
15	00 31 630	1	Scheibe 9x12 mm	Washer	Rondelle	Arandela
16	60 48 201	1	Schaumstoffplatte	Foam plate	Plaque de caoutchouc mousse	Chapa espumoso
17	62 00 135	1	Bremsband	Brake band	Ruban frein	Cinto del freno
18	60 74 611	1	Bremsbandabdeckung	Brake band cover	Boîte ruban frein	Cubierta del cinta del freno
19	00 18 280	2	Zylinderschraube M4x12 mm	Screw	Vis	Tornillo
20	60 42 850	1	Führungsscheibe	Washer	Rondelle	Arandela
21	35 00 470	1	Kupplung	Centrifugal clutch	Embrayage centrifuge	Embrague centriefugal
22	35 00 261	1	Kupplungstrommel	Clutch drum	Cloche embrayage	Campana embrague
23	00 31 526	1	Scheibe 10x24x1 mm	Washer	Rondelle	Arandela
24	00 52 255	1	Nadelkäfig 10x14x13 mm	Needle sleeve	Douille	Casquillo
25	30 38 399	1	Kettenrad pow/mat 3/8"	Drive sprocket 3/8"	Pignon à bague 3/8"	Anilla de patea para cadena 3/8"
26	60 43 900	1	Topfscheibe	Washer	Rondelle	Arandela
27	00 55 104	1	Sicherungsscheibe 8 mm	Tension washer	Rondelle de tension	Arandela elastica

Starter
Starter
Lanceur
Arranque

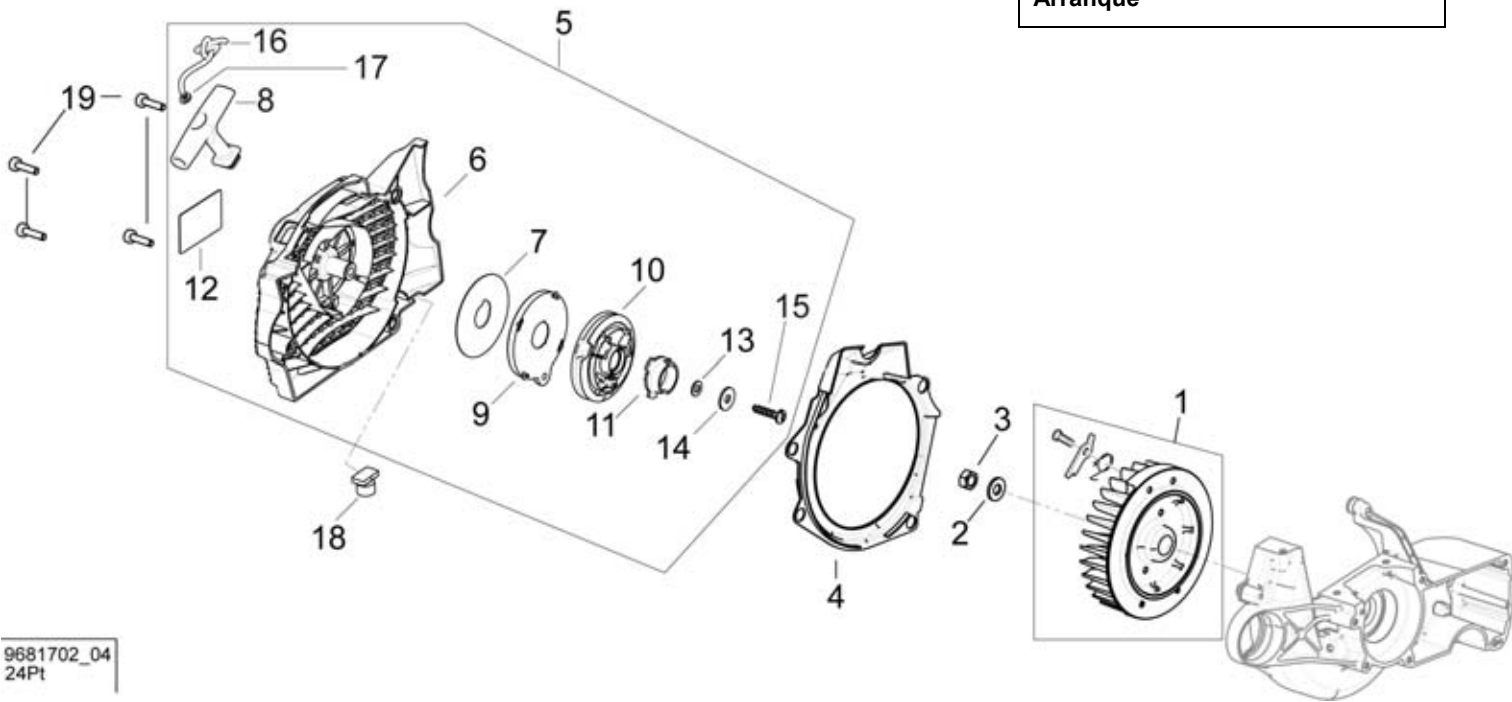

9681702_04
24Pt

Bild-Nr. Pos.-No. No.Pos. Pos.-No.	Bestell-Nr. Order-No. No. de Cde Ref.-Nr.	Menge Quantity Nombres Cantidad	Starter	Starter	Lanceur	Arranque
1	24 00 320	1	Polrad enth. 2 x Klinkenset	Flywheel incl. 2 x starter pawl	Roue polaire y inclus 2 x cliquet de lanceur	Volante incl. 2 x Trinquete
2	00 72 145	1	Sicherungsscheibe 8 mm	Tension washer	Rondelle de tension	Arandela elastica
3	00 20 145	1	Sechskantmutter M8	Nut	Écrou	Tuerca
4	60 74 537	1	Lufführung	Air guide	Guide d'air	Guía de aire
5	26 00 188	1	Starter enth. (-> 5 - 17	Starter compl. incl. (-> 5 - 17	Lanceur compl. y inclus (-> 5 - 17	Arranque compl. incl. (-> 5 - 17
6	26 00 336	1	Startergehäuse	Starter housing	Carter lanceur	Caja de arranque
7	60 42 601	1	Ausgleichsscheibe	Washer	Rondelle	Arandela
8	60 74 709	1	Startergriff	Starter handle	Poignée de lanceur	Empunadura
9	26 00 326	1	Rückholfeder	Recoil spring	Ressort de rappel	Resorte de retroceso
10	60 74 621	1	Seilrolle	Rope pulley	Poulie de câble	Roldana
11	60 45 641	1	Buchse für Seilrolle	Bushing	Douille	Cojinete
12	00 69 889	1	Selbstklebeschild SOLO	Decal "SOLO"	Autocollant "SOLO"	Etiqueta "SOLO"
13	00 34 107	1	Federscheibe	Spring washer	Rondelle elastique	Arandela de resorte
14	00 30 125	1	Scheibe 6,4 mm	Washer	Rondelle	Arandela
15	00 18 371	1	Linsenschraube 6x25 mm	Screw	Vis	Tornillo
16	00 63 186 25	1	Starterseil	Starter rope	Câble de lanceur	Cuerda de arranque
17	00 72 148	1	Sicherungsscheibe 4 mm (-)	Tension washer (-)	Rondelle de tension (-)	Arandela elastica (-)
18	60 63 346	1	Gi. Element	Rubber element	Element de gomme	Elemento de goma
19	00 18 337	4	Zylinderschraube M5x20 mm	Screw	Vis	Tornillo

Handgriff / Hauptgehäuse, Haltebügel, Handschutz
Handle bar / main housing, hand protection
Etrier / carter principal, protège main
Asa / carter principal, proteccion de mano



Bild-Nr. Pos.-No. No.Pos. Pos.-No.	Bestell-Nr. Order-No. No. de Cde Ref.-Nr.	Menge Quantity Nombres Cantidad	Handgriff / Hauptgehäuse, Haltebügel, Handschutz	Handle bar / main housing, hand protection	Etrier / carter principal, protège main	Asa / carter principal, proteccion de mano
1	21 00 934	1	Kurbelgehäuse enth. (-> 1 - 6	Crankcase incl. (-> 1 - 6	Carter-moteur y inclus (-> 1 - 6	Carter cigüenal incl. (-> 1 - 6
2	20 61 526	1	Kurbelgehäusedichtung	Gasket	Joint	Junta
3	00 40 166	3	Stift 3 M6x16mm	Pin	Goujon cylindrique	Pasador cil.
4	27 00 441	1	Belüftungsventil	Ventilation valve	Valve de ventilation	Valvula de ventilacion
5	20 31 250	1	Einpressbolzen	Bolt	Axe	Bulon
6	00 18 339	6	Zylinderschraube M5x30 mm (-)	Screw (-)	Vis (-)	Tornillo (-)
7	20 42 875	1	Isolierfolie	Isolating foil	Feuille isolatrice	Laminilla
8	27 00 445	1	Tankverschluss Öl enth. (-> 8, 9	Tank cap incl. (-> 8, 9	Bouchon réservoir y inclus (-> 8, 9	Tapa de deposito incl. (-> 8, 9
9	00 62 347	1	O-Ring 25x3 mm (-)	Gasket (-)	Joint (-)	Junta (-)
10	63 00 270	1	Federlagerung Zünderseite kpl.	Spring seat	Bride de ressort formant palier	Apoyo del resorte
11	63 00 271	1	Federlagerung hinten kpl.	Spring seat	Bride de ressort formant palier	Apoyo del resorte
12	63 00 272	1	Federlagerung vorne kpl.	Spring seat	Bride de ressort formant palier	Apoyo del resorte
13	63 00 210	1	Anschlagkralle enth. (-> 13, 14	Bucking spike incl. (-> 13, 14	Griffe de butée y inclus (-> 13, 14	Garra de apoyo incl. (-> 13, 14
14	00 20 101	1	Sechskantmutter M5 (-)	Nut (-)	Écrou (-)	Tuerca (-)
15	00 18 335	1	Zylinderschraube M5x12 mm	Screw	Vis	Tornillo
16	604390201	1	Kettenfänger	Chain catcher	Boulon de chaine	Disp. de seguridad
17	00 72 144	1	Sicherungsscheibe 5 mm	Tension washer	Rondelle de tension	Arandela elastica
18	00 18 336	1	Zylinderschraube M5x16 mm	Screw	Vis	Tornillo
19	60 43 938	1	Klammer Massearm	Clamp	Collier	Abrazadera
20	61 00 482	1	Griffgehäuse komplett enth. (-> 20 - 47	Handle housing incl. (-> 20 - 47	Carter de poignee y inclus (-> 20 - 47	Carter de empunadura incl. (-> 20 47
22	61 00 481	1	Griffgehäuse	Handle housing	Carter de poignee	Carter de empunadura
23	80 63 248	1	Tülle	hose fitting	oeillet	manguito de cable
24	60 63 340	1	Kaftstoffschlauch	Fuel hose	Tuyau	Tubo
25	00 73 351	1	Schlauchöse	Tube eye	Collier	Ojete
26	27 00 135	1	Filter Benzinsucher	Fuel pick-up	Crépine d'essence	Filtro
27	60 74 403	1	Umlenkhebel	Deflection lever	Levier	Palanca
28	00 40 186	2	Stift 3 M6x24 mm	Nail	Goujon	Clavo
29	00 73 431	1	Zugfeder	Tension spring	Ressort de tension	Resorte de tension
30	60 74 402	1	Sicherheitssperre	Ratchet	Touche a accrochage	Tecla de cierre
31	28 00 587	1	Bowdenzug	Bowden cable	Cable bowden	Cable bowden
32	60 74 404	1	Gashebel	Gas lever	Gachette gaz	Acelerador
33	00 84 478	1	Blindkappe	Blind cap	Capuchon aveugle	Caperuza loca
34	00 84 888	1	Kurzschlusschalter	Short circuit switch	Interrupteur	Interruptor
35	60 73 661	1	Griffschale oben	Grip cup red	Capsule d'etrier	Cascara
36	00 18 274	1	Linsenschraube 5x16 mm	Screw	Vis	Tornillo
37	00 66 390	1	Stutzen 4x17,5 mm	Elbow	Raccord coude	Racor
38	00 64 320	0,11 m	Schlauch 3,2x5,3 mm	Hose	Tuyau	Tubo
39	00 64 469	1	Schlauch 6x120 mm	Hose	Tuyau	Tubo
40	68 00 144	1	Haltebügel enth. (-> 40 - 43	Handle bar incl. (-> 40 - 43	Etrier y inclus (-> 40 - 43	Estribo incl. (-> 40 - 43
41	60 43 130	1	Flanschblech	Flange plate	Plaque de bride	Chapa de brida
42	00 21 241	2	Vierkantmutter M5	Nut	Écrou	Tuerca
43	00 18 335	2	Zylinderschraube M5x12 mm (-)	Screw (-)	Vis (-)	Tornillo (-)
44	27 00 445	1	Tankverschluss Benzin enth. (-> 44, 45	Tank cap incl. (-> 44, 45	Bouchon réservoir y inclus (-> 44, 45	Tapa de deposito incl. (-> 44, 45
45	00 62 347	1	O-Ring 25x3 mm (-)	Gasket (-)	Joint (-)	Junta (-)
46	00 18 363	4	Linsenschraube 5x20 mm	Screw	Vis	Tornillo
47	00 94 294	1	Puffer (-)	Buffer (-)	Butee caoutchouc (-)	Tope (-)
48	00 72 141	1	Scheibe 9,2x18x0,7 mm	Washer	Rondelle	Arandela
49	00 10 362	1	Zylinderschraube M8x12 mm	Screw	Vis	Tornillo
50	00 64 469	1	Schlauch 6x120 mm	Hose	Tuyau	Tubo
51	00 84 898	1	Masseleitung	Ground cable	Cable de masse	Cable de masa
52	00 94 246	1	Gi.Metall	Rubber element	Element de gomme	Elemento av
54	00 66 164	2	Tülle	Grommet	Passe fil	Boca
55	60 73 700	1	Handschutz	Hand protection	Protège main	Proteccion de mano
56	00 40 174	1	Stift M6x12 mm	Pin	Goujon cylindrique	Pasador cil.
57	60 31 666	1	Buchse	Sleeve	Douille	Casquillo
58	00 18 341	1	Zylinderschraube M5x20 mm	Screw	Vis	Tornillo
59	63 00 353	1	Ausrückmechanismus	Stopper	Arret	Desembrague
62	00 72 140	1	Scheibe 5,2x12x0,5 mm	Washer	Rondelle	Arandela
63	00 18 337	1	Zylinderschraube M5x20 mm	Screw	Vis	Tornillo
64	60 42 489	1	Federtopf	Spring-pot	Capuchon	Pote
65	00 70 309	1	Druckfeder	Pressure spring	Ressort de tension	Resorte de presion
66	00 31 630	1	Scheibe 9x12 mm	Washer	Rondelle	Arandela
67	60 48 201	1	Schaumstoffplatte	Foam plate	Plaque de caoutchouc mousse	Chapa espumoso
68	62 00 135	1	Bremsband	Brake band	Ruban frein	Cinto del freno
69	60 74 611	1	Bremsbandabdeckung	Brake band cover	Boîte ruban frein	Cubierta del cinta del freno
70	00 18 280	2	Zylinderschraube M4x12 mm	Screw	Vis	Tornillo
71	60 42 850	1	Führungsscheibe	Washer	Rondelle	Arandela

Schwert, Kette, Anschlagkralle, Kettenspannung
Guide bar, chain, bucking spike, Tension screw / tension carriage
Guide chaîne, chaîne, griffe de butée, Vis de tension
Espada, cadena, garra de apoyo, Tornillo de tension

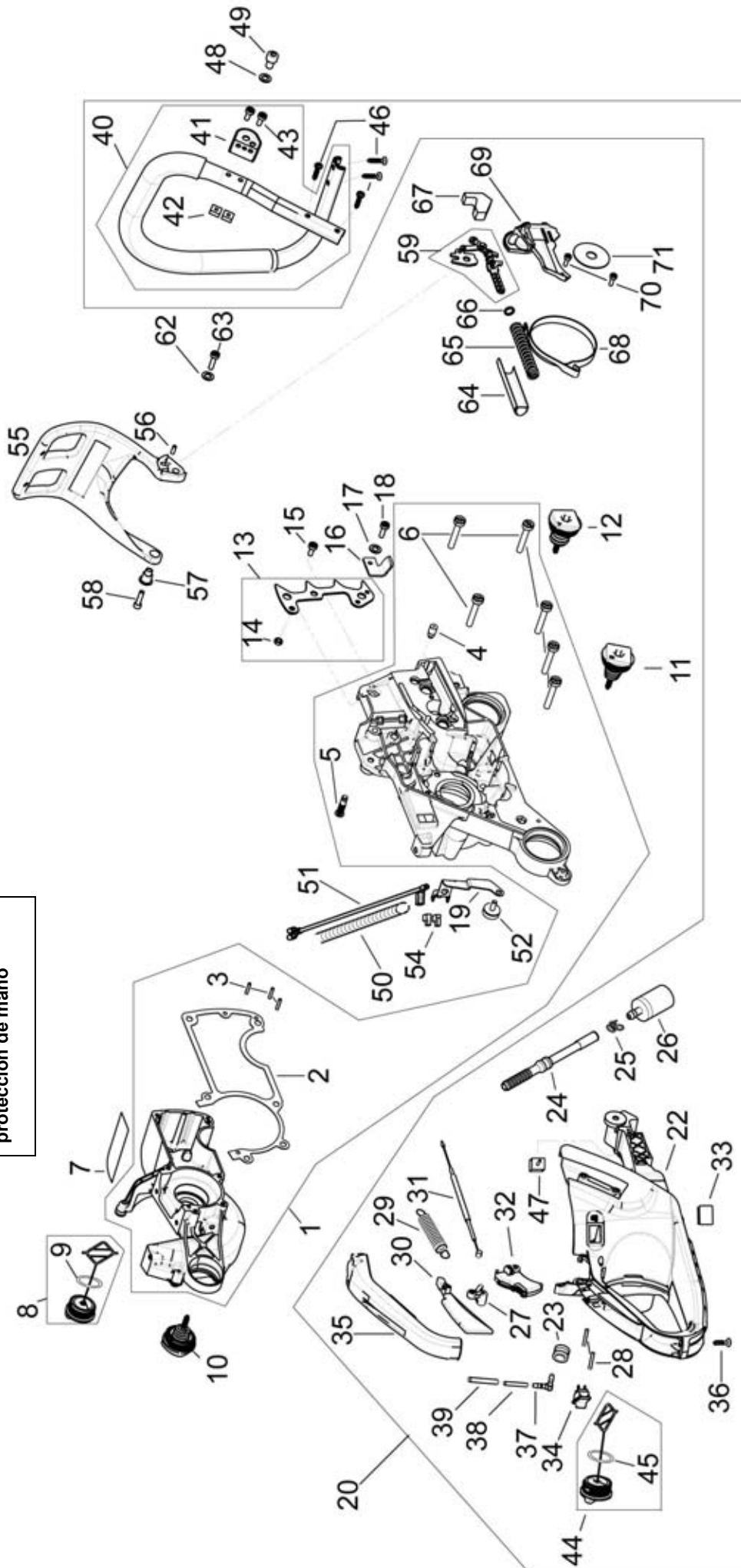
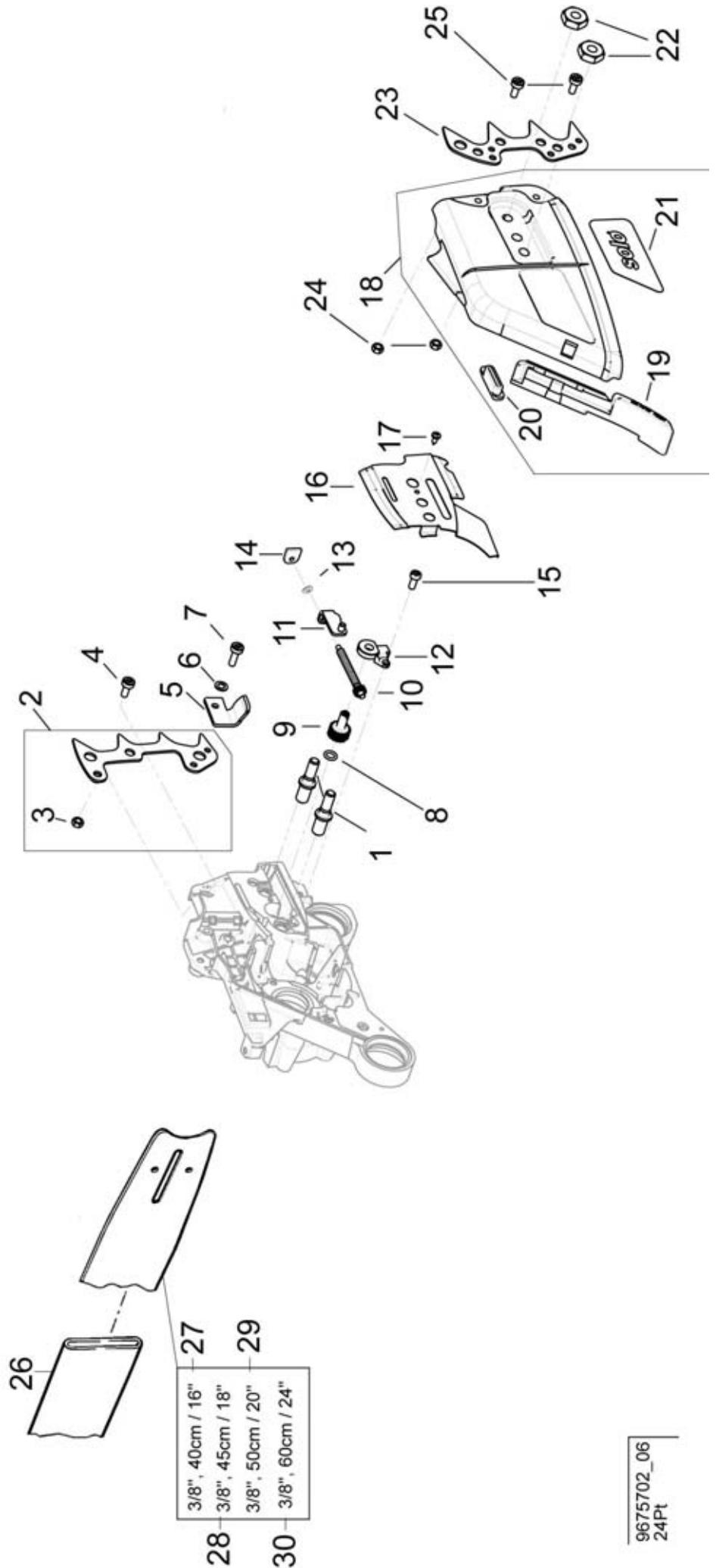
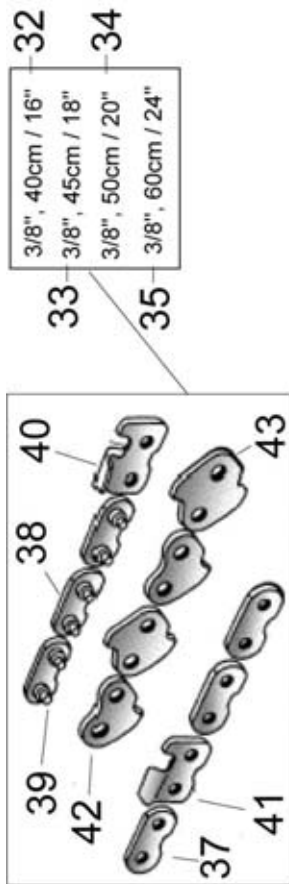

9675702_06
24Pt

Bild-Nr. Pos.-No. No.Pos. Pos.-No.	Bestell-Nr. Order-No. No. de Cde Ref.-Nr.	Menge Quantity Nombres Cantidad	Schwert, Kette, Anschlagkralle, Kettenspannung	Guide bar, chain, bucking spike, Tension screw / tension carriage	Guide chaîne, chaîne, griffe de butée, Vis de tension	Espada, cadena, garra de apoyo, Tornillo de tension
1	00 18 450	2	Schwertschraube	Screw	Vis	Tornillo
2	63 00 210	1	Anschlagkralle enth. (-> 51 - 52	Bucking spike incl. (-> 51 - 52	Griffe de butée y inclus (-> 51 - 52	Garra de apoyo incl. (-> 51 - 52
3	00 20 101	1	Sechskantmutter M5 (-)	Nut (-)	Écrou (-)	Tuerca (-)
4	00 18 335	1	Zylinderschraube M5x12 mm	Screw	Vis	Tornillo
5	604390201	1	Kettenfänger	Chain catcher	Boulon de chaîne	Disp. de seguridad
6	00 72 144	1	Sicherungsscheibe 5 mm	Tension washer	Rondelle de tension	Arandela elastica
7	00 18 336	1	Zylinderschraube M5x16 mm	Screw	Vis	Tornillo
8	00 62 174	1	O-Ring 7x2 mm	Tension washer	Rondelle de tension	Arandela elastica
9	60 31 306	1	Einstellschraube	F. H. Screw	Vis t. c.	Tornillo
10	20 38 400	1	Spannschraube M6	Tornillo de tension	Vis de tension	Tornillo de tension
11	63 00 346	1	Kettenspannbolzen M6	Chain pulling bolt	Boulon de tension de chaîne	Perno de tension de cadena
12	60 74 124	1	Getriebeabdeckung	Gear cover	Couvercle de engrenage	Tapa de engranaje
13	00 31 572	1	Scheibe 4x8x0,5 mm	Washer	Rondelle	Arandela
14	60 74 125	1	Lagerung	Support	Support	Soporte
15	00 18 449	1	Zylinderschraube M5x12 mm	Screw	Vis	Tornillo
16	60 43 681	1	Kettenschutzblech	Chain protection plate	Toile de protection de chaîne	Chapa de proteccion de cadena
17	00 10 427	1	Blechschrabe 3,5x9,5 mm	Screw	Vis	Tornillo
18	61 00 463	1	Schwertabdeckung enth. (-> 18 - 21	Chain guard incl. (-> 18 - 21	Carter de chaîne y inclus (-> 18 - 21	Cubierta espada incl. (-> 18 - 21
19	00 94 178	1	Prallschutz	Baffle protection	Protection	Proteccion
20	60 74 910	1	Gleitschuh	Guide shoe	Patin	Patin
21	00 68 247	1	Selbstklebeschild SOLO (-)	Sticker (-)	Autocollant (-)	Adhesivo (-)
22	00 20 214	2	Sechskantmutter M8	Nut	Écrou	Tuerca
23	60 43 920	1	Anschlagkralle Aussen	Bucking spike	Griffe de butée	Garra de apoyo
24	00 28 137	2	Sechskantmutter M5	Nut	Écrou	Tuerca
25	00 18 335	2	Zylinderschraube M5x12 mm	Screw	Vis	Tornillo
26	60 71 253	1	Kettenschutz	Scabblad	Fourreau de chaîne	Proteccion cadena
27	69 00 368	1	Führungsschiene, 3/8", 40 cm (16")	Guide bar, 3/8", 40 cm (16")	Guide, 3/8", 40 cm (16")	Espada, 3/8", 40 cm (16")
28	69 00 498	1	Führungsschiene, 3/8", 45 cm (18")	Guide bar, 3/8", 45 cm (18")	Guide, 3/8", 45 cm (18")	Espada, 3/8", 45 cm (18")
29	69 00 370	1	Führungsschiene, 3/8", 50 cm (20")	Guide bar, 3/8", 50 cm (20")	Guide, 3/8", 50 cm (20")	Espada, 3/8", 50 cm (20")
30	69 00 372	1	Führungsschiene, 3/8", 60 cm (24")	Guide bar, 3/8", 60 cm (24")	Guide, 3/8", 60 cm (24")	Espada, 3/8", 60 cm (24")
32	69 00 872	1	Vollmeiselkette 40 cm (16") 3/8 " 60 Treibglieder enth. (-> 37 - 43	Chain 16" (40 cm) incl. (-> 37 - 43	Chaîne 16" (40 cm) y inclus (-> 37 - 43	Cadena 16" (40 cm) incl. (-> 37 - 43
33	69 00 873	1	Vollmeiselkette 45 cm (18") 3/8 " 68 Treibglieder enth. (-> 37 - 43	Chain 18" (45 cm) incl. (-> 37 - 43	Chaîne 18" (45 cm) y inclus (-> 37 - 43	Cadena 18" (45 cm) incl. (-> 37 - 43
34	69 00 874	1	Vollmeiselkette 50 cm (20") 3/8 " 72 Treibglieder enth. (-> 37 - 43	Chain 20" (50 cm) incl. (-> 37 - 43	Chaîne 20" (50 cm) y inclus (-> 37 - 43	Cadena 20" (50 cm) incl. (-> 37 - 43
35	69 00 888	1	Vollmeiselkette 60 cm (24") 3/8 " 84 Treibglieder enth. (-> 37 - 43	Chain 24" (60 cm) incl. (-> 37 - 43	Chaîne 24" (60 cm) y inclus (-> 37 - 43	Cadena 24" (60 cm) incl. (-> 37 - 43
37	05 40 184		Verbindungsglied, ohne Niet	Connection link w/o rivet	Maillon sans rivet	Eslabon de connexion
38	05 40 185		Verbindungsglied mit Niet	Connection link with rivet	Maillon avec rivet	Eslabon con remache
39	05 40 188		Niet	Rivet	Rivet	Remache
40	05 40 182		Linksschneider	Left cutter	Gouge gauche	Cortador izquierda
41	05 40 183		Rechtsschneider	Right cutter	Gouge droite	Cortador derecha
42	05 40 228		Treibglied	Drive link	Maillon entraineur	Eslabon de mango
43	05 40 275		Sicherheitstreibglied (-)	Safety conn. (-)	Maillon de sécurité (-)	Eslabon (-)

Bestell-Nr. Order-No. No. de Cde Ref.-Nr.	Menge Quantity Nombres Cantidad	Seite Page Page Pagina
00 10 362	1	8
00 10 427	1	10
00 10 604	4	2
00 15 111	1	2
00 18 274	1	8
00 18 280	2	6, 8
00 18 327	2	2
00 18 331	2	4
00 18 335	1, 2, 1, 2, 1, 2	2, 6, 8, 8, 10, 10
00 18 336	1, 1	8, 10
00 18 337	2, 2, 4, 1	4, 4, 7, 8
00 18 339	6, 6	2, 8
00 18 340	1	4
00 18 341	2, 1	4, 8
00 18 355	2	4
00 18 363	4	8
00 18 371	1	7
00 18 449	1	10
00 18 450	2	10
00 20 101	1, 1	8, 10
00 20 145	1, 1	2, 7
00 20 214	2	10
00 21 215	2	4
00 21 241	2	8
00 28 137	2	10
00 30 125	1	7
00 31 526	1	6
00 31 572	1	10
00 31 630	1, 1	6, 8
00 33 119	1	4
00 33 240	1	4
00 34 107	1	7
00 34 152	2	4
00 40 166	3, 3	2, 8
00 40 174	1	8
00 40 186	2	8
00 44 248	4	4
00 50 183	1	2
00 50 186	1	2
00 52 236	1	2
00 52 255	1	6
00 54 143	1	2
00 54 159	1	2
00 55 104	1	6
00 55 266	2	2
00 62 174	1	10
00 62 278	1,1	4, 4
00 62 347	1, 1, 1	2, 8, 8
00 63 186 25	1	7
00 64 320	0,11 m	8
00 64 328	2	4
00 64 353	1	4
00 64 407	55 mm	4
00 64 441	1	4

Bestell-Nr. Order-No. No. de Cde Ref.-Nr.	Menge Quantity Nombres Cantidad	Seite Page Page Pagina
00 64 469	1, 1, 1	2, 8, 8
00 66 164	2, 2	2, 8
00 66 335	1	4
00 66 390	1, 1	6, 8
00 66 425	1	4
00 66 429	1	4
00 66 677	1	4
00 68 212	1	4
00 68 220	1	4
00 68 247	1	10
00 69 889	1	7
00 70 309	1, 1	6, 8
00 70 309	1	8
00 72 140	1, 1	4, 8
00 72 141	1	8
00 72 143	1	2
00 72 144	4, 1, 1	2, 8, 10
00 72 145	1, 1	2, 7
00 72 148	2, 1	2, 7
00 72 175	2	4
00 73 108 1	2	4
00 73 205	1	4
00 73 264	1	2
00 73 279	1	4
00 73 331	1, 1	6, 8
00 73 431	1	8
00 73 433	2	2
00 73 434	2	4
00 75 101	1	2
00 84 478	1	8
00 84 888	1	8
00 84 897	1	2
00 84 898	1, 1	2, 8
00 94 178	1	10
00 94 246	1, 1	2, 8
00 94 247	1	2
00 94 270	1	2
00 94 294	1	8
00 94 339	2	4
05 10 793	1	4
05 10 794	1	4
05 10 795	1	4
05 40 182		10
05 40 183		10
05 40 184		10
05 40 185		10
05 40 188		10
05 40 228		10
05 40 275		10
20 31 233 25	1	2
20 31 250	1, 1	2, 8
20 38 400	1	10
20 42 875	1, 1	2, 8
20 45 762	1	4

Bestell-Nr. Order-No. No. de Cde Ref.-Nr.	Menge Quantity Nombres Cantidad	Seite Page Page Pagina
20 48 259	1	2
20 61 523	1	4
20 61 525	1	2
20 61 526	1, 1	2, 8
20 63 128	1	4
21 00 934	1, 1	2, 8
22 00 514	1	2
22 00 521	1	2
22 00 681 52	1	2
23 00 652	1	4
23 00 730	1	2
23 00 852	1	2
23 00 862	1	4
23 00 863	1	4
24 00 320	1, 1	2, 7
25 00 158	1	4
25 00 161	1	4
25 00 825	1	4
26 00 188	1	7
26 00 326	1	7
26 00 336	1	7
27 00 135	1	8
27 00 322	1	4
27 00 414	1	4
27 00 441	1, 1	2, 8
27 00 445	1, 1, 1	2, 8, 8
28 00 554	1	4
28 00 587	1	8
28 00 681	1	2
30 38 399	1	6
35 00 261	1	6
35 00 470	1	6
60 31 306	1	10
60 31 666	1	8
60 36 168	1	4
60 36 168	1	4
60 42 489	1, 1	6, 8
60 42 601	1	7
60 42 850	1, 1	6, 8
60 42 851	1	6
60 43 130	1	8
60 43 137	1	4
60 43 681	1	10
60 43 900	1	6
60 43 902 01	1, 1	8, 10
60 43 920	1	10
60 43 938	1, 1	2, 8
60 45 641	1	7
60 48 201	1, 1	6, 8
60 63 301	1	4
60 63 340	1	8
60 63 346	1	7
60 63 353	1	4
60 63 354	1	4

Bestell-Nr. Order-No. No. de Cde Ref.-Nr.	Menge Quantity Nombres Cantidad	Seite Page Page Pagina
60 63 355	1	6
60 63 356	1	6
60 63 359	1	4
60 71 253	1	10
60 73 661	1	8
60 73 663	1	4
60 73 700	1	8
60 73 701	1	4
60 73 702	1	4
60 74 124	1	10
60 74 125	1	10
60 74 180	1	6
60 74 402	1	8
60 74 403	1	8
60 74 404	1	8
60 74 530	2	4
60 74 531	1	4
60 74 533	1	4
60 74 535	1	4
60 74 536	1	4
60 74 537	1	7
60 74 540	1	4
60 74 541	1	4
60 74 611	1, 1	6, 8
60 74 621	1	7
60 74 643	1	4
60 74 681	1	4
60 74 709	1	7
60 74 910	1	10
61 00 463	1	10
61 00 476	1	4
61 00 481	1	8
61 00 482	1	8
62 00 135	1, 1	6, 8
63 00 210	1, 1	8, 10
63 00 270	1	8
63 00 271	1	8
63 00 272	1	8
63 00 346	1	10
63 00 353	1, 1	6, 8
64 00 231	1	6
64 00 232	1	6
68 00 144	1	8
69 00 368	1	10
69 00 370	1	10
69 00 372	1	10
69 00 498	1	10
69 00 872	1	10
69 00 873	1	10
69 00 874	1	10
69 00 888	1	10
80 63 248	1	8

D**Allgemeine Richtlinien für die Bestellung von Original SOLO Ersatzteilen:**

Voraussetzung für eine reibungslose Erledigung sind folgende Angaben:

1. Ersatzteil-Bestellnummer
2. Gewünschte Anzahl
3. Typenbezeichnung des Geräts

Diese Ersatzteilliste ist für die Lieferung und Ausstattung von SOLO Erzeugnissen unverbindlich.

Im Interesse der technischen Weiterentwicklung bleiben Konstruktionsänderungen vorbehalten.

GB**General Directions for Ordering Original SOLO Spare Parts:**

For correct and diligent processing of your order, please give the following information:

1. Spare Part number
2. Quantity
3. Model and serial number
4. Shipping instructions

Delivery is made in accordance with our general sales and delivery conditions. This spare parts list is non-committal for us with regard to delivery and layout of SOLO products.

In favour of technical improvements, design modifications are subject to change without notice.

F**Directives générales pour les commandes de pièces de rechange d'origine SOLO:**

Il est indispensable de préciser dans toutes les commandes de pièces:

1. le numéro de référence de la pièce
2. la quantité
3. le type de la machine
4. le mode d'expédition

Les livraisons sont effectuées dans le cadre de nos conditions générales de vente.

Toutes modifications réservées.

E**Directivas Generales de pedido de la firma SOLO:**

Por adelantado de un arreglo sin dificultades necesitamos siguientes indicaciones:

1. Número de repuesto
2. Numero de cantidad
3. Modelo y número de serial
4. Instrucción de Envío

Esta lista de repuestos no es obligatoria para los envíos y/o forma de equipo de los productos SOLO.

En el interés del constante desarrollo debemos reservarnos el derecho de cambios.