

SURE STAND

SECURITY POLE

A man with grey hair, wearing a light pink short-sleeved button-down shirt and light-colored trousers, is smiling and leaning on a black Sure Stand Security Pole. He is holding the horizontal handrails with both hands. The pole is positioned in a well-lit living room. In the background, there is a white desk with a small basket on it, a light-colored sofa with patterned pillows and a white blanket, a window with white blinds, and a black floor lamp. The overall atmosphere is bright and comfortable.

When you start counting your age in decades instead of years, there's much to look back on. You've built a life to be proud of, and worked hard for the independence that you have. Don't let anything take that hard won freedom away. With its tension mounted design, the Sure Stand Pole can help you when you need to stand, anywhere in your house. Not content to take things sitting down, we've made a way to ensure you can continue to get up and stand for something.

PRODUCT #93471
PRODUCT #93472

FEATURES

WHAT CUSTOMERS ARE SAYING

BILL

"I have three of the Security Poles now. I often wonder how I got along without them. My knees are bad and the Security Pole lets me get up from a low chair without a lot of pain."

JANET

"We have two of these poles, otherwise it would be very hard for my husband to be at home. I don't know what we would do without it. It is a terrific item and I cannot say enough good things about it."



You love the comforting feeling of your home, and now, with the Sure Stand Security Pole, you can have the support you need to stand safely without changing the look and feel of your home. The Sure Stand Security Pole is tension mounted, so it can be installed anywhere in the home without drilling holes in your floor or ceiling.*



HELPFUL TIP: The most common place in the home for falls is in the bathroom, so place the Sure Stand Pole between the tub/shower and toilet, then position the handles to be used for both getting in and out of the shower, and on and off the toilet.

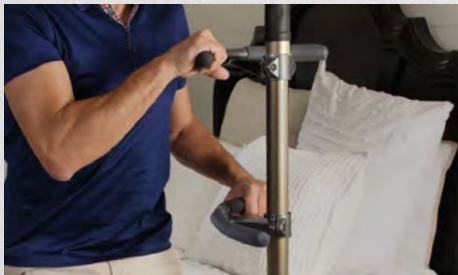

SURE STAND HAND GRIPS

Dual hand grips make it easy to climb to a standing position



EASY INSTALLATION

Installs in less than 15 minutes. No screws or bolts required*



IDEAL FOR BATHROOM

Place between the shower and toilet for an extra handle to help prevent falls



UNIVERSAL FIT

Can be installed on either flat or vaulted ceilings*

*Pole must be screwed in for vaulted ceilings

SPECIFICATIONS

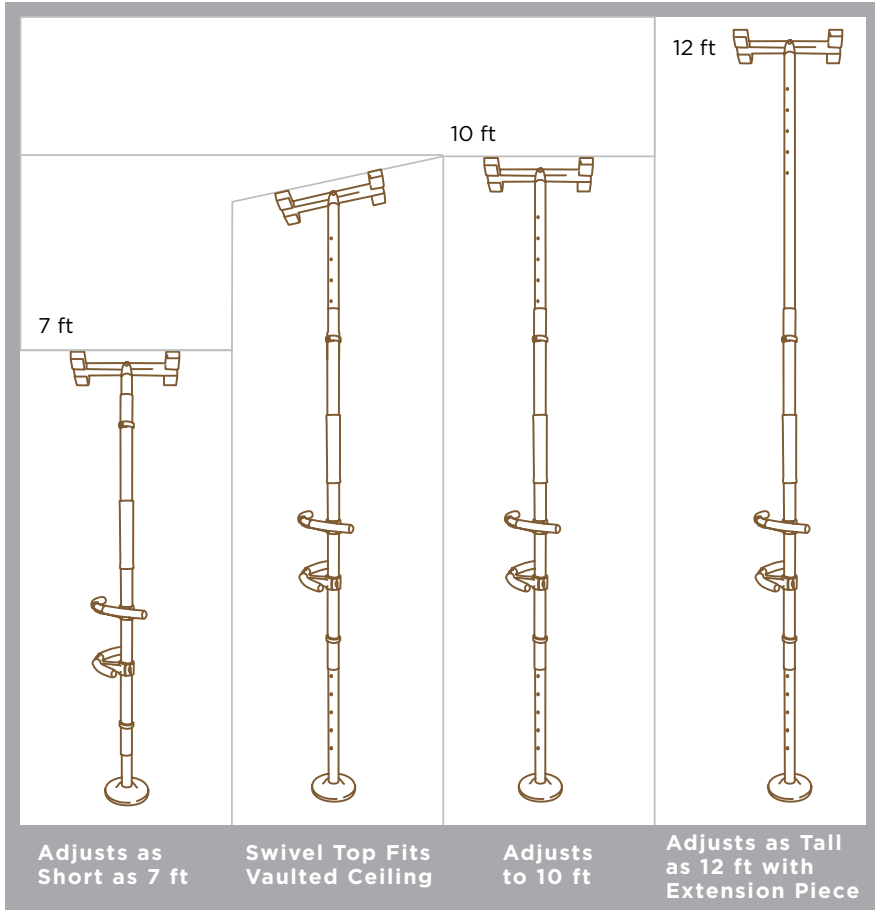

HEIGHT ADJUSTMENT





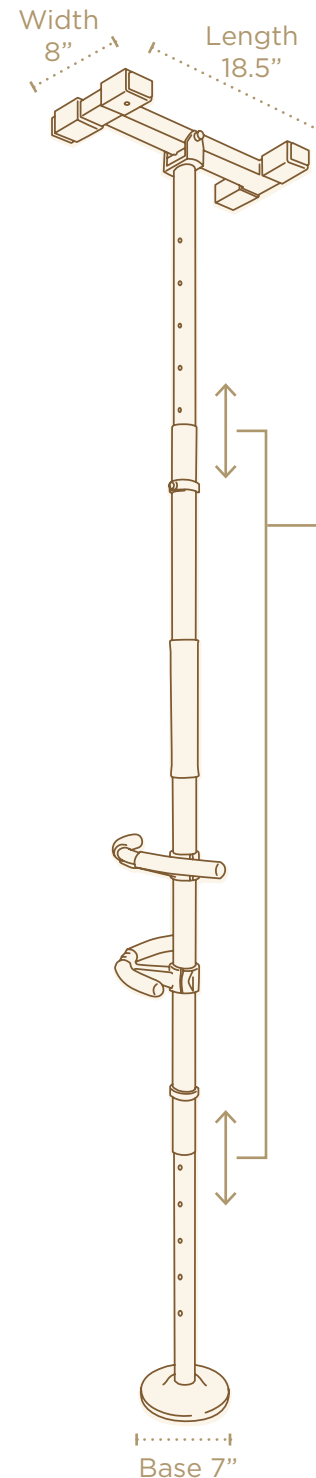
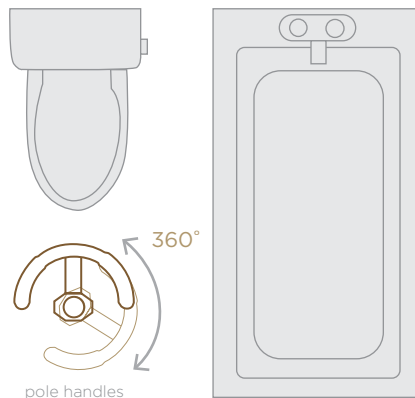

USE IN BATHROOM

Because the handles can rotate 360° around the pole it allows you to place them in the optimal position for use in the bathroom.



PRODUCT #93471
PRODUCT #93472



THE DETAILS

-  **WEIGHT CAPACITY**
Supports up to 300 lbs
-  **PRODUCT WEIGHT**
Product weights 16.5 lbs
-  **MATERIALS**
Rust resistant aluminum with durable anodized finish
-  **ADJUSTABLE**
Pole extends to fit ceiling heights from 7- 10 ft. Extension piece sold separately for 12 ft ceilings. #93481 & #93482
-  **CEILING TYPES**
Fits flat and vaulted ceilings*
-  **CUSTOMIZE**
Handles can be placed anywhere 360° on the pole and at most heights
-  **PACKAGE DIMENSIONS**
4.5" H x 37" L x 8.5" W
-  **CASE DIMENSIONS**
2/case, 9.5" H x 37" L x 8.5" W 37 lbs

COMES IN 2 COLORS

-  DEEP BRONZE
#93471
-  GRAPHITE
#93472

*Pole must be screwed in for vaulted ceilings

"I think it's nice to age gracefully. OK, you lose the youth, a certain stamina and dewy glow, but what you gain on the inside as a human being is wonderful: the wisdom, the acceptance and the peace of mind. It's a fair exchange." -Cherie Lunghi

