



USER MANUAL

51.2V 208AH 10.6KWH LIFEPO4 LITHIUM IRON
PHOSPHATE WALL MOUNT SOLAR UPS BATTERY



PLEASE READ THIS MANUAL CAREFULLY BEFORE
OPERATING AND RETAIN IT FOR FUTURE REFERENCE.

www.LBSA.co.za



This manual introduces LBSA Smart Battery by Lithium Batteries SA. Please read this manual before installation of the battery module and follow the instructions carefully during the assembly. Any confusion, please contact Lithium Batteries SA for advice and clarification.

CONTENT

1. Safety Precautions.....	3
1.1 Precautions.....	3
1.2 Warning.....	4
2. Introduction.....	4-5
2.1 Features.....	5
2.2 Specifications.....	6
2.3 Interfaces.....	7-11
2.4 Cell Features.....	11
2.4.1 Specifications.....	11-12
2.5 Battery Management System.....	12
2.5.1 BMS Functions.....	12
2.5.2 Compatible Inverters.....	13
3. Installation.....	14

1. Safety Precautions

It is very important and necessary to read the user manual carefully before installing or using the product. Failure to do so or to follow any of the instructions or warnings in this document can result in electrical shock, serious injury or death, and could damage the battery, or potentially render it inoperable.

1.1 Precautions

- If the battery pack is stored for a long time, it is required to charge the battery every six months, and the SOC should be no less than 90%.
- Please recharge the battery pack within 12 hours, after fully discharged.
- All the battery pack terminals must be disconnected before any maintenance.
- Do not use cleaning solvents to clean the battery pack.
- Do not expose the battery pack to flammable or harsh chemicals, or corrosive gasses and liquids.
- Do not paint any part of the battery pack, including any internal or external components.
- Do not expose the battery pack to direct sunlight for extended periods of time.
- Do not connect the battery pack with PV solar wiring directly.
- Do not insert any foreign object into any part of the battery pack.

1.2 Warning

- Do not touch the battery pack with wet hands.
- Do not crush, drop or puncture the battery pack.
- Always dispose of the battery pack according to local safety regulations.
- Store and recharge the battery pack in a manner in accordance with this user manual.
- Ensure reliable grounding.
- Do not reverse the polarity when installing.
- Do not short circuit the terminals, remove all jewellery items that could cause a short circuit before installation and handling.
- Disconnect battery from power or loads, and then power off battery before installation and maintenance.
- The battery packs should not be stacked more than specified numbers.
- Continued operation of a damaged battery pack can result in a fire.

2. Introduction



LBSA lithium iron phosphate (LiFePO₄) battery pack is a household renewable energy storage solution developed and produced by Lithium Batteries SA. After full installation, it is a low-voltage DC battery system with an operating voltage of 51.2V, and works with a low-voltage inverter to realize the goal of energy storage for home application.

The battery pack supports parallel connection to expand capacity, which can meet various capacity requirements. It has a built-in battery management system (BMS), which can manage and monitor the pack and cell information including voltage, current and temperature. What's more, the BMS can balance cells when charging and discharging to extend cycle life.

2.1 Features

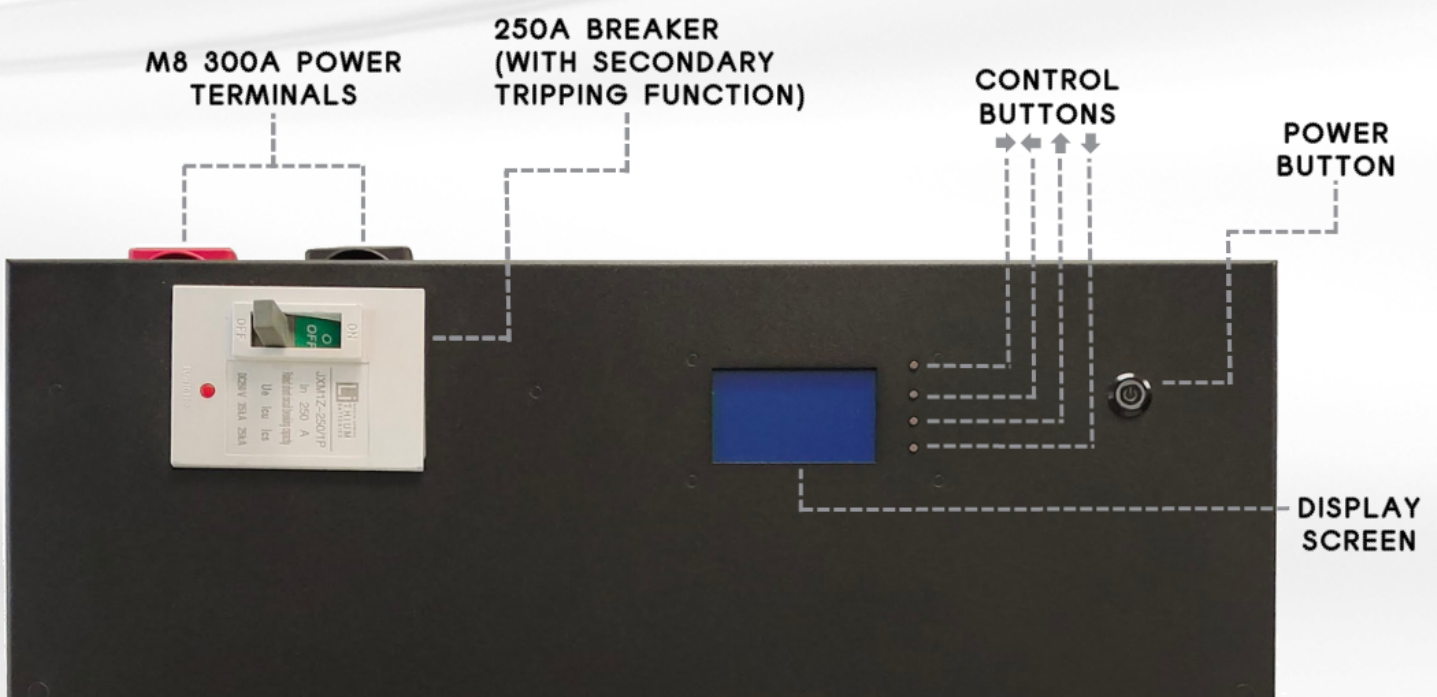

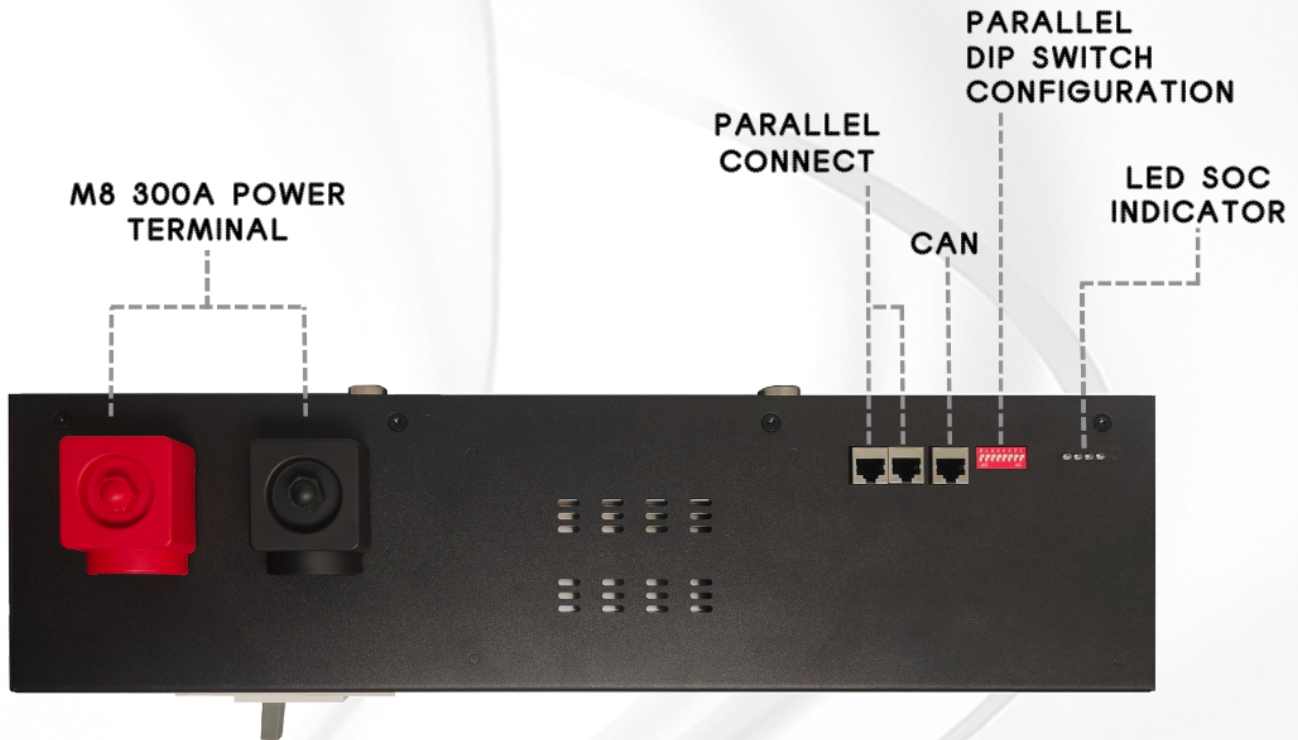

- Battery cell is a 3.2V 104Ah aluminium case prismatic cell.
- Battery cell is made from lithium iron phosphate (LiFePO4) with safety performance and longer cycle life.
- BMS has over-discharge, over-charge, over-current, high and low temperature warning and protection functions.
- BMS monitors charge and discharge state, and balances current and voltage of each cell.
- 250A DC Circuit Breaker (with secondary tripping function).
- Flexible configuration, max. 16 packs can be connected in parallel for expanding capacity and power with 8 DIP switches.
- Working temperature range is from -20°C~50°C (Charging 0°C~50°C; discharging -20°C~50°C) with excellent discharge performance and cycle life.



2.2 Specifications

Basic Parameters	
Nominal Voltage (V)	51.2V
Nominal Capacity (Ah)	208Ah
Nominal Power (kWh)	10.6 kWh
Dimensions (mm)	750mm*135mm*520mm
Weight (Kg)	84KG
Discharge Cut-off Voltage (V)	44V
Charge Voltage (Bulk+ Absorption) (V)	56.2V
Max Discharge Current (A)	200A
Recommended Charge Current	100A
Communication Interface	CAN
Configuration	16S 2P
Working Temperature	0~50°C (Charge)
	-20~50°C (Discharge)
	-20~55°C (Storage)
Cell chemistry	Lithium iron phosphate (LiFePO4)
Cycle life	≥80% capacity state after 4800 cycles at 0.5C, 25°C, 100% DOD
IP level	IP 20

2.3 Interfaces

Reset

Reset button: To start the battery pack, press the button down to reset the battery pack.

CAN

CAN communication interface: follow CAN BUS protocol, for output pack information to inverter.

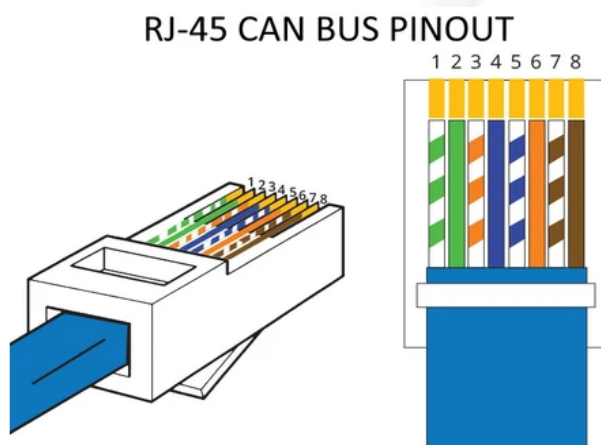

Pin 3:	Ground
Pin 4:	CAN-H
Pin 5:	CAN-L

RS485 communication interface: RJ45 port, follow RS485 protocol. For transmitting battery pack information between paralleled packs, use a standard RJ45 cable. This pack is compatible with any LBSA SMART batteries.

Pin	Definition
PIN 1, 8	RS485-B
PIN 2, 7	RS485-A
PIN 3, 6	Ground
PIN 4,5	NC (Bridge weld)

Parallel communication dip switch settings







ADS Switch: To set up battery address, and to communicate between battery and Inverter. Down = 'OF' Up = 'ON'.

CAN Communication									
Master Packs (#1, #2, #3, #4 set OFF) #5, #6, #7, #8 set as follows					Slave Packs (#5, #6, #7, #8 set OFF) #1, #2, #3, #4 set as follows				
	8	7	6	5		4	3	2	1
One pack	OFF	OFF	OFF	OFF					
2 packs in parallel	OFF	OFF	OFF	ON	1 st slave pack	OFF	OFF	OFF	ON
3 packs in parallel	OFF	OFF	ON	OFF	2 nd slave pack	OFF	OFF	ON	OFF
4 packs in parallel	OFF	OFF	ON	ON	3 rd slave pack	OFF	OFF	ON	ON
5 packs in parallel	OFF	ON	OFF	OFF	4 th slave pack	OFF	ON	OFF	OFF
6 packs in parallel	OFF	ON	OFF	ON	5 th slave pack	OFF	ON	OFF	ON
7 packs in parallel	OFF	ON	ON	OFF	6 th slave pack	OFF	ON	ON	OFF
8 packs in parallel	OFF	ON	ON	ON	7 th slave pack	OFF	ON	ON	ON
9 packs in parallel	ON	OFF	OFF	OFF	8 th slave pack	ON	OFF	OFF	OFF
10 packs in parallel	ON	OFF	OFF	ON	9 th slave pack	ON	OFF	OFF	ON
11 packs in parallel	ON	OFF	ON	OFF	10 th slave pack	ON	OFF	ON	OFF
12 packs in parallel	ON	OFF	ON	ON	11 th slave pack	ON	OFF	ON	ON
13 packs in parallel	ON	ON	OFF	OFF	12 th slave pack	ON	ON	OFF	OFF
14 packs in parallel	ON	ON	OFF	ON	13 th slave pack	ON	ON	OFF	ON
15 packs in parallel	ON	ON	ON	OFF	14 th slave pack	ON	ON	ON	OFF
16 packs in parallel	ON	ON	ON	ON	15 th slave pack	ON	ON	ON	ON

Running mode

Working light: green LED to show the battery working status.









Details as follows:

Battery status	Operating Mode	RUN	ALM	LED Light				Remark
								
Power off	Standby	OFF	OFF	OFF	OFF	OFF	OFF	OFF
Standby	Normal	Solid Green	OFF	OFF				Standby mode
Charge Mode	Normal	Solid Green	OFF	According to battery SOC status				
	Over current warnings	Solid Green	Blink type 2					
	Over voltage protection	Blink type1	OFF	OFF	OFF	OFF	OFF	
	Temperature, over current protection	Blink type1	OFF	OFF	OFF	OFF	OFF	
Discharge Mode	Normal	Blink type 3	OFF	According to battery SOC status				
	Warning	Blink type 3	Blink type 3					
	Over current, temperature, short-circuit protection	OFF	Solid Red	OFF	OFF	OFF	OFF	Termination of discharge
	Under voltage protection	OFF	OFF	OFF	OFF	OFF	OFF	Termination of discharge

Capacity

SOC light: 4 green LED lights to show the capacity status of battery pack.
Each LED represents 25%

the capacity.

Status	Charge				Discharge			
Capacity indicator								
0-25%	OFF	OFF	OFF	Blink	OFF	OFF	OFF	Solid Green
25%-50%	OFF	OFF	Blink	Solid Green	OFF	OFF	Solid Green	Solid Green
50%-75%	OFF	Blink	Solid Green	Solid Green	OFF	Solid Green	Solid Green	Solid Green
>75%	Blink	Solid Green	Solid Green	Solid Green	Solid Green	Solid Green	Solid Green	Solid Green
Operating indicator	Solid Green				Blink			

Alarm

ALARM light: red LED flash to show the battery alarm status.

And red light permanently to show the battery in protection status of abnormal temperature, over-current, or short-circuit.

P+/P-

Power terminals: one pair of 300A power terminals to go directly to a single inverter if one pack is used. If more than one pack is used the batteries must be connected to a busbar with equal length cable to ensure there is equal discharge and charge between the batteries

Power cable uses 10.0mm lug to connect to the battery terminals.

2.4 Cell Features

2.4.1 Specifications

3.2V 104Ah lithium iron phosphate (LiFePO4) aluminium case prismatic rechargeable battery cell.

Nominal Voltage	3.2V
Nominal Capacity	104Ah
Weight	≤1.9Kg
Self-discharge Rate	≤3.5% per month
Initial Internal Resistance (1KHz)	≤0.35mΩ

Refer to the cell specification for more detailed information.

High-quality Grade A cells are inside the battery box

- The real capacity of each single cell is 104Ah.

2.5 Advanced Battery Management System (BMS) inside

The BMS is applied to monitor current, voltage, temperature, and protection against over-charge, over-discharge, over-current, over-temperature, under-temperature, and short circuit. The BMS provides cell balancing and current limitations during the charging process to ensure reliable safety and performance. The BMS will automatically adjust the available capacity after every full charge of 56.2v when discharged. This capacity will be influenced by the temperature as the cells generally have less capacity available under very cold temperatures.

2.5.1 BMS Functions

- Over charge protection
- Over discharge protection
- Overcurrent protection
- Cell balancing
- Temperature protection
- CAN communication to inverters and RS485 communication between battery packs

2.5.2 Compatible Inverters (with regards to CANbus Communication), all other inverters should have the charge and discharge cut-off set with accordance to section 2.2 in the Manual

- Victron(Pin 4 and 5 on the LBSA BMS CAN and pin 7 and 8 on the VE.CAN)
 - Set the port speed of the VE.CAN port to 500kbit/s.
- Growatt(Straight RJ45 cable to be used from the battery CAN port and the inverter CAN port)
 - Set inverter to LI - PTCL52
- Goodwe(Straight RJ45 cable to be used from the battery CAN port and the inverter CAN port)
- Sunsynk(Straight RJ45 cable to be used from the battery CAN port and the inverter CAN port)
 - Set inverter to Lithium 00
- Deye(Straight RJ45 cable to be used from the battery CAN port and the inverter CAN port)
 - Set inverter to Lithium 00
- LuxPower(For Luxpower models before September 2022 refer to the Luxpower to LBSA document to be obtained from your supplier. For newer models use a straight pin-to-pin connection. NB: BATTERY CAN PROTOCOL NEEDS TO BE SET TO LUXPOWER USING THE BATTERY MONITOR CABLE SUPPLIED BY LBSA)
 - Set inverter to Lithium - Battery brand 06 (LBSA BMS to be set to Luxpower)

3. Installation

When connecting the batteries in parallel the batteries should be connected to a central busbar and from the busbar be distributed to the inverters with equal cable lengths. This unit is compatible with all LBSA SMART batteries. Terminals must not be torqued more than 6nm.

M8 rawl bolts to be used to mount the wall bracket to a wall (please ensure that the surface/structure/wall is capable of carrying the unit weight).

Mounting the battery:

Ensure a secure mounting surface that can support the weight of the battery.

Use a 14mm/12mm drill bit (depending on a Rawl bolt of your choice) to drill two holes in the wall approximately 270mm apart. (Use the bracket as a guide)

Mount the bracket to the wall by using M6/M8 Rawl bolts. The mounting points of the bracket need to be flush against the wall.

Once the bracket is secure you can screw your two mounting studs into the top middle Rivet nuts at the back of your battery.

You must then slide your battery into the two central slots of your bracket.

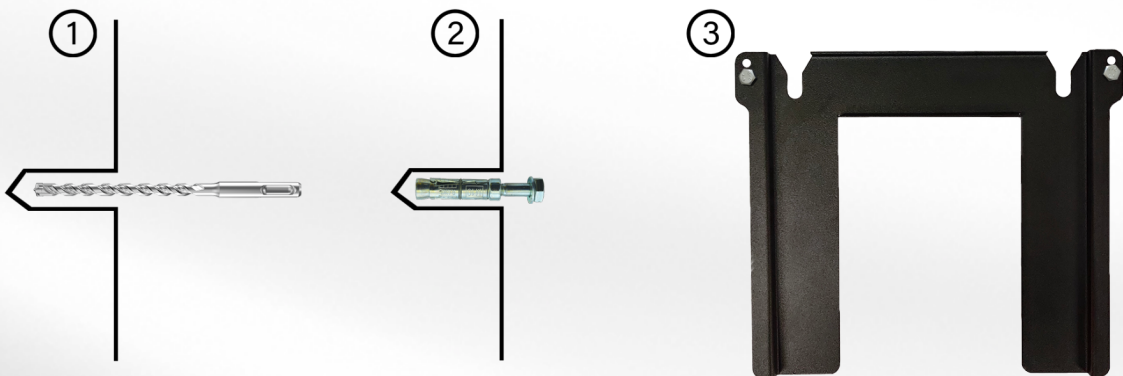



This document is subject to change without notice.

©2023 Lithium Batteries SA
54 Mimetes Rd, Denver,
Johannesburg, 2011
South Africa

Unit 9 & 10,
1 Michigan Street,
Bonquinar Industrial Area,
Cape Town, 7490
South Africa

TEL: (+27) 10 110 1991
mail: info@lbsa.co.za
<http://www.lbsa.co.za>