

# IMA 400 Watts Power Supply Series

for medical and industrial applications

Product data sheet

## 400 Watts Power Supply Series

for medical and industrial applications

### Features

- Safety approval for Medical (IEC 60601-1-2), Industrial (IEC 62368) and IT
- Wide operating input voltage range: 80 Vac to 275 Vac or 120 Vdc to 300 Vdc
- Wide adjustable output voltage range (+/- 20%)
- 5 Vdc standby output
- High efficiency: up to 94%
- Size: 4 x 6.96 x 1.6 in (1U design)
- Low acoustic noise level of less than 30 dB(A)
- Active current sharing
- 2 × MOPP
- PMBus™ compatible for control, programming and monitoring
- 500,000 hour MTBF
- Optional conformal coating
- 3 years warranty

### Model variants

Model number <sup>1)</sup>	Input voltage range		Main DC Output		Auxiliary DC Output		Remote ON/OFF standard setting <sup>2)</sup>
	AC (Vac)	DC (Vdc)	Voltage (Vdc)	Current (A)	Voltage (Vdc)	Current (A)	
IMA-x400-12-ZNPLI	80 to 275	120 to 300	12	33.3	5	0.5	OFF
IMA-x400-12-ZNPLY							ON
IMA-x400-24-ZNPLI			24	16.7			OFF
IMA-x400-24-ZNPLY							ON
IMA-x400-48-ZNPLI			48	8.33			OFF
IMA-x400-48-ZNPLY							ON

<sup>1)</sup> IMA-x400: x = S for standard version (e.g. IMA-S400-24-ZNPLY),  
x = C for conformal coated version (e.g. IMA-C400-24-ZNPLY)

<sup>2)</sup> Model ZNPLI and ZNPLY have different settings for Remote ON/OFF, see "Other features", p. 4

### AC/DC input (J1)

	IMA-x400-12	IMA-x400-24	IMA-x400-48
Nominal input voltage	100 Vac to 240 Vac		
AC operating input voltage range	80 Vac to 275 Vac		
Nominal input frequency	50 / 60 Hz		
Input frequency range	47 Hz to 63 Hz		
DC Input voltage range	120 Vdc to 300 Vdc		
Maximum input current	6 A at 80 Vac / 3.8 A at 120 Vdc		
Efficiency @ 100% load	see Fig. 16 to Fig. 18, page 11		
@ 230 Vac	92%	94%	94%
@ 115 Vac	90%	92%	92%
Max inrush current <sup>1)</sup>	< 20 A		
Input fuse	DC input compliant, dual 10 A fuses used		
Power factor <sup>2)</sup>	0.9 (typical)		

<sup>1)</sup> Hot and cold turn on

<sup>2)</sup> EN 61000-3-2, Class A compliant

**Main DC output (J2)**

		IMA-x400-12	IMA-x400-24	IMA-x400-48
<b>Nominal output voltage</b>		12 V	24 V	48 V
<b>Output voltage adjustment range</b>		9.6 V to 14.4 V	19.2 V to 28.8 V	38.4 V to 56.0 V
<b>Maximum output power</b>		400 W		
<b>Output voltage regulation</b>				
Total		2.25%		
Over line	Full input range, full load	0.25%		
Over load	Nominal input, full load range	1%		
Over temperature	Nominal input, full load, full temperature	1%		
<b>Maximum output current</b>		33.3 A	16.7 A	8.3 A
<b>Maximum output capacitive load</b>		10,000 $\mu$ F		
<b>Dynamic load regulation <sup>1)</sup></b>		< 5%		
<b>PARD (20 MHz) <sup>2)</sup></b>		< 1% peak to peak		
<b>Turn on overshoot</b>		< 2%		
<b>Output rising time</b>		< 150 ms		
<b>Hold up time</b>		20 msec nominal		
<b>Start up time</b>				
AC OFF --> ON	Nominal input, max. load	< 2.5 s		
REMOTE OFF --> ON	Nominal input, max. load	< 150 ms		
<b>Output over voltage protection</b>		YES, latch mode		
		15 V to 17.5 V	30 V to 35 V	58.5 V to 63 V
<b>Output over current protection</b>		YES, at 108% to 140% of nominal output current; auto recovery		
<b>Short circuit protection</b>		YES, auto recovery		
<b>Over temperature protection</b>		YES, auto recovery		
<b>Remote sense <sup>3)</sup></b>	Total voltage drop compensation for +V_SENSE and -V_SENSE connections (J3 Pins 13 and 14) to the output load	200 mV		

<sup>1)</sup> 50% step from 5% load, 1 A/ $\mu$ s, 10  $\mu$ F Tan and 1  $\mu$ F ceramic capacitor

<sup>2)</sup> 10  $\mu$ F Tan and 1  $\mu$ F ceramic capacitor

<sup>3)</sup> Do not short or reversely connect +V\_SENSE and -V\_SENSE. Doing this can cause damage to the power supply

**Auxiliary DC output (J3) <sup>1)</sup>**

		IMA-x400-xx
<b>Connector type</b>		Molex, Part number 87833-1420, 14 pin, see Fig. 19, page 12
<b>Nominal output voltage</b>		5 V
<b>Output voltage adjustment range</b>		–
<b>Output voltage regulation</b>		
Total		2.25%
Over line	Full input range, full load	0.25 %
Over load	Nominal input, full load range	1%
Over temperature	Nominal input, full load, full temperature	1%
<b>Maximum output current</b>		0.5 A
<b>Maximum output capacitive load</b>		1,000 $\mu$ F
<b>Output over voltage protection</b>		Yes, at 5.5 V to 6 V, latch mode
<b>Output over current protection</b>		Yes, at 1.0 A to 1.3 A, auto recovery
<b>Short circuit protection</b>		YES, auto recovery
<b>Over temperature protection</b>		YES, auto recovery

<sup>1)</sup> There is no galvanic isolation between 5VSB GND and Main DC Output GND.

**Galvanic isolation**

		IMA-x400-xx
Input to Output	Reinforced	4000 Vac; 2 x MOPP
Input to Case	Basic	1500 Vac; 1 x MOPP
Output to Case	Basic	1500 Vac; 1 x MOPP

**Leakage currents**

		IMA-x400-xx			
<b>AC Leakage current from Input to earth ground</b>	Measured at mains voltage	at 60 Hz	at 63 Hz		
	Normal condition (low line)	132 Vac	< 150 µA	< 150 µA	
	Single fault condition (low line)	132 Vac	< 250 µA	< 260 µA	
	Normal condition (high line)	264 Vac	< 300 µA	< 300 µA	
	Single fault condition (high line)	264 Vac	< 500 µA	< 520 µA	
<b>AC Leakage current from Output to earth ground</b>	Measured at mains voltage	Typical at 60 Hz <sup>1)</sup>	Maximum value at 63 Hz <sup>1)</sup>		Limit per IEC 60601-1
	Normal condition	264 Vac	45 µA	< 60 µA	100 µA
	Single fault condition (neutral open)	264 Vac	45 µA	< 80 µA	500 µA
	Single fault condition (ground open)	264 Vac	114 µA	< 150 µA	500 µA
	AC Backdrive fault	264 Vac	< 450 µA	< 550 µA	5000 µA

<sup>1)</sup> Meets IEC 60601-1 BF leakage current limit

**Other features**

		IMA-x400-xx
<b>Current Share Bus Pin</b>	J3 Pin 11 (CURRENT_SHARE_V)	Voltage at CS Pin will vary linearly with load current on main output, and will be 6 V at rated load current, when the output voltage is at its rated value.
<b>Power Good Pin</b>	J3 Pin 9 (PWR_GOOD)	Open collector. As soon as AC input voltage and DC output voltage are in the predefined range, the PWR_GOOD signal is set to HIGH.
<b>Green LED</b>		Will turn ON as soon as PWR_GOOD signal is set to HIGH
<b>Derating Guideline</b>		Refer to IPC 9592B and Delta Internal Guideline
<b>OR-ing</b>		Redundant operation with active circuit sharing, see <i>Application Note "Redundant operation", p. 10</i>
<b>SDA, SCL for I2C</b>		Internal 10 kΩ pull-up resistor to internal 3.3 V

		IMA-x400-xx-ZNPLI		IMA-x400-xx-ZNPLY	
<b>Remote On/Off Pin <sup>1)</sup></b>	J3 Pin 10 (REMOTE_ON/OFF)	REMOTE ON/OFF (J3 Pin 10) and 5VSB_RTN (J3 Pin 3 or J3 Pin 4 or J3 Pin 7)	Main DC Output	REMOTE ON/OFF (J3 Pin 10) and 5VSB_RTN (J3 Pin 3 or J3 Pin 4 or J3 Pin 7)	Main DC Output
		Shorted	OFF	Shorted	ON
		Open	ON	Open	OFF

<sup>1)</sup> Logic can be switched with PMBus™

**Environmental conditions**

	IMA-x400-12	IMA-x400-24	IMA-x400-48
<b>Ambient operating temperature range</b> <sup>1)</sup>	-20 °C ... +70 °C (-4°F to +158 °F) (see Fig. 7 to Fig. 8, page 10)		
<b>Ambient storage temperature range</b>	-40 °C ... +85 °C (-40 °F to +185 °F)		
<b>Output power derating</b>			
Versus input voltage	When AC input voltage is < 90 Vac, the output power will be reduced by 4 W per 1 V. (see Fig. 9, page 10)		
Versus ambient temperature	(see Fig. 9, page 10)	(see Fig. 8, page 10)	
<b>Output current derating</b> Versus output voltage	When output voltage is > 12 Vdc, the output current is reduced by 2.292 A per 1 V (see Fig. 10, page 10).	When output voltage is > 24 Vdc, the output current is reduced by 0.583 A per 1 V (see Fig. 11, page 10).	When output voltage is > 48 Vdc, the output current is reduced by 0.148 A per 1 V (see Fig. 13, page 11).
<b>Relative humidity</b>	< 95% (non-condensing)		
<b>Operating altitude</b> <sup>1) 2)</sup>	-200 m to 5,000 m (-650 ft to 16,400 ft)		
<b>Shock test (non-operating)</b>	IEC 60068-2-27 compliant, 50 g, 11 msec, 3 shocks for each direction		
<b>Vibration (non-operating)</b>	IEC 60068-2-6 compliant, 2.09 Grms, 5 Hz to 500 Hz, 20 minutes per side (3 planes)		
<b>Pollution degree</b>	2		

<sup>1)</sup> Ambient operating temperature decreases by 1 °C per 305 m (1000 ft) altitude increase

<sup>2)</sup> Maximum operating altitude requirements for different types of products, see "Safety standards and directives 1)", p. 6

**Reliability**

	IMA-x400-xx
<b>CMTBF</b> <sup>1)</sup>	500,000 hours
<b>Expected capacitor life time</b> <sup>2)</sup>	10 years
<b>Warranty</b>	3 years

<sup>1)</sup> Telecordia SR-332, Issue 3, 25 °C, 90% confidence level

<sup>2)</sup> Nominal input voltage, 45 °C, 80% load

**EMC**

This device has been fully tested according to EN 60601-1-2:2015 (4th edition).

IMA-x400-xx		
	Applied standards	Criteria
<b>Radiated emissions</b> <sup>1)</sup>	EN 55011, EN 55022 and FCC, Class B	
<b>Conducted emissions</b> <sup>1)</sup>	EN 55011, EN 55022 and FCC, Class B	
<b>Power line harmonics</b>	EN 61000-3-2, Class A	
<b>Voltage flicker</b>	EN 61000-3-3	
<b>ESD</b>	EN 61000-4-2, level 4, 8 kV contact, 15 kV air	A
<b>Radiated immunity</b>	EN 61000-4-3, level 3, 10 V/m	A
<b>Electrical fast transient</b>	EN 61000-4-4, level 4, ±4 kV	A
<b>Surge immunity</b>	EN 61000-4-5, level 4, 2 kV DM, 4 kV CM	A
<b>Conducted RF immunity</b>	EN 61000-4-6, level 2, 3 Vrms, 6 Vrms in ISM band	A
<b>Power frequency magnetic field</b>	EN 61000-4-8, 30 A/m	A
<b>Voltage dips and sags</b>	EN 61000-4-11, 30%, 500 ms	A
	EN 61000-4-11, 60%, 100 ms	B
	EN 61000-4-11, 100%, 20 ms	A
	EN 60601-1-2:2015 (4 <sup>th</sup> edition), 30%, 500 ms	A
	EN 60601-1-2 :2015 (4 <sup>th</sup> edition), 60%, 100 ms	B
	EN 60601-1-2 :2015 (4 <sup>th</sup> edition), 100%, 20 ms	A
	EN 60601-1-2 :2015 (4 <sup>th</sup> edition), 100%, 5000 ms	B
<b>Ring wave</b>	EN 61000-4-12, level 3, 1 kV DM, 2 kV CM	A
<b>Voltage fluctuations</b>	EN 61000-4-14, Class 3	A

<sup>1)</sup> Power Supply Unit inside a dummy system

**Safety standards and directives** <sup>1)</sup>

IMA-x400-xx	
<b>IEC 62368 Edition 2</b>	IEC 62368-1 (2014) Edition 2 5000 m (16,400 ft) altitude, 120 V to 300 Vdc and 100 V to 240 ±10% Vac
<b>IEC/EN 60950-1, Edition 2 and all national deviations</b>	UL 60950-1/CSA 22.2 No 60950-1, Edition 2; 5,000 m (16,400 ft) altitude, 120 V to 300 Vdc and 100 V to 240 ±10% Vac (UL File E191395)
<b>IEC/EN 60601-1, Edition 3 (tested against Edition 2, too) and all national deviations</b>	IEC 60601-1:2005, EN 60601-1(2006) ANSI/AAMI ES 60601-1(2005) CAN/CSA C22.2 No. 60601-1 (2008); 3,000 m (9,800 ft) altitude, 100 V to 240 Vac ±10% (UL File E325662)
<b>IEC 60601-1-2 Edition 4</b>	IEC 60601-1-2 (2014)
<b>Protection class</b>	I

<sup>1)</sup> Designed to support Type B Applied Part End Product Requirements

**Ecological characteristics**

IMA-x400-xx	
<b>WEEE (Waste Electrical and Electronic Equipment Directive)</b>	2012/19/EU
<b>RoHS (Restriction of Hazardous Substances Directive)</b>	2011/65/EU

**Mechanical data**

	<b>IMA-x400-xx</b>
<b>Dimensions (L x W x D)</b>	176.8 x 101.6 x 40.6 mm (6.96 x 4 x 1.6 in)
<b>Weight</b>	0.960 kg (2.12 lb)
<b>Indicator</b>	Green LED
<b>Cooling system</b>	System airflow cooling or natural convection cooling
<b>AC/DC input port</b>	Block M3.5 x 3 pins
<b>Main DC output port</b>	Block M5 x 2 pins
<b>Auxiliary DC output + signals port</b>	Connector x 14 pins
<b>Noise <sup>1)</sup></b>	< 30 dB(A)

<sup>1)</sup> At 1 Hz to 20 kHz and a distance of 1 m. Test conditions: 100 Vac, 100% load, ambient temperature 30 °C (86 °F)

**Options**

<b>Model</b>	<b>Main Output voltage</b>	<b>Standby Output</b>	<b>Leakage current</b>	<b>Main Output adjustable</b>	<b>Open frame</b>	<b>U channel</b>	<b>Enclosed</b>	<b>Convection cooling</b>	<b>Fan</b>	<b>Fan, airflow from end to front</b>	<b>Fan, airflow from front to end</b>	<b>Top FAN solution</b>	<b>Active current sharing</b>	<b>Remote ON/OFF</b>	<b>Coated <sup>1)</sup></b>
IMA-S400-12V	12 V	5 V/0.5 A	300 µA	●	○	●	○	●	○	○	○	○	●	●	-
IMA-S400-24V	24 V	5 V/0.5 A	300 µA	●	○	●	○	●	○	○	○	○	●	●	-
IMA-S400-48V	48 V	5 V/0.5 A	300 µA	●	○	●	○	●	○	○	○	○	●	●	-
IMA-C400-12V	12 V	5 V/0.5 A	300 µA	●	○	●	○	●	○	○	○	○	●	●	●
IMA-C400-24V	24 V	5 V/0.5 A	300 µA	●	○	●	○	●	○	○	○	○	●	●	●
IMA-C400-48V	48 V	5 V/0.5 A	300 µA	●	○	●	○	●	○	○	○	○	●	●	●

- included
- on request
- not available

Mounting orientations

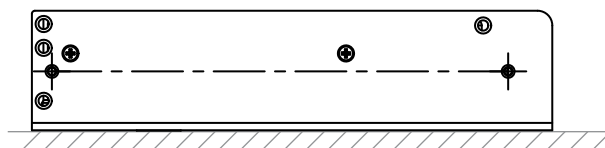

Fig. 1: Standard mounting orientation

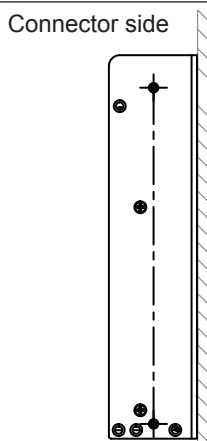

Fig. 2: Vertical mounting

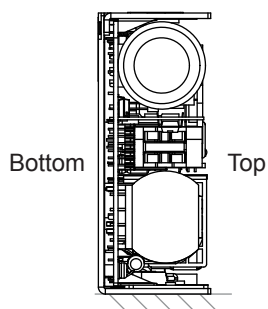

Fig. 3: Mounting on the left side

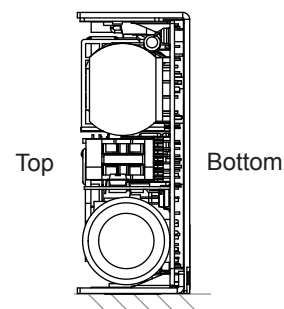
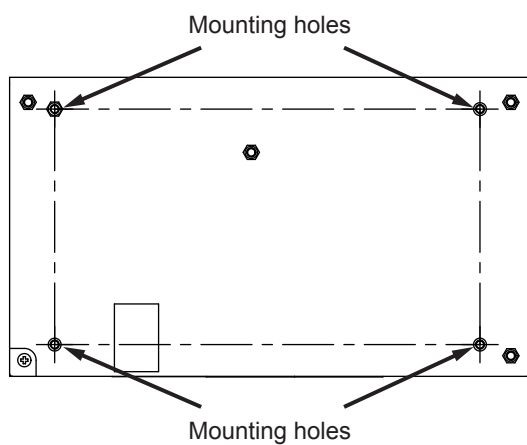

Fig. 4: Mounting on the right side

Bottom view



Side view

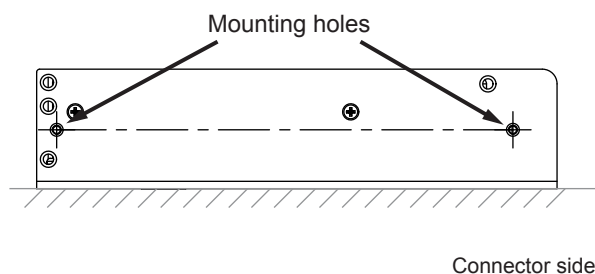

Fig. 5: Position of the mounting holes



Dimensional drawings

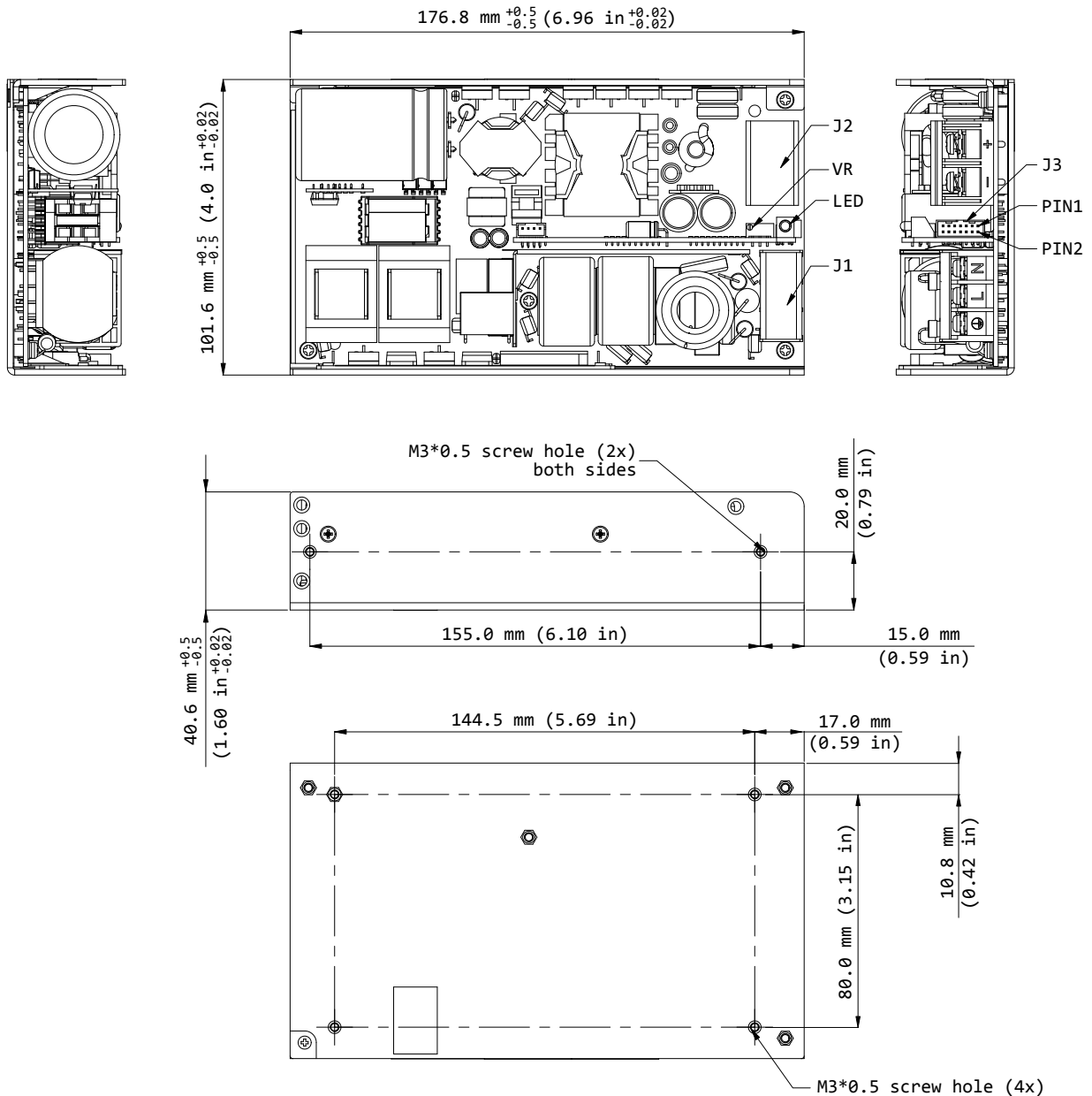

Fig. 6: Dimensional drawing IMA-x400-xx

Notes:

- Base plate mounting, M3 thread holes, maximum penetration 4.0 mm (0.16 in) (from outside face of chassis), maximum torque 0.6 Nm (5.31 lb-in)
- (J1) Input terminal block, Switchlab T14-EMII03, M3.5 screw in 3 positions, maximum torque 1.3 Nm (11.5 lb-in)
- (J2) Output terminal block, Dinkle DT-7C-B01W-3943-02, M4 screw in 2 positions, maximum torque 1.5 Nm (13.28 lb-in)
- (J3) Signal connector and Auxiliary DC Output, Mating connector for J3 is either Molex, part number 51110-1450 (without locking ramp), or Molex part number 51110-1451 (with locking ramp). The connector is not shipped with the power supply unit.
- General tolerance:  $\pm 0.3$  mm (0.012 in)

Curves

**IMA-x400-12**

Tested at 90 Vac input

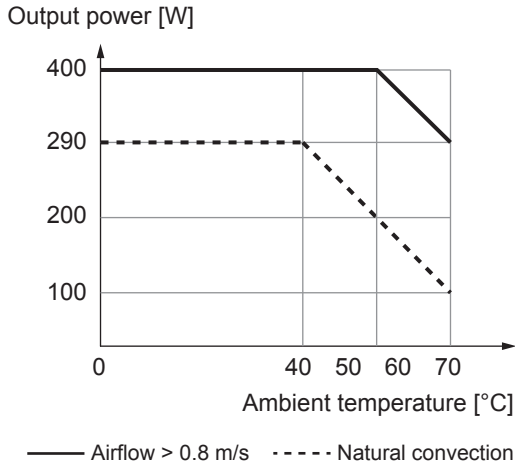

Fig. 7: Output power versus ambient temperature 12 V

**IMA-x400-24/48**

Tested at 90 Vac input

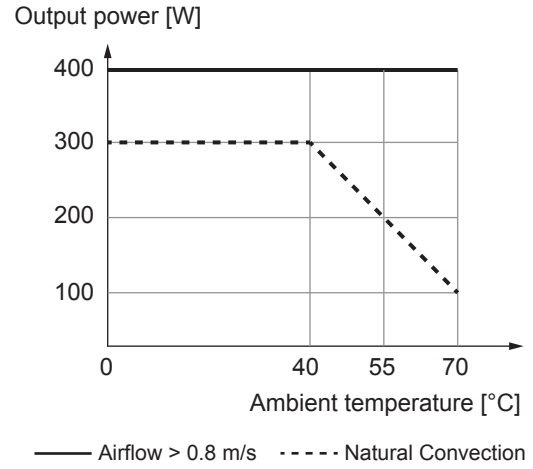

Fig. 8: Output power versus ambient temperature 24/48 V

**IMA-x400-xx**

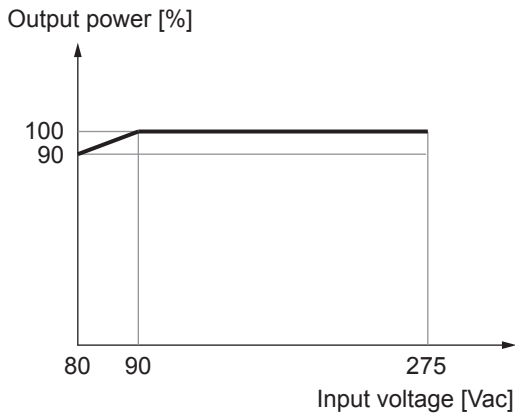

Fig. 9: Output power versus input voltage

**IMA-x400-12**

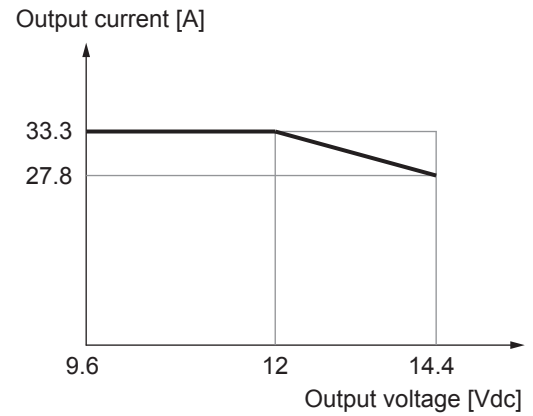

Fig. 10: Output current versus output voltage 12 V

**IMA-x400-24**

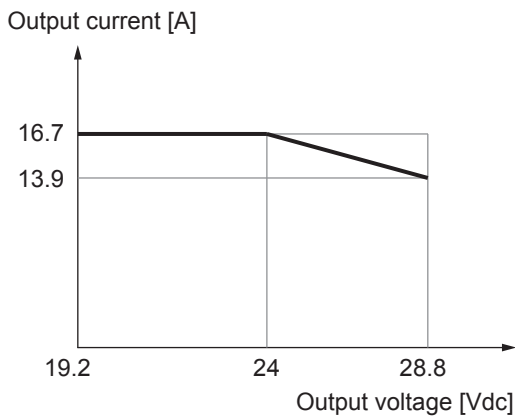

Fig. 11: Output current versus output voltage 24 V

**IMA-x400-48**

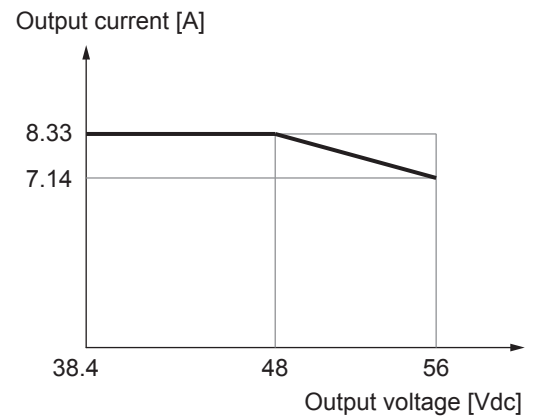

Fig. 12: Output current versus output voltage 48 V

Curves (continued)

**IMA-x400-12**

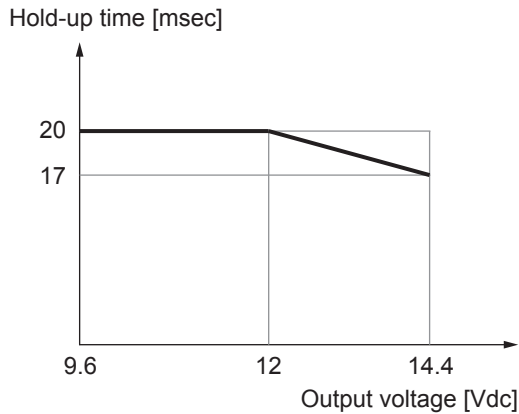

Fig. 13: Hold-up time versus output voltage 12 V

**IMA-x400-24**

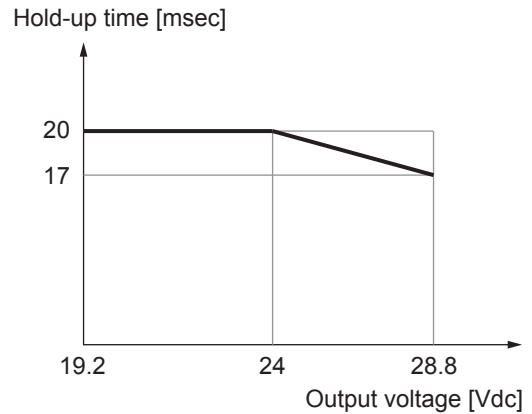

Fig. 14: Hold-up time versus output voltage 24 V

**IMA-x400-48**

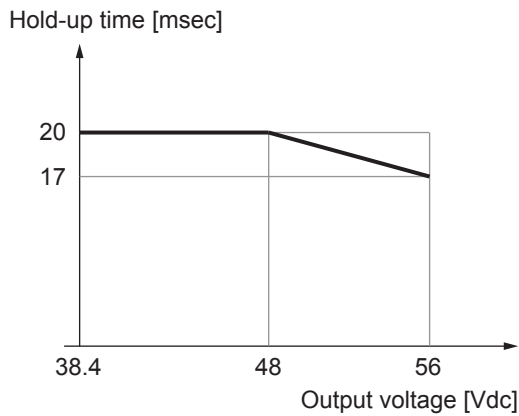

Fig. 15: Hold-up time versus output voltage 48 V

**IMA-x400-12**

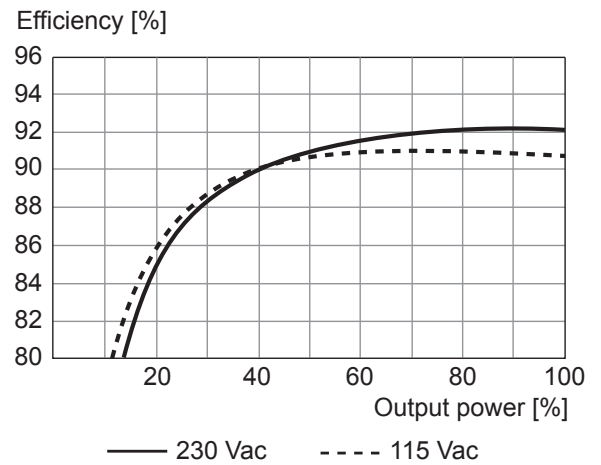

Fig. 16: Typical efficiency curves 12 V

**IMA-x400-24**

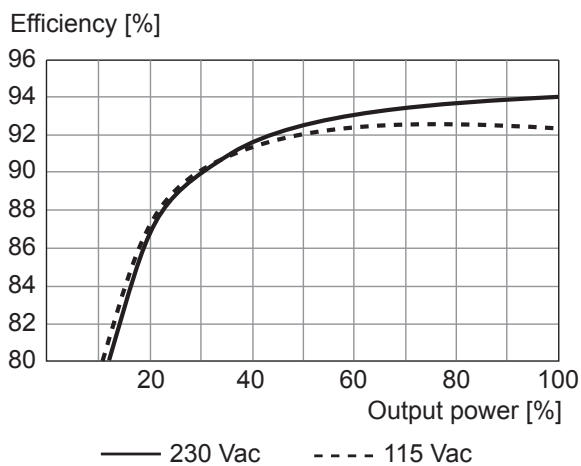

Fig. 17: Typical efficiency curves 24 V

**IMA-x400-48**

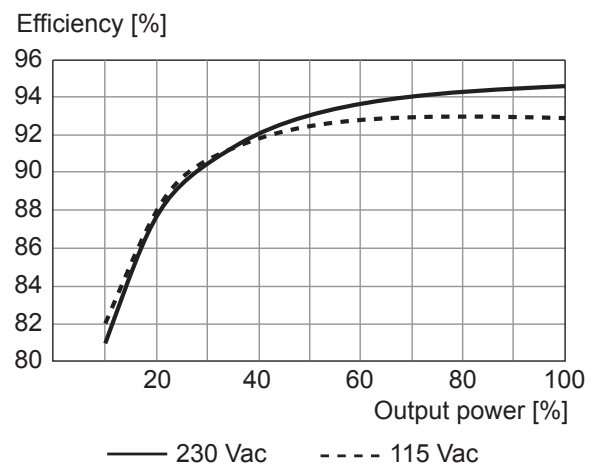

Fig. 18: Typical efficiency curves 48 V

Pin assignment (J3)

IMA-x400-xx			
Pin	Assignment	Pin	Assignment
14	-V_SENSE	13	+V_SENSE
12	Address	11	Current_Share_V
10	Remote ON/OFF	9	PWR_GOOD
8	+5VSB	7	5VSB_RTN
6	SDA	5	SCL
4	5VSB_RTN	3	5VSB_RTN
2	+5VSB	1	+5VSB

Mating connector type: Molex, Part number 51110-145x

Fig. 19: Pin assignment J3 terminal block

Circuit diagrams

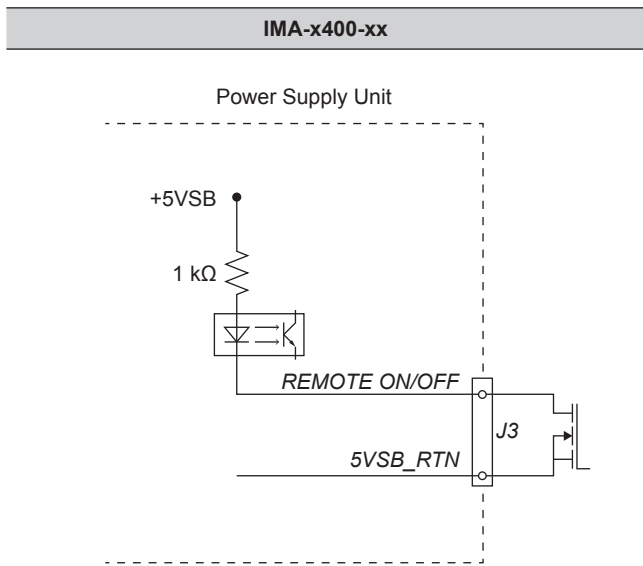

Fig. 20: Circuit diagram J3 Pin 10 (REMOTE ON/OFF)

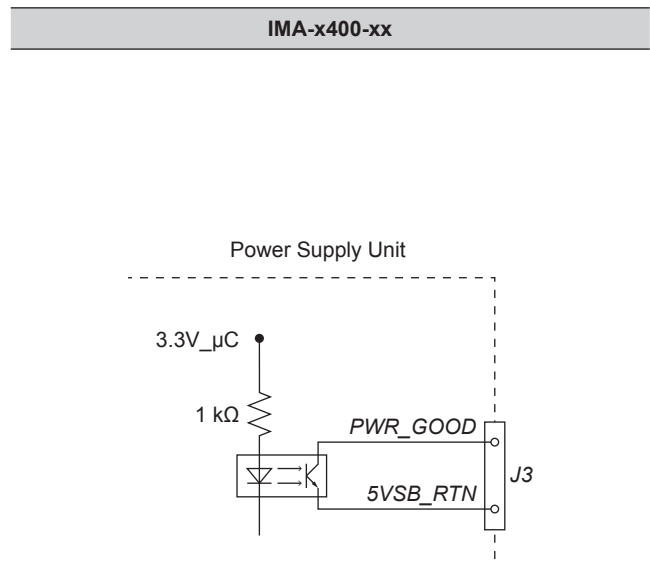

Fig. 21: Circuit diagram J3 Pin 9 (PWR\_GOOD)

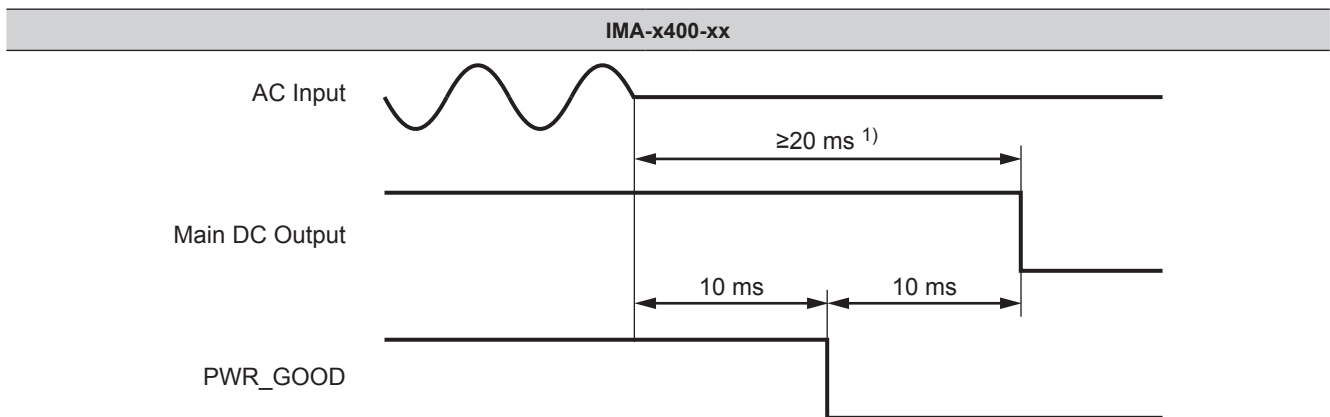

Fig. 22: Power Good function timing

<sup>1)</sup> For DC output voltage ≤ Nominal output voltage; will reduce at DC output voltages > Nominal output voltage.

This page is intentionally left blank.

## **Sales Contact**

### **Europe**

Delta Energy Systems (Germany) GmbH  
Tscheulinstrasse 21  
79331 Teningen  
Germany  
deu.sales@deltaww.com  
www.deltaenergysystems.com

### **USA**

Delta Electronics (Americas)  
46101 Fremont Blvd.  
Fremont, CA 94538  
USA  
na.sales@deltaww.com  
www.deltaenergysystems.com

### **Other regions**

Delta Energy Systems (Germany) GmbH  
Tscheulinstrasse 21  
79331 Teningen  
Germany  
im.sales@deltaww.com  
www.deltaenergysystems.com