

# OMNI-402

ANTENNAS | OMNI-402 SERIES

## OMNI-DIRECTIONAL, MARINE & COASTAL LTE MIMO ANTENNA

410 MHz – 3800 MHz, 6.2 dBi



410 – 470 MHz; 698 – 2700 MHz; 3400 – 3800 MHz	6.2 dBi	Omni-Directional	4G LTE	5G Ready	450 MHz	3.5 GHz CBRS Band
2.4 – 2.5 GHz	IoT & M2M	-40°C to +80°C	Fire Resistant	2x2 MIMO	IP 68	



APPLICATION AREAS

- High performance wideband omni-directional marine antenna
- 2X2 MIMO capability for improved performance
- Easy mounting with feed through 1-inch marine standard adapter bracket included
- Robust and all-weather proof for harsh conditions at sea (IP 68)
- Various 316 stainless steel mounting brackets available optionally
- UV and saltwater protected against tempestuous weather conditions

### Product Overview

The OMNI-402 is an ultra-wide band antenna, which covers all contemporary LTE operating frequencies with excellent balanced gain across all frequencies. The antenna also offers 2X2 MIMO capability from its vertically separated radiating elements, all in the same radome. The antenna design allows the antenna to have superior pattern control over the entire frequency range making the OMNI-402 a true high performance omni-directional MIMO antenna, suitable for marine and coastal applications. Usable in all parts of the world, the OMNI-402 guarantees signal reception almost everywhere. Poynting Antennas achieves this through new antenna configuration using multiple dipoles and a unique (patented) feed network. The antenna is future proof as it covers the 450 MHz LTE frequency band, which is becoming more popular in various regions and countries. This antenna is also 3400 – 3800 MHz capable for coastal and inland use.

### Features

- Medium gain omni-directional antenna
- Antenna is purpose-built for marine and coastal operation
- UV and salt-water resistant
- Robust and weather resistant design with IP 68 rating
- 2X2 MIMO capable for improved performance
- Includes 3.5 GHz CBRS band and is 5G ready

### Application Areas

- Marine applications / Yachts / Boats / Ferries
- Enhanced LTE reception
- IoT and M2M
- Poor data signal reception
- Improve data transmission connection reliability & stability
- Wi-Fi applications



### Frequency Bands

#### OMNI-402

The OMNI-402 is an omni-directional antenna that works from 410 – 470 MHz | 698 – 960 MHz | 1710 – 2700 MHz | 3400 – 3800 MHz

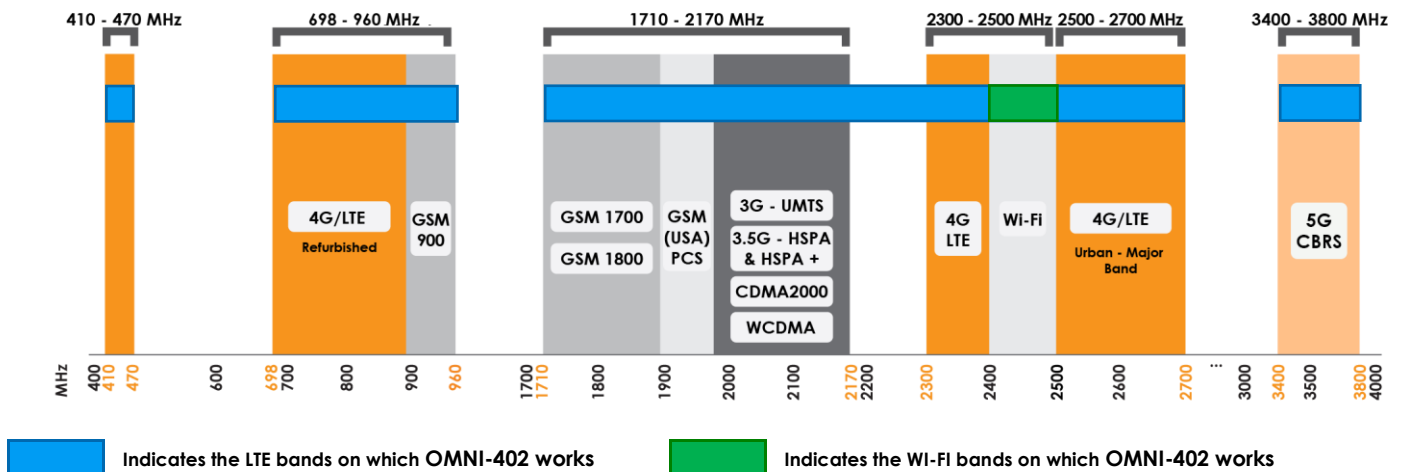

### Antenna Overview

Ports	2
SISO / MIMO	2x2 MIMO
Frequency Bands	410 – 3800 MHz
Polarisation	Linear Vertical
Peak Gain	6.2 dBi
Coax Cable Type	Twin HDF 195
Coax Cable Length	2m
Connector Type	SMA (M)

*\*The coax cable & connector are factory mounted to the antenna*

## Electrical Specifications

<b>Frequency bands:</b>	410 – 470 MHz 698 – 2700 MHz 3400 – 3800 MHz
<b>Gain (max):</b>	1 dBi @ 410-470 MHz 6.2 dBi @ 698-2700 MHz 2.5 dBi @ 3400-3800 MHz
<b>VSWR:</b>	<2.5:1 across 90% of the bands
<b>Feed power handling:</b>	10 W
<b>Input impedance:</b>	50 Ohm (nominal)
<b>Coax cable loss:</b>	0.25 dB/m @ 400 MHz 0.385 dB/m @ 900 MHz 0.565 dB/m @ 1800 MHz 0.666 dB/m @ 2400 MHz 0.788 dB/m @ 3000 MHz
<b>DC short:</b>	Yes

## Product Box Contents

<b>Antenna:</b>	A-OMNI-0402
<b>Mounting bracket:</b>	1" (14 TPI) Marine Adapter (BRKT-40) & L-bracket (Ø30-50mm Pole)

## Ordering Information

<b>Commercial name:</b>	OMNI-402
<b>Order product code:</b>	A-OMNI-0402-V1
<b>EAN number:</b>	0707273470393

## Mechanical Specifications

<b>Product dimensions</b>	750 mm x Ø75 mm (Incl. BRKT-40)
<b>Packaged dimensions:</b>	704 mm x 147 mm x 100 mm
<b>Weight:</b>	0.86 kg
<b>Packaged weight:</b>	1.7 kg
<b>Radome material:</b>	UV Stable Marine ASA
<b>Radome colour:</b>	Brilliant White Pantone P 179-1 C
<b>Mounting Type:</b>	Standard 1" -14 TPI marine mount & Wall/pole mount

## Environmental Specifications, Certification & Approvals

<b>Wind Survival:</b>	<160 km/h
<b>Temperature Range (Operating):</b>	-40°C to +80°C
<b>Environmental Conditions:</b>	Outdoor/Indoor
<b>Water ingress protection ratio/standard:</b>	IP 68
<b>Salt Spray:</b>	MIL-STD 810F/ASTM B117
<b>Operating Relative Humidity:</b>	Up to 98%
<b>Storage Humidity:</b>	5% to 95% - non-condensing
<b>Storage Temperature:</b>	-40°C to +80°C
<b>Enclosure Flammability Rating:</b>	UL 94-HB
<b>Impact resistance:</b>	IK 08
<b>Product Safety &amp; Environmental:</b>	Complies with CE and RoHS standards



**Antenna Performance Plots**

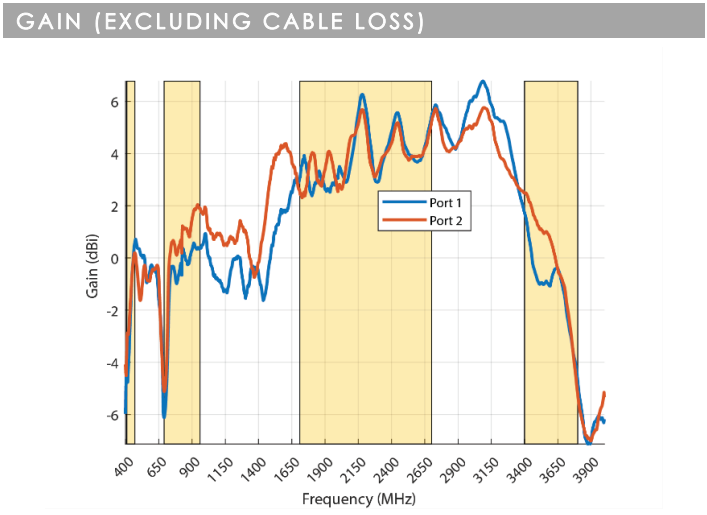
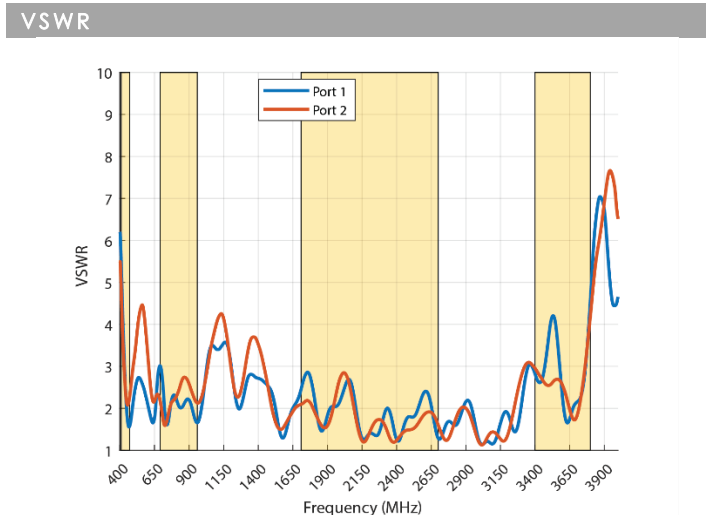

**Voltage Standing Wave Ratio (VSWR)**

VSWR is a measure of how efficiently radio-frequency power is transmitted from a power source, through a transmission line, into a load. In an ideal system, 100% of the energy is transmitted which corresponds to a VSWR of 1:1.

The OMNI-402 delivers superior performance across all bands with a VSWR of  $\leq 2.5:1$  or better across 90% of the bands.

**Gain\* in dBi**

6.2 dBi is the peak gain across all bands from 410 – 3800 MHz

Gain @ 410 – 470 MHz:	1 dBi
Gain @ 698 – 2700 MHz:	6.2 dBi
Gain @ 3400 – 3800 MHz:	2.5 dBi

*\*Antenna gain measured with polarisation aligned standard antenna*

**Technical Drawings**

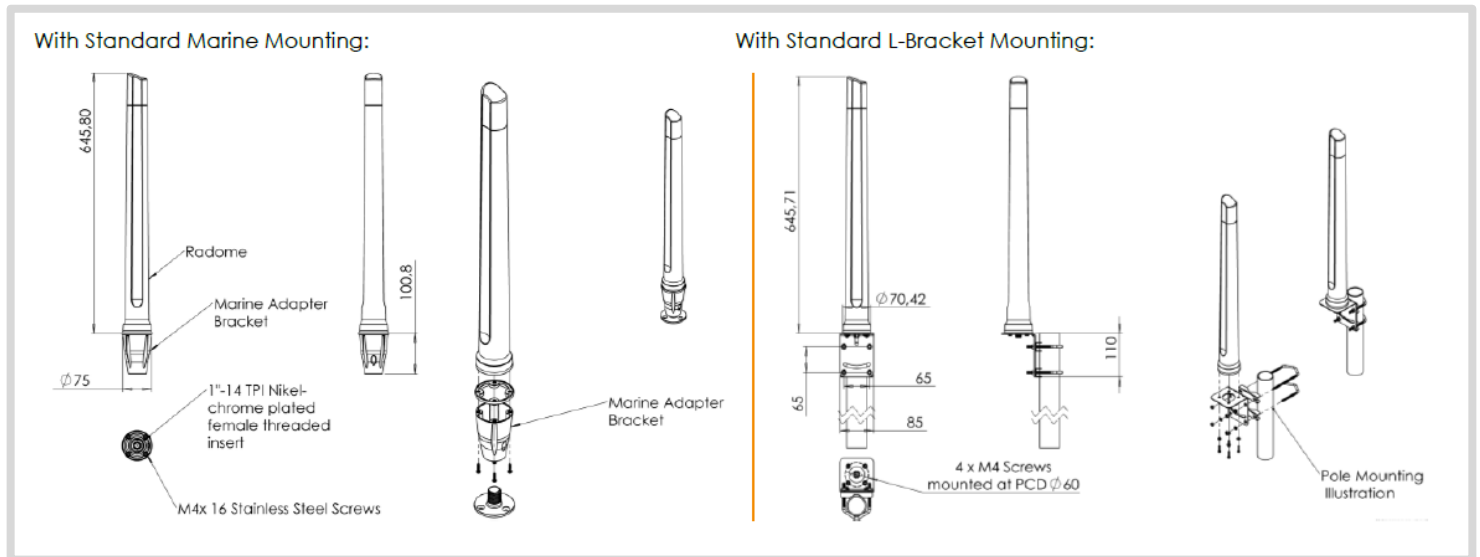

**Radiation Patterns**

Azimuth (Top View): 410–470 MHz      Azimuth (Top View): 698–960 MHz      Azimuth (Top View): 1710–2100 MHz

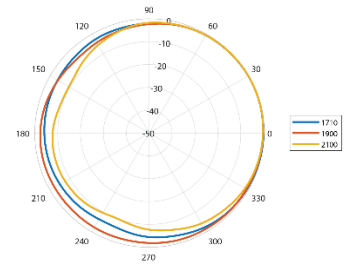
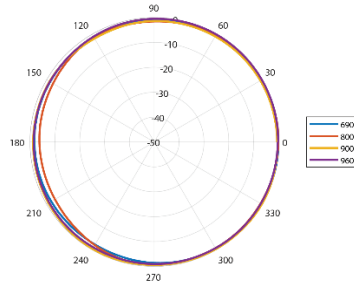
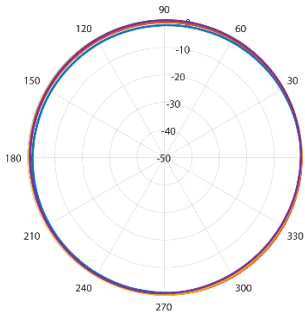

Azimuth (Top View): 2300–2700 MHz      Azimuth (Top View): 3400–3800 MHz      Elevation 1 (Side View): 410–470 MHz

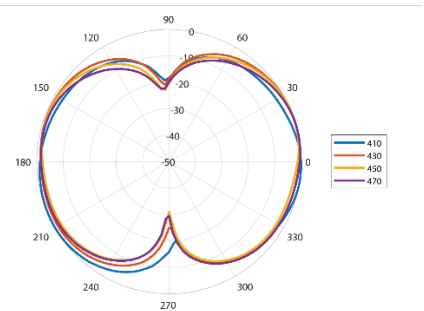
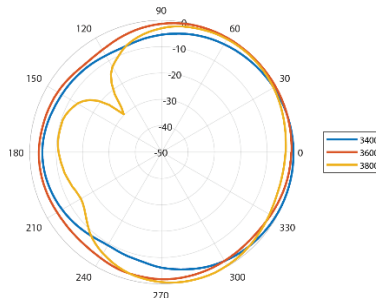
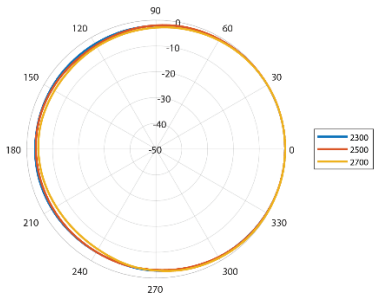

Elevation 1 (Side View): 698–960 MHz      Elevation 1 (Side View): 1710–2100 MHz      Elevation 1 (Side View): 2300–2700 MHz

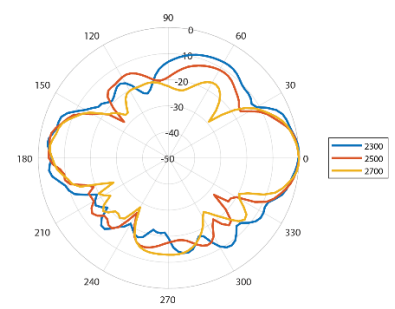
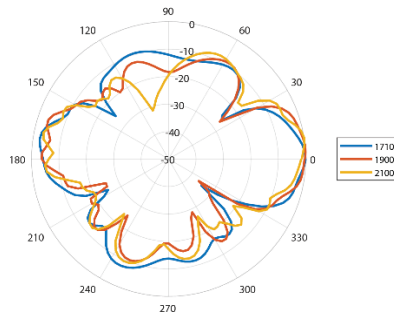
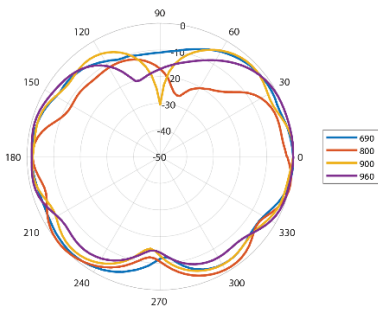

Elevation 1 (Side View): 3400–3800 MHz      Elevation 2 (Side View): 410–470 MHz      Elevation 2 (Side View): 698–960 MHz

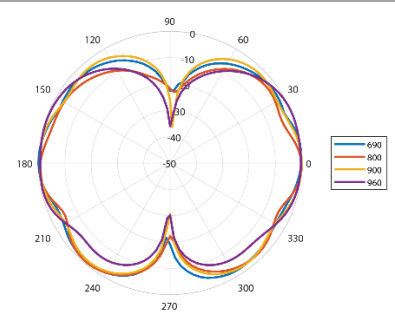
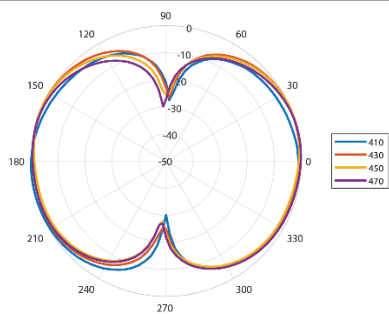
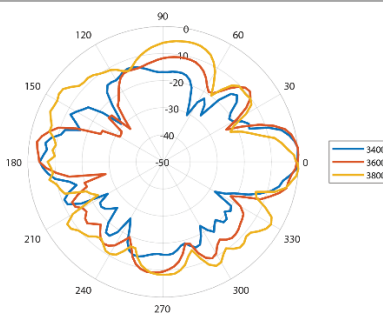

Elevation 2 (Side View): 1710–2100 MHz      Elevation 2 (Side View): 2300–2700 MHz      Elevation 2 (Side View): 3400–3800 MHz

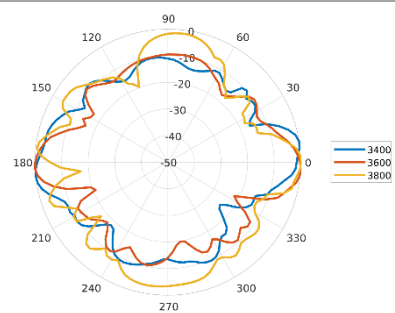
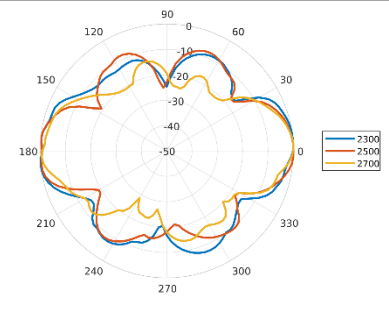
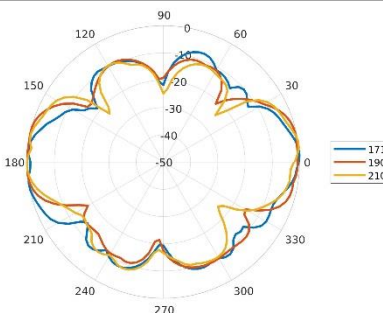

## Mounting Options

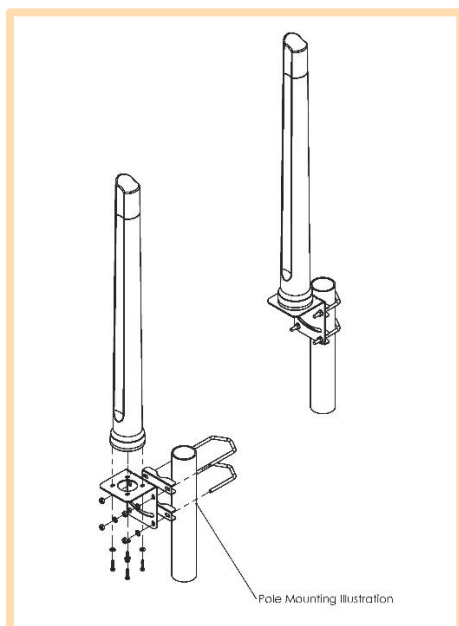

### Pole Mount

L-Bracket 316 Stainless Steel – included  
 (for Ø 30-50mm pole)

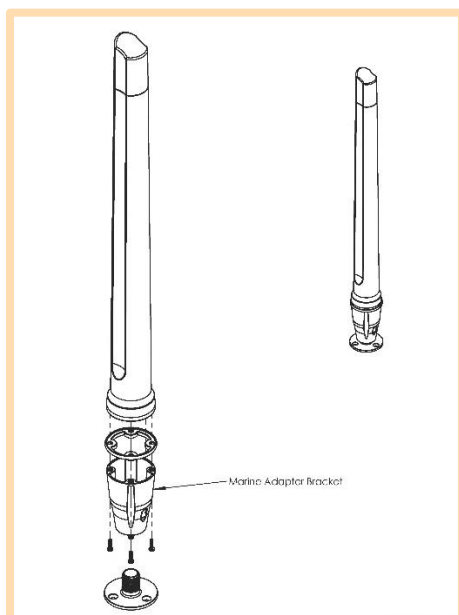

### Marine Bracket Mount

1" -14 TPI female adapter – included

Mounts to standard marine brackets:

- BRKT-37: Flat Mount - Optional
- BRKT-38: Ratchet Mount - Optional
- BRKT-39: Rail Mount - Optional

See Optional Accessories below

Also available: BRKT-41 with 1.25" – 11TPI female adapter (Optional)

See Accessories below

## Additional Accessories



### BRKT-37

Marine flat mount antenna bracket 1"-14TPI 316 Stainless Steel

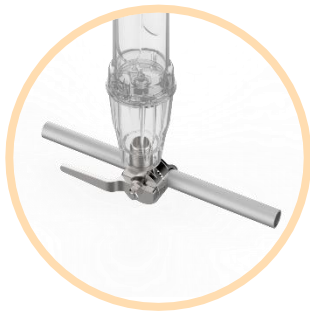

### BRKT-38

Marine ratchet rail mount antenna bracket 1"-14TPI 316 Stainless Steel



### BRKT-39

Heavy duty marine mount antenna bracket 1"-14TPI 316 Stainless Steel

See accessories technical specifications on [www.poynting.tech](http://www.poynting.tech)

## Contact Poynting

### Poynting Antennas (Pty) Ltd - Head Office

Unit 4, N1 Industrial Park  
Landmarks Avenue,  
Samrand, 0157  
South Africa

**Phone:** +27 (0) 12 657 0050

**E-mail:** sales@poynting.co.za

### Poynting Europe

Regus Business Center Neue Messe Riem  
Kronstadter Straße 4  
81677 München  
Germany

**Phone:** +49 89 208026538

**E-mail:** sales-europe@poynting.tech