



FEATURES

- Universal 85 - 305VAC or 120 - 430VDC Input voltage
- Accepts AC or DC input (dual-use of same terminal)
- Operating ambient temperature range: -40°C to +85°C
- High I/O isolation test voltage up to 4000VAC
- Low ripple & noise
- Output short circuit, over-current, over-voltage, over-temperature protection
- DIN rail TS-35/7.5 or 15 mountable
- OVC II
- Operating altitude up to 5000m
- 3 years warranty
- Suitable for small chassis and narrow space installation
- Safety according to UL62368, EN60335, EN61558, GB4943

LI75-23BxxR3 is Mornsun AC-DC converter series featuring a cost-effective, energy efficient green power supply solution for standard DIN-rail mounting. The products offer a high level of stability and immunity to noise for industrial control equipment, machinery, and other industrial equipment in a variety of harsh environments. These light weight AC-DC converters have an extremely compact design and the standard rail installation for space saving. With good EMC performance, compliant with international UL61010, EN/UL/BS EN62368, EN60335, EN61558, GB4943 standards for EMC and safety.

Selection Guide

Certification	Part No.*	Output Power (W)	Nominal Output Voltage and Current (Vo/Io)	Output Voltage Adjustable Range (V)	Efficiency at 230VAC (%) Typ.	Max. Capacitive Load (µF)
EN/UL/BIS	LI75-23B12R3	75.6	12V/6.3A	12-14V	88	6000
	LI75-23B24R3	76.8	24V/3.2A	24-28V	90	1500
	LI75-23B48R3		48V/1.6A	48-53V	91	1000

Note: *Use suffix "Q" for conformal coating.

Input Specifications

Item	Operating Conditions		Min.	Typ.	Max.	Unit
Input Voltage Range	AC input		85	--	305	VAC
	DC input		120	--	430	VDC
Input Voltage Frequency			47	--	63	Hz
Input Current	115VAC		--	--	2	A
	230VAC		--	--	1	
Inrush Current	115VAC		--	30	--	A
	230VAC		--	50	--	
Leakage Current	277VAC, 60Hz		<0.5mA			
Hot Plug			Unavailable			

Output Specifications

Item	Operating Conditions		Min.	Typ.	Max.	Unit
Output Voltage Accuracy	Full load range	12V	--	±2.0	--	%
		24V/48V	--	±1.0	--	



Line Regulation	Rated load	--	±0.5	--		
Load Regulation	0% - 100% load	--	±1.0	--		
Ripple & Noise*	20MHz bandwidth (peak-to-peak value)	12V	--	80	--	mV
		24V	--	120	--	
		48V	--	150	--	
Temperature Coefficient		--	±0.03	--	%/°C	
Minimum Load		0	--	--	%	
Stand-by Power Consumption	115VAC	--	0.5	1.0	W	
	230VAC	--	1.0	1.5		
Hold-up Time	115VAC	--	12	--	ms	
	230VAC	--	60	--		
Short Circuit Protection	Recovery time <5s after the short circuit disappear.	Constant current mode, continuous, self-recover				
Over-current Protection	230VAC, rated load	Normal temperature	110% Io - 150% Io, self-recover			
		High temperature, low temperature	≥ 105% Io, self-recover			
Over-voltage Protection	12V	≤ 17VDC (Hiccup, self-recover)				
	24V	≤ 33VDC (Hiccup, self-recover)				
	48V	≤ 60VDC (Hiccup, self-recover)				
Over-temperature Protection	230VAC, rated load	Output voltage turn off, self-recover after the temperature drops				
Note: *The "Tip and barrel method" is used for ripple and noise test, output parallel 47uF electrolytic capacitor and 0.1uF ceramic capacitor, please refer to Enclosed Switching Power Supply Application Notes for specific information.						

General Specifications

Item	Operating Conditions		Min.	Typ.	Max.	Unit	
Isolation Test	Input - ⊕	Electric strength test for 1min., leakage current <10mA	2000	--	--	VAC	
	Input - output		4000	--	--		
	Output - ⊕		500	--	--		
Insulation Resistance	Input - ⊕	At 500VDC	50	--	--	MΩ	
	Input - output		50	--	--		
	Output - ⊕		50	--	--		
Operating Temperature			-40	--	+85	°C	
Storage Temperature			-40	--	+85		
Operating Humidity	Non-condensing			10	--	95	%RH
Storage Humidity				20	--	95	
Switching Frequency			--	65	--	kHz	
Power Derating	Operating temperature derating	-40°C to -30°C	5	--	--	%/°C	
		+45°C to +85°C	2	--	--		
	Input voltage derating	85VAC - 100VAC	2	--	--	%VAC	
		277VAC - 305VAC	0.71	--	--		
Safety Standard			UL61010-1, IS13252 (Part1) safety approved & EN62368-1, BS EN62368-1 (Report) Design refer to EN60335-1, GB4943.1, IEC/UL62368-1, IEC/EN61558-1				
Safety Class			CLASS I				
MTBF	MIL-HDBK-217F@25°C		≥ 300,000 h				

Mechanical Specifications

Case Material	Metal (AL1100, SGCC)
Dimensions	110.00mm x 87.50mm x 32.00mm
Weight	340g (Typ.)
Cooling Method	Free air convection

Electromagnetic Compatibility (EMC)

Emissions	CE	CISPR32/EN55032	CLASS B	
	RE	CISPR32/EN55032	CLASS B	
	Harmonic current	IEC/EN61000-3-2	CLASS A	
Immunity	ESD	IEC/EN 61000-4-2	Contact ±6KV/Air ±8KV	perf. Criteria A
	RS	IEC/EN 61000-4-3	10V/m	perf. Criteria A
	EFT	IEC/EN 61000-4-4	±2KV	perf. Criteria A
	Surge	IEC/EN 61000-4-5	line to line ±2KV/line to ground ±4KV	perf. Criteria A
	CS	IEC/EN61000-4-6	10 Vr.m.s	perf. Criteria A
	MS	IEC/EN61000-4-8	30A/m	perf. Criteria A
	Voltage dips, short interruptions and voltage variations immunity	IEC/EN61000-4-11	0%, 70%	perf. Criteria B

Product Characteristic Curve

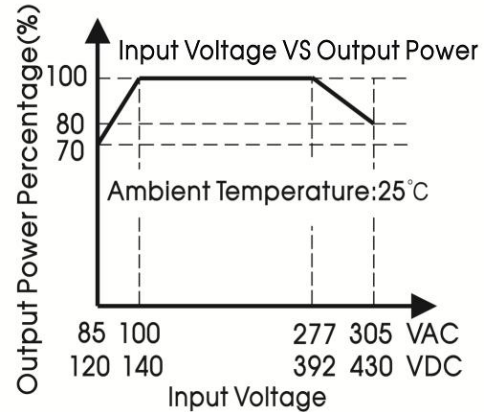
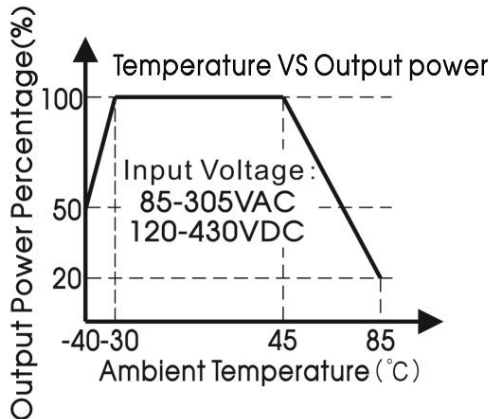

Note: 1. With an AC input voltage between 85 - 100VAC/277 - 305VAC and a DC input between 120 - 140VDC/392 - 430VDC the output power must be derated as per the temperature derating curves;

2. This product is suitable for applications using natural air cooling; for applications in closed environment please consult Mornsun FAE.

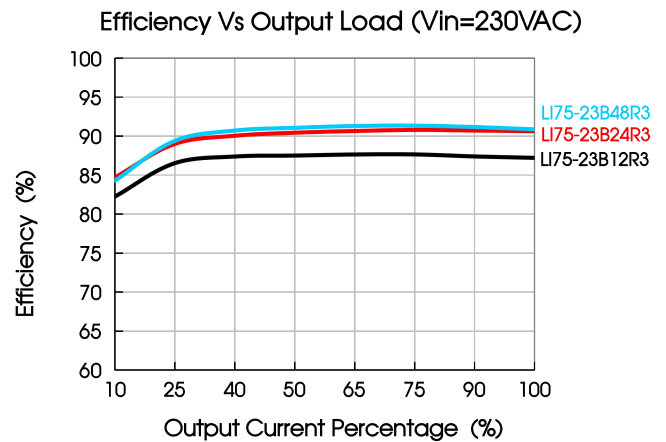
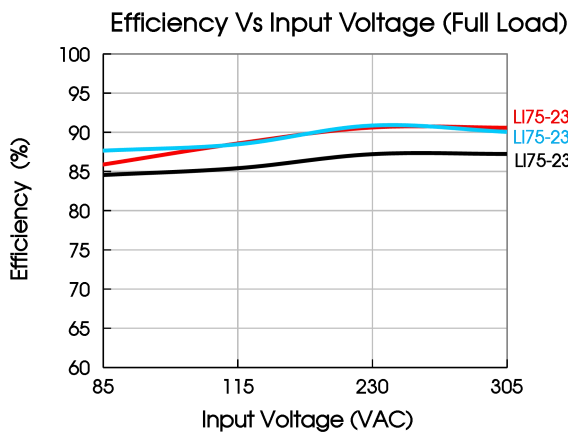

Installation Diagram

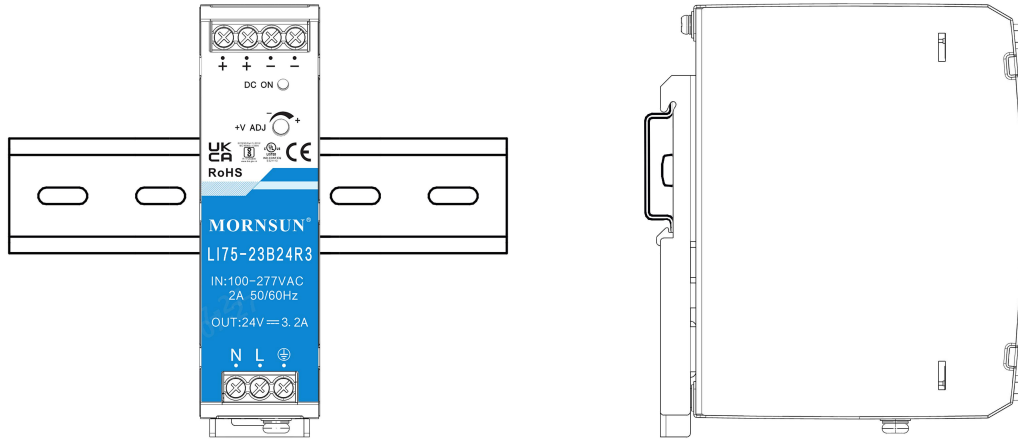

Bill Of Material		
1	Product	1 PCS
2	Phillips screwdriver Slotted screwdriver	1 PCS
3	TS35/7.5 or TS35/15	1 PCS
	26-10AWG wires	/ PCS
4	All above is only for reference, the actual wiring diameter and locking torque refer to the appearance size diagram	

Installation steps ①-②

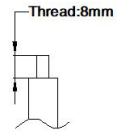
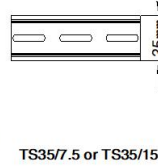
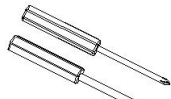
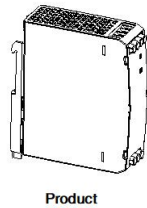

① Put the product buckle down into the TS35 rail.

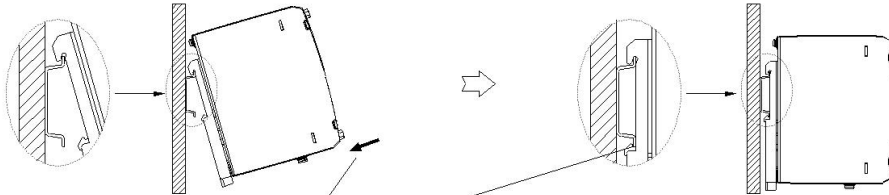

② Push the product perpendicular to the TS35 rail until hear the sound of the clip snapping into the rail.

Disassembly steps ③-④

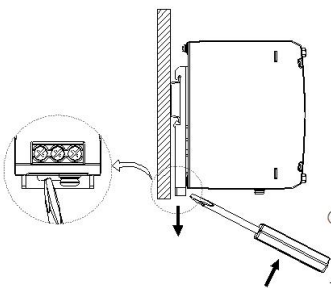

③ After inserting a Slotted screwdriver into the square groove at the bottom of the buckle, push the sliding part of the buckle downward according to the direction shown.

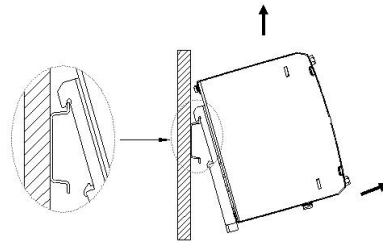

④ Push the bottom of the product outwards and take it out upwards.

Connecting/Disconnecting Steps ⑤-⑥

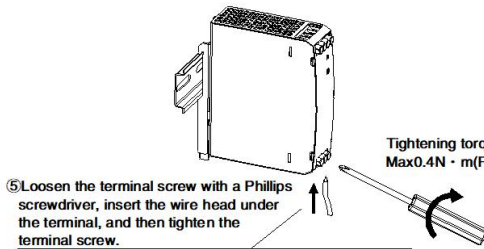

⑤ Loosen the terminal screw with a Phillips screwdriver, insert the wire head under the terminal, and then tighten the terminal screw.

Tightening torque:
 Max 0.4N · m (Reference);

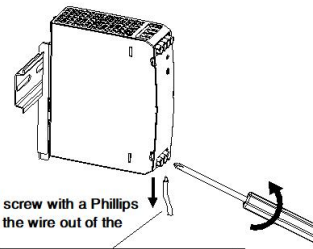

⑥ Loosen the terminal screw with a Phillips screwdriver and pull the wire out of the terminal hole.

Note: Keep the following installation clearances: 20mm on top, 20mm on the bottom, 5mm on the left and right sides are recommended when the device is loaded permanently with more than 50% of the rated power. Increase this clearance to 15mm in case the adjacent device is a heat source (e.g. another power supply).

Dimensions and Recommended Layout

THIRD ANGLE PROJECTION

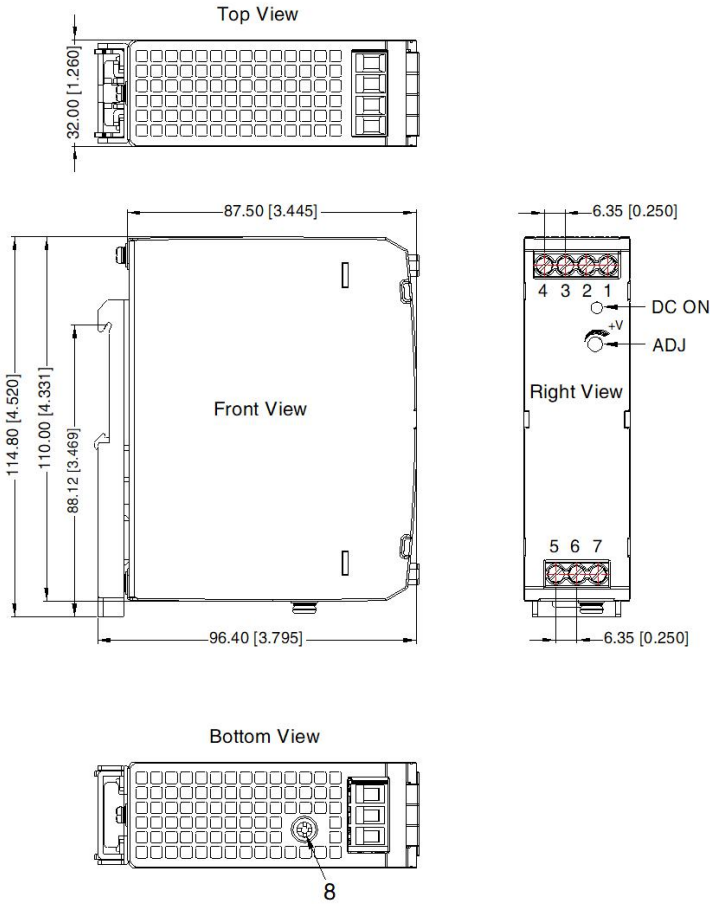

Pin-Out	
Pin	Mark
1	-Vo
2	-Vo
3	+Vo
4	+Vo
5	AC(N)
6	AC(L)
7	

7, 8 any position must be connected to the earth ()

Note:
Unit: mm[inch]
ADJ: Output adjustable resistor
Wire range: 26-10 AWG
Tightening torque: Max 0.4 N-m
Mounting rail: TS35, rail needs to connect safety ground
General tolerances: $\pm 1.00 [\pm 0.039]$



WARNING Risk of electrical shock, fire, personal injury or death:

AVERTISSEMENT AVERTISSEMENT Risque de choc électrique, d'incendie, de blessures corporelles ou de décès :

1. Do not use the power supply without proper grounding (Protective Earth). Use the terminal on the input block for earth connection and not one of the screws on the housing;
N'utilisez pas l'alimentation électrique sans mise à la terre appropriée (Terre protectrice). Utilisez le terminal sur le bloc d'entrée pour la connexion terrestre et non pas une des vis sur le boîtier;
2. Turn power off before working on the device, protect against inadvertent re-powering;
Éteignez l'alimentation avant de travailler sur l'appareil, protégez-vous contre la réénergisation accidentelle;
3. Make sure that the wiring is correct by following all local and national codes;
Assurez-vous que le câblage est correct en suivant tous les codes locaux et nationaux;
4. Do not modify or repair the unit;
Ne modifiez pas ou ne réparez pas l'appareil;
5. Do not open the unit as high voltages are present inside;
Ne modifiez pas ou ne réparez pas l'appareil;
6. Use caution to prevent any foreign objects from entering the housing;
Faire preuve de prudence pour empêcher les objets étrangers d'entrer dans le logement;
7. Do not use in wet locations or in areas where moisture or condensation can be expected;
Faire preuve de prudence pour empêcher les objets étrangers d'entrer dans le logement;
8. Do not touch during power-on, and immediately after power-off, hot surfaces may cause burns; 
Ne touchez pas pendant l'alimentation et, immédiatement après l'alimentation, les surfaces chaudes peuvent causer des brûlures.
9. For ambient temperature $\leq 60^{\circ}\text{C}$, use $\geq 90^{\circ}\text{C}$ - copper wire only; for ambient temperature $>60^{\circ}\text{C}$ to 85°C , use $\geq 105^{\circ}\text{C}$ - copper wire only; use only wires with a minimum dielectric strength of 300V (input) and 60V (output);
Température ambiante $\leq 60^{\circ}\text{C}$, utiliser $\geq 90^{\circ}\text{C}$ - seulement fils de cuivre; Température ambiante $>60^{\circ}\text{C}$ et 85°C , utiliser $\geq 105^{\circ}\text{C}$ - seulement fils de cuivre; Uniquement pour l'utilisation de fils de cuivre d'une résistance d'isolation minimale de 300V (d'entrée) et 60V (de sortie).

Note:

1. For additional information on Product Packaging please refer to www.mornsun-power.com. Packaging bag number: 58220280;
2. Unless otherwise specified, parameters in this datasheet were measured under the conditions of $T_a=25^{\circ}\text{C}$, humidity $<75\%$ RH with nominal input voltage and rated output load;
3. The room temperature derating of $5^{\circ}\text{C}/1000\text{m}$ is needed for operating altitude greater than 2000m;
4. All index testing methods in this datasheet are based on our company corporate standards;
5. In order to improve the efficiency at high input voltage, there will be audible noise generated, but it does not affect product performance and reliability;
6. We can provide product customization service, please contact our technicians directly for specific information;
7. Products are related to laws and regulations: see "Features" and "EMC";
8. The out case needs to be connected to PE (\oplus) of system when the terminal equipment in operating;
9. The output voltage can be adjusted by the ADJ, clockwise to increase;
10. Our products shall be classified according to ISO14001 and related environmental laws and regulations, and shall be handled by qualified units;
11. The power supply is considered a component which will be installed into a terminal equipment. All EMC tests should be confirmed with the final equipment. Please consult our FAE for EMC test operation instructions.

Matlog

4 avenue du Vieil Etang | Espace Ouest - Hall A | 78180 Montigny le Bretonneux
+33 1 80 97 92 70 | contact@matlog.com | www.matlog.fr