

PMR Panel Mount Power Supply

5V 300W 1 Phase / PMR-5V320WD□A

PMR

Highlights & Features

- Universal AC input voltage range
- Full corrosion resistant aluminium casing
- Built-in active PFC and conforms to harmonic current IEC/EN 61000-3-2, Class A and Class D
- Low profile design for 1U installation
- Built-in DC OK relay contact and redundancy operation (PMR-5V320WDBA and PMR-5V320WDCA)



Safety Standards



CB Certified for worldwide use

Model Number: PMR-5V320WD□A
Unit Weight: 0.86 kg (1.90 lb)
Dimensions (L x W x D): 215 x 115 x 30 mm
 (8.46 x 4.53 x 1.18 inch)

General Description

The PMR-5V320WD□A offers nominal output voltage of 5V with a wide operating temperature range from -20°C to +70°C and can withstand shock and vibration according to IEC 60068-2. The product comes with universal AC input voltage range at 88Vac to 264Vac. At only 30mm height and encased in a full corrosion resistant aluminium casing, the PMR series is made for installation in narrow space while its built-in active PFC circuit provides high power factor values and conforms to harmonic current emission according to IEC/EN 61000-3-2, Class A and Class D.

Model Information

PMR Panel Mount Power Supply

Model Number	Input Voltage Range	Rated Output Voltage	Rated Output Current
PMR-5V320WD□A	88-264Vac	5Vdc	60.0A

Model Numbering

						CC Code
PM	R –	5V	320W	D	□	A
Panel Mount	Product Series R – Standard Rack Type Series (1U)	Output Voltage	Output Power (320W series model)	Package Type D – Enclosed without Fan	Connector Type A – Terminal Block B – Terminal Block (Parallel Connection)* G – Front Face* C – Front Face (Parallel Connection)*	Variable A – Coating

*Options

PMR Panel Mount Power Supply

5V 300W 1 Phase / PMR-5V320WD□A

Specifications

Input Ratings / Characteristics

Nominal Input Voltage	100-240Vac	
Input Voltage Range	88-264Vac	
Nominal Input Frequency	50-60Hz	
Input Frequency Range	47-63Hz	
Input Current	< 5.00A @ 115Vac, < 2.50A @ 230Vac	
Efficiency at 100% Load	PMR-5V320WD <u>A</u>	86.0% typ. @ 115Vac, 88.0% typ. @ 230Vac
	PMR-5V320WD <u>G</u> A	
	PMR-5V320WD <u>B</u> A	85.0% typ. @ 115Vac, 87.0% typ. @ 230Vac
	PMR-5V320WD <u>C</u> A	
Max Inrush Current (Cold Start)	< 20A @ 115Vac, < 40A @ 230Vac	
Power Factor at 100% Load	0.98 typ. @ 115Vac, 0.95 typ. @ 230Vac	
Leakage Current	< 1mA @ 240Vac	

Output Ratings / Characteristics**

Nominal Output Voltage	5Vdc	
Factory Set Point Tolerance	5Vdc \pm 1% (initial set point tolerance from factory) For PMR-5V320WD <u>A</u> A and PMR-5V320WD <u>G</u> A	
Output Voltage Adjustment Range	PMR-5V320WD <u>A</u> A	4.50-5.50Vdc
	PMR-5V320WD <u>G</u> A	
Output Voltage Range	PMR-5V320WD <u>B</u> A	4.75-5.25Vdc (No potentiometer)
	PMR-5V320WD <u>C</u> A	
Output Current	60.0A (300W max.)	
Output Power	300W	
Line Regulation	\pm 0.5% typ. (@ 115Vac & 230Vac, 100% load)	
Load Regulation	\pm 1.0% typ. (@ 115Vac & 230Vac, 0-100% load) For PMR-5V320WD <u>A</u> A and PMR-5V320WD <u>G</u> A	
PARD*** (20MHz)	< 150mVpp @ 25°C < 300mVpp @ -20°C	
Rise Time	100ms typ. @ 115Vac & 230Vac (100% load)	
Start-up Time	3000ms typ. @ 115Vac, 1500ms typ. @ 230Vac (100% load)	
Hold-up Time	8ms typ. @ 115Vac & 230Vac (100% load)	
Dynamic Response (Overshoot & Undershoot O/P Voltage)	\pm 1500mVpp @ 10-50% load and 50-100% load	
Start-up with Capacitive Loads	8,000 μ F Max	
Functional*	Parallel Connection	<ul style="list-style-type: none"> For N+1 connection, note that N \leq 4 (difference of coupling impedance for each power supply must be < 5mΩ in redundancy connection). The total output power shall be < N \times 80% \times rated power.
	DC OK Relay Contact	5V / 0.1A The relay is usually open when the output is normal.

*For PMR-5V320WDBA and PMR-5V320WDCA.

**For power de-rating from 40°C to 70°C, see power de-rating on page 3.

***PARD is measured with an AC coupling mode and in parallel to end terminal with 0.1 μ F ceramic capacitor & 47 μ F electrolytic capacitor.

PMR Panel Mount Power Supply

5V 300W 1 Phase / PMR-5V320WD□A

Mechanical

Case Chassis / Cover	Aluminium	
Dimensions (L x W x D)	215 x 115 x 30 mm (8.46 x 4.53 x 1.18 inch)	
Unit Weight	0.86 kg (1.90 lb)	
Indicator	Green LED (DC OK)	
Cooling System	Convection	
Terminal	PMR-5V320WD <u>A</u> A	M3.5 x 9 Pins (Rated 300V/15A)
	PMR-5V320WD <u>G</u> A	M3.5 x 9 Pins (Rated 300V/20A)
	PMR-5V320WD <u>B</u> A	M3.5 x 9 Pins (Rated 300V/15A)
	PMR-5V320WD <u>C</u> A	M3.5 x 9 Pins (Rated 300V/20A)
Wire	AWG 14-12*	
Noise (1 Meter from power supply)	Sound Pressure Level (SPL) < 25dBA	

*Only use wire that can withstand operating temperature of more than 125°C.

Environment

Surrounding Air Temperature	Operating	-20°C to +70°C (Cold start at -40°C)
	Storage	-40°C to +85°C
Power De-rating	> 40°C de-rate power by 1% / °C, > 50°C de-rate power by 1.5% / °C < 110Vac de-rate power by 1% / 1V	
Operating Humidity	5 to 95% RH (Non-Condensing)	
Operating Altitude	0 to 5,000 Meters (16,400 ft)	
Shock Test	Non-Operating	IEC 60068-2-27, Half Sine: 50G for a duration of 11ms, 3 shocks for each 3 directions
Vibration	Non-Operating	IEC 60068-2-6, Random: 5Hz to 500Hz (2.09Grms); 20 min per axis for all X, Y, Z direction
Over Voltage Category	II	
Pollution Degree	2	

Protections

Overvoltage	5.75-6.50V, Hiccup Mode, Non-Latching (Auto-Recovery)
Overload / Overcurrent	105-150%, Hiccup Mode, Non-Latching (Auto-Recovery)
Over Temperature	Hiccup Mode, Non-Latching (Auto-Recovery)
Short Circuit	Hiccup Mode, Non-Latching (Auto-Recovery)
Internal Fuse at L pin	T6.3AH
Protection Against Shock	Class I with PE** connection

**PE: Primary Earth

PMR Panel Mount Power Supply

5V 300W 1 Phase / PMR-5V320WD□A

Reliability Data

MTBF	> 700,000 hrs. as per Telcordia SR-332 I/P: 100Vac, O/P: 100% load, Ta: 35°C
Expected Cap Life Time	10 years (115Vac & 230Vac, 50% load @ 40°C)

Safety Standards / Directives

Safety Entry Low Voltage		SELV (EN 60950-1)
Electrical Safety	TUV Bauart	EN 60950-1
	UL/cUL recognized	UL/cUL recognized to UL 60950-1 and CSA C22.2 No. 60950-1 (File No. E131881)
	CB scheme	IEC 60950-1
	CCC	CCC to GB 4943
CE		In conformance with EMC Directive 2014/30/EU and Low Voltage Directive 2014/35/EC
Material and Parts		RoHS Directive 2011/65/EU Compliant
Galvanic Isolation	Input to Output	3.0KVac
	Input to Ground	2.0KVac
	Output to Ground	0.5KVac

EMC

Emissions (CE & RE)		CISPR 32, EN 55032, FCC Title 47: Class B
Immunity		EN 55024
Electrostatic Discharge	IEC 61000-4-2	Level 4 Criteria A ¹⁾ Air Discharge: 15kV Contact Discharge: 8kV
Radiated Field	IEC 61000-4-3	Level 3 Criteria A ¹⁾ 80MHz-1GHz, 10V/M with 1kHz tone / 80% modulation
Electrical Fast Transient / Burst	IEC 61000-4-4	Level 3 Criteria A ¹⁾ 2kV
Surge	IEC 61000-4-5	Level 3 Criteria A ¹⁾ Common Mode ²⁾ : 2kV Differential Mode ³⁾ : 1kV
Conducted	IEC 61000-4-6	Level 3 Criteria A ¹⁾ 150kHz-80MHz, 10Vrms
Power Frequency Magnetic Fields	IEC 61000-4-8	Criteria A ¹⁾ 10A/Meter
Voltage Dips and Interruptions	IEC 61000-4-11	100% dip; 1 cycle (20ms); Self Recoverable
Low Energy Pulse Test (Ring Wave)	IEC61000-4-12	Level 3 Criteria A ¹⁾ Common Mode ²⁾ : 2kV Differential Mode ³⁾ : 1kV
Harmonic Current Emission		IEC/EN 61000-3-2, Class A and Class D
Voltage Fluctuation and Flicker		IEC/EN 61000-3-3

1) Criteria A: Normal performance within the specification limits

2) Asymmetrical: Common mode (Line to earth)

3) Symmetrical: Differential mode (Line to line)

PMR Panel Mount Power Supply

5V 300W 1 Phase / PMR-5V320WD□A

Block Diagram

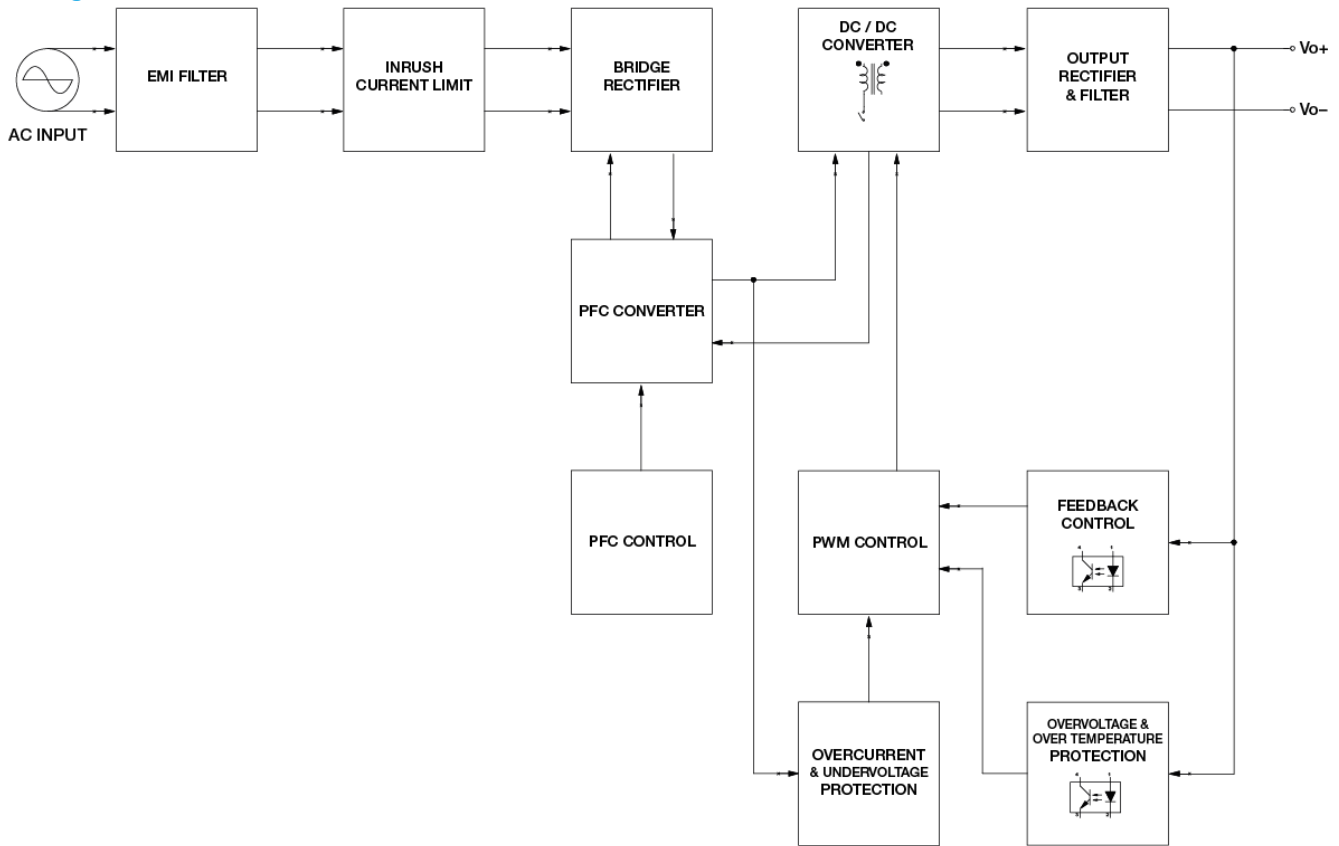

Device Descriptions

PMR-5V320WDAA, PMR-5V320WDBA: Terminal Block	PMR-5V320WDGA, PMR-5V320WDCA: Front Face

- 1) Input & Output terminal block connector
- 2) DC voltage adjustment potentiometer (Option)
- 3) DC OK control LED (Green)
- 4) DC OK relay contact (Option)

PMR Panel Mount Power Supply

5V 300W 1 Phase / PMR-5V320WD□A

Dimensions

PMR-5V320WDA, PMR-5V320WDBA: Terminal Block
L x W x D: 215 x 115 x 30 mm (8.46 x 4.53 x 1.18 inch)

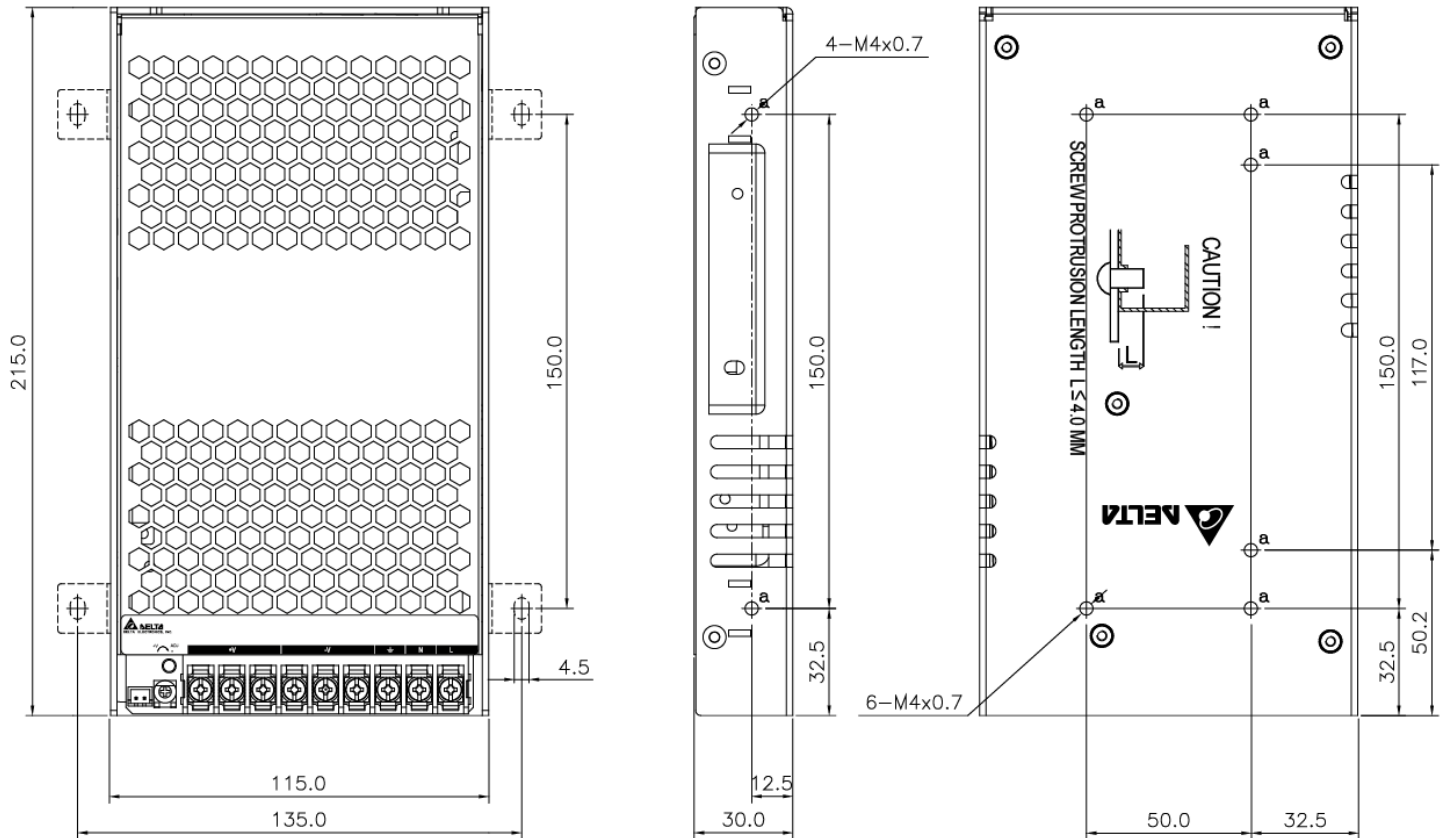

PMR Panel Mount Power Supply

5V 300W 1 Phase / PMR-5V320WD□A

PMR-5V320WDGA, PMR-5V320WDCA: Front Face
 L x W x D: 215 x 115 x 30 mm (8.46 x 4.53 x 1.18 inch)

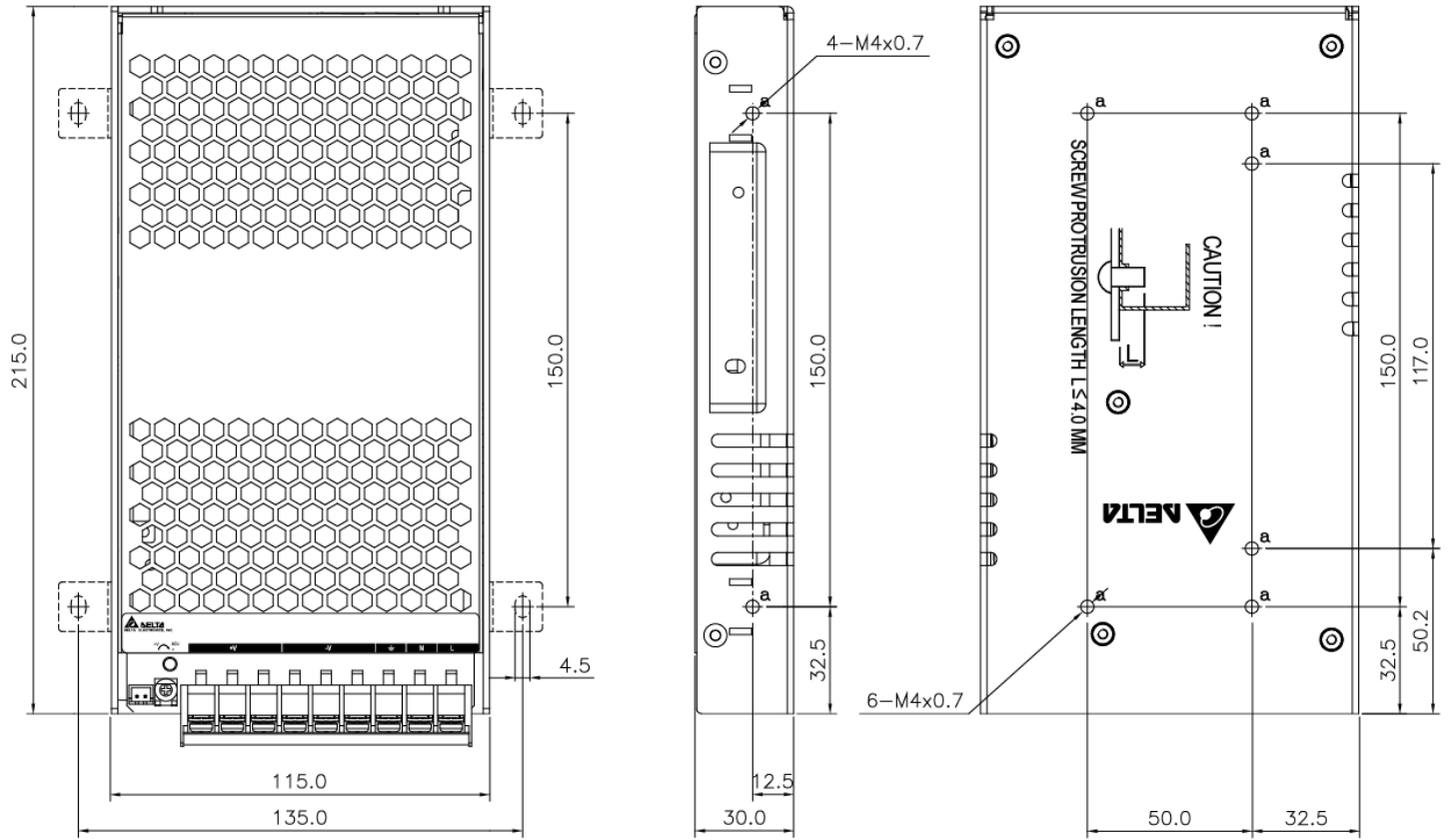

PMR Panel Mount Power Supply

5V 300W 1 Phase / PMR-5V320WD□A

Engineering Data

Output Load De-rating VS Surrounding Air Temperature

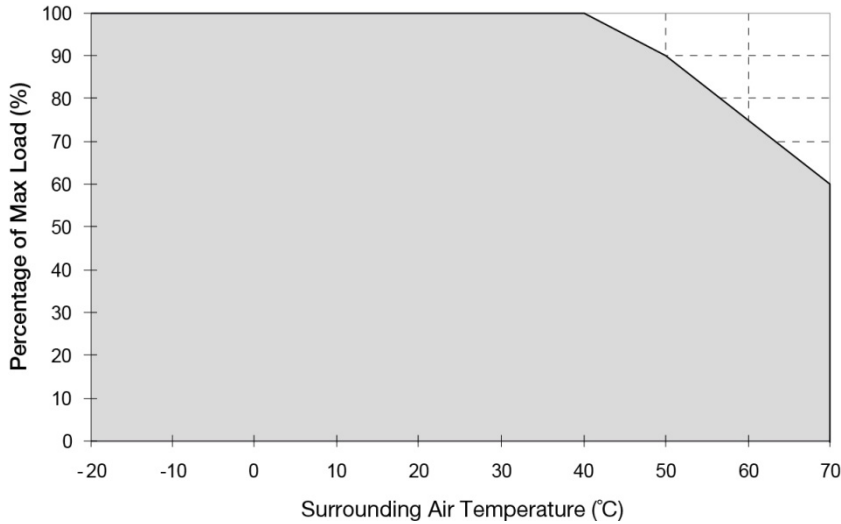

Fig. 1 De-rating for Vertical and Horizontal Mounting Orientation

> 40°C de-rate power by 1% / °C,
 > 50°C de-rate power by 1.5% / °C

Note

1. Power supply components may degrade, or be damaged, when the power supply is continuously used outside the shaded region, refer to the graph shown in Fig. 1.
2. If the output capacity is not reduced when the surrounding air temperature exceeds its specification as defined on Page 3, the device will run into Over Temperature Protection. When activated, the output voltage will go into bouncing mode and will recover when the surrounding air temperature is lowered or the load is reduced as far as necessary to keep the device in working condition.
3. In order for the device to function in the manner intended, it is also necessary to keep a safety distance of 20mm (0.78 inch) with adjacent units while the device is in operation.
4. Depending on the surrounding air temperature and output load delivered by the power supply, the device can be very hot!
5. If the device has to be mounted in any other orientation, please contact info@deltapsu.com for more details.

Output Load De-rating VS. Input Voltage

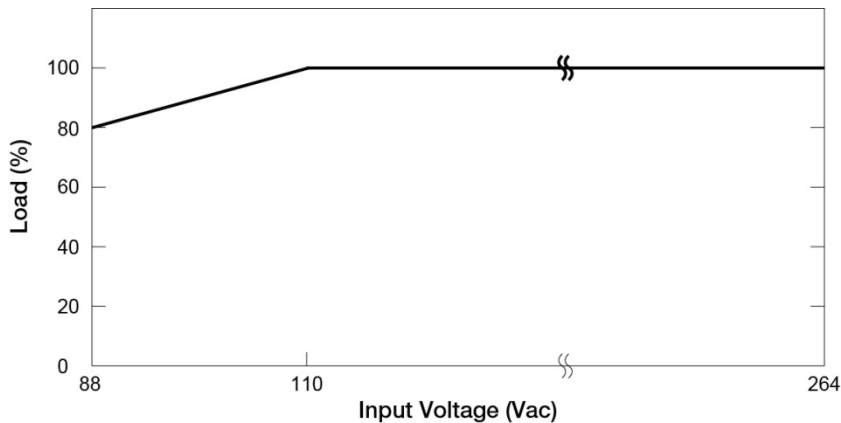

- No output power de-rating for the input voltage from 110Vac to 264Vac

PMR Panel Mount Power Supply

5V 300W 1 Phase / PMR-5V320WD□A

Assembly & Installation

- Ⓐ Side Mounting: Fig. 2 and Fig. 3 show the mounting hole locations for power supply assembly onto a metal mounting surface. The power supply shall be mounted on minimum of 2 mounting holes using M4 screw of maximum 5mm (0.20 inch) length (Refer to Fig. 4). This is to maintain a safety distance between the screw and internal components.
- Ⓑ Base Mounting: Fig. 2 and Fig. 3 show the mounting hole locations for power supply assembly onto a metal mounting surface. The power supply shall be mounted on minimum of 4 mounting holes using M4 screw of maximum 4mm (0.16 inch) length (Refer to Fig. 4). This is to maintain a safety distance between the screw and internal components.
- Ⓒ Connector
- Ⓓ This surface belongs to customer's end system or panel where the power supply is mounted.

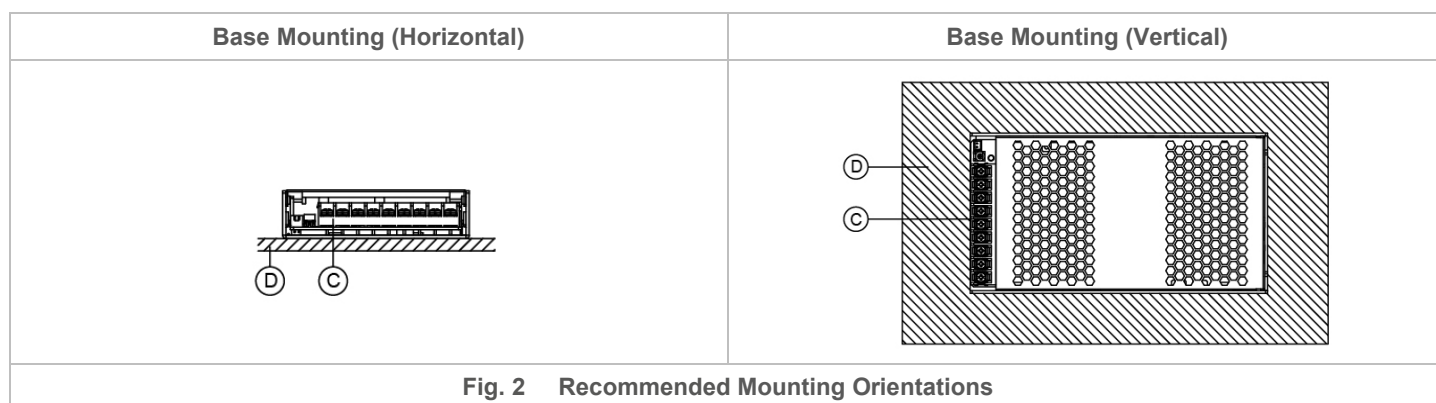

- Use flexible cable (stranded or solid) of AWG No. 14-12. The input/output connectors' allowable current is 23A max per pin. User should calculate and select the suitable wire specification (type/quantity/diameter) according to actual output current. The torque at the connector shall not exceed 13Kgf.cm. The insulation stripping length should not exceed 0.275" or 7mm.
- Recommended mounting torque of the product and its mounting accessories is 9~12Kgf.cm.

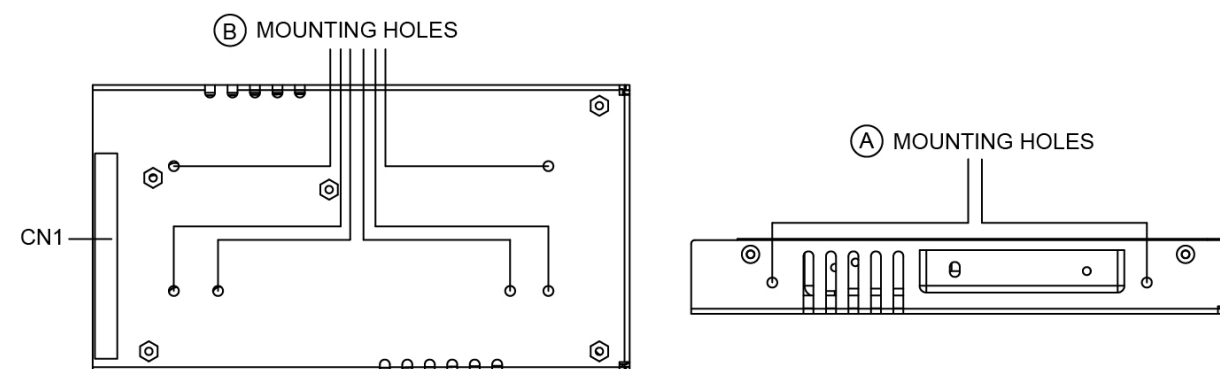

Fig. 3 Mounting Hole Locations

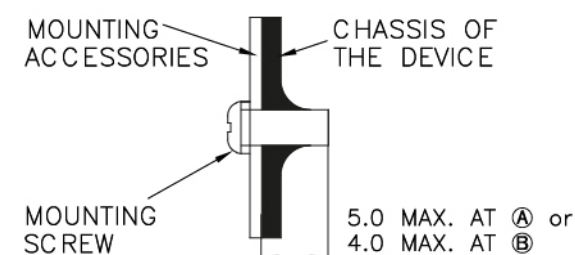

Fig. 4 Assembly Reference

- Only use M4 screw \leq 5mm (0.20 inch) through the base mounting holes at Ⓐ. This is to keep a safe distance between the screw and internal components.
- Only use M4 screws \leq 4mm (0.16 inch) through the base mounting holes at Ⓑ. This is to keep a safe distance between the screw and internal components.

PMR Panel Mount Power Supply

5V 300W 1 Phase / PMR-5V320WD□A

Safety Instructions

- If user's mounting orientation is not according to the recommended mounting orientations, please consult Delta for further information.
- To ensure sufficient convection cooling, always maintain a distance of $\geq 20\text{mm}$ (0.78 inch) from ventilated surfaces while the device is in operation.
- The device is not recommended to be placed on low thermal conductive surface. For example, plastics.
- The enclosure of the device can become very hot depending on the ambient temperature and load of the power supply. Do not touch the device while it is in operation or immediately after power is turned OFF. Risk of burning!
- Do not touch the terminals while power is being supplied. Risk of electric shock.
- Prevent any foreign metal, particles or conductors from entering the device through the openings during installation. It may cause electric shock, safety hazard, fire, and/or product failure.
- Warning: When connecting the device, secure Earth connection before connecting L and N. When disconnecting the device, remove L and N connections before removing the Earth connection. The power supply must be mounted by metal screws onto a grounded metal surface. It is highly recommended that the Earth terminal on the connector be connected to the grounded metal surface.

Accessories

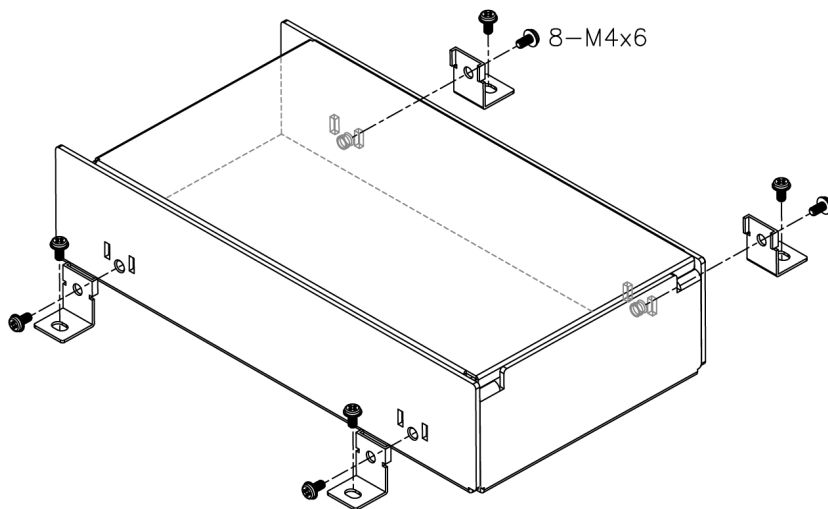

LM-01: Top Fixing Bracket

This bracket is used to fix the power supply onto a flat surface from the top.

PMR Panel Mount Power Supply

5V 300W 1 Phase / PMR-5V320WD□A

Functions

Start-up Time

The time required for the output voltage to reach 90% of its final steady state set value, after the input voltage is applied.

Rise Time

The time required for the output voltage to change from 10% to 90% of its final steady state set value.

Hold-up Time

Time between the collapse of the AC input voltage, and the output falling to 95% of its steady state set value.

■ Graph illustrating the Start-up Time, Rise Time, and Hold-up Time

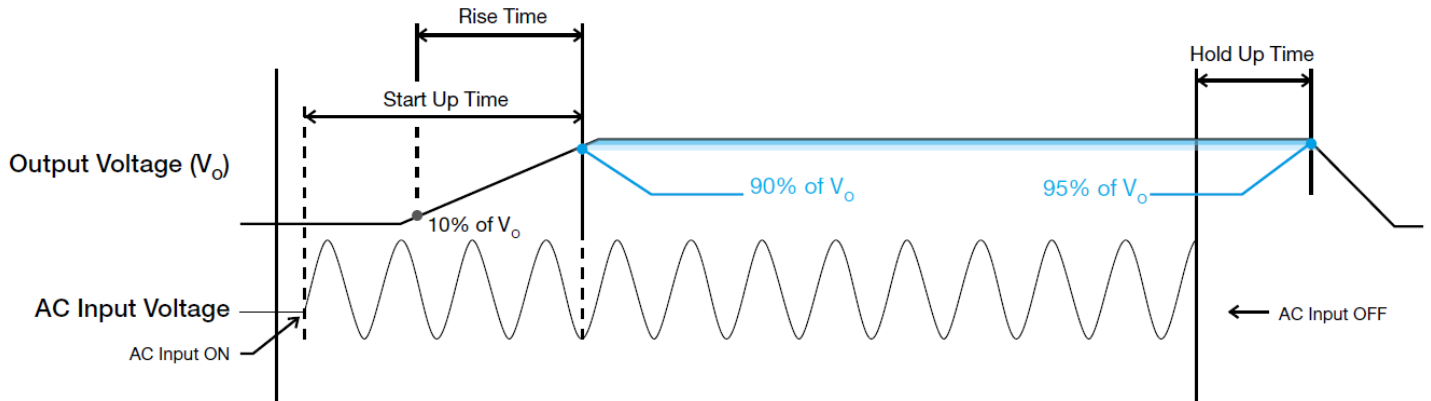

Inrush Current

Inrush current is the peak, instantaneous, input current measured and, occurs when the input voltage is first applied. For AC input voltages, the maximum peak value of inrush current will occur during the first half cycle of the applied AC voltage. This peak value decreases exponentially during subsequent cycles of AC voltage.

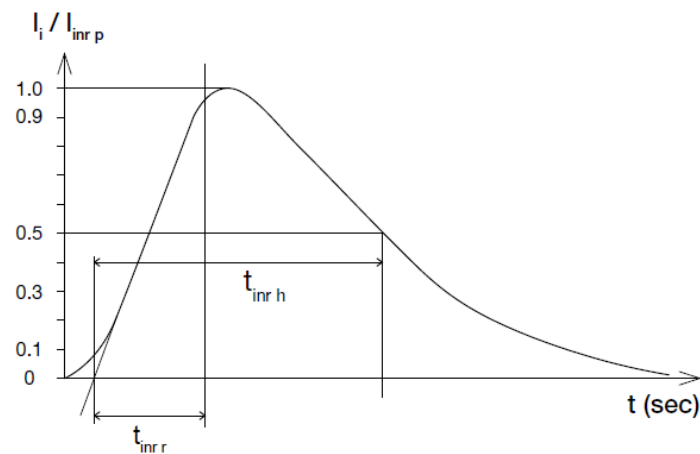

Dynamic Response

The power supply output voltage will remain within $\pm 1500\text{mVpp}$ of its steady state value, when subjected to a dynamic load from 10 to 50% and 50 to 100% of its rated current.

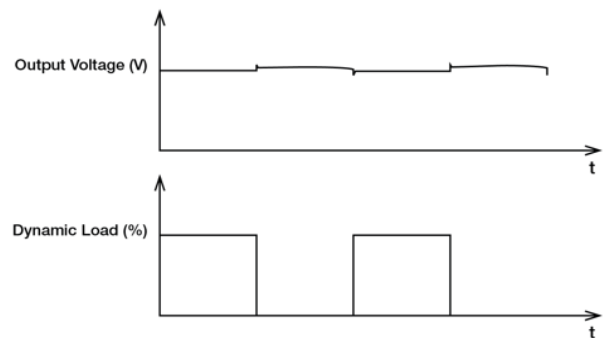

PMR Panel Mount Power Supply

5V 300W 1 Phase / PMR-5V320WD□A

Overload & Overcurrent Protections (Auto-Recovery)

The power supply's Overload (OLP) and Overcurrent (OCP) Protections will be activated when output current exceeds 105-150% of I_o (Max load). In such occurrence, the V_o will start to droop and once the power supply has reached its maximum power limit, the protection is activated and the power supply will go into "Hiccup mode" (Auto-Recovery). The power supply will recover once the fault condition of the OLP and OCP is removed and I_o is back within the specifications.

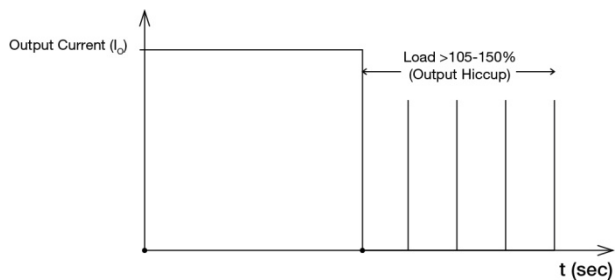

It is not recommended to prolong the duration of I_o when it is <105% but >100%, since it may cause damage to the PSU.

Short Circuit Protection (Auto-Recovery)

The power supply's output OLP/OCP function also provides protection against short circuits. When a short circuit is applied, the output current will operate in "Hiccup mode", as shown in the illustration in the OLP/OCP section on this page. The power supply will return to normal operation after the short circuit is removed.

Overvoltage Protection (Auto-Recovery)

The power supply's overvoltage circuit will be activated when its internal feedback circuit fails. The output voltage shall not exceed its specifications defined on Page 3 under "Protections".

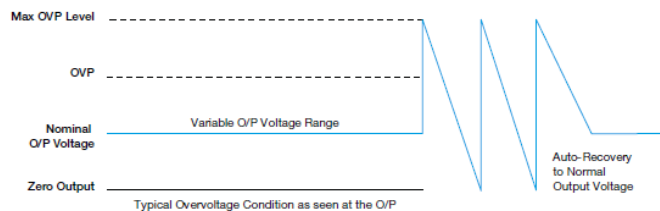

Over Temperature Protection (Auto-Recovery)

As described in load de-rating section, the power supply also has Over Temperature Protection (OTP). In the event of a higher operating temperature at 100% load, the power supply will run into OTP when the operating temperature is beyond what is recommended in the de-rating graph. When activated, the output voltage will go into bouncing mode until the temperature drops to its normal operating temperature as recommended in the de-rating graph.

PMR Panel Mount Power Supply

5V 300W 1 Phase / PMR-5V320WD□A

Others

Delta RoHS Compliant



Restriction of the usage of hazardous substances

The European directive 2011/65/EU limits the maximum impurity level of homogeneous materials such as lead, mercury, cadmium, chrome, polybrominated flame retardants PBB and PBDE for the use in electrical and electronic equipment. RoHS is the abbreviation for “Restriction of the use of certain hazardous substances in electrical and electronic equipment”.

This product conforms to this standard.

Conformal Coating

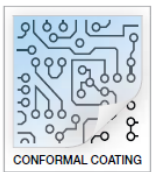

The Protective Coating Technology

Delta Electronics Group has designed the perfect dipping technique which penetrates everywhere including under device, and prevents leakage. The conformal coating dipping can be applied to PCBAs or circuit board. The coating preserves the performance of precision electronic primarily by preventing ionizable contaminants such as salt from reaching circuit nodes, where the material slumps around sharp edges. This can be a problem especially in highly conversing atmosphere.

PFC – Norm EN 61000-3-2



Line Current Harmonic content

Typically, the input current waveform is not sinusoidal due to the periodical peak charging of the input capacitor. In industrial environment, complying with EN 61000-3-2 is only necessary under special conditions. Complying to this standard can have some technical drawbacks, such as lower efficiency as well as some commercial aspects such as higher purchasing costs. Frequently, the user does not profit from fulfilling this standard, therefore, it is important to know whether it is mandatory to meet this standard for a specific application.

Attention

Delta provides all information in the datasheets on an “AS IS” basis and does not offer any kind of warranty through the information for using the product. In the event of any discrepancy between the information in the catalog and datasheets, the datasheets shall prevail (please refer to www.DeltaPSU.com for the latest datasheets information). Delta shall have no liability of indemnification for any claim or action arising from any error for the provided information in the datasheets. Customer shall take its responsibility for evaluation of using the product before placing an order with Delta.

Delta reserves the right to make changes to the information described in the datasheets without notice.