

Medical/Industrial AC-DC Configurable Power Supply

Up to 700 Watt / MEG-700A Series



Highlights & Features

- Up to 700 W in 3.5" x 8.5" x 1.63" Package
- Up to 14.5 W/inch³ Power Density
- Full Power up to 50°C Ambient
- 3 Slots Modules Configurable
- 2xMOPP Isolation for Medical Application
- Output selectable from 2 V to 60 V
- Current sharing for single slot modules
- Class B Conducted and Radiated EMI
- IEC 60601-1-2 4th edition immunity compliance
- Normal and Reversed Option for Global Remote On/Off
- Analog Voltage Trimming

Safety Certifications

- IEC60601-1 2nd edition
- IEC60601-1 3rd edition + A1 CB report
- TUV EN60601-1:2006/A11/A12
- ANSI/AAMI ES 60601-1+CAN/CSA-C22.2 NO.60601-1: (Ed.3.2005)
- IEC60950-1 CB report
- IEC62368-1 CB report
- TUV EN62368-1
- UL62368-1 and CAN/CSA C22.2 No. 62368-1
- GB4943.1-2011, GB9254-2008, GB17625.1-2012

Input			
Input Voltage	90 VAC ~ 264 VAC		
Input Frequency	47 Hz ~ 63 Hz		
Input Current	<8.5 A		
Inrush Current	<40 A		
Power Factor	>0.95 @ rated load		
Efficiency	Up to 93% ¹⁾		
Patient Leakage Current	<100 uA normal, <500 uA SFC		
Earth Leakage Current	<300 uA normal, <1 mA SFC		
Output Module			
Output Number	Single Output		Dual Output
Consuming Slots	Single Slot	Triple Slot	Single Slot
Output Voltage	2 V ~ 60 V	8 V ~ 60 V	3.3 V ~ 30 V
Output Power	300 W Max	700 W Max	180 W Max
Ripple & Noise	<1% Vrated pk-pk or 100 mV, which is larger		
Standby Power	5 V / 2 A (No minimum load required)		
Environmental			
MTBF	500KHrs		
Operation Temperature	-20°C ~ 70°C ²⁾		
Operation Altitude	5000 m or 50 kPa		

1) Exclude fan power with module assembled, efficiency may vary for different configurations

2) Power de-rating with temperature above 50°C, refer to power de-rating curve for detail

Medical/Industrial AC-DC Configurable Power Supply

Up to 700 Watt / MEG-700A Series

Model Numbering

MEG	-	700		A		3		X	-	Y-Y-Y	-	ZZZZZ
ME: Delta Medical Power Supply G: Configurable		Max Wattage in Product Series 700: 700W		Family Code A series		Slot Number 3: 3 Slots		Inlet Type T: US Terminal E: EU Terminal C: C14		Output Configurations See below		PSU Configuration See below

Output Configurations:

Y-Y-Y
Output Configurations
See below

For single output **module**, output module code combined with a voltage code and a current code.

For dual output module, output module code is combined with two voltage code.

Please check Table 1 for all available combinations.

For example:

J1: 12 V, 25 A, single slot, single output module.

O2: 24 V, 50 A, triple slot, single output module.

OJ: Dual output module, one 24 V/4 A output, one 12 V/5 A output.

Split the modules with a "-".

If any slot to be left empty, use code "NU".

Medical/Industrial AC-DC Configurable Power Supply

Up to 700 Watt / MEG-700A Series

Output Modules:

Table 1. Output Modules

Voltage Code		Current Code					
		Single Slot Module		Triple Slot Module		Single Slot Dual Output Module	
		1		2			
Code	Voltage	Current	Power (max)	Current	Power (max)	V1 or V2 Current	V1 or V2 Power (max)
A	2.0 V	45.0 A	90 W	-	-	-	-
B	2.4 V	45.0 A	108 W	-	-	-	-
C	3.0 V	45.0 A	135 W	-	-	-	-
D	3.3 V	45.0 A	149 W	-	-	5.0 A	16.5 W
E	5.0 V	45.0 A	225 W	-	-	5.0 A	25 W
F	5.5 V	45.0 A	248 W	-	-	5.0 A	27.5 W
G	6.0 V	42.0 A	252 W	-	-	5.0 A	30 W
H	8.0 V	25.0 A	200 W	78.7 A	630 W	5.0 A	40 W
I	10.0 V	25.0 A	250 W	70.0 A	700 W	5.0 A	50 W
J	12.0 V	25.0 A	300 W	58.3 A	700 W	5.0 A	60 W
K	14.0 V	21.4 A	300 W	50.0 A	700 W	5.0 A	70 W
L	15.0 V	20.0 A	300 W	46.7 A	700 W	5.0 A	75 W
M	18.0 V	16.7 A	300 W	38.9 A	700 W	5.0 A	90 W
N	20.0 V	15.0 A	300 W	35.0 A	700 W	4.5 A	90 W
O	24.0 V	12.5 A	300 W	29.2 A	700 W	3.7 A	90 W
P	28.0 V	10.7 A	300 W	25.0 A	700 W	3.2 A	90 W
Q	30.0 V	10.0 A	300 W	23.3 A	700 W	3.0 A	90 W
R	32.0 V	9.4 A	300 W	21.9 A	700 W	-	-
S	36.0 V	8.3 A	300 W	19.4 A	700 W	-	-
T	42.0 V	7.1 A	300 W	16.7 A	700 W	-	-
U	48.0 V	6.3 A	300 W	14.6 A	700 W	-	-
V	54.0 V	5.5 A	300 W	13.0 A	700 W	-	-
W	60.0 V	5.0 A	300 W	11.7 A	700 W	-	-

Note: for Triple slot module series, the module's max output power can be up to 1200 W peak, constant operation power will be limited with 700 W power by the frame.

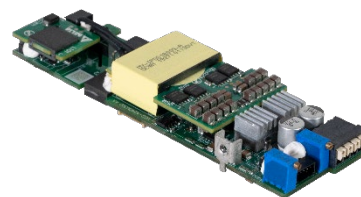
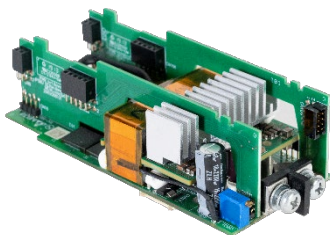

Medical/Industrial AC-DC Configurable Power Supply

Up to 700 Watt / MEG-700A Series

PSU Configurations:

Use following definition for PSU configurations

Z	Z	Z	ZZ
Parallel Code	Control Code	Communication Code	CC code
See Table 2	0: Normal Logic & Normal Fan Direction 1: Reversed Logic & Normal Fan Direction	0: Default N/A	Use AA for default

Parallel Code:

Parallel feature is available for the same output modules. Select parallel code, Delta will parallel the outputs before shipping to customer. Parallel feature is designed for single slot modules and only two modules can be paralleled. Triple slot modules and dual output module cannot support this option.

Table 2 Parallel Code

Code	1	2	3
0	No Parallel		
A			
B			

Examples:

MEG-700A3T J1-J1-O1 A00AA

3 Slots, US Terminal type input, two 12 V modules in parallel, one 24 V module

Medical/Industrial AC-DC Configurable Power Supply

Up to 700 Watt / MEG-700A Series

Specifications

Input Ratings / Characteristics

Nominal Input Voltage	100-240 Vac
Input Voltage Range	90-264 Vac
Nominal Input Frequency	50-60 Hz
Input Frequency Range	47-63 Hz
Input Current (max)	8.5 A
Input Surge Voltage (max)	300 Vac for 100 ms
Full load Efficiency (typ.)	91% @ 115 Vac/60 Hz 93% @ 230 Vac/50 Hz
Inrush Current (max)	40 A @ 230 Vac, cold start
Power Factor (min)	>0.95 @ 115 V/50 Hz, 230 V/50 Hz, full load

Output Ratings / Characteristics

Total Regulation	±3%
Output Power	Up to 300 W per single slot module, 700 W per triple slot module
Output Voltage Trimming range	±10% of module rated output voltage
Line Regulation (max)	±0.5%
Load Regulation (max)	±1%
Ripple & Noise (typ.)	1% pk-pk V_{rated} or 100mV, which is greater
Start-up Time (max)	3000 ms @ 115 Vac
Hold-up Time (min)	12 ms @ rated load, with nominal input range 400 W @200 Vac/240 Vac for SEMI F47
Dynamic Response (Overshoot & Undershoot O/P Voltage)	±5% @ with 50-100% load change
Capacitive load (max)	Single Slot Single Output Module: 1500 uF on each load Triple Slot Single Output Module: 2800 uF on each load Single Slot Dual Output Module: 1000 uF on each load
Rise time (max)	100 ms
Remote Sense	Up to 500 mV compensation for voltage drop across external wire connections to load. Short and reverse connection protected.
Inhibit	Default ON, see detail in description
Power Good	Open collector signal when output is in regulation. See application note for detail

Medical/Industrial AC-DC Configurable Power Supply

Up to 700 Watt / MEG-700A Series

Global Control

DC OK	Open collector signal. Pulled high when all output is in regulation.
Global Inhibit	Default ON, see detail in description

Standby Ratings / Characteristics

Nominal Output Voltage of standby output	5 V
Nominal Output Current of standby output	2.0 A
Total Regulation of standby output	±3%
Ripple & Noise of standby output	100 mV max (Refer to Fig. 1)

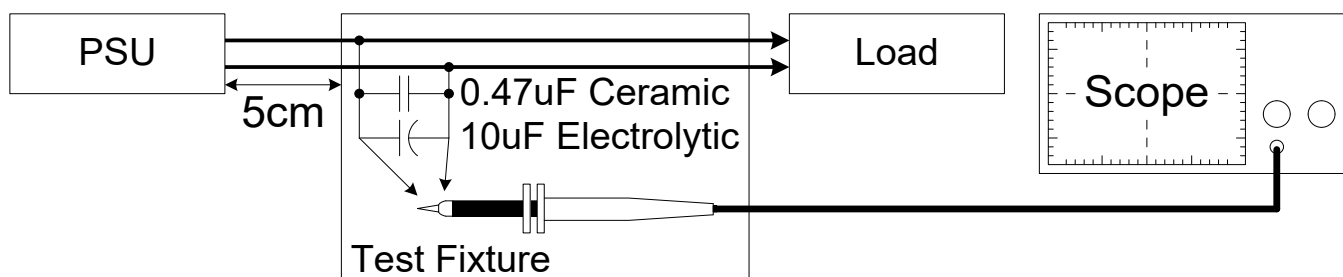

Figure 1. Ripple & Noise Measurement Circuit

Mechanical

Case Material	SGCC
Dimensions (W x L x H)	3.5" x 8.5" x 1.63" (88.9 x 215.9 x 41.5mm)
Unit Weight	0.8 kg(1.76 lb)

Environment

Surrounding Air Temperature	Operating	Absolute Maximum/Minimum Rating. -20°C to +70°C. Power derating linearly to 50% power under 70°C
	Storage	-40°C to +85°C
Operating Humidity		5-95% RH (Non-Condensing)
Operating Altitude		Up to 5,000 meters (up to 16,400 feet or 106-54kPa)
Non-Operating Altitude		Up to 5,575 meters (up to 18,290 feet or 106-50kPa)
Shock Test	Non-Operating	50 G, 11 ms, 3 shocks for each direction
Vibration	Non-Operating	5-500 Hz, 2 Grms, 15 minutes for each three axis

Medical/Industrial AC-DC Configurable Power Supply

Up to 700 Watt / MEG-700A Series

Protections

Overvoltage	Latch off. Reset by recycling AC		
	Min	Nom	Max
	110%	117%	130%
Overload / Overcurrent	Hiccup Mode (Non-Latching, Auto-Recovery)		
	Min	Nom (default)	Max
	110%	115%	130%
The max over load is limited to 950W with 5 seconds time delay for triple slot modules.			
Over Temperature	Latch off		
Short Circuit	Hiccup Mode (Non-Latching, Auto-Recovery)		

Reliability Data

MTBF (Minimum) at 160Vac, 35°C	>500 kHrs based on Telecordia SR-332
--------------------------------	--------------------------------------

Safety Standards / Directives

Medical Safety	IEC60601-1 2 nd and 3 rd +A1 edition CB report TUV EN60601-1:2006 ANSI/AAMI ES 60601-1+CAN/CSA-C22.2 No.60601-1: (Ed.3.2005)	
ITE Safety	IEC60950-1 CB report IEC62368-1 CB report TUV EN 62368-1 UL 62368-1 and CAN/CSA C22.2 No. 62368-1 GB4943.1-2011, GB9254-2008, GB17625.1-2012	
CE	MDD Directive 93/42/EEC	
Galvanic Isolation	Input to Output (2xMOPP)	4000 Vac
	Input to Ground (1xMOPP)	1768 Vac
	Output to Ground	500 Vac (Type B application rated)
	Output to Output	500 Vac

Medical/Industrial AC-DC Configurable Power Supply

Up to 700 Watt / MEG-700A Series

EMC

EMC / Emissions		EN55011/EN55032, FCC Title 47:Class B
Harmonic Current Emissions	IEC61000-3-2	Meet Class A limit
Immunity to		
Voltage Flicker	IEC61000-3-3	
Electrostatic Discharge	IEC61000-4-2	Level 4 Criteria A ¹⁾⁵⁾ Air Discharge: 15 kV Contact Discharge: 8 kV
Radiated Field	IEC61000-4-3	Level 3 Criteria A ¹⁾ 80 MHz-1000 MHz, 10 V/m AM modulation
	IEC60601-1-2	Criteria A ¹⁾⁵⁾ 80 MHz-2700 MHz, 10 V/m AM modulation 385 MHz-5785 MHz, 28 V/m Pulse mode and other modulation
Electrical Fast Transient / Burst	IEC61000-4-4	Level 3 Criteria A ¹⁾ :2 kV
Surge	IEC61000-4-5	Level 3 Criteria A ¹⁾⁵⁾ Common Mode ³⁾ : 2 kV Differential Mode ⁴⁾ : 1 kV
Conducted	IEC61000-4-6	Level 2 Criteria A ¹⁾⁵⁾ 150 kHz-80 MHz, 3 Vrms, 6 Vrms at ISM bands and Amateur radio bands
Power Frequency Magnetic Fields	IEC61000-4-8	Criteria A ¹⁾⁵⁾ Magnetic field strength 30 A/m
Voltage Dips	IEC61000-4-11	30% 10 ms Criteria A ¹⁾ 60% 100 ms Criteria B ²⁾ 100% 5000 ms Criteria B ²⁾
Voltage Dips ⁵⁾		Criteria A ¹⁾ @ rated full load 0% U _T , 0.5 cycle(10 ms) (0°,45°,90°,135°,180°,225°,270°,315°,360°) Criteria B ²⁾ , can meet Criteria A with 400 W or lower load 0% U _T ,1 cycle (20 ms), 0° Criteria B ²⁾ 70% U _T ,25 cycle (500 ms), 0° Criteria B ²⁾ 0% U _T ,250 cycle (5000 ms), 0°

1) Criteria A: Normal performance within the specification limits

2) Criteria B: Output out of regulation, or shuts down during test. Automatically restored to normal operation after test.

3) Asymmetrical: Common mode (Line to earth)

4) Symmetrical: Differential mode (Line to line)

5) Compliant with IEC-60601-1-2 4th edition requirements.

Medical/Industrial AC-DC Configurable Power Supply

Up to 700 Watt / MEG-700A Series

MEG Series Mechanical Outlines

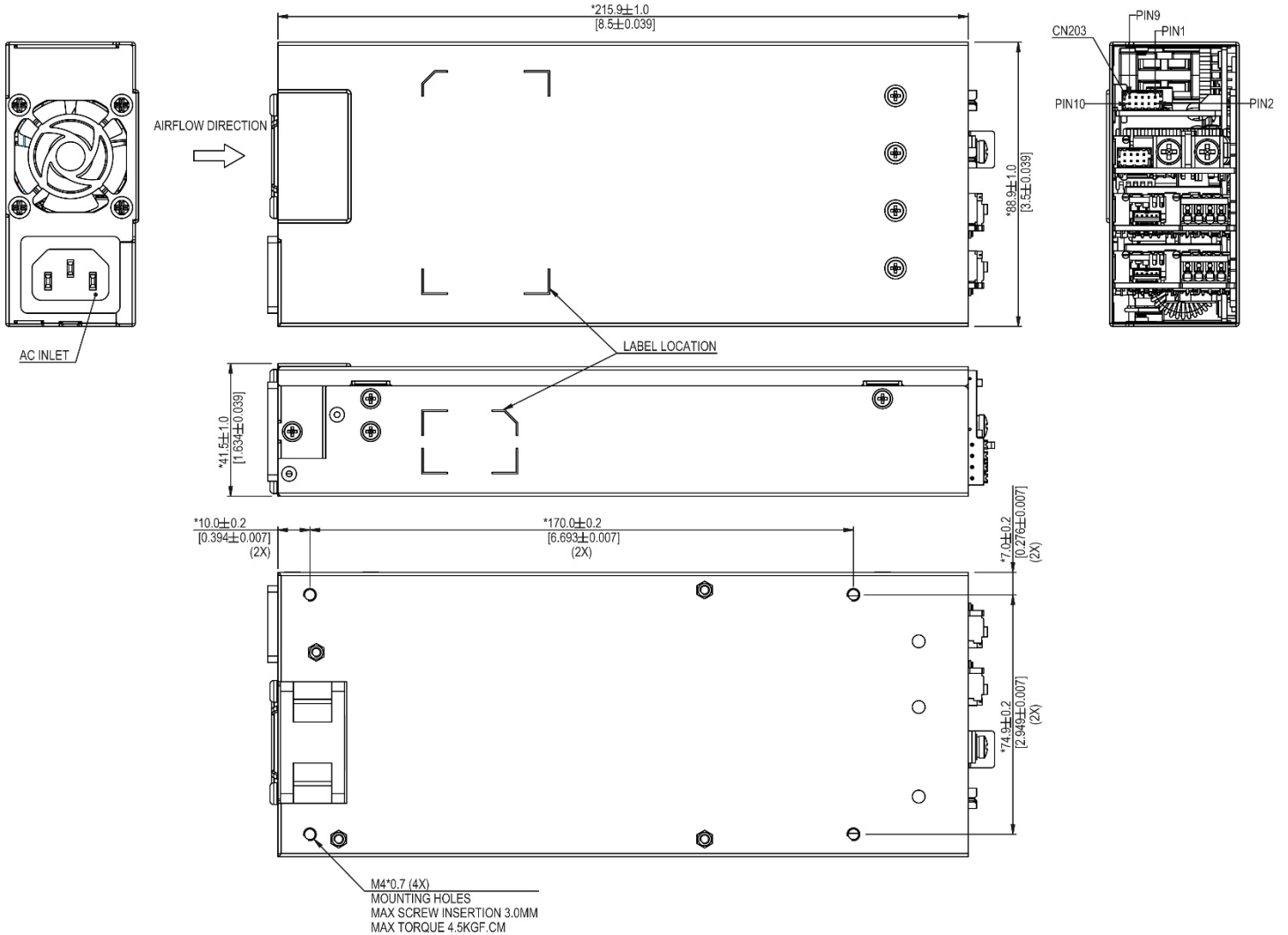

- Note:**
- Output Module Connectors: All single O/P modules are M4 x 8 mm screws, tighten between 7.0 to 10.0 kgf.cm (6.08 to 8.68 lbf.in); Dual O/P module is PUSH IN conductor connector; Wire Strip Length: 0.315" - 0.354" (8.0 - 9.0 mm).
 - Case Material: SGCC (conductive).
 - Customer Mounting: Screw M4-type mounting holes; Max. Penetration is 3.0 mm (0.118"); Max. Torque: 4.5 kgf.cm (3.91 lbf.in)
 - Adjustable VR clockwise is to increase the output voltage.
 - All dimensions are in millimeters and inches.

Medical/Industrial AC-DC Configurable Power Supply

Up to 700 Watt / MEG-700A Series

AC Inlet Type Option

“C” TYPE

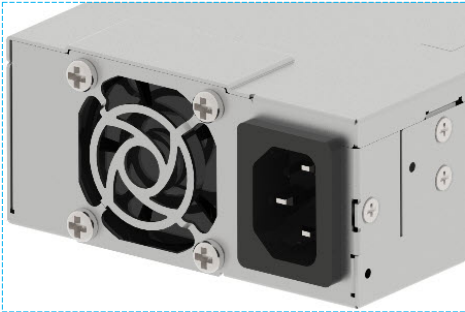

Figure 4. IEC320-C14
CONDUCTOR SIZE: 14 AWG Max.

“E” TYPE



Figure 5. European Terminal Block
TIGHTENING TORQUE:2.4 Lbf.in

“T” TYPE

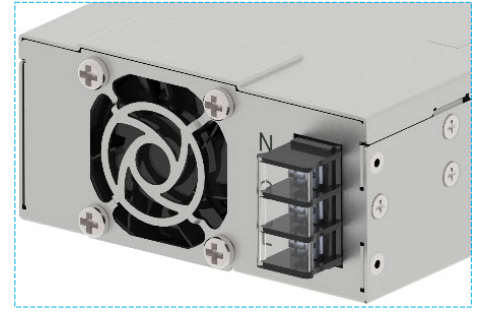
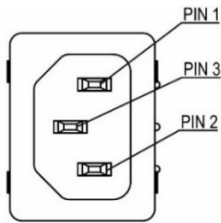
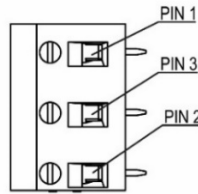

Figure 6. American Barrier Strip
CONDUCTOR SIZE: 14 AWG Max.
TIGHTENING TORQUE:8kgf.cm

Connector Definitions – Frame



IEC Connector
(IEC320-C14)



European
Terminal Block

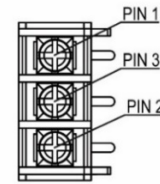

American
Barrier Strip

Figure 8. AC Input Connector

Pin	Function
PIN 1	AC Neutral
PIN 2	AC Line (Phase)
PIN 3	Chassis(Earth) Ground

Table 3. AC Input Connector - pin assignment

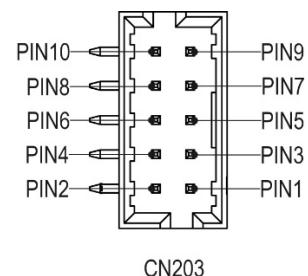
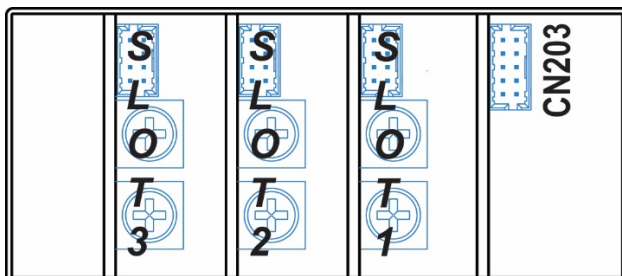

Figure 9. Global Control Signals

Medical/Industrial AC-DC Configurable Power Supply

Up to 700 Watt / MEG-700A Series

Global control signals CN203 (Molex:87833-1031) Mating With Molex:51110-1051 or equivalent Terminal: 0503948052	
Pin	Function
1	Global DC_OK+
2	Global DC_OK-
3	5V+
4	5V+
5	GROUND
6	GROUND
7	Global Inhibit +
8	Global Inhibit -
9	No Connection
10	No Connection

Table 4. Global Control Signals (CN203) – Pin assignment

Medical/Industrial AC-DC Configurable Power Supply

Up to 700 Watt / MEG-700A Series

Connector Definitions – Single Slot Single Output Module

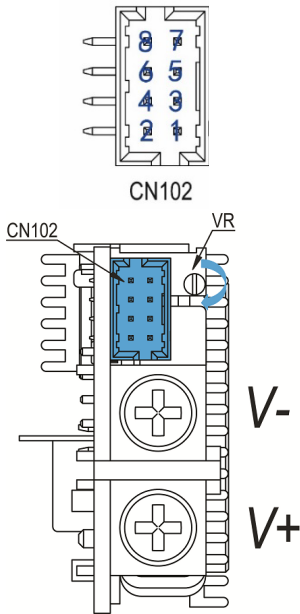

Figure 10. -x1 Module Connector

Pin	Function
V+	Output
V-	Output Return

Wire range: 8-20 AWG
Screw torque: 7.0 to 10.0 kgf.cm (6.08 to 8.68 lbf.in)
Screws are suitable for slotted and Phillips head screwdrivers.

Table 5. DC output port - pin assignment

Control Connector CN102 (Molex: 87833-0851) Mating With Molex: 51110-0851 or equivalent , Terminal: 0503948052	
Pin	Function
1	Remote On_Off/Inhibit +
2	Remote On_Off/Inhibit -
3	Remote Sense +
4	Remote Sense -
5	Power Good- "Collector"
6	Power Good- "Emitter"
7	Current Share
8	Reserve/No Connection

Table 6. Control Signals Connector - pin assignment

Connector Definitions – Triple Slot Single Output Module

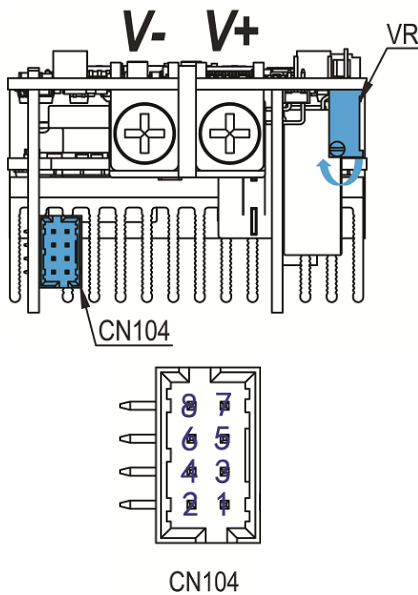

Figure 11. -x2 Module Connector

Pin	Function
V+	Output
V-	Output Return

Wire range: 2-16 AWG
Screw torque: 15.0 to 20.0 kgf.cm (13.02 to 17.36 lbf.in)
Screws are suitable for slotted and Phillips head screwdrivers.

Table 7. DC output port - pin assignment

Control Connector CN104 (Molex: 87833-0851) Mating With Molex: 51110-0851 or equivalent Terminal: 0503948052	
Pin	Function
1	Remote On_Off/Inhibit +
2	Remote On_Off/Inhibit -
3	Remote Sense +
4	Remote Sense -
5	Power Good- "Collector"
6	Power Good- "Emitter"
7	Current Share
8	Reserve/No Connection

Table 8. Control Signals Connector - pin assignment

Medical/Industrial AC-DC Configurable Power Supply

Up to 700 Watt / MEG-700A Series

Connector Definitions – Single Slot Dual Output Module

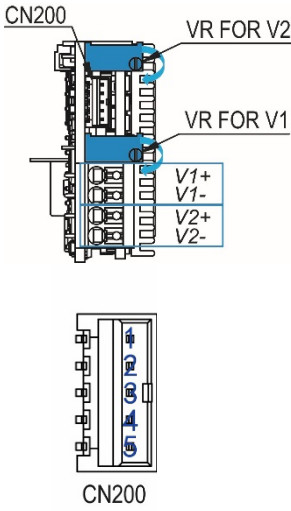

Figure 12. -x3 Module Connector

Pin	Function
V1+	V1 Output
V1-	V1 Output Return
V2+	V2 Output
V2-	V2 Output Return
Wire range: 28-16 AWG	

Table 9. DC output port - pin assignment

Control Connector CN200 (Molex: 87438-0563) Mating With Molex: 87439-0500 Terminal: 874210102	
Pin	Function
1	Remote Inhibit 2 +
2	Remote Inhibit 2 -
3	NC
4	Remote Inhibit 1 +
5	Remote Inhibit 1 -

Table 10. Control Signals Connector - pin assignment

Functions

Start-up Time

The time required for the output voltage to reach 90% of its final steady state value, after the input voltage is applied.

Rise Time

The time required for the output voltage to change from 10% to 90% of its final steady state value.

Hold-up Time

Time between the collapse of the AC input voltage, and the output falling to 90% of its steady state value.

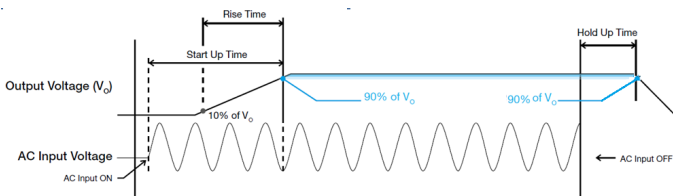

Figure 13. Time Sequence

Dynamic Response

The power supply output voltage will remain within $\pm 5\%$ of its steady state value, when subjected to a dynamic load 50 to 100% of its rated current.

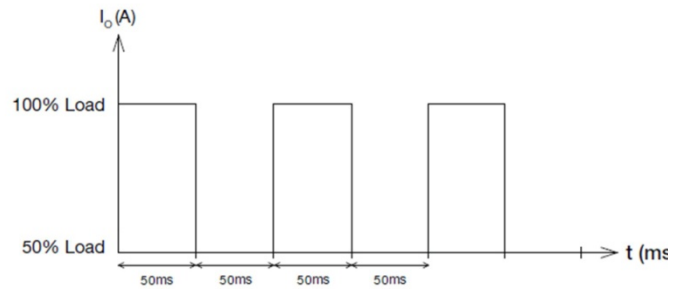

Figure 14. Dynamic from 50% load to 100% Load

Medical/Industrial AC-DC Configurable Power Supply

Up to 700 Watt / MEG-700A Series

Inrush Current

Inrush current is the input current that occurs when the input voltage is first applied. For AC input voltages, the maximum peak value of inrush current will occur during the first half cycle of the applied AC voltage. This peak value decreases exponentially during subsequent cycles of AC voltage.

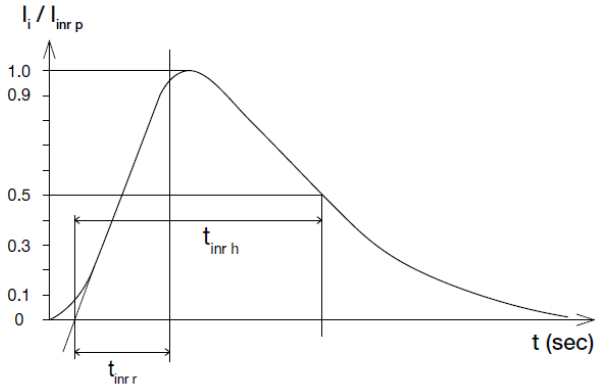

Figure 15. Inrush Current

Overvoltage Protection

The power supply's overvoltage circuit will be activated when its internal feedback circuit fails. The output voltage shall not exceed its specifications defined on Page 9 under "Protections". Power supply will latch off, and require removal/re-application of input AC voltage in order to restart.

Overload & Overcurrent Protections

Each output will enter auto-recovery mode when the output current reaches over current protection set point. The output can hold to 950W typical for 5 second before tripping protection. The power supply will recover once the fault condition causing the OLP and OCP is removed and I_o is back within the specified limit. The time interval between each auto re-start during protection is 4s typical.

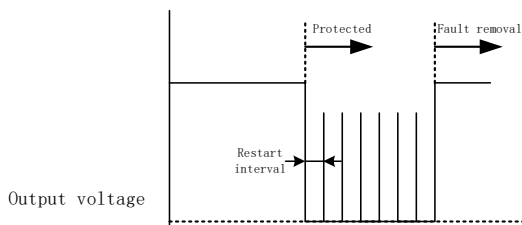

Figure 16. Auto-Recovery

Short Circuit Protection

The power supply's output OLP/OCP function also provides protection against short circuits. When a short circuit is applied, the output current will operate in "Hiccup mode", as shown in the illustration in the OLP/OCP section on this page. The power supply will return to normal operation after the short circuit is removed.

Over Temperature Protection

Each output module and PFC module sense each module operation temperature. Any output module temperature is higher than the over temperature protection set point, all the modules will be shut down latched.

An AC recycle is required to reset the power supply to normal operation.

Remote Sense

Remote sense feature can be used to compensate for the extra voltage drop on output wires that are connected from the main output terminals, to the load. With wires connected from the remote sense pins, at the same locations as the wires from the main output, the remote sense function can compensate up to 500mV voltage drop. If the remote sense pins are shorted, or if a reverse/inverted polarity connection is made, the output module will be turned off.

Remote On_Off/Inhibit

The remote control signal can be used to enable or disable only the main output. When the main output is disabled, the +5V Standby output will continue to operate. Every module has its own remote on/on control signal pin, and can work independently from each other. Below is a suggested connection, system can use a switch to conduct through this diode (suggested pull up resistor to 5V standby with 1Kohm resistor) to disable the main out. The signal can be floated (no connection to the signal), in order to enable the main output.

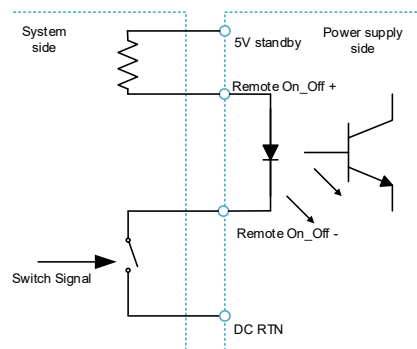

Figure 17. Remote On_Off connection

Medical/Industrial AC-DC Configurable Power Supply

Up to 700 Watt / MEG-700A Series

Global Remote On_Off/Inhibit

The global inhibit function will turn on/off all the output modules. The control logic is selectable on demand. In normal logic, the module is default on with the control logic described in Figure 17. The module outputs will be turned off if the diode is conducted and modules will be on if diode is left floated or open.

Power Good Signal

Power Good+/- pin on every module's control connector is an isolated open collector transistor (80V/50mA rating). A resistor (suggested value 10Kohm, 1/8W) can be added between Power Good- pin and DC RTN, Power Good+ pin can be connected to 5V standby (or, other available pull-up voltage that is no greater than the transistor rating). Value of resistor may have to be adjusted, depending on voltage used, and other end-use conditions of the Power Good+ pin connection to the product. When DC output is presented, Power Good Signal (Shown in below figure) generated will be high. When DC output is off, Power Good Signal generated will be low. There will be a minimum of 5 milliseconds between the time the Power Good Signal goes to low level, and the time when the output reaches 90% of its rated value.

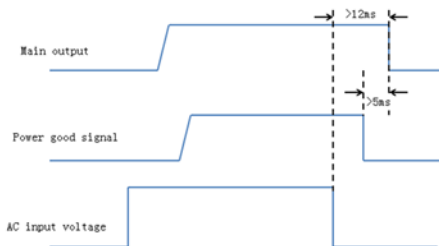

Figure 19. Power good signal sequence

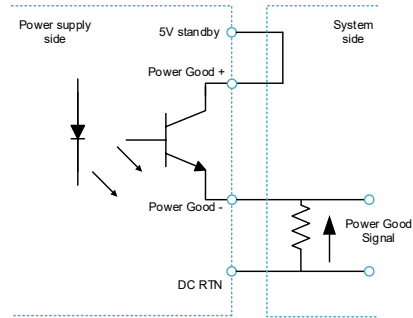

Figure 18. Power good signal connection

Global DC_OK

Global DC_OK indicate the module output information. DC_OK pin is an open collector type output (80V/50mA rating). DC_OK signal connection can refer to power good signal. When all module outputs are on, DC_OK pin will be high. When one of the outputs is off, DC_OK pin will be pulled low .

Medical/Industrial AC-DC Configurable Power Supply

Up to 700 Watt / MEG-700A Series

Power Derating – MEG-700A Series

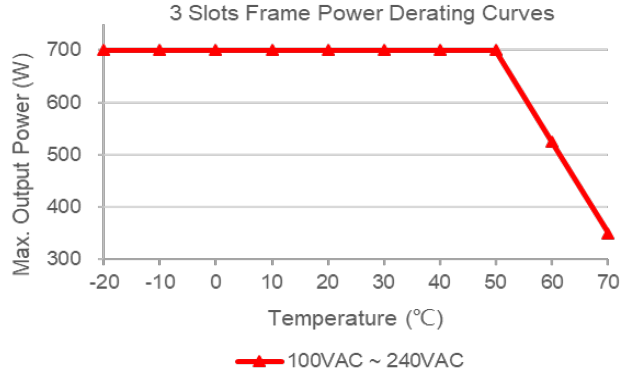

Power Derating – Triple Slot Modules

No air flow direction power derating unless specifically identified.

8V Module Max. Output Power Derating Curves

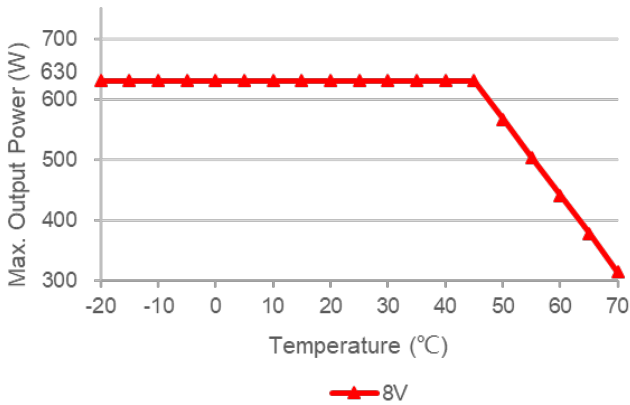

12V Module Max. Output Power Derating Curves

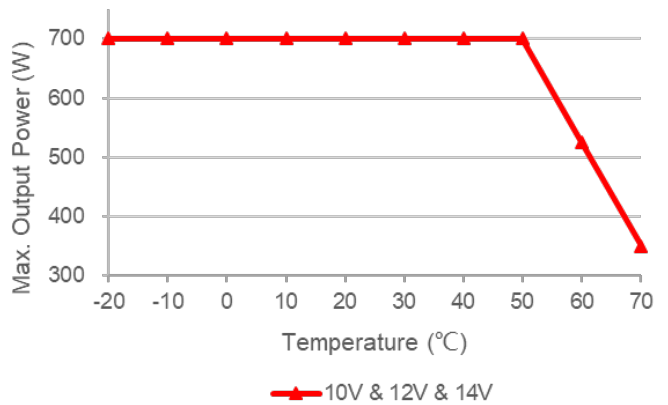

18V Module Max. Output Power Derating Curves

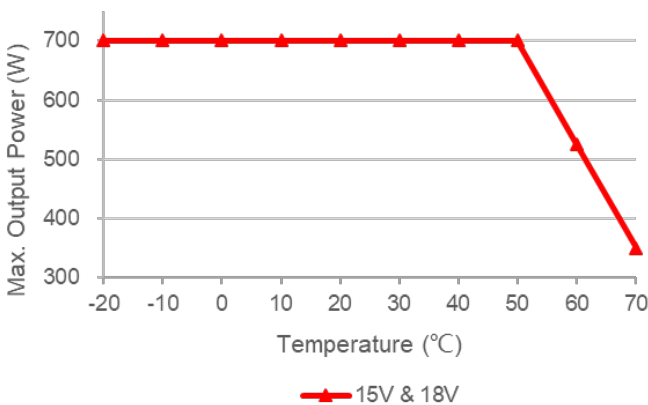

24V Module Max. Output Power Derating Curves

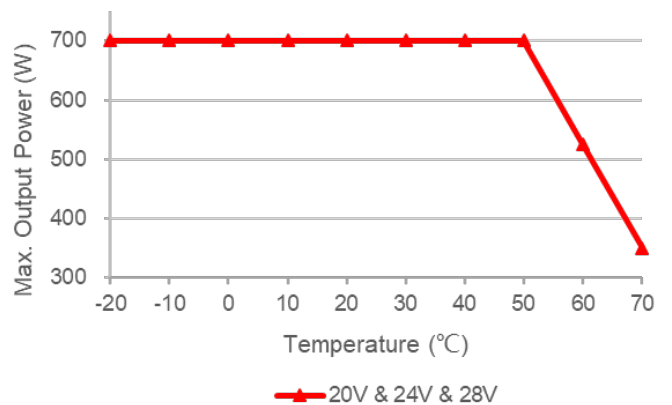

Medical/Industrial AC-DC Configurable Power Supply

Up to 700 Watt / MEG-700A Series

36V Module Max. Output Power Derating Curves

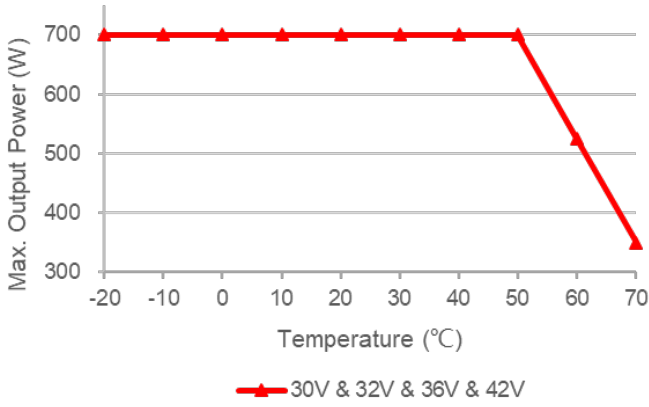

48V Module Max. Output Power Derating Curves

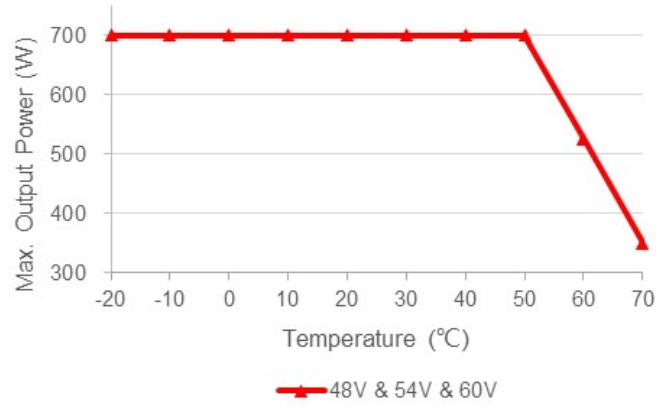

Power Derating – Single Slot Modules & Dual Output Modules

Max. Output Power Derating Curves

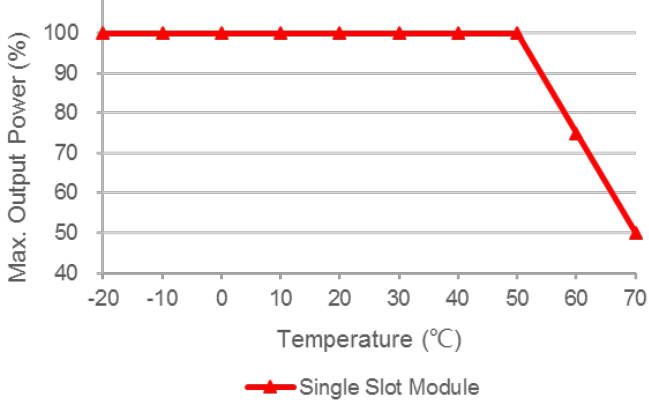

Max. Output Power Derating Curves

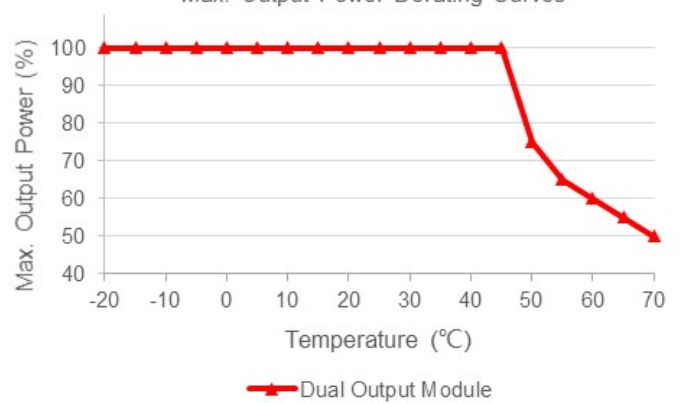

Medical/Industrial AC-DC Configurable Power Supply

Up to 700 Watt / MEG-700A Series

Certificate



Delta has been certified as meeting the requirement of ISO 13485: 2003 and EN ISO 13485:2012 for the design and manufacture of switching power supply and adaptor for medical device.



In addition to a UL Total Certification Program (TCP) approved client laboratory for IEC 60950 and IEC 60065. Delta also has participated UL Client Test Data Program (CDTP) for IEC 60601

Attention

Delta provides all information in the datasheets on an "AS IS" basis and does not offer any kind of warranty through the information for using the product. In the event of any discrepancy between the information in the catalog and datasheets, the datasheets shall prevail (please refer to www.DeltaPSU.com for the latest datasheets information). Delta shall have no liability of indemnification for any claim or action arising from any error for the provided information in the datasheets. Customer shall take its responsibility for evaluation of using the product before placing an order with Delta.

Delta reserves the right to make changes to the information described in the datasheets without notice.