

MDS Medical AC-DC Adapter

12 Volt, 60 Watt / MDS-060AAS12 B



060AAS12 B



Highlights & Features

- Meet DOE Level V
- Safety Approvals to IEC 60601-1 3.1rd ed. & IEC 62368-1
- Compliant with IEC 60601-1-2 4th Ed. Requirements
- Low touch current (<0.1 mA Normal & <0.3 mA single fault)
- Over-Voltage/Load/Temperature & Short Circuit protections
- 1 Million Hours MTBF
- 2 × MOPP isolation
- 3 years warranty

Safety Standards



CB Certified for worldwide use

Model Number:	MDS-060AAS12 B
Unit Weight:	360 grams (12.7 ounces)
Dimensions (W x L x H):	62.0 x 135.0 x 34.1 mm 2.4 x 5.3 x 1.3 in

General Description

The MDS series of external power supply come with universal AC input at 90 Vac to 275 Vac. Other features include low earth leakage, risk management report available and the electric shock protection comply with 2 × MOPP. The MDS series is certified for EMC standards according to EN/BS EN 55011 for industrial, scientific and medical (ISM) radio-frequency equipment and EN/BS EN 55032 for Information Technology Equipment (ITE) radio-frequency equipment. In addition, only recognized Japanese capacitors are used.

The MDS series come with both medical and ITE safety approvals including UL/cUL/CCC/CE and CB certification and are fully compliant with RoHS Directive for environmental protection.

Model Information

Medical AC-DC Adapter

Model Number	Input Voltage Range	Output Voltage	Output Current
MDS-060AAS12 B	90-275 Vac	12 Vdc	5 A

Model Numbering

MDS	-	060	AAS	12	B
Delta Medical power Supply		Max wattage in the product series. Maybe lower at some voltage. 060 → 60 W	Family Code	Output Voltage Single Output: 12 for 12 V	



MDS Medical AC-DC Adapter

12 Volt, 60 Watt / MDS-060AAS12 B

Specifications

Input Ratings / Characteristics

Nominal Input Voltage	100-250 Vac
Input Voltage Range	90-275 Vac
Nominal Input Frequency	50-60 Hz
Input Frequency Range	47-63 Hz
Input Current (max)	1.5 A @ 115 Vac, 0.75 A @ 230Vac
Efficiency (typ.)	87%, Reference Fig.1
Average Efficiency (min)	87% @ 115 Vac
Standby Power (max)	0.5 W @ 115 Vac
Inrush Current (typ.)	50 A @ 115 Vac, 100 A @ 230 Vac
Touch Current (max)	0.1 mA @ 275 Vac NC ¹⁾ , 0.3 mA @ 275 Vac SFC ²⁾
Earth Leakage Current (max)	0.1 mA @ 275 Vac NC ¹⁾ , 0.3 mA @ 275 Vac SFC ²⁾

1) NC: normal condition

2) SFC: single fault condition

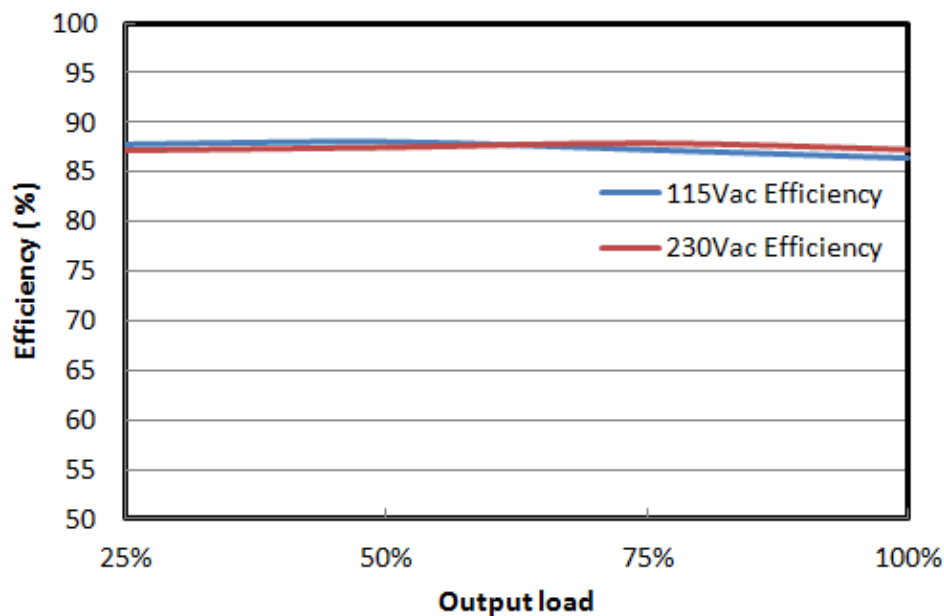

Fig.1 Efficiency versus output load

Output Ratings / Characteristics

Nominal Output Voltage	12 Vdc
Total regulation	± 5%
Output Current	5 A
Output Power	60 W
Line Regulation (max)	± 0.5%
Load Regulation (max)	± 4.5%
Ripple & Noise (typ.)	67 mV pk-pk @ Full load, Reference Fig. 2
Start-up Time (max)	3000 ms @ 115 Vac
Hold-up Time (min)	10 ms @ 115 Vac
Dynamic Response (Overshoot & Undershoot O/P Voltage)	± 5% @ 50-100% load
Capacitive load (max)	3300 uF

*Periodic and Random Deviation



MDS Medical AC-DC Adapter

12 Volt, 60 Watt / MDS-060AAS12 B

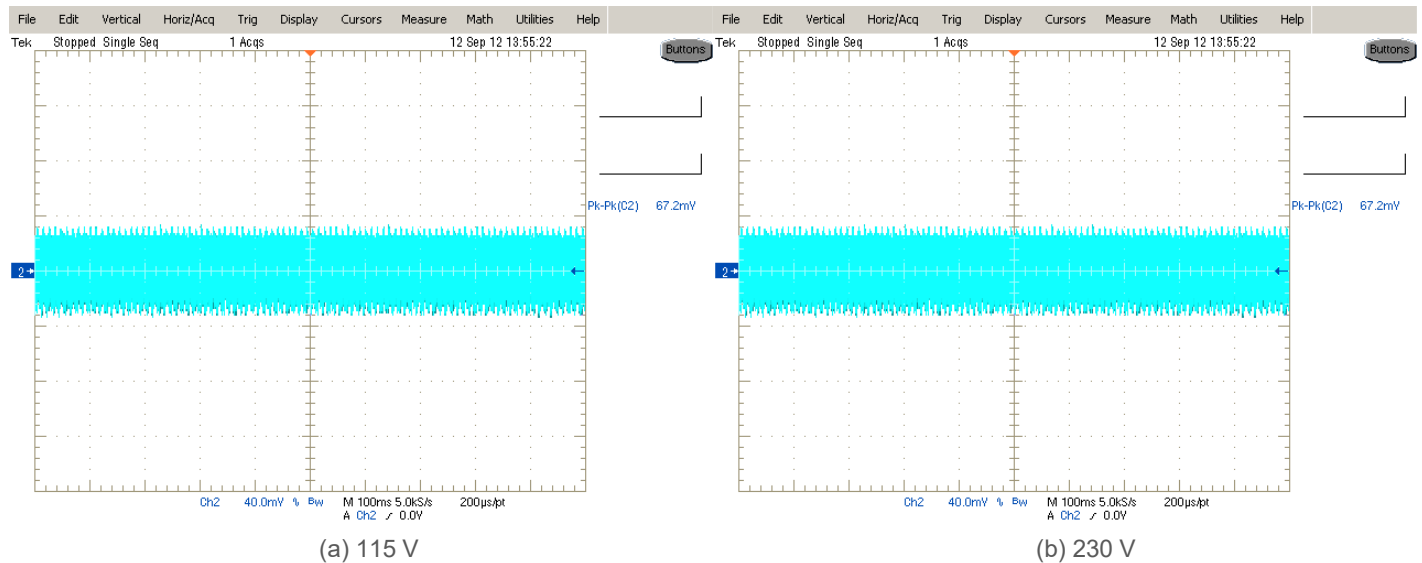
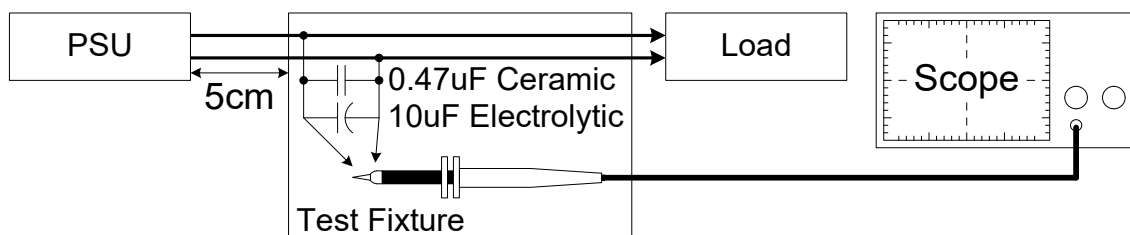

Fig. 2 Ripple & Noise example, 20 MHz BW

Ripple & Noise measurement circuit



Mechanical

Case Chassis	PC
Case Cover	PC
Dimensions(W x L x H)	62.0 x 135.0 x 34.1 mm (2.4 x 5.3 x 1.3 in)
Unit Weight	360 grams (12.7 ounces)
Indicator	LED
Terminal	Input C14 socket
	Output 4 pin Din / Barrel type / Tuning fork type

Environment

Surrounding Air Temperature	Operating	0°C to +40°C
	Storage	-40°C to +85°C
Operating Humidity	10-95% RH (Non-Condensing)	
Operating Altitude	3,000 meters (9,840 feet)	
Shock Test (Non-Operating)	50 G, 11 ms, 3 shocks for each direction	
Vibration (Non-Operating)	5-500 Hz, 2.09 Grms, 20 minute for each three axis	

MDS Medical AC-DC Adapter

12 Volt, 60 Watt / MDS-060AAS12 B

Protections

Overvoltage (max)	150%, Latch Mode
Over load / Over current (max)	180% of rated load current, Hiccup Mode, (Non-Latching, Auto-Recovery)
Over Temperature	Hiccup Mode, (Non-Latching, Auto-Recovery)
Short Circuit	Hiccup Mode, (Non-Latching, Auto-Recovery)
Protection Against Shock	Class I

Reliability Data

MTBF (typ.)	1 million Hours based on Telecordia SR-332
-------------	--

Safety Standards / Directives

Medical Safety	IEC60601-1 3 rd and 3.1 st edition CB report IEC60601-1 edition 3.1 st (2012), EN60601-1 (2006) + A11 + A1 + A12, CAN/CSA-C22.2 NO. 60601-1:14, ANSI/AAMI ES60601-1:2005/(R)2012	
ITE Safety	IEC60950-1 (Ed.2,2005), IEC62368-1, GB4943.1-2011, GB9254-2008, GB17625.1-2003	
CE	In conformance with EN 60601-1: 2006 + A11: 2011 + A1: 2013 + A12: 2014 & EN 60601-1-2: 2015	
UKCA	Medical Devices Regulations 2002(UK MDR 2002)	
Galvanic Isolation	Input to Output	4000 Vac
	Input to Ground	1500 Vac
	Output to Ground	500 Vac

MDS Medical AC-DC Adapter

12 Volt, 60 Watt / MDS-060AAS12 B

EMC (Compliant with IEC 60601-1-2 4th Ed. Requirements)

EMC / Emissions		EN/BS EN 55011, EN/BS EN 55032, FCC Title 47: Class B
Harmonic Current Emissions	IEC61000-3-2	Meet Class A limit
Immunity to		
Voltage Flicker	IEC61000-3-3	
Electrostatic Discharge	IEC61000-4-2	Level 4 Criteria A ¹⁾ Air Discharge: 15 kV Contact Discharge: 8 kV
Radiated Field	IEC61000-4-3	Criteria A ¹⁾ 80 MHz-2700 MHz, 10 V/m AM modulation 385 MHz-5785 MHz, 28 V/m Pulse mode and other modulation
Electrical Fast Transient / Burst	IEC61000-4-4	Level 3 Criteria A ¹⁾ :2 kV
Surge	IEC61000-4-5	Level 3 Criteria A ¹⁾ Common Mode ³⁾ : 2 kV Differential Mode ⁴⁾ : 1 kV
Conducted	IEC61000-4-6	Level 2 Criteria A ¹⁾ 150 kHz-80 MHz, 3 Vrms, 6 Vrms at ISM bands and Amateur radio bands
Power Frequency Magnetic Fields	IEC61000-4-8	Criteria A ¹⁾ Magnetic field strength 30 A/m
Voltage Dips	IEC61000-4-11	Criteria A ¹⁾ 0% U _T , 0.5 cycle (10 ms), 0°/45°/90°/135°/180°/225°/270°/315°/360° Criteria B ²⁾ 0% U _T , 1 cycle (20 ms), 0° Criteria A ¹⁾ 70% U _T , 25 cycle (500 ms), 0° Criteria B ²⁾ 0% U _T , 250 cycle (5000 ms), 0°

1) Criteria A: Normal performance within the specification limits

2) Criteria B: Output out of regulation, or shuts down during test. Automatically restore to normal operation after test.

3) Asymmetrical: Common mode (Line to earth)

4) Symmetrical: Differential mode (Line to line)

MDS Medical AC-DC Adapter

12 Volt, 60 Watt / MDS-060AAS12 B

Block Diagram

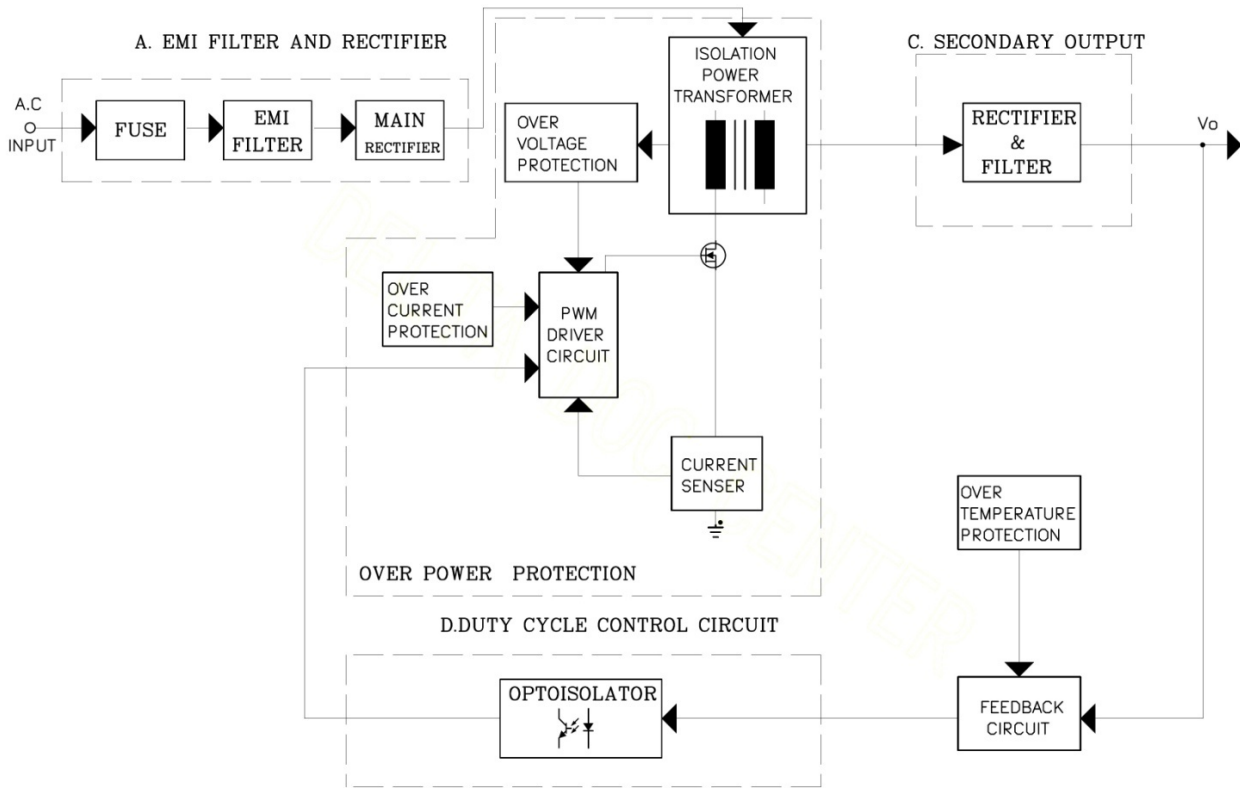

MDS Medical AC-DC Adapter

12 Volt, 60 Watt / MDS-060AAS12 B

Dimensions

W x L x H: 62.0 x 135 x 34.1 mm

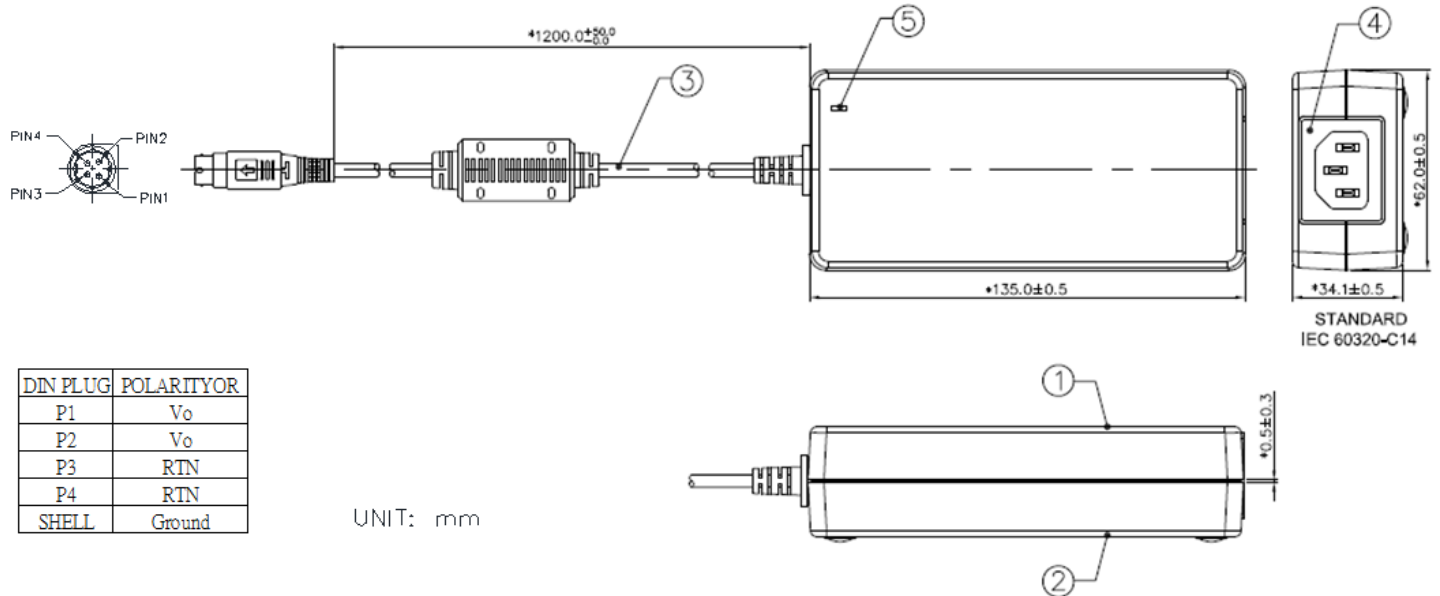

Item	Device Description
1	Cover
2	Chassis
3	Power Cord
4	Socket (IEC60320, C14)
5	Lens

MDS Medical AC-DC Adapter

12 Volt, 60 Watt / MDS-060AAS12 B

Functions

Start-up Time

The time required for the output voltage (V_o) to reach 90% of its set value, after the input AC voltage is applied.

Rise Time

The time required for the output voltage (V_o) to change from 10% to 90% of its steady state value.

Hold-up Time

Hold up time is the time when the AC input collapses and output voltage retains regulation for a certain period of time. The time required for the output to reach 95% of its set value, after the input voltage is removed.

■ Graph illustrating the Start-up Time, Rise Time, and Hold-up Time

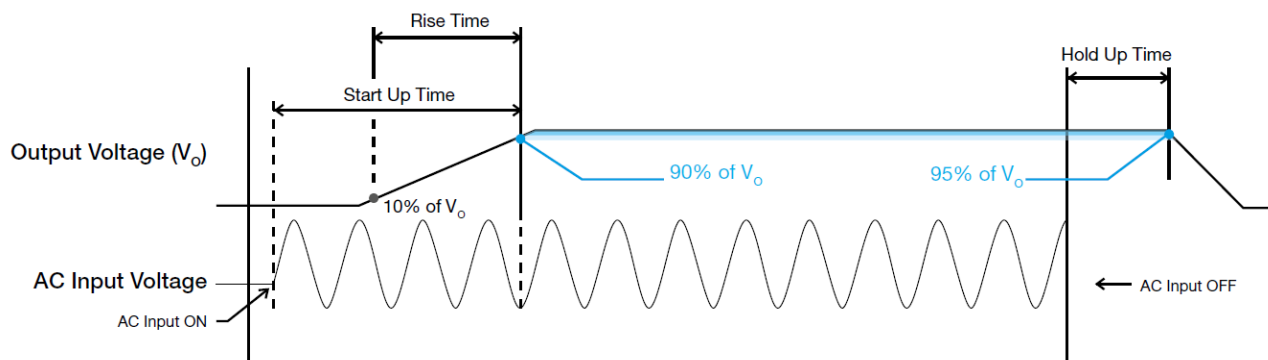

MDS Medical AC-DC Adapter

12 Volt, 60 Watt / MDS-060AAS12 B

Dynamic Response

The power supply output voltage will remain within $\pm 3\%$ of its steady state value, when subjected to a dynamic load change from 50 to 100% of its rated current.

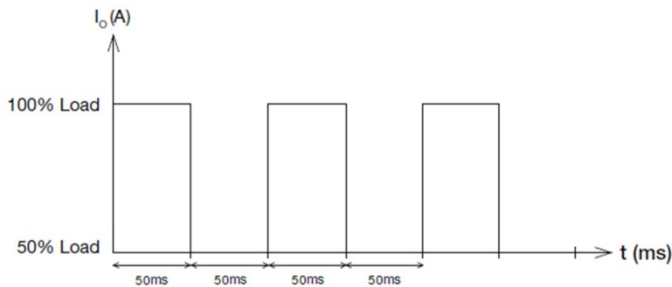

Inrush Current

Inrush current is the input current that occurs when the input voltage is first applied. For AC input voltages, the maximum peak value of inrush current will occur during the first half cycle of the applied AC voltage. This peak value decreases exponentially during subsequent cycles of AC voltage.

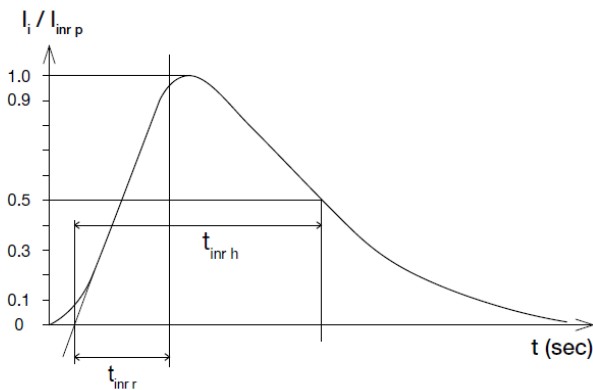

Overvoltage Protection

The power supply's overvoltage circuit will be activated when its internal feedback circuit fails. The output voltage shall not exceed its specifications defined on Page 4 under "Protections". Power supply will latch off, and require removal/re-application of input AC voltage in order to restart.

Short Circuit Protection

The power supply's output OLP/OCP function also provides protection against short circuits. When a short circuit is applied, the output current will operate in "Hiccup mode", as shown in the illustration in the OLP/OCP section on this page. The power supply will return to normal operation after the short circuit is removed.

Overload & Over current Protections

The power supply's Overload (OLP) and Over current (OCP) Protections will be activated when output current is between 110% and 130% of I_o (Max load). Upon such an occurrence, V_o will start to drop. Once the power supply has reached its maximum power limit, the protection will be activated and the power supply will go into "Hiccup mode" (Auto-Recovery). The power supply will recover once the fault condition causing the OLP and OCP is removed and I_o is back within the specified limit.

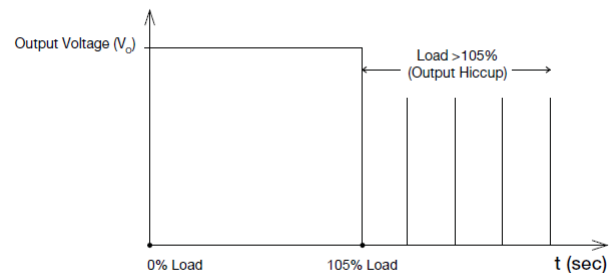

Additionally, if the I_o is $<130\%$ but $>110\%$ for a prolonged period of time (depending on the load), the Over Temperature Protection (OTP) will be activated due to high temperature on critical components. The power supply will then go into hiccup mode until the fault is removed; and, the input voltage is removed, then reapplied.

Over Temperature Protection

As mentioned above, the power supply also has Over Temperature Protection (OTP). This is activated when the overload condition persists for an extended duration and the output current is below the overload trigger point but $>100\%$ load. In the event of a higher operating condition at 100% load, the power supply will run into OTP when the surrounding air temperature is higher than the operating temperature. When activated, the output voltage will go into hiccup mode until the input voltage is removed; then, reapplied, and the surrounding air temperature drops to its normal operating temperature.

MDS Medical AC-DC Adapter

12 Volt, 60 Watt / MDS-060AAS12 B

Certificate



Delta has been certified as meeting the requirement of ISO 13485: 2003 and EN ISO 13485:2012 for the design and manufacture of switching power supply and adaptor for medical device.



Delta is approved for the UL Total Certification Program (TCP) approved client laboratory for IEC62368-1. Delta also has participated UL Client Test Data Program (CTDP) for IEC 60601.



Meet DOE Level V Efficiency Requirement

Attention

Delta provides all information in the datasheets on an “AS IS” basis and does not offer any kind of warranty through the information for using the product. In the event of any discrepancy between the information in the catalog and datasheets, the datasheets shall prevail (please refer to www.DeltaPSU.com for the latest datasheets information). Delta shall have no liability of indemnification for any claim or action arising from any error for the provided information in the datasheets. Customer shall take its responsibility for evaluation of using the product before placing an order with Delta.

Delta reserves the right to make changes to the information described in the datasheets without notice.

Manufacturer and Authorized Representatives Information

Manufacturer

Thailand

Delta Electronics (Thailand) PCL.
909 Pattana 1 Rd., Muang, Samutprakarn, 10280 Thailand

Taiwan

Delta Electronics, Inc.
3 Tungyuan Road, Chungli Industrial Zone, Taoyuan County
32063, Taiwan

Authorized Representatives

The Netherlands

Delta Greentech (Netherlands) B.V.
Zandsteen 15, 2132 MZ Hoofddorp, The Netherlands

United Kingdom

Delta Electronics Europe Limited
1 Redwood Court, Peel Park Campus,
East Kilbride, Glasgow, G74 5PF, United Kingdom

MDS Medical AC-DC Adapter

12 Volt, 60 Watt / MDS-060AAS12 B

Document Revision Record

Date	Item	Content Revised	Page Affected	Rev
19 Dec 18	1	- Update EMC/Emission from EN55022 to EN55032 - Add "Attention"	5 10	06
21 Jun 19	1	-Update to "Vibration (Non-Operating)"	3	07
9 Sep 20	1	- Update 62368-1 - Remove RoHS	1,4,10 1,4,10	08
16 Jun 21	1 2 3	Add UKCA Mark and update CCC mark Add / BS EN for safety and EMC standard Add UKCA Address	1, 4,5 11	09