

SD101/SD103-Q170

Q170

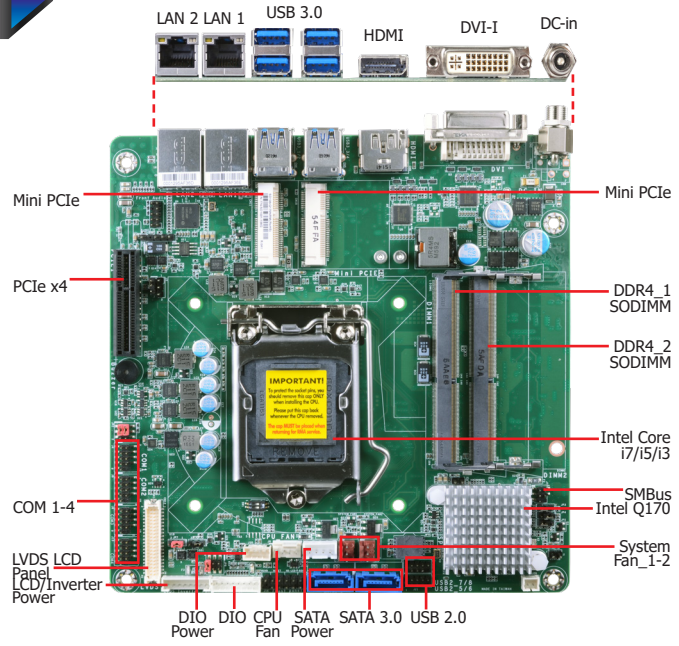

* The photos above refer to SD103-Q170.

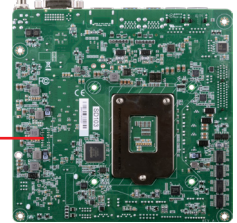

Bottom View

LPC(Optional)

Ordering Information

Model Name	P/N	Memory	HDMI/DP++	GbE	RS-232/422/485	RS-232	USB 3.0	USB 2.0	Power	Thermal	Temp.
SD101-Q170NRM	770-SD1011-100G	2 SODIMM	HDMI	2	1	3	4	4	12V DC-in	Active	0 to 60°C
SD103-Q170NRM	770-SD1031-100G	2 SODIMM	HDMI	2	1	3	4	4	15~36V DC-in	Active	0 to 60°C

Mechanical Drawing

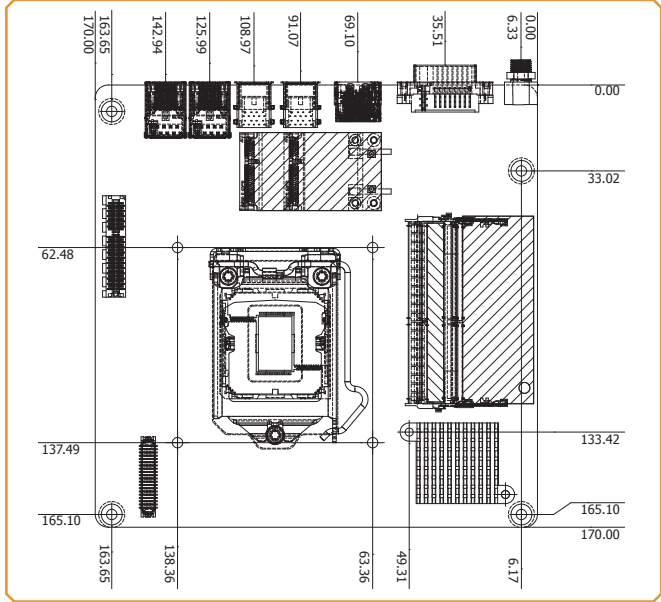

Features

- 2 DDR4 SODIMM up to 32GB
- Three independent displays: LVDS + DVI-I + HDMI*/DP
- DP resolution up to 4096x2304 @ 60Hz
Dual Channel LVDS resolution up to 1920x1200 @ 60Hz
- Multiple expansion: 1 PCIe x4, 2 Mini PCIe
- Rich I/O: 2 Intel GbE, 4 COM, 4 USB 3.0, 4 USB 2.0
- LPC EXT-RS232/485 module extends additional 4 COM ports

* Populated by default



2 Extension Modules for Additional 4 COM Ports (via the LPC connector)

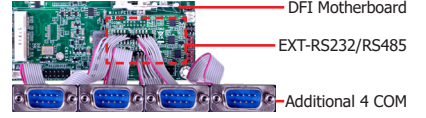
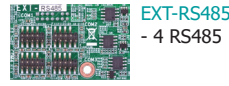
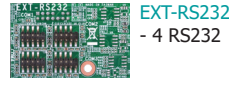

Block Diagram

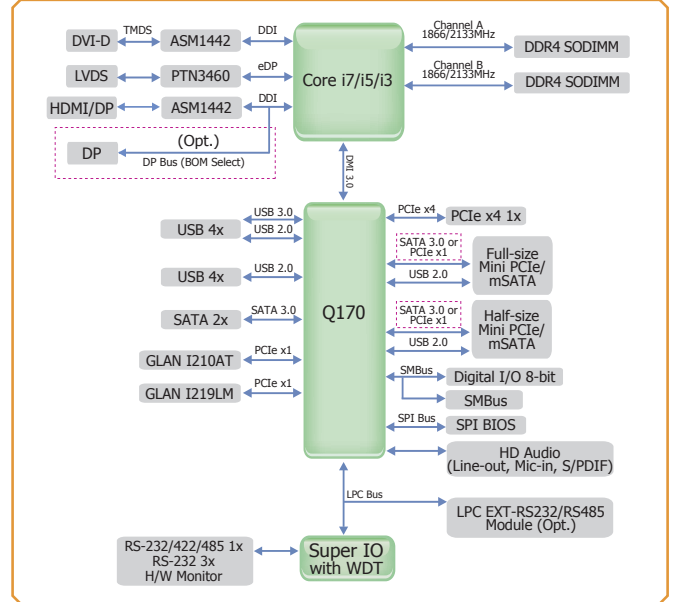

Specifications

SYSTEM	Processor	7th Generation Intel® Core™ Processors, LGA 1151 Socket Intel® Core™ i7-7700 Processor, Quad Core, 8M Cache, 3.6GHz (4.2GHz), 65W Intel® Core™ i5-7500 Processor, Quad Core, 6M Cache, 3.4GHz (3.8GHz), 65W Intel® Core™ i3-7101E Processor, Dual Core, 3M Cache, 3.9GHz, 65W 6th Generation Intel® Core™ Processors, LGA 1151 Socket Intel® Core™ i7-6700, Quad Core, 8M Cache, 3.4GHz (4.0GHz), 65W Intel® Core™ i7-6700TE, Quad Core, 8M Cache, 2.4GHz (3.4GHz), 35W Intel® Core™ i5-6500, Quad Core, 6M Cache, 3.2GHz (3.6GHz), 65W Intel® Core™ i5-6500TE, Quad Core, 6M Cache, 2.3GHz (3.3GHz), 35W Intel® Core™ i3-6100, Dual Core, 3M Cache, 3.7GHz, 47W Intel® Core™ i3-6100TE, Dual Core, 4M Cache, 2.7GHz, 35W Intel® Pentium® G4400, Dual Core, 3M Cache, 3.3GHz, 47W Intel® Pentium® G4400TE, Dual Core, 3M Cache, 2.4GHz, 35W Intel® Celeron® Processor G3900, Dual Core, 2M Cache, 2.8GHz, 65W Intel® Celeron® Processor G3900TE, Dual Core, 2M Cache, 2.6GHz, 35W	
	Chipset	Intel® Q170 Chipset	
	Memory	Two 260-pin SODIMM up to 32GB	Dual Channel DDR4 1866/2133MHz
	BIOS	Insyde SPI 128Mbit	
	GRAPHICS	Controller	Intel® HD Gen 9 Graphics
	Feature	OpenGL 5.0, DirectX 12, OpenCL 2.1 HW Decode: AVC/H.264, MPEG2, VC1/WMV9, JPEG/MJPEG, HEVC/H265, VP8, VP9 HW Encode: MPEG2, AVC/H264, JPEG, HEVC/H265, VP8, VP9	
	Display	1 x LVDS 1 x DVI-I (DVI-D signal) 1 x HDMI/DP (DP available upon request)	LVDS: dual channel, resolution up to 1920x1200 @ 60Hz DVI-I: resolution up to 1920x1200 @ 60Hz HDMI: resolution up to 2560x1600 @ 60Hz or 4096x2160 @ 24Hz DP: resolution up to 4096x2304 @ 60Hz
	Triple Displays	LVDS + DVI-I (DVI-D signal) + HDMI	LVDS + DVI-I (DVI-D signal) + DP
EXPANSION	Interface	1 x PCIe x4 (Gen 3)	1 x Full-size Mini PCIe (USB/PCIe/SATA, SATA by default) 1 x Half-size Mini PCIe (USB/PCIe/SATA, PCIe by default)
AUDIO	Audio Codec	Realtek ALC888S-VD2-GR	
ETHERNET	Controller	1 x Intel® I210AT PCIe (10/100/1000Mbps) 1 x Intel® I219LM PCIe with iAMT11.0 (10/100/1000Mbps) (only Core i7/i5 supports iAMT)	
REAR I/O	Ethernet	2 x GbE (RJ-45)	
	USB	4 x USB 3.0	
	Display	1 x DVI-I (DVI-D signal)	1 x HDMI/DP (DP available upon request)
INTERNAL I/O	Serial	3 x RS-232 (2.00mm pitch)	1 x RS-232/422/485 (RS-232 w/ power) (2.00mm pitch)
	USB	4 x USB 2.0 (2.00mm pitch)	
	Display	1 x LVDS LCD Panel Connector	1 x LCD/Inverter Power
	Audio	1 x Audio (Line-out/Mic-in)	1 x S/PDIF
	SATA	2 x SATA 3.0 (up to 6Gb/s)	RAID 0/1/5/10
	DIO	1 x 8-bit DIO	
	LPC	1 x LPC (supports LPC EXT-RS232/RS485 module) (available upon request)	
	SMBus	1 x SMBus	
WATCHDOG TIMER	Output & Interval	System Reset, Programmable via Software from 1 to 255 Seconds	
POWER	Type	Single 12V +/-10% DC (SD101)	Wide Range 15~36V (SD103)
	Connector	DC-in Jack	Right Angle Connector (4-pin) (available upon request) Vertical Type Connector (4-pin) (available upon request)
	Consumption	SD101-Q170 Typical: 15.65W: 12V @ 3.18A (38.16Watt) Max.: 15.65W: 12V @ 5.51A (66.12Watt)	SD103-Q170 Typical: 15.65W: 19V @ 2.16A (41.04Watt) Max.: 15.65W: 19V @ 3.68A (69.92Watt)
	RTC Battery	CR2032 Coin Cell	
OS SUPPORT	Microsoft/Linux	Windows 7 (WES7) 32/64-bit Windows 8.1 (64-bit) Windows 10 IoT Enterprise 64-bit Note: 7th Gen Intel Core processors only support Win 10.	Debian 8 (with VESA graphic driver) CentOS 7 (with VESA graphic driver) Linux
ENVIRONMENT	Temperature	Operating: 0 to 60°C	Storage: -40 to 85°C
	Humidity	Operating: 5 to 90% RH	Storage: 5 to 90% RH
	MTBF	SD101-Q170 : 435,042 hrs @ 25°C; 256,660 hrs @ 45°C ; 165,275 hrs @ 60°C SD103-Q170 : 420,421 hrs @ 25°C; 246,826 hrs @ 45°C ; 158,744 hrs @ 60°C Calculation model: Telcordia Issue 2, Method I Case 3 Environment: GB, GC – Ground Benign, Controlled	
MECHANICAL	Dimensions	Mini-ITX Form Factor	170mm (6.7") x 170mm (6.7")
	Height	PCB: 1.6mm	Top Side: 20mm, Bottom Side: 3mm
CERTIFICATIONS	CE, FCC Class B, RoHS, UL		

Packing List

• 1 SD101/SD103-Q170 motherboard	
• 1 COM port cable (Length: 250mm, 1 x COM ports)	A81-015011-001G
• 1 Serial ATA data cable (Length: 500mm)	332-553001-005G
• 1 Serial ATA power Y cable (Length: 300mm)	A81-002013-000G

Optional Items

• COM port cable (Length: 250mm, 1 x COM ports)	A81-015011-001G
• Audio (Line-out/Mic-in) cable (Length: 160mm)	A81-022007-016G
• Power adapter (100W, 12V, Level 6) (SD101)	671-110002-100G
• Power adapter (120W, 19V, Level 6) (SD103)	671-110003-100G
• Thermal solution (For 35W, Height: 37.3mm)	A71-103004-000G
• Thermal solution (For 65W, Height: 72.8mm)	552-200049-000G
• LPC EXT-RS232 module (4 x RS232 ports)	770-EXTRS1-000G
• LPC EXT-RS485 module (4 x RS485 ports)	770-EXTRS1-100G
• I/O shield	A49-SD1010-000G
• DT122 Chassis	761-DT1220-200G
• Intel 750 Series PCIe SSD (400GB)	635-604002-400G
• Intel 750 Series PCIe SSD (800GB)	635-608002-400G
• Intel 750 Series PCIe SSD (1.2TB)	635-612002-400G