



LIVE AIR3
(PDL-AFX/PDL-AFX-RA)

Product manual

Welcome To Use LIVE AIR 3



Bluetooth Controller
PDL-TC-AFX

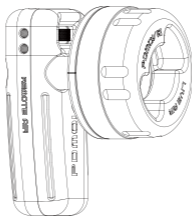

Large handwheel device
REMOTE AIR RIG

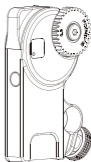

Bluetooth Motor
PD-BTMP-N

Notice For Use

- Before using the product, please read the instructions carefully or watch the tutorial videos to learn how to use the products properly. If there are any direct or indirect adverse effects due to operational errors, PDMOVIE will not assume any responsibility.
- Please do not dismantle, repair or refit the internal structure of the product without authorization. If the product is damaged due to the above improper operation, PDMOVIE has the right to refuse product service.
- If you need technical support or if the product has any problems, Please contact us.

E-mail: pd@pdmovie.com

Website: www.pdmovie.com

Instagram: [pdmovie_official](#)

Facebook: PDmovie

Youtube: PDMOVIE

WhatsApp: +8613542105054

Configuration List



①

Bluetooth Controller
PDL-TC-AFX



②

Large handwheel device
REMOTE AIR RIG



③

Bluetooth motor
PD-BTMP-N



④

Fixed fixture



⑤

Lir2477 Battery



⑥

Li42Bx2 Battery



⑦

Micro USB
Charging Cable



⑧

Charger



⑨

Hot Shoe Clamp



⑩

15MM Pipe



⑪

Inner hexagon spanner
1/4 Screw



⑫

Lens Gear
Ring

| Number | Name | PDL-AFX | PDL-AFX-R |
|--------|-------------------------------------|---------|-----------|
| 1 | Controller(PDL-TC-AFX) | 1 | 1 |
| 2 | Large handwheel device | - | 1 |
| 3 | Motor Mini(PD-BTMP-N) | 1 | 1 |
| 4 | Fixed fixture | 1 | 1 |
| 5 | LIR2477 Battery | 1 | 1 |
| 6 | Li42Bx2 Battery(3.7V600mAh2.2Wh*2) | 2 | 2 |
| 7 | Micro USB Charging Cable | 2 | 2 |
| 8 | Li42B Battery Charger | 1 | 1 |
| 9 | Camera Hot Shoe Clamp | 1 | 1 |
| 10 | 15MM Pipe | 1 | 1 |
| 11 | Inner hexagon spanner*1 1/4 screw*2 | 1 | 1 |
| 12 | LENS GEAR RING | 1 | 1 |

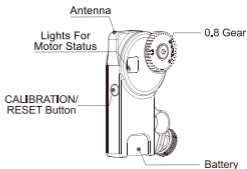
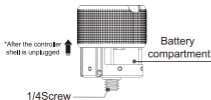

1. Install Motor

Install the motor on the 15mm rod and make sure the motor gear matches with the lens gear. (If it install on DSLR Camera lens, please use the camera hot shoe clamp.)

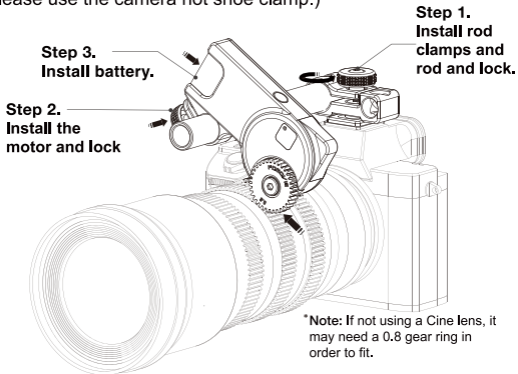

2. Turn on the Bluetooth controller and motor

Press the ON/OFF button on the Bluetooth controller for three seconds until the indicator light powers on. The motor will turn on automatically when the battery is inserted.

3. Bluetooth Connection

The controller and motor are paired at the factory. Turn on the controller and the motor at the same time, and the Bluetooth will be paired automatically (if the indicator lights at both ends continue to flash rapidly, it means pairing is in progress). After successful pairing, the controller indicator light is always on, and the motor indicator light shows the flashing frequency corresponding to the current speed gear of the motor. (if pairing with other controllers /motors: the Bluetooth of the controller and the motor needs to be reset, see Table 2-④ and Table 3-⑥)

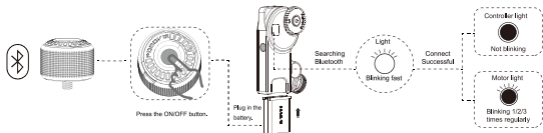

*1. The recommended control distance of the controller within 100 meters, although the actual control distance can be affected by environmental factors.

2. In an environment with strong signal interference, The motor and controller may lose connection. We recommend to shorten the operating distance until the controller and the motor are connected again.

4. Calibration

(1) Press the ON/OFF button of the Bluetooth controller once, then press it again and hold until the motor rotates.

(2) Press and hold the button on the bottom of the motor for three seconds until the motor rotates.

(1) Press the button once, then press it again for three seconds.

Bluetooth controller



(2) Press the button for three seconds.

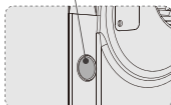

Motor

(3) Manually calibration:

- A. When the motor gear and the lens gear are completely connected, turn the lens to the starting point and hold for 0.5 seconds.
- B. Then turn the lens ring to the end and hold for 0.5 seconds.
- C. Finally, turn the lens ring slightly to the middle, Calibrate done. **(It is recommend that you use manual calibration when when using a lens with out hard stop)**

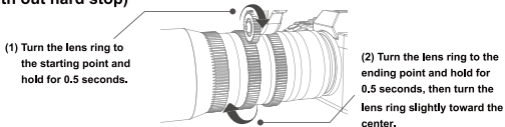

***After completing steps 1 to 4, you can use the controller to drive the motor. For more command settings, see Table 2 and Table 3.**

5. Charging instructions

- Use the micro usb cable, plug it into the charging port of the controller, and connect to a 5V USB charger for charging.
- Insert the motor battery into the charging case, plug the Micro USB cable and connect to a 5V USB charger for charging. The charging case allows you to charge 2 motor batteries at the same time.

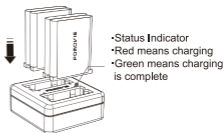
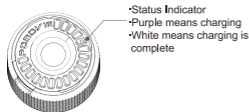
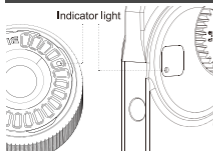

Table 1 The color of the indicator light







| The color of the indicator light | Residual electricity |
|----------------------------------|--|
| WHITE |  100% - 75% |
| GREEN |  75% - 50% |
| YELLOW |  50% - 25% |
| RED |  25% - 0% |

Table 2 Bluetooth controller Instruction of button













| Number of press on the buttons | Function |
|--|---------------------------------------|
| ①  Long press for 3 seconds | ON/OFF |
| ②  Short press a times | A-B FOCUS LIMITS |
| ③  Short press a times and then long press for 3 seconds | AUTO CALIBRATION |
| ④  Short press 3 times and then long press for 3 seconds | BLUETOOTH PAIRING |
| ⑤  Short press 7 times | MOTOR DIRECTION |
| ⑥  Short press 4 times and then long press for 3 seconds | MODE FOCUS \longleftrightarrow ZOOM |
| ② Press once to set point A, press the second to set point B, press the third time to start the automatic operation of point AB, press the fourth time to cancel the automatic operation Run, cancel point AB. (*The speed of automatic operation increases or decreases linearly according to the rotation angle of the knob) | |

Table 3 Motor Instruction of button

| Number of press on the buttons | Function |
|---|--|
| ①  Long press for 3 seconds | AUTO CALIBRATION |
| ②  Short press a times | EMERGENCY STOP AUTO CALIBRATION |
| ③  Short press 4 times | RESTORE THE LENS STROKE WHEN POWER OFF / REMOVE THE LENS STROKE |
| ④  Short press 5 times | SWITCH MOTOR SPEED (FAST-MEDIUM-SLOW) PULSE FREQUENCY (3/2/1 TIMES) |
| ⑤  Short press 7 times | SWITCH MOTOR ROTATE DIRECTION |
| ⑥  Short press 3 times and then long press for 3 seconds | BLUETOOTH PAIRING |
| ③ Cancel the calibrated stroke: when the motor have a stroke, Press the button four times to clear the motor stroke. Restore lens stroke: If the motor need to change battery, press the button for 4 times to restart the previous trip after restarting. | |
| ④ When the motor speed is switched, the motor indicator will cycle to display the corresponding flashing frequency. Fast = 3 flashes; medium = 2 flashes; slow = 1 flash. | |

REMOTE AIR RIG Installation note

1. Installation

First install the Bluetooth controller into the slot of the REMOTE AIR RIG large handwheel extension device (*must be inserted to the end). Then turn the controller clockwise until the controller can't rotate, the installation is complete.

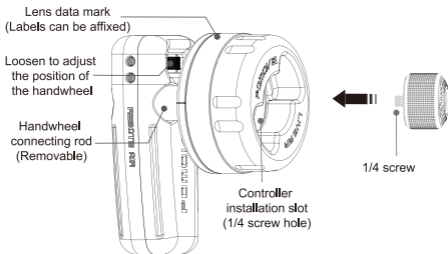

2. Disassembly

First, turn the Bluetooth controller counterclockwise to the limit of the controller, and then apply a little force to continue to rotate the controller counterclockwise until the 1/4 screw of the controller is completely out of the large handwheel slot, then you can pull out the controller .

REMOTE AIR APP

1.APP download

- Users can use APP to connect and control up to 6 Bluetooth motors.
- Search for PDMOVIE or REMOTE AIR in the Apple App Store to download.
- Log in to the official website www.pdmovie.com with your mobile phone, and enter the APP download page of support to download and install the APP. (APP currently only supports IOS system)

2. Connect

Before use the APP connect to the motor, please make sure that the controller is turned off. And make sure that the APP is not running in the background. The specific connection steps are as follows:

1. Turn on the bluetooth of the mobile phone and open the APP

2. Enter the Bluetooth selection interface

3. Insert the battery into the motor to turn on the motor

6. Click the "Continue" sign to enter the main interface of the app

5. Select the product category for Bluetooth connectivity as MOTOR MINI, then click connect

4. Select the motor you want to connect and rename it

7. Long press the AUTO sign to automatically calibrate the lens

8. Tap the "-" sign to select the motor that you want to control in this channel

9. Slide the control bar to check whether the motor is working properly

- If you need to connect multiple Bluetooth motors, repeat steps 3 ~ 5.
- Step 6: Automatic lens calibration can also replace by manual lens calibration.
- For more information about APP, please enter the APP SET interface and select HELP to view more detailed tutorials.

Battery replacement instructions

For changing the controller's battery, please mount the controller on an object that has a 1/4 screw hole. Pull up the shell and make sure the shell is moved to the end. Then use a small Allen key to push out the battery.

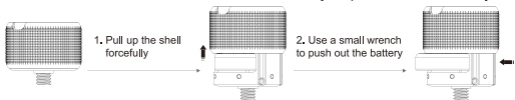

- Unless you encounter force majeure factors such as battery damage and drastically reduced battery life, it is not recommended to replace the controller battery frequently.
- When replacing the battery, Please check the electrode direction when replacing the battery to avoid incorrect installation of the battery.
- To replace the battery of the motor, please push the battery to the right side first, then pull it out. (Refer to the direction indicated by the arrow icon on the motor.) If the battery is difficult to take out due to slipperiness, please use the BATTERY STICKER to help remove the battery.

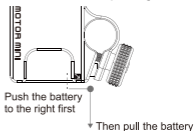

Notice

1. Emergency stop calibration: The motor skips teeth during the automatic calibration process, resulting in the phenomenon of non-stop rotation. Just click the motor button to terminate the automatic calibration immediately;
2. When the motor is not calibrated, it cannot be used. When the damping of individual lenses is too heavy or not smooth, and the motor cannot complete the automatic calibration, the manual calibration lens travel function can be used
3. The controller defaults to FOCUS mode. If it is switched to ZOOM mode, it will be divided equally based on the rotation of the wheel by 300 degrees, and the middle 10 degrees will be the stationary position. Turn left to move forward, turn right to move backward. The propulsion speed is linearly adjusted according to the angle of rotation.

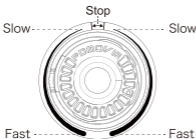

In ZOOM mode, there are three speed control gears.



Short press the controller button for 5 times to change speed.

4. When the rotating stroke of the motor does not match the calibrated stroke, please check whether the indicator light of the Bluetooth controller is blue and the color of the current battery flashes alternately. If the above state occurs, it means that the controller has set the point A-B stroke Limit, you need to briefly press the controller button to start the A-B automatic operation, and then press it again to cancel the automatic operation and cancel the A-B point travel limit. (*A-B point command logic: click the 1st time = set point A; click the 2nd time = set point B; click the 3rd time = start the automatic running of the A-B point cycle; click the 4th time = stop the automatic operation Run and cancel the A-B point limit.)
5. The PD-BTMP-N Bluetooth motor supports adjusting the three-speed response speed. Short press the motor button 5 times to switch the three-speed response speed cyclically. The speed gears are slow, medium, and fast. After switching the motor speed, the motor indicator will cycle to display the corresponding flashing frequency. Fast = 3 flashes; medium = 2 flashes; slow = 1 flash.
6. Regarding battery maintenance: When the product is not used for a long time, it is recommended to check the power of the device every other month to ensure that the battery has sufficient power; when the device is in a low or no power state for a long time, the battery capacity will become smaller. If the battery is swollen, do not continue to use the battery to avoid the battery being stuck in the battery compartment and difficult to remove.

LIVE AIR 3

PDMOVIE Technology Co., Ltd.

Web: www.pdmovie.com

E-mail: pd@pdmovie.com

Instagram: [pdmovie_official](#)

Facebook: [PDmovie](#)

Youtube: [PDMOVIE](#)

©2022 PDMOVIE All rights reserved.